

**K-CON**<sup>®</sup>

Lossnay Weatherproof Housing

# Installation Manual

Instructions for :-

KS4-KWH80 to fit Mitsubishi Electric Lossnay LGH-80RX5

KS4-KWH100 to fit Mitsubishi Electric Lossnay LGH-100RX5

For safe and correct use please read this installation manual and the Lossnay installation manual

## Contents

---



Page	
3	Safety precautions
4	Application and specifications
5	Exploded view
6 - 8	Installation instructions
9	Access to filter, core and electrical panel

## Safety precautions

### Before installation and electric work

Before installing the unit, make sure you read all the "Safety precautions". The "Safety precautions" provided are very important points regarding safety. Make sure you follow them.



Symbols used in the text

-  Warning: Describes precautions that should be observed to prevent danger of injury or death to the user.
-  Caution: Describes precautions that should be observed to prevent damage to the unit.

 Warning: Carefully read the labels affixed to the main unit.

-  Warning:
- Ask the dealer or an authorised technician to install the unit.  
Improper installation by the user may result in water leakage, electric shock, or fire.
  - Use the specified cables for wiring. Make the connections securely so that any outside forces acting on the cables are not applied to the terminals. Inadequate connection and fastening may generate heat and cause a fire.
  - Never repair the unit. If the controller must be repaired, consult the dealer.  
If the unit is repaired improperly, electric shock, or fire may result.
  - When handling this product, always wear protective equipment. EG: Gloves, full arm protection namely boiler suit, and safety glasses. Improper handling may result in injury.
  - Have all electric work done by a licensed electrician according to "Electric Facility Engineering Standard", "Interior Wire Regulations" and the instructions given in this manual and always use a special circuit.
  - If the power source capacity is inadequate or electric work is performed im-properly, electric shock and fire may result.  
Keep the electric parts away from any water - washing water etc...  
Contact may result in electric shock, fire or smoke.  
To dispose of this product, consult your dealer.

### Before installation

-  Caution:
  - Do not install the unit where combustible gas may leak. If the gas leaks and accumulates around the unit, an explosion may result.
-  Caution:
  - Ground the unit.  
Do not connect the ground wire to gas or water pipes, lightning rods, or telephone ground lines. Improper grounding may result in electric shock.
  - Be very careful regarding product transportation.  
Two people should be used to carry products of 20kg or more.
  - Some products use PP bands for packaging. Do not use any PP bands for a means of transportation.
  - Safely dispose of the packing materials.  
Packing materials, such as nails and other metal or wooden parts, may cause stabs or other injuries.  
Tear apart and throw away plastic packaging bags so that children will not play with them - If children play with a plastic bag which has not been torn apart, they face the risk of suffocation.

### Disclaimer

#### Warranty:

All products manufactured on behalf of Mitsubishi Electric UK are warranted against defective materials for a period of three years from the date of delivery to the original purchaser.

#### Warning:

-  Mitsubishi Electric UK assumes no liability for damages consequent to the user of this product. We reserve the right to change this manual at any time without notice. The information furnished by us is believed to be accurate and reliable. However, no responsibility is assumed by us for its use, nor for any infringements of patents or other rights of third parties resulting from its use.

## Application

---

It is advised that where possible the Lossnay unit and housing should be installed in an area sheltered from the wind. Preferably the unit should be mounted on a suitable, level support so that the bottom of the air inlet grille is at least 300mm above floor level.

Ducting connected to the Supply Air and Return Air should be fully insulated to ensure maximum efficiency from the Lossnay Heat Exchanger.

Sufficient space should be allowed to enable access to the service access panel and the serviceable parts within.

## Specification

---

Model	Lossnay Unit	A (mm)	B (mm)	C (mm)	Housing Weight kg	IP Rating
KS4-KWH 80	LGH 80RX5	1140	1163	446	43.40	IP43
KS4-KWH 100	LGH 100RX5	1366	1163	446	47.40	IP43

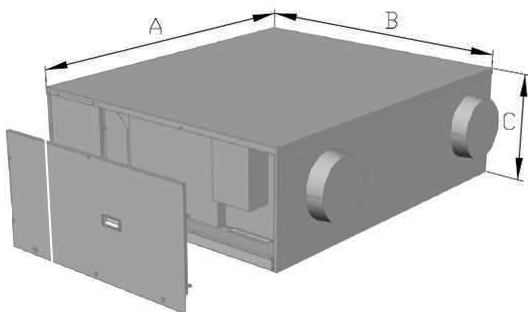

# Weatherproof Lossnay Housing - Assembly Instructions

## Exploded view and parts list

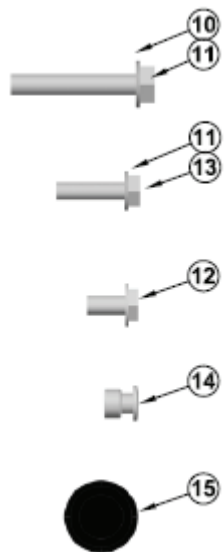
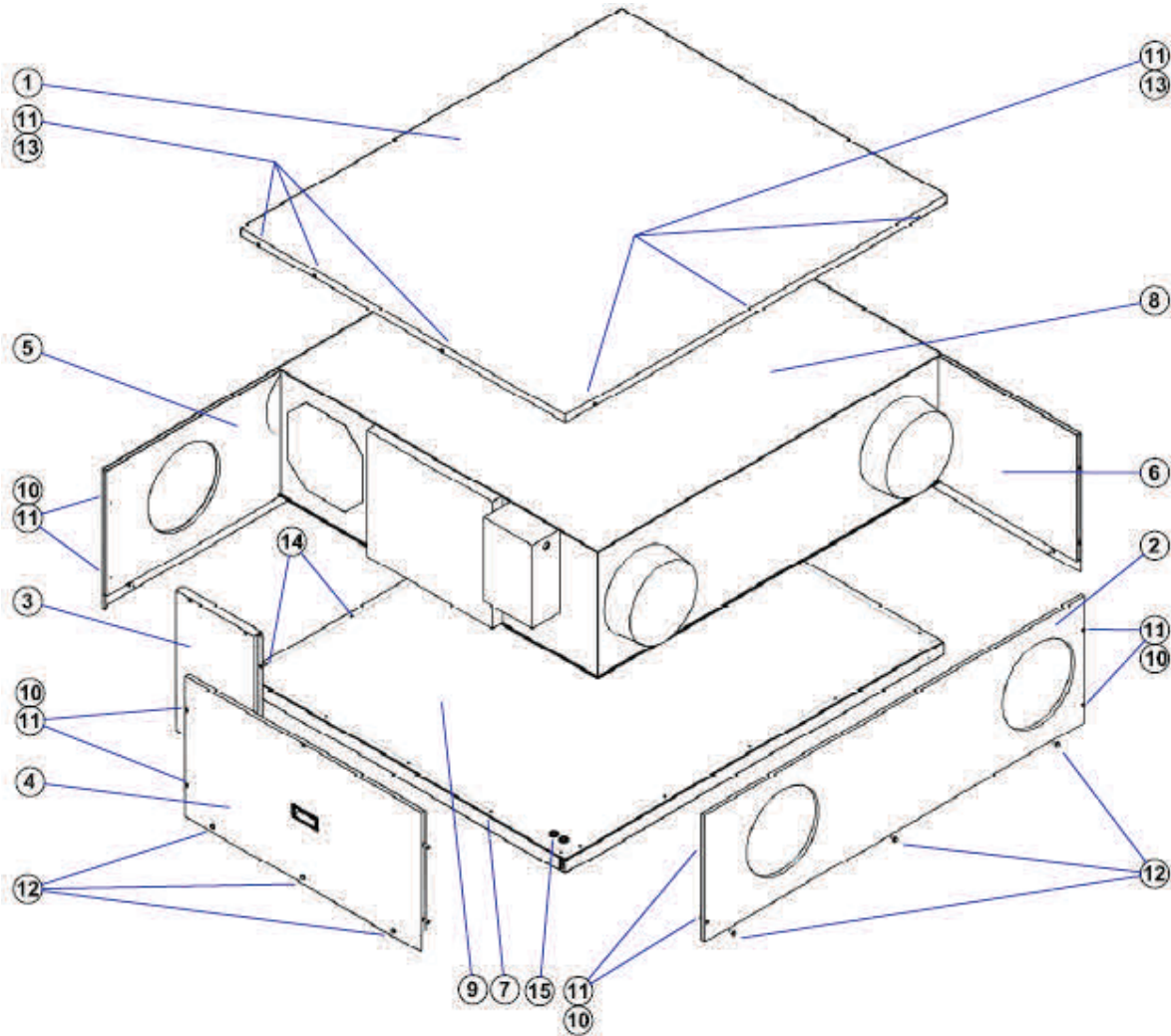

PART	DESCRIPTION	QTY
1	TOP COVER	1
2	INDOOR RA/SA	1
3	FRONT	1
4	DOOR	1
5	OUTDOOR EA/OA	1
6	BACK	1
7	BASE ASSY	1
8	LOSSNAY UNIT	1
9	BASEPLATE	1
10	M4x25 HEX SCREW	10
11	M4 NYLON WASHER	22
12	M6x12 TAPTITE SCREW	18
13	M4x16 HEX SCREW	12
14	3.2MM X10MM RIVET	18
15	20MM GROMMET	2

OA - Outside Air  
 EA - Exhaust Air  
 SA - Supply Air  
 RA - Return Air

\*LOSSNAY UNIT SOLD SEPARATELY  
 PART 10,11 FOR CONNECTING PANEL TO PANEL  
 PART 12 FOR CONNECTING PANEL TO BASEFRAME  
 PART 11,13 FOR CONNECTING TOP PANEL TO PANEL

## Weatherproof Lossnay Housing - Assembly Instructions

---

- ① Carefully remove all housing parts from the packaging and place the base assembly consisting of parts ⑦⑨⑭⑮ on a flat surface.

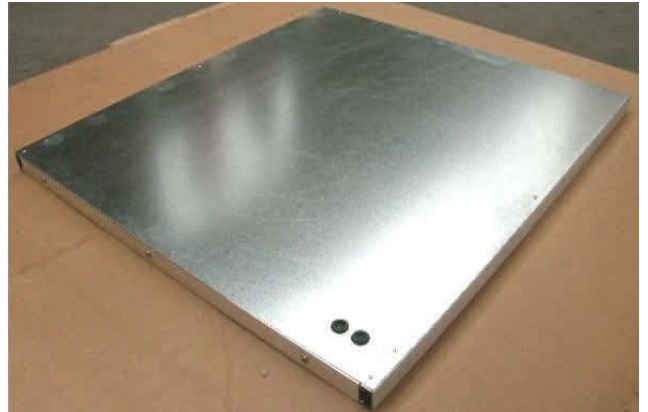

- ② Remove duct plenums from Lossnay unit and fit following Mitsubishi Electric instructions.



- ③ Place the Lossnay square on the base assembly with the electric box at the same side as the rubber grommets.





## Weatherproof Lossnay Housing - Assembly Instructions

- ④ Remove the transport / hanging brackets from the Lossnay unit.



- ⑤ Align the back panel ⑥ to the Lossnay unit and fit using 3 x M6 X 12 set screws ⑫

Repeat this procedure for fitting the front panel ③ and then the door panel ④

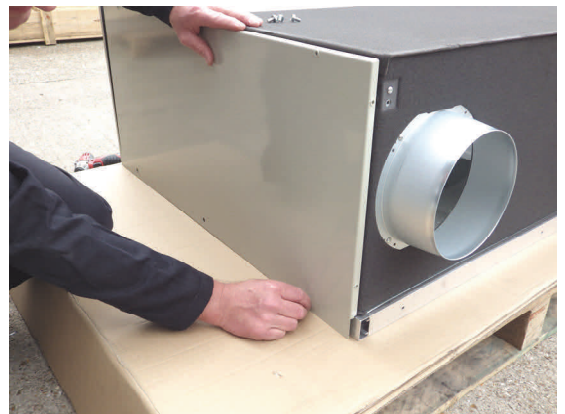

- ⑥ Align the OA & EA panel ⑤ to the Lossnay unit and fit using 3 x M6 X 12 set screws ⑫ and screw to the back, front and door panels using 4 x M4 X 25 set screws ⑩ and 4 x nylon washers ⑪

Repeat this procedure for fitting the SA & RA panel ②



## Weatherproof Lossnay Housing - Assembly Instructions

- 7 Place the top cover 1 over the housing panels and fix using 8 x M4 X 16 set screws 13 and 8 x nylon washers 11



- 8 The Lossnay and weatherproof housing is now complete for final installation.

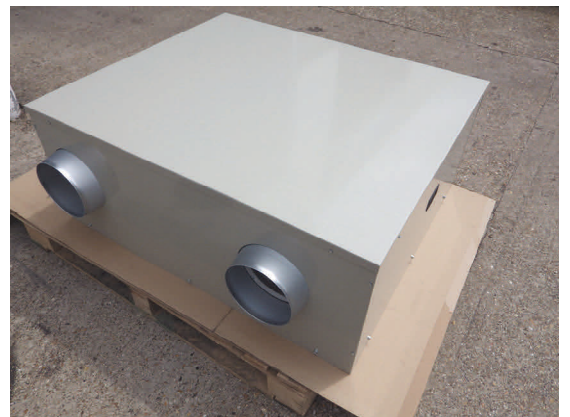

- 9 It is advised that the Lossnay unit and housing should be securely mounted on a suitable support to minimise vibration and movement and to ensure that the bottom of the air inlet spigot is at least 300mm above floor level.

Additionally 45 degree angle cowls with wire mesh guards should be fitted to the outside air intake and exhaust air outlet spigots, as per installed example shown to prevent water and bird / rodent access.





## Weatherproof Lossnay Housing - Assembly Instructions

### Access to filter, core and electrical panel

- 1 To access the electrical panel remove the screws from around the door panel.

Take care to support the panel by the handle to prevent it from dropping free.

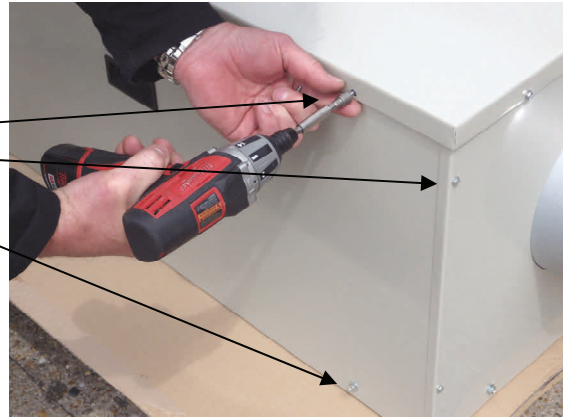

- 2 Slide the panel down and away to expose access to the Lossnay services.

Care should be taken to protect the services area from moisture ingress.



---

Please be sure to put the contact address/telephone number  
on this manual before handing it to the customer.



**mitsubishi electric uk**

MITSUBISHI ELECTRIC UK, TRAVELLERS LANE, HATFIELD, HERTFORDSHIRE, AL10 8XB