

Interface (Cased) PAC-IF011B-E PAC-IF012B-E

INSTALLATION MANUAL

For safe and correct use, read this manual and the indoor unit installation manual thoroughly before installing the air-conditioner unit.

FOR INSTALLER

English (GB)

INSTALLATIONSHANDBUCH

Aus Sicherheitsgründen und zur richtigen Verwendung vor der Installation die vorliegende Bedienungsanleitung und die Installationsanleitung der Innenanlage gründlich durchlesen die Klimaanlage.

FÜR INSTALLATEURE

Deutsch (D)

MANUEL D'INSTALLATION

Avant d'installer le climatiseur, lire attentivement ce manuel, ainsi que le manuel d'installation de l'appareil intérieur pour une utilisation sûre et correcte.

POUR L'INSTALLATEUR

Français (F)

INSTALLATIEHANDLEIDING

Lees deze handleiding en de installatiehandleiding van het binnenapparaat zorgvuldig door voordat u met het installeren van de airconditioner begint.

VOOR DE INSTALLATEUR

Nederlands (NL)

MANUAL DE INSTALACIÓN

Para un uso correcto y seguro, lea detalladamente este manual y el manual de instalación de la unidad interior antes de instalar la unidad de aire acondicionado.

PARA EL INSTALADOR

Español (E)

MANUALE DI INSTALLAZIONE

Per un uso sicuro e corretto, leggere attentamente il presente manuale ed il manuale d'installazione dell'unità interna prima di installare il condizionatore d'aria.

PER L'INSTALLATORE

Italiano (I)

ΕΓΧΕΙΡΙΔΙΟ ΟΔΗΓΙΩΝ ΕΓΚΑΤΑΣΤΑΣΗΣ

Για σωστή και ασφαλή χρήση, διαβάστε προσεκτικά αυτό το εγχειρίδιο καθώς και το εγχειρίδιο εγκατάστασης της εσωτερικής μονάδας, προτού εγκαταστήσετε τη μονάδα του κλιματιστικού.

ΓΙΑ ΑΥΤΟΝ ΠΟΥ ΚΑΝΕΙ ΤΗΝ ΕΓΚΑΤΑΣΤΑΣΗ

Ελληνικά (GR)

MANUAL DE INSTALAÇÃO

Para uma utilização segura e correcta, leia atentamente este manual e o manual de instalação da unidade interior antes de instalar o aparelho de ar condicionado.

PARA O INSTALADOR

Português (P)

INSTALLATIONSMANUAL

Læs af sikkerhedshensyn denne manual samt manualen til installation af indendørsenheden grundigt, før du installerer klimaanlægget.

TIL INSTALLATØREN

Dansk (DE)

INSTALLATIONSMANUAL

Läs bruksanvisningen och inomhusenhetens installationshandbok noga innan luftkonditioneringen installeras så att den används på ett säkert och korrekt sätt.

FÖR INSTALLATÖREN

Svenska (SW)

MONTAJ ELKİTABI

Emniyetli ve doğru kullanım için, klima cihazını monte etmeden önce bu kılavuzu ve iç ünite montaj kılavuzunu tamamiyla okuyun.

MONTÖR İÇİN

Türkçe (TR)

РУКОВОДСТВО ПО УСТАНОВКЕ

Для обеспечения безопасной и надлежащей эксплуатации внимательно прочтите данное руководство и руководство по установке внутреннего прибора перед установкой кондиционера.

ДЛЯ УСТАНОВИТЕЛЯ

Русский (RU)

Contents

1. Safety precautions.....	2
2. Installing the interface unit.....	3
3. Electrical work.....	4

Guide to plan local applications	8
--	---

Note (Marking for WEEE)



This symbol mark is for EU countries only.

This symbol mark is according to the directive 2002/96/EC Article 10 Information for users and Annex IV.

Your MITSUBISHI ELECTRIC product is designed and manufactured with high quality materials and components which can be recycled and reused.

This symbol means that electronic equipment, at the end-of-life, should be disposed of separately from your household waste.

Please, dispose of this equipment at your local community waste collection/recycling centre.

In European Union there are separate collection systems for used electrical and electronic products.

Please, help us to conserve the environment we live in.

1. Safety precautions

- ▶ Before installing the interface unit, make sure you read all the "Safety precautions".
- ▶ Please report to your supply authority or obtain their consent before connecting this equipment to the power supply system.

⚠ Warning:

Precautions that must be observed to prevent injuries or death.

⚠ Caution:

Precautions that must be observed to prevent damages to the unit.

⚠ Warning:

- The unit must not be installed by the user. Ask an installer or an authorised technician to install the unit. If the unit is installed improperly, electric shock, or fire may be caused.
- For installation work, follow the instructions in the Installation Manual and use tools and pipe components specifically made for use with refrigerant specified in the outdoor unit installation manual.
- The unit must be installed according to the instructions in order to minimize the risk of damages by earthquakes, typhoons, or strong winds. Improperly installed unit may fall down and cause damage or injury.
- The unit must be securely installed on a structure that can sustain its weight. If the unit is mounted on an unstable structure, it may fall down and cause damage or injury.
- All electric work must be performed by a qualified technician according to local regulations and the instructions given in this manual. The unit must be powered by dedicated power lines and the correct voltage and circuit breakers must be used. Power lines with insufficient capacity or incorrect electrical work may result in electric shock or fire.

After installation, perform the test run to ensure normal operation. Then explain the "Safety Precautions," use, and maintenance of the unit based on the information in the Operation Manual to your customer. Both the Installation Manual and the Operation Manual must be given to the user. These manuals must always be kept by the actual users.

⚡: Indicates a part which must be grounded.

⚠ Warning:

Carefully read the labels attached to the unit.

- Only the specified cables can be used for wiring. Connections must be made securely without tension on the terminals. If cables are connected or installed improperly, it may result in overheating or fire.
- Terminal block cover panel of the unit must be firmly fixed. If the cover panel is mounted improperly, dust and moisture may enter the unit, and it may cause electric shock or fire.
- Make sure to use accessories authorised by Mitsubishi Electric and ask an installer or an authorised technician to install them. If accessories are improperly installed, it may cause electric shock, or fire.
- Do not remodel the unit. Consult an installer for repairs. If alterations or repairs are not performed correctly, it may cause electric shock or fire.
- The user should never attempt to repair the unit or transfer it to another location. If the unit is installed improperly, it may cause electric shock or fire. If the interface unit needs to be repaired or moved, ask an installer or an authorised technician.

1.1. Before installation (Environment)

⚠ Caution:

- Do not install the interface unit in outdoor location as it is designed for indoor installation only. Otherwise electric shock or breakdown may be caused by water drop, wind or dust.
- Do not use the unit in an unusual environment. If the interface unit is installed or exposed to steam, volatile oil (including machine oil), or sulfuric gas, or exposed to briny air, the internal parts can be damaged.
- Do not install the unit where combustible gases may leak, be produced, flow, or accumulate. If combustible gas accumulates around the unit, it may cause fire or explosion.

- When installing the unit in a hospital or in a building where communications equipment are installed, you may need to take measure to noise and electronic interference. Inverters, home appliances, high-frequency medical equipment, and radio communications equipment can cause the interface unit to malfunction or to breakdown. At the same time, the noise and electric interference from the interface unit may disturb the proper operation of medical equipment, and communications equipment.

1.2. Before installation or relocation

⚠ Caution:

- Be very careful when moving the units. Do not hold the packaging bands. Wear protective gloves to unpack and to move it, in order to avoid your hands being injured by parts.

- Be sure to safely dispose of the packaging materials. Packaging materials, such as nails and other metal or wooden parts may cause injury.
- Do not wash the interface unit. You may receive an electric shock.

1.3. Before electric work

⚠ Caution:

- Be sure to install a circuit breaker. If it is not installed, there may be a risk of electric shock.
- For the power lines, use standard cables of sufficient capacity. Otherwise, it may cause a short circuit, overheating, or fire.
- When installing the power lines, do not apply tension to the cables. The cables may be cut or overheated resulting in a fire.

- Make sure to ground the unit. Do not connect the ground wire to gas or water pipes, lightning rods, or telephone grounding lines. If the unit is not properly grounded, there may be a risk of electric shock.
- Make sure to use circuit breakers (ground fault interrupter, isolating switch (+B fuse), and molded case circuit breaker) with the specified capacity. If the circuit breaker capacity is larger than the specified capacity, breakdown or fire may result.

1. Safety precautions

1.4. Before starting the test run

⚠ Caution:

- Turn on the main power switch of the outdoor unit more than 12 hours before starting operation. Starting operation immediately after turning on the power switch can severely damage the internal parts. Keep the main power switch turned on during the operation period.

- Before starting operation, check that all protective parts are correctly installed. Make sure not to get injured by touching high voltage parts.
- Do not touch any switch with wet hands. There may be a risk of electric shock.
- After stopping operation, wait at least 5 minutes before turning off the main power. Otherwise, it may cause breakdown.

2. Installing the interface unit

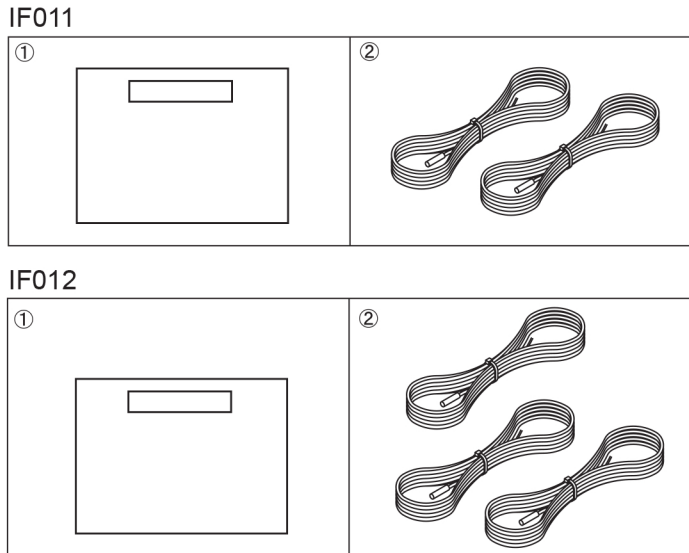

Fig. 2-1

2.1. Check the parts (Fig. 2-1)

The interface unit should be supplied with the following parts.

	Part Name	IF011	IF012
①	Interface unit	1	1
②	Thermistor	2	3

2.2. Choosing the interface unit installation location

- Do not install the interface unit in outdoor location as it is designed for indoor installation only. (The interface board and casing are not waterproof.)
- Avoid locations where the unit is exposed to direct sunlight or other sources of heat.
- Select a location where easy wiring access to the power source is available.
- Avoid locations where combustible gases may leak, be produced, flow, or accumulate.
- Select a level location that can bear the weight and vibration of the unit.
- Avoid locations where the unit is exposed to oil, steam, or sulfuric gas.

2.3. Installing the interface unit (Fig. 2-2, Photo.2-1)

1. Remove 2 screws from interface unit and remove the cover.
2. Install the 4 screws (locally supplied) in 4 holes.

- Ⓐ Screw
- Ⓑ Cover
- Ⓒ Hole for installation

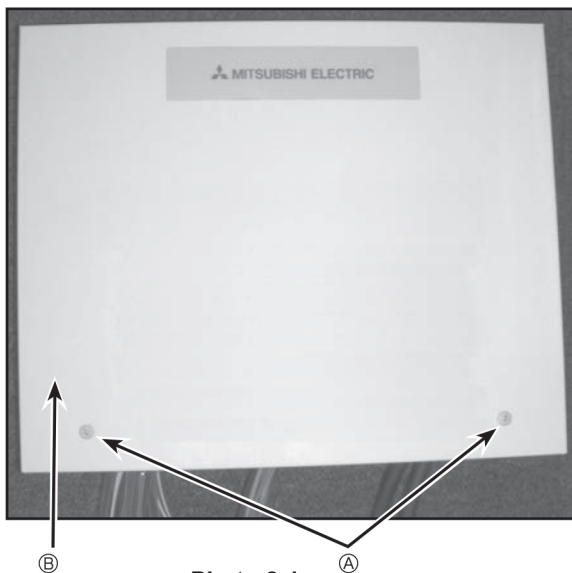

Photo.2-1

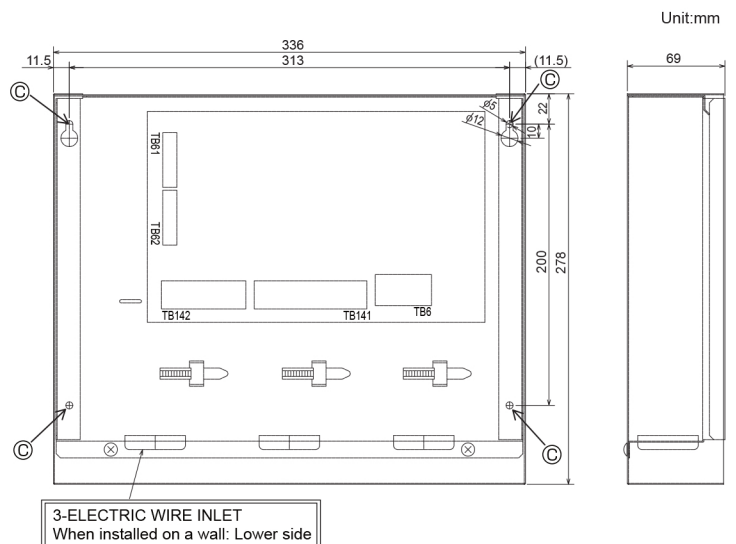
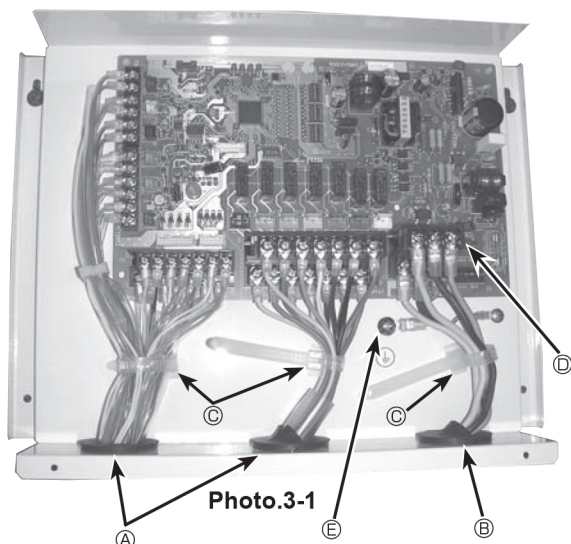

Fig.2-2

3. Electrical work



3.1. Interface unit (Photo. 3-1)

1. Remove the cover.
 2. Wire the power cable and control cable separately through the respective wiring inlets given in the photo.
- Do not allow slackening of the terminal screws.
 - Ⓐ Inlet for control cable
 - Ⓑ Inlet for power
 - Ⓒ Clamp
 - Ⓓ Interface / Outdoor unit connecting terminals
 - Ⓔ Earth terminal

3.1.1. Interface unit power supplied from outdoor unit

The following connection patterns are available.

The outdoor unit power supply patterns vary on models.

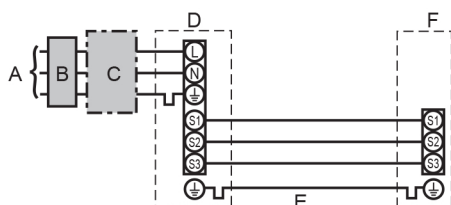

- A Outdoor unit power supply
- B Earth leakage breaker
- C Wiring circuit breaker or isolating switch
- D Outdoor unit
- E Interface unit/outdoor unit connecting cables
- F Interface unit

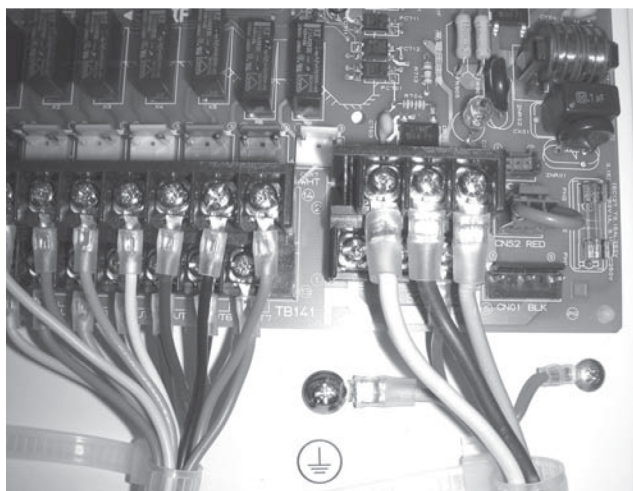

Photo.3-2

Interface unit model		PAC-IF011/012B-E	
Wiring Wire No. x size (mm ²)	Interface unit-Outdoor unit	*1	3 × 1.5 (polar)
	Interface unit-Outdoor unit earth	*1	1 × Min. 1.5
Circuit rating	Interface unit-Outdoor unit S1-S2	*2	AC 230 V
	Interface unit-Outdoor unit S2-S3	*2	DC24 V

*1. Max. 80 m

*2. The figures are NOT always against the ground.

S3 terminal has DC 24 V against S2 terminal. However between S3 and S1, these terminals are not electrically insulated by the transformer or other device.

- Notes:
1. Wiring size must comply with the applicable local and national code.
 2. Power supply cables and interface unit/outdoor unit connecting cables shall not be lighter than polychloroprene sheathed flexible cable. (Design 60245 IEC 57)
 3. Install an earth longer than other cables.

3. Electrical work

3.1.2. Separate interface unit/outdoor unit power supplies

The following connection patterns are available.

The outdoor unit power supply patterns vary on models.

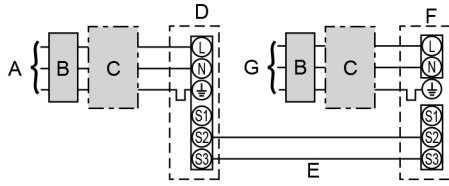

- A Outdoor unit power supply
- B Earth leakage breaker
- C Wiring circuit breaker or isolating switch
- D Outdoor unit
- E Interface unit/outdoor unit connecting cables
- F Interface unit
- G Interface unit power supply

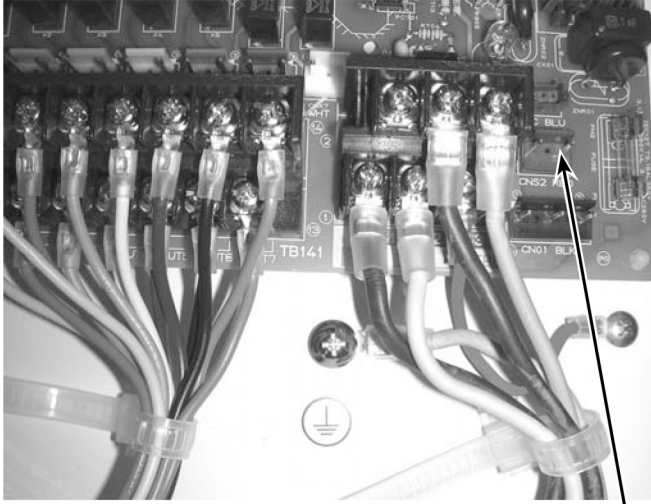

Photo.3-3

CNS2

If the interface and outdoor units have separate power supplies, refer to the table below.

		Separate power supply specifications									
Interface unit controller connector (CNS2) connection change		Disconnected									
Outdoor unit DIP switch settings (when using separate interface unit/outdoor unit power supplies only)		<table border="1"> <tr> <td>ON</td> <td></td> <td></td> <td>3</td> </tr> <tr> <td>OFF</td> <td>1</td> <td>2</td> <td></td> </tr> </table> (SW8)		ON			3	OFF	1	2	
ON			3								
OFF	1	2									
		Set the SW8-3 to ON.									

Interface unit model		PAC-IF011/012B-E	
Interface unit power supply		~N (Single Phase), 50 Hz, 230 V	
Interface unit input capacity		*1	16 A
Main switch (Breaker)			
Wiring Wire No. x size (mm ²)	Interface unit power supply		2 × Min. 1.5
	Interface unit power supply earth		1 × Min. 1.5
	Interface unit-Outdoor unit		*2 2 × Min. 0.3
	Interface unit-Outdoor unit earth		—
Circuit rating	Interface unit L-N		*3 AC 230 V
	Interface unit-Outdoor unit S1-S2		—
	Interface unit-Outdoor unit S2-S3		*3 DC24 V

*1. A breaker with at least 3.0mm contact separation in each pole shall be provided. Use earth leakage breaker (NV).

*2. Max. 120 m

*3. The figures are NOT always against the ground.

- Notes:**
1. Wiring size must comply with the applicable local and national code.
 2. Power supply cables and interface unit/outdoor unit connecting cables shall not be lighter than polychloroprene sheathed flexible cable. (Design 60245 IEC 57)
 3. Install an earth longer than other cables.

3.1.3. Connecting thermistor cable

Connect the thermistor ② for the interface controller.

1. Target temp. thermistor (TH1)
Connect the thermistor for the target temp. to 1 and 2 on the terminal block (TB61) on the interface controller.
2. Pipe temp. thermistor / Liquid (TH2)
Connect the thermistor for the pipe temp. to 3 and 4 on the terminal block (TB61) on the interface controller.
3. Cond./eva. temp. thermistor (TH5): For PAC-IF012B-E only
Connect the thermistor for the cond./eva. temp. to 5 and 6 on the terminal block (TB61) on the interface controller.

When the thermistor cables are too long, cut it to the appropriate length.
Do not bind it in the interface unit.

⚠ Caution:
Do not route the thermistor cables together with power cables.
The sensor part of the thermistor should be installed where user must not touch.
(It is separated by the supplementary insulation from where user may touch.)

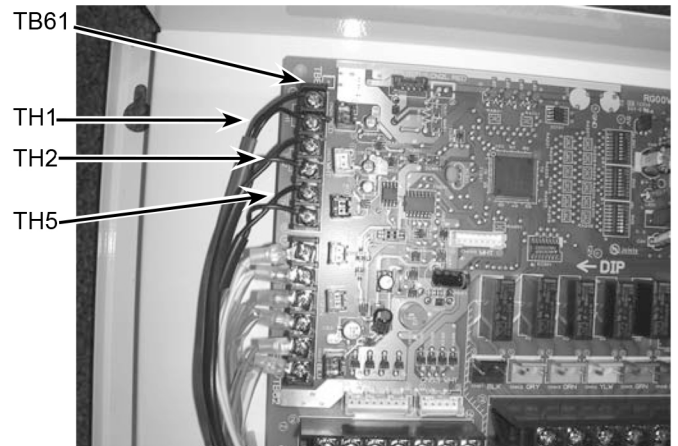

Photo.3-4

3. Electrical work

3.1.4. Connecting external input

Demand control is available by external input.

It is possible to set the outdoor unit's power consumption by setting the switch of the interface controller.

Switch1, Switch 6 : Input selection of inverter capacity setting

Input	SW 1-1	SW 1-2	SW 1-3	SW 6-1	SW 6-2	Step for capacity setting
REMOTE SWITCH Type A (4bit-8 setting)	OFF	OFF	OFF	OFF	OFF	OFF/Step1/Step2/.../Step7/Auto
REMOTE SWITCH Type B (1bit-1 setting)	ON	OFF	OFF	OFF	OFF	OFF/Step1/Step4/Step7/Auto
4-20mA	ON	ON	OFF	ON	ON	OFF/Step1/Step2/.../Step7
1-5V	ON	ON	OFF	OFF	ON	OFF/Step1/Step2/.../Step7
0-10V	OFF	OFF	ON	OFF	OFF	OFF/Step1/Step2/.../Step7
0-10kΩ	ON	OFF	ON	OFF	OFF	OFF/Step1/Step2/.../Step7/Auto
No input (AUTO mode)	OFF	ON	ON	OFF	OFF	Only Auto mode

• REMOTE SWITCH Type A (4bit - 8 setting) / Type B (1bit -1 setting)

TB142 10-11 (COM-IN5)	TB142 10-12 (COM-IN6)	TB142 10-13 (COM-IN7)	TB142 10-14 (COM-IN8)	Step for capacity setting				Remark		
				TypeA		TypeB				
OFF	OFF	OFF	OFF	[OFF]	OFF	0%	[OFF]	OFF	Hz fixed mode	
ON	OFF	OFF	OFF	[ON]	Step1	10%	[ON]	Step1		10%
OFF	ON	OFF	OFF		Step2	20%		Step4		50%
ON	ON	OFF	OFF		Step3	30%				
OFF	OFF	ON	OFF		Step4	50%		Step7		100%
ON	OFF	ON	OFF		Step5	70%				
OFF	ON	ON	OFF		Step6	80%				
ON	ON	ON	OFF		Step7	100%				
OFF	OFF	OFF	ON		Auto			Auto		Auto mode

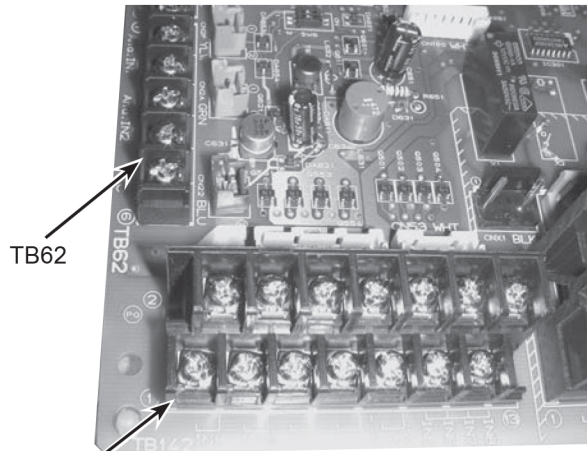
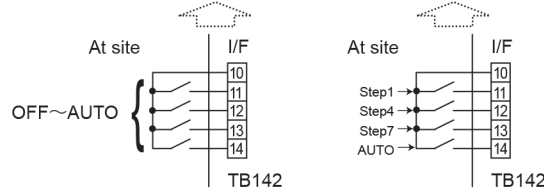

Photo.3-5

Demand control is available by connecting remote switches with terminal No.10 - 14.

Make sure to use the non-voltage switch (for the remote switch)

Remote switch cable length : Maximum 10m

Remote switch : Minimum applicable load DC12V, 1mA

• 4-20mA / 1-5V / 0-10V / 0-10kΩ

① Use 4-20mA / 1-5V / 0-10V

Connect the transmission cables to No. 3 and 4 on the terminal block (TB62).

No. 3 on the terminal block (TB62) : Plus side

No. 4 on the terminal block (TB62) : Minus side (Reference side)

② Use adjustable resistor (0-10kΩ)

Connect the transmission cables to No. 1 and 2 on the terminal block (TB62).

Adjustable resistor (0-10kΩ)	4-20mA	1-5V	0-10V	Step for capacity setting	Remark
0~100Ω	4~5mA	0~1.25V	0~0.63V	OFF 0%	Stop
510Ω	7mA	1.75V	1.88V	Step1 10%	Hz fixed mode
1kΩ	9mA	2.25V	3.13V	Step2 20%	
2kΩ	11mA	2.75V	4.38V	Step3 30%	
3.3kΩ	13mA	3.25V	5.63V	Step4 50%	
4.3kΩ	15mA	3.75V	6.88V	Step5 70%	
5.6kΩ	17mA	4.25V	8.13V	Step6 80%	
7.5kΩ	19~20mA	4.75~5V	9.38~10V	Step7 100%	
10kΩ	-	-	-	Auto	Auto mode
OPEN(12kΩ~)	-	-	-	OFF 0%	Stop

*The value of the above-mentioned table becomes the center of the input value.

Cable length : Maximum 10m

• External function setting

This function is setting operation mode or stopping compressor, by the external signal.

TB142	Item	OFF	ON	Remark
1-2 (IN1)	Forced Comp.	OFF	Normal	Forced Comp. OFF
3-4 (IN2)Item	Fixed operation mode	Cooling	Heating	Available when SW2-1 and SW2-2 are ON

Cable length : Maximum 10m

Remote switch : Minimum applicable load DC12V, 1mA

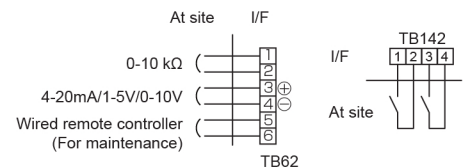

⚠ Caution:

The external input signals are separated by basic insulation from power supply for the unit.

The external input signals should be separated by supplementary insulation from where user may touch in case that it is installed where user may touch.

Connect the terminals by using the ring terminals and also insulate the cables of adjoining terminals when wiring to terminal block.

3. Electrical work

3.1.5. Connecting External Output

The signal in the following states can be output.

TB141		Item	OFF	ON
1-2 (OUT1)	X1	Operation Output	OFF	ON
3-4 (OUT2)	X2	Error Output	Normal	Error
5-6 (OUT3)	X3	Comp. Output	OFF(Comp. OFF)	ON (Comp. ON)
7-8 (OUT4)	X4	Defrost Output	OFF	ON (Defrosting)
9-10 (OUT5)	X5	Mode(Cool) Output	OFF	ON (Cooling)
11-12 (OUT6)	X6	Mode(Heat) Output	OFF	ON (Heating)
13-14 (OUT7)	-	-	-	-

Cable length : Maximum 50m

Output specification : Non-voltage switch 1A or less , 240V AC

*Connect the surge absorber according to the load at site.

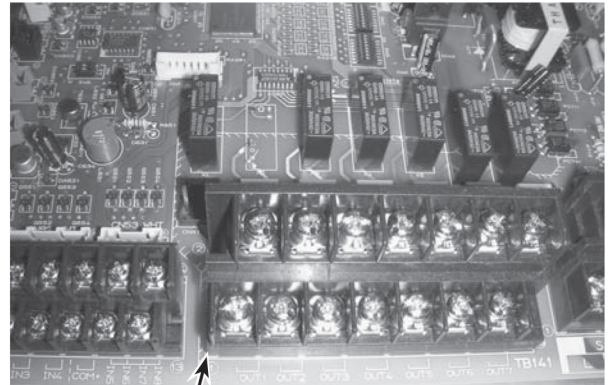
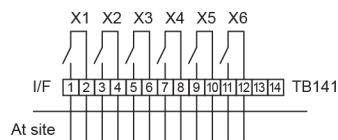

Photo.3-6

TB141

Note : External output signals are separated by basic insulation from other circuit of interface.

⚠ Caution : When 2 or more external outputs are used, the power supply on the output side should be the same.

3.1.6. Wiring specification External output / External input Locally supplied parts

Item	Name	Model and specifications
External output function	External output signal wire	Use sheathed vinyl coated cord or cable. Wire type : CV, CVS or equivalent. Wire size : Stranded wire 0.5mm ² to 1.25mm ² Solid wire : φ0.65mm to φ1.2mm
	Display lamp, etc.	Non-voltage Contact AC220-240V (DC30V), 1A or less
External input function	External input signal wire	Use sheathed vinyl coated cord or cable. Wire type : CV, CVS or equivalent. Wire size : Stranded wire 0.5mm ² to 1.25mm ² Solid wire : φ0.65mm to φ1.2mm
	Switch	Non-voltage "a" contact

3.1.7. Switch setting

It is possible to set the following function by setting the switch of the interface controller.

• SW2-1/2-2 : Fixed operation mode

SW2-1	SW2-2	Details
OFF	OFF	Not FIX (Depending on Remote controller setting)
ON	OFF	[Cooling] FIX
OFF	ON	[Heating] FIX
ON	ON	External input (Depending on TB142-3, 4)

• SW2-3/2-4/2-5 : Fixed set temperature [For Auto mode only]

SW2-3	SW2-4	SW2-5	Details
OFF	OFF	OFF	Not fixed (Remote controller setting)
ON	OFF	OFF	Cooling 19°C/Heating 17°C FIX
OFF	ON	OFF	20°C FIX
ON	ON	OFF	22°C FIX
OFF	OFF	ON	24°C FIX
ON	OFF	ON	26°C FIX
OFF	ON	ON	28°C FIX
ON	ON	ON	Cooling 30°C/Heating 28°C FIX

Set switches in case of auto mode.

• SW2-6 : COND./EVA. TEMP. THERMISTOR (TH5)

SW2-6	Details	Model
OFF	Effect	PAC-IF012B-E
ON	No effect	PAC-IF011B-E

3.1.8. Before test run

After completing installation and the wiring and piping of the local application and outdoor units, check for refrigerant leakage, looseness in the power supply or control wiring, wrong polarity, and no disconnection of one phase in the supply.

Use a 500-volt megohmmeter to check that the resistance between the power supply terminals and ground is at least 1.0MΩ.

⚠ Warning:

Do not use the system if the insulation resistance is less than 1.0MΩ.

⚠ Caution:

Do not carry out this test on the control wiring (low voltage circuit) terminals.

Local Application Factors

* This interface is to connect Mr. Slim inverter outdoor unit of MITSUBISHI ELECTRIC to local applications. Please check the following when designing the local system.

* MITSUBISHI ELECTRIC does not take any responsibility on the local system design.

1. Heat exchanger

(1) Withstanding pressure

Designed pressure of outdoor unit is 4.15 MPa. Following must be satisfied for burst pressure of connecting application.

Burst pressure : More than 12.45 MPa (3 times more than designed pressure)

(2) Performance

Secure the heat exchanger capacity which meets the following conditions. If the conditions are not met, it may result in malfunction caused by the protection operation or the outdoor unit may be turned off due to the operation of protection system.

1. Evaporate temperature is more than 4°C in max. frequency operation under ^{*1}the cooling rated conditions.
2. Condense temperature is less than 60°C in max. frequency operation under ^{*2}the heating rated conditions.
3. In case of hot water supply, condense temperature is less than 58°C in max. frequency operation with the outside temperature 7°C D.B./6°C W.B.

※1. Indoor: 27°C D.B./19°C W.B. Outdoor: 35°C D.B./24°C W.B.

※2. Indoor: 20°C D.B. Outdoor: 7°C D.B./6°C W.B.

(3) Heat exchanger internal capacity

Heat exchanger internal capacity must be within the capacity range shown below. If the heat exchanger below the minimum capacity is connected, it may result in the back flow of liquid or the failure of the compressor.

If the heat exchanger above the maximum capacity is connected, it may result in the deficiency in performance due to lack of refrigerant or overheating of the compressor.

Minimum capacity : $10 \times \text{Model capacity} [\text{cm}^3]$ / Maximum capacity : $30 \times \text{Model capacity} [\text{cm}^3]$

e.g. When connecting to PUHZ-RP100 VHA2

Minimum capacity : $10 \times 100 = 1000 \text{ cm}^3$

Maximum capacity : $30 \times 100 = 3000 \text{ cm}^3$

Model capacity	35	50	60	71	100	125	140	200	250
Maximum capacity [cm ³]	1050	1500	1800	2130	3000	3750	4200	6000	7500
Minimum capacity [cm ³]	350	500	600	710	1000	1250	1400	2000	2500

(4) Contamination maintenance

1. Wash the inside of heat exchanger to keep it clean. Be sure to rinse not to leave flux. Do not use chlorine detergent when washing.
2. Be sure that the amount of contamination per unit cubic content of heat transfer pipe is less than the following amount.

Example) In case of $\phi 9.52\text{mm}$

Residual water : 0.6mg/m, Residual oil : 0.5mg/m, Solid foreign object : 1.8mg/m

2. Thermistor position

<Target temp.thermistor (TH1)> (Used only in *auto mode (Only for Air to Air applications))

1. Put thermistor (TH1) where average intake temperature for heat exchanger can be detected.
2. It is better to put thermistor (TH1) where radiant heat from heat exchanger can be avoided.

To use this interface for manual step control, put a fixed resistor of 4~10kΩ instead of thermistor (TH1 on the terminal block TB61).

* Auto mode: In this mode, the capacity step of the outdoor unit is controlled automatically to let the target (intake) temperature reach the setting temperature. (Only for air to air application)

<Liquid pipe thermistor(TH2)>

1. Put thermistor (TH2) where liquid refrigerant pipe temperature can be detected.
2. It is better to protect the thermistor (TH2) with heat insulating materials not to be affected by the ambient temperature, etc.
3. In case that the refrigerant is distributed by distributor, put thermistor (TH2) before the distributor.

<Cond./Eva. temp. thermistor (TH5)>

1. Put thermistor (TH5) where Cond./Eva. temperature can be detected on the indoor HEX pipe.