



AIR-COOLED SPLIT-TYPE
PACKAGED AIR CONDITIONERS

Changes for the Better

2005

TECHNICAL & SERVICE MANUAL

<Indoor unit>

HEAT PUMP

Models
PEH-P400MYA
PEH-P500MYA

For use with the R407C

Contents

	Page
1 PRECAUTIONS FOR DEVICES THAT USE R407C REFRIGERANT	1
[1] Storage of Piping Material	2
[2] Piping Machining	3
[3] Necessary Apparatus and Materials and Notes on Their Handling	4
[4] Brazing	5
[5] Airtightness Test	6
[6] Vacuuming	6
[7] Charging of Refrigerant	7
2 PART NAMES AND FUNCTIONS	8
3 SPECIFICATIONS	10
4 PART NAMES AND FUNCTIONS	12
5 ELECTRICAL WIRING DIAGRAM	15
6 TECHNICAL DATA TO MEET LVD	16
[1] Capacity/Input Ratio against Changes in Room Airflow Rate	16
[2] Bypass Factor Curves	16
[3] Cooling Sensible Heating Capacity Table	17
[4] Airflow Characteristic Curves	17
[5] Center of Gravity (Indoor unit)	18
[6] NC Curve (Indoor unit)	19
7 SERVICE DATA	20
[1] Appearance of Equipment	20
[2] Internal Construction	21
[3] Refrigerant Circuit	21
8 FUNCTION OF SWITCH ON INDOOR CIRCUIT BOARD	22
[1] DIP SW1 for model Selection (DIP SW1 has been set at factory)	22
[2] DIP SW2 for Capacity Setting (DIP SW2 has been set at factory)	22
[3] DIP SWE for Emergency Operation	22
9 TEST RUN	23
[1] Before test run	23
[2] Test run procedures	23
[3] Self-diagnosis	26
[4] Remote controller diagnosis	27

1 PRECAUTIONS FOR DEVICES THAT USE R407C REFRIGERANT

Caution

Do not use the existing refrigerant piping.

- A large amount of chlorine that may be contained in the residual refrigerant and refrigerating machine oil in the existing piping may cause the refrigerating machine oil in the new unit to deteriorate.

Use refrigerant pipes made of phosphorus deoxidized copper. Keep the inner and outer surfaces of the pipes clean and free of such contaminants as sulfur, oxides, dust, dirt, shaving particles, oil, and water.

- These types of contaminants inside the refrigerant pipes may cause the refrigerant oil to deteriorate.

Store the pipes to be installed indoors, and keep both ends of the pipes sealed until immediately before brazing. (Keep elbows and other joints wrapped in plastic.)

- Infiltration of dust, dirt, or water into the refrigerant system may cause the refrigerating machine oil to deteriorate or cause the unit to malfunction.

Use a small amount of ester oil, ether oil, or alkylbenzene to coat flares and flanges.

- Infiltration of a large amount of mineral oil may cause the refrigerating machine oil to deteriorate.

Charge liquid refrigerant (as opposed to gaseous refrigerant) into the system.

- If gaseous refrigerant is charged into the system, the composition of the refrigerant in the cylinder will change and may result in performance loss.

Only use refrigerant R407C.

- The use of other types of refrigerant that contain chlorine (i.e. R22) may cause the refrigerating machine oil to deteriorate.

Use a vacuum pump with a reverse-flow check valve.

- If a vacuum pump that is not equipped with a reverse-flow check valve is used, the vacuum pump oil may flow into the refrigerant cycle and cause the refrigerating machine oil to deteriorate.

Prepare tools for exclusive use with R407C. Do not use the following tools if they have been used with the conventional refrigerant (gauge manifold, charging hose, gas leak detector, reverse-flow check valve, refrigerant charge base, vacuum gauge, and refrigerant recovery equipment.)

- If the refrigerant or the refrigerating machine oil left on these tools are mixed in with R407C, it may cause the refrigerating machine oil to deteriorate.
- Infiltration of water may cause the refrigerating machine oil to deteriorate.
- Gas leak detectors for conventional refrigerants will not detect an R407C leak because R407C is free of chlorine.

Do not use a charging cylinder.

- If a charging cylinder is used, the composition of the refrigerant will change, and the unit may experience power loss.

Exercise special care when handling the tools for use with R407C.

- Infiltration of dust, dirt, or water into the refrigerant system may cause the refrigerating machine oil to deteriorate.

If the refrigerant leaks, recover the refrigerant in the refrigerant cycle, then recharge the cycle with the specified amount of the liquid refrigerant indicated on the air conditioner.

- Since R407C is a nonazeotropic refrigerant, if additionally charged when the refrigerant leaked, the composition of the refrigerant in the refrigerant cycle will change and result in a drop in performance or abnormal stopping.

[1] Storage of Piping Material

(1) Storage location



Store the pipes to be used indoors. (Warehouse at site or owner's warehouse)
Storing them outdoors may cause dirt, waste, or water to infiltrate.

(2) Pipe sealing before storage

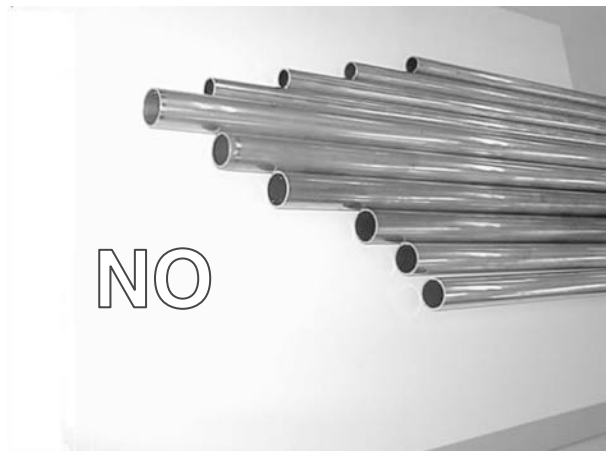
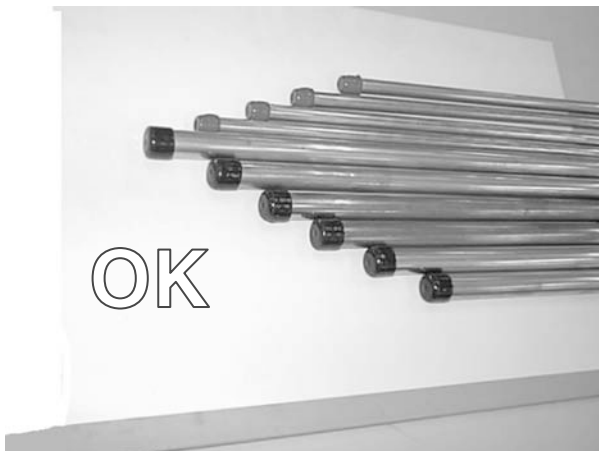

Both ends of the pipes should be sealed until immediately before brazing.
Wrap elbows and T's in plastic bags for storage.

* The new refrigerator oil is 10 times more hygroscopic than the conventional refrigerator oil (such as Suniso). Water infiltration in the refrigerant circuit may deteriorate the oil or cause a compressor failure. Piping materials must be stored with more care than with the conventional refrigerant pipes.

[2] Piping Machining

Use ester oil, ether oil or alkylbenzene (small amount) as the refrigerator oil to coat flares and flange connections.



Use only the necessary minimum quantity of oil.

Reason:

1. The refrigerator oil used for the equipment is highly hygroscopic and may introduce water inside.

Notes:

- Introducing a great quantity of mineral oil into the refrigerant circuit may also cause a compressor failure.
- Do not use oils other than ester oil, ether oil or alkylbenzene.

[3] Necessary Apparatus and Materials and Notes on Their Handling

The following tools should be marked as dedicated tools for R407C.

<<Comparison of apparatus and materials used for R407C and for R22>>

Apparatus Used	Use	R22	R407C
Gauge manifold	Evacuating, refrigerant filling	Current product	⊙
Charging hose	Operation check	Current product	⊙
Charging cylinder	Refrigerant charging	Current product	⊙ Do not use
Gas leakage detector	Gas leakage check	Current product	⊙ Shared with R134a
Refrigerant collector	Refrigerant collection	R22	⊙ For R407C use only
Refrigerant cylinder	Refrigerant filling	R22	⊙ Identification of dedicated use for R407C: Record refrigerant name and put brown belt on upper part of cylinder.
Vacuum pump	Vacuum drying	Current product	△ Can be used by attaching an adapter with a check valve.
Vacuum pump with a check valve		Current product	△
Flare tool	Flaring of pipes	Current product	△
Bender	Bending of pipes	Current product	△
Application oil	Applied to flared parts	Current product	⊙ Ester oil or Ether oil or Alkybenzene (Small amount)
Torque wrench	Tightening of flare nuts	Current product	△
Pipe cutter	Cutting of pipes	Current product	△
Welder and nitrogen cylinder	Welding of pipes	Current product	△
Refrigerant charging meter	Refrigerant charging	Current product	△
Vacuum gauge	Checking the vacuum degree	Current product	△

Symbols: ⊙ To be used for R407C only.

△ Can also be used for conventional refrigerants.

Tools for R407C must be handled with more care than those for conventional refrigerants. They must not come into contact with any water or dirt.

[4] Brazing

No changes from the conventional method, but special care is required so that foreign matter (ie. oxide scale, water, dirt, etc.) does not enter the refrigerant circuit.

Example: Inner state of brazed section

When non-oxide brazing was not used

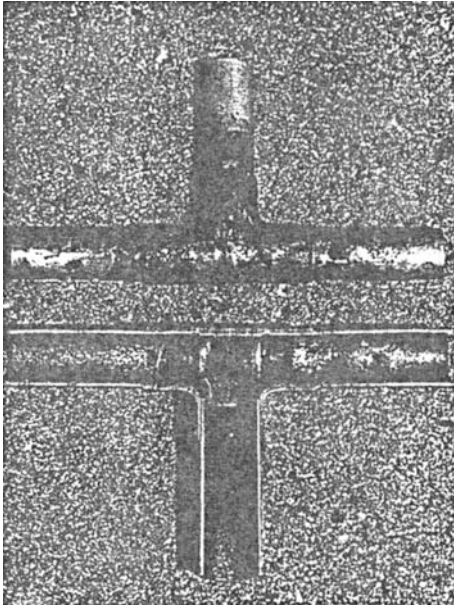

When non-oxide brazing was used

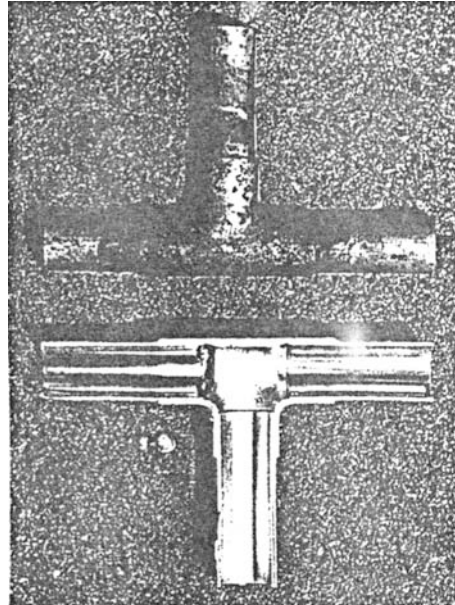

Items to be strictly observed:

1. Do not conduct refrigerant piping work outdoors on a rainy day.
2. Apply non-oxide brazing.
3. Use a brazing material (BCuP-3) which requires no flux when brazing between copper pipes or between a copper pipe and copper coupling.
4. If installed refrigerant pipes are not immediately connected to the equipment, then braze and seal both ends of them.

Reasons:

1. The new refrigerant oil is 10 times more hygroscopic than the conventional oil. The probability of a machine failure if water infiltrates is higher than with conventional refrigerant oil.
2. A flux generally contains chlorine. A residual flux in the refrigerant circuit may generate sludge.

Note:

- Commercially available antioxidants may have adverse effects on the equipment due to its residue, etc. When applying non-oxide brazing, use nitrogen.

[5] Airtightness Test

No changes from the conventional method. Note that a refrigerant leakage detector for R22 cannot detect R407C leakage.

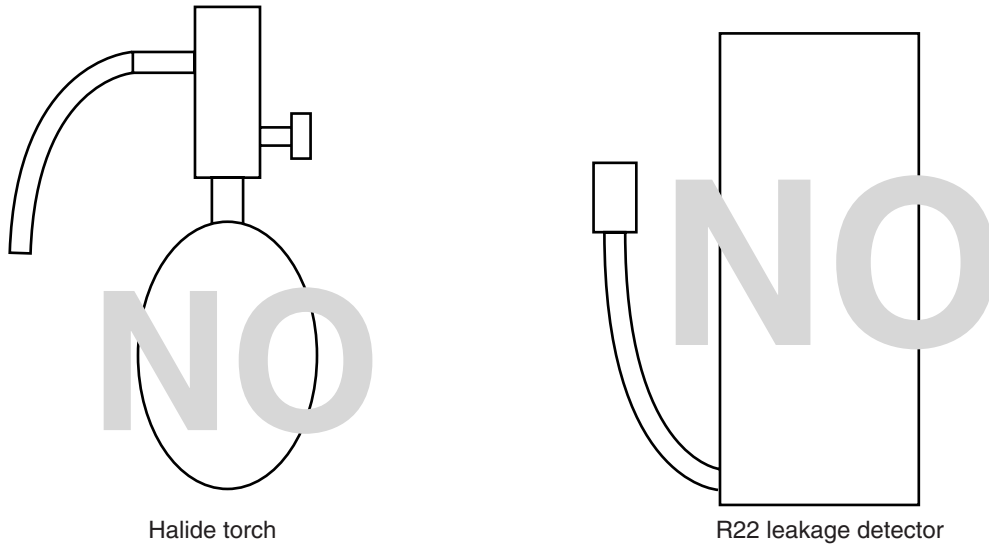

Halide torch

R22 leakage detector

Items to be strictly observed:

1. Pressurize the equipment with nitrogen up to the design pressure and then judge the equipment's airtightness, taking temperature variations into account.
2. When investigating leakage locations using a refrigerant, be sure to use R407C.
3. Ensure that R407C is in a liquid state when charging.

Reasons:

1. Use of oxygen as the pressurized gas may cause an explosion.
2. Charging with R407C gas will lead the composition of the remaining refrigerant in the cylinder to change and this refrigerant can then not be used.

Note:

- A leakage detector for R407C is sold commercially and it should be purchased.

[6] Vacuuming

1. Vacuum pump with check valve

A vacuum pump with a check valve is required to prevent the vacuum pump oil from flowing back into the refrigerant circuit when the vacuum pump power is turned off (power failure).

It is also possible to attach a check valve to the actual vacuum pump afterwards.

2. Standard degree of vacuum for the vacuum pump

Use a pump which reaches 0.5 Torr (500 MICRON) or below after 5 minutes of operation.

In addition, be sure to use a vacuum pump that has been properly maintained and oiled using the specified oil. If the vacuum pump is not properly maintained, the degree of vacuum may be too low.

3. Required accuracy of the vacuum gauge

Use a vacuum gauge that can measure up to 5 Torr. Do not use a general gauge manifold since it cannot measure a vacuum of 5 Torr.

4. Evacuating time

- Evacuate the equipment for 1 hour after -755 mmHg (5 Torr) has been reached.
- After evacuating, leave the equipment for 1 hour and make sure the that vacuum is not lost.

5. Operating procedure when the vacuum pump is stopped

In order to prevent a backflow of the vacuum pump oil, open the relief valve on the vacuum pump side or loosen the charge hose to drawn in air before stopping operation.

The same operating procedure should be used when using a vacuum pump with a check valve.

[7] Charging of Refrigerant

R407C must be in a liquid state when charging, because it is a non-azeotropic refrigerant.

For a cylinder with a syphon attached

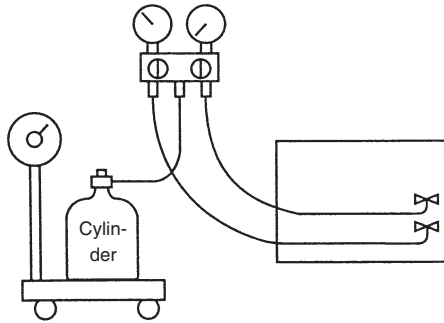

For a cylinder without a syphon attached

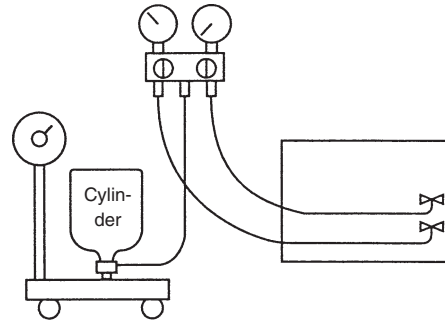

Cylinder color identification R407C-Gray
R410A-Pink

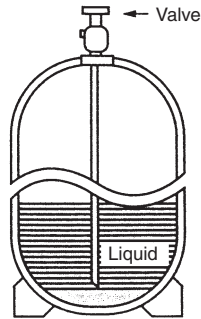

Charged with liquid refrigerant

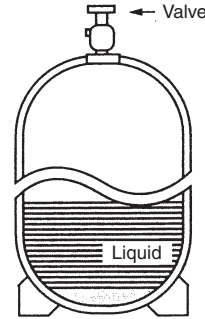

Reasons:

1. R407C is a mixture of 3 refrigerants, each with a different evaporation temperature. Therefore, if the equipment is charged with R407C gas, then the refrigerant whose evaporation temperature is closest to the outside temperature is charged first while the rest of refrigerants remain in the cylinder.

Note:

- In the case of a cylinder with a syphon, liquid R407C is charged without turning the cylinder up side down. Check the type of cylinder before charging.

2 PART NAMES AND FUNCTIONS

Indoor unit

- Air inlet : Sucks the ambient air in.
- Filter : The filter built into the unit as standard is a simple filter to remove visible dust and dirt. If air purification is one of the conditions required for use, consult with your dealer.
- Air outlet : Blows the air back out into the room.

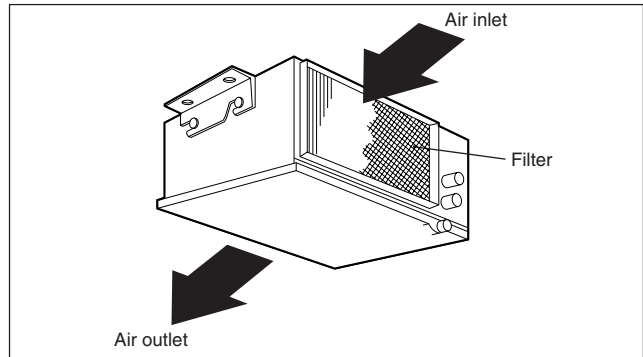

Remote controller (PAR-21MAA)

- Once the controls are set, the same operation mode can be repeated by simply pressing the ON/OFF button.

Operation buttons

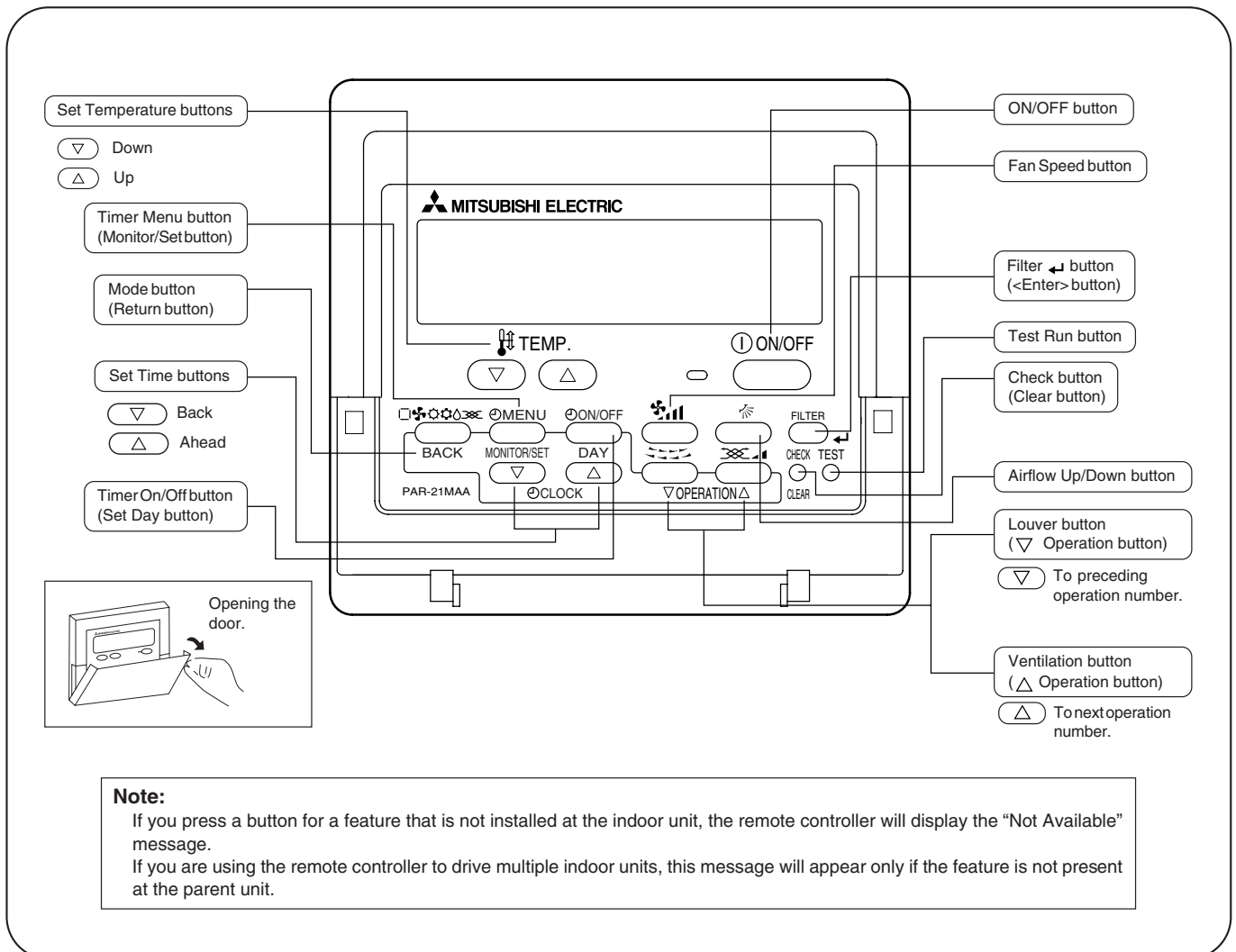

Display

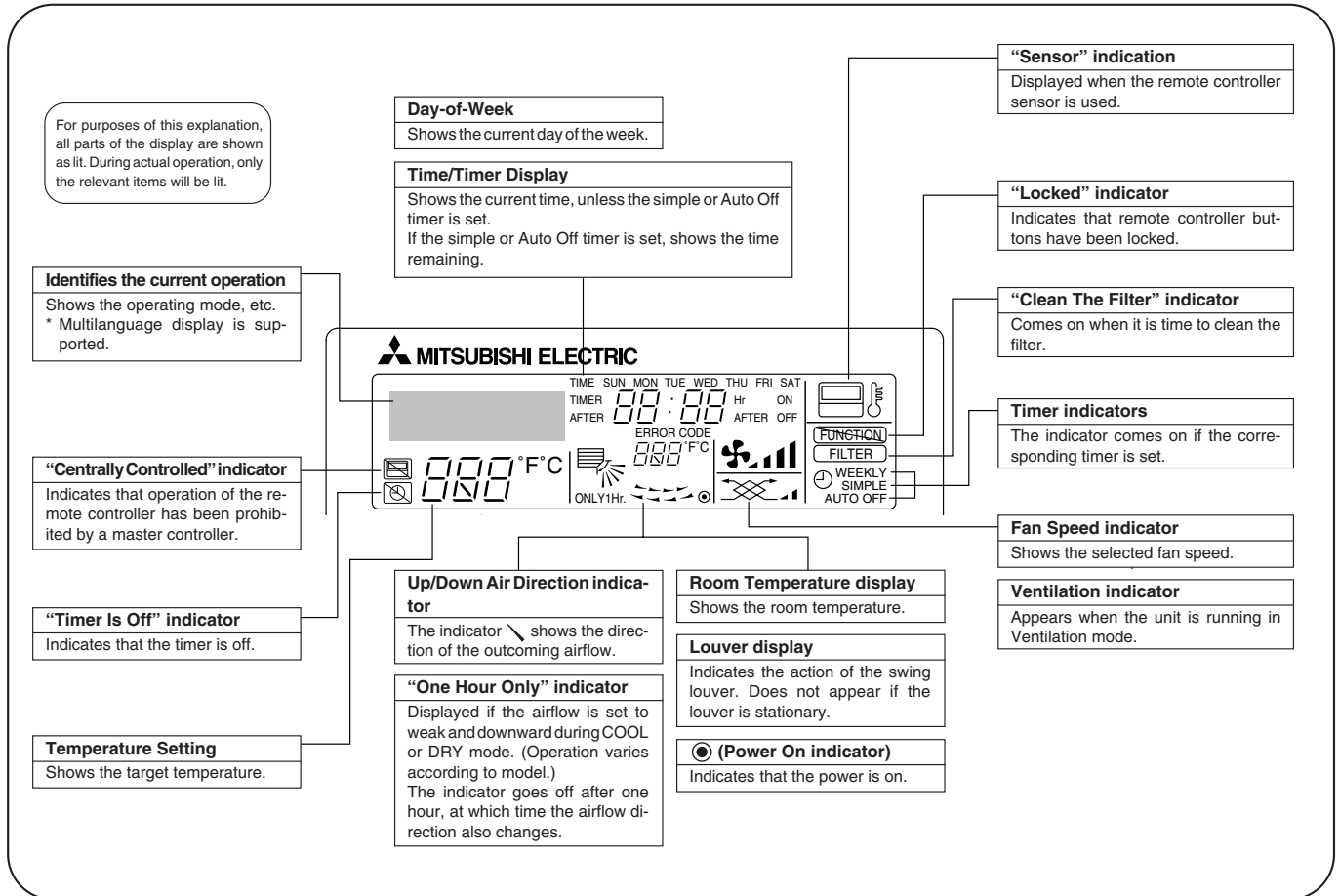

Caution

- Only the ● (Power on indicator) lights when the unit is stopped and power supplied to the unit.
- When the central control remote control unit, which is sold separately, is used the ON-OFF button, operation switch button and ⚙️ TEMP. adjustment button do not operate.
- If you press a button for a feature that is not installed at the indoor unit, the remote controller will display the “Not Available” message.
- When power is turned ON for the first time, it is normal that “PLEASE WAIT” is displayed on the screen (For max. 3minutes). Please wait until this “PLEASE WAIT” disappear then start the operation.

3 SPECIFICATIONS

Specifications of air-source heat pump type packaged air conditioner (Ceiling concealed type indoor unit)						
Model name	PEH-P400MYA		Quantity		Symbol	
			Cooling	Heating		
Capacity		kcal/h	36,000	40,800		
		kW	41.8	47.4		
Air condition	Indoor side	Dry bulb temperature/wet bulb temperature	27 °C/19 °C	20 °C/–		
	Outdoor side	Dry bulb temperature/wet bulb temperature	35 °C/24 °C	7 °C/6 °C		
Power source			3N~ 380/415V 50Hz			
Electrical characteristics		Power consumption	kW	2.3/2.3/2.3	2.3/2.3/2.3	
		Operating current	A	4.5/4.3/4.1	4.5/4.3/4.1	
Remote controller temperature setting range			°C	19 ~ 30	17 ~ 28	
Airflow direction control			–			
Fan	Type × Quantity		Sirrocco fan × 2			
	Airflow rate		m ³ /min	140		
	External static pressure		Pa	150, 170, 180		
	Motor output		kW	1.5		
External finish			Galvanizing			
External dimension		Unit (H × W × D)	mm	706 × 1,690 × 865		
		Panel (H × W × D)	mm	–		
Heat exchanger type			Cross fin			
Air filter			Saran net			
Insulation material			Polyethylene foam			
Refrigerant piping dimension Liquid/Gas			φmm	(12.7/25.4) × 2		
Drain piping dimension			φmm	25.4 (R1)		
Noise level			dB (A)	54, 55, 55		
Net weight			kg	180		
Control capacity			%	0 - 50 -100		
External wiring		Minimum wire thickness		1.6 mm		
		Circuit breaker		15 A		
Composing parts		Operation control device (provided)		Remote controller: PAR-21MAA		
		Decoration panel (Option)		–		
Other mountable major options			–			
Accessories			Installation manual, Operation manual, Remote controller			
Special note, Non-standard specifications, etc.			–			
Notes:	<ol style="list-style-type: none"> 1. The cooling and heating capacities are the maximum capacities that were obtained by operating in the above air conditions and with a refrigerant pipe of about 7.5 m. 2. The actual capacity characteristics vary with the combination of indoor and outdoor units. See the technical information. 3. The operating noise is the data that was obtained by measuring it 1.5 m from the unit's bottom in an anechoic room. (Noise meter A-scale value) 					

**Specifications of air-source heat pump type packaged air conditioner
(Ceiling concealed type indoor unit)**

Model name	PEH-P500MYA	Quantity		Symbol	
------------	--------------------	----------	--	--------	--

			Cooling	Heating	
Capacity		kcal/h	44,800	52,400	
		kW	52.0	61.0	
Air condition	Indoor side	Dry bulb temperature/wet bulb temperature	27 °C/19 °C	20 °C/–	
	Outdoor side	Dry bulb temperature/wet bulb temperature	35 °C/24 °C	7 °C/ 6 °C	
Power source			3N~ 380/415V 50 Hz		
Electrical characteristics	Power consumption		kW	2.5/2.5/2.5	2.5/2.5/2.5
	Operating current		A	5.1/4.9/4.7	5.1/4.9/4.7
Remote controller temperature setting range			°C	19 ~ 30	17 ~ 28
Airflow direction control			Vertical	–	
Fan	Type × Quantity		Sirrocco fan × 2		
	Airflow rate		m ³ /min	170	
	External static pressure		Pa	150, 160, 180	
	Motor output		kW	2.0	
External finish			Galvanizing		
External dimension	Unit (H × W × D)		mm	706 × 1,993 × 865	
	Panel (H × W × D)		mm	–	
Heat exchanger type			Cross fin		
Air filter			Saran net		
Insulation material			Polyethylene foam		
Refrigerant piping size		Liquid/Gas	φmm	(12.7/28.58) × 2	
Drain piping size			φmm	25.4 (R1)	
Noise level			dB (A)	60, 60, 60	
Net weight			kg	212	
Control capacity			%	0 - 50 - 100	
External wiring	Minimum wire thickness		1.6 mm		
	Circuit breaker		15 A		
Composing parts	Operation control device (provided)		Remote controller: PAR-21MAA		
	Decoration panel (Option)		–		
Other mountable major options			–		
Accessories			Installation manual, Operation manual, Remote controller		
Special note, Non-standard specifications, etc.			–		
Notes:	<ol style="list-style-type: none"> The cooling and heating capacities are the maximum capacities that were obtained by operating in the above air conditions and with a refrigerant pipe of about 7.5 m. The actual capacity characteristics vary with the combination of indoor and outdoor units. See the technical information. The operating noise is the data that was obtained by measuring it 1.5 m from the unit's bottom in an anechoic room. (Noise meter A-scale value) 				

4 PART NAMES AND FUNCTIONS

(1) Indoor Unit

• Models PEH-P400MYA

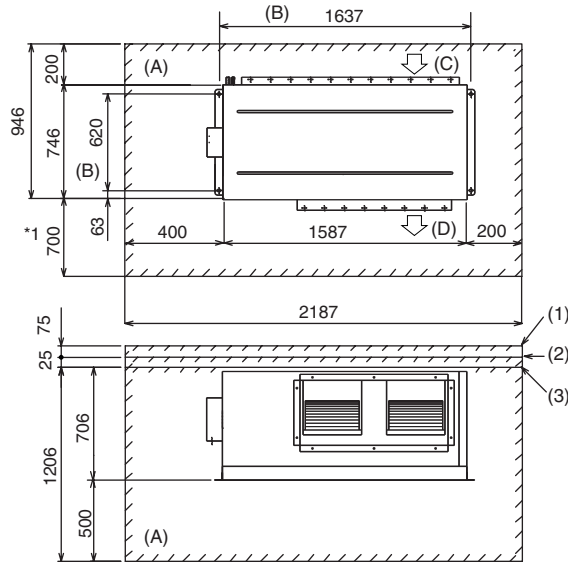

- (1)When connecting air inlet
 (2)When installing the suspension fixtures prior to installation of the indoor unit without inlet duct
 (3)When hanging the indoor unit directly without inlet duct
 (A)Service space
 (B)Suspension bolt pitch
 (C)Air inlet
 (D)Air outlet

*1 When there is not 500mm of service space on top of the unit, there must be 700mm of service space at the air outlet side.

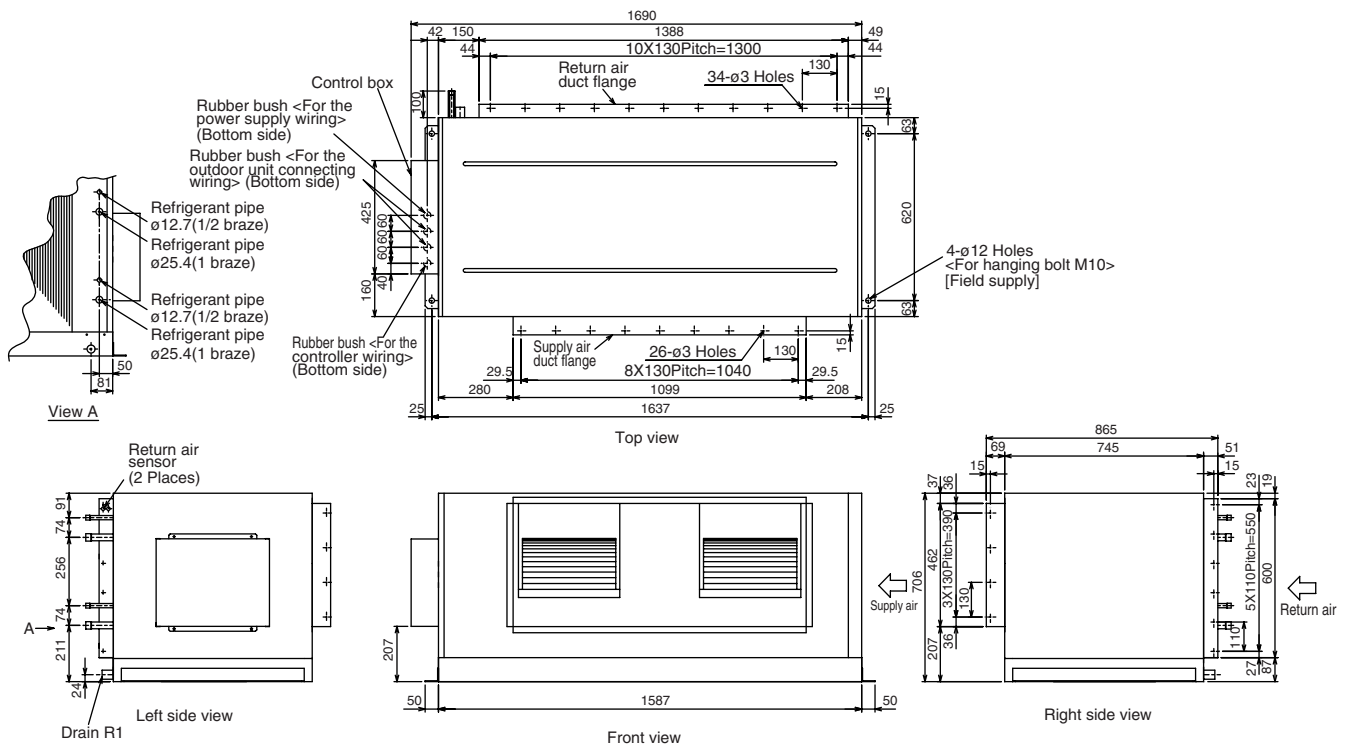

• Models PEH-P500MYA

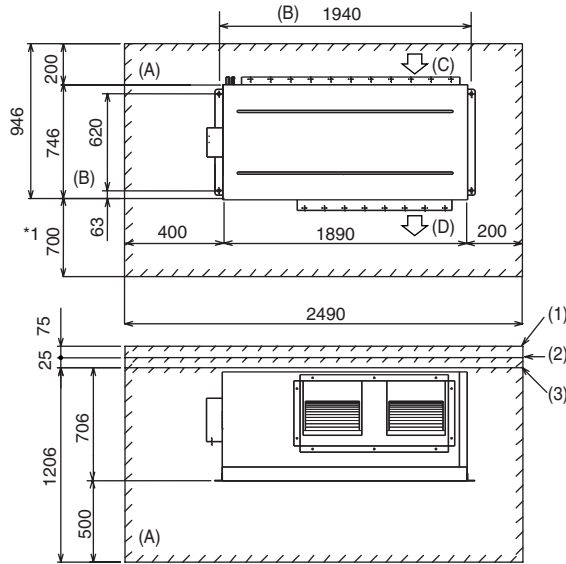

- (1)When connecting air inlet
- (2)When installing the suspension fixtures prior to installation of the indoor unit without inlet duct
- (3)When hanging the indoor unit directly without inlet duct
- (A)Service space
- (B)Suspension bolt pitch
- (C)Air inlet
- (D)Air outlet

*1 When there is not 500mm of service space on top of the unit, there must be 700mm of service space at the air outlet side.

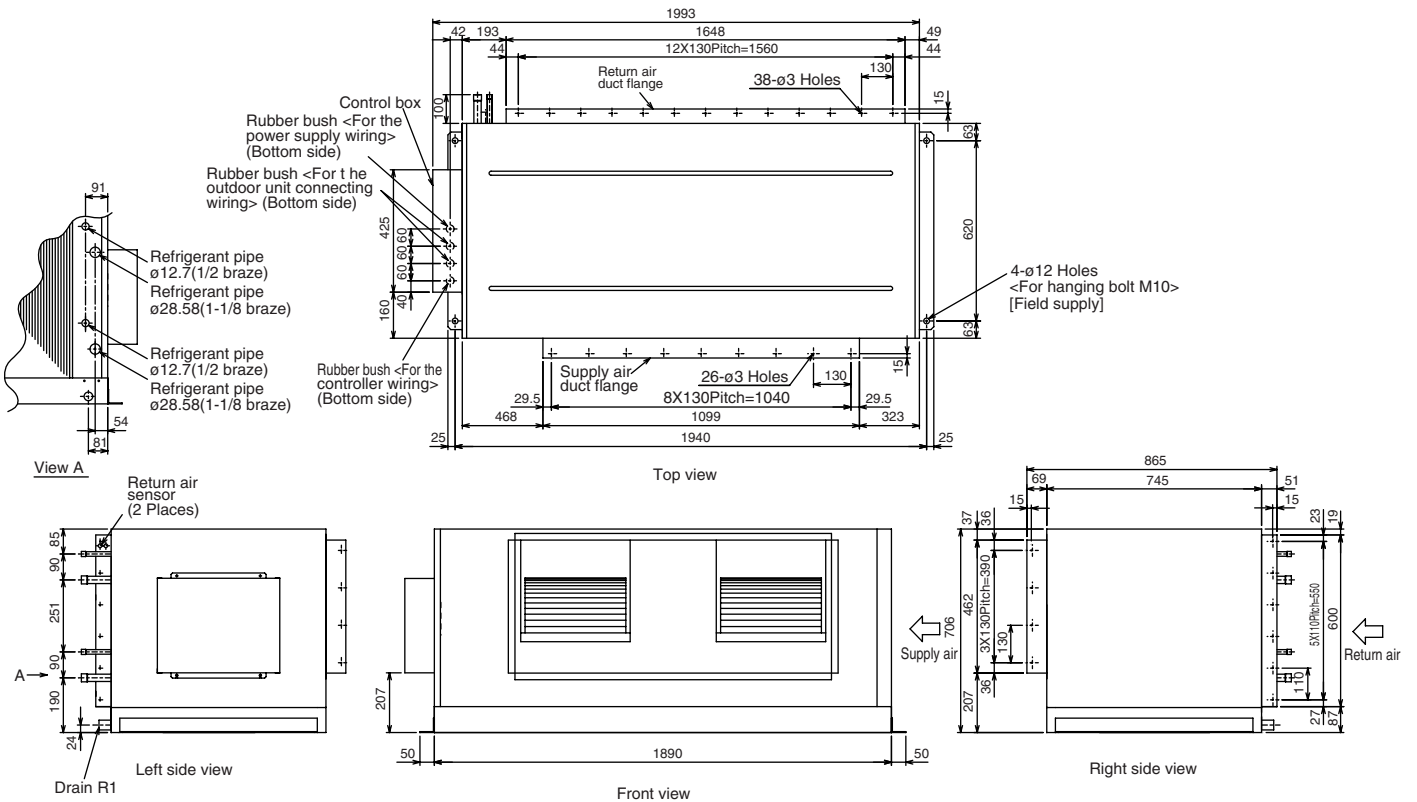

(2) Remote Controller

- Models PAR-21MAA

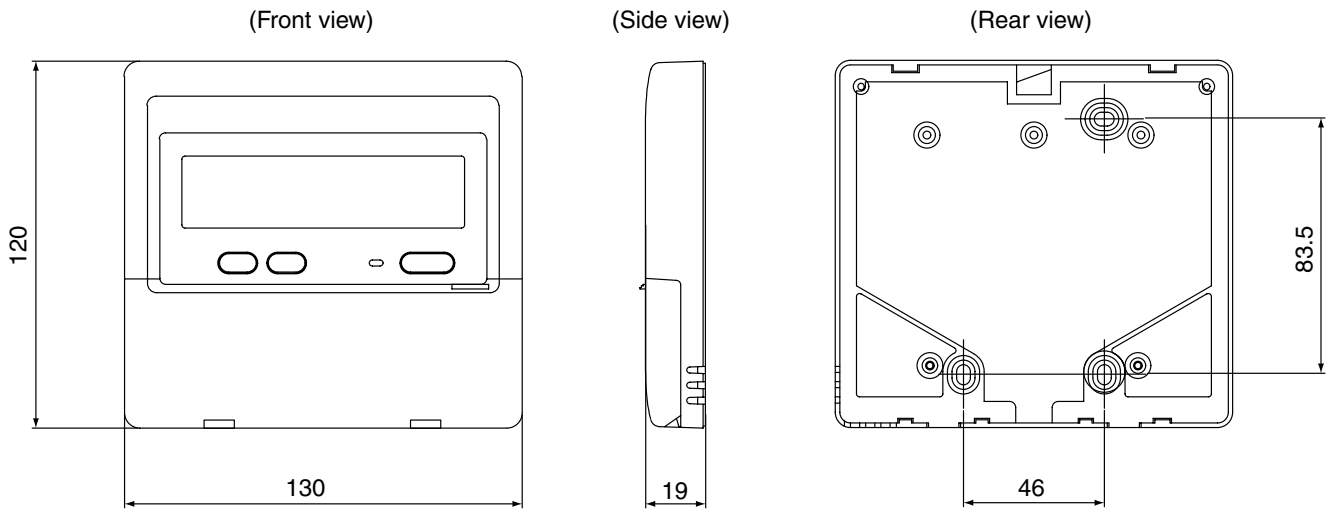

5 ELECTRICAL WIRING DIAGRAM

(1) Indoor Unit

• Models PEH-P400,500MYA

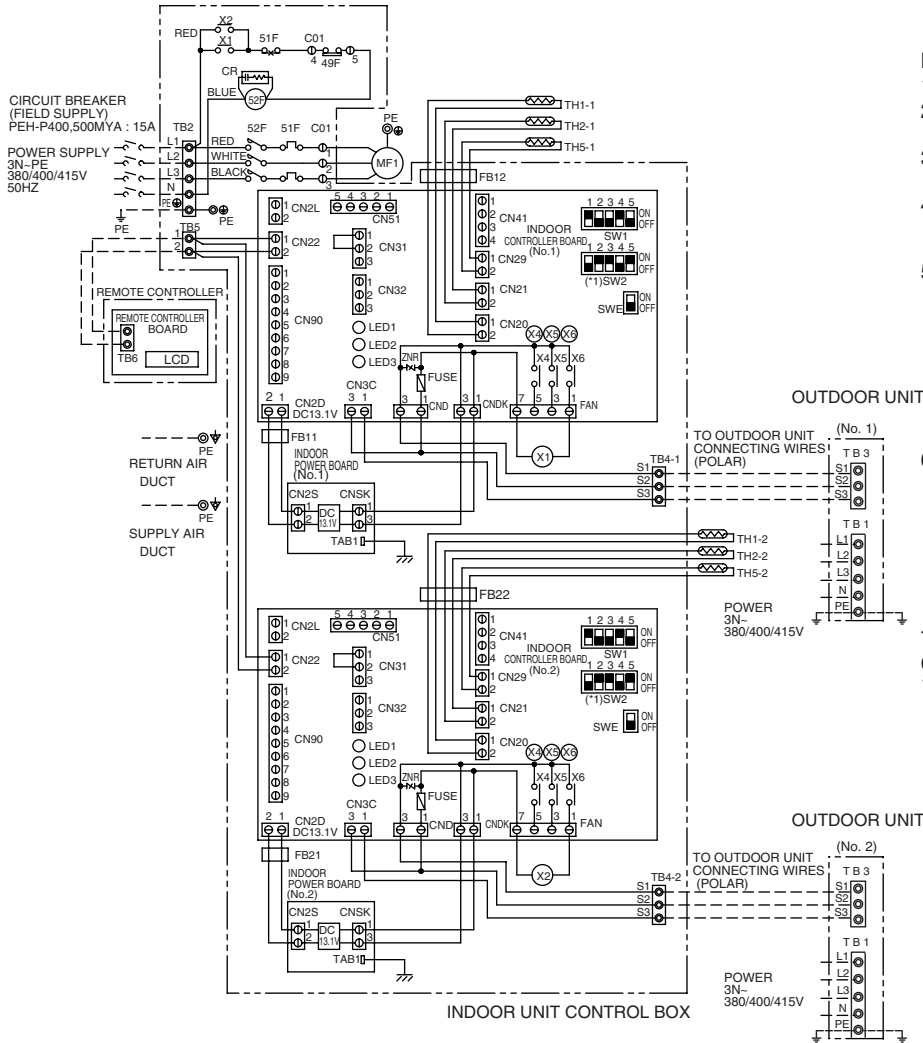

Note:

1. The dotted lines show field wiring.
2. Color of earth wire is yellow and green twisting.
3. Specification subject to change without notice.
4. Indoor and outdoor connecting wires are made with polarities, make sure matching wiring and terminal.
5. Emergency operation
If a trouble occurs with either the remote controller or the indoor microcomputer and no other trouble exists, emergency operation for cooling or heating can be performed by changing the setting of switch (SWE) "ON" on the indoor controller board.
6. SW2(*1) shows PEH-P500MYA setting. (2 places)
In case of PEH-P400MYA setting is shown as below.



7. ⊗ mark is connector.

Caution,

1. To protect fan motor from abnormal current, over current relays is installed. Therefore, do not change factory set value of over current relays.

INDOOR UNIT

SYMBOL	NAME	
MF1	FAN MOTOR (INDOOR)	
51F	OVER CURRENT RELAY (INDOOR FAN MOTOR)	
52F	MAGNETIC CONTACTOR (INDOOR FAN MOTOR)	
49F	INTERNAL THERMOSTAT (INDOOR FAN MOTOR)	
TB2,4-1,4-2,5	TERMINAL BLOCK	
TH1-1,1-2	ROOM TEMP	
TH2-1,2-2	THERMISTOR	LIQUID PIPE TEMP
TH5-1,5-2	COND/EVA TEMP	
X1,2	AUXILIARY RELAY	
CR	SURGE KILLER	
FB11,FB12 FB21,FB22	FERRITE CORE	
INDOOR CONTROLLER BOARD	FUSE	FUSE (T6.3AL250V)
	ZNR	VARISTOR
	X4-6	AUXILIARY RELAY
	SW1	SWITCH(MODEL SELECTION)
	SW2	SWITCH(CAPACITY CORD)
	SWE	SWITCH(EMERGENCY OPERATION)
	LED1	LED (POWER SUPPLY)
LED2	LED (POWER SUPPLY<REMOTE CONTROLLER>)	
LED3	LED (TRANSMISSION<INDOOR-OUTDOOR>)	

OUTDOOR UNIT

SYMBOL	NAME
TB3	TERMINAL BLOCK

REMOTE CONTROLLER

SYMBOL	NAME
TB6	TERMINAL BLOCK

6 TECHNICAL DATA TO MEET LVD

[1] Capacity/Input Ratio against Changes in Room Airflow Rate

• Models PEH-P400MYA

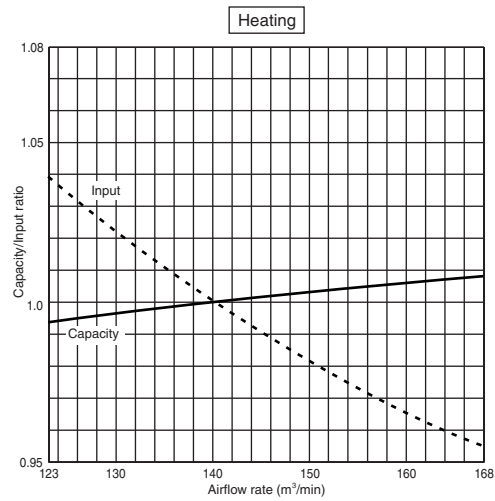
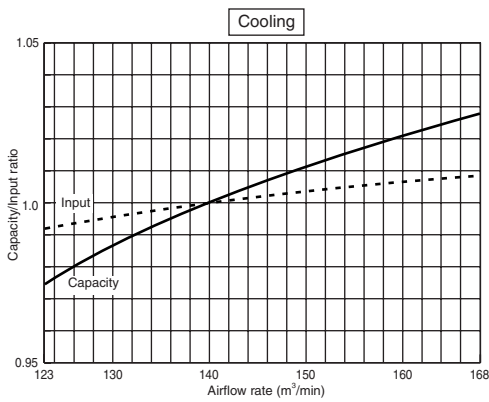

• Models PEH-P500MYA

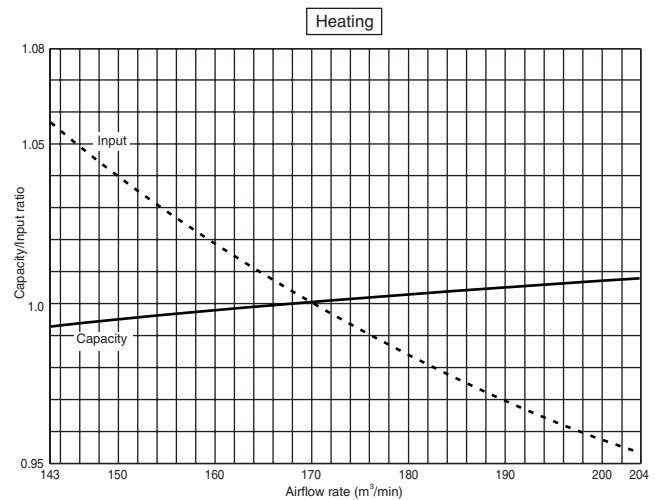
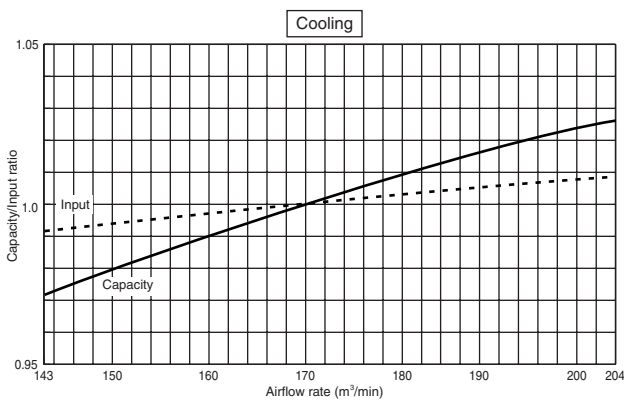

[2] Bypass Factor Curves

PEH-P400MYA

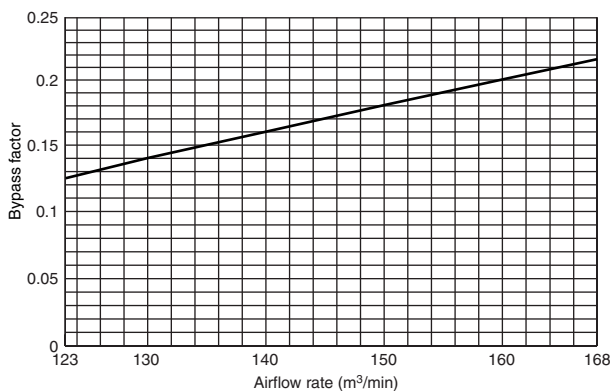

PEH-P500MYA

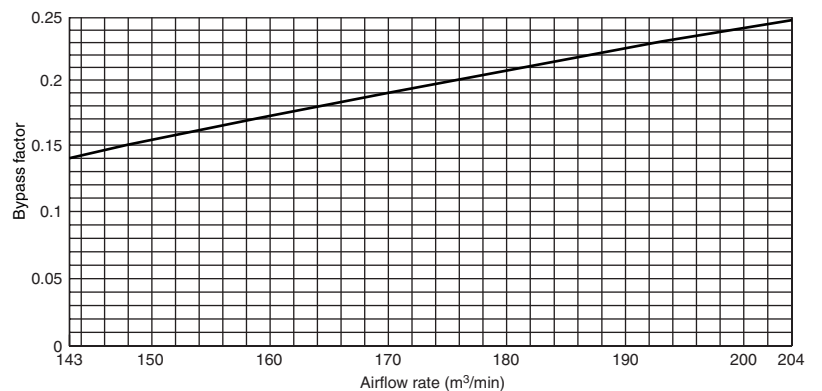

[3] Cooling Sensible Heating Capacity Table

(1) PEH-P400MYA (Airflow rate 140m³/min)

Outdoor temp. (°C)	Indoor inlet air temperature (DB/WB°C)									
	23/16		25/18		27/19		28/20		30/22	
	CA	SHC	CA	SHC	CA	SHC	CA	SHC	CA	SHC
20	36200	29200	38600	28900	40000	31000	41600	30900	43800	30400
25	35000	28600	37400	28400	39000	30500	40600	30500	43000	30100
30	33800	28100	36200	27900	37800	30100	39400	30100	41800	29700
35	32400	27400	34800	27300	36000	29300	38000	29500	40400	29200
40	30600	26600	33200	26700	34800	28800	36400	28900	39000	28700
43	29600	26200	32000	26200	33800	28400	35400	28500	38000	28300

(2) PEH-P500MYA (Airflow rate 170m³/min)

Outdoor temp. (°C)	Indoor inlet air temperature (DB/WB°C)									
	23/16		25/18		27/19		28/20		30/22	
	CA	SHC	CA	SHC	CA	SHC	CA	SHC	CA	SHC
20	45000	32900	48000	32700	49800	34600	51600	34600	54600	34100
25	43600	32200	46600	32000	48600	34100	50400	34100	53400	33600
30	42000	31400	45000	31300	47000	33400	49000	33500	52000	33000
35	40200	30600	43200	30500	44800	32500	47200	32700	50400	32400
40	38200	29600	41200	29600	43200	31800	45400	32000	48400	31600
43	36800	29000	40000	29100	42000	31300	44000	31400	47200	31200

[4] Airflow Characteristic Curves

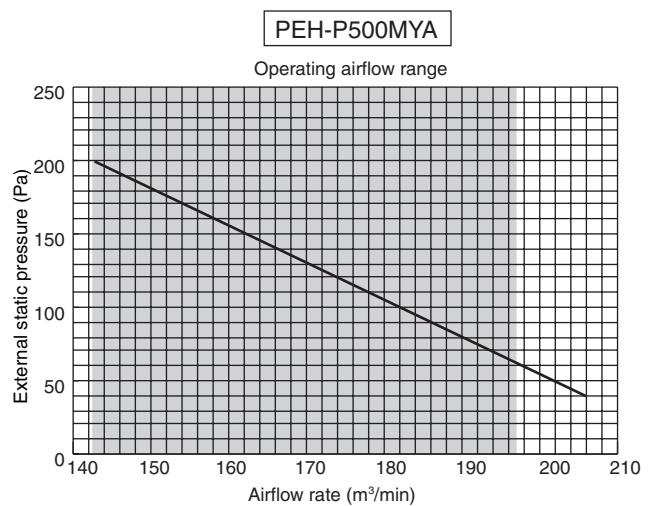
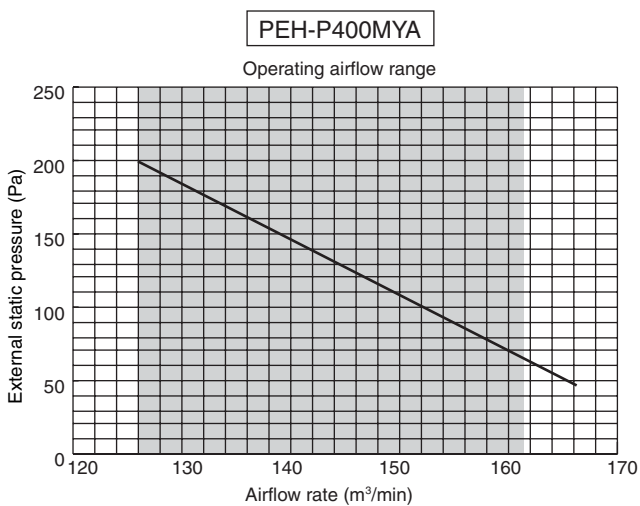

[5] Center of Gravity (Indoor unit)

• Models PEH-P400MYA/P500MYA

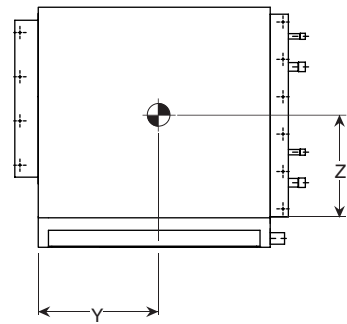
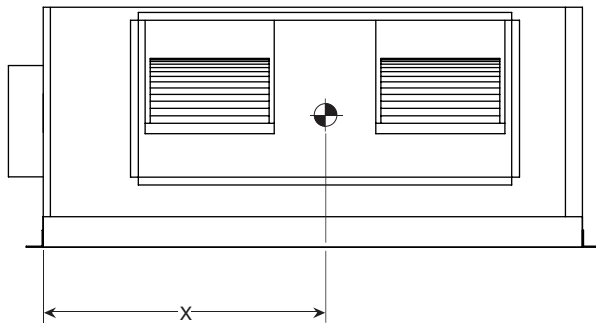
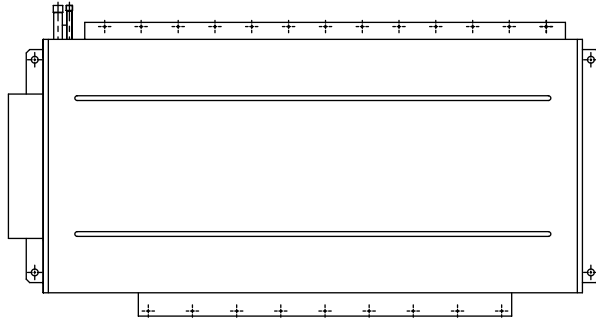

unit : (mm)

Model name \ Item	Center of gravity		
	X	Y	Z
PEH-P400MYA	830	420	340
PEH-P500MYA	1015	390	340

[6] NC Curve (Indoor unit)

PEH-P400MYA

Measurement condition

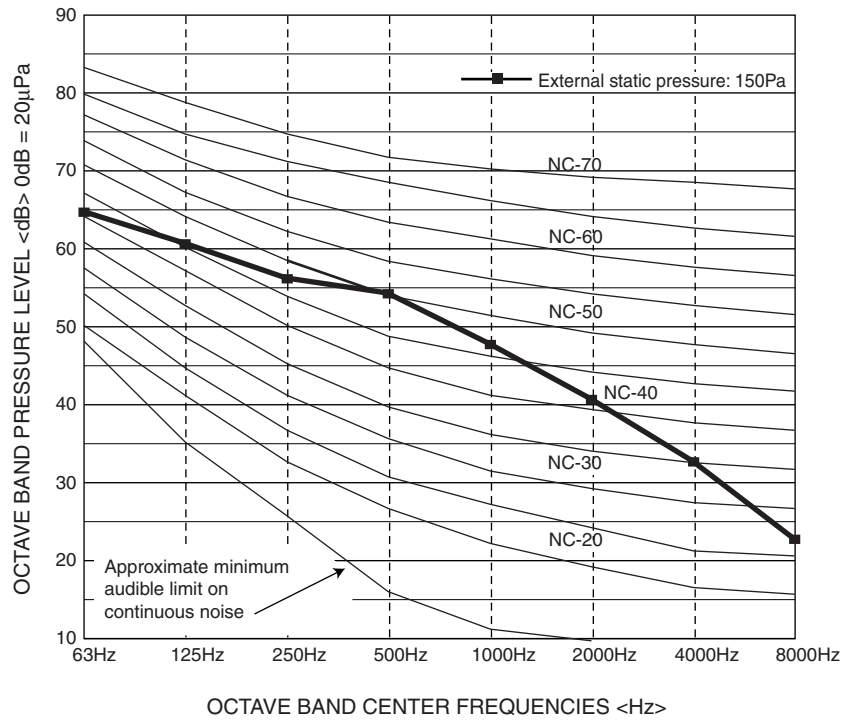
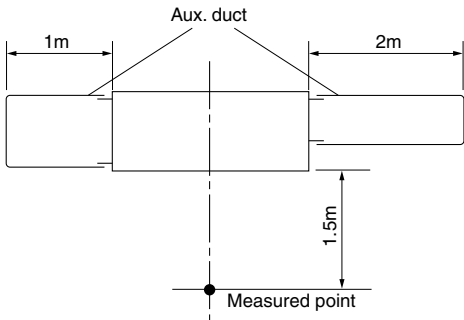

PEH-P500MYA

Measurement condition

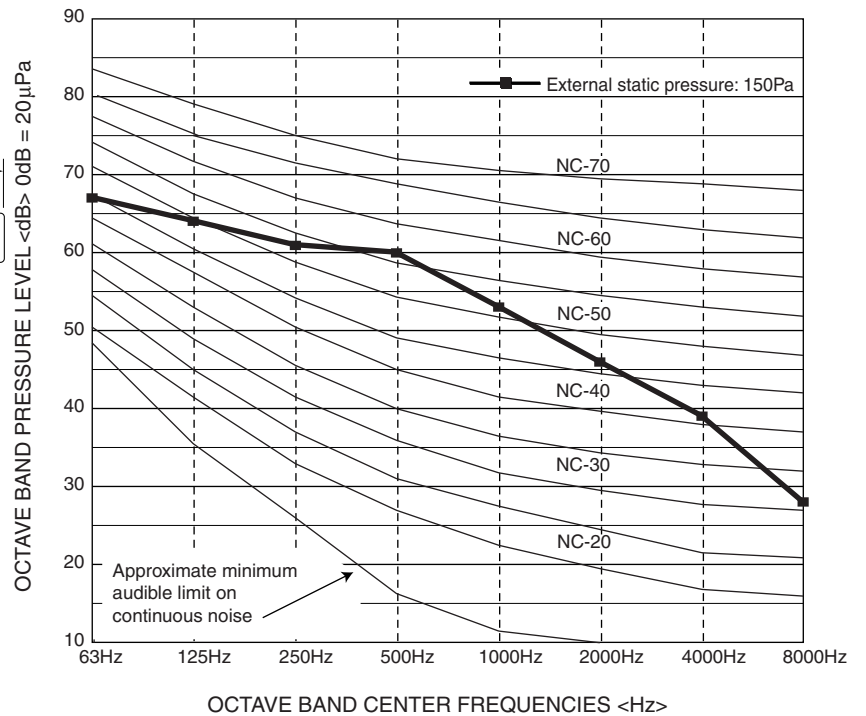
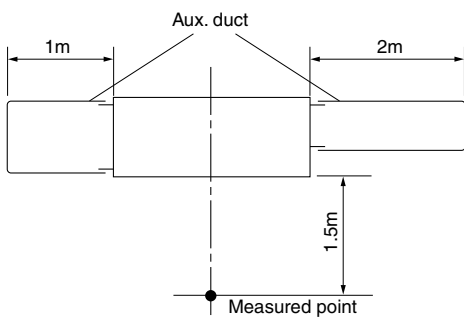

7 SERVICE DATA

[1] Appearance of Equipment

• PEH-P400MYA/P500MYA Electrical Parts Box (with cover removed)

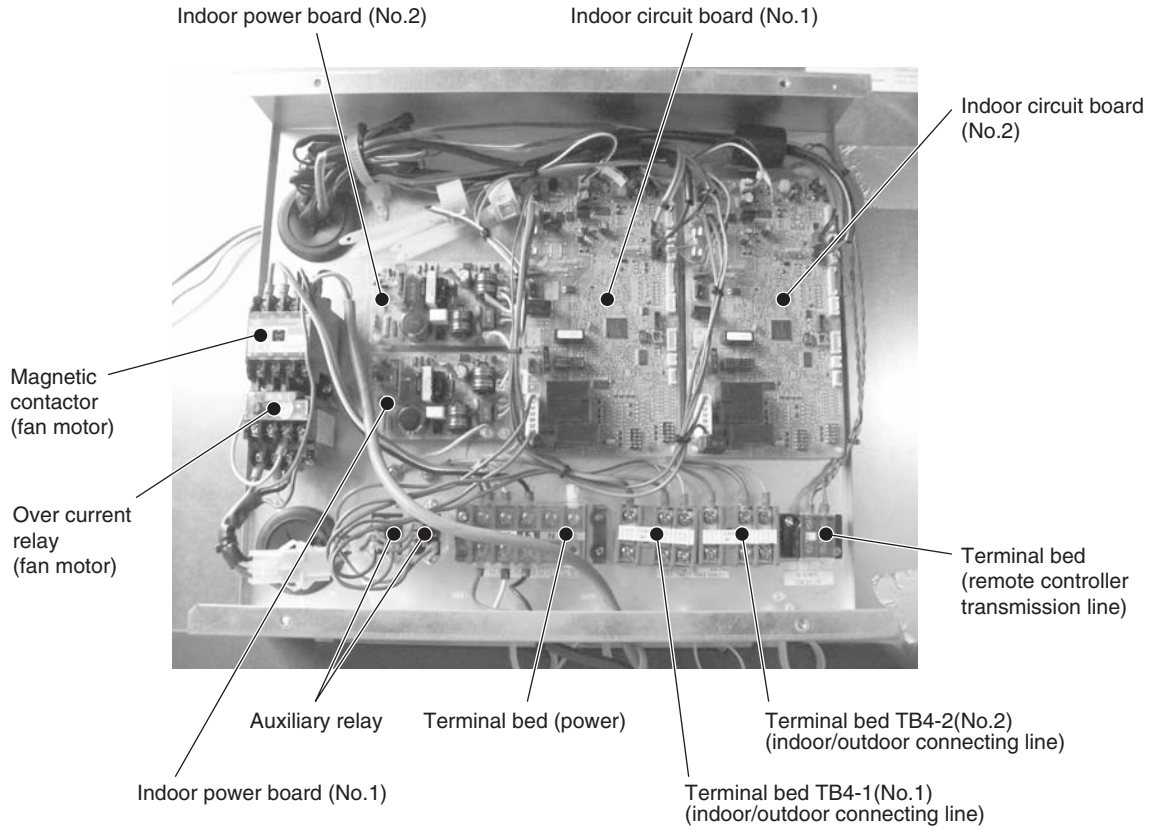

[2] Internal Construction

• PEH-P400MYA/P500MYA (Indoor unit)

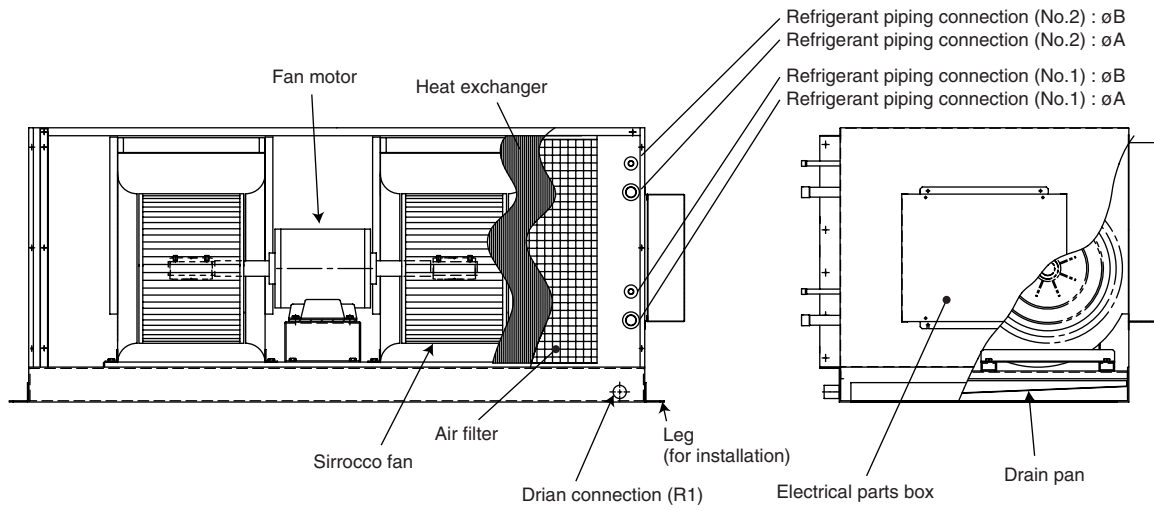

Model name	A	B
PEH-P400MYA	25.4	12.7
PEH-P500MYA	28.58	12.7

[3] Refrigerant Circuit

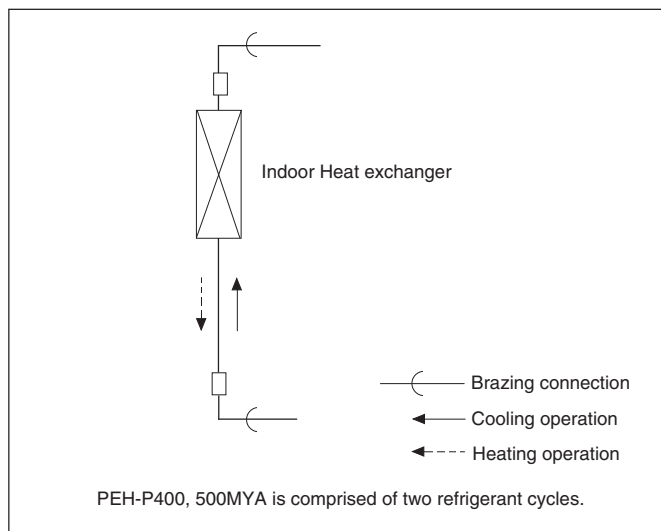

8 FUNCTION OF SWITCH ON INDOOR CIRCUIT BOARD

[1] DIP SW1 for model Selection (DIP SW1 has been set at factory)

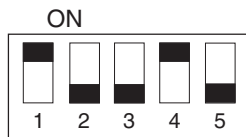

OFF

PEH-P400MYA/P500MYA : SW1-1, -4 ON, SW1-2, -3, -5 OFF

[2] DIP SW2 for Capacity Setting (DIP SW2 has been set at factory)

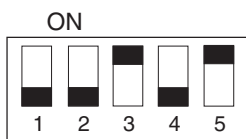

OFF

PEH-P400MYA : SW2-3, -5 ON, SW2-1, -2, -4 OFF

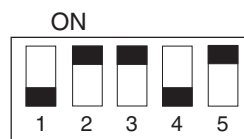

OFF

PEH-P500MYA : SW2-2, -3, -5 ON, SW2-1, -4 OFF

[3] DIP SWE for Emergency Operation

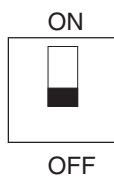

When SWE is turned ON, FAN turns ON. Setting of emergency operation other than SWE is performed at the outdoor unit. For a description of the specific emergency operation execution method, refer to the outdoor unit (PUH-P200MYA, PUH-P250MYA) Technical & Service Manual.

9 Test run

[1] Before test run

The test run can be carried out either from the outdoor unit or the indoor unit.

1. Check list

- After the installation, piping setup, and wiring of the indoor and outdoor units is complete, check that refrigerant is not leaking, the power and control wires are not loose, and the poles are not reversed.
 - Use a 500 V insulation resistance tester to make sure that the resistance between the power terminal and the ground is 1.0 M or more. If it is less than 1.0 M, do not operate the unit. *Absolutely do not touch the tester to indoor/outdoor connection terminals S1, S2, and S3. An accident could occur.
 - Make sure there is no malfunction in the outdoor unit. (If there is a malfunction, you can diagnose it using LED1 on the board.)
 - Check that the ball valve is fully open on both the liquid and gas ends.
 - Check the electrical power phase. If the phase is reversed, the fan may rotate in the wrong direction or stop, or unusual sounds may be produced.
 - Starting at least 12 hours before the test run, send current through the crankcase heater. (If the current is running for a shorter period of time, damage to the compressor could result.)
 - For specific models requiring changing of settings for higher ceilings or selection of power supply ON/OFF capability, make proper changes referring to the description for Selection of Functions through Remote Controller.
- After the above checks are complete, carry out the test run as indicated in the following outline.

[2] Test run procedures

1. Indoor unit

Operating procedures

① Turn on the main power supply

While the display on the remote controller indicates “”, the remote controller is disabled. Turn off the “” indicator before using the remote controller.

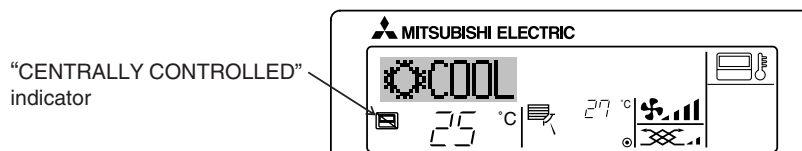

② Press the [TEST] button twice successively within three seconds. Test run starts.

“TEST RUN” and “OPERATION MODE” are displayed alternately.

③ Press [] button

Cooling/drying mode: Cool air should start to blow.

Heating mode: Warm air should start to blow (after a while).

④ Check the outdoor unit fan for correct running

The outdoor unit features automatic capacity control to provide optimum fan speeds. The fan keeps running at a low speed to meet the current outside air condition unless it exceeds its available maximum power. Then, in actuality, the fan may stop or run in the reverse direction depending on the outside air, which does not mean malfunction.

⑤ Press the [] button to reset the test run in progress

- The test run will be automatically shut down after two hours in response to the AUTO STOP setting of two hours on the timer.
- During the test run, the room temperature display shows the indoor unit tubing temperatures.
- In the case of the test run, the OFF timer will activate, and the test run will automatically stop after two hours.
- The room temperature display section shows the control temperature for the indoor units during the test run.
- Check that all the indoor units are running properly for simultaneous twin and triple operation. Malfunctions may not be displayed even if the wiring is incorrect.

⑥ Register a telephone number

The telephone number of the repair shop, sales office, etc., to contact if an error occurs can be registered in the remote controller. The telephone number will be displayed when an error occurs. For registration procedures, refer Function selection of remote controller.

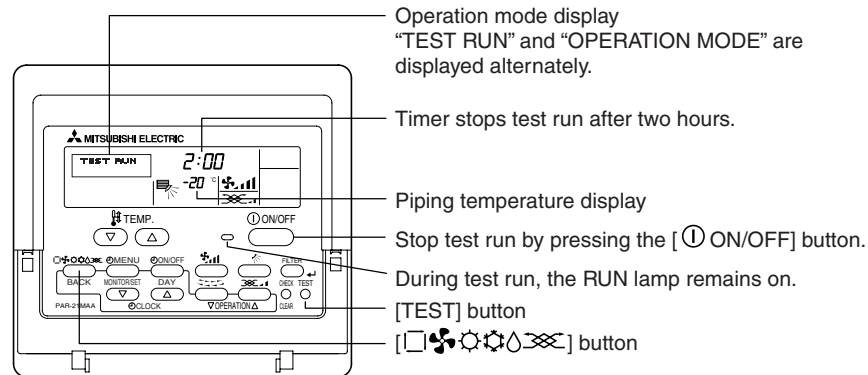

(*1)

After turning ON the power, the system will go into startup mode, and the remote controller operation lamp (green) and the display section's "PLEASE WAIT" will flash. Also, in the case of the indoor substrate LEDs, LED 1 and LED 2 light up (when address is 0) or become dim (when address is not 0), and LED 3 flashes. In the case of the outdoor substrate LED display, [] and [] are displayed alternatively at 1-second intervals.

- If one of the above operations does not function correctly, the following causes should be considered, and if applicable, dealt with. (The following symptoms have been determined under test run mode. Note that "startup" in the chart means the *1 display above.)

Symptoms		Cause
Remote Controller Display	Outdoor Substrate LED Display	
Remote controller is displaying "PLEASE WAIT", and operation is not possible.	After "startup" display, "00" is displayed (correct operation).	• After power is turned ON, system startup lasts for about 2 mins., and "PLEASE WAIT" is displayed (correct operation).
After power is turned ON, "PLEASE WAIT" is displayed for 3 mins., then error code is displayed.	After "startup" display, error code is displayed.	• Outdoor unit's safeguard installation connector is open.
	After "startup" display, "F1" (negative phase) is displayed.	• Negative phase and open phase of outdoor unit's power terminal board (Single phase: L, N, ⊕/triple phase: L1, L2, L3, N, ⊕)
	After "startup" display, "00" or "EE" is displayed ("EE" is displayed when a test run is made).	• Incorrect connection of outdoor terminal board (Single phase: L, N, ⊕/triple phase: L1, L2, L3, N, ⊕ grounding and S1, S2, S3)
Power is turned ON, and "EE" or "EF" are displayed after "PLEASE WAIT" is displayed.		• Outdoor unit and indoor unit construction differ
Display messages do not appear even when remote controller operation switch is turned ON (operation lamp does not light up).	After "startup" display, "EA" (error for number of units) or "Eb" (unit number error) is displayed.	• Wiring for the indoor and outdoor unit is not connected correctly. (Polarity is wrong for S1, S2, S3)
	After "startup" display, "00" is displayed (correct operation).	• Remote controller transmission wire short
	After "startup" display, "00" is displayed (correct operation).	• There is no outdoor unit for address 0 (address is something other than 0).
	After "startup" display, "00" is displayed (correct operation).	• Remote controller transmission wire burnout
Operation display appears but soon disappears even when remote controller operations are executed.	After "startup" display, "00" is displayed (correct operation).	• After cancellation of function selection, operation is not possible for about 30 secs. (correct operation).

* Press the remote controller's "CHECK" button twice consecutively to be able to run a self diagnosis. See the chart below for content of error code displays.

LCD	Nonconformity content	LCD	Nonconformity content	LCD	Nonconformity content
P1	Suction sensor error	P8	Tube temperature error	E6 ~ EF	Signal error between indoor and outdoor units
P2	Tubing (liquid) sensor error	P9	Tube (2-phase tube) sensor error		
P4	Drain sensor error	U0 ~ UP	Outdoor unit nonconformity	----	No error history
P5	Drain overflow safeguard operation	F1 ~ FA	Outdoor unit nonconformity	FFFF	No relevant unit
P6	Freezing/overheating safeguard operation	E0 ~ E5	Signal error between remote controller and indoor unit		

See the chart below for details of the LED displays (LED 1, 2, 3) on the indoor substrate.

LED 1 (microcomputer power supply)	Displays the ON/OFF of power for control. Check that this is lit during normal use.
LED 2 (remote controller feed)	Displays the ON/OFF of feed to wired remote controller. Is only lit for indoor unit linked to outdoor unit with address "00".
LED 3 (indoor and outdoor signals)	Displays signal between indoor and outdoor units. Check that this is flashing during normal use.

2. Outdoor unit

(1) Check Items

- After installation of indoor and outdoor units, and piping and electric wiring work, check that the unit is free from leaks of refrigerant, loosened connections, and incorrect polarity.
- Check that there is no negative phase and open phase. (The F1 message for negative phase and the F2 message for open phase will flash at LED 1 on the outdoor substrate. If this happens, rewire correctly.)
- Measure the impedance between power terminals (Single phase: L, N, \ominus / triple phase: L1, L2, L3, N, \ominus) and the ground with a 500 V Megger and check that it is 1.0 M or more. Do not operate the equipment if measurement is less than 1.0 M. *Never conduct this operation on the outdoor connection wiring terminals (S1, S2, S3) as this causes damage.
- When there is no error at the outdoor unit. (If there is an error at the outdoor unit, it can be evaluated at LED 1 [digital display] of the outdoor substrate.)
- The stop valves are open both the liquid and gas sides.
After checking the above, execute the test run in accordance with the following.

(2) Test run start and finish

- Operation from the indoor unit
Execute the test run using the installation manual for the indoor unit.
- Operation from the outdoor unit
Execute settings for test run start, finish and operation mode (cooling, heating) using the DIP switch SW 4 on the outdoor substrate.

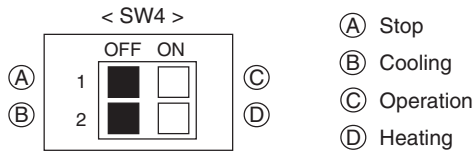

- Set the operation mode (cooling, heating) using SW 4-2
 - Turn ON SW 4-1, The operation mode for SW 4-2 will be adhered to, and the test run will commence
 - Turn OFF SW 4-1 to finish the test run
- There may be a faint knocking noise emitted from the proximity of the fan during the test run. This is torque fluctuation occurring due to control of fan revolutions. There is no problem with the product.

Note:

The SW 4-2 operation mode cannot be changed during the test run. (To change test run mode, stop the equipment with SW 4-1, change the operation mode, then restart test run with SW 4-1.)

- If the 2-hour timer is set, the test run will stop automatically after 2 hours.
- During the test run, the room temperature display on the indoor unit will indicate the temperature of the indoor unit piping.

[3] Self-diagnosis

Retrieve the error history of each unit using the remote controller.

① Switch to the self check mode.

When the [CHECK] button is pressed twice successively within three seconds, the display shown below appears.

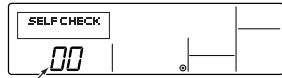

Self check address or self check refrigerant address

② Set the address or refrigerant address No. you want to self check.

When the [TEMP. (▽) and (△)] buttons are pressed, the address decreases and increases between 01 and 50 or 00 and 15. Set it to the address No. or refrigerant address No. you want to self check.

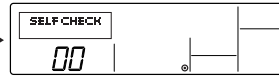

Approximately three seconds after the change operation, the self check refrigerant address changes from flashing to a steady light and self check begins.

③ Self check result display <Error history> (For the contents of the error code, refer to 13. Troubleshooting, error code list.)

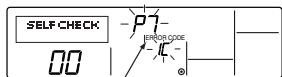

Error code 4 digits or error code 2 digits
<When there is no error history>

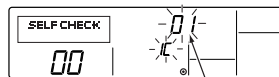

Address 3 digits or unit address No. 2 digits
<When opposite side does not exist>

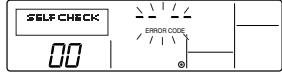

④ Error history reset

The error history is displayed in ③ Self check results display.

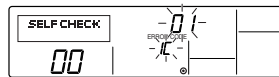
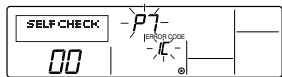

When the [MENU] button is pressed twice successively within three seconds, the self check address or refrigerant address flashes.

When the error history was reset, the display shown below appears. When error history reset failed, the error contents are displayed again.

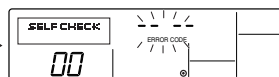

⑤ Self check reset

There are the following two ways of resetting self check.

Press the [CHECK] button twice successively within three seconds → Resets self check and returns to the state before self check.

Press the [ON/OFF] button → Self check resets and indoor units stop.

(When operation is prohibited, this operation is ineffective.)

[4] Remote controller diagnosis

If operation cannot be carried out from the remote controller, use this function to diagnose the remote controller.

① First check the power mark.

When normal voltage (DC12V) is not applied to the remote controller, the powermark goes off.
When the power mark is off, check the remote controller wiring and the indoor unit.

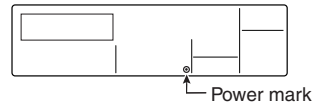

② Switch to the remote controller check mode.

When the [CHECK] button is held down for five seconds or longer, the display shown below appears.

When the [FILTER] button is pressed, remote controller check begins.

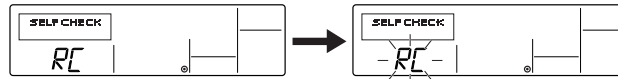

③ Remote controller check result

When remote controller is normal

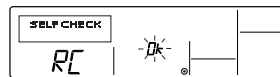

Since there is no problem at the remote controller, check for other causes.

When remote controller is faulty

(Error display 1) "NG" flashes → Remote controller send/receive circuit abnormal

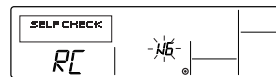

Remote controller switching is necessary.

When the problem is other than the checked remote controller

(Error code 2) "E3" "6833" "6832" flash → Cannot send

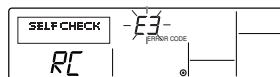

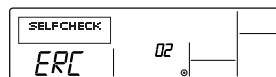

There is noise on the transmission line, or the indoor unit or another remote controller is faulty. Check the transmission line and the other remote controllers.

(Error display 3) "ERC" and data error count are displayed → Data error generation



"Data error count" is the difference between the number of bits of remote controller send data and the number of bits actually sent to the transmission line. In this case, the send data was disturbed by the noise, etc. Check the transmission line.

When data error count is 02

Remote controller send data 
Send data on transmission line 

④ Remote controller check reset

When the [CHECK] button is held down for five seconds or longer, remote controller check resets and the "PLEASE WAIT" and RUN lamp flash. Approximately 30 seconds later, the remote controller returns to the state before remote controller check.

— MEMO —

— MEMO —



Certificate Number FM33568

The Air Conditioning & Refrigeration Systems Works acquired ISO 9001 certification under Series 9000 of the International Standard Organization (ISO) based on a review of quality warranties for the production of refrigeration and air conditioning equipment.

ISO Authorization System

The ISO 9000 series is a plant authorization system relating to quality warranties as stipulated by the ISO. ISO 9001 certifies quality warranties based on the "design, development, production, installation and auxiliary services" for products built at an authorized plant.



Certificate Number EC97J1227
Registered on March 10, 1998

The Air Conditioning & Refrigeration Systems Works acquired environmental management system standard ISO 14001 certification.

The ISO 14000 series is a set of standards applying to environmental protection set by the International Standard Organization (ISO). ISO 14001 certifies the plant's environmental protection system and activities.

MITSUBISHI ELECTRIC CORPORATION

HEAD OFFICE MITSUBISHI DENKI BLDG. MARUNOUCHI TOKYO 100-0005 TELEX J24532 CABLE MELCO TOKYO