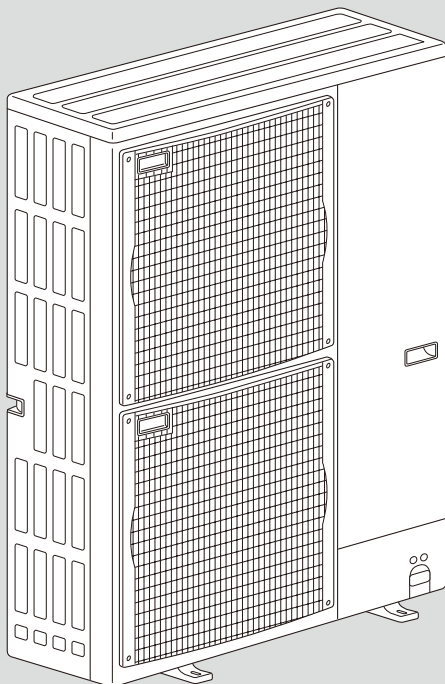

# SERVICE MANUAL

**R410A**
**Outdoor unit**
**[model names]**
**PUHZ-RP200YHA2**
**PUHZ-RP250YHA2**
**[Service Ref.]**
**PUHZ-RP200YHA2**
**PUHZ-RP250YHA2**
**Note:**

- This manual describes only service data of the outdoor units.
- RoHS compliant products have <G> mark on the spec name plate.

**PUHZ-RP200YHA2  
PUHZ-RP250YHA2**
**CONTENTS**

<b>1. REFERENCE MANUAL</b> .....	<b>2</b>
<b>2. SAFETY PRECAUTION</b> .....	<b>3</b>
<b>3. FEATURES</b> .....	<b>7</b>
<b>4. SPECIFICATIONS</b> .....	<b>8</b>
<b>5. DATA</b> .....	<b>9</b>
<b>6. OUTLINES AND DIMENSIONS</b> .....	<b>12</b>
<b>7. WIRING DIAGRAM</b> .....	<b>13</b>
<b>8. WIRING SPECIFICATIONS</b> .....	<b>14</b>
<b>9. REFRIGERANT SYSTEM DIAGRAM</b> .....	<b>19</b>
<b>10. TROUBLESHOOTING</b> .....	<b>21</b>
<b>11. FUNCTION SETTING</b> .....	<b>73</b>
<b>12. MONITORING THE OPERATION DATA BY THE REMOTE CONTROLLER</b> .....	<b>80</b>
<b>13. EASY MAINTENANCE FUNCTION</b> .....	<b>90</b>
<b>14. DISASSEMBLY PROCEDURE</b> .....	<b>93</b>

**PARTS CATALOG (OCB428)**
**Mr. SLIM™**

## INDOOR UNIT'S SERVICE MANUAL

Model name	Service Ref.	Service Manual No.
PLA-RP35/50/60/71/100/125/140BA	PLA-RP35/50/60/71/100/125/140BA <sup>(1)</sup> .UK	OCH412 OCB412
PCA-RP50/60/71/100/125/140GA PCA-RP50GA2	PCA-RP50/60/71/100/125/140GA PCA-RP50GA2	OC328
PCA-RP71/125HA	PCA-RP71/125HA	OC329
PKA-RP35/50GAL	PKA-RP35/50GAL	OC330
PKA-RP60/71/100FAL PKA-RP50FAL2	PKA-RP60/71/100FAL PKA-RP50FAL2	OC331
PEAD-RP50/60/71/125/140EA PEAD-RP35/100EA2	PEAD-RP50/60/71/125/140EA.UK PEAD-RP35/100EA2.UK	HWE05210
PEAD-RP60/71/100GA	PEAD-RP60/71/100GA.UK	HWE05060
PEA-RP200/250/400/500GA	PEA-RP200/250/400/500GA.TH-AF PEA-RP200/250GA.TH-AFMF	HWE0708A

### 2-1. ALWAYS OBSERVE FOR SAFETY

Before obtaining access to terminal, all supply circuits must be disconnected.

### 2-2. CAUTIONS RELATED TO NEW REFRIGERANT

Caution for units utilizing refrigerant R410A

#### Use new refrigerant pipes.

In case of using the existing pipes for R22, be careful with the followings.

- Be sure to perform replacement operation before test run.
- Change flare nut to the one provided with this product.
- Use a newly flared pipe.
- Avoid using thin pipes.

**Make sure that the inside and outside of refrigerant piping is clean and it has no contamination such as sulfur hazardous for use, oxides, dirt, shaving particles, etc. In addition, use pipes with specified thickness.**

Contamination inside refrigerant piping can cause deterioration of refrigerant oil etc.

**Store the piping to be used during installation indoors and keep both ends of the piping sealed until just before brazing. (Leave elbow joints, etc. in their packaging.)**

If dirt, dust or moisture enters into refrigerant cycle, that can cause deterioration of refrigerant oil or malfunction of compressor.

**Use ester oil, ether oil or alkylbenzene oil (small amount) as the refrigerant oil applied to flares and flange connections.**

If large amount of mineral oil enters, that can cause deterioration of refrigerant oil etc.

**Charge refrigerant from liquid phase of gas cylinder.**

If the refrigerant is charged from gas phase, composition change may occur in refrigerant and the efficiency will be lowered.

#### Do not use refrigerant other than R410A.

If other refrigerant (R22 etc.) is used, chlorine in refrigerant can cause deterioration of refrigerant oil etc.

#### Use a vacuum pump with a reverse flow check valve.

Vacuum pump oil may flow back into refrigerant cycle and that can cause deterioration of refrigerant oil etc.

#### Use the following tools specifically designed for use with R410A refrigerant.

The following tools are necessary to use R410A refrigerant.

Tools for R410A	
Gauge manifold	Flare tool
Charge hose	Size adjustment gauge
Gas leak detector	Vacuum pump adaptor
Torque wrench	Electronic refrigerant charging scale

#### Keep the tools with care.

If dirt, dust or moisture enters into refrigerant cycle, that can cause deterioration of refrigerant oil or malfunction of compressor.

#### Do not use a charging cylinder.

If a charging cylinder is used, the composition of refrigerant will change and the efficiency will be lowered.

**Ventilate the room if refrigerant leaks during operation. If refrigerant comes into contact with a flame, poisonous gases will be released.**

### [1] Cautions for service

- (1) Perform service after recovering the refrigerant left in unit completely.
- (2) Do not release refrigerant in the air.
- (3) After completing service, charge the cycle with specified amount of refrigerant.
- (4) When performing service, install a filter drier simultaneously.  
Be sure to use a filter drier for new refrigerant.

### [2] Additional refrigerant charge

#### When charging directly from cylinder

- Check that cylinder for R410A on the market is syphon type.
- Charging should be performed with the cylinder of syphon stood vertically. (Refrigerant is charged from liquid phase.)

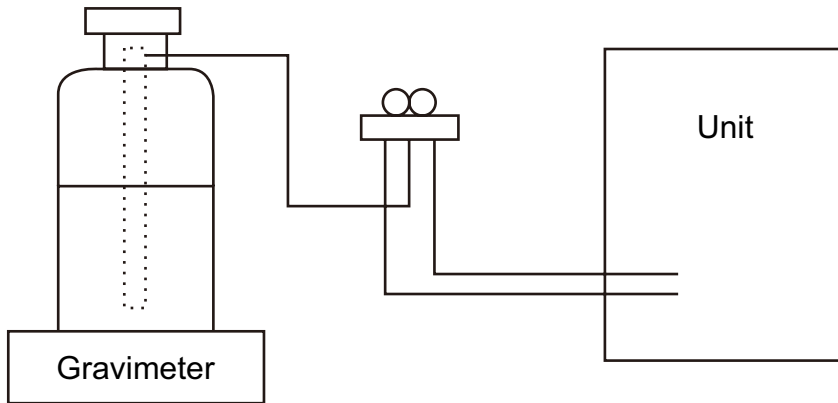

### [3] Service tools

Use the below service tools as exclusive tools for R410A refrigerant.

No.	Tool name	Specifications
①	Gauge manifold	·Only for R410A
		·Use the existing fitting specifications. (UNF1/2)
		·Use high-tension side pressure of 5.3MPa·G or over.
②	Charge hose	·Only for R410A
		·Use pressure performance of 5.09MPa·G or over.
③	Electronic scale	—
④	Gas leak detector	·Use the detector for R134a, R407C or R410A.
⑤	Adaptor for reverse flow check	·Attach on vacuum pump.
⑥	Refrigerant charge base	—
⑦	Refrigerant cylinder	·Only for R410A    ·Top of cylinder (Pink)
		·Cylinder with syphon
⑧	Refrigerant recovery equipment	—

## 2-3. Precautions when reusing existing R22 refrigerant pipes

### (1) Flowchart

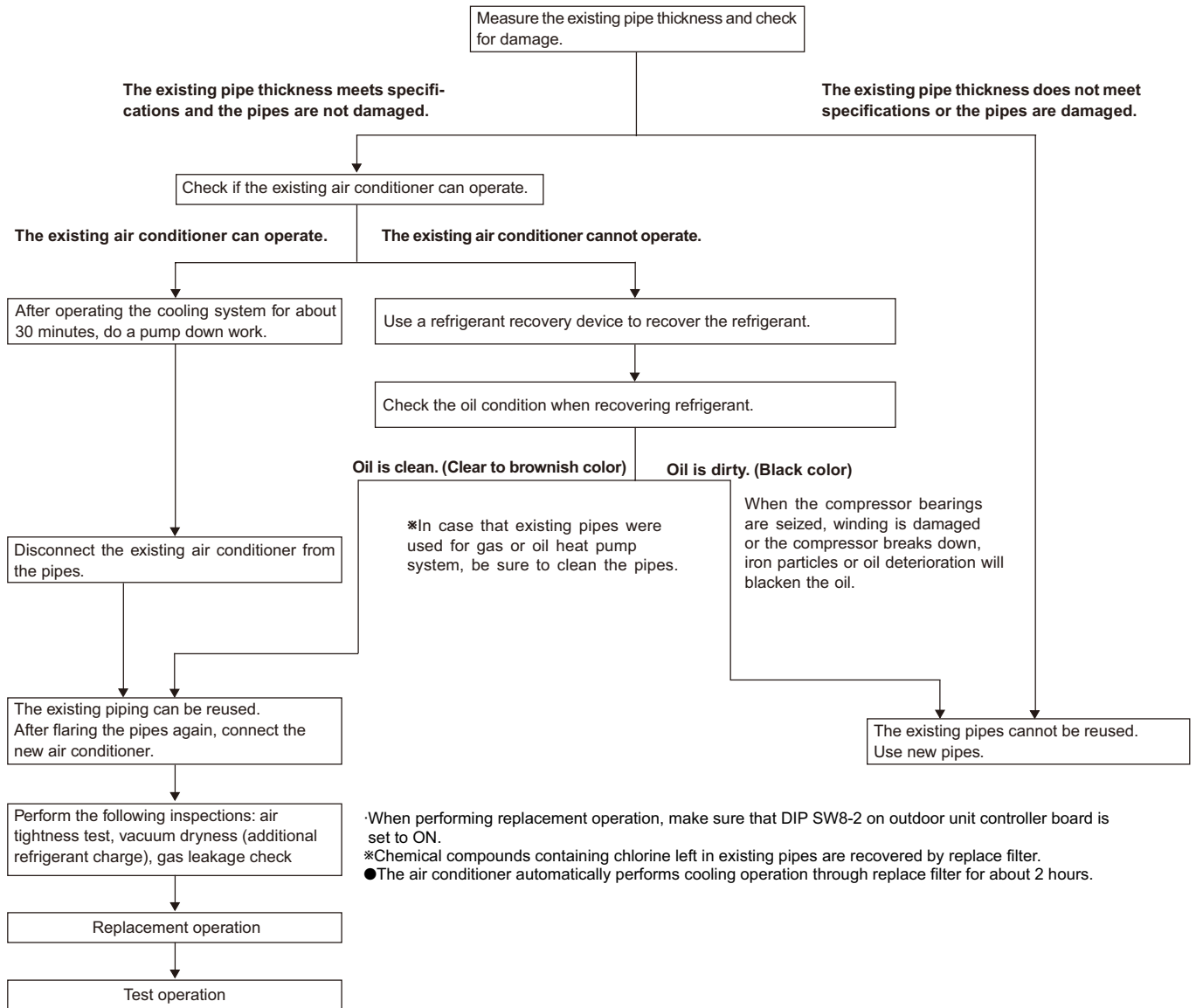

### Connecting a new air conditioner to existing R22 refrigerant pipes

- ① Flare the pipe for the use with R410A refrigerant.  
Use the flare nut attached to indoor and outdoor unit of the new air conditioner only.
- ② When reusing existing R22 refrigerant pipes of which gas pipe is  $\phi 28.58\text{mm}$  and, when the outdoor unit is installed to lower position than the indoor unit, be sure to change the setting of the DIP SW8-1 on the controller circuit board of the outdoor unit to ON.  
 \* This is to increase the speed of refrigerant passing in the gas pipe so that refrigerant oil can smoothly flow in the system.  
 • Use a different-diameter joint or brazing for the connection.
- ③ When reusing standard-size existing R22 refrigerant pipes.  
The pipes can be reused with pipe length restriction described on TECHNICAL DATA BOOK.

## (2) Cautions for refrigerant piping work

New refrigerant R410A is adopted for replacement inverter series. Although the refrigerant piping work for R410A is same as for R22, exclusive tools are necessary so as not to mix with different kind of refrigerant. Furthermore as the working pressure of R410A is 1.6 time higher than that of R22, their sizes of flared sections and flare nuts are different.

### ① Thickness of pipes

Because the working pressure of R410A is higher compared to R22, be sure to use refrigerant piping with thickness shown below. (Never use pipes of 0.7mm or below.)

Diagram below: Piping diameter and thickness

Nominal dimensions (inch)	Outside diameter (mm)	Thickness (mm)	
		R410A	R22
1/4	6.35	0.8	0.8
3/8	9.52	0.8	0.8
1/2	12.70	0.8	0.8
5/8	15.88	1.0	1.0
3/4	19.05	—	1.0
7/8	22.20	—	1.0
1	25.40	—	1.0
1-1/8	28.58	—	1.0

### ② Dimensions of flare cutting and flare nut

The component molecules in HFC refrigerant are smaller compared to conventional refrigerants. In addition to that, R410A is a refrigerant, which has higher risk of leakage because of its working pressure higher than that of other refrigerants. Therefore, to enhance airtightness and intensity, flare cutting dimension of copper pipe for R410A have been specified separately from the dimensions for other refrigerants as shown below. The dimension B of flare nut for R410A also have partly been changed to increase intensity as shown below. Set copper pipe correctly referring to copper pipe flaring dimensions for R410A below. For 1/2 and 5/8 inch, the dimension B changes. Use torque wrench corresponding to each dimension.

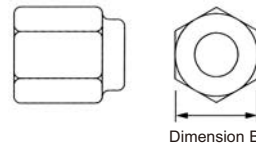
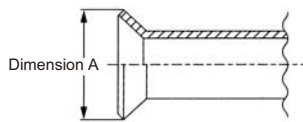

Flare cutting dimensions (mm)

Nominal dimensions (inch)	Outside diameter	Dimension A ( $^{+0}_{-0.4}$ )	
		R410A	R22
1/4	6.35	9.1	9.0
3/8	9.52	13.2	13.0
1/2	12.70	16.6	16.2
5/8	15.88	19.7	19.4
3/4	19.05	24.0	23.3

Flare nut dimensions (mm)

Nominal dimensions (inch)	Outside diameter	Dimension B	
		R410A	R22
1/4	6.35	17.0	17.0
3/8	9.52	22.0	22.0
1/2	12.70	26.0	24.0
5/8	15.88	29.0	27.0
3/4	19.05	36.0	36.0

### ③ Tools for R410A (The following table shows whether conventional tools can be used or not.)

Tools and materials	Use	R410A tools	Can R22 tools be used?	Can R407C tools be used?
Gauge manifold	Air purge, refrigerant charge and operation check	Tool exclusive for R410A	×	×
Charge hose	operation check	Tool exclusive for R410A	×	×
Gas leak detector	Gas leak check	Tool for HFC refrigerant	×	○
Refrigerant recovery equipment	Refrigerant recovery	Tool exclusive for R410A	×	×
Refrigerant cylinder	Refrigerant charge	Tool exclusive for R410A	×	×
Applied oil	Apply to flared section	Ester oil, ether oil and alkylbenzene oil (minimum amount)	×	Ester oil, ether oil: ○ Alkylbenzene oil: minimum amount
Safety charger	Prevent compressor malfunction when charging refrigerant by spraying liquid refrigerant	Tool exclusive for R410A	×	×
Charge valve	Prevent gas from blowing out when detaching charge hose	Tool exclusive for R410A	×	×
Vacuum pump	Vacuum drying and air purge	Tools for other refrigerants can be used if equipped with adpoter for reverse flow check	△ (Usable if equipped with adpoter for reverse flow)	△ (Usable if equipped with adpoter for reverse flow)
Flare tool	Flaring work of piping	Tools for other refrigerants can be used by adjusting flaring dimension	△ (Usable by adjusting flaring dimension)	△ (Usable by adjusting flaring dimension)
Bender	Bend the pipes	Tools for other refrigerants can be used	○	○
Pipe cutter	Cut the pipes	Tools for other refrigerants can be used	○	○
Welder and nitrogen gas cylinder	Weld the pipes	Tools for other refrigerants can be used	○	○
Refrigerant charging scale	Refrigerant charge	Tools for other refrigerants can be used	○	○
Vacuum gauge or thermistor vacuum gauge and vacuum valve	Check the degree of vacuum. (Vacuum valve prevents back flow of oil and refrigerant to thermistor vacuum gauge)	Tools for other refrigerants can be used	○	○
Charging cylinder	Refrigerant charge	Tool exclusive for R410A	×	—

× : Prepare a new tool. (Use the new tool as the tool exclusive for R410A.)

△ : Tools for other refrigerants can be used under certain conditions.

○ : Tools for other refrigerants can be used.

# 3

# FEATURES

## 3-1. COMBINATION OF INDOOR AND OUT DOOR UNITS

### 3-1-1. 1:1 SYSTEM, 1:2 SYSTEM

Indoor unit	Outdoor unit		Indoor unit	Outdoor unit	
	PUHZ-RP-YHA2			PUHZ-RP-YHA2	
	200	250		200 × 2	250 × 2
PEA-RP200, 250GA	○	○	PEA-RP400, 500GA	○	○

### 3-1-2. SYNCHRONIZED TWIN, TRIPLE AND QUADRUPLE SYSTEM

#### (1) Synchronized twin (50:50)

Indoor unit	Outdoor unit	
	PUHZ-RP-YHA2	
	200	250
PLA-RP100BA × 2	○	
PLA-RP125BA × 2		○
PEAD-RP100EA2 × 2	○	
PEAD-RP125EA × 2		○
PEAD-RP100GA × 2	○	
PKA-RP100FAL × 2	○	
PCA-RP100GA × 2	○	
PCA-RP125GA × 2		○
PCA-RP125HA × 2		○

#### (2) Synchronized triple (33:33:33)

Indoor unit	Outdoor unit	
	PUHZ-RP-YHA2	
	200	250
PLA-RP60BA × 3	○	
PLA-RP71BA × 3		○
PEAD-RP60EA × 3	○	
PEAD-RP71EA × 3		○
PEAD-RP60GA × 3	○	
PEAD-RP71GA × 3		○
PKA-RP60FAL × 3	○	
PKA-RP71FAL × 3		○
PCA-RP60GA × 3	○	
PCA-RP71GA × 3		○
PCA-RP71HA × 3		○

#### (3) Synchronized quadruple (25:25:25:25)

Indoor unit	Outdoor unit	
	PUHZ-RP-YHA2	
	200	250
PLA-RP50BA × 4	○	
PLA-RP60BA × 4		○
PEAD-RP50EA × 4	○	
PEAD-RP60EA × 4		○
PEAD-RP60GA × 4		○
PKA-RP50GAL × 4	○	
PKA-RP50FAL2 × 4	○	
PKA-RP60FAL × 4		○
PCA-RP50GA(2) × 4	○	
PCA-RP60GA × 4		○

### 3-1-3. MULTI DISTRIBUTION PIPE (OPTION)

	Ratio of distributing	Part No.
Synchronized twin	50:50	MSDD-50WR-E
Synchronized triple	33:33:33	MSDT-111R-E
Synchronized quadruple	25:25:25:25	MSDF-1111R-E

## 3-2. FEATURES

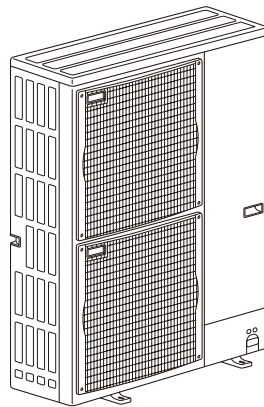

**PUHZ-RP200YHA2**  
**PUHZ-RP250YHA2**

### CHARGELESS SYSTEM

#### PRE-CHARGED REFRIGERANT IS SUPPLIED FOR PIPING LENGTH AT SHIPMENT. (Max.30m)

The refrigerant circuit with LEV(Linear Expansion Valve) and accumulator always control the optimal refrigerant level regardless of the length (30m max. and 5m min.) of piping. The additional refrigerant charging work during installation often causes problems. It is completely eliminated by chargeless system. This unique system improves the quality and reliability of the work done. It also helps to speed up the installation time.

## 4

## SPECIFICATIONS

Service Ref.			PUHZ-RP200YHA2		PUHZ-RP250YHA2		
OUTDOOR UNIT	Mode		Cooling	Heating	Cooling	Heating	
	Power supply (phase, cycle, voltage)		3 phase 50Hz, 400V				
		Running current	A	7.70	8.90	9.50	11.1
		Max. current	A	19		21	
	External finish		Munsell 3Y 7.8/1.1				
	Refrigerant control		Linear Expansion Valve				
	Compressor		Hermetic				
		Model	ANB52FFJMT				
		Motor output	kW	4.7		5.5	
		Starter type	Inverter				
		Protection devices	HP switch Comp. Shell thermo		HP switch, LP switch Discharge thermo		
		Crankcase heater	W	—			
		Heat exchanger	Plate fin coil				
		Fan	Fan(drive) × No.		Propeller fan × 2		
			Fan motor output	kW		0.150 + 0.150	
			Airflow	m <sup>3</sup> /min(L/s)		130(2170)	
		Defrost method	Reverse cycle				
		Noise level	Cooling	dB		58	
			Heating	dB		59	
		Dimensions	W	mm(in.)		950(37-3/8)	
	D		mm(in.)		330 + 30(13+1-3/16)		
	H		mm(in.)		1,350(53-1/8)		
	Weight	kg(lbs)	135(297)		136(299)		
	Refrigerant	R410A					
		Charge	kg(lbs)		6.5(14.3)		
		Oil (Model)	L		2.30(FV50S)		
REFRIGERANT PIPING	Pipe size O.D.	Liquid	mm(in.)		9.52(3/8)		
		Gas	mm(in.)		25.4(1)		
	Connection method	Indoor side	Flared				
		Outdoor side	Flared & Brazing				
	Between the indoor & outdoor unit	Height difference	Max. 30m				
Piping length		Max. 120m					



# 5

# DATA

## 5-1. ADJUSTING THE AMOUNT OF REFRIGERANT

Outdoor unit	Permitted pipe length	Initial charge (kg)	Amount of additional refrigerant charge (kg)					71-120 m and less
			30 m and less	31-40 m and less	41-50 m and less	51-60 m and less	61-70 m and less	
RP200	120m or less	6.5	No additional charge necessary	0.9 kg	1.8 kg	2.7 kg	3.6 kg	The additional charge amount is obtained by the following formula.
RP250		7.1		1.2 kg	2.4 kg	3.6 kg	4.8 kg	

Calculate the additional charge amount based on the following procedure.

If the calculation results in an amount that is smaller than the "Additional charge amount for 70m," perform the additional charge using the amount shown in "Additional charge amount for 70m."

$$\begin{array}{|c|} \hline \text{Amount of additional charge [kg]} \\ \hline \end{array}
 =
 \begin{array}{|c|} \hline \text{Main piping:} \\ \text{Liquid line size} \\ \phi 12.7 \text{ over all length [m]} \\ \times 0.12 \text{ [kg/m]} \\ \hline \end{array}
 +
 \begin{array}{|c|} \hline \text{Main piping:} \\ \text{Liquid line size} \\ \phi 9.52 \text{ over all length [m]} \\ \times 0.09 \text{ [kg/m]} \\ \hline \end{array}
 +
 \begin{array}{|c|} \hline \text{Branch piping: Liquid} \\ \text{line size} \\ \phi 9.52 \text{ over all length [m]} \\ \times 0.06 \text{ [kg/m]} \\ \hline \end{array}
 +
 \begin{array}{|c|} \hline \text{Branch piping: Liquid} \\ \text{line size} \\ \phi 6.35 \text{ over all length [m]} \\ \times 0.02 \text{ [kg/m]} \\ \hline \end{array}
 -
 \begin{array}{|c|} \hline 3.6 \text{ (kg)} \\ \hline \end{array}$$

Additional charge amount for 70 m	RP200	3.6 kg
	RP250	4.8 kg

## 5-2. COMPRESSOR TECHNICAL DATA

(at 20 °C)

Unit		PUHZ-RP200, 250YHA2
Compressor model		ANB52FFJMT
Winding Resistance (Ω)	U-V	0.30
	U-W	0.30
	W-V	0.30

## 5-3. NOISE CRITERION CURVES

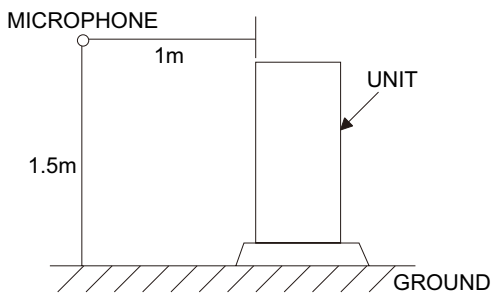

PUHZ-RP200YHA2  
PUHZ-RP250YHA2

MODE	SPL(dB)	LINE
COOLING	58	○—○
HEATING	59	●—●

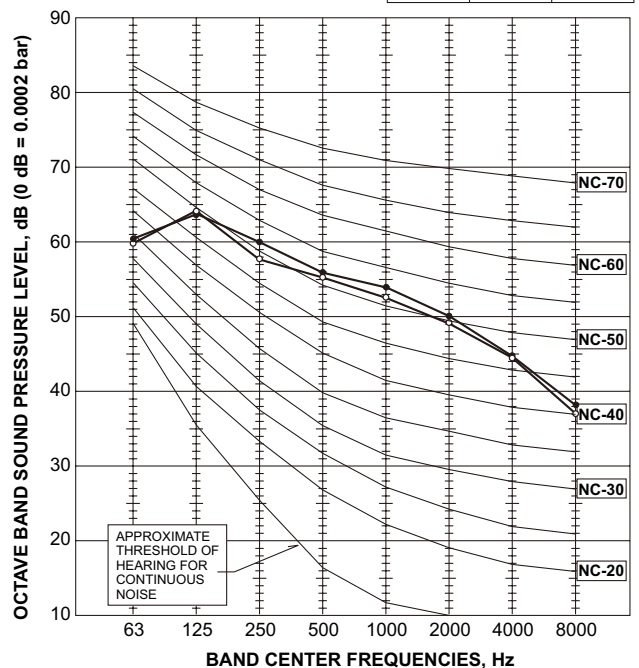

## 5-4. ELECTRICAL PARTS SPECIFICATIONS

Outdoor unit Parts name	PUHZ-RP200YHA2	PUHZ-RP250YHA2
FUSE (FUSE1,2)	250V 15A	
FUSE (F 3,4)	250V 6.3A	
Valve	STF0731Z	
4-way Valve Coil 21S4	STF AC220~240V (BG50T388)	
Linear Expansion Valve	UKV-32D (0~480 Pulse)	HAM-BD35 (0~480 Pulse)
Linear Expansion Valve Coil (LEV-A)(LEV-B)	DC12V	
Bypass Valve	FDF6A-008-RK	
Bypass Valve Coil (SV)	FQ AC220~240V	
Reactor (DCL)	2.7mH 25A	
High pressure switch (63H1)	—	ACB-1UB24 OFF 4.14±0.1MPa / ON 3.14±0.15MPa
High Pressure Switch (63H, 63H2)	OFF 3.60 + 0.2MPa ON 2.80 ± 0.15MPa	
Low Pressure Switch (63L)	—	OFF -0.03 ± 0.03MPa ON 0.05 ± 0.04MPa
Fan Motor (MF1)(MF2)	8P 150W × 2 SIC-81FW-D8187	
Thermistor (Outdoor Pipe) (TH3)	0°C/15kΩ 10°C/9.6kΩ 20°C/6.3kΩ 25°C/5.4kΩ 30°C/4.3kΩ 40°C/3.0kΩ	
Thermistor (Discharge) (TH4)	20°C/250kΩ 30°C/160kΩ 40°C/104kΩ 50°C/70kΩ 60°C/48kΩ 70°C/34kΩ 80°C/24kΩ 90°C/15kΩ 100°C/13kΩ	
Thermistor (Outdoor2-PhasePipe) (TH6)	0°C/15kΩ 10°C/9.6kΩ 20°C/6.3kΩ 25°C/5.4kΩ 30°C/4.3kΩ 40°C/3.0kΩ	
Thermistor (Outdoor) (TH7)	0°C/15kΩ 10°C/9.6kΩ 20°C/6.3kΩ 25°C/5.4kΩ 30°C/4.3kΩ 40°C/3.0kΩ	
Terminal Block (Power Supply) (TB1)	5P (L1, L2, L3, N, ⊕)	
Terminal Block (Indoor / Outdoor) (TB2)	3P (S1, S2, S3)	
Main Smoothing Capacitor (CB1, CB2)	2200μF 400V	
Rush Current Protect Resister (RS)	16Ω 30W	
Compressor (MC)	ANB52FFJMT Scroll type 6P	

## 5-5. STANDARD OPERATION DATA

Representative matching			PLA-RP100BA ×2		PLA-RP125BA ×2		
Mode			Cooling	Heating	Cooling	Heating	
Total	Capacity	W	19,000	22,400	22,000	27,000	
	Input	kW	5.19	6.10	6.83	7.48	
Electrical circuit	<b>Indoor unit</b>		<b>PLA-RP100BA</b>		<b>PLA-RP125BA</b>		
	Phase , Hz		1, 50		1, 50		
	Voltage	V	230		230		
	Input	kW	0.14 ×2	0.13 ×2	0.15 ×2	0.14 ×2	
	Current	A	0.94 ×2	0.87 ×2	1.00 ×2	0.94 ×2	
	<b>Outdoor unit</b>		<b>PUHZ-RP200YHA2</b>		<b>PUHZ-RP250YHA2</b>		
	Phase , Hz		3, 50		3, 50		
	Voltage	V	400		400		
Refrigerant circuit	Discharge pressure	Mpa (kgf/cm <sup>2</sup> )	2.71 (27.6)	2.46 (25.1)	2.86 (29.2)	2.37 (24.2)	
	Suction pressure	Mpa (kgf/cm <sup>2</sup> )	0.95 (9.69)	0.64 (6.53)	0.89 (9.08)	0.60 (6.12)	
	Discharge temperature	°C	66.1	65.6	78.2	72.8	
	Condensing temperature	°C	46.3	42.9	48.4	41.2	
	Suction temperature	°C	11.5	-0.1	16.2	0.9	
	Ref. pipe length	m	7.5	7.5	7.5	7.5	
Indoor side	Intake air temperature	D.B.	°C	27	20	27	20
		W.B.	°C	19	15	19	15
	Discharge air temperature	D.B.	°C	15.3	38.1	14.2	41.1
Outdoor side	Intake air temperature	D.B.	°C	35	7	35	7
		W.B.	°C	24	6	24	6
SHF			0.78	–	0.77	–	
BF			0.13	–	0.10	–	

The unit of pressure has been changed to MPa based on international SI system.  
The conversion factor is : 1(MPa)=10.2(kgf/cm<sup>2</sup>)

PUHZ-RP200YHA2  
PUHZ-RP250YHA2

Unit : mm

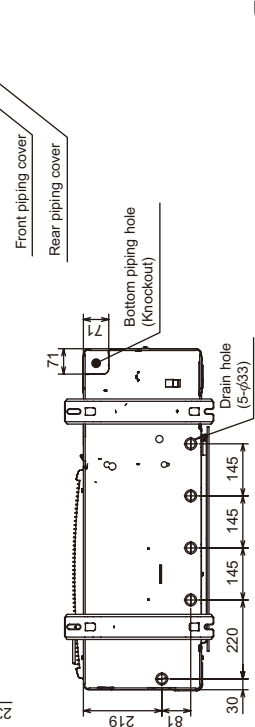
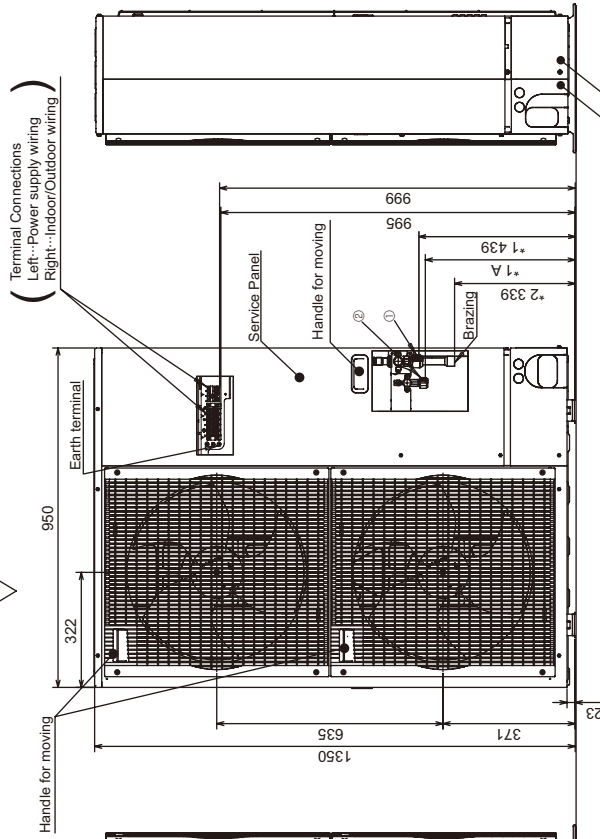
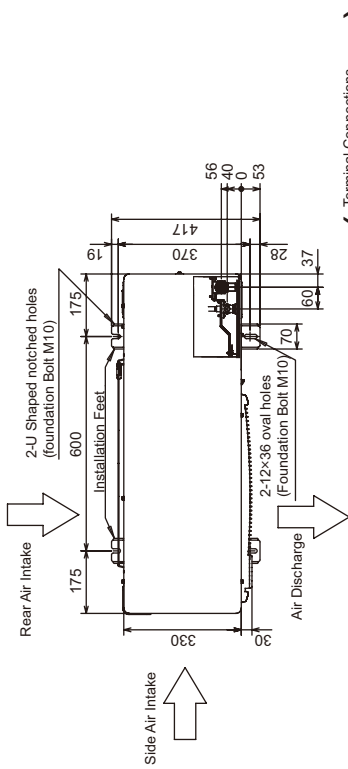

4 PIPING-WIRING DIRECTIONS

Piping and wiring connections can be made from 4 directions: front, right, rear and below.

3 FOUNDATION BOLTS

Please secure the unit firmly with 4 foundation (M10) bolts. (Bolts and washers must be purchased locally).

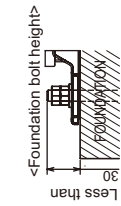

2 SERVICE SPACE

Dimensions of space needed for service access are shown in the below diagram.

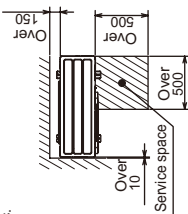

1 FREE SPACE (Around the unit)

The diagram below shows a basic example. Explanation of particular details is given in the installation manuals etc.

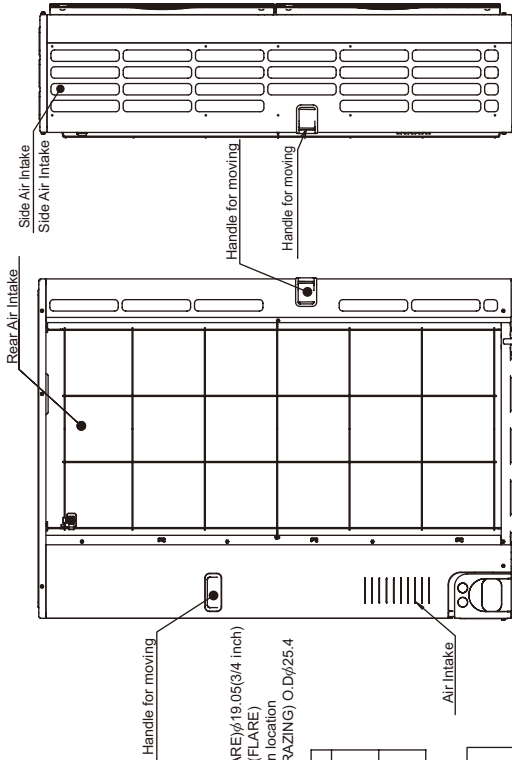
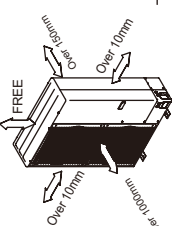

Example of Notes

- ① . . . Refrigerant GAS pipe connection (FLARE)φ19.05(3/4 inch)
- ② . . . Refrigerant LIQUID pipe connection (FLARE)
- \* . . . Indication of STOP VALVE connection location
- 2 . . . Refrigerant GAS PIPE connection(BRAZING) O.D.φ25.4

	②	A
PUHZ-RP200YHA2	φ9.52 (3/8 inch)	447
PUHZ-RP250YHA2	φ12.7 (1/2 inch)	421

Piping Knockout Hole Details

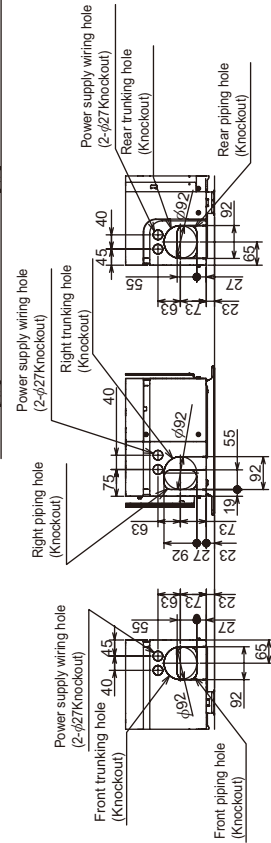

PUHZ-RP200YHA2 PUHZ-RP250YHA2

[LEGEND]

SYMBOL	NAME	SYMBOL	NAME	SYMBOL	NAME
TB1	Terminal Block<Power Supply>	P.B.	Power Circuit Board	SW8	Switch<Function Setup>
TB2	Terminal Block<Indoor/Outdoor>	SC-U/V/W	Connection Terminal<U/V/W-Phase>	SW9	Switch
MC	Motor for Compressor	TB-L1/L2/L3	Connection Terminal<L1/L2/L3-Power supply>	SWP	Switch<Pump Down>
MF1, MF2	Fan Motor	TB-P1	Connection Terminal	CN31	Connector<Emergency Operation>
21S4	Solenoid Valve (Four-Way Valve)	TB-P2	Connection Terminal	LED1 LED2	LED-Operation Inspection Indicators>
SV	Solenoid Valve (Bypass Valve)	TB-C1	Connection Terminal	F3, F4	Fuse< T6.3AL250V>
63H, 63H1, 63H2	High Pressure Switch	TB-N1	Connection Terminal	SS	Connector<Connection for Option>
63L	Low Pressure Switch	X52A	52C Relay	CNM	Connector<A-Control Service Inspection Kit>
TH3	Thermistor<Outdoor Pipe>	N.F.	Noise Filter Circuit Board	CNMNT	Connector <Connected to Optional M-NET Adapter Board>
TH4	Thermistor<Discharge>	LI1/ LI2/LI3/NI	Connection Terminal<L1/L2/L3/NI-Power supply>	CNVMNT	Connector <Connected to Optional M-NET Adapter Board>
TH6	Thermistor<Outdoor 2-Phase Pipe>	LO1/ LO2/L03	Connection Terminal<L1/L2/L3-Power supply>	CNDM	Connector < Connected for Option (Contact Input)>
TH7	Thermistor<Outdoor>	GD1, GD2	Connection Terminal<Ground>	CN3S	Connector<Connection for Option>
LEV-A, LEV-B	Electronic Expansion Valve	C.B.	Controller Circuit Board	CN51	Connector<Connection for Option>
ACL4	Reactor	SW1	Switch<Forced Defrost, Defect History Record Reset, Refrigerant Address>	X51, X52, X55	Relay
DCL	Reactor	SW4	Switch<Test Operation>		
CB1, CB2	Main Smoothing Capacitor	SW5	Switch<Function Switch>		
RS	Rush Current Protect Resistor	SW6	Switch<Model Select>		
FUSE1, FUSE2	Fuse<T15AL250V>	SW7	Switch<Function Setup>		
CY1, CY2	Capacitor				

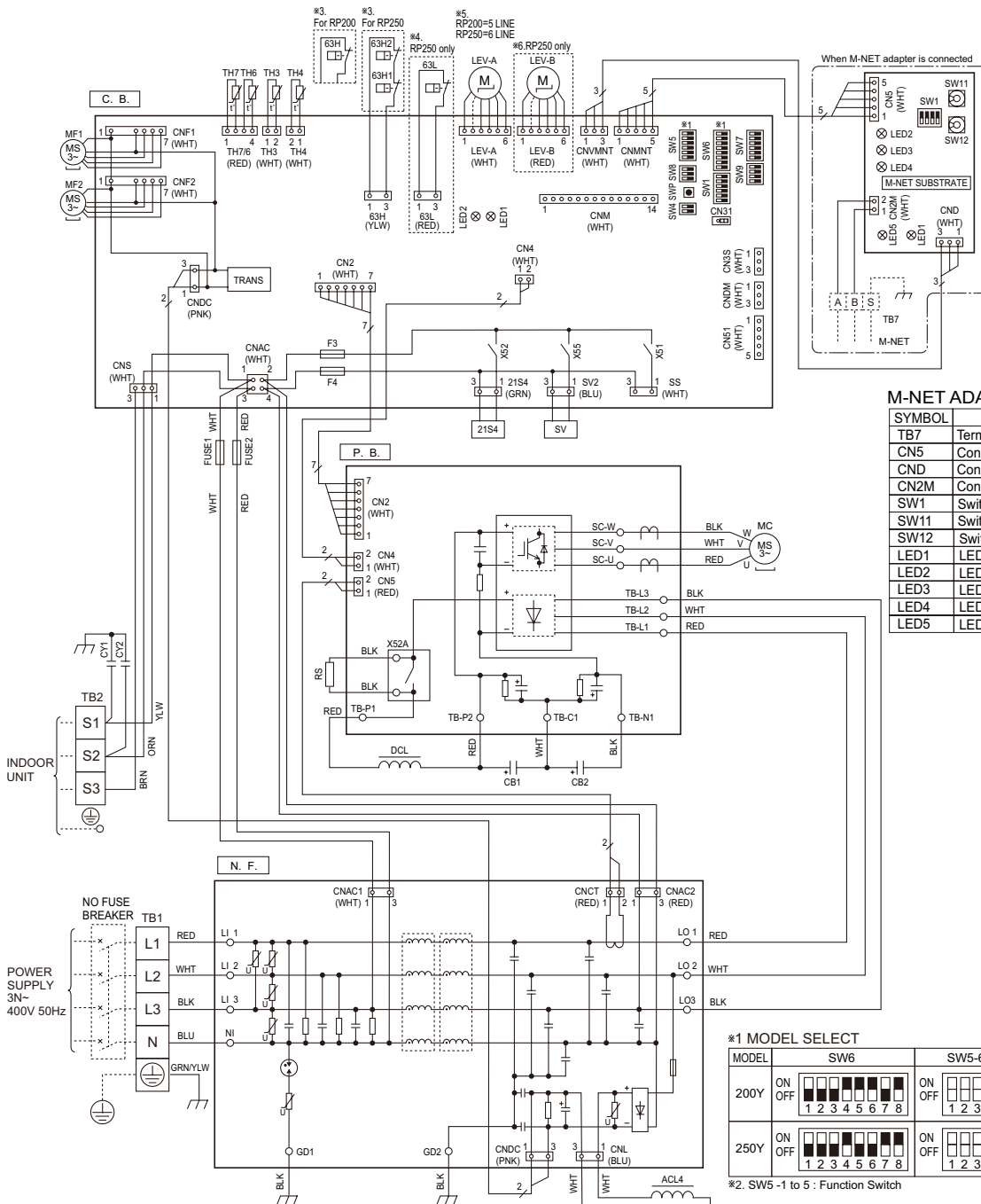

M-NET ADAPTER

SYMBOL	NAME
TB7	Terminal Block(M-NET connection)
CN5	Connector<Transmission>
CND	Connector<Power Supply>
CN2M	Connector<M-NET communication>
SW1	Switch<Status of communication>
SW11	Switch<Address setting:1st digit>
SW12	Switch<Address setting:2nd digit>
LED1	LED<Power Supply:DC5V>
LED2	LED<Connection to Outdoor Unit>
LED3	LED<Transmission:Sending>
LED4	LED<Transmission:Receiving>
LED5	LED<Power Supply:DC12V>

\*1 MODEL SELECT

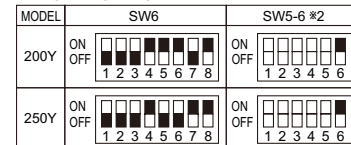

## 8-1. FIELD ELECTRICAL WIRING (power wiring specifications)

### ■ P200, P250

Outdoor unit model		RP200, 250
Outdoor unit Power supply	Phase Frequency & Voltage	3N~(3ph 4-wires), 50 Hz, 380 - 400 - 415 V
Outdoor unit input capacity Main switch (Breaker)	*1	32 A
Wiring Wire No. × size(mm <sup>2</sup> )	Outdoor unit power supply	5 × Min. 4
	Indoor unit-Outdoor unit	*2 Cable length 50 m : 3 × 4 (Polar)/Cable length 80 m : 3 × 6 (Polar)
	Indoor unit-Outdoor unit earth	1 × Min. 2.5
	Remote controller-Indoor unit	*3 2 × 0.69 (Non-polar)
Circuit rating	Outdoor unit L1-N, L2-N, L3-N	*4 AC 220 - 230 - 240 V
	Indoor unit-Outdoor unit S1-S2	*4 AC 220 - 230 - 240 V
	Indoor unit-Outdoor unit S2-S3	*4 DC 24 V
	Remote controller-Indoor unit	*4 DC 14 V

\*1. A breaker with at least 3.0 mm contact separation in each pole shall be provided. Use earth leakage breaker (NV).

\*2. Max. 80 m Total Max. including all indoor/indoor connection is 80 m.

• Use one cable for S1 and S2 and another for S3 as shown in the picture.

• Max. 50m Total Max. for PEA-200, 250, 400, 500

Wiring size 3×1.5(Polar)



\*3. The 10 m wire is attached in the remote controller accessory.

\*4. The figures are NOT against the ground.

S3 terminal has DC 24 V against S2 terminal. However between S3 and S1, these terminals are not electrically insulated by the transformer or other device.

Notes: 1. Wiring size must comply with the applicable local and national code.

2. Power supply cords and Indoor unit/Outdoor unit connecting cords shall not be lighter than polychloroprene sheathed flexible cord. (Design 60245 IEC 57)

3. Use an earth wire which is longer than the other cords so that it will not become disconnected when tension is applied.

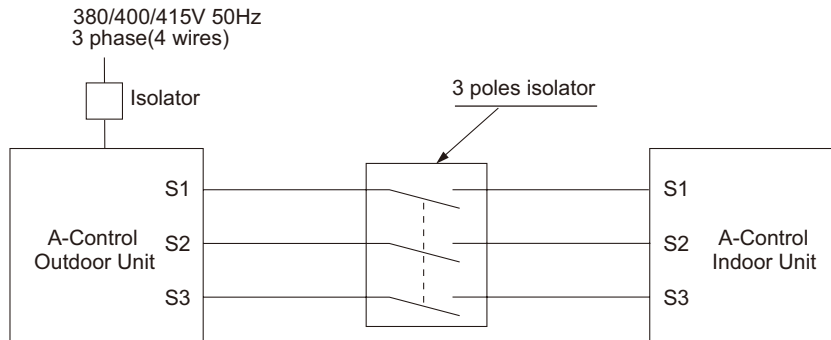

#### ⚠ Warning:

In case of A-control wiring, there is high voltage potential on the S3 terminal caused by electrical circuit design that has no electrical insulation between power line and communication signal line. Therefore, please turn off the main power supply when servicing. And do not touch the S1, S2, S3 terminals when the power is energized. If isolator should be used between indoor unit and outdoor unit, please use 3-pole type.

### Synchronized twin and triple system Electrical wiring

#### • Synchronized twin

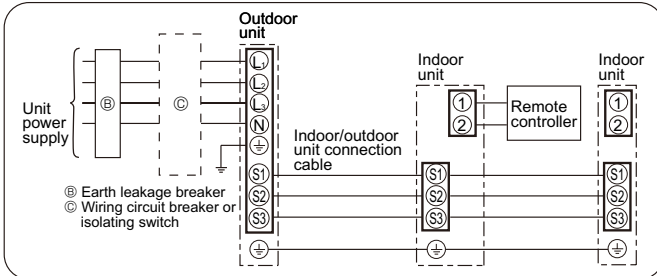

#### • Synchronized triple

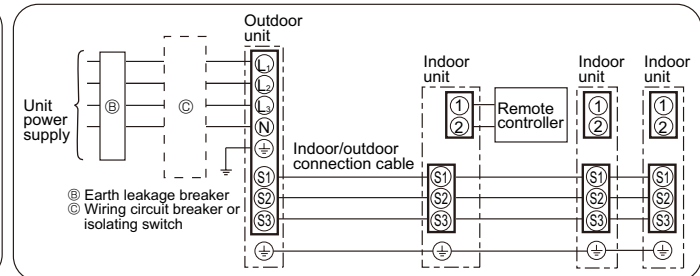

### 1:1 System (Indoor : PEA-200, 250)

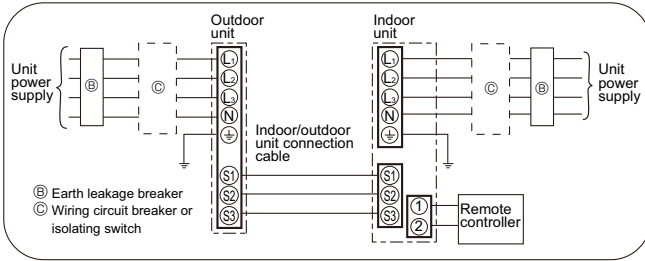

### 1:2 System (Indoor : PEA-400, 500)

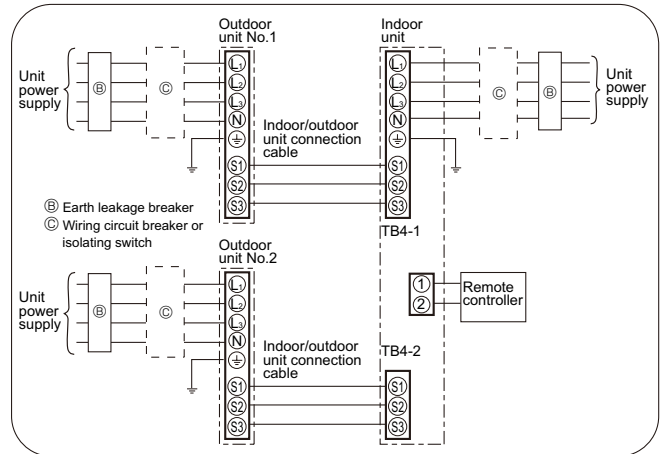

## 8-2. SEPARATE INDOOR UNIT/ OUTDOOR UNIT POWER SUPPLIES

### Simultaneous twin/triple/four system

#### <For models without heater>

\* The optional indoor power supply terminal kit is required.

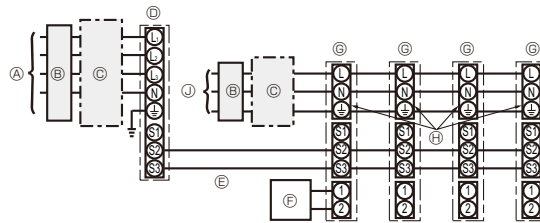

- Ⓐ Outdoor unit power supply
- Ⓑ Earth leakage breaker
- Ⓒ Wiring circuit breaker or isolating switch
- Ⓓ Outdoor unit
- Ⓔ Indoor unit/outdoor unit connecting cables
- Ⓕ Remote controller
- Ⓖ Indoor unit
- Ⓗ Option
- Ⓘ Indoor unit power supply

\* Affix a label B that is included with the manuals near each wiring diagram for the indoor and outdoor units.

If the indoor and outdoor units have separate power supplies, refer to the table below. If the optional indoor power supply terminal kit is used, change the indoor unit electrical box wiring referring to the figure in the right and the DIP switch settings of the outdoor unit control board.

	Indoor unit specifications								
Indoor power supply terminal kit (option)	Required								
Indoor unit electrical box connector connection change	Required								
Label affixed near each wiring diagram for the indoor and outdoor units	Required								
Outdoor unit DIP switch settings (when using separate indoor unit/outdoor unit power supplies only)	<table border="1"> <tr> <td>ON</td> <td></td> <td></td> <td>3</td> </tr> <tr> <td>OFF</td> <td>1</td> <td>2</td> <td></td> </tr> </table> (SW8) Set the SW8-3 to ON.	ON			3	OFF	1	2	
ON			3						
OFF	1	2							

\* There are 3 types of labels (Labels A, B, and C). Affix the appropriate labels to the units according to the wiring method.

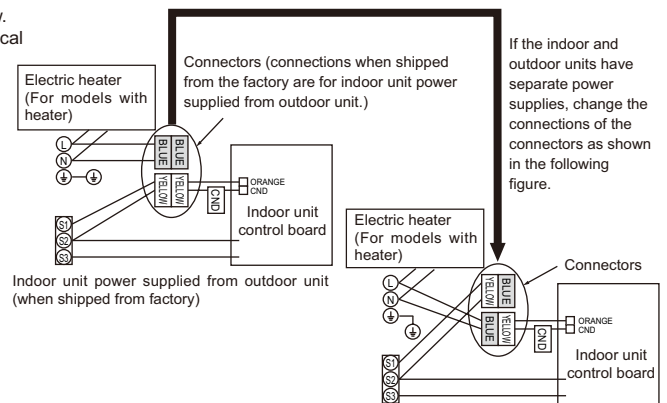

Indoor unit model		RP35~140
Indoor unit power supply		~ /N (single), 50 Hz, 230 V
Indoor unit input capacity		
Main switch (Breaker)		*1 16 A
Wiring	Wire No. × size (mm <sup>2</sup> )	
	Indoor unit power supply	2 × Min. 1.5
	Indoor unit power supply earth	1 × Min. 1.5
	Indoor unit-Outdoor unit	*2 2 × Min. 0.3
Circuit rating	Indoor unit-Outdoor unit earth	-
	Remote controller-Indoor unit	*3 2 × 0.3 (Non-polar)
	Indoor unit L-N	*4 AC 230 V
	Indoor unit-Outdoor unit S1-S2	-
	Indoor unit-Outdoor unit S2-S3	*4 DC24 V
	Remote controller-Indoor unit	*4 DC12 V

\*1. A breaker with at least 3.0 mm contact separation in each pole shall be provided. Use earth leakage breaker (NV). The breaker shall be provided to ensure disconnection of all active phase conductor of the supply.

\*2. Max. 120 m

\*3. The 10 m wire is attached in the remote controller accessory. Max. 500 m

\*4. The figures are NOT always against the ground.

**Notes: 1. Wiring size must comply with the applicable local and national code.**





**2. Power supply cables and indoor unit/outdoor unit connecting cables shall not be lighter than polychloroprene sheathed flexible cable. (Design 60245 IEC 57)**

**3. Install an earth longer than other cables.**



### 8-3. INDOOR – OUTDOOR CONNECTING CABLE

**WIRING SPECIFICATIONS FOR 220-240 V 50 Hz  
(INDOOR-OUTDOOR CONNECTING CABLE)**

Cross section of cable	Wire size (mm <sup>2</sup> )	Number of wires	Polarity	L (m)*6
Round 	2.5	3	Clockwise : S1-S2-S3 * Pay attention to stripe of yellow and green.	(30) *2
Flat 	2.5	3	Not applicable (Because center wire has no cover finish)	Not applicable *5
Flat 	1.5	4	From left to right : S1-Open-S2-S3	(18) *3
Round 	2.5	4	Clockwise : S1-S2-S3-Open *Connect S1 and S3 to the opposite angle.	(30) *4

- \*1 : Power supply cords of appliances shall not be lighter than design 60245 IEC or 227 IEC.
- \*2 : In case that cable with stripe of yellow and green is available.
- \*3 : In case of regular polarity connection (S1-S2-S3), wire size is 1.5 mm<sup>2</sup>.
- \*4 : In case of regular polarity connection (S1-S2-S3).
- \*5 : In the flat cables are connected as this picture, they can be used up to 30 m.

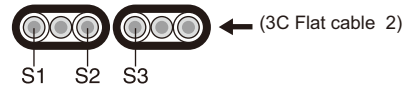

- \*6 : Mentioned cable length is just a reference value.  
It may be different depending on the condition of installation, humidity or materials, etc.

Indoor/Outdoor separate power supply	Wire No. × Size (mm <sup>2</sup> )
	Max. 120m
Indoor unit-Outdoor unit	2 × Min. 0.3
Indoor unit-Outdoor unit earth	—

※ The optional indoor power supply terminal kit is necessary.

Be sure to connect the indoor-outdoor connecting cables directly to the units (no intermediate connections). Intermediate connections can lead to communication errors if water enters the cables and causes insufficient insulation to ground or a poor electrical contact at the intermediate connection point.



## 8-4. M-NET WIRING METHOD

(Points to notice)

- (1) Outside the unit, transmission wires should stay away from electric wires in order to prevent electromagnetic noise from making an influence on the signal communication. Place them at intervals of more than 5cm. Do not put them in the same conduit tube.
- (2) Terminal block (TB7) for transmission wires should never be connected to 220~240V power supply. If it is connected, electronic parts on M-NET P.C. board may burn out.
- (3) Use 2-core x 1.25mm<sup>2</sup> shield wire (CVVS, CPEVS) for the transmission wire. Transmission signals may not be sent or received normally if different types of transmission wires are put together in the same multi-conductor cable. Never do this because this may cause a malfunction.

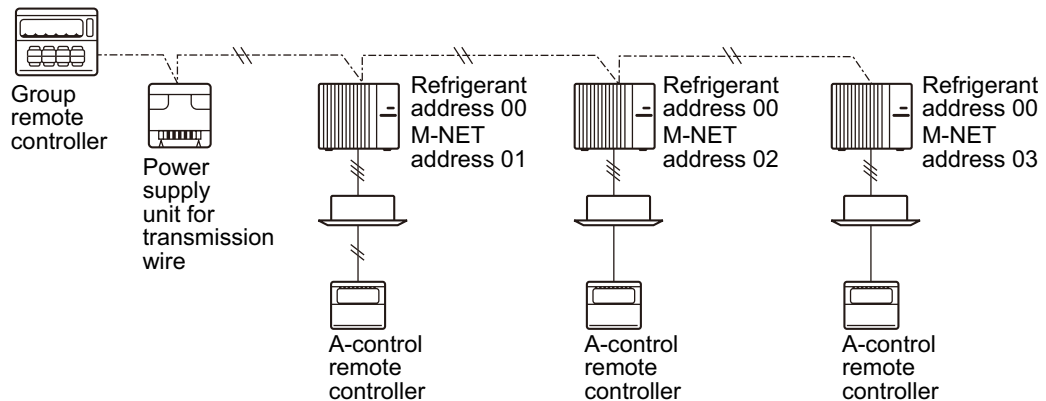

It would be ok if M-NET wire (non-polar, 2-cores) is arranged in addition to the wiring for A-control.

- (4) Ground only one of any appliances through M-NET transmission wire (shield wire). Communication error may occur due to the influence of electromagnetic noise.

“Ed” error will appear on the LED display of outdoor unit.

“0403” error will appear on the central-control remote controller.

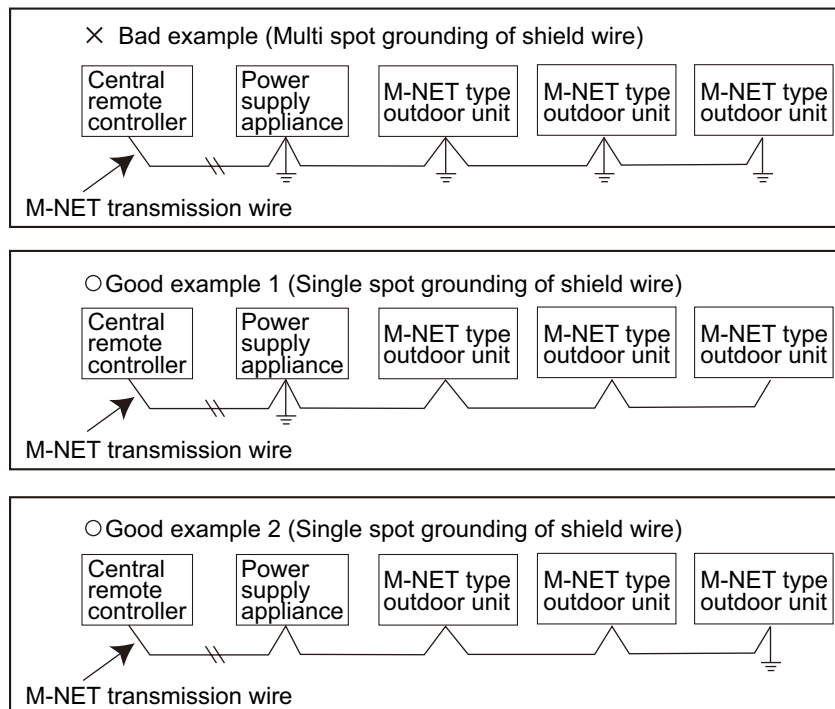

If there are more than 2 grounding spots on the shield wire, noise may enter into the shield wire because the ground wire and shield wire form 1 circuit and the electric potential difference occurs due to the impedance difference among grounding spots. In case of single spot grounding, noise does not enter into the shield wire because the ground wire and shield wire do not form 1 circuit.

To avoid communication errors caused by noise, make sure to observe the single spot grounding method described in the installation manual.

### ● M-NET wiring

- Use 2-core x 1.25mm<sup>2</sup> shield wire for electric wires.  
(Excluding the case connecting to system controller.)
- Connect the wire to the M-NET terminal block. Connect one core of the transmission wire (non-polar) to M1 terminal and the other to M2. Peel the shield wire, twist the shield part to a string and connect it to S terminal.
- In the system which several outdoor units are being connected, the terminal (M1, M2, S) on M-NET terminal block should be individually wired to the other outdoor unit's terminal, i.e. M1 to M1, M2 to M2 and S to S. In this case, choose one of those outdoor units and drive a screw to fix an ground wire on the plate as shown on the right figure.

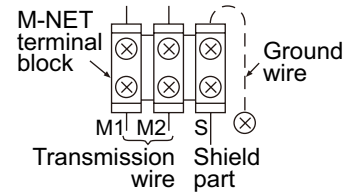

#### 8-4-1. M-NET address setting

In A-control models, M-NET address and refrigerant address should be set only for the outdoor unit. Similar to CITY MULTI system, there is no need to set the address of outdoor unit and remote controller. To construct a central control system, the setting of M-NET address should be conducted only upon the outdoor unit. The setting range should be 1 to 50 (the same as that of the indoor unit in CITY MULTI system), and the address number should be consecutively set in a same group.

Address number can be set by using rotary switches (SW11 for ones digit and SW12 for tens digit), which is located on the M-NET board of outdoor unit. (Initial setting: all addresses are set to "0".)

<Setting example>

M-NET Address No.		1	2	...	50
Switng setting	SW11 ones digit			~	
	SW12 tens digit			~	

#### 8-4-2. Refrigerant address setting

In case of multiple grouping system (multiple refrigerant circuits in one group), indoor units should be connected by remote controller wiring (TB5) and the refrigerant address needs to be set. Leave the refrigerant addresses to "00" if the group setting is not conducted. Set the refrigerant address by using DIP SW1-3 to -6 on the outdoor controller board. [Initial setting: all switches are OFF. (All refrigerant addresses are "00".)]

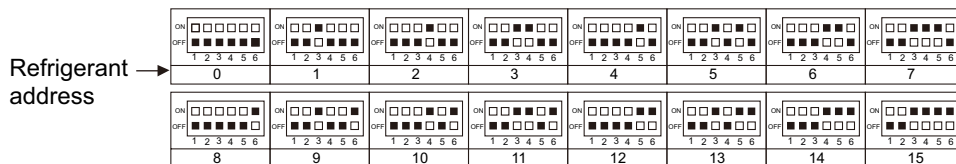

#### 8-4-3. Regulations in address settings

In case of multiple grouping system, M-NET and refrigerant address settings should be done as explained in the above section. Set the lowest number in the group for the outdoor unit whose refrigerant address is "00" as its M-NET address.

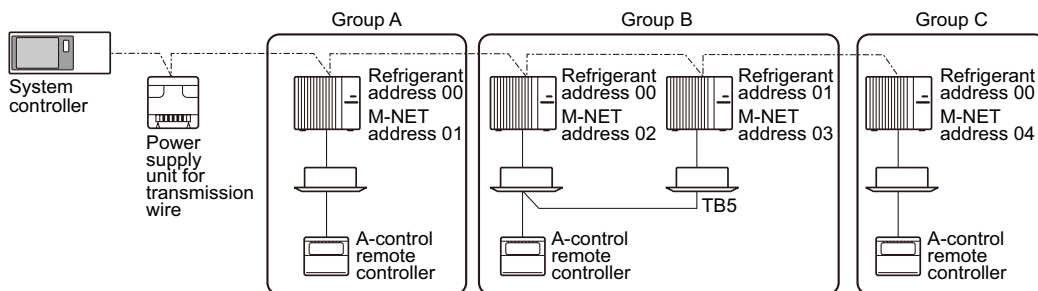

\* Refrigerant addresses can be overlapped if they are in the different group.

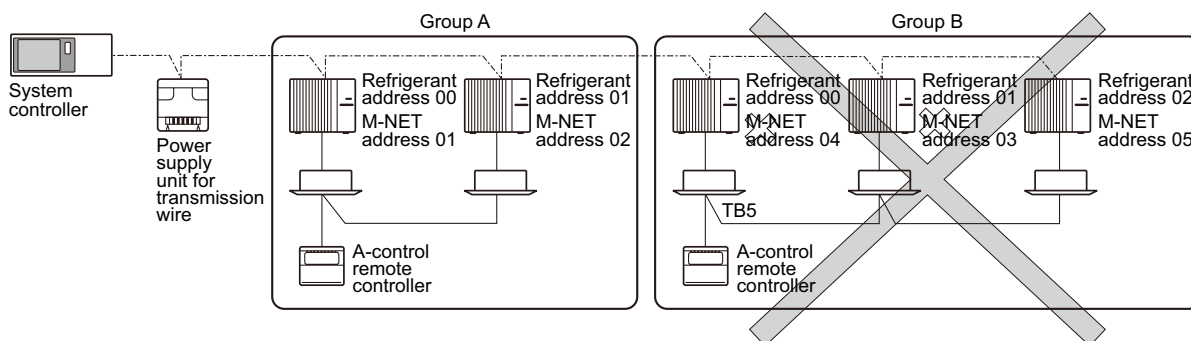

\* In group B, M-NET address of the outdoor unit whose refrigerant address is "00" is not set to the minimum in the group. As "3" is right for this situation, the setting is wrong. Taking group A as a good sample, set the minimum M-NET address in the group for the outdoor unit whose refrigerant address is "00".

Unit : mm

PUHZ-RP200YHA2

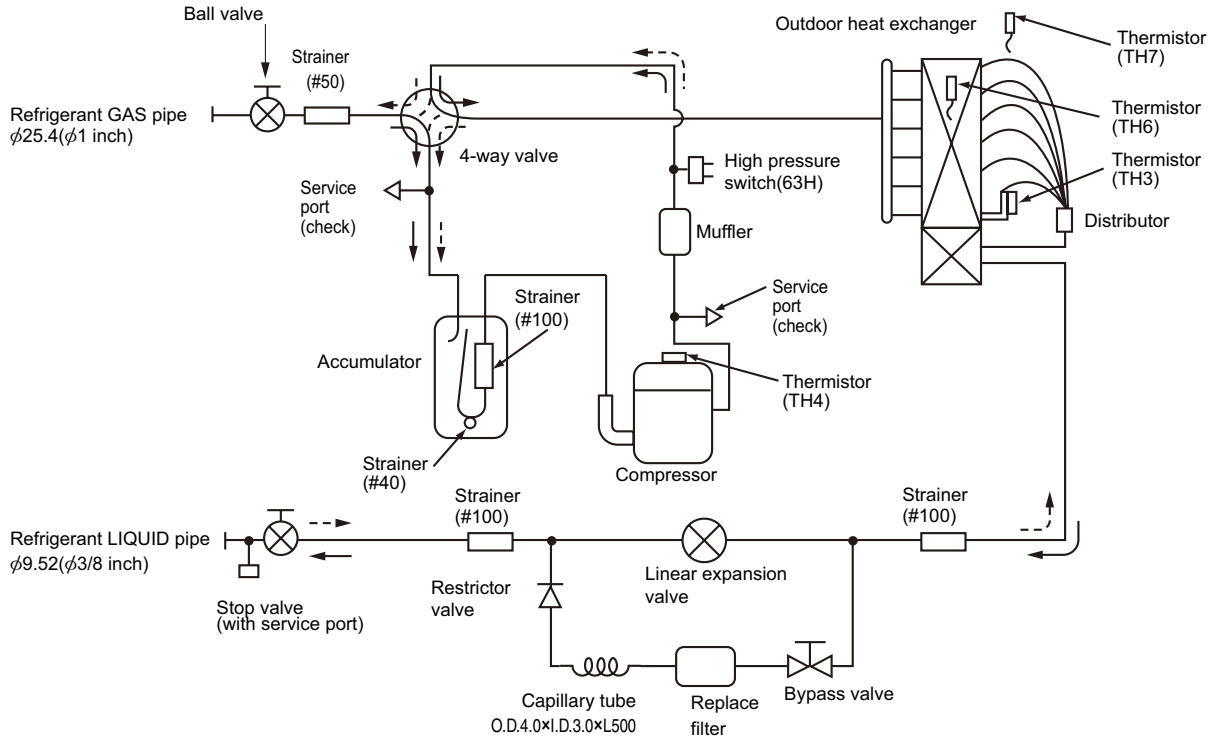
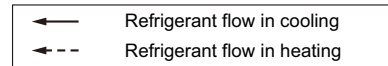

PUHZ-RP250YHA2

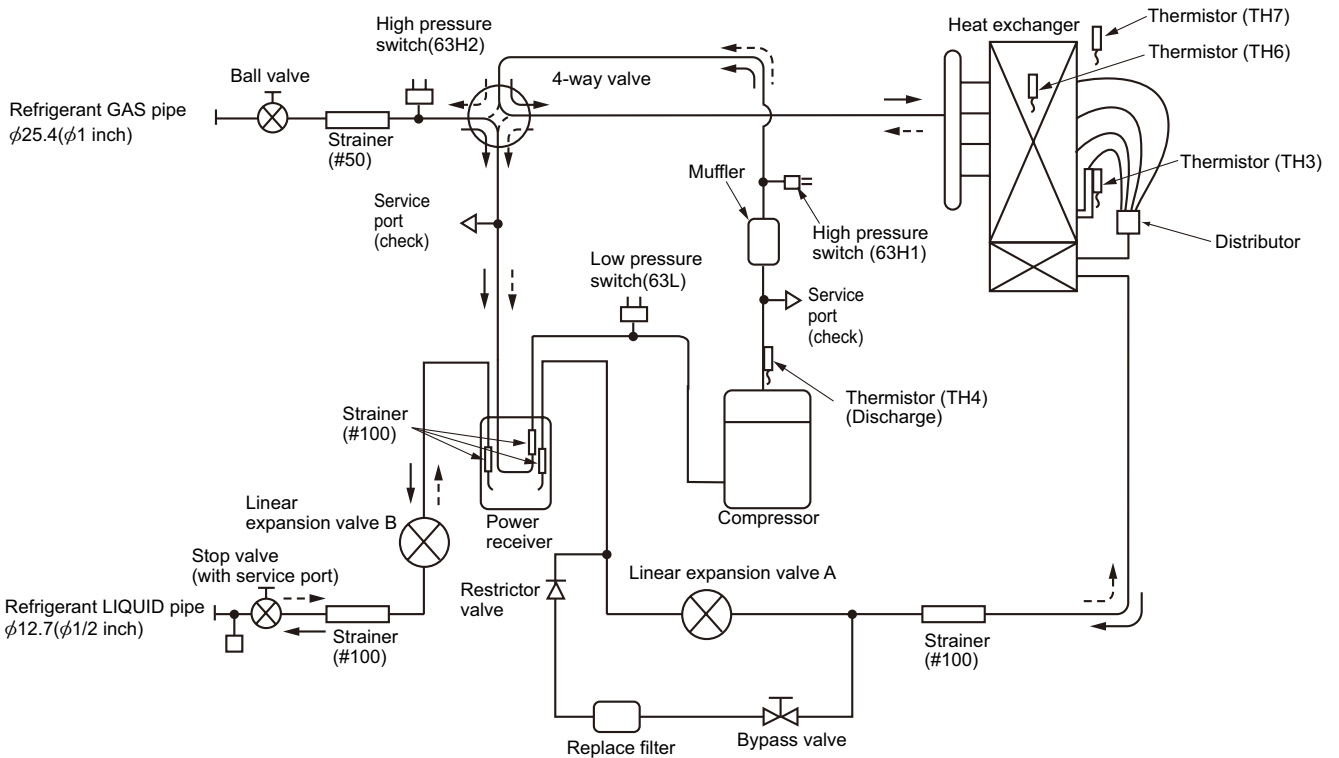

### 9-1. Refrigerant recovering (pump down)

Perform the following procedures to recover the refrigerant when moving the indoor unit or the outdoor unit.

- ① Turn on the power supply (circuit breaker).
  - \*When power is supplied, make sure that "CENTRALLY CONTROLLED" is not displayed on the remote controller. If "CENTRALLY CONTROLLED" is displayed, the refrigerant recovering (pump down) cannot be completed normally.
- ② After the liquid stop valve is closed, set the SWP switch on the control board of the outdoor unit to ON. The compressor (outdoor unit) and fans (indoor and outdoor units) start operating and refrigerant recovering operation begins. LED1 and LED2 on the control board of the outdoor unit are lit.
  - \*Set the SWP switch (push-button type) to ON in order to perform refrigerant recovering operation only when the unit is stopped. However, refrigerant recovering operation cannot be performed until compressor stops even if the unit is stopped. Wait 3 minutes until compressor stops and set the SWP switch to ON again.
- ③ Because the unit automatically stops in about 2 to 3 minutes after the refrigerant recovering operation (LED1 is not lit and LED2 is lit), be sure to quickly close the gas stop valve.
  - \*In case the outdoor unit is stopped when LED1 is lit and LED2 is not lit, open the liquid stop valve completely, and then repeat step ② 3 minutes later.
  - \*If the refrigerant recovering operation has been completed normally (LED1 is not lit and LED2 is lit), the unit will remain stopped until the power supply is turned off.
- ④ Turn off the power supply (circuit breaker.)

### 9-2. Unit replacement operation

**When reusing the existing pipes that carried R22 refrigerant for the RP200 and RP250 models, replacement operation must be performed before performing a test run.**

- ① If new pipes are used, these procedures are not necessary.
- ② During replacement operation, "C5" is displayed on "A-Control Service Tool(PAC-SK52ST)".

#### Replacement operation procedures

- ① Turn on the power supply.
- ② Set DIP switch SW8-2 on the control board of the outdoor unit to ON to start replacement operation.
  - The replacement operation is performed using the cooling system. Cool air will flow from the indoor unit during the replacement operation.
  - During the replacement operation, TEST RUN is displayed on the remote controller and LED1 (green) and LED2 (red) on the control board of the outdoor unit blink together.
- ③ The duration of the replacement operation is determined by the length of the piping. Always perform the replacement operation for longer than the stipulated time.
  - \* Use one of the following methods to complete replacement operation. When the replacement operation ends, the unit will automatically stop.

- (1) Set SW8-2 from ON to OFF. (When ending a replacement operation of less than 2 hours.)
  - Each time SW8-2 is set from OFF to ON, the replacement operation can be started. Always perform the replacement operation for longer than the stipulated time.

<Required replacement operation times>

Piping Length	"Replacement Operation Time"
0 to 20 meters	30 minutes or more
21 to 30 meters	45 minutes or more
31 to 70 meters	60 minutes or more

- (2) The replacement operation will automatically stop after 2 hours. (It will end with SW8-2 still in the ON position.)
  - When the replacement operation has ended automatically after 2 hours of operation, there is no need to set SW8-2 from ON to OFF; normal air conditioning operations can be started with the SW8-2 being set to ON. However, to repeat the replacement operation, SW8-2 will have to be returned to OFF and then set to ON.
  - \* If the indoor temperature is below 15°C, the compressor will operate intermittently but the unit is not faulty.

### 9-3. Start and finish of test run

- Operation from the indoor unit  
Execute the test run using the installation manual for the indoor unit.
- Operation from the outdoor unit  
By using the DIP switch SW4 on the control board of outdoor unit, test run can be started and finished, and its operation mode (cooling/heating) can be set up.

- ① Set the operation mode (cooling/heating) using SW4-2.
- ② Turn on SW4-1 to start test run with the operation mode set by SW4-2.
- ③ Turn off SW4-1 to finish the test run.

- There may be a faint knocking sound around the machine room after power is supplied, but this is no problem with product because the linear expansion valve is just moving to adjust opening pulse.
- There may be a knocking sound around the machine room for several seconds after compressor starts operating, but this is no problem with product because the check valve, itself, generates the sound since pressure difference is small in the refrigerant circuit.

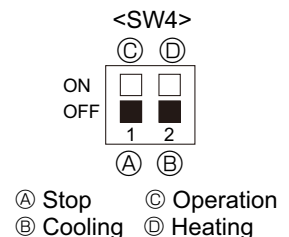

**Note:**  
The operation mode cannot be changed by SW4-2 during test run. (To change test run mode, stop the unit by SW4-1, change the operation mode and restart the test run by SW4-1.)

### 10-1. TROUBLESHOOTING

#### <Error code display by self-diagnosis and actions to be taken for service (summary)>

Present and past error codes are logged and displayed on the wired remote controller and control board of outdoor unit. Actions to be taken for service, which depends on whether or not the trouble is reoccurring at service, are summarized in the table below. Check the contents below before investigating details.

Unit conditions at service	Error code	Actions to be taken for service (summary)
The trouble is reoccurring.	Displayed	Judge what is wrong and take a corrective action according to "10-4. Self-diagnosis action table".
	Not displayed	Conduct troubleshooting and ascertain the cause of the trouble according to "10-5. Troubleshooting by inferior phenomena".
The trouble is not reoccurring.	Logged	①Consider the temporary defects such as the work of protection devices in the refrigerant circuit including compressor, poor connection of wiring, noise and etc. Re-check the symptom, and check the installation environment, refrigerant amount, weather when the trouble occurred, matters related to wiring and etc. ②Reset error code logs and restart the unit after finishing service. ③There is no abnormality in electrical component, controller board, remote controller and etc.
	Not logged	①Re-check the abnormal symptom. ②Conduct trouble shooting and ascertain the cause of the trouble according to "10-5. Troubleshooting by inferior phenomena". ③Continue to operate unit for the time being if the cause is not ascertained. ④There is no abnormality concerning of parts such as electrical component, controller board, remote controller and etc.

### 10-2. CHECK POINT UNDER TEST RUN

#### (1) Before test run

- After installation of indoor and outdoor units, piping work and electric wiring work, re-check that there is no refrigerant leakage, loosened connections and incorrect polarity.
- Measure impedance between the ground and the power supply terminal block(L, N) on the outdoor unit by 500V Megger and check that it is 1.0MΩ or over.
- ※Don't use 500V Megger to indoor/outdoor connecting wire terminal block(S1, S2, S3) and remote controller terminal block (1, 2). This may cause malfunction.
- Make sure that test run switch (SW4) is set to OFF before turning on power supply.
- Turn on power supply 12 hours before test run in order to protect compressor.
- For specific models which requires higher ceiling settings or auto-recovery feature from power failure, make proper changes of settings referring to the description of "11. Function setting".
- Make sure to read operation manual before test run. (Especially items to secure safety.)

"TEST RUN" and the currently selected operation mode are displayed alternately.

Displays the remaining test run time.

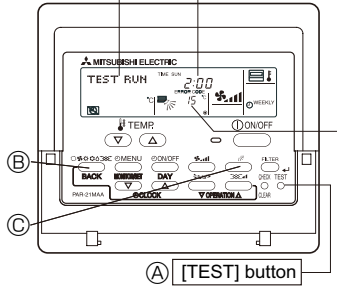

Pipe (liquid) temperature

### Operating procedures

1. Turn on the main power supply.	While the room temperature display on the remote controller is "PLEASE WAIT", the remote controller is disabled. Wait until "PLEASE WAIT" disappears before using remote controller. "PLEASE WAIT" appears for about 2 minutes after power supply is turned on. *1
2. Press (A) [TEST] button twice.	The [TEST RUN] appears on the screen.
3. Press (B) [OPERATION SWITCH] button.	Cooling mode: Check if cool air blows and water is drained. Heating mode: Check if warm air blows. (It takes a little while until warm air blows.)
4. Press (C) [AIR DIRECTION] button.	Check for correct motion of auto-vanes.
5. Check the outdoor unit fan for correct running.	The outdoor unit features automatic capacity control to provide optimum fan speeds. Therefore, the fan keeps running at a low speed to meet the current outside air condition unless it exceeds its available maximum power. Then, in actuality, the fan may stop or run in the reverse direction depending on the outside air, but this does not mean malfunction.
6. Press the [ON/OFF] button to reset the test run in progress.	
7. Register the contact number.	

- In case of test run, the OFF timer will be activated, and the test run will automatically stop after 2 hours.
- The room temperature display section shows the pipe temperature of indoor units during the test run.
- Check that all the indoor units are running properly in case of simultaneous twin, triple and quadruple operation. Malfunctions may not be displayed regardless of incorrect wiring.

\*1 After turning on the power supply, the system will go into startup mode, "PLEASE WAIT" will blink on the display section of the room temperature, and lamp(green) of the remote controller will blink.

As to INDOOR BOARD LED, LED1 will be lit up, LED2 will either be lit up in case the address is 0 or turned off in case the address is not 0. LED3 will blink.

As to OUTDOOR BOARD LED, LED1(green) and LED2(red) will be lit up. (After the startup mode of the system finishes, LED2(red) will be turned off.)

In case OUTDOOR BOARD LED is digital display, and will be displayed alternately every second.

- If one of the above operations doesn't function correctly, the causes written below should be considered. Find causes from the symptoms.

The below symptoms are under test run mode. "startup" in the table means the display status of \*1 written above.

Symptoms in test run mode		Cause
Remote Controller Display	OUTDOOR BOARD LED Display < > indicates digital display.	
Remote controller displays "PLEASE WAIT", and cannot be operated.	After "startup" is displayed, only green lights up. <00>	• After power is turned on, "PLEASE WAIT" is displayed for 2 minutes during system startup. (Normal)
After power is turned on, "PLEASE WAIT" is displayed for 3 minutes, then error code is displayed.	After "startup" is displayed, green(once) and red(once) blink alternately. <F1>	• Incorrect connection of outdoor terminal block (L1, L2, L3 and S1, S2, S3.)
	After "startup" is displayed, green(once) and red(twice) blink alternately. <F3, F5, F9>	• Outdoor unit's protection device connector is open.
No display appears even when remote controller operation switch is turned on. (Operation lamp does not light up.)	After "startup" is displayed, green(twice) and red(once) blink alternately. <EA, Eb>	• Incorrect wiring between the indoor and outdoor unit (Polarity is wrong for S1, S2, S3.)
	After "startup" is displayed, only green lights up. <00>	• Remote controller transmission wire is short. • There is no outdoor unit of address 0. (Address is other than 0.) • Remote controller transmission wire is open.
Display appears but soon disappears even when remote controller is operated.	After "startup" is displayed, only green lights up. <00>	• After canceling function selection, operation is not possible for about 30 seconds. (Normal)

\* Press the remote controller's [CHECK] button twice to perform self-diagnosis. See the table below for the contents of LCD display.

LCD	Contents of trouble	LCD	Contents of trouble
P1	Abnormality of room temperature thermistor	U1~UP	Malfunction outdoor unit
P2	Abnormality of pipe temperature thermistor/Liquid	F3~F9	Malfunction outdoor unit
P4	Abnormality of drain sensor/ Float switch connector open	E0~E5	Remote controller transmitting error
P5	Drain overflow protection is working.	E6~EF	Indoor/outdoor unit communication error
P6	Freezing/overheating protection is working.	----	No error history
P8	Abnormality of pipe temperature	FFFF	No applied unit
P9	Abnormality of pipe temperature thermistor/Cond./Eva	PA	Forced compressor stop(due to water leakage abnormality)
Fb	Abnormality of indoor controller board		





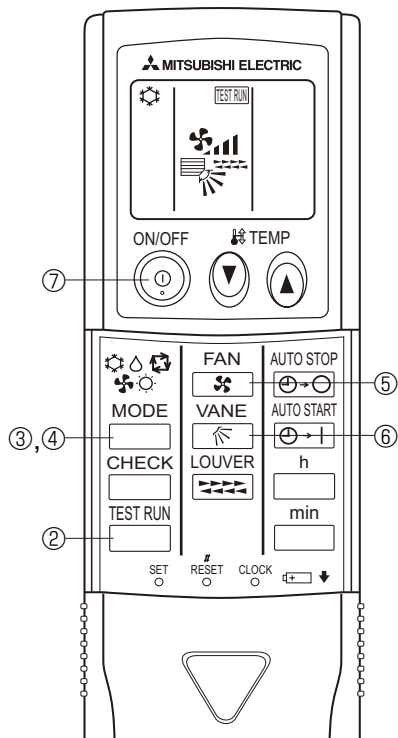











See the table below for details of the LED display (LED 1, 2, 3) on the indoor controller board.

LED1 (microcomputer power supply)	Lits when power is supplied.
LED2 (remote controller)	Lits when power is supplied for wired remote controller. The indoor unit should be connected to the outdoor unit with address "0" setting.
LED3 (indoor/outdoor communication)	Blinks when indoor and outdoor unit are communicating.



### Test run [for wireless remote controller]

Measure an impedance between the power supply terminal block on the outdoor unit and ground with a 500V Megger and check that it is equal to or greater than 1.0MΩ.

- ① Turn on the main power to the unit.
- ② Press the  button twice continuously.  
(Start this operation from the status of remote controller display turned off.)  
A  and current operation mode are displayed.
- ③ Press the  (     ) button to activate  mode, then check whether cool air is blown out from the unit.
- ④ Press the  (     ) button to activate  mode, then check whether warm air is blown out from the unit.
- ⑤ Press the  button and check whether strong air is blown out from the unit.
- ⑥ Press the  button and check whether the auto vane operates properly.
- ⑦ Press the ON/OFF button to stop the test run.

#### Note:

- Point the remote controller towards the indoor unit receiver while following steps ② to ⑦.
- It is not possible to run in FAN, DRY or AUTO mode.

## 10-3. HOW TO PROCEED "SELF-DIAGNOSIS"

### 10-3-1. When a Problem Occurs During Operation

If a problem occurs in the air conditioner, the indoor and outdoor units will stop, and the problem is shown in the remote controller display.

① [CHECK] and the refrigerant address are displayed on the temperature display, and the error code and unit number are displayed alternately as shown below.  
(If the outdoor unit is malfunctioning, the unit number will be "00".)

② In the case of group control, for which one remote controller controls multiple refrigerant systems, the refrigerant address and error code of the unit that first experienced trouble (i.e., the unit that transmitted the error code) will be displayed.

③ To clear the error code, press the **ON/OFF** button.

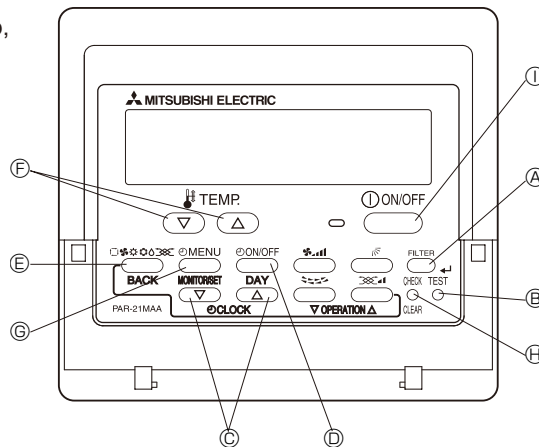

(Alternating Display)



When using remote-/local-controller combined operation, cancel the error code after turning off remote operation. During central control by a MELANS controller, cancel the error code by pressing the **ON/OFF** button.

### 10-3-2. Self-Diagnosis During Maintenance or Service

Since each unit has a function that stores error codes, the latest check code can be recalled even if it is cancelled by the remote controller or power is turned off.

Check the error code history for each unit using the remote controller.

① Switch to self-diagnosis mode.

⊕ Press the **CHECK** button twice within 3 seconds. The display content will change as shown below.

② Set the unit number or refrigerant address you want to diagnose.

⊕ Press the [TEMP] buttons (**▽** and **△**) to select the desired number or address. The number (address) changes between [01] and [50] or [00] and [15].

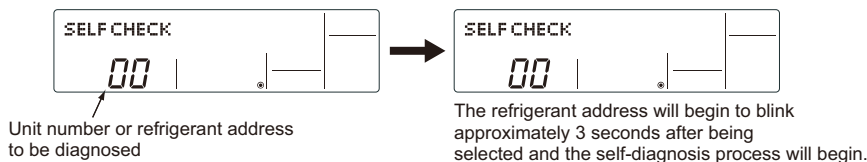

③ Display self-diagnosis results.  
<When there is error code history>

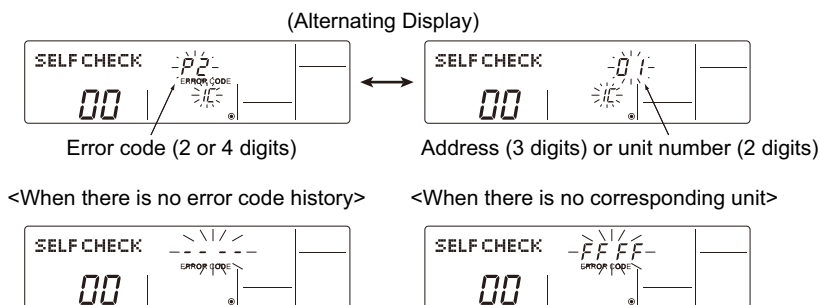

④ Reset the error history.  
Display the error history in the diagnosis result display screen (see step ③).





- ④ Press the **ON/OFF** button twice within 3 seconds. The self-diagnosis address or refrigerant address will blink.

When the error history is reset, the display will look like the one shown below. However, if you fail to reset the error history, the error content will be displayed again.

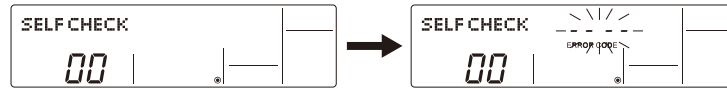

- ⑤ Cancel self-diagnosis.

Self-diagnosis can be cancelled by the following 2 methods.

- ⑥ Press the **CHECK** button twice within 3 seconds. → Self-diagnosis will be cancelled and the screen will return to the previous state in effect before the start of self-diagnosis.
- ⑦ Press the **ON/OFF** button. → Self-diagnosis will be cancelled and the indoor unit will stop.

### 10-3-3. Remote Controller Diagnosis

If the air conditioner cannot be operated from the remote controller, diagnose the remote controller as explained below.

- ① First, check that the power-on indicator is lit.  
If the correct voltage (DC12 V) is not supplied to the remote controller, the indicator will not light.  
If this occurs, check the remote controller's wiring and the indoor unit.

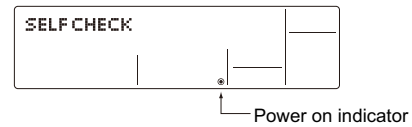

- ② Switch to the remote controller self-diagnosis mode.

④ Press the **CHECK** button for 5 seconds or more. The display content will change as shown below.

- ④ Press the **FILTER** button to start self-diagnosis.

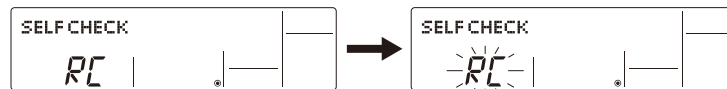

- ③ Remote controller self-diagnosis result

[When the remote controller is functioning correctly]



Check for other possible causes, as there is no problem with the remote controller.

[When the remote controller malfunctions]

(Error display 1) "NG" blinks. → The remote controller's transmitting-receiving circuit is defective.



The remote controller must be replaced with a new one.

[Where the remote controller is not defective, but cannot be operated.]

(Error display 2) [E3], [6833] or [6832] blinks.  
→ Transmission is not possible.



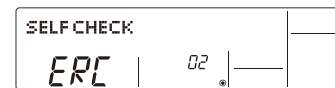

There might be noise or interference on the transmission path, or the indoor unit or other remote controllers are defective. Check the transmission path and other controllers.

(Error display 3) "ERC" and the number of data errors are displayed.  
→ Data error has occurred.



The number of data errors is the difference between the number of bits sent from the remote controller and the number actually transmitted through the transmission path. If such a problem is occurring, the transmitted data is affected by noise, etc. Check the transmission path.

When the number of data errors is "02":

Transmission data from remote controller   
Transmission data on transmission path 

- ④ To cancel remote controller diagnosis

④ Press the **CHECK** button for 5 seconds or more. Remote controller diagnosis will be cancelled, "PLEASE WAIT" and operation lamp will blink. After approximately 30 seconds, the state in effect before the diagnosis will be restored.

### 10-3-4. Malfunction-diagnosis method by wireless remote controller



#### <In case of trouble during operation>

When a malfunction occurs to air conditioner, both indoor unit and outdoor unit will stop and operation lamp blinks to inform unusual stop.

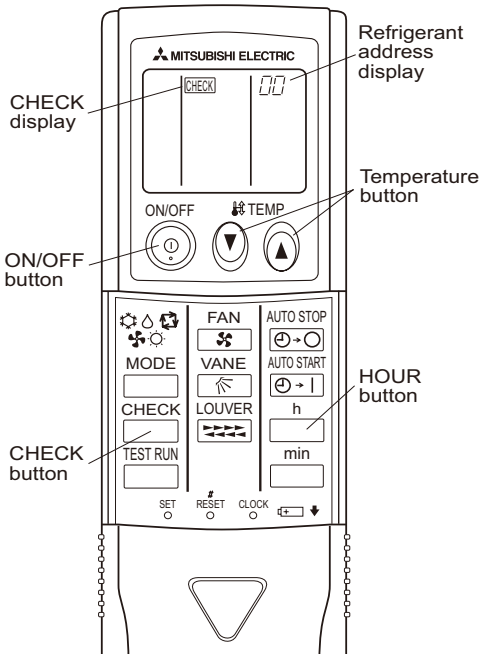
#### <Malfunction-diagnosis method at maintenance service>



#### [Procedure]

1. Press the CHECK button twice.
  - "CHECK" lights, and refrigerant address "00" blinks.
  - Check that the remote controller's display has stopped before continuing.
2. Press the temperature   buttons.
  - Select the refrigerant address of the indoor unit for the self-diagnosis.
  - Note: Set refrigerant address using the outdoor unit's DIP switch (SW1). (For more information, see the outdoor unit installation manual.)
3. Point the remote controller at the sensor on the indoor unit and press the HOUR button.
  - If an air conditioner error occurs, the indoor unit's sensor emits an intermittent buzzer sound, the operation lamp blinks, and the error code is output. (It takes 3 seconds at most for error code to appear.)
4. Point the remote controller at the sensor on the indoor unit and press the ON/OFF button.
  - The check mode is cancelled.

- Refer to the following tables for details on the check codes.

[Output pattern A]

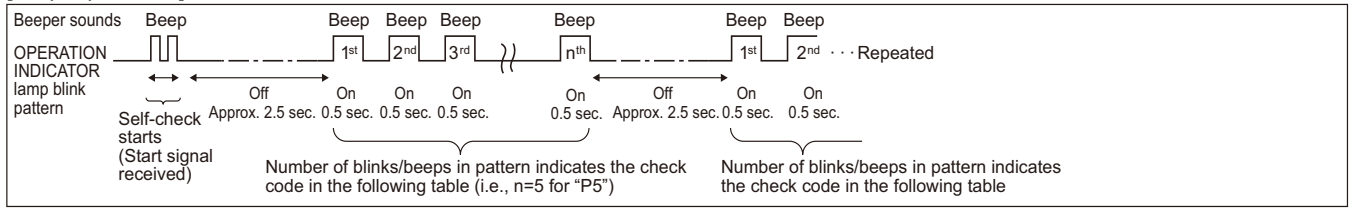

[Output pattern B]

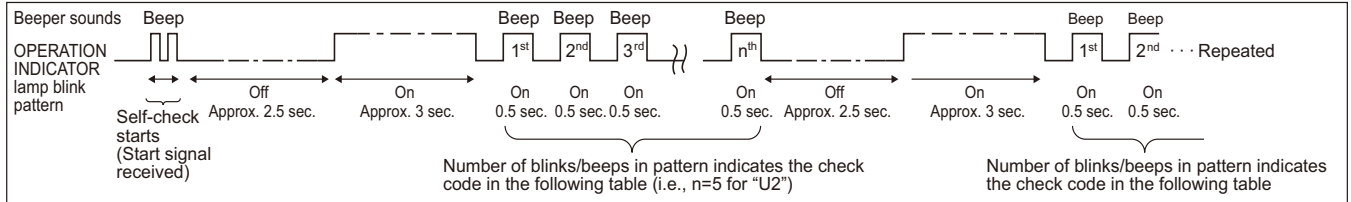

[Output pattern A] Errors detected by indoor unit

Wireless remote controller Beeper sounds/OPERATION INDICATOR lamp blinks (Number of times)	Wired remote controller Check code	Symptom	Remark
1	P1	Intake sensor error	As for indoor unit, refer to indoor unit's service manual.
2	P2	Pipe (TH2) sensor error	
	P9	Pipe (TH5) sensor error	
3	E6, E7	Indoor/outdoor unit communication error	
4	P4	Drain sensor error/Float switch connector open	
5	P5	Drain pump error	
	PA	Forced compressor stop(due to water leakage abnormality)	
6	P6	Freezing/Overheating protection operation	
7	EE	Communication error between indoor and outdoor units	
8	P8	Pipe temperature error	
9	E4, E5	Remote controller signal receiving error	
10	-	-	
11	-	-	
12	Fb	Indoor unit control system error (memory error, etc.)	
-	E0, E3	Remote controller transmission error	
-	E1, E2	Remote controller control board error	

[Output pattern B] Errors detected by unit other than indoor unit (outdoor unit, etc.)

Wireless remote controller Beeper sounds/OPERATION INDICATOR lamp blinks (Number of times)	Wired remote controller Check code	Symptom	Remark
1	E9	Indoor/outdoor unit communication error (Transmitting error) (Outdoor unit)	For details, check the LED display of the outdoor controller board.
2	UP	Compressor overcurrent interruption	
3	U3, U4	Open/short of outdoor unit thermistors	
4	UF	Compressor overcurrent interruption (When compressor locked)	
5	U2	Abnormal high discharging temperature/insufficient refrigerant	
6	U1, Ud	Abnormal high pressure (63H worked)/Overheating protection operation	
7	U5	Abnormal temperature of heatsink	
8	U8	Outdoor unit fan protection stop	
9	U6	Compressor overcurrent interruption/Abnormality of power module	
10	U7	Abnormality of superheat due to low discharge temperature	
11	U9, UH	Abnormality such as overvoltage or voltage shortage and abnormal synchronous signal to main circuit/Current sensor error	
12	-	-	
13	-	-	
14	Others	Other errors (Refer to the technical manual for the outdoor unit.)	

\*1 If the beeper does not sound again after the initial 2 beeps to confirm the self-check start signal was received and the OPERATION INDICATOR lamp does not come on, there are no error records.

\*2 If the beeper sounds 3 times continuously "beep, beep, beep (0.4 + 0.4 + 0.4 sec.)" after the initial 2 beeps to confirm the self-check start signal was received, the specified refrigerant address is incorrect.

## 10-4. SELF-DIAGNOSIS ACTION TABLE

<Abnormalities detected when the power is turned on> (Note 1) Refer to indoor unit section for code P and code E.

Error Code	Abnormal point and detection method	Case	Judgment and action
None	—	<p>① No voltage is supplied to terminal block(TB1) of outdoor unit. a) Power supply breaker is turned off. b) Contact failure or disconnection of power supply terminal c) Open phase (L2 or N phase)</p> <p>② Electric power is not supplied to outdoor controller circuit board. a) Disconnection of connector (CNDC)</p> <p>③ Disconnection of reactor (ACL4)</p> <p>④ Disconnection of outdoor noise filter circuit board or parts failure in outdoor noise filter circuit board</p> <p>⑤ Defective outdoor controller circuit board</p>	<p>① Check following items. a) Power supply breaker b), c) Connection of power supply terminal block(TB1)</p> <p>② Check connection of the connector (CNDC) on the outdoor controller circuit board. Check connection of the connector CNDC on the outdoor noise filter circuit board. Refer to 10-9.</p> <p>③ Check connection of reactor. (ACL4)</p> <p>④ a) Check connection of outdoor noise filter circuit board. b) Replace outdoor noise filter circuit board. Refer to 10-9.</p> <p>⑤ Replace controller board (When items above are checked but the units cannot be repaired).</p>
F3 (5202)	<p><b>63L connector open</b> Abnormal if 63L connector circuit is open for 3 minutes continuously after power supply. 63L: Low-pressure switch &lt;RP250 only&gt;</p>	<p>① Disconnection or contact failure of 63L connector on outdoor controller circuit board.</p> <p>② Disconnection or contact failure of 63L.</p> <p>③ 63L is working due to refrigerant leakage or defective parts.</p> <p>④ Defective outdoor controller circuit board.</p>	<p>① Check connection of 63L connector on outdoor controller circuit board. Refer to 10-9.</p> <p>② Check the 63L side of connecting wire.</p> <p>③ Check refrigerant pressure. Charge additional refrigerant. Check continuity by tester. Replace the parts if the parts are defective.</p> <p>④ Replace outdoor controller circuit board.</p>
F5 (5201)	<p><b>63H connector open</b> Abnormal if 63H connector circuit is open for 3 minutes continuously after power supply. 63H: High-pressure switch</p>	<p>① Disconnection or contact failure of 63H connector on outdoor controller circuit board</p> <p>② Disconnection or contact failure of 63H</p> <p>③ 63H is working due to defective parts.</p> <p>④ Defective outdoor controller circuit board</p>	<p>① Check connection of 63H connector on outdoor controller circuit board. Refer to 10-9.</p> <p>② Check the 63H side of connecting wire.</p> <p>③ Check continuity by tester. Replace the parts if the parts are defective.</p> <p>④ Replace outdoor controller circuit board.</p>
F9 (4119)	<p><b>2 connector open</b> Abnormal if both 63H and 63L connector circuits are open for 3 minutes continuously after power supply. 63H: High-pressure switch 63L: Low-pressure switch &lt;RP250 only&gt;</p>	<p>① Disconnection or contact failure of connector (63H,63L) on outdoor controller circuit board.</p> <p>② Disconnection or contact failure of 63H, 63L.</p> <p>③ 63H and 63L are working due to defective parts.</p> <p>④ Defective outdoor controller circuit board.</p>	<p>① Check connection of connector(63H,63L) on outdoor controller circuit board. Refer to 10-9.</p> <p>② Check the 63H and 63L side of connecting wire.</p> <p>③ Check continuity by tester. Replace the parts if the parts are defective.</p> <p>④ Replace outdoor controller circuit board.</p>



Error Code	Abnormal point and detection method	Case	Judgment and action
EA (6844)	<p><b>Indoor/outdoor unit connector miswiring, excessive number of units</b></p> <p>1. Outdoor controller circuit board can automatically check the number of connected indoor units. Abnormal if the number cannot be checked automatically due to miswiring of indoor/outdoor unit connecting wire and etc. after power is turned on for 4 minutes.</p> <p>2. Abnormal if outdoor controller circuit board recognizes excessive number of indoor units.</p>	<p>① Contact failure or miswiring of indoor/outdoor unit connecting wire</p> <p>② Diameter or length of indoor/outdoor unit connecting wire is out of specified capacity.</p> <p>③ Excessive number of indoor units are connected to 1 outdoor unit.(5 units or more)</p> <p>④ Defective transmitting receiving circuit of outdoor controller circuit board</p> <p>⑤ Defective transmitting receiving circuit of indoor controller board</p> <p>⑥ Defective indoor power board</p> <p>⑦ 2 or more outdoor units have refrigerant address "0" . (In case of group control)</p> <p>⑧ Noise has entered into power supply or indoor / outdoor unit connecting wire.</p>	<p>① Check disconnection or looseness or polarity of indoor/outdoor unit connecting wire of indoor and outdoor units.</p> <p>② Check diameter and length of indoor/outdoor unit connecting wire. Total wiring length: 80m (Including wiring connecting each indoor unit and between indoor and outdoor unit) Also check if the connection order of flat cable is S1, S2, S3.</p> <p>③ Check the number of indoor units that are connected to one outdoor unit. (If EA is detected.)</p> <p>④~⑥ Turn the power off once, and on again to check. Replace outdoor controller circuit board, indoor controller board or indoor power board if abnormality occurs again.</p> <p>⑦ Check if refrigerant addresses (SW1-3 to SW1-6 on outdoor controller circuit board) are overlapping in case of group control system.</p>
Eb (6845)	<p><b>Miswiring of indoor/outdoor unit connecting wire (converse wiring or disconnection)</b></p> <p>Outdoor controller circuit board can automatically set the unit number of indoor units. Abnormal if the indoor unit number cannot be set within 4 minutes after power on because of miswiring (converse wiring or disconnection) of indoor/outdoor unit connecting wire.</p>	<p>① Contact failure or miswiring of indoor/outdoor unit connecting wire</p> <p>② Diameter or length of indoor/outdoor unit connecting wire is out of specified capacity.</p> <p>④ Defective transmitting receiving circuit of outdoor controller circuit board</p> <p>⑤ Defective transmitting receiving circuit of indoor controller board</p> <p>⑥ Defective indoor power board</p> <p>⑦ 2 or more outdoor units have refrigerant address "0" . (In case of group control)</p> <p>⑧ Noise has entered into power supply or indoor/outdoor unit connecting wire.</p>	<p>⑥ Check transmission path, and remove the cause.</p> <p>※ The descriptions above, ①-⑧, are for EA, Eb and EC.</p>
EC (6846)	<p><b>Start-up time over</b></p> <p>The unit cannot finish start-up process within 4 minutes after power on.</p>	<p>① Contact failure of indoor/outdoor unit connecting wire</p> <p>② Diameter or length of indoor/outdoor unit connecting wire is out of specified capacity.</p> <p>⑦ 2 or more outdoor units have refrigerant address "0" . (In case of group control)</p> <p>⑧ Noise has entered into power supply or indoor/outdoor unit connecting wire.</p>	

<Abnormalities detected while unit is operating>

Error Code	Abnormal point and detection method	Case	Judgment and action
<p>U1 (1302)</p>	<p><b>High pressure (High-pressure switch 63H(RP200)/63H1 or 63H2(RP250) worked)</b>                      Abnormal if high-pressure switch 63H(RP200)/63H1 or 63H2(RP250) worked ( * ) during compressor operation.                      * 63H1: 4.15 MPa                      63H, 63H2: 3.6 MPa</p> <p>63H, 63H1, 63H2: High-pressure switch</p>	<p>① Short cycle of indoor unit                      ② Clogged filter of indoor unit                      ③ Decreased airflow caused by dirt of indoor fan                      ④ Dirt of indoor heat exchanger                      ⑤ Locked indoor fan motor                      ⑥ Malfunction of indoor fan motor                      ⑦ Defective operation of stop valve (Not fully open)                      ⑧ Clogged or broken pipe                      ⑨ Locked outdoor fan motor                      ⑩ Malfunction of outdoor fan motor                      ⑪ Short cycle of outdoor unit                      ⑫ Dirt of outdoor heat exchanger                      ⑬ Decreased airflow caused by defective inspection of outside temperature thermistor (It detects lower temperature than actual temperature.)                      ⑭ Disconnection or contact failure of connector (63H) on outdoor controller board                      ⑮ Disconnection or contact failure of 63H connection                      ⑯ Defective outdoor controller board                      ⑰ Defective action of linear expansion valve                      ⑱ Malfunction of fan driving circuit</p>	<p>①~⑥ Check indoor unit and repair defect.</p> <p>⑦ Check if stop valve is fully open.</p> <p>⑧ Check piping and repair defect.                      ⑨~⑫ Check outdoor unit and repair defect.</p> <p>⑬ Check the inspected temperature of outside temperature thermistor on LED display. (SW2 on A-Control Service Tool : Refer to 10-10.)</p> <p>⑭~⑯ Turn the power off and check F5 is displayed when the power is turned again. When F5 is displayed, refer to "Judgment and action" for F5.</p> <p>⑰ Check linear expansion valve. Refer to 10-7.                      ⑱ Replace outdoor controller board.</p>
<p>U2 (1102)</p>	<p><b>High discharging temperature</b>                      (1) Abnormal if discharge temperature thermistor (TH4) exceeds 125°C or 110°C continuously for 5 minutes.                      Abnormal if condenser/evaporator temperature thermistor (TH5) exceeds 40°C during defrosting and discharge temperature thermistor (TH4) exceeds 110°C .                      (2) Abnormal if discharge superheat (Cooling: TH4 – TH5 / Heating: TH4 – TH6) exceeds 70°C continuously for 10 minutes.</p>	<p>① Overheated compressor operation caused by shortage of refrigerant                      ② Defective operation of stop valve                      ③ Defective thermistor                      ④ Defective outdoor controller board                      ⑤ Defective action of linear expansion valve                      ⑥ Clogging with foreign objects in refrigerant circuit                      * Clogging occurs in the parts which become below freezing point when water enters in refrigerant circuit.</p>	<p>① Check intake superheat. Check leakage of refrigerant. Charge additional refrigerant.                      ② Check if stop valve is fully open.</p> <p>③④ Turn the power off and check if U3 is displayed when the power is turned on again. When U3 is displayed, refer to "Judgement and action" for U3.</p> <p>⑤ Check linear expansion valve. Refer to 10-7.                      ⑥ After recovering refrigerant, remove water from entire refrigerant circuit under vacuum more than 1 hour.</p>
<p>U3 (5104)</p>	<p><b>Open/short circuit of discharge temperature thermistor (TH4)</b>                      Abnormal if open (3°C or less) or short (217°C or more) is detected during compressor operation.                      (Detection is inoperative for 10 minutes of compressor starting process and for 10 minutes after and during defrosting.)</p>	<p>① Disconnection or contact failure of connector (TH4) on the outdoor controller circuit board                      ② Defective thermistor                      ③ Defective outdoor controller circuit board</p>	<p>① Check connection of connector (TH4) on the outdoor controller circuit board. Check breaking of the lead wire for thermistor (TH4). Refer to 10-9.                      ② Check resistance value of thermistor (TH4) or temperature by microcomputer. (Thermistor/TH4: Refer to 10-7.) (SW2 on A-Control Service Tool: Refer to 10-10.)                      ③ Replace outdoor controller board.</p>

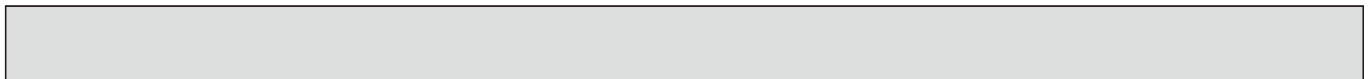

Error Code	Abnormal point and detection method	Case	Judgment and action																								
U4 (TH3:5105) (TH6:5107) (TH7:5106) (TH8:5110)	<b>Open/short of outdoor unit thermistors (TH3, TH6, TH7, and TH8)</b> Abnormal if open or short is detected during compressor operation. Open detection of thermistors TH3 and TH6 are inoperative for 10 seconds to 10 minutes after compressor starting and 10 minutes after and during defrosting. *Check which unit has abnormality in its thermistor by switching the mode of SW2. (PAC-SK52ST) (Refer to 10-10.) *Heatsink thermistor(TH8) is in the power module.	① Disconnection or contact failure of connectors (Outdoor controller circuit board: TH3,TH7/6) ② Defective thermistor ③ Defective outdoor controller circuit board ④ Defective outdoor power circuit board (TH8 open/ short)	① Check connection of connector (TH3,TH7/6) on the outdoor controller circuit board. Check breaking of the lead wire for thermistor (TH3,TH6,TH7). Refer to 10-9. ② Check resistance value of thermistor (TH3,TH6,TH7) or check temperature by microcomputer. (Thermistor/TH3,TH6,TH7 : Refer to 10-7.) (SW2 on A-Control Service Tool: Refer to 10-10.) ③ Replace outdoor controller circuit board. ④ Replace outdoor power circuit board. *Emergency operation is available in case of abnormalities of TH3, TH6 and TH7. Refer to 10-8.																								
	<table border="1" style="width:100%; border-collapse: collapse;"> <thead> <tr> <th colspan="2">Thermistors</th> <th>Open detection</th> <th>Short detection</th> </tr> <tr> <th>Symbol</th> <th>Name</th> <td></td> <td></td> </tr> </thead> <tbody> <tr> <td>TH3</td> <td>Thermistor &lt;Outdoor pipe&gt;</td> <td>- 40°C or below</td> <td>90°C or above</td> </tr> <tr> <td>TH6</td> <td>Thermistor &lt;Outdoor 2-phase pipe&gt;</td> <td>- 40°C or below</td> <td>90°C or above</td> </tr> <tr> <td>TH7</td> <td>Thermistor &lt;Outdoor&gt;</td> <td>- 40°C or below</td> <td>90°C or above</td> </tr> <tr> <td>TH8</td> <td>Thermistor &lt;Heatsink&gt;</td> <td>- 35°C or below</td> <td>170°C or above</td> </tr> </tbody> </table>				Thermistors		Open detection	Short detection	Symbol	Name			TH3	Thermistor <Outdoor pipe>	- 40°C or below	90°C or above	TH6	Thermistor <Outdoor 2-phase pipe>	- 40°C or below	90°C or above	TH7	Thermistor <Outdoor>	- 40°C or below	90°C or above	TH8	Thermistor <Heatsink>	- 35°C or below
Thermistors		Open detection	Short detection																								
Symbol	Name																										
TH3	Thermistor <Outdoor pipe>	- 40°C or below	90°C or above																								
TH6	Thermistor <Outdoor 2-phase pipe>	- 40°C or below	90°C or above																								
TH7	Thermistor <Outdoor>	- 40°C or below	90°C or above																								
TH8	Thermistor <Heatsink>	- 35°C or below	170°C or above																								
U5 (4230)	<b>Temperature of heatsink</b> Abnormal if heatsink thermistor(TH8) detects temperature 95°C. * Heatsink thermistor is in the power module.	① The outdoor fan motor is locked. ② Failure of outdoor fan motor ③ Air flow path is clogged. ④ Rise of ambient temperature ⑤ Defective thermistor ⑥ Defective input circuit of outdoor power circuit board ⑦ Failure of outdoor fan drive circuit	①② Check outdoor fan. ③ Check air flow path for cooling. ④ Check if there is something which causes temperature rise around outdoor unit. (Upper limit of ambient temperature is 46°C.) Turn off power, and on again to check if U5 is displayed within 30 minutes. If U4 is displayed instead of U5, follow the action to be taken for U4. ⑤ Check temperature(TH8) by microcomputer. (SW2 on A-Control Service Tool: Refer to 10-10.) ⑥ Replace outdoor power circuit board. ⑦ Replace outdoor controller circuit board.																								
U6 (4250)	<b>Power module</b> Check abnormality by driving power module in case overcurrent is detected. (UF or UP error condition)	① Outdoor stop valve is closed. ② Decrease of power supply voltage ③ Looseness, disconnection or converse of compressor wiring connection ④ Defective compressor ⑤ Defective outdoor power circuit board	① Open stop valve. ② Check facility of power supply. ③ Correct the wiring (U·V·W phase) to compressor. Refer to 10-9 (Outdoor power circuit board). ④ Check compressor referring to 10-6. ⑤ Replace outdoor power circuit board.																								
U8 (4400)	<b>Outdoor fan motor</b> The outdoor fan motor is considered to be abnormal if the rotational frequency of fan motor is abnormal when detected during operation. Fan motor rotational frequency is abnormal if; • 100 rpm or below detected continuously for 15 seconds at 20°C or more outside air temperature. • 50 rpm or below or 1500 rpm or more detected continuously for 1 minute.	① Failure in the operation of the DC fan motor ② Failure in the outdoor circuit controller board	① Check or replace the DC fan motor. ② Check the voltage of the outdoor circuit controller board during operation. ③ Replace the outdoor circuit controller board. (When the failure is still indicated even after performing the remedy ① above.)																								

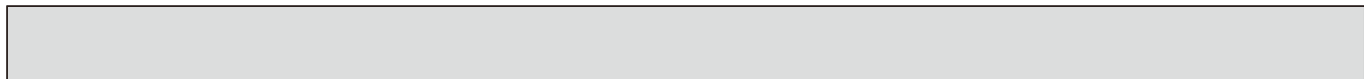

Error Code	Abnormal point and detection method	Case	Judgment and action
<p>U9 (4220)</p>	<p><b>Abnormality such as overvoltage or voltage shortage and abnormal synchronous signal to main circuit</b></p> <p>Abnormal if any of followings are detected during compressor operation;</p> <ul style="list-style-type: none"> <li>• Instantaneous decrease of DC bus voltage to 400V</li> <li>• Increase of DC bus voltage to 760V</li> <li>• Decrease of input current of outdoor unit to 0.5A only if operation frequency is more than or equal to 40Hz or compressor current is more than or equal to 5A.</li> </ul>	<ul style="list-style-type: none"> <li>① Decrease of power supply voltage</li> <li>② Disconnection of compressor wiring</li> <li>③ Defective 52C drive circuit of outdoor power circuit board</li> <li>④ Disconnection or loose connection of CN5 on the outdoor power circuit board</li> <li>⑤ Disconnection or loose connection of CN2 on the outdoor power circuit board</li> <li>⑥ Defective outdoor controller circuit board</li> </ul>	<ul style="list-style-type: none"> <li>① Check the facility of power supply.</li> <li>② Correct the wiring (U·V·W phase) to compressor. Refer to 10-9 (Outdoor power circuit board).</li> <li>③ Replace outdoor power circuit board.</li> <li>④ Check CN5 wiring on the outdoor power circuit board. Refer to 10-9.</li> <li>⑤ Check CN2 wiring on the outdoor power circuit board. Refer to 10-9.</li> <li>⑥ Replace outdoor controller circuit board.</li> </ul>
<p>Ud (1504)</p>	<p><b>Overheat protection</b></p> <p>Abnormal if outdoor pipe thermistor (TH3) detects 70°C or more during compressor operation.</p>	<ul style="list-style-type: none"> <li>① Defective outdoor fan (fan motor) or short cycle of outdoor unit during cooling operation</li> <li>② Defective outdoor pipe thermistor (TH3)</li> <li>③ Defective outdoor controller board</li> </ul>	<ul style="list-style-type: none"> <li>① Check outdoor unit air passage.</li> <li>②③ Turn the power off and on again to check the error code. If U4 is displayed, follow the U4 processing direction.</li> </ul>
<p>UF (4100)</p>	<p><b>Compressor overcurrent interruption (When compressor locked)</b></p> <p>Abnormal if overcurrent of DC bus or compressor is detected within 30 seconds after compressor starts operating.</p>	<ul style="list-style-type: none"> <li>① Stop valve is closed.</li> <li>② Decrease of power supply voltage</li> <li>③ Looseness, disconnection or converse of compressor wiring connection</li> <li>④ Defective compressor</li> <li>⑤ Defective outdoor power board</li> <li>⑥ Dip switch setting difference of outdoor controller circuit board</li> </ul>	<ul style="list-style-type: none"> <li>① Open stop valve.</li> <li>② Check facility of power supply.</li> <li>③ Correct the wiring (U·V·W phase) to compressor. Refer to 10-9 (Outdoor power circuit board).</li> <li>④ Check compressor. Refer to 10-6.</li> <li>⑤ Replace outdoor power circuit board.</li> <li>⑥ Check the dip switch setting of outdoor controller circuit board.</li> </ul>
<p>UH (5300)</p>	<p><b>Compressor current sensor error or input current error</b></p> <p>Abnormal if compressor current sensor detects -1.0A to 1.0A within 3 minutes after compressor starts operating. (This error is ignored in case of test run mode.)</p>	<ul style="list-style-type: none"> <li>① Disconnection of compressor wiring</li> <li>② Defective circuit of current sensor on outdoor power circuit board</li> </ul>	<ul style="list-style-type: none"> <li>① Correct the wiring (U·V·W phase) to compressor. Refer to 10-9 (Outdoor power circuit board).</li> <li>② Replace outdoor power circuit board.</li> </ul>
<p>UL (1300)</p>	<p><b>Low pressure(RP200)</b></p> <p>Abnormal if the following conditions are detected for continuously 1-3 minutes after compressor starts heating operation for 5 minutes.</p> <p>1. Heating mode</p> <p>Detection mode1 TH7-TH3<math>\leq</math>4°C and TH5-Indoor room temperature<math>\leq</math>2°C</p> <p>Detection mode2 TH7-TH3<math>\leq</math>2°C and TH5-Indoor room temperature<math>\leq</math>4°C and TH2-Indoor room temperature<math>\leq</math>4°C</p> <p>2. Cooling mode</p> <p>TH6-TH7<math>\leq</math>2°C and TH3-TH7<math>\leq</math>2°C and Indoor room temperature - Indoor liquid pipe temperature (TH2)<math>\leq</math>5°C</p> <p>Thermistor TH3 : Outdoor liquid pipe temperature TH5 : Indoor cond./eva. temperature TH6 : Outdoor 2-phase pipe temperature TH7 : Outdoor temperature</p>	<ul style="list-style-type: none"> <li>① Stop valve of outdoor unit is closed during operation.</li> <li>② Leakage or shortage of refrigerant</li> <li>③ Malfunction of linear expansion valve</li> <li>④ Clogging with foreign objects in refrigerant circuit</li> <li>* Clogging occurs in the parts which become below freezing point when water enters in refrigerant circuit.</li> </ul>	<ul style="list-style-type: none"> <li>① Check stop valve.</li> <li>② Check intake superheat. Check leakage of refrigerant. Check additional refrigerant.</li> <li>③ Check linear expansion valve. Refer to 10-7.</li> <li>④ After recovering refrigerant, remove water from entire refrigerant circuit under vacuum more than 1 hour.</li> </ul>





Error Code	Abnormal point and detection method	Case	Judgment and action
UL (1300)	<b>Low pressure (63L worked)(RP250)</b> Abnormal if 63L is worked (under -0.03MPa) during compressor operation. 63L: Low-pressure switch	① Stop valve of outdoor unit is closed during operation. ② Disconnection or loose connection of connector (63L) on outdoor controller circuit board ③ Disconnection or loose connection of 63L ④ Defective outdoor controller circuit board ⑤ Leakage or shortage of refrigerant ⑥ Malfunction of linear expansion valve	① Check stop valve. ②~④ Turn the power off and on again to check if F3 is displayed on restarting. If F3 is displayed, follow the F3 processing direction. ⑤ Correct to proper amount of refrigerant. ⑥ Check linear expansion valve. Refer to 10-7.
UP (4210)	<b>Compressor overcurrent interruption</b> Abnormal if overcurrent DC bus or compressor is detected after compressor starts operating for 30 seconds.	① Stop valve of outdoor unit is closed. ② Decrease of power supply voltage ③ Looseness, disconnection or converse of compressor wiring connection ④ Defective fan of indoor/outdoor units ⑤ Short cycle of indoor/outdoor units ⑥ Defective input circuit of outdoor controller board ⑦ Defective compressor ⑧ Defective outdoor power circuit board ⑨ Dip switch setting difference of outdoor controller circuit board	① Open stop valve. ② Check facility of power supply. ③ Correct the wiring (U-V-W phase) to compressor. Refer to 10-9 (Outdoor power circuit board). ④ Check indoor/outdoor fan. ⑤ Solve short cycle. ⑥ Replace outdoor controller circuit board. *Before the replacement of the outdoor controller circuit board, disconnect the wiring to compressor from the outdoor power circuit board and check the output voltage among phases, U, V, W, during test run. No defect on board if voltage among phases (U-V, V-W and W-U) is same. Make sure to perform the voltage check with same performing frequency. ⑦ Check compressor. Refer to 10-6. ⑧ Replace outdoor power circuit board. ⑨ Check the dip switch setting of outdoor controller circuit board.
E0 or E4	<b>Remote controller transmission error(E0)/signal receiving error(E4)</b> ① Abnormal if main or sub remote controller cannot receive any transmission normally from indoor unit of refrigerant address "0" for 3 minutes. (Error code : E0) ② Abnormal if sub-remote controller could not receive any signal for 2 minutes. (Error code: E0) ① Abnormal if indoor controller board cannot receive any data normally from remote controller board or from other indoor controller board for 3 minutes. (Error code: E4) ② Indoor controller board cannot receive any signal from remote controller for 2 minutes. (Error code: E4)	① Contact failure at transmission wire of remote controller ② All remote controllers are set as "sub" remote controller. In this case, E0 is displayed on remote controller, and E4 is displayed at LED (LED1, LED2) on the outdoor controller circuit board. ③ Miswiring of remote controller ④ Defective transmitting receiving circuit of remote controller ⑤ Defective transmitting receiving circuit of indoor controller board of refrigerant address "0" ⑥ Noise has entered into the transmission wire of remote controller.	① Check disconnection or looseness of indoor unit or transmission wire of remote controller. ② Set one of the remote controllers "main", if there is no problem with the action above. ③ Check wiring of remote controller. • Total wiring length: max. 500m (Do not use cable × 3 or more.) • The number of connecting indoor units: max. 16 units • The number of connecting remote controller: max. 2 units When the above-mentioned problem of ①~③ are not applied ④ Diagnose remote controllers. a) When "RC OK" is displayed, remote controllers have no problem. Turn the power off, and on again to check. If abnormality generates again, replace indoor controller board. b) When "RC NG" is displayed, replace remote controller. c) When "RC E3" is displayed, d) When "ERC 00-06" is displayed, [c],d)→Noise may be causing abnormality.] * If the unit is not normal after replacing indoor controller board in group control, indoor controller board of address "0" may be abnormal.
E1 or E2	<b>Remote controller control board</b> ① Abnormal if data cannot be read normally from the nonvolatile memory of the remote controller control board. (Error code: E1) ② Abnormal if the clock function of remote controller cannot be operated normally. (Error code: E2)	① Defective remote controller	① Replace remote controller.

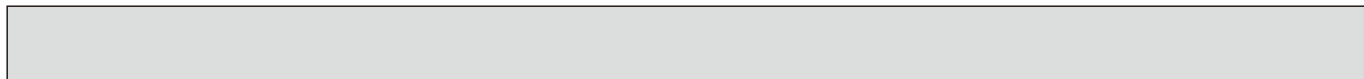

Error Code	Abnormal point and detection method	Case	Judgment and action
E3 or E5	<p><b>Remote controller transmission error(E3)/signal receiving error(E5)</b></p> <p>① Abnormal if remote controller could not find blank of transmission path for 6 seconds and could not transmit. (Error code: E3)</p> <p>② Remote controller receives transmitted data at the same time, compares the data, and when detecting it, judges different data to be abnormal 30 continuous times. (Error code: E3)</p> <p>① Abnormal if indoor controller board could not find blank of transmission path. (Error code: E5)</p> <p>② Indoor controller board receives transmitted data at the same time, compares the data, and when detecting it, judges different data to be abnormal 30 continuous times. (Error code: E5)</p>	<p>① 2 remote controllers are set as "main." (In case of 2 remote controllers)</p> <p>② Remote controller is connected with 2 indoor units or more.</p> <p>③ Repetition of refrigerant address</p> <p>④ Defective transmitting receiving circuit of remote controller</p> <p>⑤ Defective transmitting receiving circuit of indoor controller board</p> <p>⑥ Noise has entered into transmission wire of remote controller.</p>	<p>① Set a remote controller to main, and the other to sub.</p> <p>② Connect remote controller with only one indoor unit.</p> <p>③ Change the address to a separate setting.</p> <p>④~⑥ Diagnose remote controller.</p> <p>a) When "RC OK" is displayed, remote controllers have no problem. Turn the power off, and on again to check. When becoming abnormal again, replace indoor controller board.</p> <p>b) When "RC NG" is displayed, replace remote controller.</p> <p>c) When "RC E3" or "ERC 00-66" is displayed, noise may be causing abnormality.</p>
E8 (6840)	<p><b>Indoor/outdoor unit communication error (Signal receiving error) (Outdoor unit)</b></p> <p>(1) Abnormal if outdoor controller circuit board could not receive anything normally for 3 minutes.</p>	<p>① Contact failure of indoor/outdoor unit connecting wire</p> <p>② Defective communication circuit of outdoor controller circuit board</p> <p>③ Defective communication circuit of indoor controller board</p> <p>④ Noise has entered into indoor/outdoor unit connecting wire.</p>	<p>① Check disconnection or looseness of indoor/outdoor unit connecting wire of indoor or outdoor units.</p> <p>②~④ Turn the power off, and on again to check. Replace indoor controller board or outdoor controller circuit board if abnormality is displayed again.</p>
E9 (6841)	<p><b>Indoor/outdoor unit communication error (Transmitting error) (Outdoor unit)</b></p> <p>(1) Abnormal if "0" receiving is detected 30 times continuously though outdoor controller circuit board has transmitted "1".</p> <p>(2) Abnormal if outdoor controller circuit board could not find blank of transmission path for 3 minutes.</p>	<p>① Indoor/ outdoor unit connecting wire has contact failure.</p> <p>② Defective communication circuit of outdoor controller circuit board</p> <p>③ Noise has entered power supply.</p> <p>④ Noise has entered indoor/ outdoor unit connecting wire.</p>	<p>① Check disconnection or looseness of indoor/outdoor unit connecting wire.</p> <p>②~④ Turn the power off, and on again to check. Replace outdoor controller circuit board if abnormality is displayed again.</p>
EF (6607 or 6608)	<p><b>Non defined error code</b></p> <p>This code is displayed when non defined error code is received.</p>	<p>① Noise has entered transmission wire of remote controller.</p> <p>② Noise has entered indoor/ outdoor unit connecting wire.</p> <p>③ Outdoor unit is not a inverter models.</p> <p>④ Model name of remote controller is PAR-S25A.</p>	<p>①② Turn the power off, and on again to check. Replace indoor controller board or outdoor controller circuit board if abnormality is displayed again.</p> <p>③ Replace outdoor unit with inverter type outdoor unit.</p> <p>④ Replace remote controller with MA remote controller.</p>
Ed (0403)	<p><b>Serial communication error</b></p> <p>1. Abnormal if serial communication between outdoor controller circuit board and outdoor power circuit board is defective.</p> <p>2. Abnormal if communication between outdoor controller circuit board and M-NET board is not available.</p>	<p>① Breaking of wire or contact failure of connector CN2 between the outdoor controller circuit board and the outdoor power circuit board</p> <p>② Breaking of wire or contact failure of connector CN4 between the outdoor controller circuit board and the outdoor power circuit board</p> <p>③ Defective communication circuit of outdoor power circuit board</p> <p>④ Defective communication circuit of outdoor controller circuit board for outdoor power circuit board</p> <p>① Breaking of wire or contact failure of connector between outdoor controller circuit board and M-NET board</p> <p>② Contact failure of M-NET board power supply line</p> <p>③ Noise has entered into M-NET transmission wire.</p>	<p>①② Check connection of each connector CN2 and CN4 between the outdoor controller circuit board and the outdoor power circuit board.</p> <p>③ Replace outdoor power circuit board.</p> <p>④ Replace outdoor controller circuit board.</p> <p>① Check disconnection, looseness, or breaking of connection wire between outdoor controller circuit board (CNMNT) and M-NET board (CN5).</p> <p>② Check disconnection, looseness, or breaking of connection wire between outdoor controller circuit board (CNMNT) and M-NET board (CND).</p> <p>③ Check M-NET transmission wiring method.</p>



Error Code	Abnormal point and detection method	Case	Judgment and action
P8 (1110)	<p><b>Pipe temperature</b> &lt;Cooling mode&gt; Detected as abnormal when the pipe temperature is not in the cooling range 3 minutes after compressor start and 6 minutes after the liquid or condenser/evaporator pipe is out of cooling range. Note 1) It takes at least 9 minutes to detect. Note 2) Abnormality P8 is not detected in drying mode. Cooling range : Indoor pipe temperature (TH2 or TH5) – room temperature (TH1) <math>\leq -3^{\circ}\text{C}</math> TH: Lower temperature between liquid pipe temperature and condenser/evaporator temperature</p> <p>&lt;Heating mode&gt; When 10 seconds have passed after the compressor starts operation and the hot adjustment mode has finished, the unit is detected as abnormal when condenser/evaporator pipe temperature is not in heating range within 20 minutes. Note 3) It takes at least 27 minutes to detect abnormality. Note 4) It excludes the period of defrosting. (Detection restarts when defrosting mode is over) Heating range : <math>3^{\circ}\text{C} \leq</math> (Condenser/ Evaporator temperature(TH5) – room temperature(TH1))</p>	<p>① Slight temperature difference between indoor room temperature and pipe &lt;liquid or condenser / evaporator&gt; temperature thermistor</p> <ul style="list-style-type: none"> <li>• Shortage of refrigerant</li> <li>• Disconnected holder of pipe &lt;liquid or condenser / evaporator&gt; thermistor</li> <li>• Defective refrigerant circuit</li> </ul> <p>② Converse connection of extension pipe (on plural units connection)</p> <p>③ Converse wiring of indoor/outdoor unit connecting wire (on plural units connection)</p> <p>④ Defective detection of indoor room temperature and pipe &lt;condenser / evaporator&gt; temperature thermistor</p> <p>⑤ Stop valve is not opened completely.</p>	<p>①~④ Check pipe &lt;liquid or condenser / evaporator&gt; temperature with room temperature display on remote controller and outdoor controller circuit board. Pipe &lt;liquid or condenser / evaporator&gt; temperature display is indicated by setting SW2 of outdoor controller circuit board as follows.</p> <p>(Conduct temperature check with outdoor controller circuit board after connecting 'A-Control Service Tool(PAC-SK52ST)').</p> <p>A-Control Service Tool SW2 setting</p> <p>②③ Check converse connection of extension pipe or converse wiring of indoor/outdoor unit connecting wire.</p>

**<M-NET communication error>**

(Note) "Indoor unit" in the text indicates M-NET board in outdoor unit.

Error Code	Abnormal point and detection method	Case	Judgment and action
A0 (6600)	<p><b>Address duplicate definition</b> This error is displayed when transmission from the units of same address is detected. Note) The address and attribute displayed at remote controller indicate the controller that detected abnormality.</p>	<p>① There are 2 or more same address of controller of outdoor unit, indoor unit, FRESH MASTER, or LOSSNAY.</p> <p>② Noise has entered into transmission signal and signal was transformed.</p>	<p>Search the unit with same address as abnormality occurred. If the same address is found, turn the power supply of outdoor unit and indoor unit and FRESH MASTER or LOSSNAY at the same time for 2 minutes or more after the address is corrected, and turn the power on again. Check transmission waveform or noise on transmission wire.</p>
A2 (6602)	<p><b>Hardware error of transmission processor</b> Transmission processor intended to transmit "0", but "1" appeared on transmission wire. Note) The address and attribute displayed at remote controller indicate the controller that detected abnormality.</p>	<p>① Error is detected if waveform is transformed when wiring works of transmission wire of outdoor unit, indoor unit, FRESH MASTER or LOSSNAY are done, or polarity is changed with the power on and transmission data collide each other.</p> <p>② Defective transmitting receiving circuit of transmission processor</p> <p>③ Transmission data is changed by the noise on transmission.</p>	<p>① If the work of transmission wire is done with the power on, turn off the power supply of outdoor unit and indoor unit and FRESH MASTER or LOSSNAY at the same time for 2 minutes or more, and turn the power on again.</p> <p>② Check transmission waveform or noise on transmission wire.</p>
A3 (6603)	<p><b>BUS BUSY</b> 1. Overtime error by signal collision damage Abnormal if transmitting signal is not possible for 8-10 minutes continuously because of collision of transmission. 2. Data could not reach transmission wire for 8-10 minutes continuously because of noise or etc. Note) The address and attribute displayed at remote controller indicate the controller that detected abnormality.</p>	<p>① Transmission processor could not transmit signal because short cycle voltage of noise and the like have entered into transmission wire continuously.</p> <p>② Transmission quantity has increased and transmission of signal is not possible because there was wiring mistake of terminal block for transmission wire (TB3) and terminal block for central control (TB7) in outdoor unit.</p> <p>③ Transmission is mixed with others and occupation rate on transmission wire rose because of defective repeater (a function to connector or disconnect transmission of control and central control system) of outdoor unit, then abnormality is detected.</p>	<p>① Check if transmission wire of indoor unit, FRESH MASTER, LOSSNAY, or remote controller is not connected to terminal block for central control (TB7) of outdoor unit.</p> <p>② Check if transmission wire of indoor unit, FRESH MASTER or LOSSNAY is not connected to terminal block for transmission wire of outdoor unit.</p> <p>③ Check if terminal block for transmission wire (TB3) and terminal block for central control (TB7) is not connected.</p> <p>④ Check transmission waveform or noise on transmission wire.</p>



Error Code	Abnormal point and detection method	Case	Judgment and action
A6 (6606)	<p><b>Communication error with communication processor</b> Defective communication between unit processor and transmission processor Note) The address and attribute displayed at remote controller indicate the controller that detected abnormality.</p>	<p>① Data of transmission processor or unit processor is not transmitted normally because of accidental trouble such as noise or thunder surge. ② Address forwarding from unit processor is not transmitted normally because of defective transmission processor hardware.</p>	<p>Turn off the power supply of outdoor unit, indoor unit and FRESH MASTER or LOSSNAY at the same time for 2 minutes or more, and turn the power on again. System returns normally if abnormality was accidental malfunction. If the same abnormality generates again, abnormality-generated controller may be defective.</p>
A7 (6607)	<p><b>NO ACK signal</b> 1. Transmitting side controller detects abnormality if a message was transmitted but there is no reply (ACK) that a message was received. Transmitting side detects abnormality every 30 seconds, 6 times continuously. Note) The address and attribute displayed at remote controller indicate the controller that did not reply (ACK).</p> <p>2. If displayed address or attribute is outdoor unit, indoor unit detects abnormality when indoor unit transmits signal to outdoor unit and there was no reply (ACK).</p> <p>3. If displayed address or attribute is indoor unit, remote controller detects abnormality when remote controller transmits signal to indoor unit and there was no reply (ACK).</p>	<p>Common factor that has no relation with abnormality source ① The unit of former address does not exist as address switch has changed while the unit was energized. ② Extinction of transmission wire voltage and signal is caused by over-range transmission wire. • Maximum distance.....200m • Remote controller line (12m) ③ Extinction of transmission wire voltage and signal is caused by type-unmatched transmission wire. Type..... With shield wire- CVVS, CPEVS With normal wire (no shield)- VCTF, VCTFK, CVV  CVS, VVR, VVF, VCT Diameter....1.25mm<sup>2</sup> or more ④ Extinction of transmission wire voltage and signal is caused by over-numbered units. ⑤ Accidental malfunction of abnormality-detected controller (noise, thunder surge) ⑥ Defective of abnormality-generated controller</p> <p>① Contact failure of transmission wire of outdoor unit or indoor unit ② Disconnection of transmission connector (CN2M) of outdoor unit ③ Defective transmitting receiving circuit of outdoor unit or indoor unit</p> <p>① During group operation with indoor unit of multi-refrigerant system, if remote controller transmits signal to indoor unit while outdoor unit power supply of one refrigerant system is turned off or within 2 minutes of restart, abnormality is detected. ② Contact failure of transmission wire of remote controller or indoor unit ③ Disconnection of transmission connector (CN2M) of indoor unit ④ Defective transmitting receiving circuit of indoor unit or remote controller</p>	<p><b>Always try the followings when the error "A7" occurs.</b></p> <p>① Turn off the power supply of outdoor unit, indoor unit and FRESH MASTER or LOSSNAY at the same time for 2 minutes or more, and turn the power on again. If malfunction was accidental, the unit returns to normal. ② Check address switch of abnormality-generated address. ③ Check disconnection or looseness of abnormality-generated or abnormality-detected transmission wire (terminal block and connector) ④ Check if tolerance range of transmission wire is not exceeded. ⑤ Check if type of transmission wire is correct or not.</p> <p>If there were some trouble of ①-⑤ above, repair the defect, then turn off the power supply of outdoor unit, indoor unit and FRESH MASTER or LOSSNAY at the same time for 2 minutes or more, and turn the power on again. • If there was no trouble with ①-⑤ above in single refrigerant system (one outdoor unit), controller of displayed address or attribute is defective. • If there was no trouble with ①-⑤ above in different refrigerant system (2 or more outdoor units), judge with ⑥.</p> <p>⑥ If address of abnormality source is the address that should not exist, there is the unit that memorizes nonexistent address information. Delete useless address information with manual setting function of remote controller. Only the system FRESH MASTER or LOSSNAY are connected to, or the system that is equipped with group setting of different refrigerant system.</p> <p>If there was no trouble with ①-⑥ above, replace the controller board of displayed address or attribute. If the unit does not return to normal, multi-controller board of outdoor unit may be defective (repeater circuit). Replace multi-controller board one by one to check if the unit returns to normal.</p>

Continued to the next page

From the previous page

Error Code	Abnormal point and detection method	Case	Judgment and action
A7 (6607)	4. If displayed address or attribute is remote controller, indoor unit detects abnormality when indoor unit transmits signal to remote controller and there was no reply (ACK).	<ul style="list-style-type: none"> <li>① During group operation with indoor unit of multi- refrigerant system, if indoor unit transmit signal to remote controller while outdoor unit power supply of one refrigerant system is put off or within 2 minutes of restart, abnormality is detected.</li> <li>② Contact failure of transmission wire of remote controller or indoor unit</li> <li>③ Disconnection of transmission connector (CN2M) of indoor unit</li> <li>④ Defective transmitting receiving circuit of indoor unit or remote controller</li> </ul>	Same as mentioned in "A7" of the previous page
	5. If displayed address or attribute is FRESH MASTER, indoor unit detects abnormality when indoor unit transmits signal to FRESH MASTER and there was no reply (ACK).	<ul style="list-style-type: none"> <li>① During sequential operation of indoor unit and FRESH MASTER of other refrigerant system, if indoor unit transmits signal to FRESH MASTER while outdoor unit power supply of same refrigerant system with FRESH MASTER is turned off or within 2 minutes of restart, abnormality is detected.</li> <li>② Contact failure of transmission wire of indoor unit or FRESH MASTER</li> <li>③ Disconnection of transmission connector (CN2M) of indoor unit or FRESH MASTER</li> <li>④ Defective transmitting receiving circuit of indoor unit or FRESH MASTER</li> </ul>	
	6. If displayed address or attribute is LOSSNAY, indoor unit detects abnormality when indoor unit transmits signal to LOSSNAY and there was no reply (ACK).	<ul style="list-style-type: none"> <li>① If the power supply of LOSSNAY is off, indoor unit detects abnormality when it transmits signal to LOSSNAY.</li> <li>② During sequential operation of indoor unit and LOSSNAY of other refrigerant system, if indoor unit transmits signal to LOSSNAY while outdoor unit power supply of same refrigerant system with LOSSNAY is turned off or within 2 minutes of restart, abnormality is detected.</li> <li>③ Contact failure of transmission wire of indoor unit of LOSSNAY</li> <li>④ Disconnection of transmission connector (CN2M) of indoor unit</li> <li>⑤ Defective transmitting receiving circuit of indoor unit or LOSSNAY</li> </ul>	
	7. If displayed address or attribute is non-existent.	<ul style="list-style-type: none"> <li>① The unit of former address does not exist as address switch has changed while the unit was energized.</li> <li>② Abnormality is detected when indoor unit transmits signal because the address of FRESH MASTER and LOSSNAY are changed after sequential operation of FRESH MASTER and LOSSNAY by remote controller.</li> </ul>	

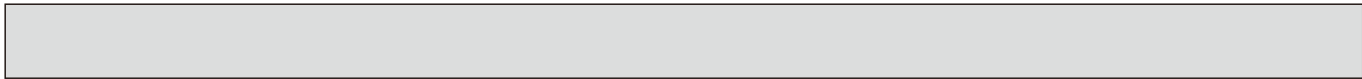

Error Code	Abnormal point and detection method	Case	Judgment and action
A8 (6608)	<p><b>M-NET NO RESPONSE</b> Abnormal if a message was transmitted and there were reply (ACK) that message was received, but response command does not return. Transmitting side detects abnormality every 30 seconds, 6 times continuously. Note) The address and attribute displayed at remote controller indicate the controller that did not reply (ACK).</p>	<p>① Transmitting condition is repeated fault because of noise and the like. ② Extension of transmission wire voltage and signal is caused by over-range transmission wire. • Maximum distance .....200m • Remote controller line (12m) ③ Extension of transmission wire voltage and signal is caused by type-unmatched transmission wire. Type..... With shield wire- CVVS, CPEVS With normal wire (no shield)- VCTF, VCTFK, CVV  CVS, VVR, VVF, VCT Diameter.....1.25mm<sup>2</sup> or more  ④ Accidental malfunction of abnormality-generated controller</p>	<p>① Check transmission waveform or noise on transmission wire. ② Turn off the power supply of outdoor unit and indoor unit and FRESH MASTER or LOSSNAY at the same time for 2 minutes or more, and turn the power on again. If malfunction was accidental, the unit returns to normal. If the same abnormality generates again, controller of displayed address and attribute may be defective.</p>

## 10-5. TROUBLESHOOTING BY INFERIOR PHENOMENA

Phenomena	Factor	Countermeasure
1. Remote controller display does not work.	<p>①DC12V is not supplied to remote controller. (Power supply display ● is not indicated on LCD.) ②DC12~15V is supplied to remote controller, however, no display is indicated. • "PLEASE WAIT" is not displayed. • "PLEASE WAIT" is displayed.</p>	<p>①Check LED2 on indoor controller board. (1) When LED2 is lit. Check the remote controller wiring for breaking or contact failure. (2) When LED2 is blinking. Check short circuit of remote controller wiring. (3) When LED2 is not lit. Refer to phenomena No.3 below. ②Check the following. • Failure of remote controller if "PLEASE WAIT" is not displayed • Refer to phenomena No.2 below if "PLEASE WAIT" is displayed.</p>
2. "PLEASE WAIT" display is remained on the remote controller.	<p>①At longest 2 minutes after the power supply "PLEASE WAIT" is displayed to start up. ②Communication error between the remote controller and indoor unit ③Communication error between the indoor and outdoor unit ④Outdoor unit protection device connector is open.</p>	<p>①Normal operation ②Self-diagnosis of remote controller ③"PLEASE WAIT" is displayed for 6 minutes at most in case of indoor/outdoor unit communication error. Check LED3 on indoor controller board. (1)When LED3 is not blinking. Check indoor/outdoor connecting wire for miswiring. (Converse wiring of S1 and S2, or break of S3 wiring.) (2)When LED3 is blinking. Indoor/outdoor connecting wire is normal. ④Check LED display on outdoor controller circuit board. Refer to 10-10. Check protection device connector (63H) for contact failure. Refer to 10-9.</p>
3. When pressing the remote controller operation switch, the OPERATION display is appeared but it will be turned off soon.	<p>①After cancelling to select function from the remote controller, the remote controller operation switch will not be accepted for approx. 30 seconds.</p>	<p>①Normal operation</p>

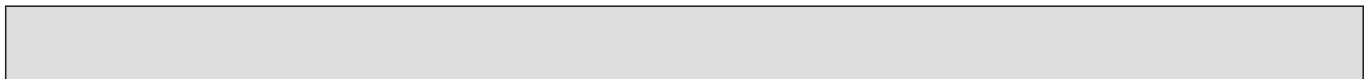

Phenomena	Factor	Countermeasure
4. Even controlled by the wireless remote controller, no beep is heard and the unit does not start operating. Operation display is indicated on wireless remote controller.	①The pair number settings of the wireless remote controller and indoor controller board are mismatched.	①Check the pair number settings.
5. When operating by the wireless remote controller, beep sound is heard, however, unit does not start operating.	①No operation for 2 minutes at most after the power supply ON. ②Local remote controller operation is prohibited. • Remote controlling adaptor is connected to CN32 on the indoor controller board. • Local remote controller operation is prohibited by centralised controller etc. since it is connected to MELANS. ③ Phenomena of No.2.	①②Normal operation  ③Check the phenomena of No.2.
6. Remote controller display works normally and the unit performs cooling operation, however, the capacity cannot be fully obtained. (The air is not cool enough.)	①Refrigerant shortage  ②Filter clogging  ③Heat exchanger clogging  ④Air duct short cycle	①• If refrigerant leaks, discharging temperature rises and LEV opening increases. Inspect leakage by checking the temperature and opening. • Check pipe connections for gas leakage. ②Open suction grille and check the filter. Clean the filter by removing dirt or dust on it. ③• If the filter is clogged, indoor pipe temperature rises and discharging pressure increases. Check if heat exchanger is clogged by inspecting discharging pressure. • Clean the heat exchanger. ④Remove the shield.
7. Remote controller display works normally and the unit performs heating operation, however, the capacity cannot be fully obtained.	①Linear expansion valve fault Opening cannot be adjusted well due to linear expansion valve fault.  ②Refrigerant shortage  ③Lack of insulation for refrigerant piping ④Filter clogging  ⑤Heat exchanger clogging  ⑥Air duct short cycle ⑦Bypass circuit of outdoor unit fault	①• Discharging temperature and indoor heat exchanger temperature does not rise. Inspect the failure by checking discharging pressure. • Replace linear expansion valve. ②• If refrigerant leaks, discharging temperature rises and LEV opening increases. Inspect leakage by checking the temperature and opening. • Check pipe connections for gas leakage. ③Check the insulation. ④Open suction grille and check the filter. Clean the filter by removing dirt or dust on it. ⑤• If the filter is clogged, indoor pipe temperature rises and discharging pressure increases. Check if heat exchanger is clogged by inspecting discharging pressure. • Clean the heat exchanger. ⑥Remove the shield. ⑦Check refrigerant system during operation.
8. ①For 3 minutes after temperature adjuster turns off, the compressor will not start operating even if temperature adjuster is turned on. ②For 3 minutes after temperature adjuster turns on, the compressor will not stop operating even if temperature adjuster is turned off. (Compressor stops operating immediately when turning off by the remote controller.)	①②Normal operation (For protection of compressor)	①②Normal operation

**Symptoms: "PLEASE WAIT" is kept being displayed on the remote controller.**

Diagnosis flow	Cause	Inspection method and troubleshooting
<pre> graph TD     Start[Check the display time of "PLEASE WAIT" after turning on the main power.] --&gt; D1{How long is "PLEASE WAIT" kept being displayed on the remote controller?}     D1 -- "6 minutes or more" --&gt; P1[Check the LED display of the outdoor controller circuit board.]     D1 -- "2 minutes or less" --&gt; C1[Cause]     D1 -- "2 to 6 minutes" --&gt; D2{Are any error codes displayed on the remote controller?}     D2 -- NO --&gt; C1     D2 -- YES --&gt; P1     P1 --&gt; D3{Are any error codes displayed on the LED?}     D3 -- YES --&gt; C2[Cause]     D3 -- NO --&gt; C3[Cause]     </pre>	<ul style="list-style-type: none"> <li>• "PLEASE WAIT" will be displayed during the start-up diagnosis after turning on the main power.</li> <li>• Miswiring of indoor/outdoor connecting wire</li> <li>• Breaking of indoor/outdoor connecting wire (S3)</li> <li>• Defective indoor controller board</li> <li>• Defective outdoor controller circuit board</li> <li>• Defective indoor controller board</li> <li>• Defective remote controller</li> </ul>	<ul style="list-style-type: none"> <li>• Normal. The start-up diagnosis will be over in around 2 minutes.</li> <li>• Refer to "Self-diagnosis action table" in order to solve the trouble.</li> <li>• In case of communication errors, the display of remote controller may not match the LED display of the outdoor unit.</li> </ul>



**Symptoms: Nothing is displayed on the remote controller ①**

LED display of the indoor controller board  
 LED1 : ○  
 LED2 : ○  
 LED3 : ○



Diagnosis flow	Cause	Inspection method and troubleshooting
<p>Check the voltage between S1 and S2 on the terminal block (TB4) of the indoor unit which is used to connect the indoor unit and the outdoor unit.</p> <p>AC 198V to AC 264V?</p> <p>NO</p> <p>Check the voltage among L(L<sub>3</sub>) and N on the terminal block (TB1) of the outdoor power circuit board.</p> <p>AC 198V to AC 264V?</p> <p>NO</p> <p>Check the voltage between S1 and S2 on the terminal block (TB1) of the outdoor unit which is used to connect the indoor unit and the outdoor unit.</p> <p>AC 198V to AC 264V?</p> <p>NO</p> <p>Check the voltage of indoor controller board (CN2D).</p> <p>DC 12V to DC 16V?</p> <p>NO</p> <p>Check the voltage of the unit after removing the indoor power board (CN2S).</p> <p>DC 12V to DC 16V?</p> <p>NO</p>	<p>• Troubles concerning power supply</p> <p>• Bad wiring of the outdoor controller board</p> <p>• The fuses on the outdoor controller circuit board are blown.</p> <p>• Bad wiring of the outdoor controller board</p> <p>• The fuses on the outdoor controller circuit board are blown.</p> <p>• Defective indoor controller board</p> <p>• Miswiring, breaking or poor connection of indoor/outdoor connecting wire</p> <p>• Defective indoor power board</p>	<p>• Check the power wiring to the outdoor unit.</p> <p>• Check the breaker.</p> <p>• Check the wiring of the outdoor unit.</p> <p>• Check if the wiring is bad. Check if the fuses are blown. The fuses on the outdoor controller circuit board will be blown when the indoor /outdoor connecting wire short-circuits.</p> <p>• Check if miswiring, breaking or poor contact is causing this problem. Indoor/outdoor connecting wire is polarized 3-core type. Connect the indoor unit and the outdoor unit by wiring each pair of S1, S2 and S3 on the both side of indoor/outdoor terminal blocks.</p> <p>• Replace the indoor controller board.</p> <p>• Check if there is miswiring or breaking of wire.</p> <p>• Replace the indoor power board.</p>

## Symptoms: Nothing is displayed on the remote controller ②

LED display of the indoor controller board





LED1 : 

LED2 : 

LED3 :  or 

Diagnosis flow	Cause	Inspection method and troubleshooting
<p>Check the voltage between S1 and S2 on the terminal block (TB4) of the indoor unit which is used to connect the indoor unit and the outdoor unit.</p> <p>AC 198V to AC 264V?</p> <p>NO</p> <p>YES</p> <p>Check the status of the indoor controller board LED3 display.</p> <p>Not lighting.</p> <p>Blinking.</p> <p>Check the looseness or disconnection of the indoor/outdoor connecting wire.</p> <p>Are there looseness or disconnection of the indoor/outdoor connecting wire?</p> <p>YES</p> <p>NO</p> <p>Check the refrigerant address of the outdoor unit. (SW1-3 to 1-6)</p> <p>Is the refrigerant address "0"?</p> <p>NO</p> <p>YES</p> <p>Check the LED display of the outdoor unit after turning on the main power again.</p> <p>Is anything displayed?</p> <p>Not displayed.</p> <p>Displayed.</p> <p>Is "EA" or "Eb" displayed?</p> <p>NO</p> <p>YES</p> <p>Is "E8" displayed?</p> <p>YES</p> <p>NO</p> <p>Can the unit be restarted?</p> <p>Can all the indoor unit be operated?</p> <p>NO</p> <p>YES</p> <p>Check the voltage between S2 and S3 on the terminal block of the outdoor unit.</p> <p>DC 17V to DC 28V?</p> <p>NO</p> <p>YES</p>	<ul style="list-style-type: none"> <li>• Breaking or poor contact of the indoor/outdoor connecting wire</li> <li>• Normal Only the unit which has the refrigerant address "0" supplies power to the remote controller.</li> <li>• Defective outdoor controller circuit board</li> <li>• Defective outdoor controller circuit board</li> <li>• Defective indoor controller board</li> <li>• Influence of electromagnetic noise</li> <li>• Defective outdoor power circuit board</li> <li>• Defective indoor power board</li> </ul>	<ul style="list-style-type: none"> <li>• Fix the breaking or poor contact of the indoor/outdoor connecting wire.</li> <li>• Set the refrigerant address to "0". In case of the multiple grouping system, recheck the refrigerant address again.</li> <li>• Replace the outdoor controller circuit board.</li> <li>• Replace the outdoor controller circuit board.</li> <li>• Replace the indoor controller board of the indoor unit which doesn't operate.</li> <li>• Not abnormal. There may be the influence of electromagnetic noise. Check the transmission wire and get rid of the causes.</li> <li>• Replace the outdoor power circuit board.</li> <li>• Replace the indoor power board.</li> </ul>

**Symptoms: Nothing is displayed on the remote controller ③**

LED display of the indoor controller board  
 LED1 :   
 LED2 :  or   
 LED3 : 

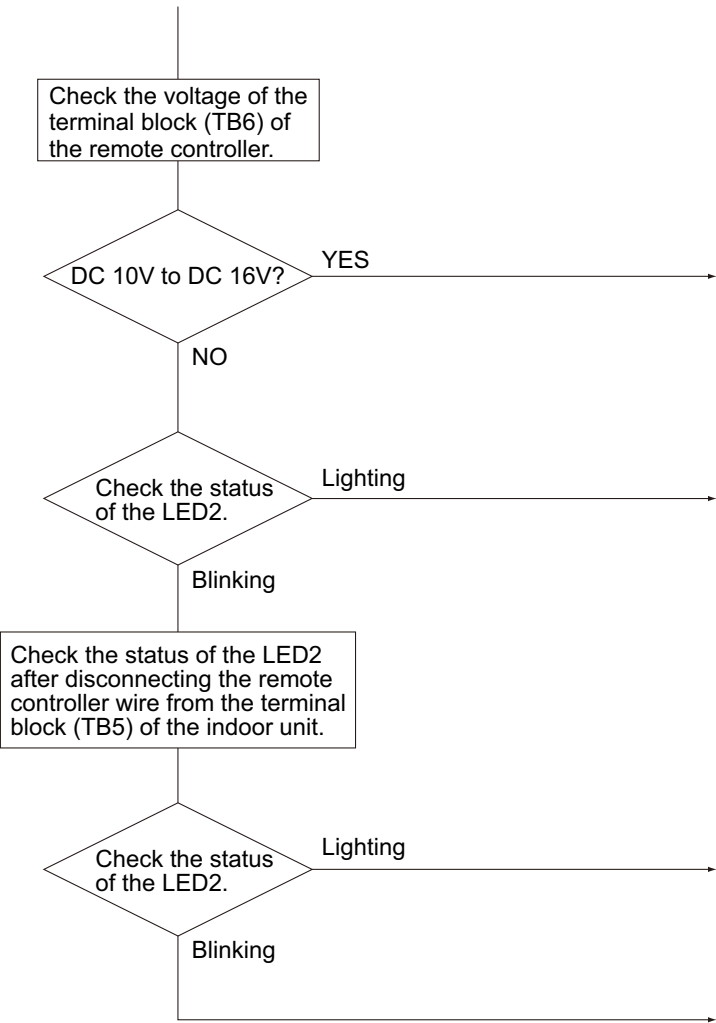
Diagnosis flow	Cause	Inspection method and troubleshooting
 <pre>                     graph TD                         Start(( )) --&gt; Step1[Check the voltage of the terminal block (TB6) of the remote controller.]                         Step1 --&gt; Dec1{DC 10V to DC 16V?}                         Dec1 -- YES --&gt; Cause1[Defective remote controller]                         Dec1 -- NO --&gt; Step2{Check the status of the LED2.}                         Step2 -- Lighting --&gt; Cause2[Breaking or poor contact of the remote controller wire]                         Step2 -- Blinking --&gt; Step3[Check the status of the LED2 after disconnecting the remote controller wire from the terminal block (TB5) of the indoor unit.]                         Step3 --&gt; Dec2{Check the status of the LED2.}                         Dec2 -- Lighting --&gt; Cause3[The remote controller wire short-circuits]                         Dec2 -- Blinking --&gt; Cause4[Defective indoor controller board]                     </pre>	<ul style="list-style-type: none"> <li>• Defective remote controller</li> <li>• Breaking or poor contact of the remote controller wire</li> <li>• The remote controller wire short-circuits</li> <li>• Defective indoor controller board</li> </ul>	<ul style="list-style-type: none"> <li>• Replace the remote controller.</li> <li>• Check if there is breaking or poor contact of the remote controller wire. Check the voltage of the terminal block (TB5) connecting the remote controller wire. If it is not between DC 10V and DC16V, the indoor controller board must be defective.</li> <li>• Check if the remote controller wire is short-circuited.</li> <li>• Replace the indoor controller board.</li> </ul>

• Before repair

Frequent calling from customers

Phone Calls From Customers	How to Respond	Note	
Unit does not operate at all.	① The operating display of remote controller does not come on.	① Check if power is supplied to air conditioner. Nothing appears on the display unless power is supplied.	_____
	② Unit cannot be restarted for a while after it's stopped.	② Wait around 3 minutes to restart unit. The air conditioner is in a state of being protected by the microcomputer's directive. Once the compressor is stopped, the unit cannot be restarted for 3 minutes. This control is also applied when the unit is turned on and off by remote controller.	_____
	③ Error code appears and blinks on the display of remote controller.	③ Error code will be displayed if any protection devices of the air conditioner are actuated. What is error code? -----	Refer to "SELF-DIAGNOSIS ACTION TABLE". ▶Check if servicing is required for the error.
Remote controller	① "PLEASE WAIT" is displayed on the screen.	① Wait around 2 minutes. An automatic startup test will be conducted for 2 minutes when power is supplied to the air conditioner. "PLEASE WAIT" will be kept being displayed while that time.	_____
	② "FILTER" is displayed on the screen.	② This indicates that it is time to clean the air filters. Clean the air filters. Press the FILTER button on the remote controller twice to clear "FILTER" from the display. See the operation manual that came with the product for how to clean the filters.	Display time of "FILTER" depends on the model. Long life filter: 2500 hrs. Regular filter: 100 hrs.
	③ "STANDBY" is displayed on the screen.	③ This is displayed when the unit starts HEAT operation, when the thermostat puts the compressor in operation mode, or when the outdoor unit ends DEFROST operation and returns to HEAT operation. The display will automatically disappear around 10 minutes later. While "STANDBY" is displayed on the remote controller, the airflow amount will be restricted because the indoor unit's heat exchanger is not fully heated up. In addition to that, the up/down vane will be automatically set to horizontal blow in order to prevent cold air from directly blowing out to human body. The up/down vane will return to the setting specified by the remote controller when "STANDBY" is released.	_____
	④ "DEFROST" is displayed on the screen. (No air comes out of the unit.)	④ The outdoor unit gets frosted when the outside temperature is low and the humidity is high. "DEFROST" indicates the DEFROST operation is being performed to melt this frost. The DEFROST operation ends in around 10 minutes (at most 15 minutes). During the DEFROST operation, the indoor unit's heat exchanger becomes cold, so the fan is stopped. The up/down vane will be automatically set to horizontal blow in order to prevent cold air from directly blowing out to human body. The display will turn into "STANDBY" when DEFROST operation ends.	_____



Phone Calls From Customers		How to Respond	Note
The room cannot be cooled or heated sufficiently.		① Check the set temperature of remote controller. The outdoor unit cannot be operated if the set temperature is not appropriate. The outdoor unit operates in the following modes. COOL: When the set temperature is lower than the room temperature. HEAT: When the set temperature is higher than the room temperature.	_____
		② Check if filters are dirty and clogged. If filters are clogged, the airflow amount will be reduced and the unit capacity will be lowered. See the instruction manual that came with the product for how to clean the filters.	_____
		③ Check there is enough space around the air conditioner. If there are any obstacles in the air intake or air outlet of indoor/outdoor units, they block the airflow direction so that the unit capacity will be lowered.	_____
Sound comes out from the air conditioner.	① An gas escaping sound is heard sometimes.	① This is not a malfunction. This is the sound which is heard when the flow of refrigerant in the air conditioner is switched.	_____
	② A cracking sound is heard sometimes.	② This is not a malfunction. This is the sound which is heard when internal parts of units expand or contract when the temperature changes.	_____
	③ A buzzing sound is heard sometimes.	③ This is not a malfunction. This is the sound which is heard when the outdoor unit starts operating.	_____
	④ A ticking sound is heard from the outdoor unit sometimes.	④ This is not a malfunction. This is the sound which is heard when the fan of the outdoor unit is controlling the airflow amount in order to keep the optimum operating condition.	_____
	⑤ A sound, similar to water flowing, is heard from the unit.	⑤ This is not a malfunction. This is the sound which is heard when the refrigerant is flowing inside the indoor unit.	_____
Something is wrong with the blower.....	① The fan speed doesn't match the setting of the remote controller during DRY operation.(No air comes out sometimes during DRY operation.)	① This is not a malfunction. During the DRY operation, the blower's ON/OFF is controlled by the microcomputer to prevent overcooling and to ensure efficient dehumidification. The fan speed cannot be set by the remote controller during DRY operation.	_____
	② The fan speed doesn't match the setting of the remote controller in HEAT operation.	② This is not a malfunction. 1) When the HEAT operation starts, to prevent the unit from blowing cold air, the fan speed is gradually increased from zero to the set speed, in proportion to the temperature rise of the discharged air. 2) When the room temperature reaches the set temperature and the outdoor unit stops, the unit starts the LOW AIR operation. 3) During the HEAT operation, the DEFROST operation is performed to defrost the outdoor unit. During the DEFROST operation, the blower is stopped to prevent cold air coming out of the indoor unit.	The up/down vane will be automatically set to horizontal blow in these cases listed up on the left ( 1)~3)). After a while, the up/down vane will be automatically moved according to the setting of the remote controller.

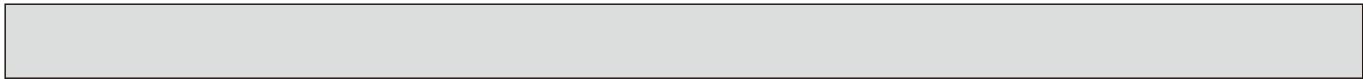

Phone Calls From Customers		How to Respond	Note
Something is wrong with the blower....	③ Air blows out for a while after HEAT operation is stopped.	③ This is not a malfunction. The blower is operating just for cooling down the heated-up air conditioner. This will be done within 1 minute. This control is conducted only when the HEAT operation is stopped with the electric heater ON.	However, this control is also applied to the models which has no electric heater.
Something is wrong with the airflow direction ....	① The airflow direction is changed during COOL operation.	① If the up/down vane is set to downward in COOL operation, it will be automatically set to horizontal blow by the microcomputer in order to prevent water from dropping down. "1 Hr." will be displayed on the remote controller if the up/down vane is set to downward with the fan speed set to be less than "LOW".	_____
	② The airflow direction is changed during HEAT operation.(The airflow direction cannot be set by remote controller.)	② In HEAT operation, the up/down vane is automatically controlled according to the temperature of the indoor unit's heat exchanger. In the following cases written below, the up/down vane will be set to horizontal blow, and the setting cannot be changed by remote controller. 1) At the beginning of the HEAT operation 2) While the outdoor unit is being stopped by thermostat or when the outdoor unit gets started to operate. 3) During DEFROST operation The airflow direction will be back to the setting of remote controller when the above situations are released.	"STANDBY" will be displayed on the remote controller in case of 1) and 2) "DEFROST" will be displayed on the screen in case of 3).
	③ The airflow direction doesn't change.(Up/down vane, left/right louver)	③ 1) Check if the vane is set to a fixed position. (Check if the vane motor connector is removed.) 2) Check if the air conditioner has a function for switching the air direction. 3) If the air conditioner doesn't have that function, "NOT AVAILABLE" will be displayed on the remote controller when "AIR DIRECTION" or "LOUVER" button is pressed.	_____
The air conditioner starts operating even though any buttons on the remote controller are not pressed.	① Check if you set ON/OFF timer. The air conditioner starts operating at the time designated if ON timer has been set before.	_____	
	② Check if any operations are ordered by distant control system or the central remote controller. While "CENTRALLY CONTROLLED INDICATOR" is displayed on the remote controller, the air conditioner is under the control of external directive.	There might be a case that "CENTRALLY CONTROLLED INDICATOR" will not be displayed.	
	③ Check if power is recovered from power failure (black out). The units will automatically start operating when power is recovered after power failure (black out) occurs. This function is called "power failure automatic recovery".	_____	
The air conditioner stops even though any buttons on the remote controller are not pressed.	① Check if you set ON/OFF timer. The air conditioner stops operating at the time designated if OFF timer has been set before. ② Check if any operations are ordered by distant control system or the central remote controller. While "CENTRALLY CONTROLLED INDICATOR" is displayed on the remote controller, the air conditioner is under the control of external directive.	There might be a case that "CENTRALLY CONTROLLED INDICATOR" will not be displayed.	

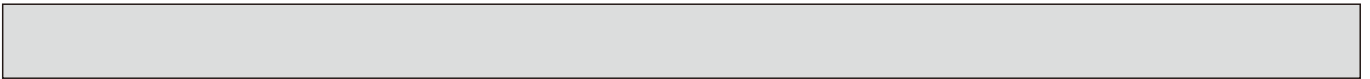

Phone Calls From Customers	How to Respond	Note
A white mist is expelled from the indoor unit.	This is not a malfunction. This may occur when the operation gets started in the room of high humidity.	_____
Water or moisture is expelled from the outdoor unit.	Cooling; when pipes or piping joints are cooled, they get sweated and water drips down. Heating; water drips down from the heat exchanger. * Make use of optional parts "Drain Socket" and "Drain pan" if these water needs to be collected and drained out for once.	_____
The display of wireless remote controller gets dim or doesn't come on. The indoor unit doesn't receive a signal from remote controller at a long distance.	Batteries are being exhausted. Replace them and press the reset button of remote controller.	_____

## 10-6. HOW TO CHECK THE PARTS

### PUHZ-RP200YHA2 PUHZ-RP250YHA2

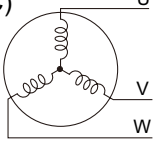
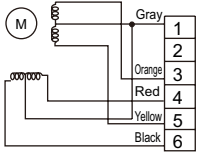
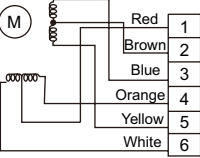
Parts name	Check points														
Thermistor (TH3) <Outdoor pipe> Thermistor (TH4) <Discharge> Thermistor (TH6) <Outdoor 2-phase pipe> Thermistor (TH7) <Outdoor>	Disconnect the connector then measure the resistance with a tester. (At the ambient temperature 10°C ~30°C) <table border="1" style="margin-top: 10px;"> <thead> <tr> <th></th> <th>Normal</th> <th>Abnormal</th> </tr> </thead> <tbody> <tr> <td>TH4</td> <td>160kΩ~410kΩ</td> <td rowspan="4">Open or short</td> </tr> <tr> <td>TH3</td> <td rowspan="3">4.3kΩ~9.6kΩ</td> </tr> <tr> <td>TH6</td> </tr> <tr> <td>TH7</td> </tr> </tbody> </table>		Normal	Abnormal	TH4	160kΩ~410kΩ	Open or short	TH3	4.3kΩ~9.6kΩ	TH6	TH7				
	Normal	Abnormal													
TH4	160kΩ~410kΩ	Open or short													
TH3	4.3kΩ~9.6kΩ														
TH6															
TH7															
Fan motor(MF1,MF2)	Refer to next page.														
4-way valve coil (21S4)	Measure the resistance between the terminals with a tester. (At the ambient temperature 20°C) <table border="1" style="margin-top: 10px;"> <thead> <tr> <th>Normal</th> <th>Abnormal</th> </tr> </thead> <tbody> <tr> <td>1435±150Ω</td> <td>Open or short</td> </tr> </tbody> </table>	Normal	Abnormal	1435±150Ω	Open or short										
Normal	Abnormal														
1435±150Ω	Open or short														
Compressor (MC) 	Measure the resistance between the terminals with a tester. (Winding temperature 20°C) <table border="1" style="margin-top: 10px;"> <thead> <tr> <th>Normal</th> <th>Abnormal</th> </tr> </thead> <tbody> <tr> <td>0.30Ω</td> <td>Open or short</td> </tr> </tbody> </table>	Normal	Abnormal	0.30Ω	Open or short										
Normal	Abnormal														
0.30Ω	Open or short														
Linear expansion valve (LEV-A) RP200 	Disconnect the connector then measure the resistance with a tester. (Winding temperature 20°C) <table border="1" style="margin-top: 10px;"> <thead> <tr> <th colspan="4">Normal</th> <th>Abnormal</th> </tr> </thead> <tbody> <tr> <td>Gray - Black</td> <td>Gray - Red</td> <td>Gray - Yellow</td> <td>Gray - Orange</td> <td rowspan="2">Open or short</td> </tr> <tr> <td colspan="4">46±3Ω</td> </tr> </tbody> </table>	Normal				Abnormal	Gray - Black	Gray - Red	Gray - Yellow	Gray - Orange	Open or short	46±3Ω			
Normal				Abnormal											
Gray - Black	Gray - Red	Gray - Yellow	Gray - Orange	Open or short											
46±3Ω															
Linear expansion valve ( LEV-A, LEV-B) RP250 	Disconnect the connector then measure the resistance with a tester. (Winding temperature 20°C) <table border="1" style="margin-top: 10px;"> <thead> <tr> <th colspan="4">Normal</th> <th>Abnormal</th> </tr> </thead> <tbody> <tr> <td>Red - White</td> <td>Red - Orange</td> <td>Brown - Yellow</td> <td>Brown - Blue</td> <td rowspan="2">Open or short</td> </tr> <tr> <td colspan="4">46±4Ω</td> </tr> </tbody> </table>	Normal				Abnormal	Red - White	Red - Orange	Brown - Yellow	Brown - Blue	Open or short	46±4Ω			
Normal				Abnormal											
Red - White	Red - Orange	Brown - Yellow	Brown - Blue	Open or short											
46±4Ω															
Bypass valve coil (SV)	Measure the resistance between the terminals with a tester. (At the ambient temperature 20°C) <table border="1" style="margin-top: 10px;"> <thead> <tr> <th>Normal</th> <th>Abnormal</th> </tr> </thead> <tbody> <tr> <td>1197±10Ω</td> <td>Open or short</td> </tr> </tbody> </table>	Normal	Abnormal	1197±10Ω	Open or short										
Normal	Abnormal														
1197±10Ω	Open or short														



## Check method of DC fan motor (fan motor / outdoor controller circuit board)

### ① Notes

- High voltage is applied to the connector (CNF1, 2) for the fan motor. Give attention to the service.
- Do not pull out the connector (CNF1, 2) for the motor with the power supply on.  
(It causes trouble of the outdoor controller circuit board and fan motor.)

### ② Self check

Symptom : The outdoor fan cannot turn around.

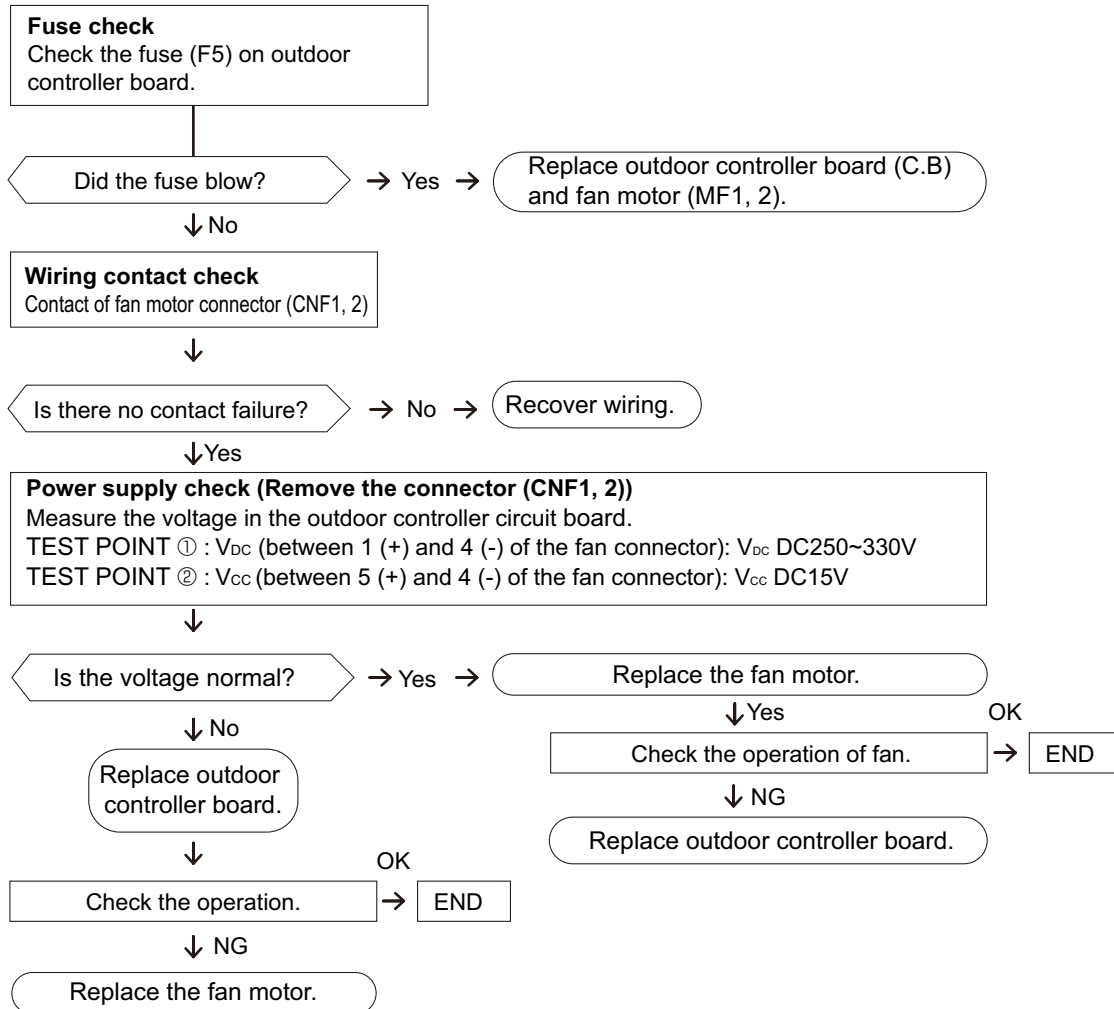

## 10-7. HOW TO CHECK THE COMPONENTS

<Thermistor feature chart>

### Low temperature thermistors

- Thermistor <Outdoor pipe> (TH3)
- Thermistor <Outdoor 2-phase pipe> (TH6)
- Thermistor <Outdoor> (TH7)

Thermistor R0 = 15kΩ ± 3%

B constant = 3480 ± 2%

$$R_t = 15 \exp\left\{3480 \left( \frac{1}{273+t} - \frac{1}{273} \right)\right\}$$

0°C	15kΩ	30°C	4.3kΩ
10°C	9.6kΩ	40°C	3.0kΩ
20°C	6.3kΩ		
25°C	5.2kΩ		

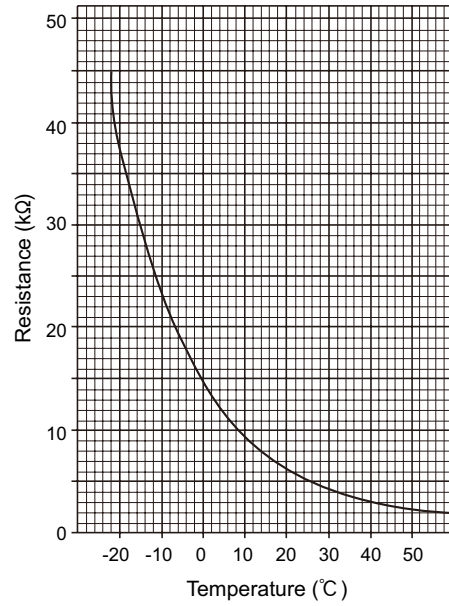

### High temperature thermistor

- Thermistor <Discharge> (TH4)

Thermistor R120 = 7.465kΩ ± 2%

B constant = 4057 ± 2%

$$R_t = 7.465 \exp\left\{4057 \left( \frac{1}{273+t} - \frac{1}{393} \right)\right\}$$

20°C	250kΩ	70°C	34kΩ
30°C	160kΩ	80°C	24kΩ
40°C	104kΩ	90°C	17.5kΩ
50°C	70kΩ	100°C	13.0kΩ
60°C	48kΩ	110°C	9.8kΩ

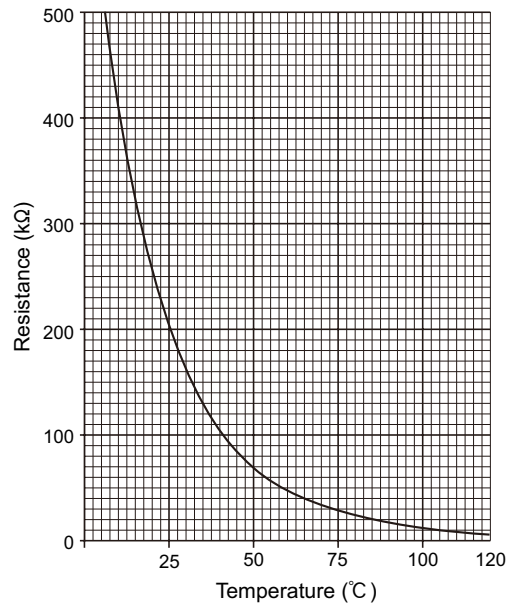

## Linear expansion valve (RP200)

### (1) Operation summary of the linear expansion valve

- Linear expansion valve opens/closes through stepping motor after receiving the pulse signal from the outdoor controller board.
  - Valve position can be changed in proportion to the number of pulse signal.
- <Connection between the indoor controller board and the linear expansion valve>

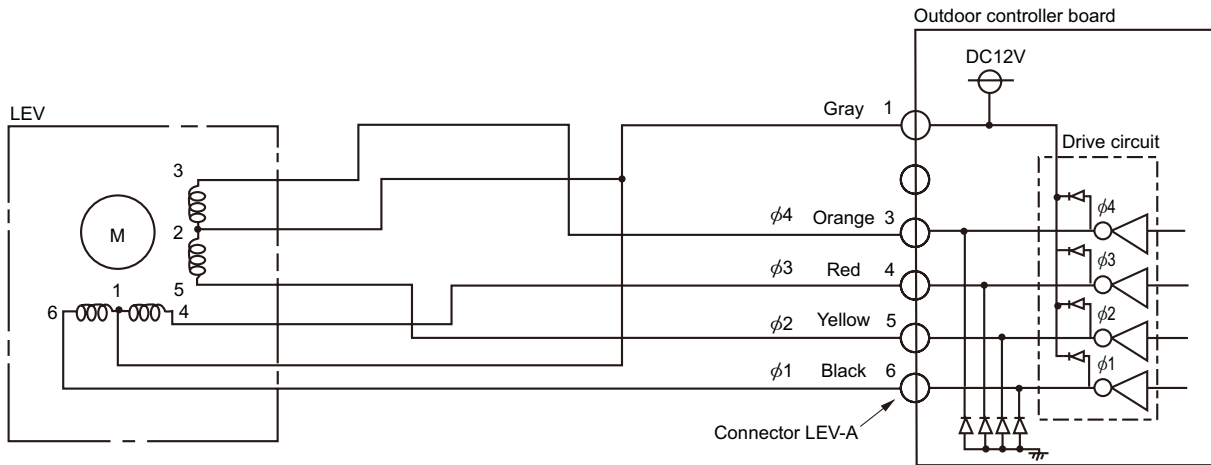

### <Output pulse signal and the valve operation>

Output (Phase)	Output							
	1	2	3	4	5	6	7	8
φ1	ON	ON	OFF	OFF	OFF	OFF	OFF	ON
φ2	OFF	ON	ON	ON	OFF	OFF	OFF	OFF
φ3	OFF	OFF	OFF	ON	ON	ON	OFF	OFF
φ4	OFF	OFF	OFF	OFF	OFF	ON	ON	ON

Opening a valve : 8 → 7 → 6 → 5 → 4 → 3 → 2 → 1 → 8

Closing a valve : 1 → 2 → 3 → 4 → 5 → 6 → 7 → 8 → 1

The output pulse shifts in above order.

- When linear expansion valve operation stops, all output phase become OFF.

### (2) Linear expansion valve operation

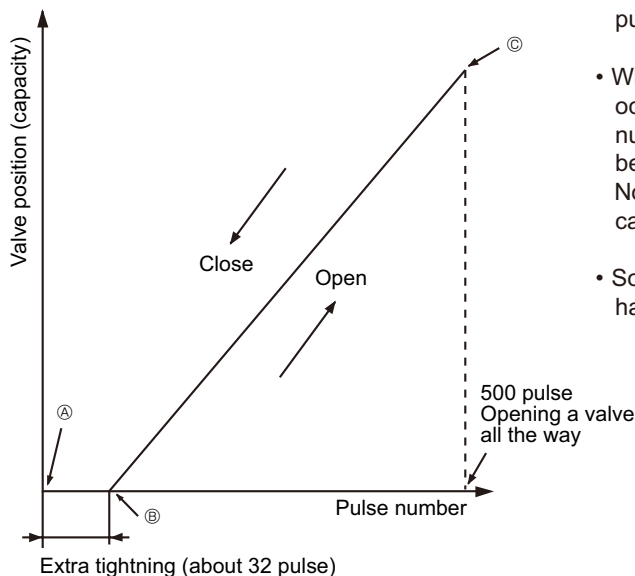

- When the switch is turned on, 700 pulse closing valve signal will be sent till it goes to (A) point in order to define the valve position. (The pulse signal is being sent for about 20 seconds.)
- When the valve moves smoothly, there is no sound or vibration occurring from the linear expansion valve ; however, when the pulse number moves from (B) to (A) or when the valve is locked, sound can be heard.  
No sound is heard when the pulse number moves from (B) to (A) in case coil is burnt out or motor is locked by open-phase.
- Sound can be detected by placing the ear against the screw driver handle while putting the screw driver to the linear expansion valve.

## Linear expansion valve (RP250)

### (1) Operation summary of the linear expansion valve.

- Linear expansion valve open/close through stepping motor after receiving the pulse signal from the outdoor controller circuit board.
- Valve position can be changed in proportion to the number of pulse signal.

<Connection between the indoor controller circuit board and the linear expansion valve>

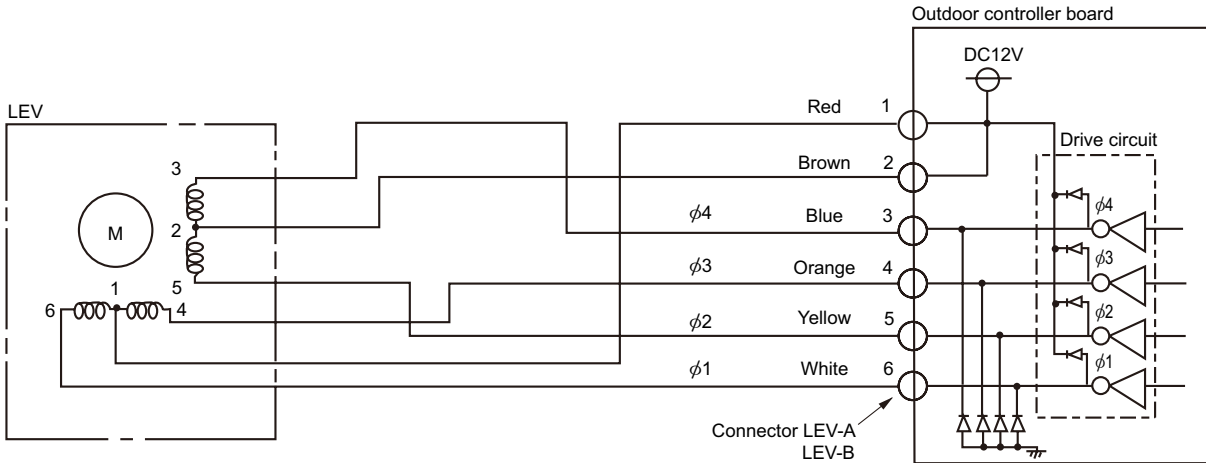

### <Output pulse signal and the valve operation>

Output (Phase)	Output							
	1	2	3	4	5	6	7	8
$\phi 1$	ON	ON	OFF	OFF	OFF	OFF	OFF	ON
$\phi 2$	OFF	ON	ON	ON	OFF	OFF	OFF	OFF
$\phi 3$	OFF	OFF	OFF	ON	ON	ON	OFF	OFF
$\phi 4$	OFF	OFF	OFF	OFF	OFF	ON	ON	ON

Opening a valve : 8 → 7 → 6 → 5 → 4 → 3 → 2 → 1 → 8

Closing a valve : 1 → 2 → 3 → 4 → 5 → 6 → 7 → 8 → 1

The output pulse shifts in above order.

- When linear expansion valve operation stops, all output phase become OFF.

### (2) Linear expansion valve operation

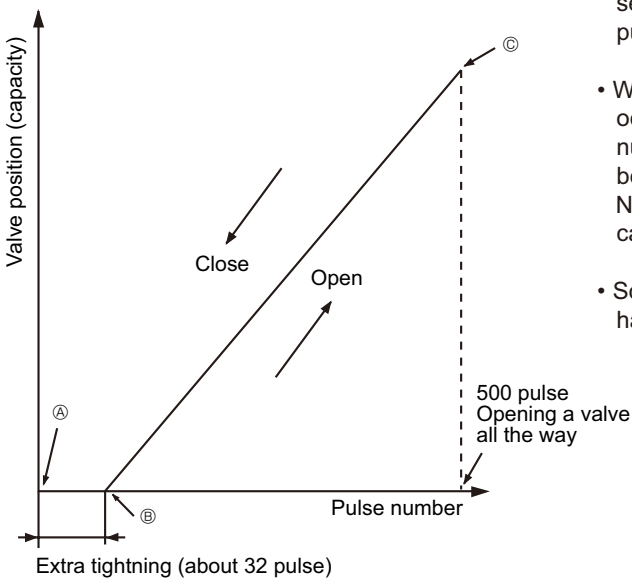

- When the switch is turned on, 700 pulse closing valve signal will be sent till it goes to A point in order to define the valve position. (The pulse signal is being sent for about 20 seconds.)
- When the valve moves smoothly, there is no sound or vibration occurring from the linear expansion valve ; however, when the pulse number moves from C to A or when the valve is locked, sound can be heard.  
No sound is heard when the pulse number moves from C to A in case coil is burnt out or motor is locked by open-phase.
- Sound can be detected by placing the ear against the screw driver handle while putting the screw driver to the linear expansion valve.

### (3) How to attach and detach the coil of linear expansion valve(RP200)

<Composition>

Linear expansion valve is separable into the main body and the coil as shown in the diagram below.

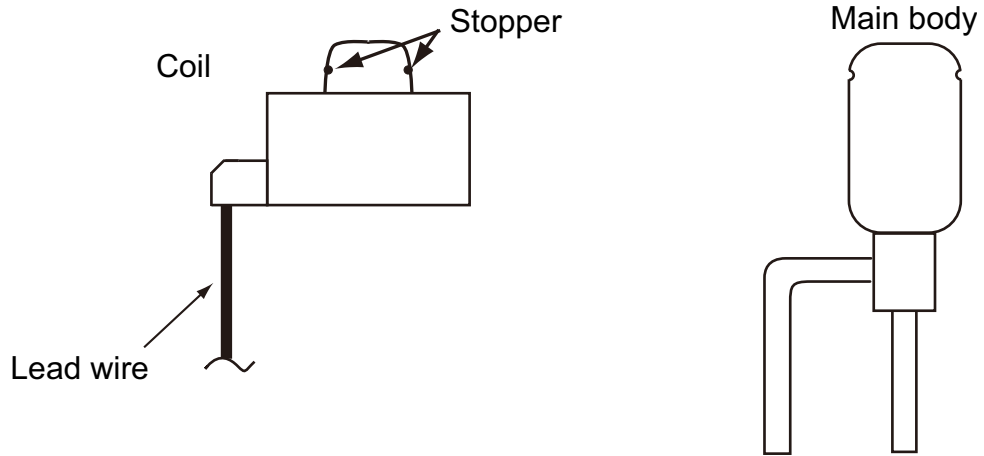

#### <How to detach the coil>

Hold the lower part of the main body (shown as A) firmly so that the main body does not move and detach the coil by pulling it upward.

Be sure to detach the coil holding main body firmly. Otherwise pipes can bend due to pressure.

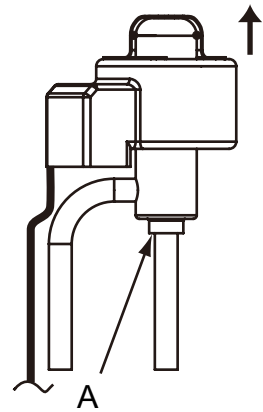

#### <How to attach the coil>

Hold the lower part of the main body (shown as A) firmly so that the main body does not move and attach the coil by inserting it downward into the main body. Then securely attach the coil stopper to main body. (At this time, be careful that stress is not added to lead wire and main body is not wounded by lead wire.) If the stopper is not firmly attached to main body, coil may be detached from the main body and that can cause defective operation of linear expansion valve.

To prevent piping stress, be sure to attach the coil holding the main body of linear expansion valve firmly. Otherwise pipe may break.

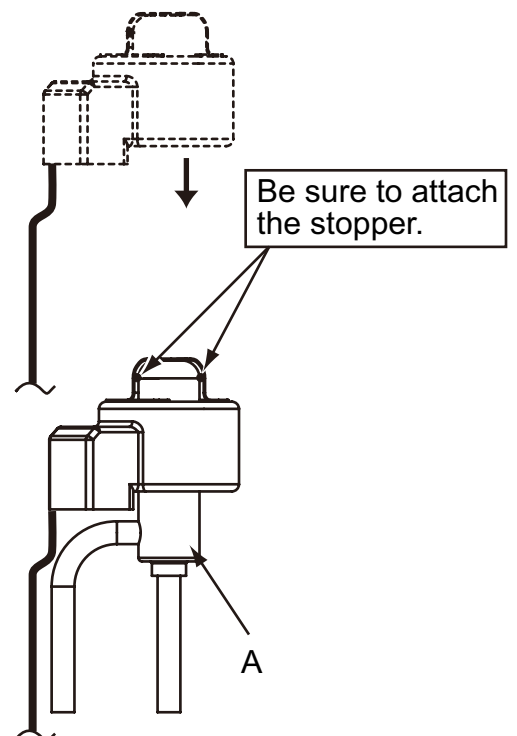

#### (4) How to attach and detach the coil of linear expansion valve(RP250)

<Composition>

Linear expansion valve is separable into the main body and the coil as shown in the diagram below.

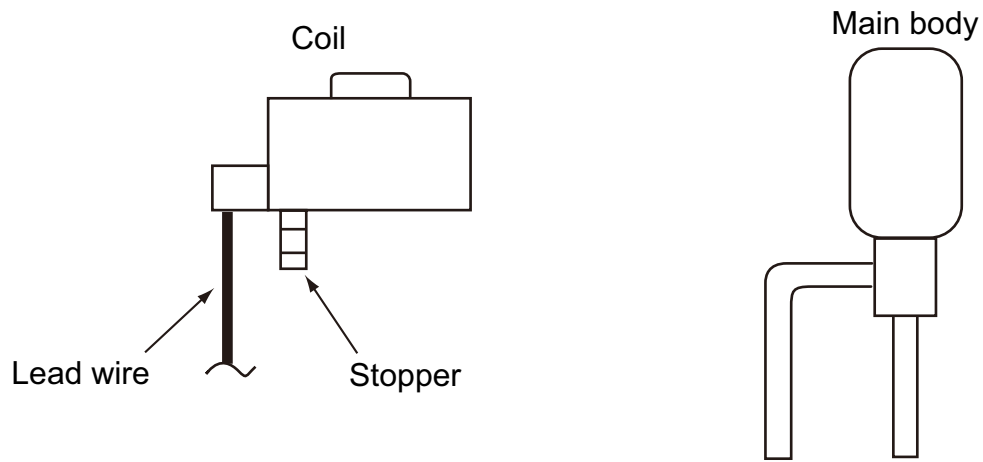

##### <How to detach the coil>

Hold the lower part of the main body (shown as A) firmly so that the main body does not move and detach the coil by pulling it upward.

Be sure to detach the coil holding main body firmly. Otherwise pipes can bend due to pressure.

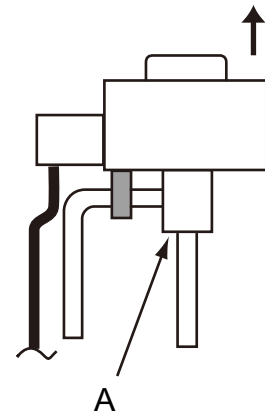

##### <How to attach the coil>

Hold the lower part of the main body (shown as A) firmly so that the main body does not move and attach the coil by inserting it downward into the main body. Then securely attach the coil stopper to pipe B. (At this time, be careful that stress is not added to lead wire and main body is not wound by lead wire.) If the stopper is not firmly attached to pipe B, coil may be detached from the main body and that can cause defective operation of linear expansion valve.

To prevent piping stress, be sure to attach the coil holding the main body of linear expansion valve firmly. Otherwise pipe may break.

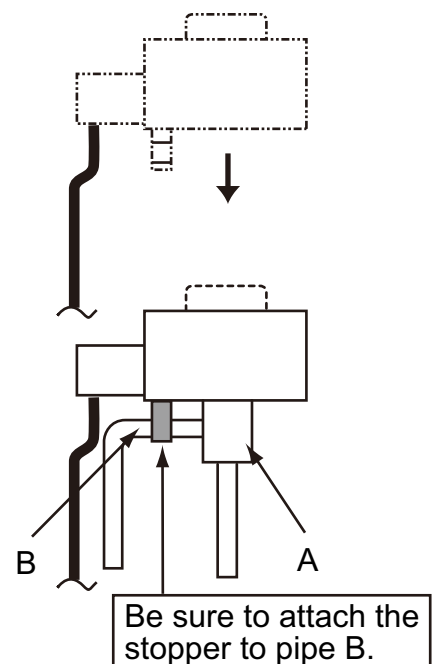

## 10-8. EMERGENCY OPERATION

(1) When the error codes shown below are displayed on outdoor unit or microcomputer for wired remote controller or indoor unit has a failure, but no other problems are found, emergency operation will be available by setting the emergency operation switch (SWE) to ON and short-circuiting the connector (CN31) on outdoor controller board.

- When following abnormalities occur, emergency operation will be available.

Error code	Inspected content
U4	Open/short of pipe thermistor (TH3/TH6)
E8	Indoor/outdoor unit communication error •Signal receiving error (Outdoor unit)
E9	Indoor/outdoor unit communication error •Transmitting error (Indoor unit)
E0 ~ E7	Communication error other than outdoor unit
Ed	Communication error between outdoor controller board and M-NET board (Serial communication error)

### (2) Check the following items and cautions for emergency operation

- ① Make sure that there is no abnormality in outdoor unit other than the above abnormalities. (Emergency operation will not be available when error code other than the above are indicated.)
- ② For emergency operation, it is necessary to set the emergency operation switch (SWE) on indoor controller board. Refer to the electrical wiring diagram of indoor unit for how to set the indoor unit.
- ③ During emergency operation, the air-conditioner will continuously be operated by supplying power and stopping it; it can not be turned on or off by remote control, and temperature control is not possible.
- ④ Do not perform emergency heating operation for an extended period of time; if the outdoor unit starts defrosting during this period, cold air will blow out from the indoor unit.
- ⑤ Do not perform emergency cooling operation for more than 10 hours; neglecting this could result in freezing the heat exchanger in indoor unit.

### (3) Emergency operation procedure

- ① Turn the main power supply off.
- ② Turn on the emergency operation switch (SWE) on indoor controller board.
- ③ Set the shorting pins of emergency operation connector (CN31) on outdoor controller board to ON.
- ④ Use SW4-2 on outdoor controller board to set the operation mode (cooling or heating). (SW4-1 is not used.)

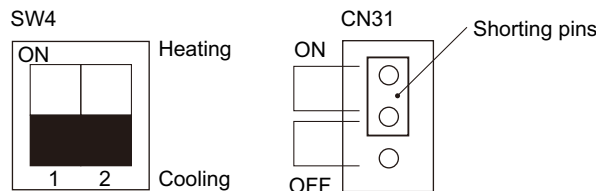

- ⑤ Turning the main power supply on will start the emergency operation.

### (4) Releasing emergency operation

- ① Turn the main power supply off.
- ② Set the emergency operation switch (SWE) on indoor controller board to OFF.
- ③ Set the shorting pins of emergency operation connector (CN31) on outdoor controller board to OFF.
- ④ Set SW4-2 on outdoor controller board as shown in the right.

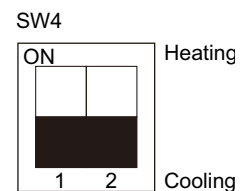

\*If shorting pins are not set on emergency operation connector (CN31), the setting remains OFF.

### (5) Operation data during emergency operation

During emergency operation, no communication is performed with the indoor unit, so the data items needed for operation are set to the following values:

Operation data	Operation mode		Remarks
	COOL	HEAT	
Room temperature (TH1)	27°C	20.5°C	—
Indoor pipe temperature (TH2)	5°C	45°C	—
Indoor 2-phase pipe temperature (TH5)	5°C	50°C	—
Set temperature	25°C	22°C	—
Outdoor pipe temperature (TH3)	45°C	5°C	(*1)
Outdoor discharge pipe temperature (TH4)	80°C	80°C	(*1)
Outdoor 2-phase pipe temperature (TH6)	50°C	5°C	(*1)
Outdoor air temperature (TH7)	35°C	7°C	(*1)
Temperature difference code (room temperature - set temperature) (Tj)	5	5	—
Discharge superheat (SHd)	30deg	30deg	(*2)
Sub-cool (SC)	5deg	5deg	(*2)

\*1: If the thermistor temperature data is normal (not open/short), that data is loaded into the control as valid data.

When the unit enters emergency operation and TH values are mismatched, set the thermistors to open/short. And the unit runs emergency operation with the values listed above.

\*2: If one thermistor is set to open/short, the values of SHd/SC will be different from the list above.

[Example] When liquid temperature thermistor (TH3) has an open or short circuit.

Thermistor	COOL	HEAT
TH3	45°C	5°C
TH6	Ta	Tb
	Regard normal figure as effective data.	
TH4	Tc	Td
	Regard normal figure as effective data.	
TH5	5°C	50°C
TH2	5°C	45°C

Discharge superheat (SHd)

Cooling = TH4 - TH6 = Tc - Ta

Heating = TH4 - TH5 = Td - 50

Degree of subcooling (SC)

Cooling = TH6 - TH3 = Ta - 45

Heating = TH5 - TH2 = 50 - 45 = 5°C



# 10-9. TEST POINT DIAGRAM

## Outdoor controller circuit board

### PUHZ-RP200YHA2 PUHZ-RP250YHA2

<CAUTION> TEST POINT① is high voltage.

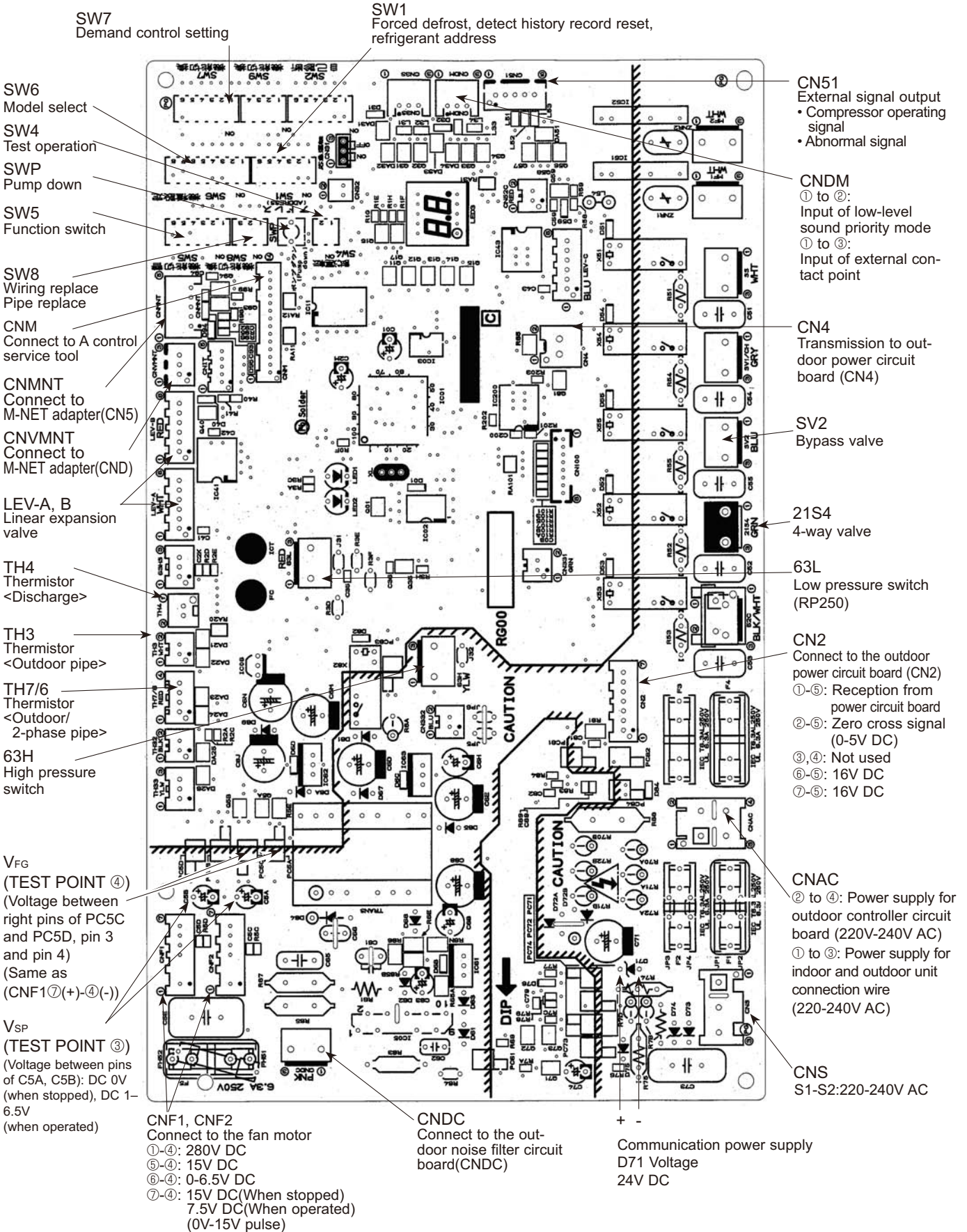

**Outdoor noise filter circuit board**  
**PUHZ-RP200YHA2**  
**PUHZ-RP250YHA2**

L11, L12, L13, NI  
 POWER SUPPLY  
 L11-L12/L1-L13/L13-L11 : AC380/400/415V input  
 L11-NI/L12-NI/L13-NI : AC220/230/240V input  
 (Connect to the terminal block (TB1))

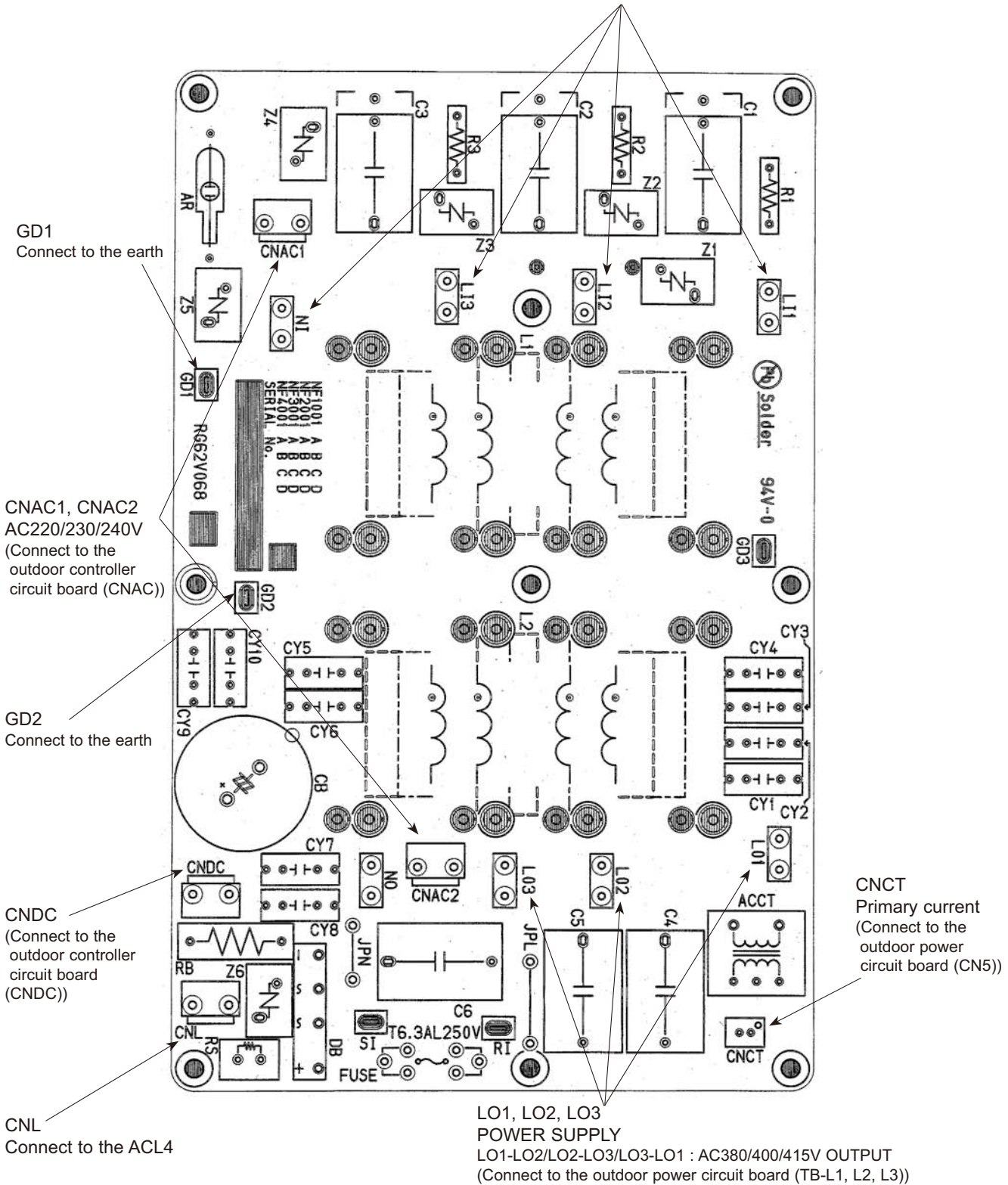

**Outdoor power circuit board**  
**PUHZ-RP200YHA2**  
**PUHZ-RP250YHA2**

**Brief check of POWER MODULE**

\* Usually, they are in a state of being short-circuited if they are broken. Measure the resistance in the following points (connectors, etc.). If they are short-circuited, it means that they are broken.

1. Check of POWER MODULE

①. Check of DIODE circuit

**L1-P1**, **L2-P1**, **L3-P1**, **L1-N1**, **L2-N1**, **L3-N1**

②. Check of IGBT circuit

**P2-U**, **P2-V**, **P2-W**, **N2-U**, **N2-V**, **N2-W**

Note: The marks, **L1**, **L2**, **L3**, **N1**, **N2**, **P1**, **P2**, **U**, **V** and **W** shown in the diagram are not actually printed on the board.

CN2

Connect to the outdoor controller circuit board (CN2)

①-⑤: Power circuit board → Transmitting signal to the controller board (0-5V DC)

②-⑤: Zero cross signal (0-5V DC)

③-④: Not used [ ⑤ : ⊖ ①, ②, ⑥, ⑦ : ⊕ ]

⑥-⑤: 16V DC

⑦-⑤: 16V DC

SC-U, SC-V, SC-W

Connect to the compressor (MC)

Voltage among phases: 10V-400V AC

CN4

Connect to the outdoor controller circuit board (CN4)

CN5

Detection of primary current (Connect to the outdoor noise filter circuit board (CNCT))

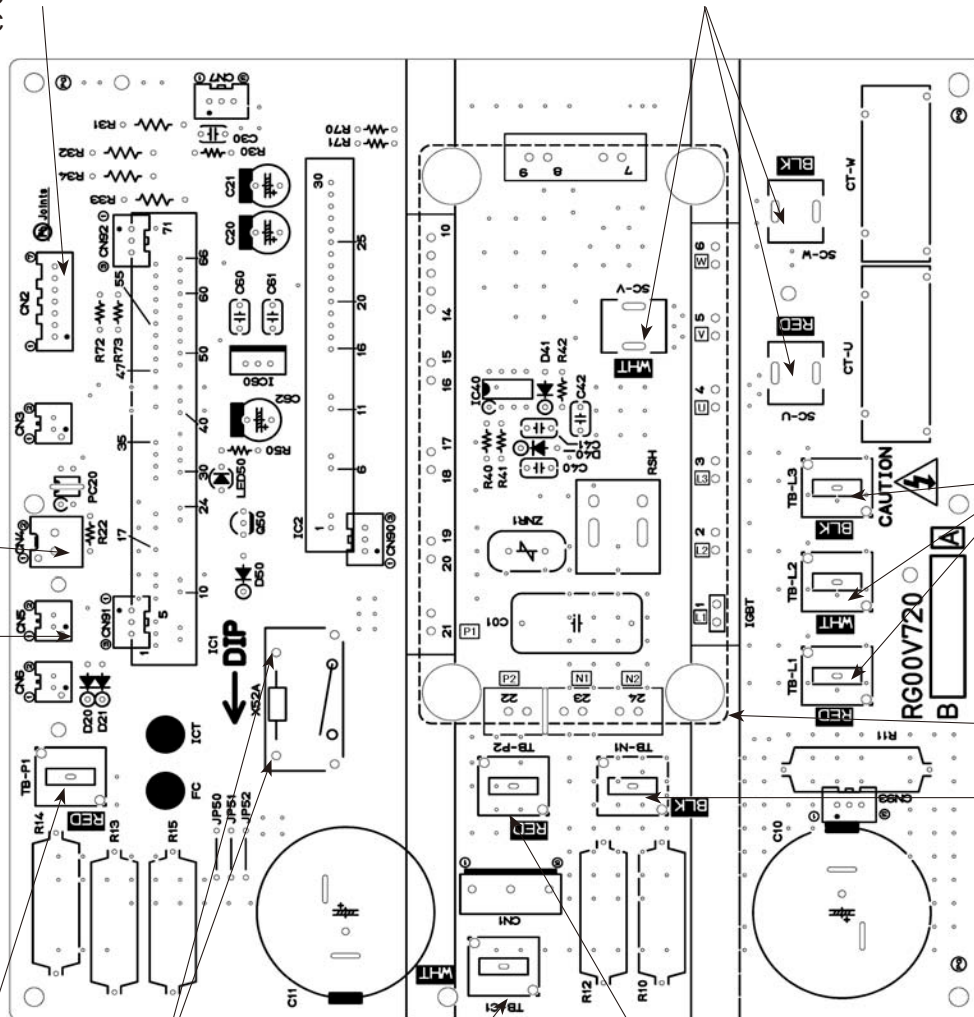

## 10-10. FUNCTION OF SWITCHES, CONNECTORS AND JUMPERS

### (1) Function of switches

Type of switch	Switch	No.	Function	Action by the switch operation		Effective timing						
				ON	OFF							
Dip switch	SW1	1	Forced defrost *1	Start	Normal	When compressor is working in heating operation. *						
		2	Abnormal history clear	Clear	Normal		off or operating					
		3	Refrigerant address setting		0		1		2		3	When power supply ON
				4		5		6		7		
				8		9		10		11		
				12		13		14		15		
		12			13		14		15			
	SW4	1	Test run	Operating	OFF	Under suspension						
		2	Test run mode setting	Heating	Cooling							

\*1. Forced defrost should be done as follows.

① Change the DIP SW1-1 on the outdoor controller board from OFF to ON.

② Forced defrost will start by the above operation ① if these conditions written below are satisfied.

- Heat mode setting
- 10 minutes have passed since compressor started operating or previous forced defrost finished.
- Pipe temperature is less than or equal to 8°C.
- Forced defrost will finish if certain conditions are satisfied.

Forced defrost can be done if above conditions are satisfied when DIP SW1-1 is changed from OFF to ON.

After DIP SW1-1 is changed from OFF to ON, there is no problem if DIP SW1-1 is left ON or changed to OFF again. This depends on the service conditions.

Type of Switch	Switch	No.	Function	Action by the switch operation		Effective timing													
				ON	OFF														
Dip switch	SW5	1	No function	—	—	—													
		2	Power failure automatic recovery *2	Auto recovery	No auto recovery	When power supply ON													
		3,4,5	No function	—	—	—													
		6	Model select	Refer to next page.															
	SW7 *4	1	Setting of demand control *3	<table border="1"> <thead> <tr> <th>SW7-1</th> <th>SW7-2</th> <th>Power consumption (Demand switch ON)</th> </tr> </thead> <tbody> <tr> <td>OFF</td> <td>OFF</td> <td>0% (Operation stop)</td> </tr> <tr> <td>ON</td> <td>OFF</td> <td>50%</td> </tr> <tr> <td>OFF</td> <td>ON</td> <td>75%</td> </tr> </tbody> </table>			SW7-1	SW7-2	Power consumption (Demand switch ON)	OFF	OFF	0% (Operation stop)	ON	OFF	50%	OFF	ON	75%	Always
				SW7-1	SW7-2	Power consumption (Demand switch ON)													
				OFF	OFF	0% (Operation stop)													
				ON	OFF	50%													
		OFF	ON	75%															
		3	Max Hz setting (cooling)	Max Hz(cooling) × 0.8	Normal	Always													
	4	Max Hz setting (heating)	Max Hz(heating) × 0.8	Normal	Always														
	5	No function	—	—	—														
	6	Defrost Hz setting	For high humidity	Normal	Always														
	SW8	1	Use of existing pipe	Existing pipe	New pipe	Always													
		2	No function	—	—	—													
		3	Use of existing wires	Existing wires	New wires	When power supply ON													
	SW9	1	No function	—	—	—													
		2	Function switch	Valid	Normal	Always													
	3,4	No function	—	—	—														
Push switch	SWP		Pump down	Start	Normal	Under suspension													

\*2 "Power failure automatic recovery" can be set by either remote controller or this DIP SW. If one of them is set to ON, "Auto recovery" activates. Please set "Auto recovery" basically by remote controller because all units do not have DIP SW. Please refer to the indoor unit installation manual.

\*3 SW7-1,2 are used for demand control. SW7-1,2 are effective only at the demand control. (Refer to next page : Special function (b))

\*4 Please do not use SW7-3~5 usually. Trouble might be caused by the usage condition.

**(2) Function of connectors and switches**

Types	Connector Switch	Function	Action by open/ short operation		Effective timing																	
			Short	Open																		
Connector	CN31	Emergency operation	Start	Normal	When power supply ON																	
SW6 SW5-6	SW6-1	Model select	<table border="1"> <thead> <tr> <th>MODEL</th> <th colspan="2">SW6</th> <th colspan="2">SW5-6</th> </tr> </thead> <tbody> <tr> <td>200Y</td> <td>ON OFF</td> <td>1 2 3 4 5 6 7 8</td> <td>ON OFF</td> <td>1 2 3 4 5 6</td> </tr> <tr> <td>250Y</td> <td>ON OFF</td> <td>1 2 3 4 5 6 7 8</td> <td>ON OFF</td> <td>1 2 3 4 5 6</td> </tr> </tbody> </table>			MODEL	SW6		SW5-6		200Y	ON OFF	1 2 3 4 5 6 7 8	ON OFF	1 2 3 4 5 6	250Y	ON OFF	1 2 3 4 5 6 7 8	ON OFF	1 2 3 4 5 6		
	MODEL					SW6		SW5-6														
	200Y					ON OFF	1 2 3 4 5 6 7 8	ON OFF	1 2 3 4 5 6													
	250Y					ON OFF	1 2 3 4 5 6 7 8	ON OFF	1 2 3 4 5 6													
	SW6-2																					
	SW6-3																					
	SW6-4																					
	SW6-5																					
	SW6-6																					
SW6-7																						
SW6-8																						
SW5-6																						

**Special function**

**(a) Low-level sound priority mode (Local wiring)**

Unit enters into Low-level sound priority mode by external signal input setting.

Inputting external signals to the outdoor unit decreases the outdoor unit operation sound 3 to 4 dB lower than that of usual. Adding a commercial timer or on-off switch contactor setting to the CNDM connector which is optional contactor for demand input located on the outdoor controller board enables to control compressor operation frequency.

※ The performance depends on the load of conditioned outdoor temperature.

**How to wire**

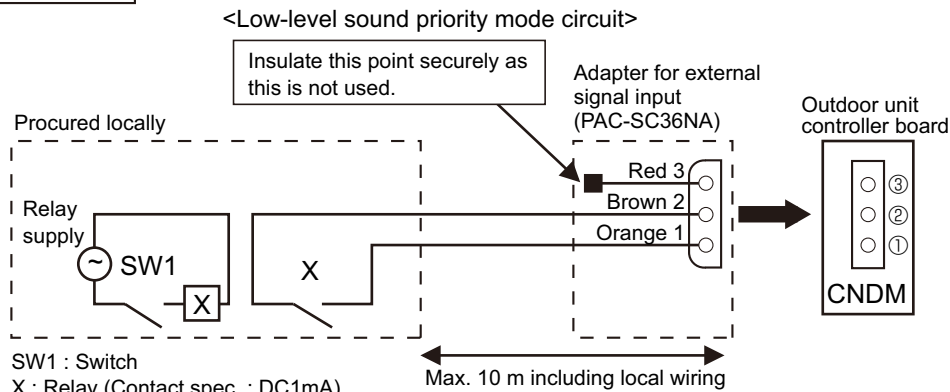

- 1) Make the circuit as shown above with adapter for external signal input(PAC-SC36NA).
- 2) Turn SW1 to on for Low-level sound priority mode.  
Turn SW1 to off to release Low-level sound priority mode and normal operation.

**(b) Demand control (Local wiring)**

Demand control is available by external input. In this mode, power consumption is decreased within the range of usual 0~100%.

**How to wire**

Basically, the wiring is same with (a).

Connect an SW 1 which is procured locally between Orange and Red(1 and 3) of the adapter for external signal input(PAC-SC36NA), and insulate the tip of the brown lead wire.

It is possible to set it to the following power consumption (compared with ratings) by setting the SW7-1, 2.

SW7-1	SW7-2	Power consumption (SW1 on)
OFF	OFF	0% (Operation stop)
ON	OFF	50%
OFF	ON	75%

### <Display function of inspection for outdoor unit>

The blinking patterns of both LED1(green) and LED2(red) indicate the types of abnormality when it occurs. Types of abnormality can be indicated in details by connecting an optional part "A-Control Service Tool (PAC-SK52ST)" to connector CNM on outdoor controller board.

[Display]

#### (1)Normal condition

Unit condition	Outdoor controller board		A-Control Service Tool	
	LED1 (Green)	LED2 (Red)	Error code	Indication of the display
When the power is turned on	Lighted	Lighted	— ↔ —	Alternately blinking display
When unit stops	Lighted	Not lighted	00, etc.	Operation mode
When compressor is warming up	Lighted	Not lighted	08, etc.	
When unit operates	Lighted	Lighted	C5, H7 etc.	

#### (2)Abnormal condition

Indication		Contents	Error code ※1	Error	Inspection method	Detailed reference page
Outdoor controller board						
LED1 (Green)	LED2 (Red)					
1 blinking	2 blinking	Connector(63L) is open.	F3	①Check if connector (63L or 63H) on the outdoor controller board is not disconnected. ②Check continuity of pressure switch (63L or 63H) by tester.	Replace indoor controller board	P.28
		Connector(63H) is open.	F5			
		2 connectors are open.	F9			
	4 blinking	Abnormality of indoor controller board	Fb			※2
2 blinking	1 blinking	Miswiring of indoor/outdoor unit connecting wire, excessive number of indoor units (5 units or more)	—	①Check if indoor/outdoor connecting wire is connected correctly. ②Check if 5 or more indoor units are connected to outdoor unit. ③Check if noise entered into indoor/outdoor connecting wire or power supply. ④Re-check error by turning off power, and on again.		P.29 (EA) P.29 (Eb) P.29 (EC)
		Miswiring of indoor/outdoor unit connecting wire (converse wiring or disconnection)	—			
		Startup time over	—			
	2 blinking	Indoor/outdoor unit communication error (signal receiving error) is detected by indoor unit.	E6			①Check if indoor/outdoor connecting wire is connected correctly. ②Check if noise entered into indoor/outdoor connecting wire or power supply. ③Check if noise entered into indoor/outdoor controller board. ④Re-check error by turning off power, and on again.
		Indoor/outdoor unit communication error (transmitting error) is detected by indoor unit.	E7			
		Indoor/outdoor unit communication error (signal receiving error) is detected by outdoor unit.	—	P.34 (E8) P.34 (E9)		
		Indoor/outdoor unit communication error (transmitting error) is detected by outdoor unit.	—			
	3 blinking	Remote controller signal receiving error is detected by remote controller.	E0	①Check if connecting wire of indoor unit or remote controller is connected correctly. ②Check if noise entered into transmission wire of remote controller. ③Re-check error by turning off power, and on again.		P.33
		Remote controller transmitting error is detected by remote controller.	E3			
		Remote controller signal receiving error is detected by indoor unit.	E4			
		Remote controller transmitting error is detected by indoor unit.	E5			
	4 blinking		Error code is not defined.	EF	①Check if remote controller is MA remote controller(PAR-21MAA). ②Check if noise entered into transmission wire of remote controller. ③Check if noise entered into indoor/outdoor connecting wire. ④Re-check error by turning off power, and on again.	
5 blinking		Serial communication error <Communication between outdoor controller board and outdoor power board> <Communication between outdoor controller board and M-NET P.C. board>	Ed	①Check if connector (CN4) on outdoor controller board and outdoor power board is not disconnected. ②Check if there is poor connection of connector on outdoor controller board(CNMNT and CNVMNT). ③Check M-NET communication signal.		P.34
		Communication error of M-NET system	A0~A8			

※1.Error code displayed on remote controller

※2.Refer to service manual for indoor unit.



Indication		Error			
Outdoor controller board		Contents	Error code *1	Inspection method	Detailed reference page
LED1 (Green)	LED2 (Red)				
3 blinking	1 blinking	Abnormality of discharging temperature (TH4) Shortage of refrigerant	U2	①Check if stop valves are open. ②Check if connectors (TH4, LEV-A and LEV-B) on outdoor controller board are not disconnected. ③Check if unit is filled with specified amount of refrigerant. ④Measure resistance values among terminals on outdoor linear expansion valve using a tester.	P.30
	2 blinking	Abnormal high pressure (High pressure switch 63H worked.)	U1	①Check if indoor/outdoor units have a short cycle on their air ducts. ②Check if connector (63H or 63L) on outdoor controller board is not disconnected. ③Check if heat exchanger and filter is not dirty. ④Measure resistance values among terminals on linear expansion valve using a tester.	P.30
		Abnormal low pressure	UL		P.32
	3 blinking	Abnormality of outdoor fan motor rotational speed	U8	①Check the outdoor fan motor. ②Check if connector (TH3) on outdoor controller board is disconnected.	P.31
		Protection from overheat operation(TH3)	Ud		P.32
	4 blinking	Compressor overcurrent breaking(Start-up locked)	UF	①Check if stop valves are open. ②Check looseness, disconnection, and converse connection of compressor wiring. ③Measure resistance values among terminals on compressor using a tester. ④Check if outdoor unit has a short cycle on its air duct.	P.32
		Compressor overcurrent breaking	UP		P.33
		Abnormality of current sensor (P.B.)	UH		P.32
		Abnormality of power module	U6		P.31
	5 blinking	Open/short of discharge thermistor (TH4)	U3	①Check if connectors(TH3,TH4,TH6 and TH7)on outdoor controller board and connector (CN3) on outdoor power board are not disconnected. ②Measure resistance value of outdoor thermistors.	P.30
		Open/short of outdoor thermistors (TH3, TH6, TH7 and TH8)	U4		P.31
	6 blinking	Abnormality of heatsink temperature	U5	①Check if indoor/outdoor units have a short cycle on their air ducts. ②Measure resistance value of outdoor thermistor(TH8).	P.31
7 blinking	Abnormality of voltage	U9	①Check looseness, disconnection, and converse connection of compressor wiring. ②Measure resistance value among terminals on compressor using a tester. ③Check the continuity of contactor (52C). ④Check if power supply voltage decreases. ⑤Check the wiring of CN52C. ⑥Check the wiring of CNAF.	P.32	
4 blinking	1 blinking	Abnormality of room temperature thermistor (TH1)	P1	①Check if connectors (CN20, CN21, CN29 and CN44) on indoor controller board are not disconnected. ②Measure resistance value of indoor thermistors.	*2
		Abnormality of pipe temperature thermistor /Liquid (TH2)	P2		*2
		Abnormality of pipe temperature thermistor/Condenser-Evaporator	P9		*2
	2 blinking	Abnormality of drain sensor (DS) Float switch connector open	P4	①Check if connector (CN31),(CN4F) on indoor controller board is not disconnected. ②Measure resistance value of indoor thermistors. ③Measure resistance value among terminals on drain-up machine using a tester. ④Check if drain-up machine works. ⑤Check drain function.	*2
		Indoor drain overflow protection	P5		
	3 blinking	Freezing (cooling)/overheating (heating) protection	P6	①Check if indoor unit has a short cycle on its air duct. ②Check if heat exchanger and filter is not dirty. ③Measure resistance value on indoor and outdoor fan motors. ④Check if the inside of refrigerant piping is not clogged.	*2
	4 blinking	Abnormality of pipe temperature	P8	①Check if indoor thermistors(TH2 and TH5) are not disconnected from holder. ②Check if stop valve is open. ③Check converse connection of extension pipe. (on plural units connection) ④Check if indoor/outdoor connecting wire is connected correctly. (on plural units connection)	*2

\*1 Error code displayed on remote controller

\*2 Refer to service manual for indoor unit.

**<Outdoor unit operation monitor function>**

**[When optional part "A-Control Service Tool(PAC-SK52ST)" is connected to outdoor controller board(CNM)]**

Digital indicator LED1 displays 2 digit number or code to inform operation condition and the meaning of error code by controlling DIP SW2 on "A-Control Service Tool".

Operation indicator SW2 : Indicator change of self diagnosis

SW2 setting	Display detail	Explanation for display	Unit
			

**<Digital indicator LED1 working details>**

(Be sure that 1 to 6 in the SW2 are set to OFF.)

- (1) Display when the power supply ON  
When the power supply ON, blinking displays by turns.  
Wait for 4 minutes at the longest.
- (2) When the display lights (Normal operation)
  - ① Operation mode display.

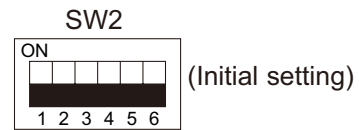
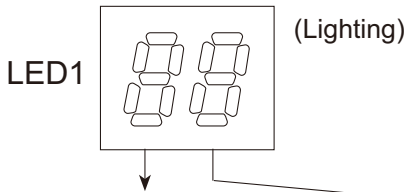
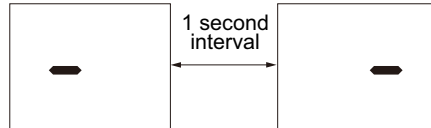

The tens digit : Operation mode

Display	Operation Model
O	OFF / FAN
C	COOLING / DRY *
H	HEATING
d	DEFROSTING

The ones digit : Relay output

Display	Warming-up Compressor	Compressor	4-way valve	Solenoid valve
0	—	—	—	—
1	—	—	—	ON
2	—	—	ON	—
3	—	—	ON	ON
4	—	ON	—	—
5	—	ON	—	ON
6	—	ON	ON	—
7	—	ON	ON	ON
8	ON	—	—	—
A	ON	—	ON	—

\*C5 is displayed during replacement operation.

② Display during error postponement  
Postponement code is displayed when compressor stops due to the work of protection device.  
Postponement code is displayed while error is being postponed.

- (3) When the display blinks  
Inspection code is displayed when compressor stops due to the work of protection devices.





Display	Contents to be inspected (During operation)
U1	Abnormal high pressure (63H worked)
U2	Abnormal high discharging temperature, shortage of refrigerant
U3	Open/short circuit of discharging thermistor(TH4)
U4	Open/short of outdoor unit thermistors(TH3, TH6, TH7 and TH8)
U5	Abnormal temperature of heatsink
U6	Abnormality of power module
U8	Abnormality in outdoor fan motor
U9	Abnormality of voltage
Ud	Overheat protection
UF	Compressor overcurrent interruption (When Comp. locked)
UH	Current sensor error
UL	Abnormal low pressure
UP	Compressor overcurrent interruption
P1~P8	Abnormality of indoor units
A0~A7	Communication error of M-NET system

Display	Inspection unit
0	Outdoor unit
1	Indoor unit 1
2	Indoor unit 2
3	Indoor unit 3
4	Indoor unit 4

Display	Contents to be inspected (When power is turned on)
F5	63H connector(yellow) is open.
E8	Indoor/outdoor communication error (Signal receiving error) (Outdoor unit)
E9	Indoor/outdoor communication error (Transmitting error) (Outdoor unit)
EA	Miswiring of indoor/outdoor unit connecting wire, excessive number of indoor units (4 units or more)
Eb	Miswiring of indoor/outdoor unit connecting wire(converse wiring or disconnection)
EC	Startup time over
E0~E7	Communication error except for outdoor unit

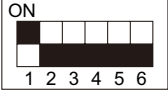
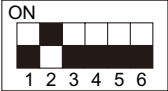
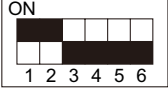
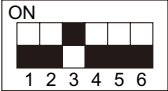
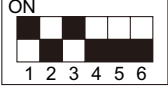

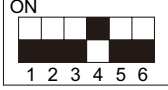
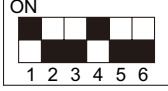

SW2 setting	Display detail	Explanation for display	Unit
	Pipe temperature / Liquid (TH3) - 40~90	- 40~90 (When the coil thermistor detects 0°C or below, “-” and temperature are displayed by turns.) (Example) When -10°C; 0.5 secs. 0.5secs. 2 secs. -□ → 10 → □□	°C
	Discharge temperature (TH4) 3~217	3~217 (When the discharge thermistor detects 100°C or more, hundreds digit, tens digit and ones digit are displayed by turns.) (Example) When 105°C; 0.5 secs. 0.5secs. 2 secs. □1 → 05 → □□	°C
	Output step of outdoor FAN 0~10	0~10	Step
	The number of ON / OFF times of compressor 0~9999	0~9999 (When the number of times is 100 or more, hundreds digit, tens digit and ones digit are displayed by turns.) (Example) When 42500 times (425 × 100 times); 0.5 secs. 0.5secs. 2 secs. □4 → 25 → □□	100 times
	Compressor integrating operation times 0~9999	0~9999 (When it is 100 hours or more, hundreds digit, tens digit and ones digit are displayed by turns.) (Example) When 2450 hours (245 × 10 hours); 0.5 secs. 0.5secs. 2 secs. □2 → 45 → □□	10 hours
	Compressor operating current 0~50	0~50 *Omit the figures after the decimal fractions.	A
	Compressor operating frequency 0~255	0~255 (When it is 100Hz or more, hundreds digit, tens digit and ones digit are displayed by turns.) (Example) When 125Hz; 0.5 secs. 0.5secs. 2 secs. □1 → 25 → □□	Hz
	LEV-A opening pulse 0~480	0~480 (When it is 100 pulse or more, hundreds digit, tens digit and ones digit are displayed by turns.) (Example) When 150 pulse; 0.5 secs. 0.5secs. 2 secs. □1 → 50 → □□	Pulse
	Error postponement code history (1) of outdoor unit	Postponement code display Blinking: During postponement Lighting: Cancellation of postponement “00” is displayed in case of no postponement.	Code display
	Operation mode on error occurring	Operation mode of when operation stops due to error is displayed by setting SW2 like below.  (SW2) 	Code display









SW2 setting	Display detail	Explanation for display	Unit
	Pipe temperature / Liquid(TH3) on error occurring - 40~90	- 40~90 (When the coil thermistor detects 0°C or below, “-” and temperature are displayed by turns.) (Example) When -15°C; 0.5 secs. 0.5secs. 2 secs. -□ → 15 → □□	°C
	Compressor temperature (TH4) or discharge temperature (TH4) on error occurring 3~217	3~217 (When the temperature is 100°C or more, the hundreds digit, tens digit and ones digit are displayed by turns.) (Example) When 130°C; 0.5 secs. 0.5secs. 2 secs. □1 → 30 → □□	°C
	Compressor operating current on error occurring 0~20	0~20	A
	Error code history (1) (latest) Alternate display of abnormal unit number and code	When no error history, “0” and “-” are displayed by turns.	Code display
	Error code history (2) Alternate display of error unit number and code	When no error history, “0” and “-” are displayed by turns.	Code display
	Thermo ON time 0~999	0~999 (When it is 100 minutes or more, the hundreds digit, tens digit and ones digit are displayed by turns.) (Example) When 245 minutes; 0.5 secs. 0.5secs. 2 secs. □2 → 45 → □□	Minute
	Test run elapsed time 0~120	0~120 (When it is 100 minutes or more, the hundreds digit, tens digit and ones digit are displayed by turns.) (Example) When 105 minutes; 0.5 secs. 0.5secs. 2 secs. □1 → 05 → □□	Minute
	LEV-B opening pulse 0~480	0~480 (When it is 100 pulse or more, hundreds digit, tens digit and ones digit are displayed by turns.) (Example) When 150 pulse; 0.5 secs. 0.5secs. 2 secs. □1 → 50 → □□	Pulse

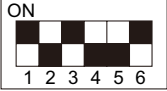

SW2 setting	Display detail	Explanation for display	Unit										
	The number of connected indoor units	0~4 (The number of connected indoor units are displayed.)	Unit										
	Capacity setting display	Displayed as an outdoor capacity code. <table border="1"> <tr> <th>Capacity</th> <th>Code</th> </tr> <tr> <td>RP200</td> <td>40</td> </tr> <tr> <td>RP250</td> <td>50</td> </tr> </table>	Capacity	Code	RP200	40	RP250	50	Code display				
Capacity	Code												
RP200	40												
RP250	50												
	Outdoor unit setting information	<ul style="list-style-type: none"> <li>The tens digit (Total display for applied setting)</li> </ul> <table border="1"> <thead> <tr> <th>Setting details</th> <th>Display details</th> </tr> </thead> <tbody> <tr> <td>H·P / Cooling only</td> <td>0 : H·P      1 : Cooling only</td> </tr> <tr> <td>Single phase / 3 phase</td> <td>0 : Single phase    2 : 3 phase</td> </tr> </tbody> </table> <ul style="list-style-type: none"> <li>The ones digit</li> </ul> <table border="1"> <thead> <tr> <th>Setting details</th> <th>Display details</th> </tr> </thead> <tbody> <tr> <td>Defrosting switch</td> <td>0 : Normal    1 : For high humidity</td> </tr> </tbody> </table> <p>(Example) When heat pump, 3 phase and defrosting (normal) are set up, "20" is displayed.</p>	Setting details	Display details	H·P / Cooling only	0 : H·P      1 : Cooling only	Single phase / 3 phase	0 : Single phase    2 : 3 phase	Setting details	Display details	Defrosting switch	0 : Normal    1 : For high humidity	Code display
Setting details	Display details												
H·P / Cooling only	0 : H·P      1 : Cooling only												
Single phase / 3 phase	0 : Single phase    2 : 3 phase												
Setting details	Display details												
Defrosting switch	0 : Normal    1 : For high humidity												
	Indoor pipe temperature / Liquid (TH2(1)) Indoor 1 – 39~88	– 39~88 (When the temperature is 0°C or less, "–" and temperature are displayed by turns.)	°C										
	Indoor pipe temperature / Cond. / Eva. (TH5(1)) Indoor 1 – 39~88	– 39~88 (When the temperature is 0°C or less, "–" and temperature are displayed by turns.)	°C										
	Indoor pipe temperature / Liquid (TH2(2)) Indoor 2 – 39~88	– 39~88 (When the temperature is 0°C or less, "–" and temperature are displayed by turns.)	°C										
	Indoor pipe temperature / Cond. / Eva. (TH5(2)) Indoor 2 – 39~88	– 39~88 (When the temperature is 0°C or less, "–" and temperature are displayed by turns.)	°C										
	Indoor room temperature (TH1) 8~39	8~39	°C										

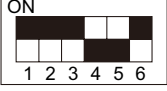
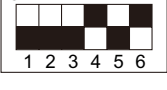





SW2 setting	Display detail	Explanation for display	Unit																					
	Indoor setting temperature 17~30	17~30	°C																					
	Outdoor pipe temperature / 2-phase (TH6) -39~88	-39~88 (When the temperature is 0°C or less, “-” and temperature are displayed by turns.)	°C																					
	Outdoor ambient temperature (TH7) -39~88	-39~88 (When the temperature is 0°C or less, “-” and temperature are displayed by turns.)	°C																					
	Outdoor heatsink temperature (TH8) -40~200	-40~200 (When the temperature is 0°C or less, “-” and temperature are displayed by turns.) (When the thermistor detects 100°C or more, hundreds digit, tens digit and ones digit are displayed by turns.)	°C																					
	Discharge superheat SHd 0~255 [ Cooling = TH4-TH6 ] [ Heating = TH4-TH5 ]	0~255 (When the temperature is 100°C or more, hundreds digit, tens digit and ones digit are displayed by turns.)	°C																					
	Subcool SC 0~130 [ Cooling = TH6-TH3 ] [ Heating = TH5-TH4 ]	0~130 (When the temperature is 100°C or more, hundreds digit, tens digit and ones digit are displayed by turns.)	°C																					
	Input current of outdoor unit	0~500 (When it is 100 or more, hundreds digit, tens digit and ones digit are displayed by turns.)	0.1 A																					
	U9 Error status	<table border="1"> <thead> <tr> <th>Description</th> <th>Detection point</th> <th>Display</th> </tr> </thead> <tbody> <tr> <td>Normal</td> <td>—</td> <td>00</td> </tr> <tr> <td>Overvoltage error</td> <td>Power circuit board</td> <td>01</td> </tr> <tr> <td>Undervoltage error</td> <td>Power circuit board</td> <td>02</td> </tr> <tr> <td>Input current sensor error</td> <td>Controller circuit board</td> <td>04</td> </tr> <tr> <td>L-phase open error</td> <td>Controller circuit board</td> <td>04</td> </tr> <tr> <td>Abnormal power synchronous signal</td> <td>Power circuit board</td> <td>08</td> </tr> </tbody> </table> <p>* Display examples for multiple errors: Overvoltage (01) + Undervoltage (02) = 03 Undervoltage (02) + Power-sync signal error (08) = 0A</p>	Description	Detection point	Display	Normal	—	00	Overvoltage error	Power circuit board	01	Undervoltage error	Power circuit board	02	Input current sensor error	Controller circuit board	04	L-phase open error	Controller circuit board	04	Abnormal power synchronous signal	Power circuit board	08	Code display
Description	Detection point	Display																						
Normal	—	00																						
Overvoltage error	Power circuit board	01																						
Undervoltage error	Power circuit board	02																						
Input current sensor error	Controller circuit board	04																						
L-phase open error	Controller circuit board	04																						
Abnormal power synchronous signal	Power circuit board	08																						
	DC bus voltage 300-750	300-750 (When it is 100V or more, hundreds digit, tens digit and ones digit are displayed by turns.)	V																					

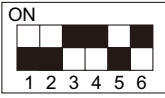
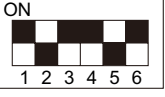
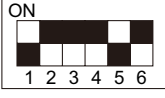
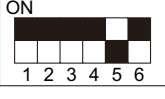
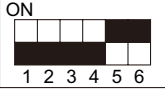
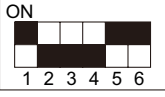
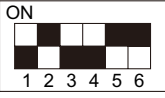

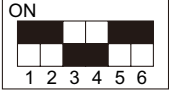
SW2 setting	Display detail	Explanation for display	Unit
	<p>Capacity save 0~255</p> <p>When air conditioner is connected to M-NET and capacity save mode is demanded, "0"~"100" is displayed.</p> <p>[ When there is no setting of capacity save "100" is displayed. ]</p>	<p>0~255 (When the capacity is 100% hundreds digit, tens digit and ones digit are displayed by turns.) (Example) When 100%;</p> <p>0.5 secs.    0.5secs.    2 secs.</p> <p>□1    → 00    → □□</p>	%
	<p>Error postponement code history (2) of outdoor unit</p>	<p>Postponement code display Blinking: During postponement Lighting: Cancellation of postponement "00" is displayed in case of no postponement.</p>	Code display
	<p>Error postponement code history (3) of outdoor unit</p>	<p>Postponement code display Blinking: During postponement Lighting: Cancellation of postponement "00" is displayed in case of no postponement.</p>	Code display
	<p>Error code history (3) (Oldest) Alternate display of abnormal unit number and code</p>	<p>When no error history, "0" and "—" are displayed by turns.</p>	Code display
	<p>Error thermistor display</p> <p>[ When there is no error thermistor, "—" is displayed. ]</p>	<p>3: Outdoor pipe temperature / Liquid (TH3) 6: Outdoor pipe temperature / 2-phase (TH6) 7: Outdoor ambient temperature (TH7) 8: Outdoor heatsink (TH8)</p>	Code display
	<p>Operation frequency on error occurring 0~255</p>	<p>0~255 (When it is 100Hz or more, hundreds digit, tens digit and ones digit are displayed by turns.) (Example) When 125Hz;</p> <p>0.5 secs.    0.5secs.    2 secs.</p> <p>□1    → 25    → □□</p>	Hz
	<p>Fan step on error occurring 0~10</p>	<p>0~10</p>	Step

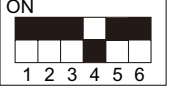
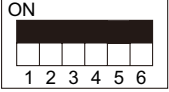

SW2 setting	Display detail	Explanation for display	Unit
	LEV-A opening pulse on error occurring 0~480	0~480 (When it is 100 pulse or more, hundreds digit, tens digit and ones digit are displayed by turns.) (Example) When 130 pulse; 0.5 secs.    0.5secs.    2 secs. $\square 1 \rightarrow 30 \rightarrow \square \square$	Pulse
	Indoor room temperature (TH1) on error occurring 8~39		°C
	Indoor pipe temperature / Liquid (TH2) on error occurring -39~88	-39~88 (When the temperature is 0°C or less, “-” and temperature are displayed by turns.) (Example) When -15°C; 0.5 secs.    0.5secs.    2 secs. $-\square \rightarrow 15 \rightarrow \square \square$	°C
	Indoor pipe temperature / Cond./ Eva. (TH5) on error occurring -39~88	-39~88 (When the temperature is 0°C or less, “-” and temperature are displayed by turns.) (Example) When -15°C; 0.5 secs.    0.5secs.    2 secs. $-\square \rightarrow 15 \rightarrow \square \square$	°C
	Outdoor pipe temperature / 2 phase (TH6) on error occurring -39~88	-39~88 (When the temperature is 0°C or less, “-” and temperature are displayed by turns.) (Example) When -15°C; 0.5 secs.    0.5secs.    2 secs. $-\square \rightarrow 15 \rightarrow \square \square$	°C
	Outdoor ambient temperature (TH7) on error occurring -39~88	-39~88 (When the temperature is 0°C or less, “-” and temperature are displayed by turns.) (Example) When -15°C; 0.5 secs.    0.5secs.    2 secs. $-\square \rightarrow 15 \rightarrow \square \square$	°C
	Outdoor heatsink temperature (TH8) on error occurring -40~200	-40~200 (When the temperature is 0°C or less, “-” and temperature are displayed by turns.) (When the temperature is 100°C or more, hundreds digit, tens digit and ones digit are displayed by turns.)	°C

SW2 setting	Display detail	Explanation for display	Unit																					
	Discharge superheat on error occurring SHd 0~255 [Cooling = TH4-TH6] [Heating = TH4-TH5]	0~255 (When the temperature is 100°C or more, hundreds digit, tens digit and ones digit are displayed by turns.) (Example) When 150°C; 0.5 secs.    0.5secs.    2 secs. □1        → 50        → □□	°C																					
	Subcool on error occurring SC 0~130 [Cooling = TH6-TH3] [Heating = TH5-TH2]	0~130 (When the temperature is 100°C or more, hundreds digit, tens digit and ones digit are displayed by turns.) (Example) When 115°C; 0.5 secs.    0.5secs.    2 secs. □1        → 15        → □□	°C																					
	Thermo-on time until error stops 0~999	0~999 (When it is 100 minutes or more, hundreds digit, tens digit and ones digit are displayed by turns.) (Example) When 415 minutes; 0.5 secs.    0.5secs.    2 secs. □4        → 15        → □□	Minute																					
	Indoor pipe temperature / Liquid (TH2 (3)) Indoor 3 -39~88	-39~88 (When the temperature is 0°C or less, “-” and temperature are displayed by turns.)	°C																					
	Indoor pipe temperature / Cond./ Eva. (TH5 (3)) Indoor 3 -39~88	-39~88 (When the temperature is 0°C or less, “-” and temperature are displayed by turns.)  When there is no indoor unit, “00” is displayed.	°C																					
	U9 Error status during the Error postponement period	<table border="1"> <thead> <tr> <th>Description</th> <th>Detection point</th> <th>Display</th> </tr> </thead> <tbody> <tr> <td>Normal</td> <td>—</td> <td>00</td> </tr> <tr> <td>Overvoltage error</td> <td>Power circuit board</td> <td>01</td> </tr> <tr> <td>Undervoltage error</td> <td>Power circuit board</td> <td>02</td> </tr> <tr> <td>Input current sensor error</td> <td>Controller circuit board</td> <td>04</td> </tr> <tr> <td>L-phase open error</td> <td>Controller circuit board</td> <td>04</td> </tr> <tr> <td>Abnormal power synchronous signal</td> <td>Power circuit board</td> <td>08</td> </tr> </tbody> </table> <p>           * Display examples for multiple errors:            Overvoltage (01) + Undervoltage (02) = 03            Undervoltage (02) + Power-sync signal error (08) = 0A         </p>	Description	Detection point	Display	Normal	—	00	Overvoltage error	Power circuit board	01	Undervoltage error	Power circuit board	02	Input current sensor error	Controller circuit board	04	L-phase open error	Controller circuit board	04	Abnormal power synchronous signal	Power circuit board	08	Code display
Description	Detection point	Display																						
Normal	—	00																						
Overvoltage error	Power circuit board	01																						
Undervoltage error	Power circuit board	02																						
Input current sensor error	Controller circuit board	04																						
L-phase open error	Controller circuit board	04																						
Abnormal power synchronous signal	Power circuit board	08																						

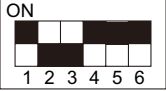
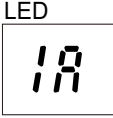

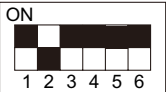
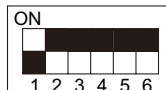
SW2 setting	Display detail	Explanation for display	Unit																
	Controlling status of compressor operating frequency	<p>The following code will be a help to know the operating status of unit.</p> <ul style="list-style-type: none"> <li>•The tens digit</li> </ul> <table border="1" data-bbox="767 367 1214 456"> <thead> <tr> <th>Display</th> <th>Compressor operating frequency control</th> </tr> </thead> <tbody> <tr> <td>1</td> <td>Primary current control</td> </tr> <tr> <td>2</td> <td>Secondary current control</td> </tr> </tbody> </table> <ul style="list-style-type: none"> <li>•The ones digit (In this digit, the total number of activated control is displayed.)</li> </ul> <table border="1" data-bbox="767 535 1214 775"> <thead> <tr> <th>Display</th> <th>Compressor operating frequency control</th> </tr> </thead> <tbody> <tr> <td>1</td> <td>Preventive control for excessive temperature rise of discharge temperature</td> </tr> <tr> <td>2</td> <td>Preventive control for excessive temperature rise of condensing temperature</td> </tr> <tr> <td>4</td> <td>Frosting preventing control</td> </tr> <tr> <td>8</td> <td>Preventive control for excessive temperature rise of radiator panel</td> </tr> </tbody> </table> <p>(Example) The following controls are activated.</p> <ul style="list-style-type: none"> <li>• Primary current control</li> <li>• Preventive control for excessive temperature rise of condensing temperature</li> <li>• Preventive control for excessive temperature rise of heatsink</li> </ul> 	Display	Compressor operating frequency control	1	Primary current control	2	Secondary current control	Display	Compressor operating frequency control	1	Preventive control for excessive temperature rise of discharge temperature	2	Preventive control for excessive temperature rise of condensing temperature	4	Frosting preventing control	8	Preventive control for excessive temperature rise of radiator panel	Code display
Display	Compressor operating frequency control																		
1	Primary current control																		
2	Secondary current control																		
Display	Compressor operating frequency control																		
1	Preventive control for excessive temperature rise of discharge temperature																		
2	Preventive control for excessive temperature rise of condensing temperature																		
4	Frosting preventing control																		
8	Preventive control for excessive temperature rise of radiator panel																		
	Indoor pipe temperature / Liquid (TH2(4)) Indoor 4 – 39~88	– 39~88 (When the temperature is 0°C or less, “–” and temperature are displayed by turns.)	°C																
	Indoor pipe temperature / (Cond./Eva.) (TH5(4)) Indoor 4 – 39~88	– 39~88 (When the temperature is 0°C or less, “–” and temperature are displayed by turns.)	°C																
	Replacement operation ※If replacement operation is conducted even once, "1" is displayed. If replacement operation is less than 2 hrs, "0" is displayed.	1: Conducted 0: Not yet	—																



11-1. UNIT FUNCTION SETTING BY THE REMOTE CONTROLLER

Each function can be set according to necessity using the remote controller. The setting of function for each unit can only be done by the remote controller. Select function available from the table 1.

(1) Functions available when setting the unit number to 00 (Select 00 referring to ④ set the indoor unit number.)

※1 The functions below are available only when the wired remote controller is used. The functions are not available for floor standing models.

<Table 1> Function selections

Function	Settings	Mode No.	Setting No.	● : Initial setting (when sent from the factory)	Remarks
Power failure automatic recovery	OFF	01	1		The setting is applied to all the units in the same refrigerant system.
	ON		2	●	
Indoor temperature detecting ※1	Average data from each indoor unit	02	1	●	
	Data from the indoor unit with remote controller		2		
	Data from main remote controller		3		
LOSSNAY connectivity	Not supported	03	1	●	
	Supported (Indoor unit does not intake outdoor air through LOSSNAY)		2		
	Supported (Indoor unit intakes outdoor air through LOSSNAY)		3		
Power supply voltage	240V	04	1		
	220V, 230V		2	●	
Auto operating mode	Auto energy-saving operation ON	05	1		
	Auto energy-saving operation OFF		2	●	
Frost prevention temperature	2°C (Normal)	15	1	●	
	3°C		2		
Humidifier control	When the compressor operates, the humidifier also operates.	16	1	●	
	When the fan operates, the humidifier also operates.		2		
Change of defrosting control	Standard	17	1	●	
	For high humidity		2		

Meaning of "Function setting"

Mode02:indoor temperature detecting

No.	Indoor temperature(ta)=	Diagram	Initial setting	ta=(A+B)/2	ta=A	ta=A
No.1	Average data of the sensor on all the indoor units		Initial setting	ta=(A+B)/2	ta=(A+B)/2	ta=A
No.2	Data of the sensor on the indoor unit that connected with remote controller			ta=A	ta=B	ta=A
No.3	Data of the sensor on main remote controller			ta=C	ta=C	ta=C

- (2) Functions available when setting the unit number to 01-04 or AL (07 in case of wireless remote controller)
- When setting functions for an indoor unit in an independent system, set the unit number to 01 referring to ④ setting the unit number of Operating Procedure.
  - When setting functions for a simultaneous twin/triple/quadruple indoor unit system, set the unit number to 01 to 04 for each indoor unit in case of selecting different functions for each unit referring to ④ setting the indoor unit number of Operating Procedure.
  - When setting the same functions for an entire simultaneous twin/triple/quadruple indoor unit system, set refrigerant address to AL (07 in case of wireless remote controller) referring to ④ setting the indoor unit number of Operating Procedure.

Function	Settings	Mode No.	Setting No.	● : Initial setting (Factory setting) - : Not available					
				4-Way cassette	Ceiling concealed		Ceiling suspended		Wall mounted
				PLA-BA	PEAD-EA(2) PEAD-GA	PEA-GA	PCA-GA(2)	PCA-HA	PKA-GAL PKA-FAL(2)
Filter sign	100h	07	1					●	●
	2500h		2	●			●		
	No filter sign indicator		3		●	●			
Airflow (Fan speed)	Quiet	08	1		-	-		-	-
	Standard		2	●	-	-	●	-	-
	High ceiling		3		-	-	-	-	-
No. of air outlets	4 directions	09	1	●	-	-	-	-	-
	3 directions		2		-	-	-	-	-
	2 directions		3		-	-	-	-	-
Optional high efficiency filter	Not supported	10	1	●	-	-	●	-	-
	Supported		2		-	-	-	-	-
Vane setting	No vanes (Vane No.3 setting : PLA only)	11	1		-	-	-	-	-
	Vane No.1 setting		2		-	-	●	-	-
	Vane No.2 setting		3	●	-	-	-	-	-
Energy saving air flow (Heating mode)	Disabled	12	1	-	-	-	●	-	-
	Enabled		2	-	-	-	-	-	-
Optional humidifier (PLA only)	Not supported	13	1	●	-	-	-	-	-
	Supported		2		-	-	-	-	-
Vane differential setting in heating mode (cold wind prevention)	No.1 setting (TH5: 24-28℃)	14	1		-	-	-	-	-
	No.2 setting (Standard, TH5:28-32℃)		2	●	-	-	●	-	●
	No.3 setting (TH5: 32-38℃)		3		-	-	-	-	-
Swing	Not available } Swing } PLA-BA	23	1		-	-	-	-	-
	Available } Wave air flow }		2	●	-	-	●	-	●
Set temperature in heating mode (4 deg up)	Available } Temperature correction: Valid } PLA-BA	24	1	●	●	●	●	●	●
	Not available } Temperature correction: Invalid }		2						
Fan speed during the heating thermo OFF	Extra low	25	1	●	●	-	●	●	●
	Stop		2			-			
	Set fan speed		3			-			
Fan speed during the cooling thermo OFF	Set fan speed	27	1	●	●	●	●	●	●
	Stop		2						
Detection of abnormality of the pipe temperature (P8)	Available	28	1	●	●	●	●	●	●
	Not available		2						

### Mode No.11

Setting No.	Settings	PLA-BA	PCA-GA(2)
1	Vane No.3 setting No Vanes	Less smudging ( Downward position than the standard )	No vane function
2	Vane No.1 setting	Standard	Standard
3	Vane No.2 setting	Less draft * ( Upward position than the standard )	Less draft * ( Upward position than the standard )

\* Be careful of the smudge on ceiling.

### 11-1-1. Selecting functions using the wired remote controller

First, try to familiarize yourself with the flow of the function selection procedure. In this section, an example of setting the room temperature detection position is given.

For actual operations, refer to steps ① to ⑩.

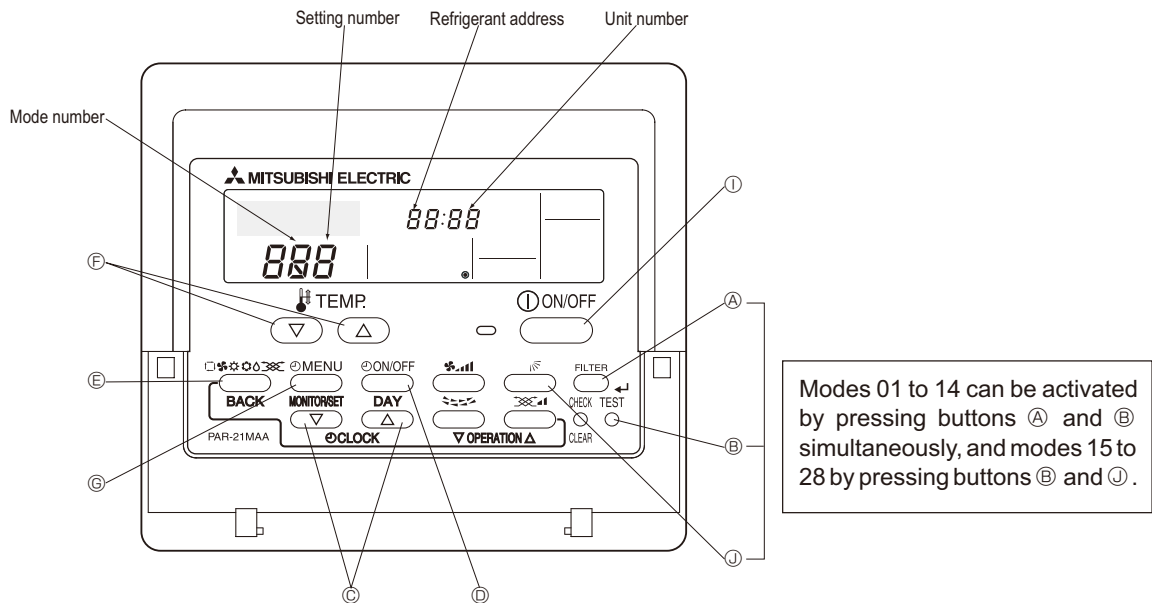

Selecting functions using the wired remote controller

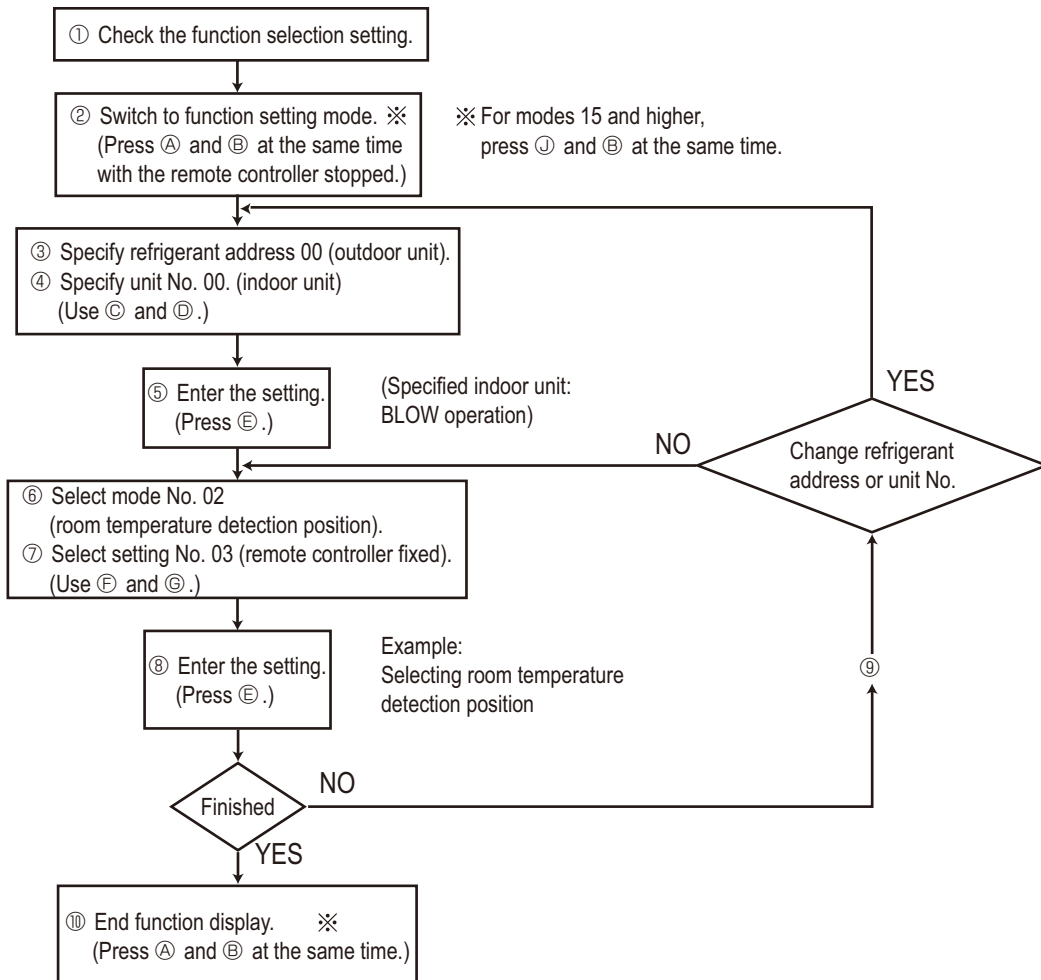

The above procedure must be carried out only if changes are necessary.

## [Operating Procedure]

① Check the setting items provided by function selection.

If settings for a mode are changed by function selection, the functions of that mode will be changed accordingly. Check all the current settings according to steps ② to ⑦, fill in the "Check" column in Table 1, then change them as necessary. For initial settings, refer to the indoor unit's installation manual.

② Switch off the remote controller.

- Ⓐ Hold down the **(FILTER)** (mode is 15 to 28) and **(TEST)** buttons simultaneously for at least 2 seconds. **FUNCTION SELECTION** will start to blink, then the remote controller's display content will change as shown below.



③ Set the outdoor unit's refrigerant address.

- Ⓒ Press the **(CLOCK)** buttons (**(▽)** and **(△)**) to select the desired refrigerant address. The refrigerant address changes from "00" to "15". (This operation is not possible for single refrigerant systems.)

\* If the unit stops after **FUNCTION SELECTION** blinked for 2 seconds or "88" blinks in the room temperature display area for 2 seconds, a transmission error may have occurred. Check to see if there are any sources of noise or interference near the transmission path.

Note  
If you have made operational mistakes during this procedure, exit function selection (see step ⑩) then restart from step ②.

④ Set the indoor unit number.

- Ⓓ Press the **(ON/OFF)** button so that "-" blinks in the unit number display area.

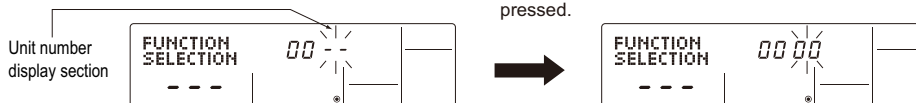

- Ⓒ Press the **(CLOCK)** buttons (**(▽)** and **(△)**) to select the unit number of the indoor unit for which you want to perform function selection. The unit number changes to "00", "01", "02", "03", "04" and "AL" each time a button is pressed.

\* To set modes 01 to 06 or 15 to 22, select unit number "00".

\* To set modes 07 to 14 or 23 to 28, carry out as follows:

- To set each indoor unit individually, select "01" to "04".
- To set all the indoor units collectively, select "AL".

⑤ Confirm the refrigerant address and unit number.

- Ⓔ Press the **(MODE)** button to confirm the refrigerant address and unit number. After a while, "-" will start to blink in the mode number display area.

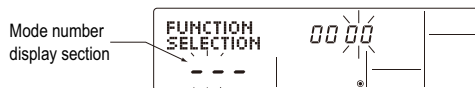

Ⓔ When the refrigerant address and unit number are confirmed by pressing the

- (MODE)** button, the corresponding indoor unit will start fan operation. This helps you find the location of the indoor unit for which you want to perform function selection. However, if "00" or "AL" is selected as the unit number, all the indoor units corresponding to the specified refrigerant address will start fan operation.

Example) When the refrigerant address is set to 00 and the unit number is 02.

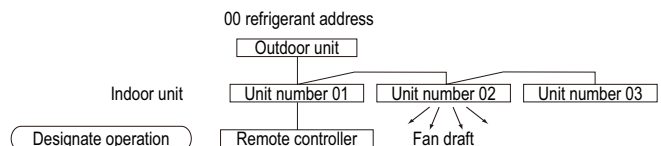

- \* "88" will blink in the room temperature display area if the selected refrigerant address does not exist in the system. Furthermore, if "F" appears and blinks in the unit number display area and the refrigerant address display area also blinks, there are no units that correspond to the selected unit number. In this case, the refrigerant address and unit number may be incorrect, so repeat steps ② and ③ to set the correct ones.

- \* When grouping different refrigerant systems, if an indoor unit other than the one to which the refrigerant address has been set to perform fan operation, there may be another refrigerant address that is the same as the specified one. In this case, check the DIP switch of the outdoor unit to see whether such a refrigerant address exists.

⑥ Select the mode number.

- Ⓕ Press the **(TEMP)** buttons (**(▽)** and **(△)**) to set the desired mode number. (Only the selectable mode numbers can be selected.)

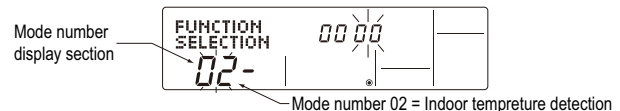

⑦ Select the setting content for the selected mode.

- Ⓖ Press the **(MENU)** button. The currently selected setting number will blink, so check the currently set content.

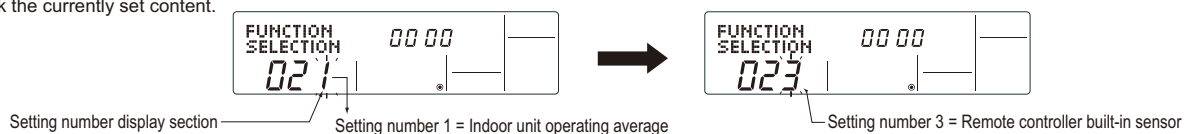

- Ⓖ Press the **(TEMP)** buttons (**(▽)** and **(△)**) to select the desired setting number.

⑧ Register the settings you have made in steps ③ to ⑦.

- Ⓗ Press the **(MODE)** button. The mode number and setting number will start to blink and registration starts.

The mode number and setting number will stop blinking and remain lit, indicating the end of registration.



\* If "-" is displayed for both the mode number and setting number and "88" blinks in the room temperature display area, a transmission error may have occurred. Check to see if there are any sources of noise or interference near the transmission path.

⑨ If you wish to continue to select other functions, repeat steps ③ to ⑧.

⑩ Complete function selection.

- Ⓐ Hold down the **(FILTER)** (mode is 15 to 28) and **(TEST)** buttons simultaneously for at least 2 seconds. After a while, the function selection screen will disappear and the air conditioner OFF screen will reappear.

\* Do not operate the remote controller for at least 30 seconds after completing function selection. (No operations will be accepted even if they are made.)

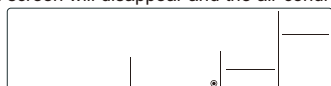

Note  
If a function of an indoor unit is changed by function selection after installation is complete, make sure that a "O" mark, etc., is given in the "Check" column of Table 1 to indicate the change.

## 11-1-2. Selecting functions using the wireless remote controller (Type C)

Functions can be selected with the wireless remote controller. Function selection using wireless remote controller is available only for refrigerant system with wireless function. Refrigerant address cannot be specified by the wireless remote controller.

### [Flow of function selection procedure]

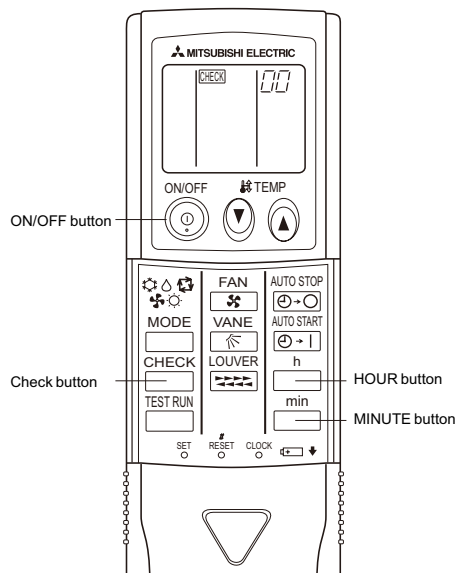

The flow of the function selection procedure is shown below. This example shows how to turn off the function that raises the set temperature by 4 degrees during HEAT operation.

The procedure is given after the flow chart.

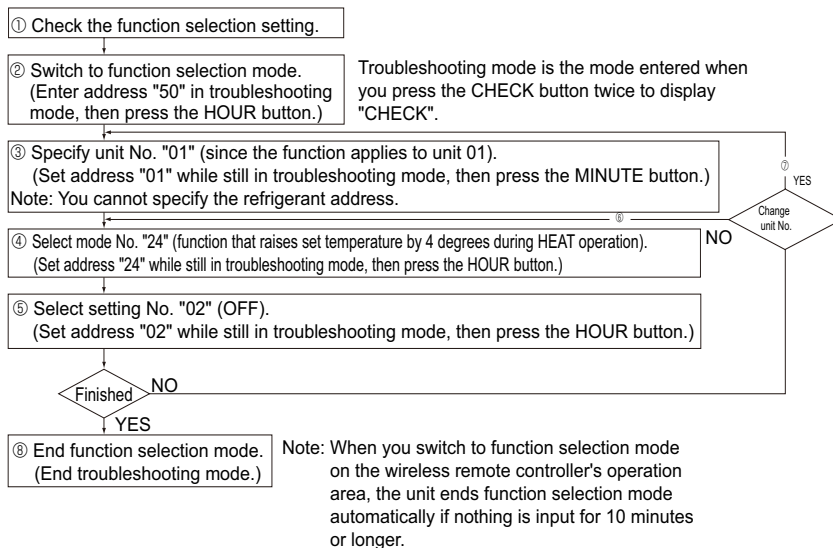

### [Operating instructions]

① Check the function settings.

② Press the button twice continuously. → is lit and "00" blinks.

Press the temp button once to set "50". Direct the wireless remote controller toward the receiver of the indoor unit and press the button.

③ Set the unit number.

Press the temp button to set the unit number. (Press "01" to specify the indoor unit whose unit number is 01.)

Direct the wireless remote controller toward the receiver of the indoor unit and press the button.

(By setting unit number with the button, specified indoor unit starts performing fan operation.

Detect which unit is assigned to which number using this function. If unit number is set to AL, all the indoor units in same refrigerant system start performing fan operation simultaneously.)

\* If a unit number that cannot be recognized by the unit is entered, 3 beeps of 0.4 seconds will be heard. Reenter the unit number setting.

\* If the signal was not received by the sensor, you will not hear a beep or a "double ping sound" may be heard. Reenter the unit number setting.

④ Select a mode.

Press the temp button to set a mode. Press "24" to turn on the function that raises the set temperature by 4 degree during heat operation. Direct the wireless remote controller toward the sensor of the indoor unit and press the button.

→ The sensor-operation indicator will blink and beeps will be heard to indicate the current setting number.

Current setting number: 1 = 1 beep (one second)

2 = 2 beeps (one second each)

3 = 3 beeps (one second each)

\* If a mode number that cannot be recognized by the unit is entered, 3 beeps of 0.4 seconds will be heard. Reenter the mode number.

\* If the signal was not received by the sensor, you will not hear a beep or a "double ping sound" may be heard. Reenter the mode number.

⑤ Select the setting number.

Press the temp button to select the setting number. (02: Not available)

Direct the wireless remote controller toward the receiver of the indoor unit and press the button.

→ The sensor-operation indicator will blink and beeps will be heard to indicate the setting number.

Setting number: 1 = 2 beeps (0.4 seconds each)

2 = 2 beeps (0.4 seconds each, repeated twice)

3 = 2 beeps (0.4 seconds each, repeated 3 times)

\* If a setting number that cannot be recognized by the unit is entered, the setting will turn back to the original setting.

\* If the signal was not received by the sensor, you will not hear a beep or a "double ping sound" may be heard. Reenter the setting number.

⑥ Repeat steps ④ and ⑤ to make an additional setting without changing unit number.

⑦ Repeat steps ③ to ⑤ to change unit number and make function settings on it.

⑧ Complete the function settings.

Press button.

\* Do not use the wireless remote controller for 30 seconds after completing the function setting.

## 11-2. FUNCTION SELECTION OF REMOTE CONTROLLER

The setting of the following remote controller functions can be changed using the remote controller function selection mode. Change the setting when needed.

Item 1	Item 2	Item 3 (Setting content)
1.Change language ("CHANGE LANGUAGE")	Language setting to display	• Display in multiple languages is possible.
2.Function limit ("FUNCTION SELECTION")	(1) Operation function limit setting (operation lock) ("LOCKING FUNCTION")	• Setting the range of operation limit (operation lock)
	(2) Use of automatic mode setting ("SELECT AUTO MODE")	• Setting the use or non-use of "automatic" operation mode
	(3) Temperature range limit setting ("LIMIT TEMP FUNCTION")	• Setting the temperature adjustable range (maximum, minimum)
3.Mode selection ("MODE SELECTION")	(1) Remote controller main/sub setting ("CONTROLLER MAIN/SUB")	• Selecting main or sub remote controller * When two remote controllers are connected to one group, one controller must be set to sub.
	(2) Use of clock setting ("CLOCK")	• Setting the use or non-use of clock function
	(3) Timer function setting ("WEEKLY TIMER")	• Setting the timer type
	(4) Contact number setting for error situation ("CALL.")	• Contact number display in case of error • Setting the telephone number
4.Display change ("DISP MODE SETTING")	(1) Temperature display °C/F setting ("TEMP MODE °C/F")	• Setting the temperature unit (°C or F) to display
	(2) Room air temperature display setting ("ROOM TEMP DISP SELECT")	• Setting the use or non-use of the display of indoor (suction) air temperature
	(3) Automatic cooling/heating display setting ("AUTO MODE DISP C/H")	• Setting the use or non-use of the display of "Cooling" or "Heating" display during operation with automatic mode

[Function selection flowchart] Refer to next page.

[1] Stop the air conditioner to start remote controller function selection mode. → [2] Select from item1. → [3] Select from item2. → [4] Make the setting. (Details are specified in item3) → [5] Setting completed. → [6] Change the display to the normal one. (End)

[Detailed setting]

### [4] -1. CHANGE LANGUAGE setting

The language that appears on the dot display can be selected.

- Press the [ ⊙ MENU ] button to change the language.
- ① Japanese (JP), ② English (GB), ③ German (D), ④ Spanish (E), ⑤ Russian (RU), ⑥ Italian (I), ⑦ Chinese (CH), ⑧ French (F)

### [4] -2. Function limit

#### (1) Operation function limit setting (operation lock)

- To switch the setting, press the [ ⊙ ON/OFF ] button.
- ① no1 : Operation lock setting is made on all buttons other than the [ ⊙ ON/OFF ] button.
- ② no2 : Operation lock setting is made on all buttons.
- ③ OFF (Initial setting value) : Operation lock setting is not made
- \* To make the operation lock setting valid on the normal screen, it is necessary to press buttons (Press and hold down the [ FILTER ] and [ ⊙ ON/OFF ] buttons at the same time for 2 seconds.) on the normal screen after the above setting is made.

#### (2) Use of automatic mode setting

When the remote controller is connected to the unit that has automatic operation mode, the following settings can be made.

- To switch the setting, press the [ ⊙ ON/OFF ] button.
- ① ON (Initial setting value) : The automatic mode is displayed when the operation mode is selected.
- ② OFF : The automatic mode is not displayed when the operation mode is selected.

#### (3) Temperature range limit setting

After this setting is made, the temperature can be changed within the set range.

- To switch the setting, press the [ ⊙ ON/OFF ] button.
- ① LIMIT TEMP COOL MODE :  
The temperature range can be changed on cooling/dry mode.
- ② LIMIT TEMP HEAT MODE :  
The temperature range can be changed on heating mode.
- ③ LIMIT TEMP AUTO MODE :  
The temperature range can be changed on automatic mode.
- ④ OFF (initial setting) : The temperature range limit is not active.
- \* When the setting, other than OFF, is made, the temperature range limit setting on cooling, heating and automatic mode is made at the same time. However the range cannot be limited when the set temperature range has not changed.
- To increase or decrease the temperature, press the [ ⬆ TEMP ( ▽ ) ] or [ ⬆ ] button.
- To switch the upper limit setting and the lower limit setting, press the [ ⚙ ] button. The selected setting will flash and the temperature can be set.
- Settable range  
Cooling/Dry mode : Lower limit: 19 °C ~ 30 °C Upper limit: 30 °C ~ 19 °C  
Heating mode : Lower limit: 17 °C ~ 28 °C Upper limit: 28 °C ~ 17 °C  
Automatic mode : Lower limit: 19 °C ~ 28 °C Upper limit: 28 °C ~ 19 °C

### [4] -3. Mode selection setting

#### (1) Remote controller main/sub setting

- To switch the setting, press the [ ⊙ ON/OFF ] button.
- ① Main : The controller will be the main controller.
- ② Sub : The controller will be the sub controller.

#### (2) Use of clock setting

- To switch the setting, press the [ ⊙ ON/OFF ] button.
- ① ON : The clock function can be used.
- ② OFF : The clock function cannot be used.

#### (3) Timer function setting

- To switch the setting, press the [ ⊙ ON/OFF ] button (Choose one of the followings.).
- ① WEEKLY TIMER (initial setting):  
The weekly timer can be used.
- ② AUTO OFF TIMER: The auto off timer can be used.
- ③ SIMPLE TIMER: The simple timer can be used.
- ④ TIMER MODE OFF: The timer mode cannot be used.
- \* When the use of clock setting is OFF, the "WEEKLY TIMER" cannot be used.

#### (4) Contact number setting for error situation

- To switch the setting, press the [ ⊙ ON/OFF ] button.
- ① CALL OFF : The set contact numbers are not displayed in case of error.
- ② CALL \*\*\*\* \* : The set contact numbers are displayed in case of error.  
CALL\_ : The contact number can be set when the display is as shown on the left.

- Setting the contact numbers

To set the contact numbers, follow the following procedures.

Move the flashing cursor to set numbers. Press the [ ⬆ TEMP ( ▽ ) ] and [ ⬆ ] button to move the cursor to the right (left). Press the [ ⊙ CLOCK ( ▽ ) ] and [ ⬆ ] button to set the numbers.

### [4] -4. Display change setting

#### (1) Temperature display °C/ F setting

- To switch the setting, press the [ ⊙ ON/OFF ] button.
- ① °C : The temperature unit °C is used.
- ② F : The temperature unit F is used.

#### (2) Room air temperature display setting

- To switch the setting, press the [ ⊙ ON/OFF ] button.
- ① ON : The room air temperature is displayed.
- ② OFF : The room air temperature is not displayed.

#### (3) Automatic cooling/heating display setting

- To switch the setting, press the [ ⊙ ON/OFF ] button.
- ① ON : One of "Automatic cooling" and "Automatic heating" is displayed under the automatic mode is running.
- ② OFF : Only "Automatic" is displayed under the automatic mode.

**[Function selection flowchart]**  
Setting language (English)

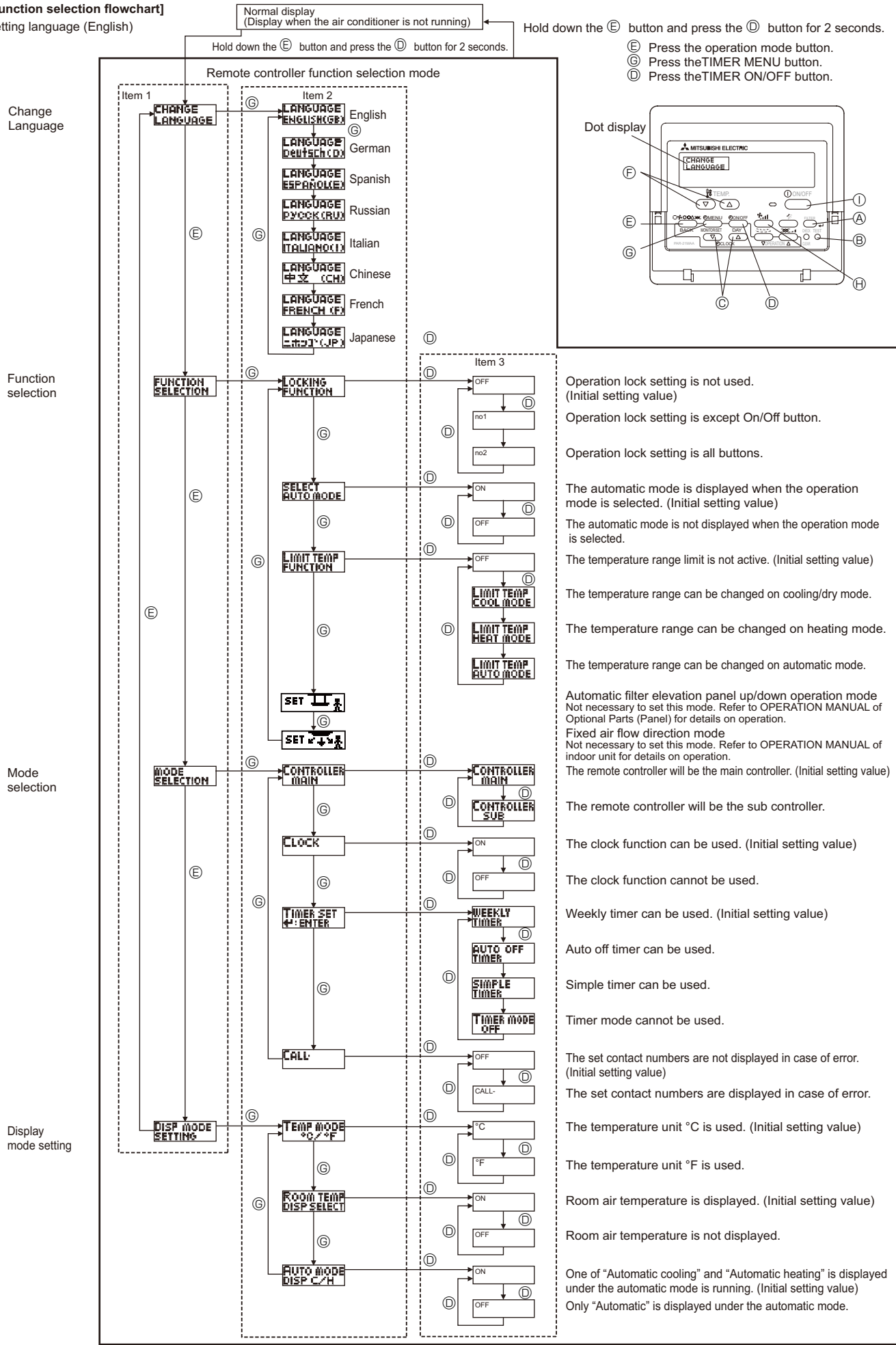

# 12 MONITORING THE OPERATION DATA BY THE REMOTE CONTROLLER

## 12-1. HOW TO "MONITOR THE OPERATION DATA"

- Turning on the [Monitoring the operation data]

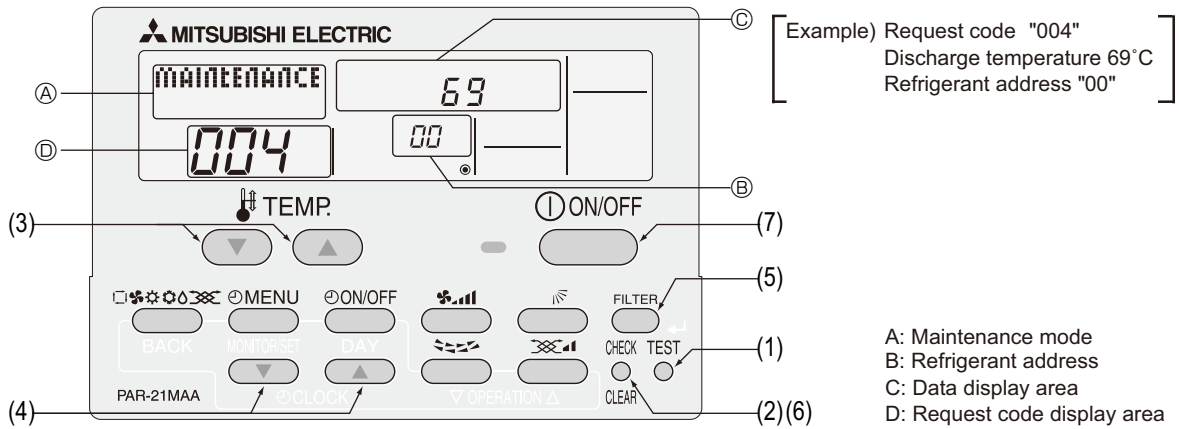

- (1) Press the **TEST** button for 3 seconds so that [ Maintenance mode] appears on the screen (at ①).
- (2) Press the **CHECK** button for 3 seconds to switch to [Maintenance monitor].  
 Note) It is not possible to switch to [Maintenance monitor] during data request in maintenance mode (i.e., while "----" is blinking) since no buttons are operative.

- Operating the service inspection monitor  
 [ - - - ] appears on the screen (at ②) when [Maintenance monitor] is activated.  
 (The display (at ②) now allows you to set a request code No.)

- (3) Press the [TEMP] buttons (**▽** and **△**) to select the desired refrigerant address.



- (4) Press the [CLOCK] buttons (**▽** and **△**) to set the desired request code No.
- (5) Press the **FILTER** button to perform data request.

(The requested data will be displayed at ③ in the same way as in maintenance mode.)

Data collected during operation of the remote controller will be displayed.  
 The collected data such as temperature data will not be updated automatically even if the data changes.  
 To display the updated data, carry out step (4) again.

- Canceling the Monitoring the operation data
- (6) While [Maintenance monitor] is displayed, press the **CHECK** button for 3 seconds to return to maintenance mode.
  - (7) To return to normal mode, press the **ON/OFF** button.



## 12-2. REQUEST CODE LIST

\* Certain indoor/outdoor combinations do not have the request code function; therefore, no request codes are displayed.

Request code	Request content	Description (Display range)	Unit	Remarks
0	Operation state	Refer to 12-2-1. Detail Contents in Request Code.	–	
1	Compressor-Operating current (rms)	0 – 50	A	
2	Compressor-Accumulated operating time	0 – 9999	10 hours	
3	Compressor-Number of operation times	0 – 9999	100 times	
4	Discharge temperature (TH4)	3 – 217	°C	
5	Outdoor unit - Liquid pipe 1 temperature (TH3)	-40 – 90	°C	
6	Outdoor unit - Liquid pipe 2 temperature	-40 – 90	°C	
7	Outdoor unit-2-phase pipe temperature (TH6)	-39 – 88	°C	
8				
9	Outdoor unit-Outside air temperature (TH7)	-39 – 88	°C	
10	Outdoor unit-Heatsink temperature (TH8)	-40 – 200	°C	
11				
12	Discharge superheat (SHd)	0 – 255	°C	
13	Sub-cool (SC)	0 – 130	°C	
14				
15				
16	Compressor-Operating frequency	0 – 255	Hz	
17	Compressor-Target operating frequency	0 – 255	Hz	
18	Outdoor unit-Fan output step	0 – 10	Step	
19	Outdoor unit-Fan 1 speed (Only for air conditioners with DC fan motor)	0 – 9999	rpm	
20	Outdoor unit-Fan 2 speed (Only for air conditioners with DC fan motor)	0 – 9999	rpm	"0" is displayed if the air conditioner is a single-fan type.
21				
22	LEV (A) opening	0 – 500	Pulses	
23	LEV (B) opening	0 – 500	Pulses	
24				
25	Primary current	0 – 50	A	
26	DC bus voltage	180 – 370	V	
27				
28				
29	Number of connected indoor units	0 – 4	Units	
30	Indoor unit-Setting temperature	17 – 30	°C	
31	Indoor unit-Intake air temperature <Measured by thermostat>	8 – 39	°C	
32	Indoor unit-Intake air temperature (Unit No. 1) <Heat mode-4-deg correction>	8 – 39	°C	"0" is displayed if the target unit is not present.
33	Indoor unit-Intake air temperature (Unit No. 2) <Heat mode-4-deg correction>	8 – 39	°C	↑
34	Indoor unit-Intake air temperature (Unit No. 3) <Heat mode-4-deg correction>	8 – 39	°C	↑
35	Indoor unit-Intake air temperature (Unit No. 4) <Heat mode-4-deg correction>	8 – 39	°C	↑
36				
37	Indoor unit - Liquid pipe temperature (Unit No. 1)	-39 – 88	°C	"0" is displayed if the target unit is not present.
38	Indoor unit - Liquid pipe temperature (Unit No. 2)	-39 – 88	°C	↑
39	Indoor unit - Liquid pipe temperature (Unit No. 3)	-39 – 88	°C	↑
40	Indoor unit - Liquid pipe temperature (Unit No. 4)	-39 – 88	°C	↑
41				
42	Indoor unit-Cond./Eva. pipe temperature (Unit No. 1)	-39 – 88	°C	"0" is displayed if the target unit is not present.
43	Indoor unit-Cond./Eva. pipe temperature (Unit No. 2)	-39 – 88	°C	↑
44	Indoor unit-Cond./Eva. pipe temperature (Unit No. 3)	-39 – 88	°C	↑
45	Indoor unit-Cond./Eva. pipe temperature (Unit No. 4)	-39 – 88	°C	↑
46				
47				
48	Thermo ON operating time	0 – 999	Minutes	
49	Test run elapsed time	0 – 120	Minutes	← Not possible to activate maintenance mode during the test run.



Request code	Request content	Description (Display range)	Unit	Remarks
50	Indoor unit-Control state	Refer to 12-2-1.Detail Contents in Request Code.	—	
51	Outdoor unit-Control state	Refer to 12-2-1.Detail Contents in Request Code.	—	
52	Compressor-Frequency control state	Refer to 12-2-1.Detail Contents in Request Code.	—	
53	Outdoor unit-Fan control state	Refer to 12-2-1.Detail Contents in Request Code.	—	
54	Actuator output state	Refer to 12-2-1.Detail Contents in Request Code.	—	
55	Error content (U9)	Refer to 12-2-1.Detail Contents in Request Code.	—	
56				
57				
58				
59				
60	Signal transmission demand capacity	0 – 255	%	
61	Contact demand capacity	Refer to 12-2-1.Detail Contents in Request Code.	—	
62	External input state (silent mode, etc.)	Refer to 12-2-1.Detail Contents in Request Code.	—	
63				
64				
65				
66				
67				
68				
69				
70	Outdoor unit-Capacity setting display	Refer to 12-2-1.Detail Contents in Request Code.	—	
71	Outdoor unit-Setting information	Refer to 12-2-1.Detail Contents in Request Code.	—	
72				
73	Outdoor unit-SW1 setting information	Refer to 12-2-1.Detail Contents in Request Code.	—	
74	Outdoor unit-SW2 setting information	Refer to 12-2-1.Detail Contents in Request Code.	—	
75				
76	Outdoor unit-SW4 setting information	Refer to 12-2-1.Detail Contents in Request Code.	—	
77	Outdoor unit-SW5 setting information	Refer to 12-2-1.Detail Contents in Request Code.	—	
78	Outdoor unit-SW6 setting information	Refer to 12-2-1.Detail Contents in Request Code.	—	
79	Outdoor unit-SW7 setting information	Refer to 12-2-1.Detail Contents in Request Code.	—	
80	Outdoor unit-SW8 setting information	Refer to 12-2-1.Detail Contents in Request Code.	—	
81	Outdoor unit-SW9 setting information	Refer to 12-2-1.Detail Contents in Request Code.	—	
82	Outdoor unit-SW10 setting information	Refer to 12-2-1.Detail Contents in Request Code.	—	
83				
84	M-NET adapter connection (presence/absence)	"0000": Not connected "0001": Connected	—	
85				
86				
87				
88				
89	Display of execution of replace/wash operation	"0000": Not washed "0001": Washed	—	
90	Outdoor unit-Microcomputer version information	Examples) Ver 5.01 → "0501"	Ver	
91	Outdoor unit-Microcomputer version information (sub No.)	Auxiliary information (displayed after version information) Examples) Ver 5.01 A000 → "A000"	—	
92				
93				
94				
95				
96				
97				
98				
99				
100	Outdoor unit - Error postponement history 1 (latest)	Displays postponement code. (" - - " is displayed if no postponement code is present)	Code	
101	Outdoor unit - Error postponement history 2 (previous)	Displays postponement code. (" - - " is displayed if no postponement code is present)	Code	
102	Outdoor unit - Error postponement history 3 (last but one)	Displays postponement code. (" - - " is displayed if no postponement code is present)	Code	



Request code	Request content	Description (Display range)	Unit	Remarks
103	Error history 1 (latest)	Displays error history. ("-" is displayed if no history is present.)	Code	
104	Error history 2 (second to last)	Displays error history. ("-" is displayed if no history is present.)	Code	
105	Error history 3 (third to last)	Displays error history. ("-" is displayed if no history is present.)	Code	
106	Abnormal thermistor display (TH3/TH6/TH7/TH8)	3 : TH3 6 : TH6 7 : TH7 8 : TH8 0 : No thermistor error	Sensor number	
107	Operation mode at time of error	Displayed in the same way as request code "0".	-	
108	Compressor-Operating current at time of error	0 – 50	A	
109	Compressor-Accumulated operating time at time of error	0 – 9999	10 hours	
110	Compressor-Number of operation times at time of error	0 – 9999	100 times	
111	Discharge temperature at time of error	3 – 217	°C	
112	Outdoor unit - Liquid pipe 1 temperature (TH3) at time of error	-40 – 90	°C	
113	Outdoor unit - Liquid pipe 2 temperature at time of error	-40 – 90	°C	
114	Outdoor unit-2-phase pipe temperature (TH6) at time of error	-39 – 88	°C	
115				
116	Outdoor unit-Outside air temperature (TH7) at time of error	-39 – 88	°C	
117	Outdoor unit-Heatsink temperature (TH8) at time of error	-40 – 200	°C	
118	Discharge superheat (SHd) at time of error	0 – 255	°C	
119	Sub-cool (SC) at time of error	0 – 130	°C	
120	Compressor-Operating frequency at time of error	0 – 255	Hz	
121	Outdoor unit at time of error • Fan output step	0 – 10	Step	
122	Outdoor unit at time of error • Fan 1 speed (Only for air conditioners with DC fan)	0 – 9999	rpm	
123	Outdoor unit at time of error • Fan 2 speed (Only for air conditioners with DC fan)	0 – 9999	rpm	"0" is displayed if the air conditioner is a single-fan type.
124				
125	LEV (A) opening at time of error	0 – 500	Pulses	
126	LEV (B) opening at time of error	0 – 500	Pulses	
127				
128				
129				
130	Thermostat ON time until operation stops due to error	0 – 999	Minutes	
131				
132	Indoor - Liquid pipe temperature at time of error	-39 – 88	°C	Average value of all indoor units is displayed if the air conditioner consists of two or more indoor units (twin, triple, quad).
133	Indoor-2-phase pipe temperature at time of error	-39 – 88	°C	Average value of all indoor units is displayed if the air conditioner consists of two or more indoor units (twin, triple, quad).
134	Indoor at time of error • Intake air temperature <Thermostat judge temperature>	-39 – 88	°C	
135				
136				
137				
138				
139				
140				
~				
146				
147				
148				
149				
150	Indoor-Actual intake air temperature	-39 – 88	°C	
151	Indoor - Liquid pipe temperature	-39 – 88	°C	
152	Indoor-2-phase pipe temperature	-39 – 88	°C	

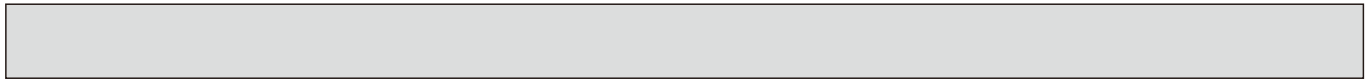

Request code	Request content	Description (Display range)	Unit	Remarks
153				
154	Indoor-Fan operating time (After filter is reset)	0 – 9999	1 hour	
155	Indoor-Total operating time (Fan motor ON time)	0 – 9999	10 hours	
156				
157	Indoor fan output value (Sj value)	0 – 255 Fan control data	–	For indoor fan phase control
158	Indoor fan output value (Pulsation ON/OFF)	"00 *** ****" indicates fan control data.	–	For indoor fan pulsation control
159	Indoor fan output value (duty value)	"00 *** ****" indicates fan control data.	–	For indoor DC brushless motor control
160				
161				
162	Indoor unit-Model setting information	Refer to 12-2-1 Detail Contents in Request Code.	–	
163	Indoor unit-Capacity setting information	Refer to 12-2-1 Detail Contents in Request Code.	–	
164	Indoor unit-SW3 information	Undefined	–	
165	Wireless pair No. (indoor control board side) setting	Refer to 12-2-1 Detail Contents in Request Code.	–	
166	Indoor unit-SW5 information	Undefined	–	
167				
~				
189				
190	Indoor unit-Microcomputer version information	Examples) Ver 5.01 → "0501"	Ver	
191	Indoor unit-Microcomputer version information (sub No.)	Auxiliary information (displayed after version information) Examples) Ver 5.01 A000 → "A000"	–	
192				
~				
764				
765	Stable operation (Heat mode)	This request code is not provided to collect data. It is used to fix the operation state.		
766	Stable operation (Cool mode)	This request code is not provided to collect data. It is used to fix the operation state.		
767	Stable operation cancellation	This request code is not provided to collect data. It is used to cancel the operation state that has been fixed by request codes "765" and "766".		

## 12-2-1. Detail Contents in Request Code

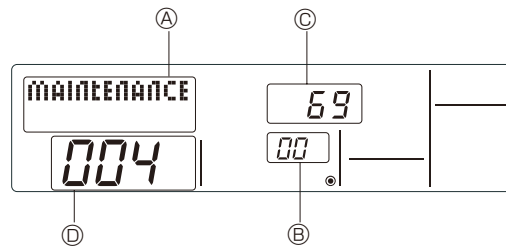

[ Example ) Request code "004"  
Discharge temperature 69°C  
Refrigerant address "00" ]

- A: Maintenance mode display
- B: Refrigerant address
- C: Data display area
- D: Request code display area

### [Operation state] (Request code "0")

Data display

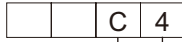

- Relay output state
- Operation mode

Operation mode

Display	Operation mode
0	STOP • FAN
C	COOL • DRY
H	HEAT
d	DEFROST

Relay output state

Display	Power currently supplied to compressor	Compressor	4-way valve	Solenoid valve
0	—	—	—	—
1				ON
2			ON	
3			ON	ON
4		ON		
5		ON		ON
6		ON	ON	
7		ON	ON	ON
8	ON			
A	ON		ON	

### [Indoor unit – Control state] (Request code : "50")

Data display



- Unit No. 4 state
- Unit No. 3 state
- Unit No. 2 state
- Unit No. 1 state

Display	State
0	Normal
1	Preparing for heat operation
2	—
3	—
4	Heater is ON.
5	Anti-freeze protection is ON.
6	Overheat protection is ON.
7	Requesting compressor to turn OFF
F	There are no corresponding units.

### [Outdoor unit – Control state] (Request code "51")

Data display	State
0 0 0 0	Normal
0 0 0 1	Preparing for heat operation
0 0 0 2	Defrost

### [Compressor – Frequency control state] (Request code "52")

Data display

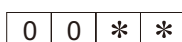

- Frequency control state ②
- Frequency control state ①

Frequency control state ①

Display	Current limit control
0	No current limit
1	Primary current limit control is ON.
2	Secondary current limit control is ON.

Frequency control state ②

Display	Discharge temperature overheat prevention	Condensation temperature overheat prevention	Anti-freeze protection control	Heatsink temperature overheat prevention
0				
1	Controlled			
2		Controlled		
3	Controlled	Controlled		
4			Controlled	
5	Controlled		Controlled	
6		Controlled	Controlled	
7	Controlled	Controlled	Controlled	
8				Controlled
9	Controlled			Controlled
A		Controlled		Controlled
b	Controlled	Controlled		Controlled
C			Controlled	Controlled
d	Controlled		Controlled	Controlled
E		Controlled	Controlled	Controlled
F	Controlled	Controlled	Controlled	Controlled

**[Fan control state] (Request code : "53")**

Data display 

0	0	*	*
---	---	---	---

— Fan step correction value by heatsink temperature overheat prevention control  
 — Fan step correction value by cool condensation temperature overheat prevention control

Display	Correction value
- (minus)	- 1
0	0
1	+1
2	+2

**[Actuator output state] (Request code : "54")**

Data display 

0	0	*	*
---	---	---	---

— Actuator output state ①  
 — Actuator output state ②

**Actuator output state ①**

Display	SV1	Four-way valve	Compressor	Compressor is warming up
0				
1	ON			
2		ON		
3	ON	ON		
4			ON	
5	ON		ON	
6		ON	ON	
7	ON	ON	ON	
8				ON
9	ON			ON
A		ON		ON
b	ON	ON		ON
C			ON	ON
d	ON		ON	ON
E		ON	ON	ON
F	ON	ON	ON	ON

**Actuator output state ②**

Display	52C	SV2	SS
0			
1	ON		
2		ON	
3	ON	ON	
4			ON
5	ON		ON
6		ON	ON
7	ON	ON	ON

**[Error content (U9)] (Request code : "55")**

Data display 

0	0	*	*
---	---	---	---

— Error content ①  
 — Error content ②

**Error content ①**

● : Detected

Display	Oversvoltage error	Undersvoltage error	L1-phase open error	Power synchronizing signal error
0				
1	●			
2		●		
3	●	●		
4			●	
5	●		●	
6		●	●	
7	●	●	●	
8				●
9	●			●
A		●		●
b	●	●		●
C			●	●
d	●		●	●
E		●	●	●
F	●	●	●	●

**Error content ②**

● : Detected

Display	Converter Fo error	PAM error
0		
1	●	
2		●
3	●	●

**[Contact demand capacity] (Request code "61")**

Data display 

0	0	0	*
---	---	---	---

 Setting content

Setting content

Display	Setting value	Setting	
		SW7-1	SW7-2
0	0%		
1	50%	ON	
2	75%		ON
3	100%	ON	ON

**[External input state] (Request code "62")**

Data display 

0	0	0	*
---	---	---	---

 Input state

Input state

● : Input present

Display	Contact demand input	Silent mode input	Spare 1 input	Spare 2 input
0				
1	●			
2		●		
3	●	●		
4			●	
5	●		●	
6		●	●	
7	●	●	●	
8				●
9	●			●
A		●		●
b	●	●		●
C			●	●
d	●		●	●
E		●	●	●
F	●	●	●	●

**[Outdoor unit –Capacity setting display] (Request code : "70")**

Data display	Capacity
9	35
10	50
11	60
14	71
20	100
25	125
28	140
40	200
50	250

**[Outdoor unit – Setting information] (Request code "71")**

Data display 

0	0	*	*
---	---	---	---

 Setting information ①  
Setting information ②

Setting information ①

Display	Defrost mode
0	Standard
1	For high humidity

Setting information ②

Display	Single-/3-phase	Heat pump/cooling only
0	Single-phase	Heat pump
1		Cooling only
2	3-phase	Heat pump
3		Cooling only

**[Outdoor unit switch setting display (SW1 to SW10, except SW3)] Request codes: 73 to 82**

0: Switch OFF 1: Switch ON

SW1, SW2, SW6, SW7						Data display
1	2	3	4	5	6	
0	0	0	0	0	0	00 00
1	0	0	0	0	0	00 01
0	1	0	0	0	0	00 02
1	1	0	0	0	0	00 03
0	0	1	0	0	0	00 04
1	0	1	0	0	0	00 05
0	1	1	0	0	0	00 06
1	1	1	0	0	0	00 07
0	0	0	1	0	0	00 08
1	0	0	1	0	0	00 09
0	1	0	1	0	0	00 0A
1	1	0	1	0	0	00 0b
0	0	1	1	0	0	00 0C
1	0	1	1	0	0	00 0d
0	1	1	1	0	0	00 0E
1	1	1	1	0	0	00 0F
0	0	0	0	1	0	00 10
1	0	0	0	1	0	00 11
0	1	0	0	1	0	00 12
1	1	0	0	1	0	00 13
0	0	1	0	1	0	00 14
1	0	1	0	1	0	00 15
0	1	1	0	1	0	00 16
1	1	1	0	1	0	00 17
0	0	0	1	1	0	00 18
1	0	0	1	1	0	00 19
0	1	0	1	1	0	00 1A
1	1	0	1	1	0	00 1B
0	0	1	1	1	0	00 1C
1	0	1	1	1	0	00 1D
0	1	1	1	1	0	00 1E
1	1	1	1	1	0	00 1F
0	0	0	0	0	1	00 20
1	0	0	0	0	1	00 21
0	1	0	0	0	1	00 22
1	1	0	0	0	1	00 23
0	0	1	0	0	1	00 24
1	0	1	0	0	1	00 25
0	1	1	0	0	1	00 26
1	1	1	0	0	1	00 27
0	0	0	1	0	1	00 28
1	0	0	1	0	1	00 29
0	1	0	1	0	1	00 2A
1	1	0	1	0	1	00 2B
0	0	1	1	0	1	00 2C
1	0	1	1	0	1	00 2D
0	1	1	1	0	1	00 2E
1	1	1	1	0	1	00 2F
0	0	0	0	1	1	00 30
1	0	0	0	1	1	00 31
0	1	0	0	1	1	00 32
1	1	0	0	1	1	00 33
0	0	1	0	1	1	00 34
1	0	1	0	1	1	00 35
0	1	1	0	1	1	00 36
1	1	1	0	1	1	00 37
0	0	0	1	1	1	00 38
1	0	0	1	1	1	00 39
0	1	0	1	1	1	00 3A
1	1	0	1	1	1	00 3B
0	0	1	1	1	1	00 3C
1	0	1	1	1	1	00 3D
0	1	1	1	1	1	00 3E
1	1	1	1	1	1	00 3F

0: Switch OFF 1: Switch ON

SW5				Data display
1	2	3	4	
0	0	0	0	00 00
1	0	0	0	00 01
0	1	0	0	00 02
1	1	0	0	00 03
0	0	1	0	00 04
1	0	1	0	00 05
0	1	1	0	00 06
1	1	1	0	00 07
0	0	0	1	00 08
1	0	0	1	00 09
0	1	0	1	00 0A
1	1	0	1	00 0b
0	0	1	1	00 0C
1	0	1	1	00 0d
0	1	1	1	00 0E
1	1	1	1	00 0F

0: Switch OFF 1: Switch ON

SW8			Data display
1	2	3	
0	0	0	00 00
1	0	0	00 01
0	1	0	00 02
1	1	0	00 03
0	0	1	00 04
1	0	1	00 05
0	1	1	00 06
1	1	1	00 07

0: Switch OFF 1: Switch ON

SW4, SW9, SW10		Data display
1	2	
0	0	00 00
1	0	00 01
0	1	00 02
1	1	00 03



**[Indoor unit – Model setting information] (Request code : 162)**

Data display

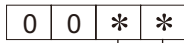

See the table on the right.

Display	Model setting state	Display	Model setting state
00	PSA-RP-GA, PSH-PGAH	20	
01		21	PKA-RP-FAL(2), PKH-P-FALH
02	PEAD-RP-EA(2)/GA, PEHD-P-EAH	22	PCA-RP-GA(2), PCH-P-GAH, PLA-RP-BA
03	SEZ-KA-VA	23	
04		24	
05	SLZ-KA-VA(L)	25	
06	PCA-RP-HA	26	
07		27	
08		28	
09	PEA-RP400/500GA	29	
0A		2A	
0b	PEA-RP200/250GA	2b	PKA-RP-GAL, PKH-P-GALH
0C		2C	
0d		2d	
0E		2E	
0F		2F	PLA-RP-AA
10		30	
11	PEA-RP-EA	31	PLH-P-AAH
12	MEXZ-GA-VA(L)	32	
13		33	
14		34	
15		35	
16		36	PLA-RP-AA2
17		37	
18		38	
19		39	
1A		3A	
1b		3b	
1C		3C	
1d		3d	
1E		3E	
1F		3F	

**[Indoor unit – Capacity setting information] (Request code 163 )**

Data display



See the table on the right.

Display	Capacity setting state	Display	Capacity setting state
00	12	10	112
01	16	11	125
02	22	12	140
03	25	13	
04	28	14	
05	32	15	
06	35, 36	16	
07	40	17	
08	45	18	
09	50	19	
0A	56	1A	
0b	63	1b	
0C	71	1C	
0d	80	1d	
0E	90	1E	
0F	100	1F	

**[Wireless pair No. (indoor control board side) setting] (Request code 165 )**

Data display

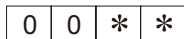

See the table on the right.

Display	Pair No. setting state
00	No. 0
01	No. 1 J41 disconnected
02	No. 2 J42 disconnected
03	No. 3 J41, J42 disconnected

- Reduces maintenance work drastically.
- Enables you to check operation data of the indoor and outdoor units by remote controller. Furthermore, use of maintenance stable-operation control that fixes the operating frequency, allows smooth inspection, even for inverter models.

Smooth Maintenance Function

**Discharge temperature 64°C**

● Conventional inspection work

Easy maintenance information (unit)

Compressor		Outdoor unit		Indoor unit	
①	Accumulated operating time (x10 hours)	④	Heat exchanger temperature (°C)	⑦	Intake air temperature (°C)
②	Number of ON/OFF times (x10 times)	⑤	Discharge temperature (°C)	⑧	Heat exchanger temperature (°C)
③	Operating current (A)	⑥	Outside air temperature (°C)	⑨	Filter operating time* (Hours)

\* The filter operating time is the time that has elapsed since the filter was reset.

## 13-1. MAINTENANCE MODE OPERATION METHOD

\* If you are going to use 13-2. "GUIDE FOR OPERATION CONDITION", set the airflow to "High" before activating maintenance mode.

### ● Switching to maintenance mode

Maintenance mode can be activated either when the air conditioner is operated or stopped. It cannot be activated during test run.

※ Maintenance information can be viewed even if the air conditioner is stopped.

#### ■ Remote controller button information

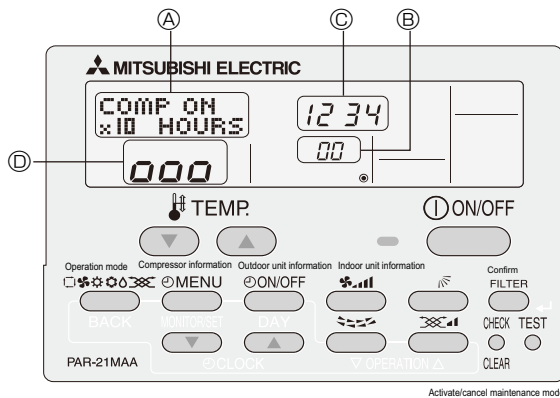

(1) Press the **TEST** button for 3 seconds to switch to maintenance mode.

[Display **A**] MAINTENANCE

If stable operation is unnecessary or if you want to check the data with the air conditioner stopped, skip to step (4).

### ● Fixed Hz operation

The operating frequency can be fixed to stabilize operation of inverter model. If the air conditioner is currently stopped, start it by this operation.

(2) Press the **MODE** button to select the desired operation mode.

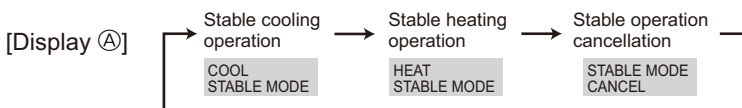

(3) Press the **FILTER** button to confirm the setting.



● **Data measurement**

When the operation is stabilized, measure operation data as explained below.

➤(4) Press the [TEMP] buttons ( ) and ( ) to select the desired refrigerant address.



➤(5) Select the type of data to be displayed.

After selecting, go to step (6).

**Compressor information**

MENU button

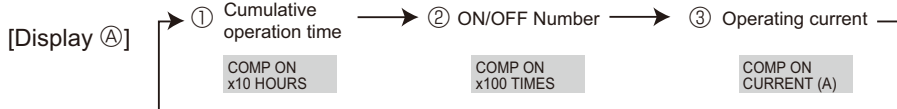

**Outdoor unit information**

ON/OFF button

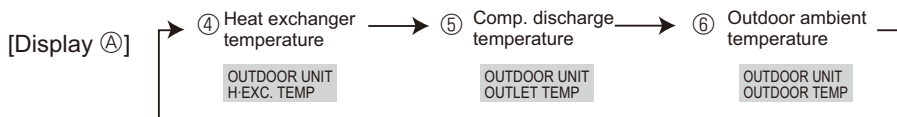

**Indoor unit information**

Filter button

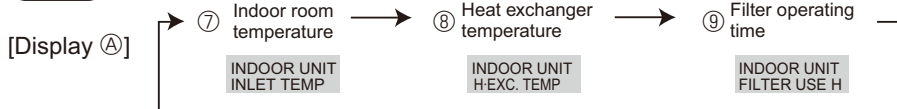

(6) Press the **FILTER** () button to confirm the setting.

[Display example for accumulated operating time]

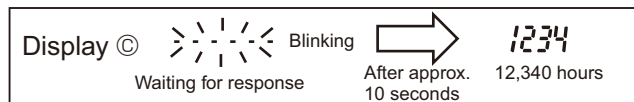

(7) Data is displayed on the display (at ⑤).

**To check the data for each item, repeat steps (5) to (7).**

(8) To cancel maintenance mode, press the **TEST** button for 3 seconds or press the ON/OFF button.

■ **Refrigerant address**

Single refrigerant system

In the case of single refrigerant system, the refrigerant address is "00" and no operation is required. Simultaneous twin, triple and quadruple units belong to this category (Single refrigerant system).

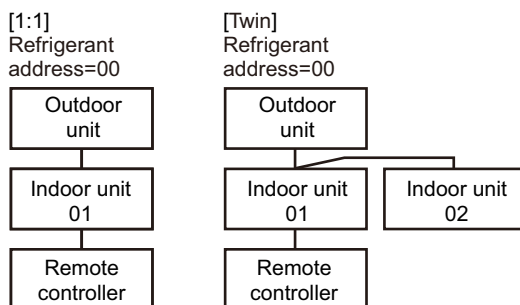

Multi refrigerant system (group control)

Up to 16 refrigerant systems (16 outdoor units) can be connected as a group by 1 remote controller. To check or set the refrigerant addresses.

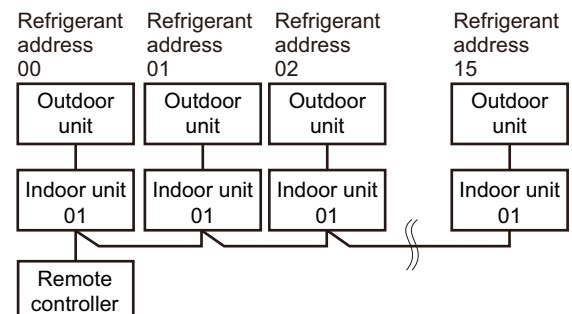

## 13-2. GUIDE FOR OPERATION CONDITION

		Inspection item		Result	
Power supply	Loose connection	Terminal block	Breaker	Good	Retightened
			Outdoor Unit	Good	Retightened
			Indoor Unit	Good	Retightened
		(Insulation resistance)			MΩ
	(Voltage)			V	
Compressor		① Accumulated operating time			Time
		② Number of ON/OFF times			Times
		③ Current			A
Outdoor Unit	Temperature	④ Refrigerant/heat exchanger temperature	COOL	°C	HEAT °C
		⑤ Refrigerant/discharge temperature	COOL	°C	HEAT °C
		⑥ Air/outside air temperature	COOL	°C	HEAT °C
		(Air/discharge temperature)	COOL	°C	HEAT °C
	Cleanliness	Appearance	Good		Cleaning required
		Heat exchanger	Good		Cleaning required
	Sound/vibration	None		Present	
Indoor Unit	Temperature	⑦ Air/intake air temperature	COOL	°C	HEAT °C
		(Air/discharge temperature)	COOL	°C	HEAT °C
		⑧ Refrigerant/heat exchanger temperature	COOL	°C	HEAT °C
		⑨ Filter operating time*			Time
	Cleanliness	Decorative panel	Good		Cleaning required
		Filter	Good		Cleaning required
		Fan	Good		Cleaning required
		Heat exchanger	Good		Cleaning required
		Sound/vibration	None		Present

\* The filter operating time is the time that has elapsed since the filter was reset.

Area	Check item	Judgment	
		Cool	Heat
Normal	Normal operation state		
Filter inspection	Filter may be clogged. *1		
Inspection A	Performance has dropped. Detailed inspection is necessary.		
Inspection B	Refrigerant amount is dropping.		
Inspection C	Filter or indoor heat exchanger may be clogged.		

\* The above judgement is just a guide based on Japanese standard conditions.

It may be changed depending on the indoor and outdoor temperature.

\*1 It may be judged as "Filter inspection" due to the outdoor and indoor temperature, even though it is not clogged.

## Check Points

Enter the temperature differences between ⑤, ④, ⑦ and ⑧ into the graph given below.

Operation state is determined according to the plotted areas on the graph.

For data measurements, set the fan speed to "Hi" before activating maintenance mode.

Classification	Item	Result	
Cool	Inspection	Is "D000" displayed stably on the remote controller?	
	Temperature difference	(⑤ Discharge temperature) – (④ Outdoor heat exchanger temperature) – (⑦ Indoor intake air temperature) – (⑧ Indoor heat exchanger temperature)	Stable / Unstable
Heat	Inspection	Is "D000" displayed stably on the remote controller?	
	Temperature difference	(⑤ Discharge temperature) – (⑧ Indoor heat exchanger temperature) – (⑧ Indoor heat exchanger temperature) – (⑦ Indoor intake air temperature)	Stable / Unstable

\* Fixed Hz operation may not be possible under the following temperature ranges.

A) In cool mode, outdoor intake air temperature is 40 °C or higher or indoor intake air temperature is 23 °C or lower.



B) In heat mode, outdoor intake air temperature is 20 °C or higher or indoor intake air temperature is 25 °C or lower.

\* If the air conditioner is operated at a temperature range other than the ones above but operation is not stabilized after 30 minutes or more have elapsed, carry out inspection.

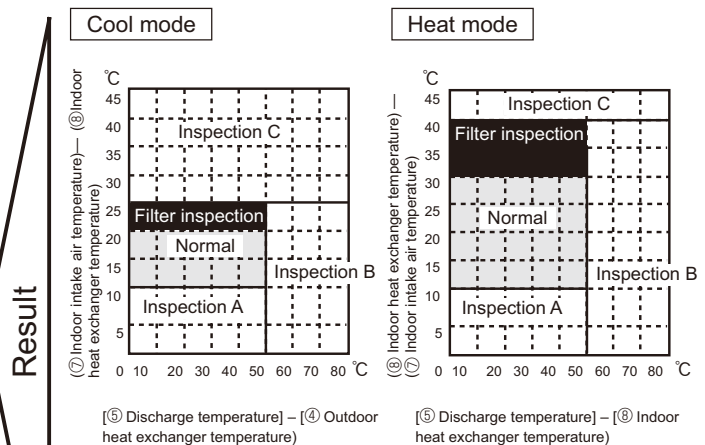
\* In heat mode, the operation state may vary due to frost forming on the outdoor heat exchanger.

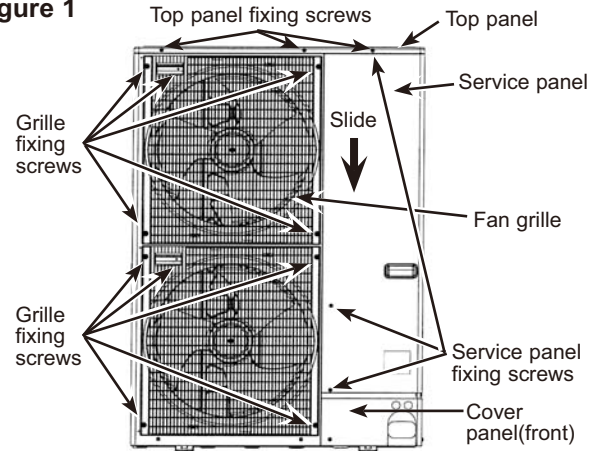
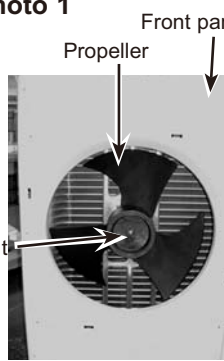
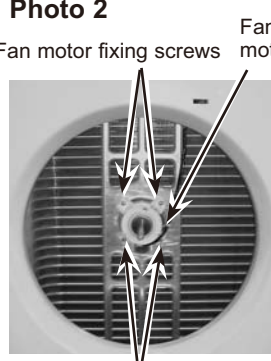

PUHZ-RP200YHA2 PUHZ-RP250YHA2

OPERATING PROCEDURE	PHOTOS & ILLUSTRATION
<p><b>1. Removing the service panel and top panel</b></p> <p>(1) Remove 3 service panel fixing screws (5 × 10) and slide the hook on the right downward to remove the service panel.</p> <p>(2) Remove screws (3 for front, 3 for rear/5 × 10) of the top panel and remove it.</p>	<p><b>Figure 1</b></p> 
<p><b>2. Removing the fan motor (MF1, MF2)</b></p> <p>(1) Remove the service panel. (See figure 1.)</p> <p>(2) Remove the top panel. (See figure 1.)</p> <p>(3) Remove 5 fan grille fixing screws (5 × 10) to detach the fan grille. (See figure 1.)</p> <p>(4) Remove a nut (for right handed screw of M6) to detach the propeller. (See photo 1.)</p> <p>(5) Disconnect the connectors, CNF1 and CNF2 on controller circuit board in electrical parts box.</p> <p>(6) Remove 4 fan motor fixing screws (5 × 25) to detach the fan motor. (See photo 2.)</p>	<p><b>Photo 1</b></p>  <p><b>Photo 2</b></p>  <p>Fan motor fixing screws</p>
<p><b>3. Removing the electrical parts box</b></p> <p>(1) Remove the service panel. (See figure 1.)</p> <p>(2) Remove the top panel. (See figure 1.)</p> <p>(3) Disconnect the indoor/outdoor connecting wire and power supply wire from terminal block.</p> <p>(4) Disconnect the connectors on the controller circuit board.</p> <p>(5) Remove the terminal cover and disconnect the compressor lead wire.</p> <p>(6) Remove an electrical parts box fixing screw (4 × 10) and detach the electrical parts box by pulling it upward. The electrical parts box is fixed with 2 hooks on the left and 1 hook on the right.</p>	<p><b>Photo 3</b></p> 

## OPERATING PROCEDURE

### 4. Removing the thermistor <Outdoor 2-phase pipe> (TH6)

- (1) Remove the service panel. (See figure 1.)
- (2) Remove the top panel. (See figure 1.)
- (3) Disconnect the connectors, TH6 and TH7 (red), on the controller circuit board in the electrical parts box.
- (4) Loosen the 2 wire clamps on top of the electrical parts box.
- (5) Pull out the thermistor <Outdoor 2-phase pipe> (TH6) from the sensor holder.

**Note:** In case of replacing thermistor <Outdoor 2-phase pipe> (TH6), replace it together with thermistor <Outdoor> (TH7) since they are combined together. Refer to No.6 below to remove thermistor <Outdoor>.

### 5. Removing the thermistor <Outdoor> (TH7)

- (1) Remove the service panel. (See figure 1.)
- (2) Remove the top panel. (See figure 1.)
- (3) Disconnect the connector TH7 (red) on the controller circuit board in the electrical parts box.
- (4) Loosen the 2 wire clamps on top of the electrical parts box. (See photo 4.)
- (5) Pull out the thermistor <Outdoor> (TH7) from the sensor holder.

**Note:** In case of replacing thermistor <Outdoor> (TH7), replace it together with thermistor <Outdoor 2-phase pipe> (TH6), since they are combined together. Refer to No.5 above to remove thermistor <Outdoor 2-phase pipe>.

### 6. Removing the thermistor <Outdoor pipe> (TH3) and thermistor <Discharge> (TH4)

- (1) Remove the service panel. (See figure 1.)
- (2) Disconnect the connectors, TH3 (white) and TH4 (white) on the controller circuit board in the electrical parts box.
- (3) Loosen the clamp for the lead wire in the rear of the electrical parts box.

#### [Removing the thermistor<Outdoor pipe>(TH3)]

- (4) Pull out the thermistor <Outdoor pipe> (TH3) from the sensor holder.

#### [Removing the thermistor<Discharge>(TH4)]

For RP200

- (4) Remove the soundproof cover(upper) for compressor.
- (5) Pull out the thermistor <Discharge> (TH4) from the thermo-holder of the compressor shell.

For RP250

- (4) Pull out the thermistor <Discharge> (TH4) from the sensor holder.

## PHOTOS

Photo 4

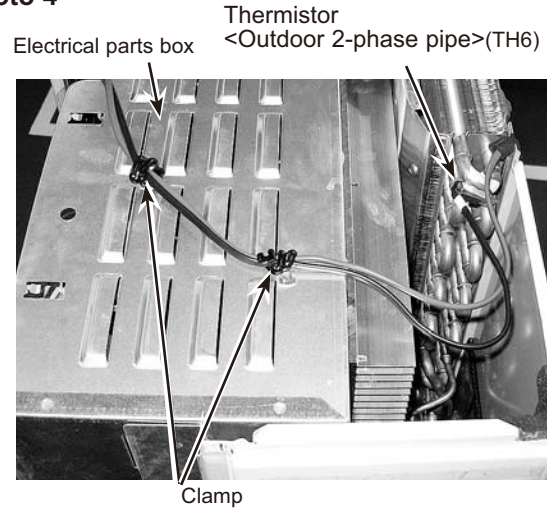

Photo 5

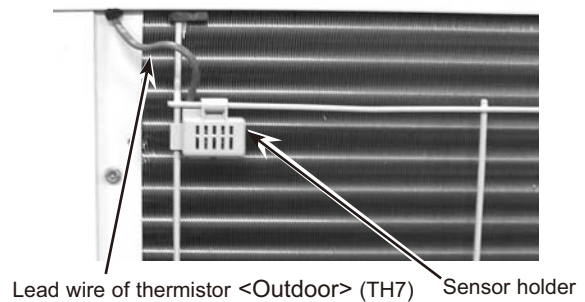
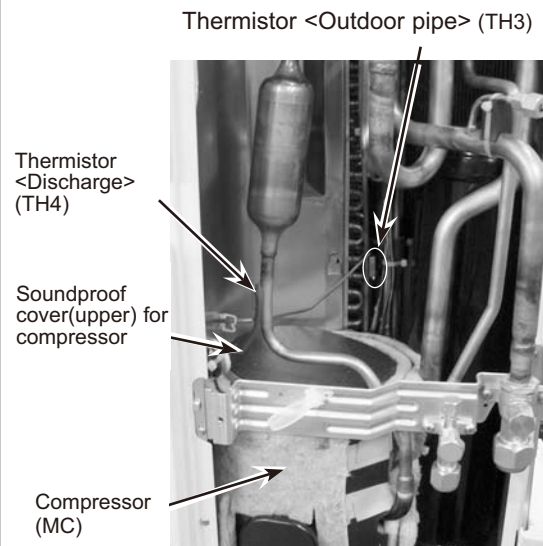

Photo 6

(Photo:PUHZ-RP250YHA2)



## OPERATING PROCEDURE

### 7. Removing the 4-way valve coil (21S4) and linear expansion valve coil (LEV-A, LEV-B) and bypass valve coil(SV)

- (1) Remove the service panel. (See figure 1.)
- (2) Remove the top panel. (See figure 1.)
- (3) Remove the electrical parts box. (See photo 3.)

#### [Removing the 4-way valve coil]

- (4) Remove 4-way valve coil fixing screw (M4 × 6).
- (5) Remove the 4-way valve coil by sliding the coil toward you.

#### [Removing the linear expansion valve coil]

- (4) Remove the linear expansion valve coil by sliding the coil upward.

#### [Removing the bypass valve coil]

- (4) Remove bypass valve coil fixing screw (M4 × 6).
- (5) Remove the bypass valve coil by sliding the coil upward.

### 8. Removing the 4-way valve and bypass valve

- (1) Remove the service panel. (See figure 1.)
- (2) Remove the top panel. (See figure 1.)
- (3) Remove the electrical parts box. (See photo 3.)
- (4) Remove 3 valve bed fixing screws (4 × 10), 4 ball valve and stop valve fixing screws (5 × 16) then remove the valve bed.
- (5) Remove 3 right side panel fixing screws (5 × 10) in the rear of the unit then remove the right side panel.

#### [Removing the 4-way valve]

- (6) Remove the 4-way valve coil.
- (7) Recover refrigerant.
- (8) Remove the welded part of 4-way valve.

#### [Removing the bypass valve]

- (6) Remove bypass valve coil.
- (7) Recover refrigerant.
- (8) Remove the welded part of bypass valve.

### 9. Removing the linear expansion valve

- (1) Remove the service panel. (See figure 1.)
- (2) Remove the top panel. (See figure 1.)
- (3) Remove 3 valve bed fixing screws (4 × 10), 4 ball valve and stop valve fixing screws (5 × 16) then remove the valve bed.
- (4) Remove 4 right side panel fixing screws (5 × 10) in the rear of the unit then remove the right side panel.
- (5) Remove the linear expansion valve coil.
- (6) Recover refrigerant.
- (7) Remove the welded part of linear expansion valve.

## PHOTOS

Photo 7

(Photo:PUHZ-RP200YHA2)

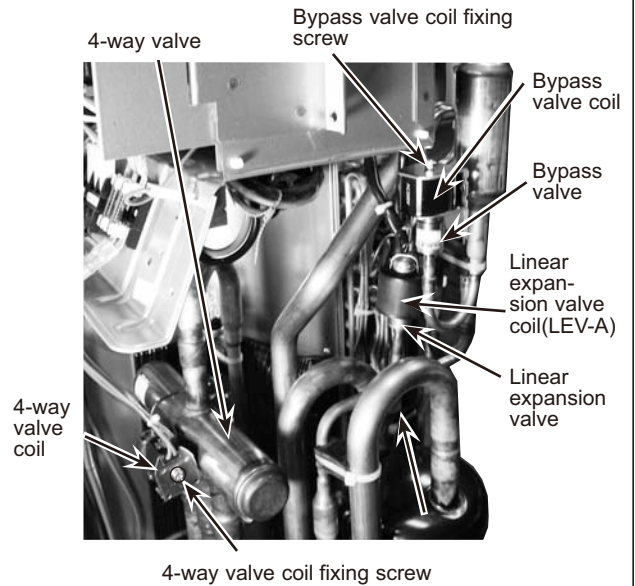

**Note 1:** Recover refrigerant without spreading it in the air.

**Note 2:** The welded part can be removed easily by removing the right side panel.

**Note 3:** When installing the parts of refrigerant circuit, cover it with a wet cloth to prevent it from heating (120°C or more), then braze the pipes so that the inside of pipes are not oxidized.

## OPERATING PROCEDURE

### 10. Removing the high pressure switch (63H)(63H1)(63H2) and the low pressure switch (63L)

- (1) Remove the service panel. (See figure 1.)
- (2) Remove the top panel. (See figure 1.)
- (3) Remove 3 right side panel fixing screws (5 × 10) in the rear of the unit and remove the right side panel.
- (4) Pull out the lead wire of high pressure switch and low pressure switch.
- (5) Recover refrigerant.
- (6) Remove the welded part of high pressure switch and low pressure switch.

63H(For RP200)  
63H1, 63H2, 63L(For RP250)

**Note 1:** Recover refrigerant without spreading it in the air.

**Note 2:** The welded part can be removed easily by removing the right side panel.

**Note 3:** When installing the parts of refrigerant circuit, cover it with a wet cloth to prevent it from heating (100°C or more), then braze the pipes so that the inside of pipes are not oxidized.

## PHOTOS

Photo 8

(Photo:PUHZ-RP200YHA2)



High pressure switch

### 11. Removing the compressor (MC)

- (1) Remove the service panel. (See figure 1.)
- (2) Remove the top panel. (See figure 1.)
- (3) Remove 2 front cover panel fixing screws (5 × 10) and remove the front cover panel.
- (4) Remove 2 back cover panel fixing screws (5 × 10) and remove the back cover panel.
- (5) Remove the electrical parts box. (See photo 3.)
- (6) Remove 3 valve bed fixing screws (4 × 10), 4 ball valve and stop valve fixing screws (5 × 16), then remove the valve bed.
- (7) Remove 3 right side panel fixing screws (5 × 10) in the rear of the unit and remove the right side panel.
- (8) Remove 3 separator fixing screws (4 × 10) and remove the separator.
- (9) Remove the soundproof cover for compressor.
- (10) Remove the terminal cover and remove the compressor lead wire.
- (11) Recover refrigerant.
- (12) Remove the 3 points of the compressor fixing nut using a spanner or an adjustable wrench.
- (13) Remove the welded pipe of compressor inlet and outlet and remove the compressor.

**Note:** Recover refrigerant without spreading it in the air.

Photo 9



Compressor terminal

Compressor (MC)

Soundproof cover

Compressor fixing nut



## OPERATING PROCEDURE

### 12. Removing the accumulator(RP200)

- (1) Remove the service panel. (See figure 1.)
- (2) Remove the top panel. (See figure 1.)
- (3) Remove 2 front cover panel fixing screws (5 × 10) and remove the front cover panel.
- (4) Remove 2 back cover panel fixing screws (5 × 10) and remove the back cover panel.
- (5) Remove the electrical parts box. (See photo 3.)
- (6) Remove 3 valve bed fixing screws (4 × 10), 4 ball valve and stop valve fixing screws (5 × 16) then remove the valve bed.
- (7) Remove 3 right side panel fixing screws (5 × 10) in the rear of the unit and remove the right side panel.
- (8) Recover refrigerant.
- (9) Remove 2 welded pipes of accumulator inlet and outlet.
- (10) Remove 2 accumulator leg fixing screws (4 × 10).

**Note: Recover refrigerant without spreading it in the air.**

**Photo 11**

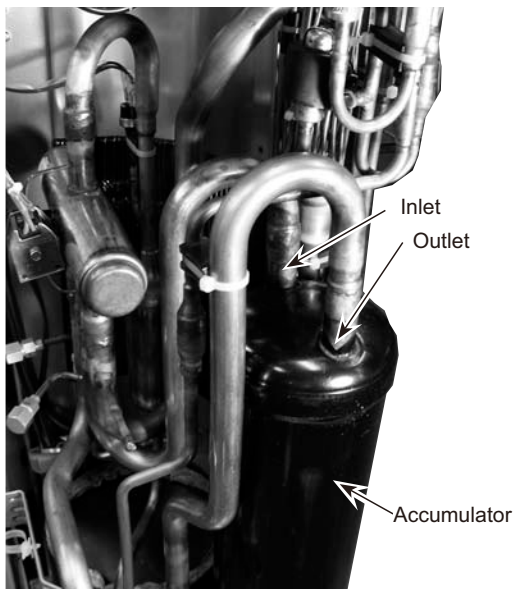

## PHOTOS

**Photo 10**

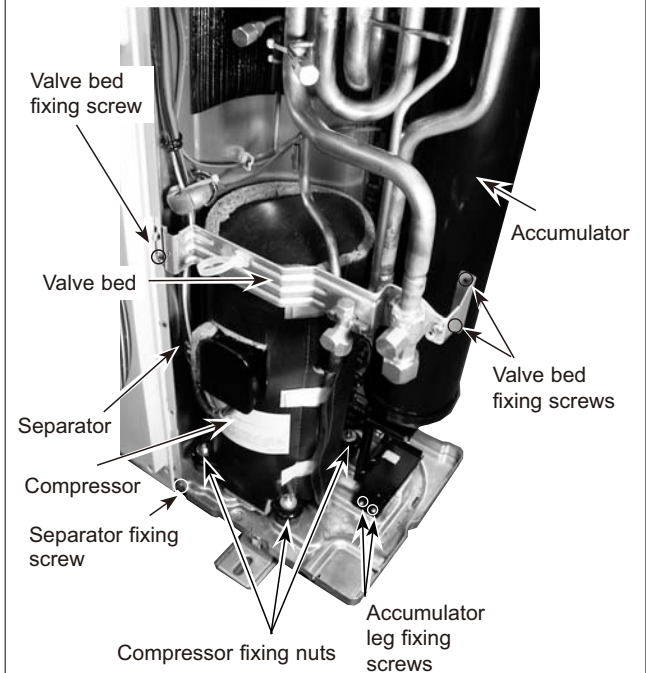

### 13. Removing the power receiver(RP250)

- (1) Remove the service panel. (See figure 1.)
- (2) Remove the top panel. (See figure 1.)
- (3) Remove 2 front cover panel fixing screws (5 × 10) and remove the front cover panel.
- (4) Remove 2 back cover panel fixing screws (5 × 10) and remove the back cover panel.
- (5) Remove the electrical parts box. (See photo 3.)
- (6) Remove 3 valve bed fixing screws (4 × 10) and 4 ball valve and stop valve fixing screws (5 × 16) and then remove the valve bed.
- (7) Remove 3 right side panel fixing screws (5 × 10) in the rear of the unit and then remove the right side panel.
- (8) Recover refrigerant.
- (9) Remove 4 welded pipes of power receiver inlet and outlet.
- (10) Remove 2 receiver leg fixing screws (4 × 10).

**Note: Recover refrigerant without spreading it in the air.**

**Photo 12**

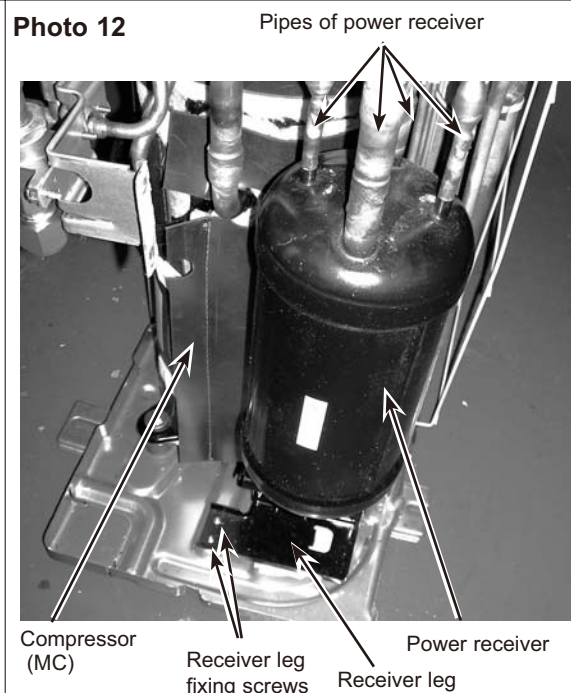

Mr. SLIM™

 **MITSUBISHI ELECTRIC CORPORATION**

HEAD OFFICE : TOKYO BLDG., 2-7-3, MARUNOUCHI, CHIYODA-KU, TOKYO 100-8310, JAPAN