

SERVICE MANUAL

Series PKA Wall Mounted

R410A

Indoor unit
[Model names]

[Service Ref.]

PKA-RP60KAL

PKA-RP60KAL.TH

PKA-RP71KAL

PKA-RP71KAL.TH

PKA-RP100KAL

PKA-RP100KAL.TH

NOTE:

- This manual describes only service data of the indoor units.
- RoHS compliant products have <G> mark on the spec name plate.

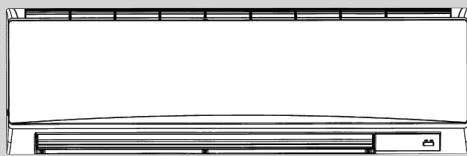

INDOOR UNIT

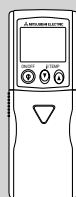

WIRELESS REMOTE
CONTROLLER

CONTENTS

1. REFERENCE MANUAL.....	2
2. SAFETY PRECAUTION.....	3
3. PART NAMES AND FUNCTIONS.....	4
4. SPECIFICATIONS.....	6
5. NOISE CRITERION CURVES.....	7
6. OUTLINES AND DIMENSIONS.....	8
7. WIRING DIAGRAM.....	9
8. REFRIGERANT SYSTEM DIAGRAM.....	10
9. TROUBLESHOOTING.....	11
10. SPECIAL FUNCTION.....	26
11. DISASSEMBLY PROCEDURE.....	29

PARTS CATALOG (OCB452)

Mr. SLIM™

OUTDOOR UNIT'S SERVICE MANUAL

Service Ref.	Service Manual No.
PUHZ-RP35/50/60/71VHA4 PUHZ-RP100/125/140VKA PUHZ-RP100/125/140/200/250YKA	OCH451 OCB451
PU(H)-P71/100VHA#2.UK PU(H)-P71/100/125/140YHA#2.UK	OC379
PUHZ-P100/125/140VHA3.UK	OCH415/ OCB415
PUHZ-P200/250YHA3	OCH424/ OCB424
PUHZ-HRP100VHA2 PUHZ-HRP100YHA2	OCH425/ OCB425

2-1. ALWAYS OBSERVE FOR SAFETY

Before obtaining access to terminal, all supply circuits must be disconnected.

2-2. CAUTIONS RELATED TO NEW REFRIGERANT

Caution for units utilising refrigerant R410A

Use new refrigerant pipes.

In case of using the existing pipes for R22, be careful with the followings.

- For RP100, 125 and 140, be sure to perform replacement operation before test run.
- Change flare nut to the one provided with this product. Use a newly flared pipe.
- Avoid using thin pipes.

Make sure that the inside and outside of refrigerant piping is clean and it has no contamination such as sulfur hazardous for use, oxides, dirt, shaving particles, etc. In addition, use pipes with specified thickness.

Contamination inside refrigerant piping can cause deterioration of refrigerant oil etc.

Store the piping to be used indoors during installation, and keep both ends of the piping sealed until just before brazing. (Leave elbow joints, etc. in their packaging.)

If dirt, dust or moisture enters into refrigerant cycle, that can cause deterioration of refrigerant oil or malfunction of compressor.

Use ester oil, ether oil or alkylbenzene oil (small amount) as the refrigerant oil applied to flares and flange connections.

If large amount of mineral oil enters, that can cause deterioration of refrigerant oil etc.

Charge refrigerant from liquid phase of gas cylinder.

If the refrigerant is charged from gas phase, composition change may occur in refrigerant and the efficiency will be lowered.

Do not use refrigerant other than R410A.

If other refrigerant (R22 etc.) is used, chlorine in refrigerant can cause deterioration of refrigerant oil etc.

Use a vacuum pump with a reverse flow check valve.

Vacuum pump oil may flow back into refrigerant cycle and that can cause deterioration of refrigerant oil etc.

Use the following tools specifically designed for use with R410A refrigerant.

The following tools are necessary to use R410A refrigerant.

Tools for R410A	
Gauge manifold	Flare tool
Charge hose	Size adjustment gauge
Gas leak detector	Vacuum pump adaptor
Torque wrench	Electronic refrigerant charging scale

Handle tools with care.

If dirt, dust or moisture enters into refrigerant cycle, that can cause deterioration of refrigerant oil or malfunction of compressor.

Do not use a charging cylinder.

If a charging cylinder is used, the composition of refrigerant will change and the efficiency will be lowered.

Ventilate the room if refrigerant leaks during operation. If refrigerant comes into contact with a flame, poisonous gases will be released.

[1] Cautions for service

- (1) Perform service after recovering the refrigerant left in unit completely.
- (2) Do not release refrigerant in the air.
- (3) After completing service, charge the cycle with specified amount of refrigerant.
- (4) When performing service, install a filter drier simultaneously.
Be sure to use a filter drier for new refrigerant.

[2] Additional refrigerant charge

When charging directly from cylinder

- Check that cylinder for R410A on the market is syphon type.
- Charging should be performed with the cylinder of syphon stood vertically. (Refrigerant is charged from liquid phase.)

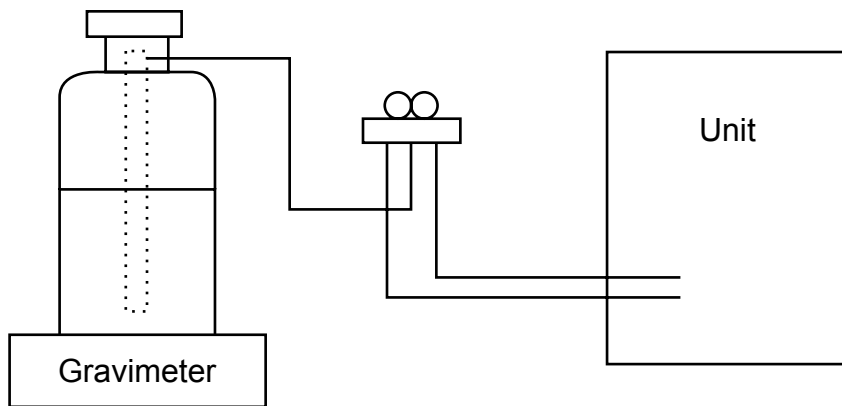

[3] Service tools

Use the below service tools as exclusive tools for R410A refrigerant.

No.	Tool name	Specifications
①	Gauge manifold	·Only for R410A
		·Use the existing fitting specifications. (UNF1/2)
		·Use high-tension side pressure of 5.3MPa-G or over.
②	Charge hose	·Only for R410A
		·Use pressure performance of 5.09MPa-G or over.
③	Electronic scale	—
④	Gas leak detector	·Use the detector for R134a, R407C or R410A.
⑤	Adaptor for reverse flow check	·Attach on vacuum pump.
⑥	Refrigerant charge base	—
⑦	Refrigerant cylinder	·Only for R410A ·Top of cylinder (Pink)
		·Cylinder with syphon
⑧	Refrigerant recovery equipment	—

3 PART NAMES AND FUNCTIONS

• Indoor unit

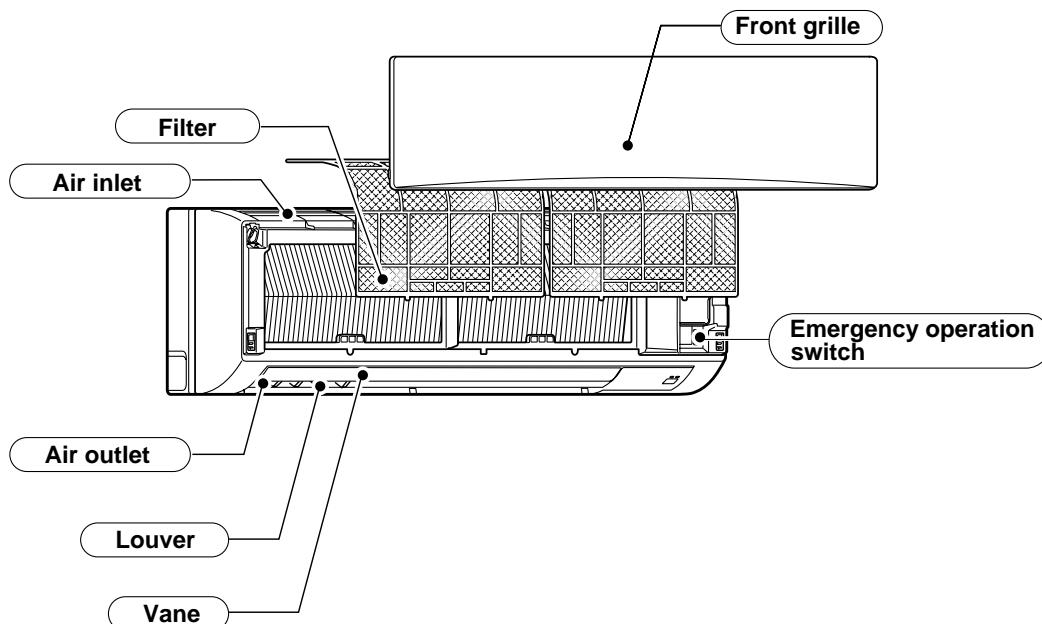

● **Wireless remote controller**

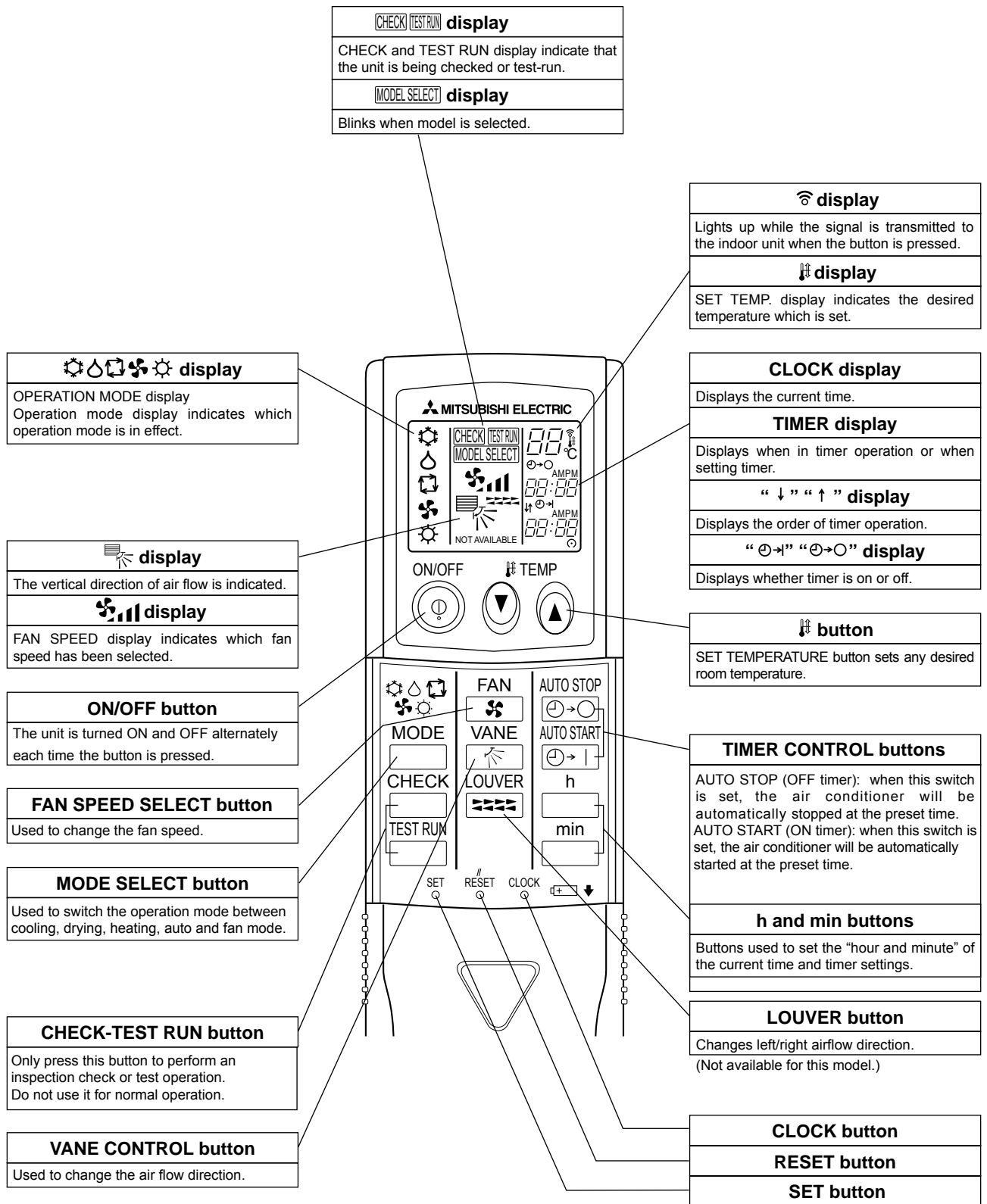

4

SPECIFICATIONS

Service Ref.			PKA-RP60KAL.TH		
INDOOR UNIT	Mode		Cooling	Heating	
	Power supply (phase, cycle, voltage)		Single phase, 50Hz, 230V		
	Input	kW	0.06	0.05	
	Running current	A	0.43	0.36	
	External finish (Panel)		Munsell 1.0Y 9.2/0.2		
	Heat exchanger		Plate fin coil		
	Fan	Fan (drive) × No.		Line flow fan (direct) × 1	
		Fan motor output	kW	0.056	
		Airflow (Low-Middle-High)	m ³ /min(CFM)	18-20-22(635-705-780)	
		External static pressure	Pa(mmAq)	0(direct blow)	
	Booster heater		kW	-	
	Operation control & Thermostat		Wireless remote controller & built-in		
	Noise level (Low-Middle-High)		dB 39-42-45		
	Field drain pipe I.D.		mm(in.) 16 (5/8)		
	Dimensions	W	mm(in.)	1,170 (46-1/16)	
D		mm(in.)	295 (11-5/8)		
H		mm(in.)	365 (14-3/8)		
Weight		kg(lbs)	21 (46)		

Service Ref.			PKA-RP71KAL.TH		
INDOOR UNIT	Mode		Cooling	Heating	
	Power supply (phase, cycle, voltage)		Single phase, 50Hz, 230V		
	Input	kW	0.06	0.05	
	Running current	A	0.43	0.36	
	External finish (Panel)		Munsell 1.0Y 9.2/0.2		
	Heat exchanger		Plate fin coil		
	Fan	Fan (drive) × No.		Line flow fan (direct) × 1	
		Fan motor output	kW	0.056	
		Airflow (Low-Middle-High)	m ³ /min(CFM)	18-20-22(635-705-780)	
		External static pressure	Pa(mmAq)	0(direct blow)	
	Booster heater		kW	-	
	Operation control & Thermostat		Wireless remote controller & built-in		
	Noise level (Low-Middle-High)		dB 39-42-45		
	Field drain pipe I.D.		mm(in.) 16 (5/8)		
	Dimensions	W	mm(in.)	1,170 (46-1/16)	
D		mm(in.)	295 (11-5/8)		
H		mm(in.)	365 (14-3/8)		
Weight		kg(lbs)	21 (46)		

Service Ref.			PKA-RP100KAL.TH		
INDOOR UNIT	Mode		Cooling	Heating	
	Power supply (phase, cycle, voltage)		Single phase, 50Hz, 230V		
	Input	kW	0.08	0.07	
	Running current	A	0.57	0.50	
	External finish (Panel)		Munsell 1.0Y 9.2/0.2		
	Heat exchanger		Plate fin coil		
	Fan	Fan (drive) × No.		Line flow fan (direct) × 1	
		Fan motor output	kW	0.056	
		Airflow (Low-Middle-High)	m ³ /min(CFM)	20-23-26(705-810-920)	
		External static pressure	Pa(mmAq)	0(direct blow)	
	Booster heater		kW	-	
	Operation control & Thermostat		Wireless remote controller & built-in		
	Noise level (Low-Middle-High)		dB 41-45-49		
	Field drain pipe I.D.		mm(in.) 16(5/8)		
	Dimensions	W	mm(in.)	1,170 (46-1/16)	
D		mm(in.)	295 (11-5/8)		
H		mm(in.)	365 (14-3/8)		
Weight		kg(lbs)	21(46)		

5

NOISE CRITERION CURVES

5-1. SOUND LEVELS

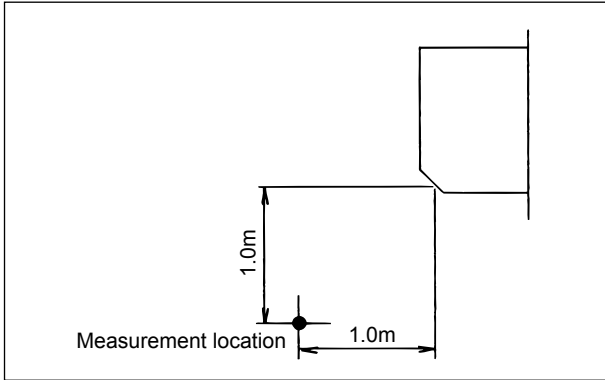

* Measured in anechoic room.

Sound level at anechoic room : Low-Middle-High

	Sound level dB (A)
PKA-RP60,71KAL,TH	39 - 42 - 45
PKA-RP100KAL,TH	41 - 45 - 49

5-2. NOISE CRITERION CURVES

PKA-RP60,71KAL

External static pressure : 0Pa

Power source : 220, 230, 240V, 50Hz

PKA-RP100KAL

External static pressure : 0Pa

Power source : 220, 230, 240V, 50Hz

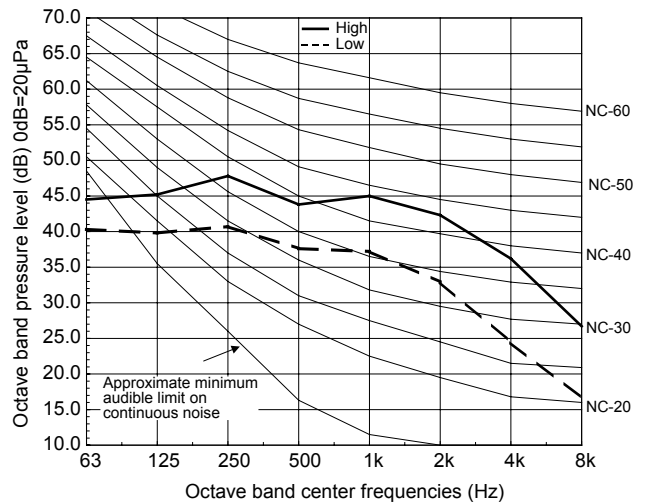
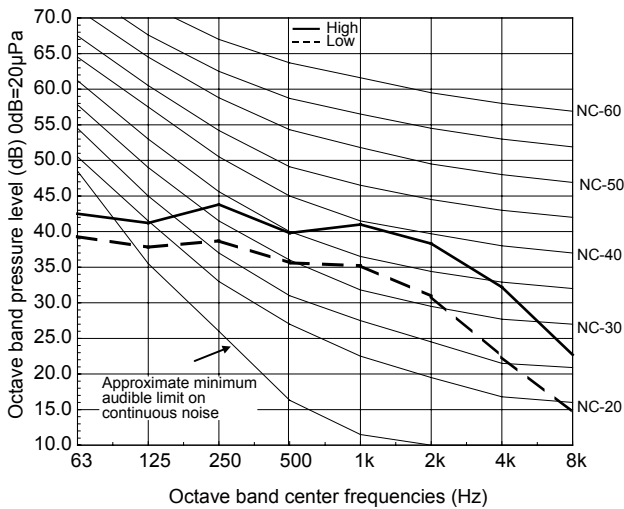

PKA-RP60,71,100KAL.TH

Unit : mm

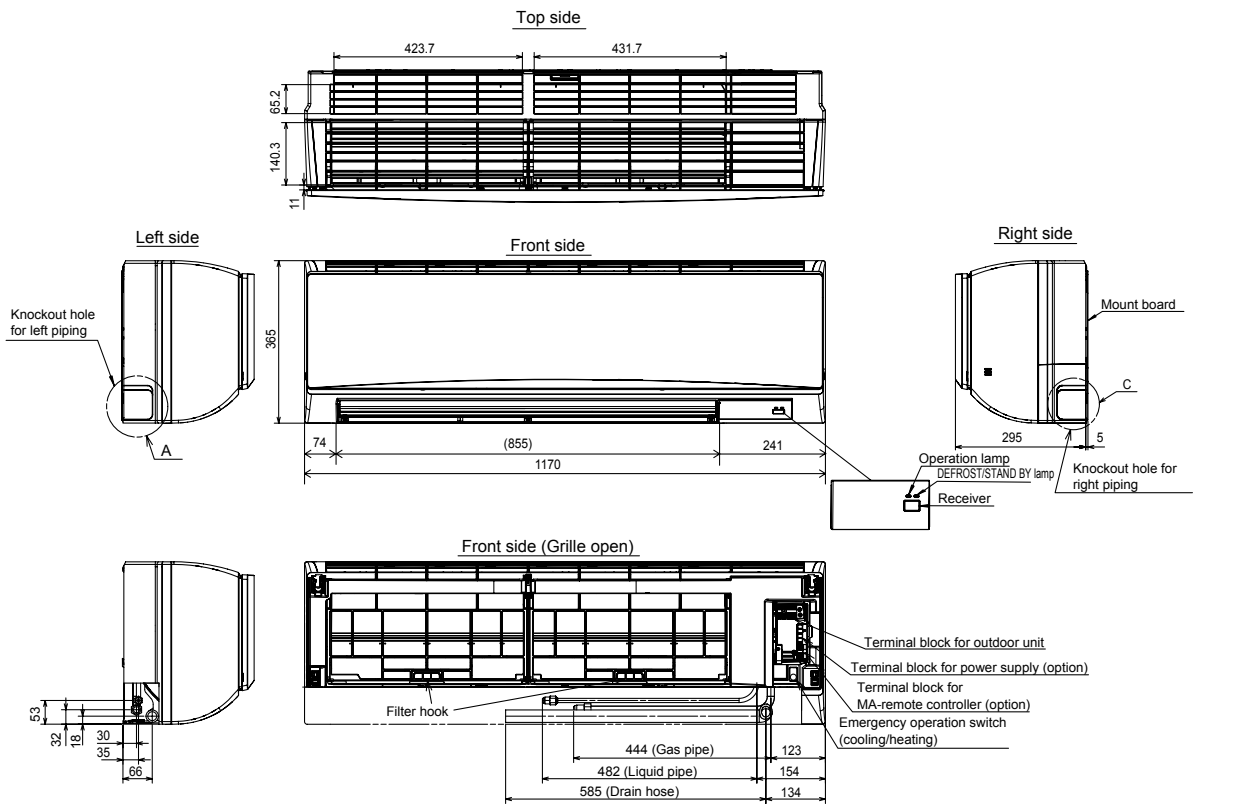

Sleeve (purchased locally)	Through hole
φ75	φ75~φ80

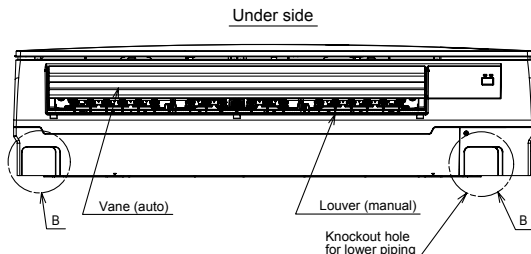

Piping connection department

① Liquid pipe	Refrigerant pipe : φ9.52 Flared connection : 3/8F
② Gas pipe	Refrigerant pipe : φ15.88 Flared connection : 5/8F
③ Drain hose	φ16 O.D

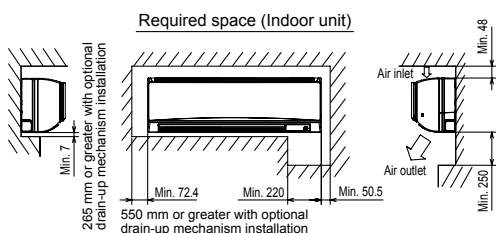
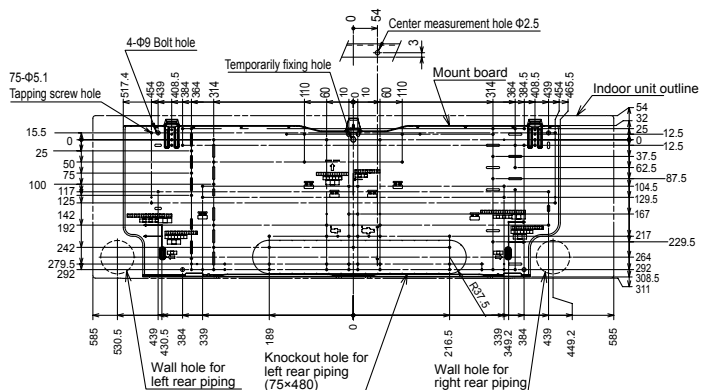
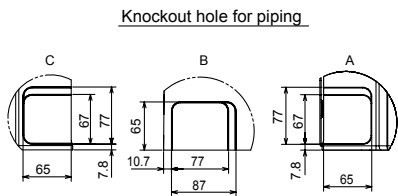

PKA-RP60KAL.TH

PKA-RP71KAL.TH

PKA-RP100KAL.TH

[LEGEND]

SYMBOL	NAME	SYMBOL	NAME
I.B	Indoor controller board	M	Vane motor
CN2L	Connector (LOSSNAY)	MS	Fan motor
CN32	Connector (Remote switch)	S.W	Switch board
CN41	Connector (HA terminal-A)	SWE2	Emergency operation
CN51	Connector (Centrally control)	TB2	Terminal block (Indoor unit Power (option))
CN90	Connector (Remote operation adapter)	TB4	Terminal block (Indoor/outdoor connecting line)
DSA	Surge absorber	TB5	Terminal block (Remote controller transmission line)
FUSE	FUSE (T3.15A/250V)	TH1	Room temp. Thermistor (0°C / 15kΩ, 25°C / 5.4kΩ Detect)
LED1	Power supply (I.B)	TH2	Pipe temp. Thermistor/liquid (0°C / 15kΩ, 25°C / 5.4kΩ Detect)
LED2	Power supply (R.B)	TH5	Cond. / eva. temp. Thermistor (0°C / 15kΩ, 25°C / 5.4kΩ Detect)
LED3	Transmission (Indoor-outdoor)	W.B	Pcb for wireless remote controller
SW1	Switch (Model selection) *See table 1	LED1	LED (Operation indication : Green)
SW2	Switch (Capacity code) *See table 2	LED2	LED (Preparation for heating : Orange)
SWE	Connector (Emergency operation)	REC1	Receiving unit
X1	Relay (Drain pump(option))	DCL	REACTOR
ZNR01,02	Varistor	DP	DRAIN PUMP (OPTION)
CNP	Drain pump (option) power supply (Sold separately:Drain pump(option))	FS	DRAIN FLOAT SWITCH (OPTION)
CN4F	Drain float switch (Sold separately:Drain pump (option))		
R.B	Wired remote controller		
TB6	Terminal block (Remote controller transmission line)		

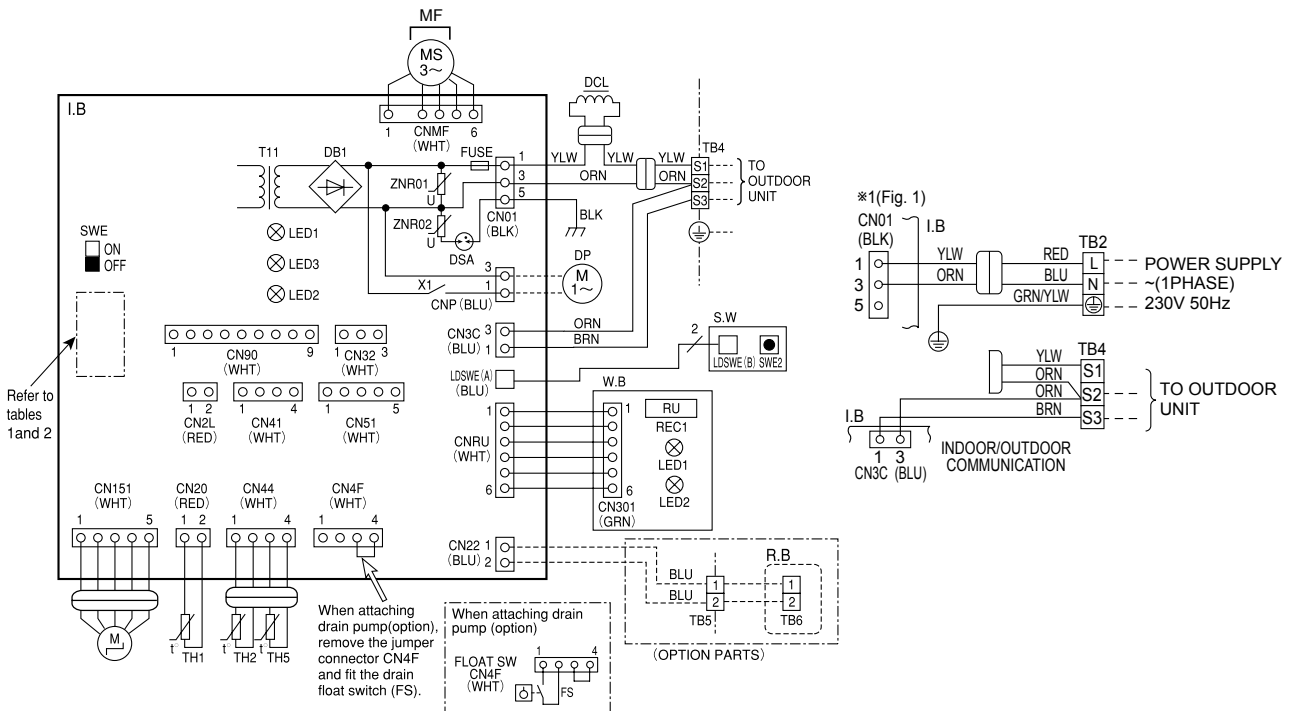

<Table 1>

SW1 (MODEL SELECTION)

SETTING
1 2 3 4 5
ON OFF

<Table 2>

SW2 (CAPACITY CODE)

MODELS	SETTING	MODELS	SETTING	MODELS	SETTING
PKA-RP60KAL	1 2 3 4 5	PKA-RP71KAL	1 2 3 4 5	PKA-RP100KAL	1 2 3 4 5
	ON OFF		ON OFF		ON OFF

Notes:

1. Symbols used in wiring diagram above are, :Connector, : Terminal (block).
2. Indoor and outdoor connecting wires have polarities, make sure to match terminal numbers (S1, S2, S3) for correct wirings.
3. Since the outdoor side electric wiring may change, be sure to check the outdoor unit electric wiring diagram for servicing.
4. This diagram shows the wiring of indoor and outdoor connecting wires.(specification of 230V), adopting superimposed system of power and signal.
 *1 When work to Supply power separately to indoor and outdoor units was applied, refer to Fig. 1.
 *2 For power supply system of this unit, refer to the caution label located near this diagram.

8

REFRIGERANT SYSTEM DIAGRAM

PKA-RP60KAL.TH

PKA-RP71KAL.TH

PKA-RP100KAL.TH

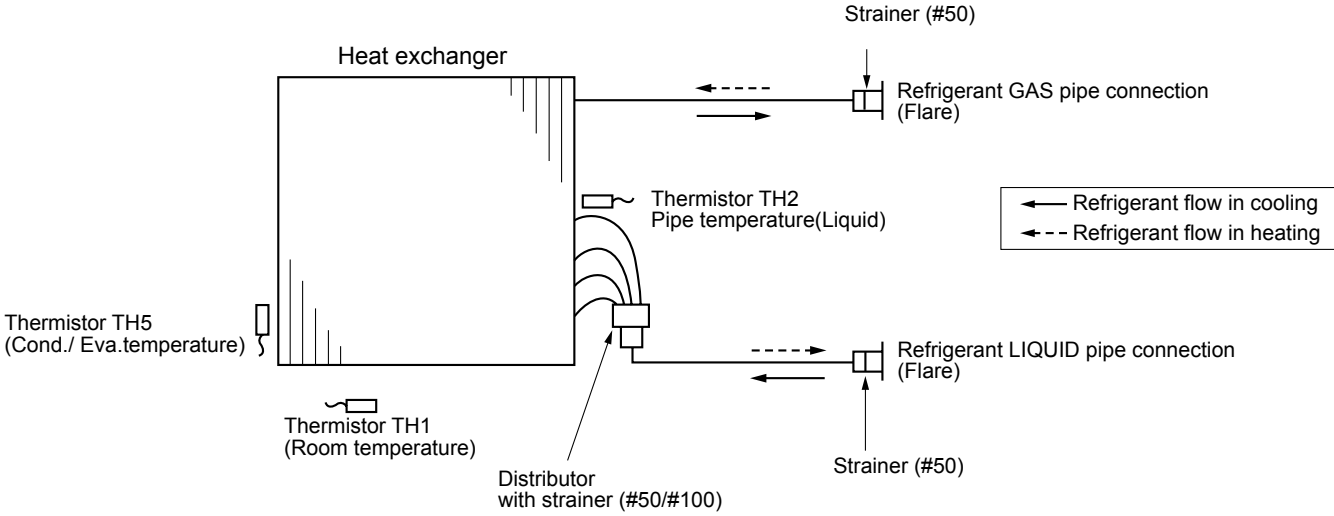

9-1. TROUBLESHOOTING

<Error code display by self-diagnosis and actions to be taken for service (summary)>

Present and past error codes are logged and displayed on the wired remote controller or controller board of outdoor unit. Actions to be taken for service and the trouble recurrence at field are summarized in the table below. Check the contents below before investigating details.

Unit conditions at service	Error code	Actions to be taken for service (summary)
The trouble is reoccurring.	Displayed	Judge what is wrong and take a corrective action according to "9-3. Self-diagnosis action table".
	Not displayed	Conduct troubleshooting and ascertain the cause of the trouble according to "9-4. Troubleshooting by inferior phenomena".
The trouble is not reoccurring.	Logged	<ul style="list-style-type: none"> ① Consider the temporary defects such as the work of protection devices in the refrigerant circuit including compressor, poor connection of wiring, noise and etc. Re-check the symptom, and check the installation environment, refrigerant amount, weather when the trouble occurred, matters related to wiring and etc. ② Reset error code logs and restart the unit after finishing service. ③ There is no abnormality in electrical component, controller board, remote controller and etc.
	Not logged	<ul style="list-style-type: none"> ① Re-check the abnormal symptom. ② Conduct trouble shooting and ascertain the cause of the trouble according to "9-4. Troubleshooting by inferior phenomena". ③ Continue to operate unit for the time being if the cause is not ascertained. ④ There is no abnormality concerning of parts such as electrical component, controller board, remote controller and etc.

9-2. MALFUNCTION-DIAGNOSIS METHOD BY REMOTE CONTROLLER

<In case of trouble during operation>



When a malfunction occurs to air conditioner, both indoor unit and outdoor unit will stop and operation lamp blinks to inform unusual stop.

<Malfunction-diagnosis method at maintenance service>

[Procedure]

1. Press the CHECK button twice.

- "CHECK" lights, and refrigerant address "00" flashes.
- Check that the remote controller's display has stopped before continuing.

2. Press the temperature   buttons.

- Select the refrigerant address of the indoor unit for the self-diagnosis.
- Note: Set refrigerant address using the outdoor unit's DIP switch (SW1). (For more information, see the outdoor unit installation manual.)

3. Point the remote controller at the sensor on the indoor unit and press the HOUR button.

- If an air conditioner error occurs, the indoor unit's sensor emits an intermittent buzzer sound, the operation light flashes, and the error code is output. (It takes 3 seconds at most for error code to appear.)

4. Point the remote controller at the sensor on the indoor unit and press the ON/OFF button.

- The check mode is cancelled.

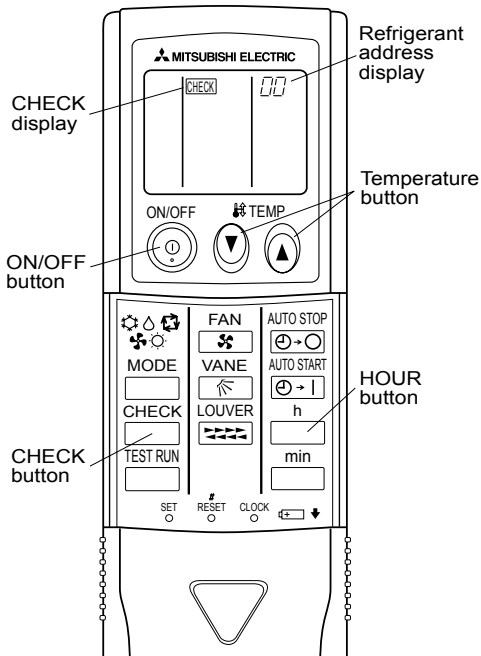

To be continued to the next page.

• Refer to the following tables for details on the check codes.

[Output pattern A]

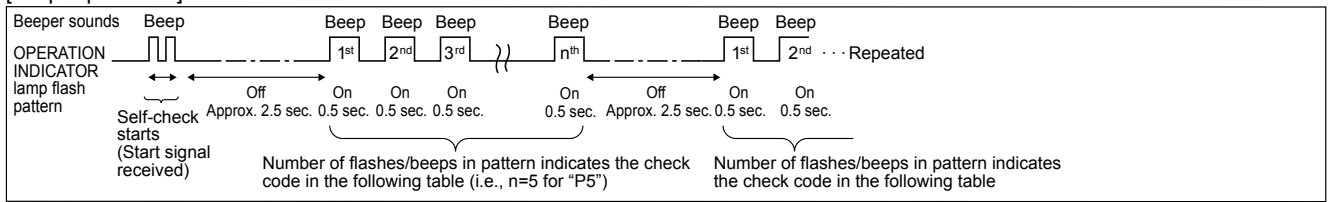

[Output pattern B]

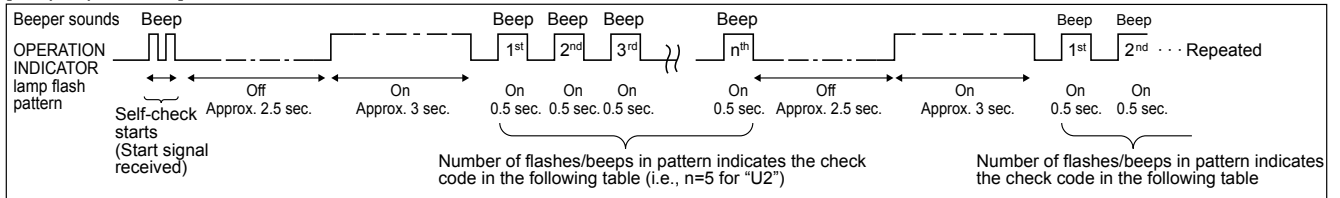

[Output pattern A] Errors detected by indoor unit

Wireless remote controller Beeper sounds/OPERATION INDICATOR lamp flashes (Number of times)	Wired remote controller Check code	Symptom	Remark
1	P1	Intake sensor error	—
2	P2	Pipe (TH2) sensor error	
	P9	Pipe (TH5) sensor error	
3	E6, E7	Indoor/outdoor unit communication error	
4	P4	Drain sensor error/Float switch connector (CN4F) open	
5	P5	Drain pump error	
	PA	Forced compressor stop(due to water leakage abnormality)	
6	P6	Freezing/Overheating protection operation	
7	EE	Communication error between indoor and outdoor units	
8	P8	Pipe temperature error	
9	E4, E5	Remote controller signal receiving error	
10	—	—	
11	—	—	
12	Fb	Indoor unit control system error (memory error, etc.)	
—	E0, E3	Remote controller transmission error	
—	E1, E2	Remote controller control board error	

[Output pattern B] Errors detected by unit other than indoor unit (outdoor unit, etc.)

Wireless remote controller Beeper sounds/OPERATION INDICATOR lamp flashes (Number of times)	Wired remote controller Check code	Symptom	Remark
1	E9	Indoor/outdoor unit communication error (Transmitting error) (Outdoor unit)	For details, check the LED display of the outdoor controller board. As for outdoor unit, refer to outdoor unit's service manual.
2	UP	Compressor overcurrent interruption	
3	U3, U4	Open/short of outdoor unit thermistors	
4	UF	Compressor overcurrent interruption (When compressor locked)	
5	U2	Abnormal high discharging temperature/49C worked/ insufficient refrigerant	
6	U1, Ud	Abnormal high pressure (63H worked)/Overheating protection operation	
7	U5	Abnormal temperature of heat sink	
8	U8	Outdoor unit fan protection stop	
9	U6	Compressor overcurrent interruption/Abnormal of power module	
10	U7	Abnormality of super heat due to low discharge temperature	
11	U9, UH	Abnormality such as overvoltage or voltage shortage and abnormal synchronous signal to main circuit/Current sensor error	
12	—	—	
13	—	—	
14	Others	Other errors (Refer to the technical manual for the outdoor unit.)	

*1 If the beeper does not sound again after the initial 2 beeps to confirm the self-check start signal was received and the OPERATION INDICATOR lamp does not come on, there are no error records.

*2 If the beeper sounds 3 times continuously "beep, beep, beep (0.4 + 0.4 + 0.4 sec.)" after the initial 2 beeps to confirm the self-check start signal was received, the specified refrigerant address is incorrect.

- On wireless remote controller
The continuous buzzer sounds from receiving section of indoor unit.
Blink of operation lamp
- On wired remote controller
Check code displayed in the LCD.

- On wireless remote controller
The continuous buzzer sounds from receiving section of indoor unit.
Blink of operation lamp
- On wired remote controller
Check code displayed in the LCD.

• If the unit cannot be operated properly after test run, refer to the following table to find the cause.

Symptom		Cause
Wired remote controller	LED 1, 2 (PCB in outdoor unit)	
PLEASE WAIT	For about 2 minutes after power-on	After LED 1, 2 are lighted, LED 2 is turned off, then only LED 1 is lighted. (Correct operation)
PLEASE WAIT → Error code	Subsequent to about 2 minutes after power-on	Only LED 1 is lighted. → LED 1, 2 blink.
Display messages do not appear even when operation switch is turned ON (operation lamp does not light up).		Only LED 1 is lighted. → LED 1 blinks twice, LED 2 blinks once.

On the wireless remote controller with condition above, following phenomena take place.

- No signals from the remote controller can be received.
- Operation lamp is blinking.
- The buzzer makes a short ping sound.

Note:

Operation is not possible for about 30 seconds after cancellation of function selection. (Correct operation)

For description of each LED (LED1, 2, 3) provided on the indoor controller, refer to the following table.

LED1 (power for microcomputer)	Indicates whether control power is supplied. Make sure that this LED is always lit.
LED2 (power for remote controller)	Indicates whether power is supplied to the remote controller. This LED lights only in the case of the indoor unit which is connected to the outdoor unit refrigerant addresses "0".
LED3 (communication between indoor and outdoor units)	Indicates state of communication between the indoor and outdoor units. Make sure that this LED is always blinking.

Note: Refer to the manual of outdoor unit for the details of display such as F, U, and other E.

9-3. SELF-DIAGNOSIS ACTION TABLE

Error Code	Abnormal point and detection method	Cause	Countermeasure										
P1	<p>Room temperature thermistor (TH1)</p> <p>① The unit is in 3-minute resume prevention mode if short/open of thermistor is detected. Abnormal if the unit does not reset normally after 3 minutes. (The unit returns to normal operation, if it has been reset normally.)</p> <p>② Constantly detected during cooling, drying, and heating operation. Short: -90°C or more Open: -40°C or less</p>	<p>① Defective thermistor characteristics</p> <p>② Contact failure of connector (CN20) on the indoor controller board (Insert failure)</p> <p>③ Breaking of wire or contact failure of thermistor wiring</p> <p>④ Defective indoor controller board</p>	<p>①-③ Check resistance value of thermistor.</p> <table border="1"> <tr> <td>0°C</td> <td>15.0kΩ</td> </tr> <tr> <td>10°C</td> <td>9.6kΩ</td> </tr> <tr> <td>20°C</td> <td>6.3kΩ</td> </tr> <tr> <td>30°C</td> <td>4.3kΩ</td> </tr> <tr> <td>40°C</td> <td>3.0kΩ</td> </tr> </table> <p>If you put force on (draw or bend) the lead wire with measuring resistance value of thermistor, breaking of wire or contact failure can be detected.</p> <p>② Check contact failure of connector (CN20) on the indoor controller board. Refer to 9-7. Turn the power on again and check restart after inserting connector again.</p> <p>④ Check room temperature display on remote controller. Replace indoor controller board if there is abnormal difference with actual room temperature.</p> <p>Turn the power off, and on again to operate after check.</p>	0°C	15.0kΩ	10°C	9.6kΩ	20°C	6.3kΩ	30°C	4.3kΩ	40°C	3.0kΩ
0°C	15.0kΩ												
10°C	9.6kΩ												
20°C	6.3kΩ												
30°C	4.3kΩ												
40°C	3.0kΩ												
P2	<p>Pipe temperature thermistor/Liquid (TH2)</p> <p>① The unit is in 3-minute resume prevention mode if short/open of thermistor is detected. Abnormal if the unit does not reset normally after 3 minutes. (The unit returns to normal operation, if it has been reset normally.)</p> <p>② Constantly detected during cooling, drying, and heating (except defrosting) operation Short: 90°C or more Open: -40°C or less</p>	<p>① Defective thermistor characteristics</p> <p>② Contact failure of connector (CN44) on the indoor controller board (Insert failure)</p> <p>③ Breaking of wire or contact failure of thermistor wiring</p> <p>④ Defective refrigerant circuit is causing thermistor temperature of 90°C or more or -40°C or less.</p> <p>⑤ Defective indoor controller board</p>	<p>①-③ Check resistance value of thermistor. For characteristics, refer to (P1) above.</p> <p>② Check contact failure of connector (CN44) on the indoor controller board. Refer to 9-7. Turn the power on and check restart after inserting connector again.</p> <p>④ Check pipe <liquid> temperature with remote controller in test run mode. If pipe <liquid> temperature is extremely low (in cooling mode) or high (in heating mode), refrigerant circuit may have defective.</p> <p>⑤ Check pipe <liquid> temperature with remote controller in test run mode. If there is extremely difference with actual pipe <liquid> temperature, replace indoor controller board.</p> <p>Turn the power off, and on again to operate after check.</p>										
P4	<p>Contact failure of drain float switch (CN4F)</p> <ul style="list-style-type: none"> Extract when the connector of drain float switch is disconnected. (③ and ④ of connector CN4F is not short-circuited.) Constantly detected during operation 	<p>① Contact failure of connector (Insert failure)</p> <p>② Defective indoor controller board</p>	<p>① Check contact failure of float switch connector. Turn the power on again and check after inserting connector again.</p> <p>② Operate with connector (CN4F) short-circuited. Replace indoor controller board if abnormality reappears.</p>										
P5	<p>Drain over flow protection operation</p> <p>① Suspensive abnormality, if drain float switch is detected to be underwater for 1 minute and 30 seconds continuously with drain pump on. Compressor and indoor fan will be turned off.</p> <p>② Drain pump is abnormal if the condition above is detected during suspensive abnormality.</p> <p>③ Constantly detected during drain pump operation</p>	<p>① Malfunction of drain pump</p> <p>② Defective drain Clogged drain pump Clogged drain pipe</p> <p>③ Defective drain float switch Catch of drain float switch or malfunction of moving parts cause drain float switch to be detected under water (Switch On)</p> <p>④ Defective indoor-controller board</p>	<p>① Check if drain-up machine works.</p> <p>② Check drain function.</p> <p>③ Remove drain float switch connector CN4F and check if it is short (Switch On) with the moving part of float switch UP, or OPEN with the moving part of float switch down. Replace float switch if it is short with the moving part of float switch down.</p> <p>④ Replace indoor controller board if it is short-circuited between ③-④ of the drain float switch connector CN4F and abnormality reappears.</p> <p>It is not abnormal if there is no problem about the above-mentioned Turn the power off, and on again to operate after check.</p>										



Error Code	Abnormal point and detection method	Cause	Countermeasure
P6	<p>Freezing/overheating protection is working</p> <p>① Freezing protection (Cooling mode) The unit is in 6-minute resume prevention mode if pipe <liquid or condenser/evaporator> temperature stays under -15°C for 3 minutes, 3 minutes after the compressor started. Abnormal if it stays under -15°C for 3 minutes again within 16 minutes after 6-minute resume prevention mode.</p> <p>② Overheating protection (Heating mode) The units is in 6 minute resume prevention mode if pipe <liquid or condenser/evaporator> temperature is detected as over 70°C after the compressor started. Abnormal if the temperature of over 70°C is detected again within 30 minutes after 6 minute resume prevention mode.</p>	<p>(Cooling or drying mode)</p> <p>① Clogged filter (reduced airflow) ② Short cycle of air path ③ Low-load (low temperature) operation out of the tolerance range ④ Defective indoor fan motor • Fan motor is defective. • Indoor controller board is defective.</p> <p>⑤ Defective outdoor fan control ⑥ Overcharge of refrigerant ⑦ Defective refrigerant circuit (clogs)</p> <p>(Heating mode)</p> <p>① Clogged filter (reduced airflow) ② Short cycle of air path ③ Over-load (high temperature) operation out of the tolerance range ④ Defective indoor fan motor • Fan motor is defective. • Indoor controller board is defective. ⑤ Defective outdoor fan control ⑥ Overcharge of refrigerant ⑦ Defective refrigerant circuit (clogs) ⑧ Bypass circuit of outdoor unit is defective.</p>	<p>(Cooling or drying mode)</p> <p>① Check clogs of the filter. ② Remove shields.</p> <p>④ Refer to 9-6.</p> <p>⑤ Check outdoor fan motor. ⑥⑦ Check operating condition of refrigerant circuit.</p> <p>(Heating mode)</p> <p>① Check clogs of the filter. ② Remove shields.</p> <p>④ Refer to 9-6.</p> <p>⑤ Check outdoor fan motor. ⑥~⑧ Check operating condition of refrigerant circuit.</p>
P8	<p>Pipe temperature <Cooling mode> Detected as abnormal when the pipe temperature is not in the cooling range 3 minutes after compressor start and 6 minutes after the liquid or condenser/evaporator pipe is out of cooling range. Note 1) It takes at least 9 minutes to detect. Note 2) Abnormality P8 is not detected in drying mode. Cooling range : -3 °C ≧ (TH-TH1) TH: Lower temperature between: liquid pipe temperature (TH2) and condenser/evaporator temperature (TH5) TH1: Intake temperature</p> <p><Heating mode> When 10 seconds have passed after the compressor starts operation and the hot adjustment mode has finished, the unit is detected as abnormal when condenser/evaporator pipe temperature is not in heating range within 20 minutes.</p> <p>Note 3) It takes at least 27 minutes to detect abnormality. Note 4) It excludes the period of defrosting. (Detection restarts when defrosting mode is over.) Heating range : 3 °C ≦ (TH5-TH1)</p>	<p>① Slight temperature difference between indoor room temperature and pipe <liquid or condenser / evaporator> temperature thermistor • Shortage of refrigerant • Disconnected holder of pipe <liquid or condenser / evaporator> thermistor • Defective refrigerant circuit</p> <p>② Converse connection of extension pipe (on plural units connection)</p> <p>③ Converse wiring of indoor/outdoor unit connecting wire (on plural units connection)</p> <p>④ Defective detection of indoor room temperature and pipe <condenser / evaporator> temperature thermistor</p> <p>⑤ Stop valve is not opened completely.</p>	<p>①~④ Check pipe <liquid or condenser / evaporator> temperature with room temperature display on remote controller and outdoor controller circuit board. Pipe <liquid or condenser / evaporator> temperature display is indicated by setting SW2 of outdoor controller circuit board as follows.</p> <p>(Conduct temperature check with outdoor controller circuit board after connecting 'A-Control Service Tool(PAC-SK52ST)')</p> <p>②③ Check converse connection of extension pipe or converse wiring of indoor/outdoor unit connecting wire.</p>



Error Code	Abnormal point and detection method	Cause	Countermeasure
P9	<p>Pipe temperature thermistor / Condenser-Evaporator (TH5)</p> <p>① The unit is in 3-minute resume protection mode if short/open of thermistor is detected. Abnormal if the unit does not get back to normal within 3 minutes. (The unit returns to normal operation, if it has been reset normally.)</p> <p>② Constantly detected during cooling, drying, and heating operation (except defrosting) Short: 90°C or more Open: -40°C or less</p>	<p>① Defective thermistor characteristics</p> <p>② Contact failure of connector (CN44) on the indoor controller board (Insert failure)</p> <p>③ Breaking of wire or contact failure of thermistor wiring</p> <p>④ Temperature of thermistor is 90°C or more or -40°C or less caused by defective refrigerant circuit.</p> <p>⑤ Defective indoor controller board</p>	<p>①-③ Check resistance value of thermistor. For characteristics, refer to (P1) above.</p> <p>② Check contact failure of connector (CN44) on the indoor controller board. Refer to 9-7.</p> <p>Turn the power on and check restart after inserting connector again.</p> <p>④ Operate in test run mode and check pipe <condenser / evaporator> temperature with outdoor controller circuit board. If pipe <condenser / evaporator> temperature is extremely low (in cooling mode) or high (in heating mode), refrigerant circuit may have defect.</p> <p>⑤ Operate in test run mode and check pipe <condenser / evaporator> temperature with outdoor control circuit board. If there is extreme difference with actual pipe <condenser / evaporator> temperature, replace indoor controller board. There is no abnormality if none of above comes within the unit.</p> <p>Turn the power off and on again to operate.</p> <p>(In case of checking pipe temperature with outdoor controller circuit board, be sure to connect A-control service tool (PAC-SK52ST).)</p>
E0 or E4	<p>Remote controller transmission error(E0)/signal receiving error(E4)</p> <p>① Abnormal if main or sub remote controller cannot receive any transmission normally from indoor unit of refrigerant address "0" for 3 minutes. (Error code : E0)</p> <p>② Abnormal if sub remote controller could not receive any signal for 2 minutes. (Error code: E0)</p> <p>① Abnormal if indoor controller board can not receive any data normally from remote controller board or from other indoor controller board for 3 minutes. (Error code: E4)</p> <p>② Indoor controller board cannot receive any signal from remote controller for 2 minutes. (Error code: E4)</p>	<p>① Contact failure at transmission wire of remote controller</p> <p>② All remote controllers are set as "sub" remote controller. In this case, E0 is displayed on remote controller, and E4 is displayed at LED (LED1, LED2) on the outdoor controller circuit board.</p> <p>③ Miswiring of remote controller</p> <p>④ Defective transmitting receiving circuit of remote controller</p> <p>⑤ Defective transmitting receiving circuit of indoor controller board of refrigerant addresses "0".</p> <p>⑥ Noise has entered into the transmission wire of remote controller.</p>	<p>① Check disconnection or looseness of indoor unit or transmission wire of remote controller.</p> <p>② Set one of the remote controllers "main" if there is no problem with the action above.</p> <p>③ Check wiring of remote controller.</p> <ul style="list-style-type: none"> • Total wiring length: max. 500m (Do not use cable x 3 or more.) • The number of connecting indoor units: max. 16 units • The number of connecting remote controller: max. 2 units <p>When it is not the above-mentioned problem of ①-③</p> <p>①-③ Diagnose remote controllers.</p> <p>a) When "RC OK" is displayed, Remote controllers have no problem. Turn the power off, and on again to check. If abnormality generates again, replace indoor controller board.</p> <p>b) When "RC NG" is displayed, Replace remote controller.</p> <p>c) When "RC E3" or "ERC 00-66" is displayed, noise may be causing abnormality.</p> <p>* If the unit is not normal after replacing indoor controller board in group control, indoor controller board of address "0" may be abnormal.</p>
E3 or E5	<p>Remote controller transmission error(E3)/signal receiving error(E5)</p> <p>① Abnormal if remote controller could not find blank of transmission path for 6 seconds and could not transmit. (Error code: E3)</p> <p>② Remote controller receives transmitted data at the same time and compares the received and transmitted data. Abnormal if these data are judged to be different 30 continuous times. (Error code: E3)</p> <p>① Abnormal if indoor controller board could not find blank of transmission path. (Error code: E5)</p> <p>② Indoor controller board receives transmitted data at the same time and compares the received and transmitted data. Abnormal if these data are judged to be different 30 continuous times. (Error code: E5)</p>	<p>① 2 remote controllers are set as "main." (In case of 2 remote controllers)</p> <p>② Remote controller is connected with 2 indoor units or more.</p> <p>③ Repetition of refrigerant address</p> <p>④ Defective transmitting receiving circuit of remote controller</p> <p>⑤ Defective transmitting receiving circuit of indoor controller board</p> <p>⑥ Noise has entered into transmission wire of remote controller.</p>	<p>① Set a remote controller to main, and the other to sub.</p> <p>② Remote controller is connected with only one indoor unit.</p> <p>③ The address changes to a separate setting.</p> <p>④-⑥ Diagnose remote controller.</p> <p>a) When "RC OK" is displayed, remote controllers have no problem. Turn the power off, and on again to check. When becoming abnormal again, replace indoor controller board.</p> <p>b) When "RC NG" is displayed, replace remote controller.</p> <p>c) When "RC E3" or "ERC 00-66" is displayed, noise may be causing abnormality.</p>



Error Code	Abnormal point and detection method	Cause	Countermeasure
E6	Indoor/outdoor unit communication error (Signal receiving error) ① Abnormal if indoor controller board cannot receive any signal normally for 6 minutes after turning the power on. ② Abnormal if indoor controller board cannot receive any signal normally for 3 minutes. ③ Consider the unit abnormal under the following condition: When 2 or more indoor units are connected to an outdoor unit, indoor controller board cannot receive a signal for 3 minutes from outdoor controller circuit board, a signal which allows outdoor controller circuit board to transmit signals.	① Contact failure, short circuit or, miswiring (converse wiring) of indoor/outdoor unit connecting wire ② Defective transmitting receiving circuit of indoor controller board ③ Defective transmitting receiving circuit of indoor controller board ④ Noise has entered into indoor/outdoor unit connecting wire.	* Check LED display on the outdoor control circuit board. (Connect A-control service tool, PAC-SK52ST.) Refer to outdoor unit service manual. ① Check disconnection or looseness of indoor/outdoor unit connecting wire of indoor unit or outdoor unit. Check all the units in case of twin triple indoor unit system. ②-④ Turn the power off, and on again to check. If abnormality generates again, replace indoor controller board or outdoor controller circuit board. * Other indoor controller board may have defect in case of twin triple indoor unit system.
E7	Indoor/outdoor unit communication error (Transmitting error) Abnormal if "1" receiving is detected 30 times continuously though indoor controller board has transmitted "0".	① Defective transmitting receiving circuit of indoor controller board ② Noise has entered into power supply. ③ Noise has entered into outdoor control wire.	①-③ Turn the power off, and on again to check. If abnormality generates again, replace indoor controller board.
Fb	Indoor controller board Abnormal if data cannot be read normally from the nonvolatile memory of the indoor controller board.	① Defective indoor controller board	① Replace indoor controller board.
E1 or E2	Remote controller control board ① Abnormal if data cannot be read normally from the nonvolatile memory of the remote controller control board. (Error code: E1) ② Abnormal if the clock function of remote controller cannot be operated normally. (Error code: E2)	① Defective remote controller	① Replace remote controller.
PA	Forced compressor stop (due to water leakage abnormality) ① The unit has a water leakage abnormality when the following conditions, a) and b), are satisfied while the above-mentioned detection is performed. a) The intake temperature subtracted with liquid pipe temperature detects to be less than -10°C for a total of 30 minutes. (When the drain sensor is detected to be NOT soaked in the water, the detection record of a) and b) will be cleared.) b) Drain float switch detects to be in the water for more than 15 minutes. *Once the water leakage abnormality is detected, abnormality state will not be released until the main power is reset.	① Drain pump trouble ② Drain defective · Drain pump clogging · Drain pipe clogging ③ Open circuit of float switch ④ Contact failure of float switch connector ⑤ Dew condensation on float switch · Drain water descends along lead wire. · Drain water waving due to filter clogging. ⑥ Extension piping connection difference at twin, triple, quadruple system. ⑦ Miswiring of indoor/ outdoor connecting at twin, triple, quadruple system. ⑧ Room temperature thermistor / liquid pipe temperature thermistor detection is defective.	① Check the drain pump. ② Check whether water can be drained. ③ Check the resistance of the float switch. ④ Check the connector contact failure. ⑤ Check the float switch leadwire mounted. Check the filter clogging. ⑥ Check the piping connection. ⑦ Check the indoor/ outdoor connecting wires. ⑧ Check the room temperature display of remote controller. Check the indoor liquid pipe temperature display of outdoor controller board.

9-4. TROUBLESHOOTING BY INFERIOR PHENOMENA

Note: Refer to the manual of outdoor unit for the detail of remote controller.

Phenomena	Cause	Countermeasure
(1)LED2 on indoor controller board is off.	<ul style="list-style-type: none"> • When LED1 on indoor controller board is also off. <p>① Power supply of rated voltage is not supplied to outdoor unit.</p> <p>② Defective outdoor controller circuit board</p> <p>③ Power supply of 220~240V is not supplied to indoor unit.</p> <p>④ Defective indoor controller board</p> <p>(For the separate indoor/outdoor unit power supply system)</p> <p>① Power supply of 220~240V AC is not supplied to indoor unit.</p> <p>② The connectors of the optional replacement kit are not used.</p> <p>③ Defective indoor controller board</p>	<p>① Check the voltage of outdoor power supply terminal block (L, N) or (L₃, N).</p> <ul style="list-style-type: none"> • When AC 220~240V is not detected, check the power wiring to outdoor unit and the breaker. • When AC 220~240V is detected, check ② (below). <p>② Check the voltage between outdoor terminal block S1 and S2.</p> <ul style="list-style-type: none"> • When AC 220~240V is not detected, —check the fuse on outdoor controller circuit board. —check the wiring connection. • When AC 220~240V is detected, check ③ (below). <p>③ Check the voltage between indoor terminal block S1 and S2.</p> <ul style="list-style-type: none"> • When AC 220~240V is not detected, check indoor/outdoor unit connecting wire for miswiring. • When AC 220~240V is detected, check ④ (below). <p>④ Check the fuse on indoor controller board. Check the wiring connection. If no problem are found, indoor controller board is defective.</p> <p>① Check the voltage of indoor power supply terminal block (L,N).</p> <ul style="list-style-type: none"> • When AC220~240V is not detected, check the power supply wiring. • When AC220~240V is detected, check ② (below). <p>② Check that there is no problem in the method of connecting the connectors.</p> <ul style="list-style-type: none"> • When there are problems in the method of connecting the connectors, connect the connector correctly referring to installation manual of an optional kit. • When there is no problem in the method of connecting the connectors, check ③ (below). <p>③ Check the fuse on indoor controller board. Check the wiring connection. If no problem are found, indoor controller board is defective.</p>
	<ul style="list-style-type: none"> • When LED1 on indoor controller board is lit. <p>① Mis-setting of refrigerant address for outdoor unit (There is no unit corresponding to refrigerant address "0".)</p>	<p>① Check again the setting of refrigerant address for outdoor unit. Set the refrigerant address to "0". (For grouping control system under which 2 or more outdoor units are connected, set one of the units to "0".) Set refrigerant address using SW1 (3-6) on outdoor controller circuit board.</p>

Note: Refer to the manual of outdoor unit for the detail of remote controller.

Phenomena	Cause	Countermeasure
(2)LED2 on indoor controller board is blinking.	<ul style="list-style-type: none"> • When LED1 on indoor controller board is also blinking. Connection failure of indoor/outdoor unit connecting wire • When LED1 is lit. ① Miswiring of remote controller wires Under twin triple indoor unit system, 2 or more indoor units are wired together. ② Refrigerant address for outdoor unit is wrong or not set. Under grouping control system, there are some units whose refrigerant address is 0. ③ Short-cut of remote controller wires ④ Defective remote controller 	<p>Check indoor/outdoor unit connecting wire for connection failure.</p> <ul style="list-style-type: none"> ① Check the connection of remote controller wires in case of twin triple indoor unit system. When 2 or more indoor units are wired in one refrigerant system, connect remote controller wires to one of those units. ② Check the setting of refrigerant address in case of grouping control system. If there are some units whose refrigerant addresses are 0 in one group, set one of the units to 0 using SW1 (3-6) on outdoor controller circuit board. ③④ Remove remote controller wires and check LED2 on indoor controller board. <ul style="list-style-type: none"> • When LED2 is blinking, check the short-cut of remote controller wires. • When LED2 is lit, connect remote controller wires again and: if LED2 is blinking, remote controller is defective; if LED2 is lit, connection failure of remote controller terminal block etc. has returned to normal.
(3)Upward/downward vane performance failure	<ul style="list-style-type: none"> ① The vane is not downward during defrosting and heat preparation and when the thermostat is OFF in HEAT mode. (Working of COOL protection function) ② Vane motor does not rotate. <ul style="list-style-type: none"> • Defective vane motor • Breaking of wire or connection failure of connector ③ Upward/downward vane does not work. <ul style="list-style-type: none"> • The vane is set to fixed position. 	<ul style="list-style-type: none"> ① Normal operation (The vane is set to horizontal regardless of remote control.) ② Check ② (left). <ul style="list-style-type: none"> • Check the vane motor. (Refer to "How to check the parts".) • Check for breaking of wire or connection failure of connector. ③ Normal operation (Each connector on vane motor side is disconnected or setting the fixed vanes by wired remote controller.)
(4)Receiver for wireless remote controller	<ul style="list-style-type: none"> ① Weak batteries of wireless remote controller. ② Contact failure of connector (CNB) on wireless remote controller board (Insert failure) ③ Contact failure of connector (CN90) on indoor controller board (Insert failure) ④ Contact failure of connector between wireless remote controller board and indoor controller board 	<ul style="list-style-type: none"> ① Replace batteries of wireless remote controller. ②~④ Check contact failure of each connector. If no problems are found of connector, replace indoor controller board. When the same trouble occurs even if indoor controller board is replaced, replace wireless remote controller board.

9-5. EMERGENCY OPERATION

9-5-1. When wireless remote controller troubles or its battery is exhausted

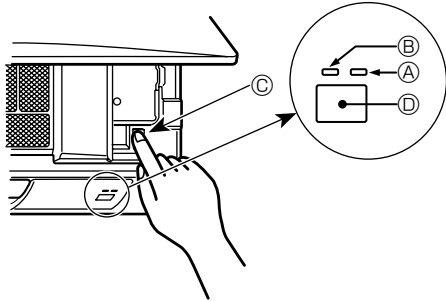

When the remote controller cannot be used

When the batteries of the remote controller run out or the remote controller malfunctions, the emergency operation can be done using the emergency buttons.

- Ⓐ DEFROST/STAND BY lamp (ORANGE)
- Ⓑ Operation lamp (GREEN)
- Ⓒ Emergency operation switch (cooling/heating)
- Ⓓ Receiver

- Each press of the emergency operation switch will toggle the operation mode.
- Check "COOL/HEAT" with the operation monitor display. (The display will appear orange for 5 seconds after pressing the emergency operation switch.)

[Heat pump type]

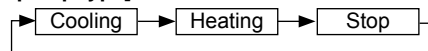

[Cooling Only type]

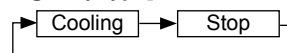

Operation Monitor Display

	GREEN	ORANGE	
STOP	○	○	The orange lamp follows the switch operation as indicated at the left for 5 seconds, and then it will return to the normal display.
COOL	●	○	
HEAT	●	●	

○ Turning off ● Lighting

* Details of emergency mode are as shown below.

Operation Mod	COOL	HEAT
Set Temperature	24°C	24°C
Fan Speed	High	High
Airflow Direction Up and Down	Horizontal	Downward

9-5-2. When wired remote controller or indoor unit microcomputer troubles

1. When the wired remote control or the indoor unit microcomputer has failed, but all other components work properly, if you set the switch (SWE) on the indoor controller board ON, the indoor unit will begin Emergency Operation.

When Emergency Operation is activated, the indoor unit operates as follows:

(1) Indoor fan is running at high speed. (2) Drain-up machine is working.

※ Note on the wireless remote control

When the remote control does not function, it is possible to activate.

Emergency Operation by using the indoor unit Emergency operation switch.

However, if the indoor unit microcomputer has failed, it is necessary to proceed with points 2 and 3 below as in the case of the wired remote control.

2. When you activate Emergency operation of the cooling or heating, you have to set the switch(SWE) on the indoor controller board and activate Emergency operation of the outdoor unit.

For details on how to activate Emergency operation of the outdoor unit, refer to the outdoor unit wiring diagram.

3. Before you activate Emergency operation, check the following points:

(1) Emergency operation cannot be activated when:

- the outdoor unit malfunctions.
- the indoor fan malfunctions.
- when it has detected the malfunction of drain-up machine during self-diagnosing.

(2) Emergency operation becomes continuous only by switching the power source on/off.

ON/OFF on the remote control or temperature control etc. does not function.

(3) Avoid operating for a long time when the outdoor unit begins defrosting while Emergency operation of the heating is activated, because it will start to blow cold air.

(4) Emergency cooling should be limited to 10 hours maximum (The indoor unit heat exchanger may freeze).

(5) After Emergency operation has been deactivated, set the switches etc. to their original positions.

(6) Movement of the vanes does not work in Emergency operation, therefore you have to slowly set them manually to the appropriate position.

9-6. HOW TO CHECK THE PARTS

PKA-RP60KAL.TH PKA-RP71KAL.TH PKA-RP100KAL.TH

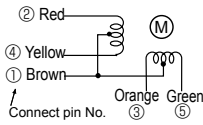
Parts name	Check points														
Room temperature thermistor (TH1) Liquid pipe temperature thermistor (TH2) Condenser / Evaporator temperature thermistor (TH5)	Disconnect the connector then measure the resistance using a tester. (At the ambient temperature 10°C~30°C) <table border="1" style="display: inline-table; vertical-align: middle;"> <thead> <tr> <th>Normal</th> <th>Abnormal</th> </tr> </thead> <tbody> <tr> <td>4.3kΩ~9.6kΩ</td> <td>Open or short</td> </tr> </tbody> </table> Refer to the thermistor.	Normal	Abnormal	4.3kΩ~9.6kΩ	Open or short										
Normal	Abnormal														
4.3kΩ~9.6kΩ	Open or short														
Vane motor (MV) 	Measure the resistance between the terminals using a tester. (Coil temperature 20°C) <table border="1" style="display: inline-table; vertical-align: middle;"> <thead> <tr> <th colspan="4">Normal</th> <th>Abnormal</th> </tr> </thead> <tbody> <tr> <td>①-② Brown-Red</td> <td>①-③ Brown-Orange</td> <td>①-④ Brown-Yellow</td> <td>①-⑤ Brown-Green</td> <td rowspan="2">Open or short</td> </tr> <tr> <td colspan="4" style="text-align: center;">250Ω ± 7%</td> </tr> </tbody> </table>	Normal				Abnormal	①-② Brown-Red	①-③ Brown-Orange	①-④ Brown-Yellow	①-⑤ Brown-Green	Open or short	250Ω ± 7%			
Normal				Abnormal											
①-② Brown-Red	①-③ Brown-Orange	①-④ Brown-Yellow	①-⑤ Brown-Green	Open or short											
250Ω ± 7%															
Fan motor (MF)	Refer to 9-6-2.														

9-6-1. Thermistor

<Thermistor Characteristic graph>

Thermistor for lower temperature

Room temperature thermistor(TH1)
Pipe temperature thermistor/liquid(TH2)
Condenser/evaporator temperature thermistor(TH5)

Thermistor $R_0=15k\Omega \pm 3\%$

Fixed number of $B=3480 \pm 2\%$

$$R_t=15\exp \left\{ 3480 \left(\frac{1}{273+t} - \frac{1}{273} \right) \right\}$$

0°C	15kΩ
10°C	9.6kΩ
20°C	6.3kΩ
25°C	5.4kΩ
30°C	4.3kΩ
40°C	3.0kΩ

< Thermistor for lower temperature >

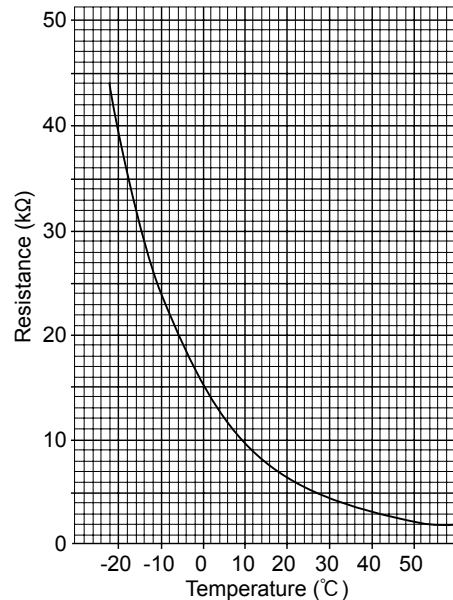



9-6-2. DC Fan motor (fan motor/indoor controller circuit board)

Check method of DC fan motor (fan motor/indoor controller circuit board)

① Notes

- High voltage is applied to the connector (CNMF) for the fan motor. Pay attention to the service.
- Do not pull out the connector (CNMF) for the motor with the power supply on.
(It causes trouble of the indoor controller circuit board and fan motor.)

② Self check

Symptom : The indoor fan cannot turn around.

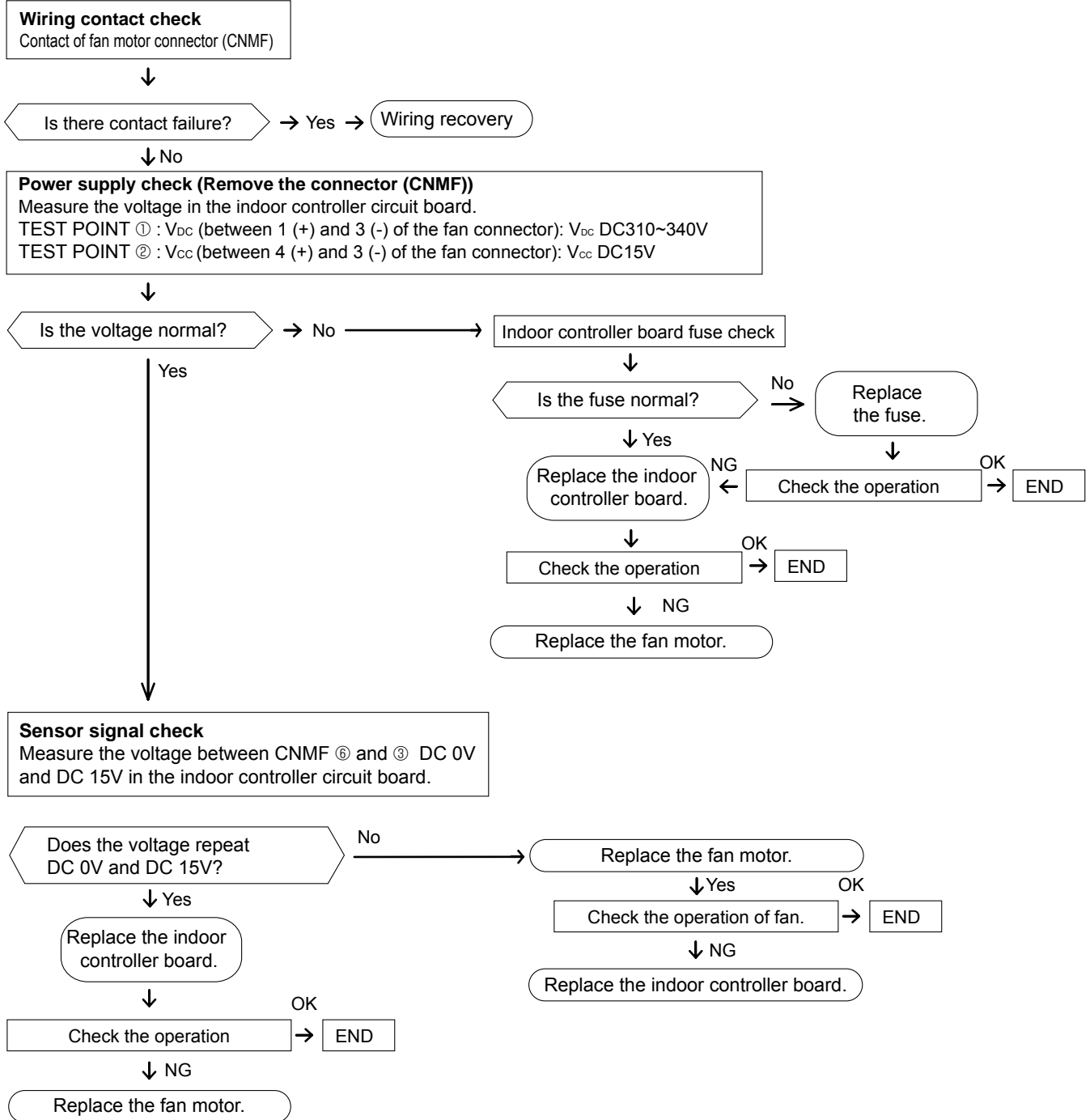

9-7. TEST POINT DIAGRAM

PKA-RP60KAL.TH PKA-RP71KAL.TH PKA-RP100KAL.TH

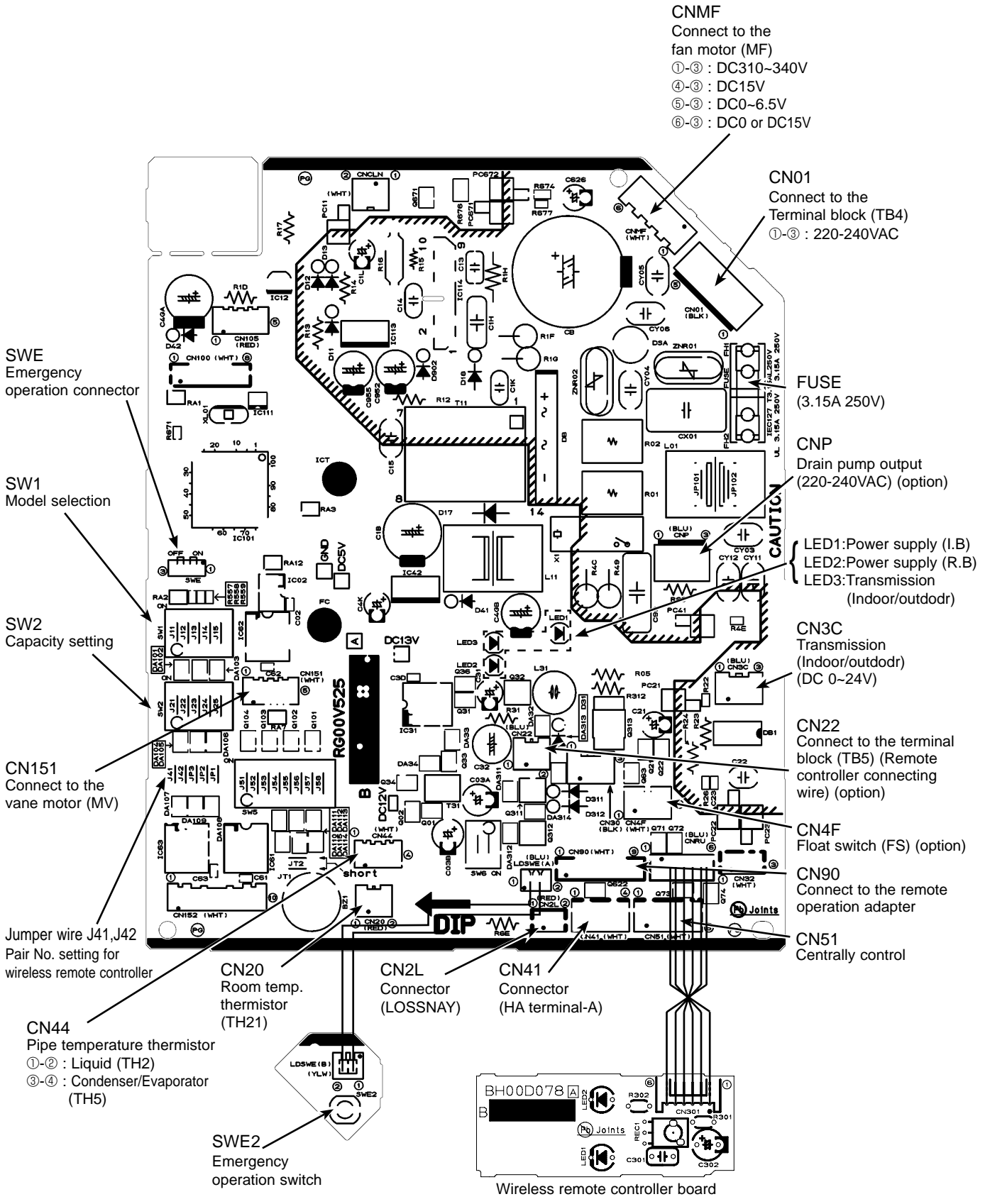

CNMF
Connect to the fan motor (MF)
①-③ : DC310~340V
④-③ : DC15V
⑤-③ : DC0~6.5V
⑥-③ : DC0 or DC15V

CN01
Connect to the Terminal block (TB4)
①-③ : 220-240VAC

FUSE
(3.15A 250V)

CNP
Drain pump output (220-240VAC) (option)

LED1: Power supply (L.B)
LED2: Power supply (R.B)
LED3: Transmission (Indoor/outdoor)

CN3C
Transmission (Indoor/outdoor) (DC 0~24V)

CN22
Connect to the terminal block (TB5) (Remote controller connecting wire) (option)

CN4F
Float switch (FS) (option)

CN90
Connect to the remote operation adapter

CN51
Centrally control

SWE
Emergency operation connector

SW1
Model selection

SW2
Capacity setting

CN151
Connect to the vane motor (MV)

Jumper wire J41, J42
Pair No. setting for wireless remote controller

CN44
Pipe temperature thermistor
①-② : Liquid (TH2)
③-④ : Condenser/Evaporator (TH5)

SWE2
Emergency operation switch

CN20
Room temp. thermistor (TH21)

CN2L
Connector (LOSSNAY)

CN41
Connector (HA terminal-A)

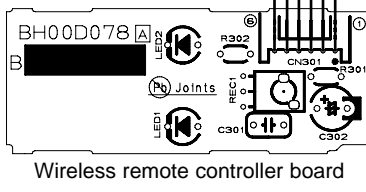

Wireless remote controller board

9-8. FUNCTIONS OF DIP SWITCH AND JUMPER WIRE

Each function is controlled by the dip switch and the jumper wire on control P.C. board.

(Marks in the table below) Jumper wire (○ : Short × : Open)

Jumper wire	Functions	Setting by the dip switch and jumper wire	Remarks																																												
SW1	Model settings	<table border="1"> <thead> <tr> <th>MODELS</th> <th>SETTING</th> </tr> </thead> <tbody> <tr> <td>PKA-RP-KAL</td> <td> <table border="1"> <tr> <td>1</td><td>2</td><td>3</td><td>4</td><td>5</td> <td>ON OFF</td> </tr> <tr> <td><input checked="" type="checkbox"/></td><td><input checked="" type="checkbox"/></td><td><input checked="" type="checkbox"/></td><td><input checked="" type="checkbox"/></td><td><input checked="" type="checkbox"/></td> <td></td> </tr> </table> </td> </tr> </tbody> </table>	MODELS	SETTING	PKA-RP-KAL	<table border="1"> <tr> <td>1</td><td>2</td><td>3</td><td>4</td><td>5</td> <td>ON OFF</td> </tr> <tr> <td><input checked="" type="checkbox"/></td><td><input checked="" type="checkbox"/></td><td><input checked="" type="checkbox"/></td><td><input checked="" type="checkbox"/></td><td><input checked="" type="checkbox"/></td> <td></td> </tr> </table>	1	2	3	4	5	ON OFF	<input checked="" type="checkbox"/>	<input checked="" type="checkbox"/>	<input checked="" type="checkbox"/>	<input checked="" type="checkbox"/>	<input checked="" type="checkbox"/>																														
MODELS	SETTING																																														
PKA-RP-KAL	<table border="1"> <tr> <td>1</td><td>2</td><td>3</td><td>4</td><td>5</td> <td>ON OFF</td> </tr> <tr> <td><input checked="" type="checkbox"/></td><td><input checked="" type="checkbox"/></td><td><input checked="" type="checkbox"/></td><td><input checked="" type="checkbox"/></td><td><input checked="" type="checkbox"/></td> <td></td> </tr> </table>	1	2	3	4	5	ON OFF	<input checked="" type="checkbox"/>	<input checked="" type="checkbox"/>	<input checked="" type="checkbox"/>	<input checked="" type="checkbox"/>	<input checked="" type="checkbox"/>																																			
1	2	3	4	5	ON OFF																																										
<input checked="" type="checkbox"/>	<input checked="" type="checkbox"/>	<input checked="" type="checkbox"/>	<input checked="" type="checkbox"/>	<input checked="" type="checkbox"/>																																											
SW2	Capacity settings	<table border="1"> <thead> <tr> <th>MODELS</th> <th>SETTING</th> </tr> </thead> <tbody> <tr> <td>PKA-RP60KAL</td> <td> <table border="1"> <tr> <td>1</td><td>2</td><td>3</td><td>4</td><td>5</td> <td>ON OFF</td> </tr> <tr> <td><input checked="" type="checkbox"/></td><td><input checked="" type="checkbox"/></td><td><input checked="" type="checkbox"/></td><td><input checked="" type="checkbox"/></td><td><input checked="" type="checkbox"/></td> <td></td> </tr> </table> </td> </tr> <tr> <td>PKA-RP71KAL</td> <td> <table border="1"> <tr> <td>1</td><td>2</td><td>3</td><td>4</td><td>5</td> <td>ON OFF</td> </tr> <tr> <td><input checked="" type="checkbox"/></td><td><input checked="" type="checkbox"/></td><td><input checked="" type="checkbox"/></td><td><input checked="" type="checkbox"/></td><td><input checked="" type="checkbox"/></td> <td></td> </tr> </table> </td> </tr> <tr> <td>PKA-RP100KAL</td> <td> <table border="1"> <tr> <td>1</td><td>2</td><td>3</td><td>4</td><td>5</td> <td>ON OFF</td> </tr> <tr> <td><input checked="" type="checkbox"/></td><td><input checked="" type="checkbox"/></td><td><input checked="" type="checkbox"/></td><td><input checked="" type="checkbox"/></td><td><input checked="" type="checkbox"/></td> <td></td> </tr> </table> </td> </tr> </tbody> </table>	MODELS	SETTING	PKA-RP60KAL	<table border="1"> <tr> <td>1</td><td>2</td><td>3</td><td>4</td><td>5</td> <td>ON OFF</td> </tr> <tr> <td><input checked="" type="checkbox"/></td><td><input checked="" type="checkbox"/></td><td><input checked="" type="checkbox"/></td><td><input checked="" type="checkbox"/></td><td><input checked="" type="checkbox"/></td> <td></td> </tr> </table>	1	2	3	4	5	ON OFF	<input checked="" type="checkbox"/>	<input checked="" type="checkbox"/>	<input checked="" type="checkbox"/>	<input checked="" type="checkbox"/>	<input checked="" type="checkbox"/>		PKA-RP71KAL	<table border="1"> <tr> <td>1</td><td>2</td><td>3</td><td>4</td><td>5</td> <td>ON OFF</td> </tr> <tr> <td><input checked="" type="checkbox"/></td><td><input checked="" type="checkbox"/></td><td><input checked="" type="checkbox"/></td><td><input checked="" type="checkbox"/></td><td><input checked="" type="checkbox"/></td> <td></td> </tr> </table>	1	2	3	4	5	ON OFF	<input checked="" type="checkbox"/>	<input checked="" type="checkbox"/>	<input checked="" type="checkbox"/>	<input checked="" type="checkbox"/>	<input checked="" type="checkbox"/>		PKA-RP100KAL	<table border="1"> <tr> <td>1</td><td>2</td><td>3</td><td>4</td><td>5</td> <td>ON OFF</td> </tr> <tr> <td><input checked="" type="checkbox"/></td><td><input checked="" type="checkbox"/></td><td><input checked="" type="checkbox"/></td><td><input checked="" type="checkbox"/></td><td><input checked="" type="checkbox"/></td> <td></td> </tr> </table>	1	2	3	4	5	ON OFF	<input checked="" type="checkbox"/>	<input checked="" type="checkbox"/>	<input checked="" type="checkbox"/>	<input checked="" type="checkbox"/>	<input checked="" type="checkbox"/>		
MODELS	SETTING																																														
PKA-RP60KAL	<table border="1"> <tr> <td>1</td><td>2</td><td>3</td><td>4</td><td>5</td> <td>ON OFF</td> </tr> <tr> <td><input checked="" type="checkbox"/></td><td><input checked="" type="checkbox"/></td><td><input checked="" type="checkbox"/></td><td><input checked="" type="checkbox"/></td><td><input checked="" type="checkbox"/></td> <td></td> </tr> </table>	1	2	3	4	5	ON OFF	<input checked="" type="checkbox"/>	<input checked="" type="checkbox"/>	<input checked="" type="checkbox"/>	<input checked="" type="checkbox"/>	<input checked="" type="checkbox"/>																																			
1	2	3	4	5	ON OFF																																										
<input checked="" type="checkbox"/>	<input checked="" type="checkbox"/>	<input checked="" type="checkbox"/>	<input checked="" type="checkbox"/>	<input checked="" type="checkbox"/>																																											
PKA-RP71KAL	<table border="1"> <tr> <td>1</td><td>2</td><td>3</td><td>4</td><td>5</td> <td>ON OFF</td> </tr> <tr> <td><input checked="" type="checkbox"/></td><td><input checked="" type="checkbox"/></td><td><input checked="" type="checkbox"/></td><td><input checked="" type="checkbox"/></td><td><input checked="" type="checkbox"/></td> <td></td> </tr> </table>	1	2	3	4	5	ON OFF	<input checked="" type="checkbox"/>	<input checked="" type="checkbox"/>	<input checked="" type="checkbox"/>	<input checked="" type="checkbox"/>	<input checked="" type="checkbox"/>																																			
1	2	3	4	5	ON OFF																																										
<input checked="" type="checkbox"/>	<input checked="" type="checkbox"/>	<input checked="" type="checkbox"/>	<input checked="" type="checkbox"/>	<input checked="" type="checkbox"/>																																											
PKA-RP100KAL	<table border="1"> <tr> <td>1</td><td>2</td><td>3</td><td>4</td><td>5</td> <td>ON OFF</td> </tr> <tr> <td><input checked="" type="checkbox"/></td><td><input checked="" type="checkbox"/></td><td><input checked="" type="checkbox"/></td><td><input checked="" type="checkbox"/></td><td><input checked="" type="checkbox"/></td> <td></td> </tr> </table>	1	2	3	4	5	ON OFF	<input checked="" type="checkbox"/>	<input checked="" type="checkbox"/>	<input checked="" type="checkbox"/>	<input checked="" type="checkbox"/>	<input checked="" type="checkbox"/>																																			
1	2	3	4	5	ON OFF																																										
<input checked="" type="checkbox"/>	<input checked="" type="checkbox"/>	<input checked="" type="checkbox"/>	<input checked="" type="checkbox"/>	<input checked="" type="checkbox"/>																																											
J41 J42	Pair number setting with wireless remote controller	<table border="1"> <thead> <tr> <th rowspan="2">Wireless remote controller setting</th> <th colspan="2">Control PCB setting</th> </tr> <tr> <th>J41</th> <th>J42</th> </tr> </thead> <tbody> <tr> <td>0</td> <td>○</td> <td>○</td> </tr> <tr> <td>1</td> <td>×</td> <td>○</td> </tr> <tr> <td>2</td> <td>○</td> <td>×</td> </tr> <tr> <td>3 ~ 9</td> <td>×</td> <td>×</td> </tr> </tbody> </table>	Wireless remote controller setting	Control PCB setting		J41	J42	0	○	○	1	×	○	2	○	×	3 ~ 9	×	×	<p><Initial setting> Wireless remote controller: 0 Control PCB: ○ (for both J41 and J42) 4 pair number settings are supported. The pair number settings of the wireless remote controller and indoor control PCB (J41/J42) are given in the table on the left. ('×' in the table indicates the jumper wire is disconnected.)</p>																											
Wireless remote controller setting	Control PCB setting																																														
	J41	J42																																													
0	○	○																																													
1	×	○																																													
2	○	×																																													
3 ~ 9	×	×																																													
JP3	Indoor controller board type setting	<table border="1"> <thead> <tr> <th>Indoor controller board type</th> <th>JP3</th> </tr> </thead> <tbody> <tr> <td>For product</td> <td>○</td> </tr> <tr> <td>Service parts</td> <td>○</td> </tr> </tbody> </table>	Indoor controller board type	JP3	For product	○	Service parts	○	<p>○ : With JP3 × : Without JP3</p>																																						
Indoor controller board type	JP3																																														
For product	○																																														
Service parts	○																																														

10-1. ROTATION FUNCTION(AND BACK-UP FUNCTION, 2ND STAGE CUT-IN FUNCTION)

Optional wired remote controller with terminal bed (PAR-21MAAT-E) are necessary for PKA type.

10-1-1. Operation

(1) Rotation function (and Back-up function)

• Outline of functions

- Main and sub unit operate alternately according to the interval of rotation setting.
- ※ Main and sub unit should be set by refrigerant address.(Outdoor Dip switch setting)
 Refrigerant address"00" → Main unit
 Refrigerant address"01" → Sub unit
- When error occurs to one unit, another unit will start operation.(Back-up function)

• System constraint

- This function is available only by the grouping control system(INDOOR UNIT : OUTDOOR UNIT=1:1) of 2 refrigerant groups.(Refer to Fig. 1)
- Main indoor unit should be connected for wired remote controller and the transmission line(TB5) for main and sub unit should also be connected. (Refer to Fig. 1)
 (This function cannot be set by wireless remote controller.)
- Set refrigerant address of each unit.(Dip switch on the outdoor unit...Refrigerant address 00/01)

Operation pattern

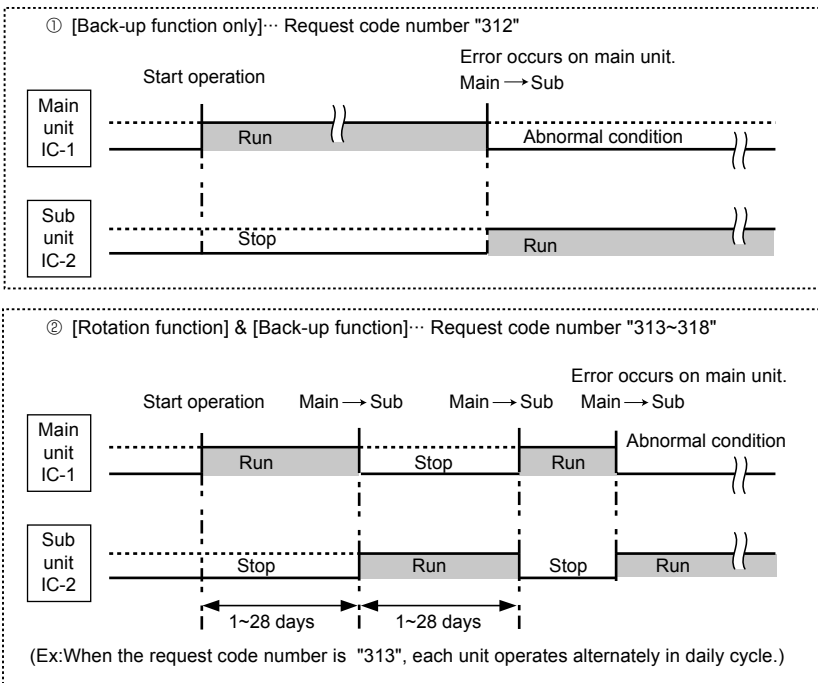
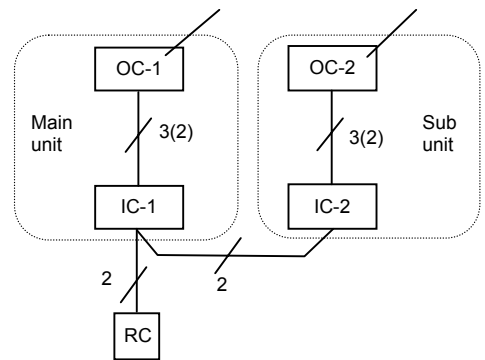

Fig. 1 Refrigerant address "00" Refrigerant address "01"



OC : Outdoor unit
 IC : Indoor unit
 RC : Wired remote controller

Note:

- When the unit is restarted to operate after turning off the power or OFF operation,the unit which was operating will start operation.
- To operate the main unit, refer to the 10-1-2. and set the request code No. which is not the same as the current one, and set again the former request code No.

(2) 2nd stage cut-in function

Outline of functions

- When the 1st unit can NOT supply with sufficient capacity for exceptionally high-demand conditions and the actual room temperature reaches set point *, the 2nd unit starts operation in conjunction with the 1st unit.
- Once the actual room temperature goes down to 4degrees C below set point *, the 2nd unit stops operation automatically.
 (* set point = set temperature by R/C (remote controller) + 4, 6, 8°C (selectable))
- Number of operating units is determined according to the room temperature and set point.
- When room temperature becomes higher than set point, standby unit starts.(2 units operation)
- When room temperature falls below set point -4°C , standby unit stops.(1 unit operation)

• **System constraint**

- This function is available only in cooling mode.

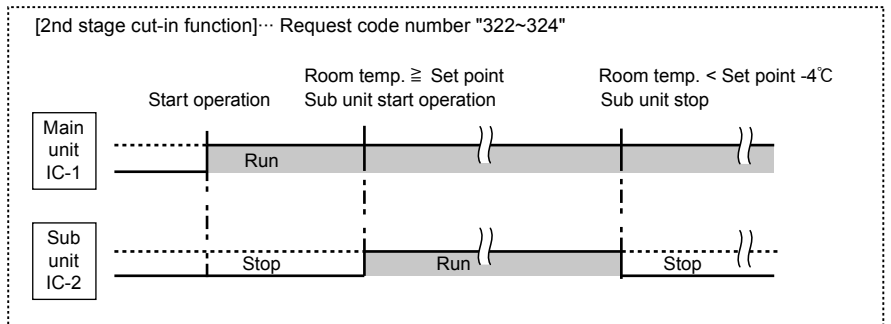
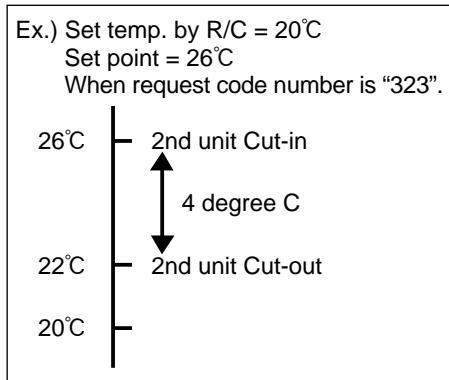

10-1-2. How to set rotation function(Back-up function, 2nd stage cut-in function)

You can set these functions by wired remote controller.(Maintenance monitor)

NOTICE

Both main and sub unit should be set in same setting.
Every time replacing indoor controller board for servicing, the function should be set again.

(1) Request Code List

Rotation setting

Setting No. (Request code)	Setting contents	Initial setting
No.1 (310)	Monitoring the request code of current setting.	
No.2 (311)	Rotation and Back-up OFF (Normal group control operation)	☉
No.3 (312)	Back-up function only	
No.4 (313)	Rotation ON (Alternating interval = 1day) and back-up function	
No.5 (314)	Rotation ON (Alternating interval = 3days) and back-up function	
No.6 (315)	Rotation ON (Alternating interval = 5days) and back-up function	
No.7 (316)	Rotation ON (Alternating interval = 7days) and back-up function	
No.8 (317)	Rotation ON (Alternating interval = 14days) and back-up function	
No.9 (318)	Rotation ON (Alternating interval = 28days) and back-up function	

2nd unit cut-in setting

Setting No. (Request code)	Setting contents	Initial setting
No.1 (320)	Monitoring the request code of current setting.	
No.2 (321)	Cut-in function OFF	☉
No.3 (322)	Cut-in function ON(Set point = Set temp.+ 4°C (7.2°F))	
No.4 (323)	Cut-in function ON(Set point = Set temp.+ 6°C (10.8°F))	
No.5 (324)	Cut-in function ON(Set point = Set temp.+ 8°C (14.4°F))	

(2) Setting method of each function by wired remote controller

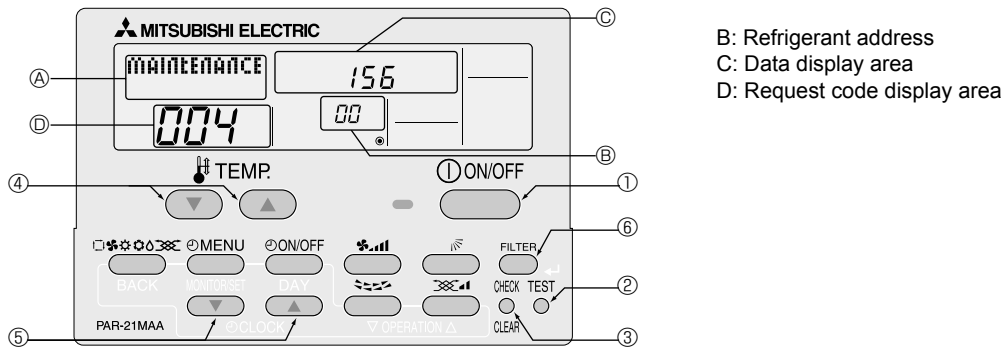

1. Stop operation(①).

2. Press the **TEST** button (②) for 3 seconds so that [Maintenance mode] appears on the screen (A).
After a while, [00] appears in the refrigerant address number display area.(at B)

3. Press the **CHECK** button (③) for 3 seconds to switch to [Maintenance monitor].
Note) It is not possible to switch to [Maintenance monitor] during data request in maintenance mode (i.e., while "----" is blinking) since no buttons are operative.

[----] appears on the screen (D) when [Maintenance monitor] is activated.
(The display (D) now allows you to set a request code No.)

4. Press the [TEMP (∇ and Δ)] buttons (④) to select the desired refrigerant address.

[ScreenB] → **00** ↔ **01** ↔ ↔ **15** ←

5. Press the [CLOCK (∇ and Δ)] buttons (⑤) to set the desired request code No. ("311~318", "321~324")

6. Press the **FILTER** button (⑥) to perform function setting.
If above setting operations are done correctly, "Request code number will appear in data display area.(C)
[Example: When the "311" of "Request code number" is set, [311] appears on the screen.(C)]

[Reference]

You can check current "request code number" setting by setting the "request code number" ("310" or "320") and pressing the **FILTER** button.(⑥)
[Example: When the current setting is "Setting No.2(Request code 311)", [311] appears on the screen.(C)]

7. To return to normal mode, press the **ON/OFF** button (①).

PKA-RP60KAL.TH PKA-RP71KAL.TH PKA-RP100KAL.TH

Be careful when removing heavy parts.

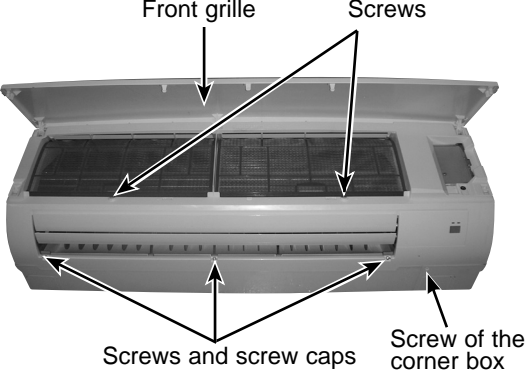
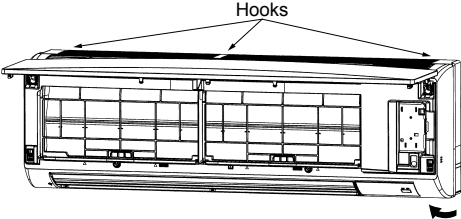
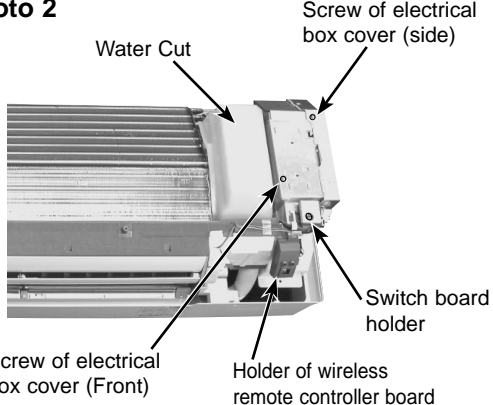
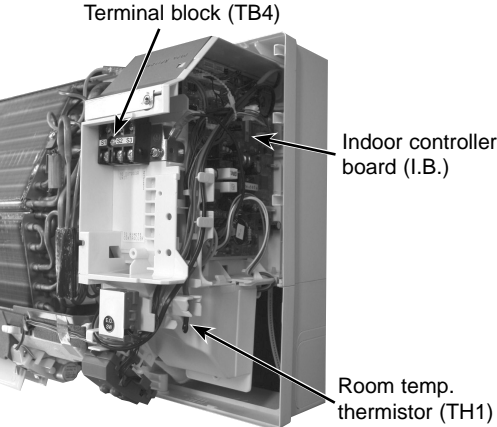
OPERATION PROCEDURE	PHOTOS & ILLUSTRATIONS
<p>1. REMOVING THE PANEL</p> <ol style="list-style-type: none"> (1) Press and unlock the knobs on both sides of the front grille and lift the front grille until it is level. Pull the hinges forward to remove the front grille. (See Photo 1) (2) Remove 3 screw caps of the panel. Remove 5 screws. (See Photo 1) (3) Unfix 3 hooks. (See Figure 1) (4) Hold the lower part of both ends of the panel and pull it slightly toward you, and then remove the panel by pushing it upward. (5) Remove the screw of the corner box. (See Photo 1) Remove the corner box. 	<p>Photo 1</p>  <p>Figure 1</p> 
<p>2. REMOVING THE INDOOR CONTROLLER BOARD AND THE WIRELESS CONTROLLER BOARD</p> <ol style="list-style-type: none"> (1) Remove the panel and the corner box. (Refer to 1.) (2) Remove the front and side electrical box covers (each 1 screw). (See Photo 2) (3) Disconnect the connectors on the indoor controller board. (See Photo 3) (4) Remove the switch board holder and open the cover. (5) Pull out the indoor controller board toward you then remove the indoor controller board and switch board. (See Photo 3) (6) Remove the holder of wireless remote controller board. (7) Disconnect the connector of wireless remote controller board and remove the wireless remote controller board from the holder. 	<p>Photo 2</p>  <p>Photo 3</p> 

OPERATION PROCEDURE

3. REMOVING THE ELECTRICAL BOX

- (1) Remove the panel and the corner box. (Refer to 1.)
- (2) Remove the front and side electrical box covers (each 1 screw).
- (3) Remove the indoor / outdoor connecting wire from terminal block (TB4).
- (4) Disconnect the connectors on the indoor controller board.
- (5) Disconnect the connector for ground wire.
- (6) Remove the screw on lower side of the electrical box. (See Photo 5)
- (7) Push up the upper fixture catch to remove the box, then remove it from the box fixture.

PHOTOS

Photo 4

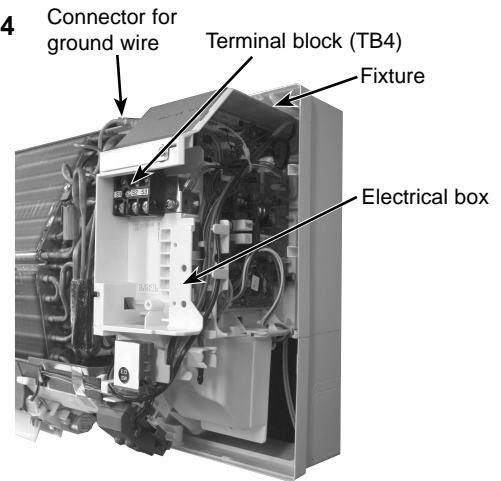

4. REMOVING THE NOZZLE ASSEMBLY (with VANE and VANE MOTOR) AND DRAIN HOSE

- (1) Remove the panel and corner box. (Refer to 1.)
- (2) Remove the electrical box covers. (Refer to 2.)
- (3) Disconnect the vane motor connector (CN151) on the indoor controller board.
- (4) Pull out the drain hose from the nozzle assembly, and remove nozzle assembly. (See Photo 5)

Photo 5 (see the bottom)

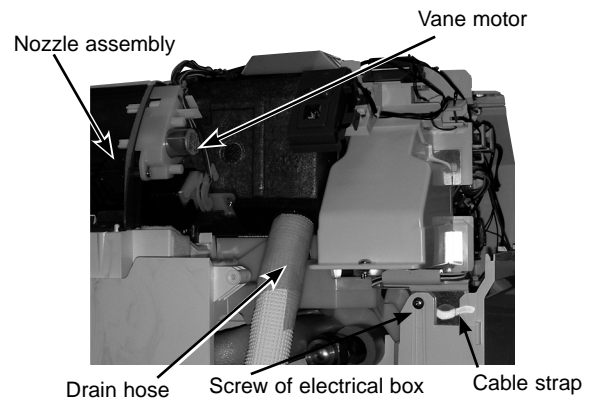

5. REMOVING THE VANE MOTOR

- (1) Remove the nozzle assembly. (Refer to 4.)
- (2) Remove 2 screws of the vane motor unit cover, and pull out the vane motor unit.
- (3) Remove 2 screws of the vane motor unit.
- (4) Remove the vane motor from the vane motor unit.
- (5) Disconnect the connector from the vane motor.

Photo 6

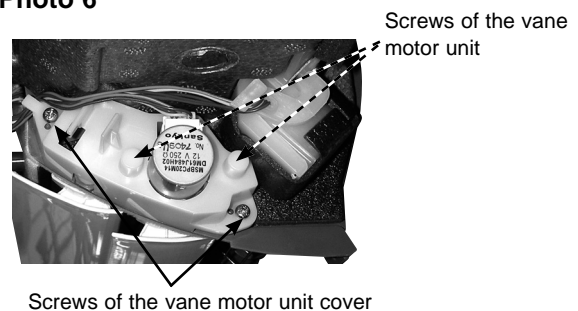

OPERATION PROCEDURE

6. REMOVING THE INDOOR FAN MOTOR AND THE LINE FLOW FAN

- (1) Remove the panel and the corner box. (Refer to 1.)
- (2) Remove the electrical box (Refer to 2.) and the nozzle assembly (Refer to 3.).
- (3) Remove the water cut. (See Photo 2)
- (4) Remove the screw fixing the line flow fan. (See Photo 8)
- (5) Remove 5 screws fixing the motor bed. (See Photo 7)
- (6) Remove the lead wire of pipe thermistor from the hook of motor bed. (See Photo 7)
- (7) Remove the screw fixing motor band. (See Photo 7)
- (8) Remove the motor bed together with fan motor and motor band.
- (9) Remove 3 screws fixing the left side of the heat exchanger. (See Photo 9)
- (10) Lift the heat exchanger, and pull out the line flow fan to the lower-left.

Photo 9

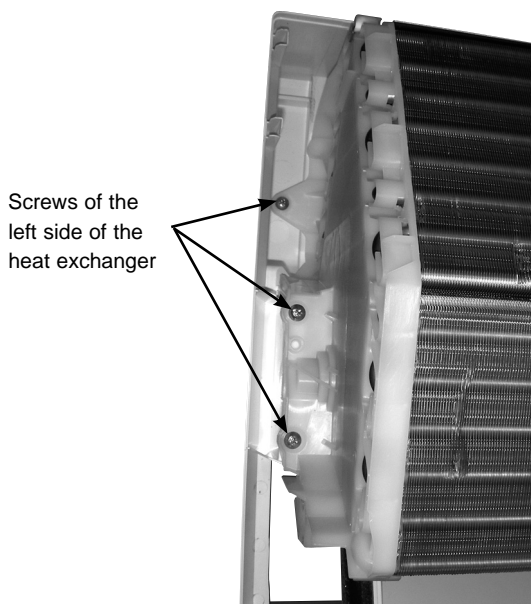

PHOTOS

Photo 7

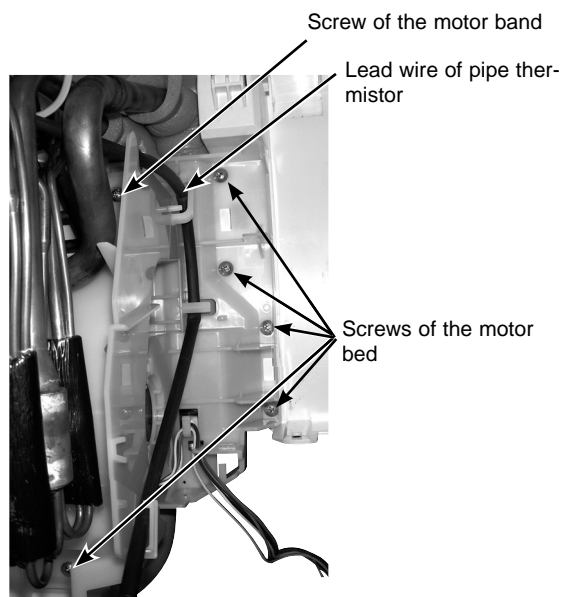
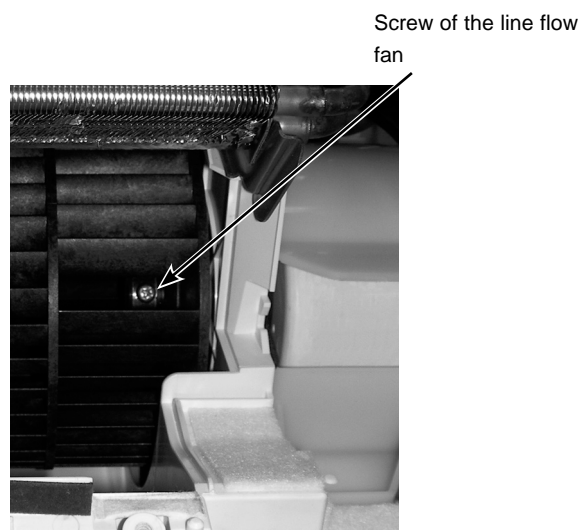

Photo 8



7. REMOVING THE LIQUID PIPE THERMISTOR AND COND / EVA PIPE THERMISTOR

- (1) Remove the panel and the corner box. (Refer to 1)
- (2) Remove the electrical box covers. (Refer to 2.)
- (3) Remove the water cut. (See Photo 2)
- (4) Remove the liquid pipe thermistor and cond / eva thermistor.
- (5) Disconnect the connector (CN44) on the indoor controller board.

Photo 10

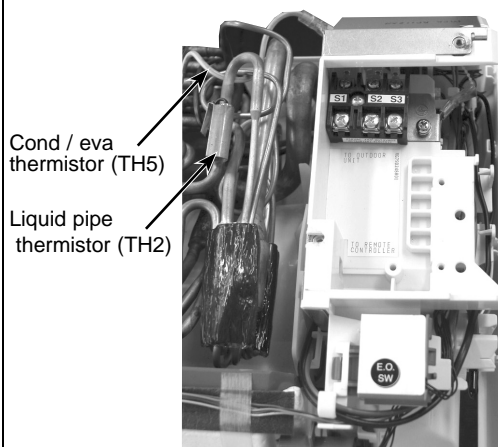

OPERATION PROCEDURE

8. REMOVING THE HEAT EXCHANGER

- (1) Remove the panel and the corner box. (Refer to 1.)
- (2) Remove the electrical box (Refer to 3.) and the nozzle assembly (Refer to 4.).
- (3) Remove the water cut.
- (4) Remove the pipe thermistors from each holder.
- (5) Disconnect the connector for ground wire.
- (6) Remove 3 screws fixing the left side of the heat exchanger. (See Photo 9)
- (7) Remove the heat exchanger.

PHOTOS

Photo 11

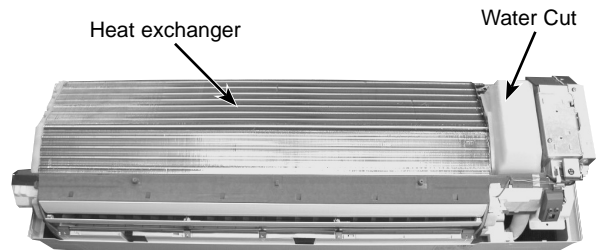
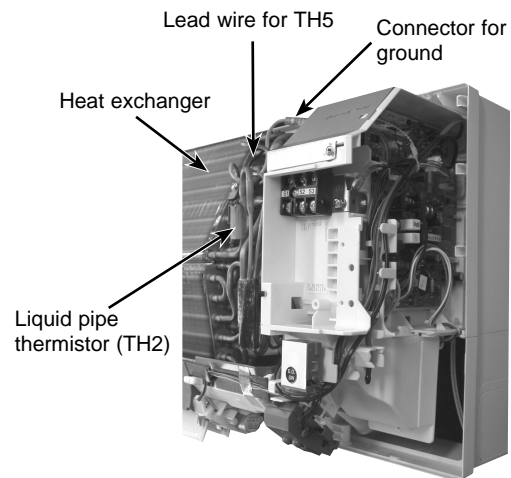

Photo 12



9. REMOVING THE ROOM TEMPERATURE THERMISTOR

- (1) Remove the panel and corner box. (Refer to 1.)
- (2) Remove the electrical box covers.
- (3) Remove the room temperature thermistor.
- (4) Disconnect the connector (CN20) on the indoor controller board.

Photo 13

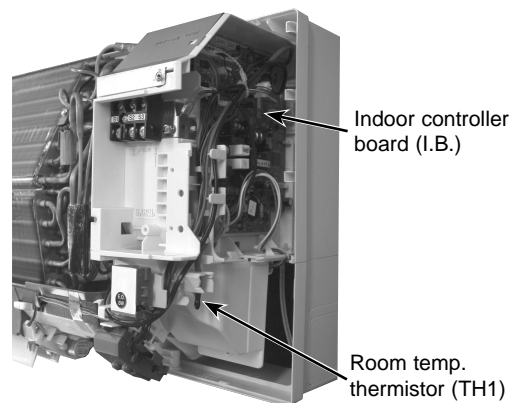

 **MITSUBISHI ELECTRIC CORPORATION**

HEAD OFFICE : TOKYO BLDG., 2-7-3, MARUNOUCHI, CHIYODA-KU, TOKYO 100-8310, JAPAN