

SERVICE MANUAL

Series PLA Ceiling Cassettes R410A

Indoor unit
[Model names] [Service Ref.]

PLA-ZRP35BA	PLA-ZRP35BA.UK
PLA-ZRP50BA	PLA-ZRP50BA.UK
PLA-ZRP60BA	PLA-ZRP60BA.UK
PLA-ZRP71BA	PLA-ZRP71BA.UK
PLA-ZRP125BA	PLA-ZRP125BA.UK
PLA-ZRP140BA	PLA-ZRP140BA.UK

NOTE:

- This manual describes only service data of the indoor units.
- RoHS compliant products have <G> mark on the spec name plate.

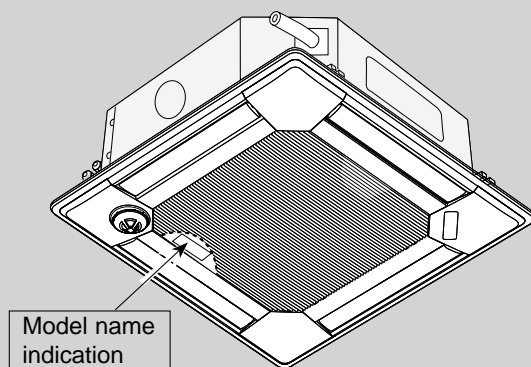

INDOOR UNIT

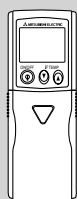
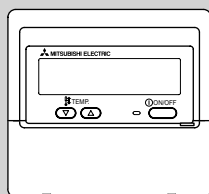
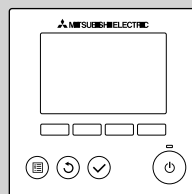
 WIRELESS REMOTE
CONTROLLER

 WIRED REMOTE
CONTROLLER

CONTENTS

1. REFERENCE MANUAL.....	2
2. SAFETY PRECAUTION.....	3
3. PART NAMES AND FUNCTIONS.....	4
4. SPECIFICATIONS.....	12
5. NOISE CRITERION CURVES.....	14
6. OUTLINES AND DIMENSIONS.....	16
7. WIRING DIAGRAM.....	17
8. REFRIGERANT SYSTEM DIAGRAM.....	18
9. TROUBLESHOOTING.....	19
10. SPECIAL FUNCTION.....	35
11. DISASSEMBLY PROCEDURE.....	45

PARTS CATALOG (OCB535)

OUTDOOR UNIT'S SERVICE MANUAL

Service Ref.	Service Manual No.
PUHZ-ZRP35/50VKA PUHZ-ZRP60/71VHA PUHZ-ZRP125/140VKA PUHZ-ZRP125/140YKA	OCH527/OCB527

2

SAFETY PRECAUTION

2-1. ALWAYS OBSERVE FOR SAFETY

Before obtaining access to terminal, all supply circuits must be disconnected.

2-2. CAUTIONS RELATED TO NEW REFRIGERANT

Caution for units utilising refrigerant R410A

Use new refrigerant pipes.

In case of using the existing pipes for R22, be careful with the followings.

- For ZRP125 and 140, be sure to perform replacement operation before test run.
- Change flare nut to the one provided with this product. Use a newly flared pipe.
- Avoid using thin pipes.

Make sure that the inside and outside of refrigerant piping is clean and it has no contaminants such as sulfur, oxides, dirt, shaving particles, etc, which are hazard to refrigerant cycle. In addition, use pipes with specified thickness.

Contamination inside refrigerant piping can cause deterioration of refrigerant oil etc.

Store the piping indoors, and keep both ends of the piping sealed until just before brazing. (Leave elbow joints, etc. in their packaging.)

If dirt, dust or moisture enters into refrigerant cycle, that can cause deterioration of refrigerant oil or malfunction of compressor.

The refrigerant oil applied to flare and flange connections must be ester oil, ether oil or alkylbenzene oil in a small amount.

If large amount of mineral oil enters, that can cause deterioration of refrigerant oil etc.

Charge refrigerant from liquid phase of gas cylinder.

If the refrigerant is charged from gas phase, composition change may occur in refrigerant and the efficiency will be lowered.

Do not use refrigerant other than R410A.

If other refrigerant (R22 etc.) is used, chlorine in refrigerant can cause deterioration of refrigerant oil etc.

Use a vacuum pump with a reverse flow check valve.

Vacuum pump oil may flow back into refrigerant cycle and that can cause deterioration of refrigerant oil etc.

Use the following tools specifically designed for use with R410A refrigerant.

The following tools are necessary to use R410A refrigerant.

Tools for R410A	
Gauge manifold	Flare tool
Charge hose	Size adjustment gauge
Gas leak detector	Vacuum pump adaptor
Torque wrench	Electronic refrigerant charging scale

Handle tools with care.

If dirt, dust or moisture enters into refrigerant cycle, that can cause deterioration of refrigerant oil or malfunction of compressor.

Do not use a charging cylinder.

If a charging cylinder is used, the composition of refrigerant will change and the efficiency will be lowered.

Use the specified refrigerant only.

Never use any refrigerant other than that specified.

Doing so may cause a burst, an explosion, or fire when the unit is being used, serviced, or disposed of.

Correct refrigerant is specified in the manuals and on the spec labels provided with our products.

We will not be held responsible for mechanical failure, system malfunction, unit breakdown or accidents caused by failure to follow the instructions.

Ventilate the room if refrigerant leaks during operation. If refrigerant comes into contact with a flame, poisonous gases will be released.

[1] Cautions for service

- (1) Perform service after recovering the refrigerant left in unit completely.
- (2) Do not release refrigerant in the air.
- (3) After completing service, charge the cycle with specified amount of refrigerant.
- (4) When performing service, install a filter drier simultaneously.
Be sure to use a filter drier for new refrigerant.

[2] Additional refrigerant charge

When charging directly from cylinder

- Check that cylinder for R410A available on the market is syphon type.
- Charging should be performed with the cylinder of syphon stood vertically. (Refrigerant is charged from liquid phase.)

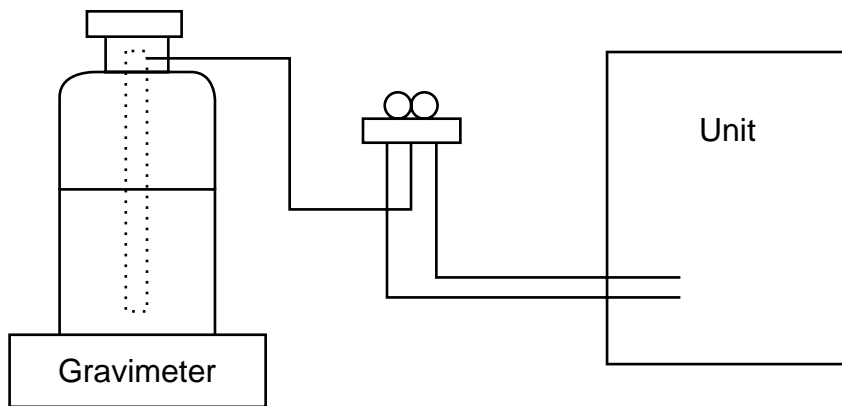

[3] Service tools

Use the below service tools as exclusive tools for R410A refrigerant.

No.	Tool name	Specifications
①	Gauge manifold	· Only for R410A
		· Use the existing fitting specifications. (UNF1/2)
		· Use high-tension side pressure of 5.3MPa-G or over.
②	Charge hose	· Only for R410A
		· Use pressure performance of 5.09MPa-G or over.
③	Electronic scale	—
④	Gas leak detector	· Use the detector for R134a, R407C or R410A.
⑤	Adaptor for reverse flow check	· Attach on vacuum pump.
⑥	Refrigerant charge base	—
⑦	Refrigerant cylinder	· Only for R410A · Top of cylinder (Pink)
		· Cylinder with syphon
⑧	Refrigerant recovery equipment	—

3 PART NAMES AND FUNCTIONS

3-1. INDOOR UNIT

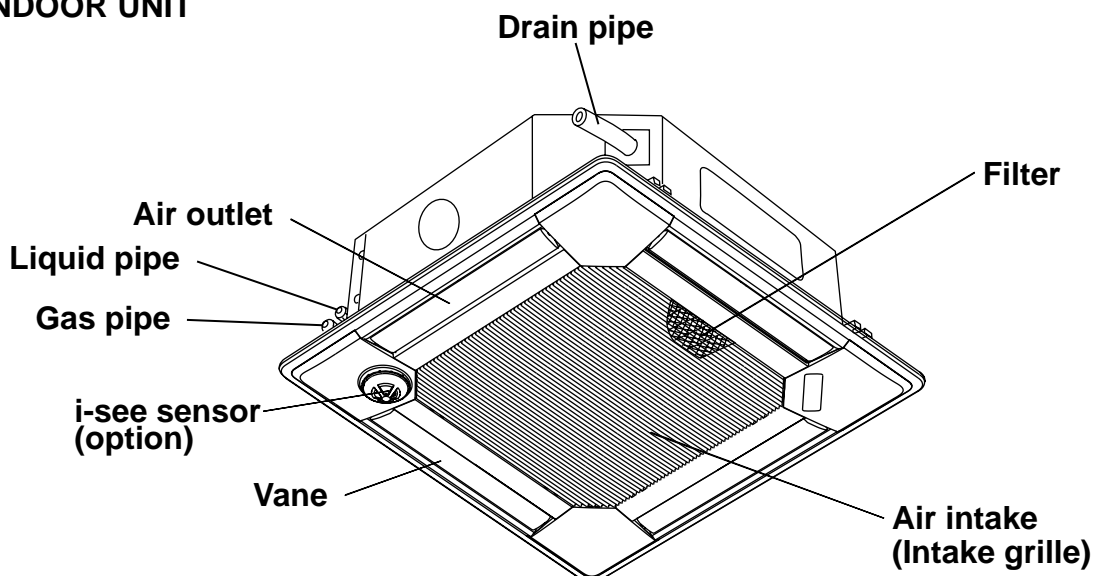

3-2. WIRELESS REMOTE CONTROLLER

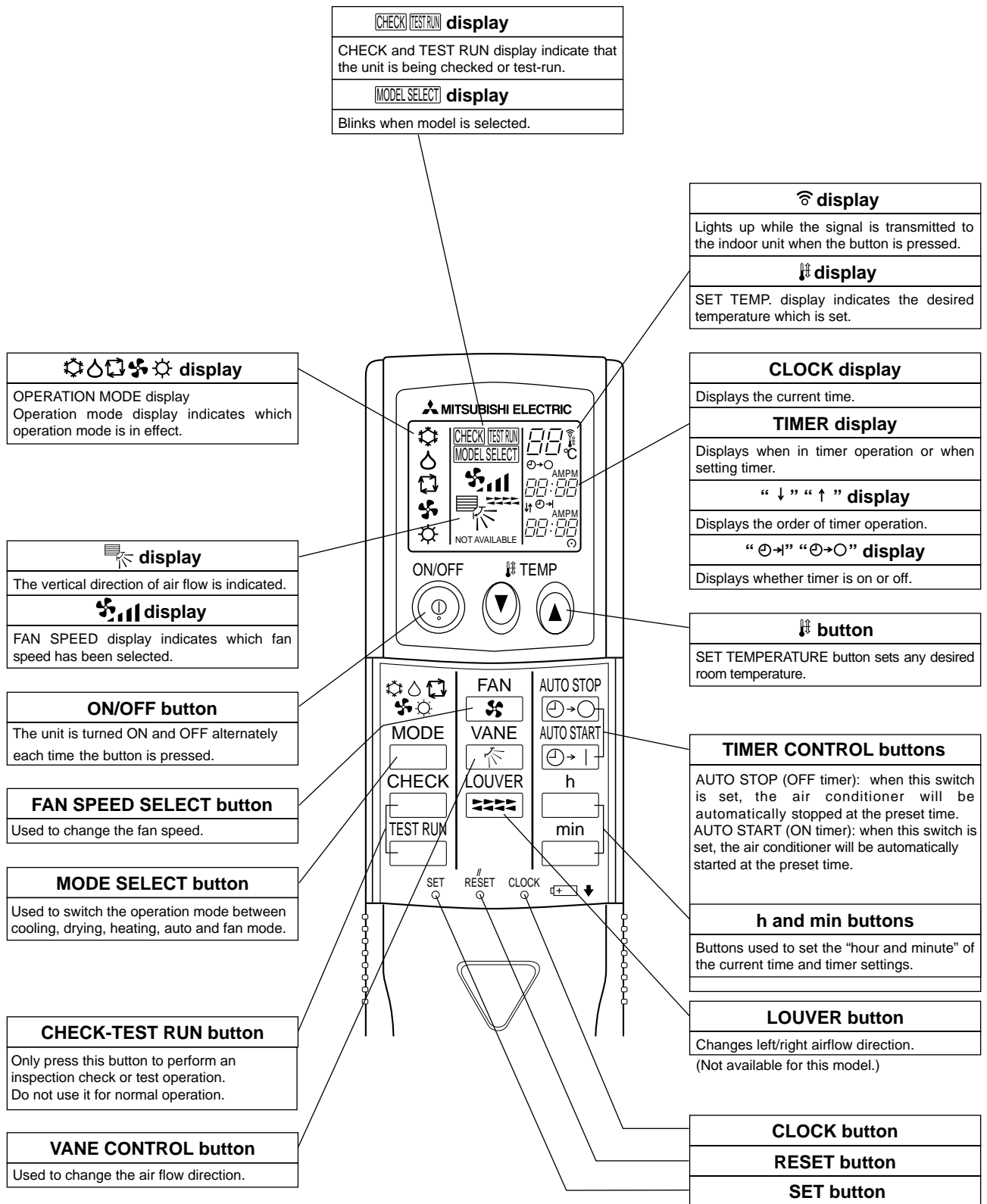

3-3. WIRED REMOTE CONTROLLER <PAR-30MAA / PAR-31MAA>

Wired remote controller function

* The functions which can be used are restricted according to the model.

○ : Supported × : Unsupported

	Function	PAR-30MAA / PAR-31MAA		PAR-21MAA
		Slim	City multi	
Body	Product size H x W x D (mm)	120 x 120 x 19		120 x 130 x 19
	LCD	Full Dot LCD		Partial Dot LCD
	Backlight	○		×
Energy-saving	Energy-saving operation schedule	○	×	×
	Automatic return to the preset temperature	○		×
Restriction	Setting the temperature range restriction	○		○
Function	Operation lock function	○		○
	Weekly timer	○		×
	On / Off timer	○		○
	High Power	○	×	×
	Manual vane angle	○		○

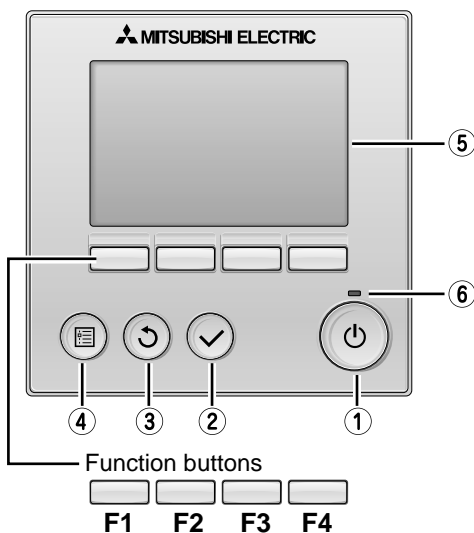

The functions of the function buttons change depending on the screen. Refer to the button function guide that appears at the bottom of the LCD for the functions they serve on a given screen.

When the system is centrally controlled, the button function guide that corresponds to the locked button will not appear.

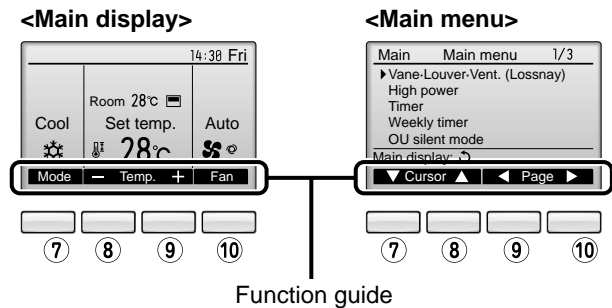

① ON / OFF button

Press to turn ON/OFF the indoor unit.

② SELECT button

Press to save the setting.

③ RETURN button

Press to return to the previous screen.

④ MENU button

Press to bring up the Main menu.

⑤ Backlit LCD

Operation settings will appear. When the backlight is off, pressing any button turns the backlight on and it will stay lit for a certain period of time depending on the screen.

When the backlight is off, pressing any button turns the backlight on and does not perform its function. (except for the (1) (ON / OFF) button)

⑥ ON / OFF lamp

This lamp lights up in green while the unit is in operation. It blinks while the remote controller is starting up or when there is an error.

⑦ Function button F1

Main display : Press to change the operation mode.
Main menu : Press to move the cursor down.

⑧ Function button F2

Main display : Press to decrease temperature.
Main menu : Press to move the cursor up.

⑨ Function button F3

Main display : Press to increase temperature.
Main menu : Press to go to the previous page.

⑩ Function button F4

Main display : Press to change the fan speed.
Main menu : Press to go to the next page.

The main display can be displayed in two different modes: "Full" and "Basic".
The factory setting is "Full". To switch to the "Basic" mode, change the setting on the Main display setting.

<Full mode>

* All icons are displayed for explanation.

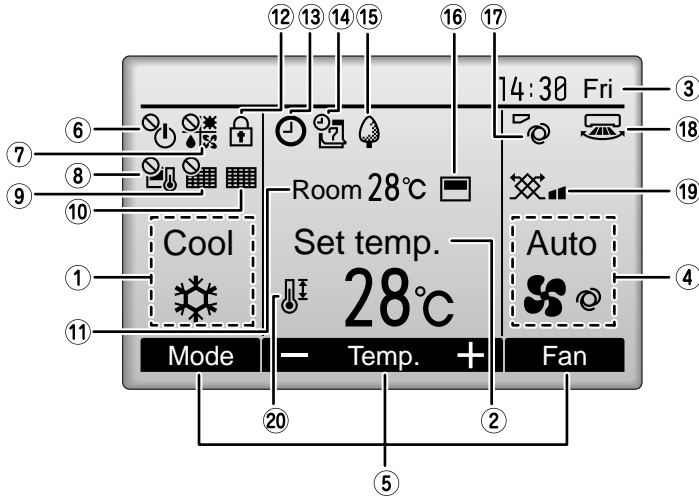

<Basic mode>

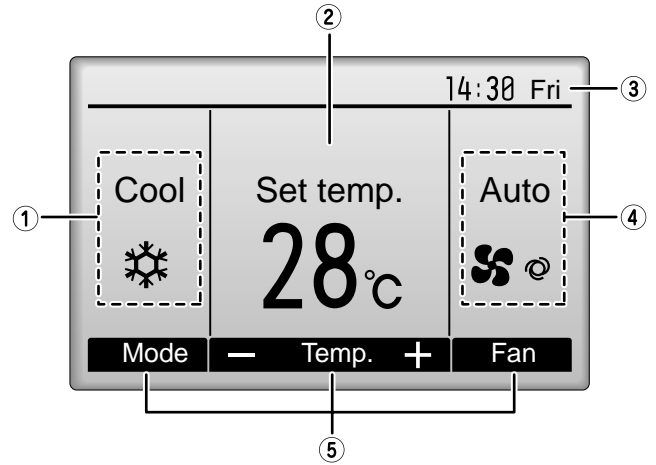

- ① Operation mode**
Indoor unit operation mode appears here.
- ② Preset temperature**
Preset temperature appears here.
- ③ Clock (See the Installation Manual.)**
Current time appears here.
- ④ Fan speed**
Fan speed setting appears here.
- ⑤ Button function guide**
Functions of the corresponding buttons appear here.
- ⑥**
Appears when the ON/OFF operation is centrally controlled.
- ⑦**
Appears when the operation mode is centrally controlled.
- ⑧**
Appears when the preset temperature is centrally controlled.
- ⑨**
Appears when the filter reset function is centrally controlled.
- ⑩**
Indicates when filter needs maintenance.
- ⑪ Room temperature (See the Installation Manual.)**
Current room temperature appears here.

- ⑫**
Appears when the buttons are locked.
- ⑬**
Appears when the On/Off timer or Night setback function is enabled.
- ⑭**
Appears when the Weekly timer is enabled.
- ⑮**
Appears while the units are operated in the energy-save mode.
- ⑯**
Appears when the built-in thermistor on the remote controller is activated to monitor the room temperature (a).
 appears when the thermistor on the indoor unit is activated to monitor the room temperature.
- ⑰**
Indicates the vane setting.
- ⑱**
Indicates the louver setting.
- ⑲**
Indicates the ventilation setting.
- ⑳**
Appears when the preset temperature range is restricted.

Most settings (except ON / OFF, mode, fan speed, temperature) can be made from the Menu screen.

Menu structure

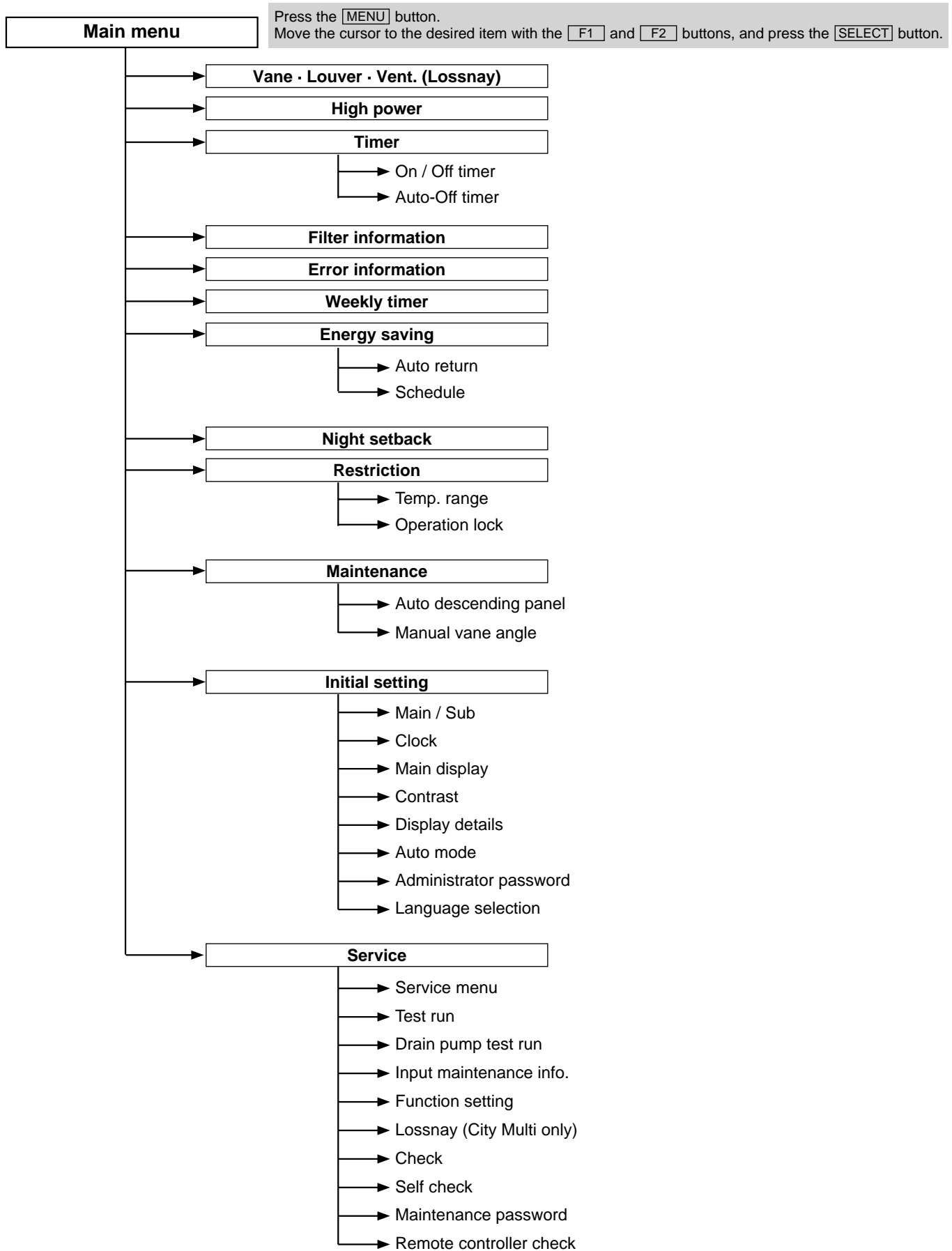

Not all functions are available on all models of indoor units.



Main menu list

Setting and display items		Setting details
Vane · Louver · Vent. (Lossnay)		<p>Use to set the vane angle.</p> <ul style="list-style-type: none"> • Select a desired vane setting from five different settings. <p>Use to turn ON / OFF the louver.</p> <ul style="list-style-type: none"> • Select a desired setting from "ON" and "OFF." <p>Use to set the amount of ventilation.</p> <ul style="list-style-type: none"> • Select a desired setting from "Off," "Low," and "High."
High power		<p>Use to reach the comfortable room temperature quickly.</p> <ul style="list-style-type: none"> • Units can be operated in the High-power mode for up to 30 minutes.
Timer	On/Off timer	<p>Use to set the operation On/Off times.</p> <ul style="list-style-type: none"> • Time can be set in 5-minute increments. * Clock setting is required.
	Auto-Off timer	<p>Use to set the Auto-Off time.</p> <ul style="list-style-type: none"> • Time can be set to a value from 30 to 240 in 10-minute increments.
Filter information		<p>Use to check the filter status.</p> <ul style="list-style-type: none"> • The filter sign can be reset.
Error information		<p>Use to check error information when an error occurs.</p> <ul style="list-style-type: none"> • Error code, error source, refrigerant address, unit model, manufacturing number, contact information (dealer's phone number) can be displayed. * The unit model, manufacturing number, and contact information need to be registered in advance to be displayed.
Weekly timer		<p>Use to set the weekly operation On / Off times.</p> <ul style="list-style-type: none"> • Up to eight operation patterns can be set for each day. * Clock setting is required. * Not valid when the On/Off timer is enabled.
Energy saving	Auto return	<p>Use to get the units to operate at the preset temperature after performing energy-save operation for a specified time period.</p> <ul style="list-style-type: none"> • Time can be set to a value from 30 and 120 in 10-minute increments. * This function will not be valid when the preset temperature ranges are restricted.
	Schedule	<p>Set the start/stop times to operate the units in the energy-save mode for each day of the week, and set the energy-saving rate.</p> <ul style="list-style-type: none"> • Up to four energy-save operation patterns can be set for each day. • Time can be set in 5-minute increments. • Energy-saving rate can be set to a value from 0% or 50 to 90% in 10% increments. * Clock setting is required.
Night setback		<p>Use to make Night setback settings.</p> <ul style="list-style-type: none"> • Select "Yes" to enable the setting, and "No" to disable the setting. The temperature range and the start/stop times can be set. * Clock setting is required.
Restriction	Temp. range	<p>Use to restrict the preset temperature range.</p> <ul style="list-style-type: none"> • Different temperature ranges can be set for different operation modes.
	Operation lock	<p>Use to lock selected functions.</p> <ul style="list-style-type: none"> • The locked functions cannot be operated.
Maintenance	Auto descending panel	<p>Auto descending panel (Optional parts) Up / Down you can do.</p>
	Manual vane angle	<p>Use to set the vane angle for each vane to a fixed position.</p>
Initial setting	Main/Sub	<p>When connecting two remote controllers, one of them needs to be designated as a sub controller.</p>
	Clock	<p>Use to set the current time.</p>
	Main display	<p>Use to switch between "Full" and "Basic" modes for the Main display.</p> <ul style="list-style-type: none"> • The default setting is "Full."
	Contrast	<p>Use to adjust screen contrast.</p>



Setting and display items		Setting details
Initial setting	Display details	<p>Make the settings for the remote controller related items as necessary.</p> <p>Clock: The factory settings are "Yes" and "24h" format.</p> <p>Temperature: Set either Celsius (°C) or Fahrenheit (°F).</p> <p>Room temp. : Set Show or Hide.</p> <p>Auto mode: Set the Auto mode display or Only Auto display.</p>
	Auto mode	<p>Whether or not to use the AUTO mode can be selected by using the button.</p> <p>This setting is valid only when indoor units with the AUTO mode function are connected.</p>
	Administrator password	<p>The administrator password is required to make the settings for the following items.</p> <ul style="list-style-type: none"> • Timer setting • Energy-save setting • Weekly timer setting • Restriction setting • Outdoor unit silent mode setting • Night set back
	Language selection	<p>Use to select the desired language.</p>
Service	Test run	<p>Select "Test run" from the Service menu to bring up the Test run menu.</p> <ul style="list-style-type: none"> • Test run • Drain pump test run
	Input maintenance	<p>Select "Input maintenance Info." from the Service menu to bring up the Maintenance information screen.</p> <p>The following settings can be made from the Maintenance Information screen.</p> <ul style="list-style-type: none"> • Model name input • Serial No. input • Dealer information input
	Function setting	<p>Make the settings for the indoor unit functions via the remote controller as necessary.</p>
	LOSSNAY setting (City Multi only)	<p>This setting is required only when the operation of City Multi units is interlocked with LOSSNAY units.</p>
	Check	<p>Error history: Display the error history and execute delete error history.</p> <p>Refrigerant leak check: Refrigerant leaks can be judged.</p> <p>Smooth maintenance: The indoor and outdoor maintenance data can be displayed.</p> <p>Request cord: Details of the operation data including each thermistor temperature and error history can be checked.</p>
	Self check	<p>Error history of each unit can be checked via the remote controller.</p>
	Maintenance password	<p>Take the following steps to change the maintenance password.</p>
	Remote controller check	<p>When the remote controller does not work properly, use the remote controller checking function to troubleshoot the problem.</p>

3-4. WIRED REMOTE CONTROLLER <PAR-21MAA>

Display Section

For purposes of this explanation, all parts of the display are shown. During actual operation, only the relevant items will be lit.

Identifies the current operation

Shows the operating mode, etc.
*Multilanguage display is available.

"Centrally Controlled" indicator

Indicates that operation from the remote controller has been prohibited by a master controller.

"Timer is Off" indicator

Indicates that the timer is off.

Temperature Setting

Shows the target temperature.

Day-of-Week

Shows the current day of the week.

Time/Timer Display

Shows the current time, unless the simple or Auto Off timer is set. If the simple or Auto Off timer is set, the time to be switched off is shown.

"Sensor" indication

Displayed when the remote controller sensor is used.

"Locked" indicator

Indicates that remote controller buttons have been locked.

"Clean The Filter" indicator

To be displayed on when it is time to clean the filter.

Timer indicators

The indicator comes on if the corresponding timer is set.

Fan Speed indicator

Shows the selected fan speed.

Ventilation indicator

Appears when the unit is running in Ventilation mode.

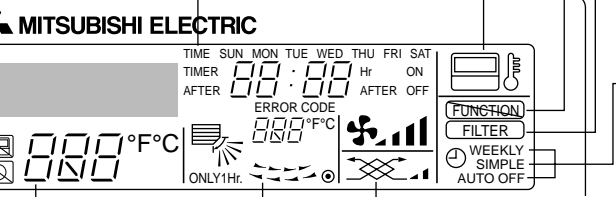

Up/Down Air Direction indicator

The indicator \ shows the direction of the outgoing airflow.

"One Hour Only" indicator

Displayed if the airflow is set to low or downward during COOL or DRY mode. (Operation varies according to model.) The indicator goes off in 1 hour, when the airflow direction also changes.

Room Temperature display

Shows the room temperature. The room temperature display range is 8 – 39°C. The display blinks if the temperature is less than 8°C or 39°C or more.

Louver display

Indicates the action of the swing louver. Does not appear if the louver is not running.

● (Power On indicator)

Indicates that the power is on.

Operation Section

Temperature setting buttons

- ▽ Down
- △ Up

Timer Menu button (Monitor/Set button)

Mode button (Return button)

Set Time buttons

- ▽ Back
- △ Ahead

Timer On/Off button (Set Day button)

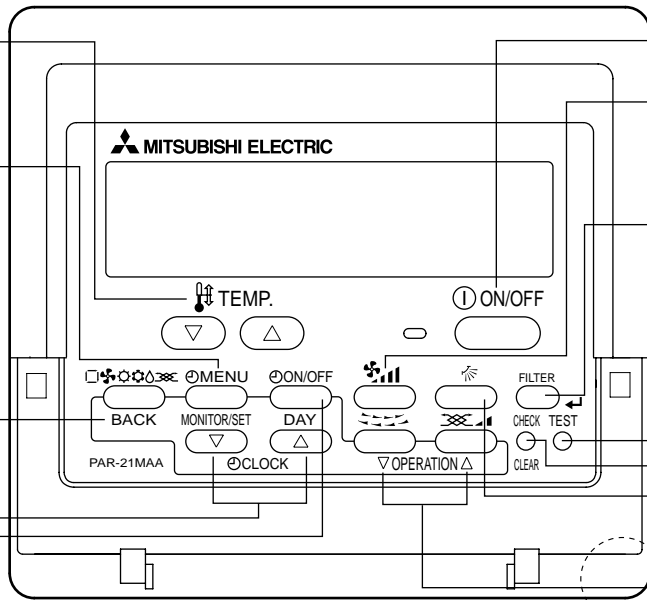
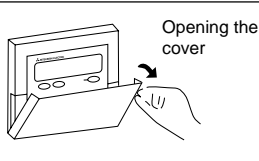

ON/OFF button

Fan Speed button

Filter button (<Enter> button)

Test Run button

Check button (Clear button)

Airflow Up/Down button

Louver button (▽ Operation button)

- ▽ To return operation number

Ventilation button (△ Operation button)

- △ To go to next operation number

Note:

- "PLEASE WAIT" message
This message is displayed for approximately 3 minutes when power is supplied to the indoor unit or when the unit is recovering from a power failure.
- "NOT AVAILABLE" message
This message is displayed if an invalid button is pressed (to operate a function that the indoor unit does not have).
If a single remote controller is used to operate multiple indoor units simultaneously that are different types, this message will not be displayed as far as any of the indoor units is equipped with the function.

4

SPECIFICATIONS

Service Ref.			PLA-ZRP35BA.UK	
Mode			Cooling	Heating
Power supply (phase, cycle, voltage)			Single phase, 50Hz, 230V	
Input			0.04	0.03
Running current			0.28	0.25
External finish (Panel)			Munsell 6.4Y 8.9/0.4	
Heat exchanger			Plate fin coil	
Fan (drive) × No.			Turbo fan (direct) × 1	
Fan motor output			0.050	
Airflow (Low-Medium2-Medium1-High)			11-13-15-16(390-460-530-565)	
External static pressure			0(direct blow)	
Booster heater			-	
Operation control & Thermostat			Remote controller & built-in	
Noise level (Low-Medium2-Medium1-High)			27-28-29-31	
Field drain pipe O.D.			32 (1-1/4)	
Dimensions	W	mm(in.)	UNIT : 840 (33-1/16)	PANEL : 950 (37-3/8)
	D	mm(in.)	UNIT : 840 (33-1/16)	PANEL : 950 (37-3/8)
	H	mm(in.)	UNIT : 258 (10-3/16)	PANEL : 35 (1-3/8)
Weight			UNIT : 23 (51)	PANEL : 6 (13)

Service Ref.			PLA-ZRP50BA.UK	
Mode			Cooling	Heating
Power supply (phase, cycle, voltage)			Single phase, 50Hz, 230V	
Input			0.04	0.03
Running current			0.30	0.27
External finish (Panel)			Munsell 6.4Y 8.9/0.4	
Heat exchanger			Plate fin coil	
Fan (drive) × No.			Turbo fan (direct) × 1	
Fan motor output			0.050	
Airflow (Low-Medium2-Medium1-High)			12-14-16-18(425-495-565-635)	
External static pressure			0(direct blow)	
Booster heater			-	
Operation control & Thermostat			Remote controller & built-in	
Noise level (Low-Medium2-Medium1-High)			28-29-31-32	
Field drain pipe O.D.			32(1-1/4)	
Dimensions	W	mm(in.)	UNIT : 840 (33-1/16)	PANEL : 950 (37-3/8)
	D	mm(in.)	UNIT : 840 (33-1/16)	PANEL : 950 (37-3/8)
	H	mm(in.)	UNIT : 258 (10-3/16)	PANEL : 35 (1-3/8)
Weight			UNIT : 23 (51)	PANEL : 6 (13)

Service Ref.			PLA-ZRP60BA.UK	
Mode			Cooling	Heating
Power supply (phase, cycle, voltage)			Single phase, 50Hz, 230V	
Input			0.04	0.03
Running current			0.30	0.27
External finish (Panel)			Munsell 6.4Y 8.9/0.4	
Heat exchanger			Plate fin coil	
Fan (drive) × No.			Turbo fan (direct) × 1	
Fan motor output			0.050	
Airflow (Low-Medium2-Medium1-High)			12-14-16-18(425-495-565-635)	
External static pressure			0(direct blow)	
Booster heater			-	
Operation control & Thermostat			Remote controller & built-in	
Noise level (Low-Medium2-Medium1-High)			28-29-31-32	
Field drain pipe O.D.			32(1-1/4)	
Dimensions	W	mm(in.)	UNIT : 840 (33-1/16)	PANEL : 950 (37-3/8)
	D	mm(in.)	UNIT : 840 (33-1/16)	PANEL : 950 (37-3/8)
	H	mm(in.)	UNIT : 258 (10-3/16)	PANEL : 35 (1-3/8)
Weight			UNIT : 23 (51)	PANEL : 6 (13)



Service Ref.			PLA-ZRP71BA.UK		
INDOOR UNIT	Mode		Cooling	Heating	
	Power supply (phase, cycle, voltage)		Single phase, 50Hz, 230V		
	Input	kW	0.05	0.04	
	Running current	A	0.45	0.41	
	External finish (Panel)		Munsell 6.4Y 8.9/0.4		
	Heat exchanger		Plate fin coil		
	Fan	Fan (drive) × No.		Turbo fan (direct) × 1	
		Fan motor output	kW	0.120	
		Airflow (Low-Medium2-Medium1-High)	m³/min(CFM)	17-19-21-23(600-671-740-810)	
		External static pressure	Pa(mmAq)	0(direct blow)	
	Booster heater		kW	-	
	Operation control & Thermostat		Remote controller & built-in		
	Noise level (Low-Medium2-Medium1-High)		dB	28-30-34-36	
	Field drain pipe O.D.		mm(in.)	32(1-1/4)	
	Dimensions	W	mm(in.)	UNIT : 840 (33-1/16)	PANEL : 950 (37-3/8)
D		mm(in.)	UNIT : 840 (33-1/16)	PANEL : 950 (37-3/8)	
H		mm(in.)	UNIT : 298 (11-3/4)	PANEL : 35 (1-3/8)	
Weight		kg(lbs)	UNIT : 25 (55)	PANEL : 6 (13)	

Service Ref.			PLA-ZRP125BA.UK		
INDOOR UNIT	Mode		Cooling	Heating	
	Power supply (phase, cycle, voltage)		Single phase, 50Hz, 230V		
	Input	kW	0.09	0.08	
	Running current	A	0.80	0.71	
	External finish (Panel)		Munsell 6.4Y 8.9/0.4		
	Heat exchanger		Plate fin coil		
	Fan	Fan (drive) × No.		Turbo fan (direct) × 1	
		Fan motor output	kW	0.120	
		Airflow (Low-Medium2-Medium1-High)	m³/min(CFM)	22-25-28-31(780-880-990-1,090)	
		External static pressure	Pa(mmAq)	0(direct blow)	
	Booster heater		kW	-	
	Operation control & Thermostat		Remote controller & built-in		
	Noise level (Low-Medium2-Medium1-High)		dB	34-36-39-41	
	Field drain pipe O.D.		mm(in.)	32(1-1/4)	
	Dimensions	W	mm(in.)	UNIT : 840 (33-1/16)	PANEL : 950 (37-3/8)
D		mm(in.)	UNIT : 840 (33-1/16)	PANEL : 950 (37-3/8)	
H		mm(in.)	UNIT : 298 (11-3/4)	PANEL : 35 (1-3/8)	
Weight		kg(lbs)	UNIT : 27 (60)	PANEL : 6 (13)	

Service Ref.			PLA-ZRP140BA.UK		
INDOOR UNIT	Mode		Cooling	Heating	
	Power supply (phase, cycle, voltage)		Single phase, 50Hz, 230V		
	Input	kW	0.12	0.11	
	Running current	A	1.07	0.95	
	External finish (Panel)		Munsell 6.4Y 8.9/0.4		
	Heat exchanger		Plate fin coil		
	Fan	Fan(drive) × No.		Turbo fan (direct) × 1	
		Fan motor output	kW	0.120	
		Airflow (Low-Medium2-Medium1-High)	m³/min(CFM)	24-26-29-32(850-920-1,020-1,130)	
		External static pressure	Pa(mmAq)	0(direct blow)	
	Booster heater		kW	-	
	Operation control & Thermostat		Remote controller & built-in		
	Noise level (Low-Medium2-Medium1-High)		dB	36-39-42-44	
	Field drain pipe O.D.		mm(in.)	32(1-1/4)	
	Dimensions	W	mm(in.)	UNIT : 840 (33-1/16)	PANEL : 950 (37-3/8)
D		mm(in.)	UNIT : 840 (33-1/16)	PANEL : 950 (37-3/8)	
H		mm(in.)	UNIT : 298 (11-3/4)	PANEL : 35 (1-3/8)	
Weight		kg(lbs)	UNIT : 27 (60)	PANEL : 6 (13)	

PLA-ZRP35BA.UK

NOTCH	SPL(dB)	LINE
High	31	○—○
Medium1	29	●—●
Medium2	28	△—△
Low	27	▲—▲

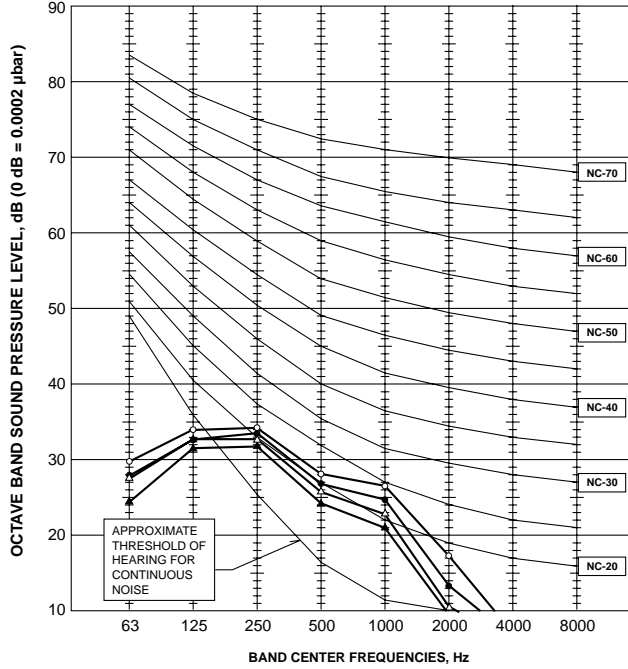

PLA-ZRP50BA.UK

NOTCH	SPL(dB)	LINE
High	32	○—○
Medium1	31	●—●
Medium2	29	△—△
Low	28	▲—▲

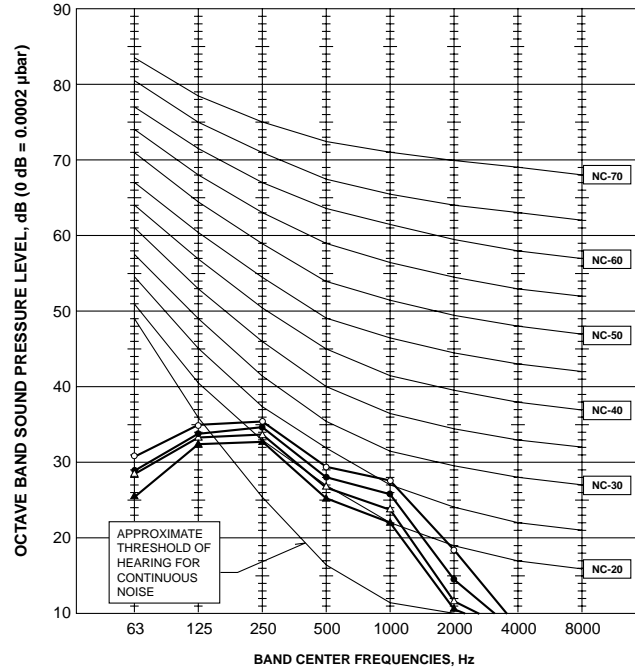

PLA-ZRP60BA.UK

NOTCH	SPL(dB)	LINE
High	32	○—○
Medium1	31	●—●
Medium2	29	△—△
Low	28	▲—▲

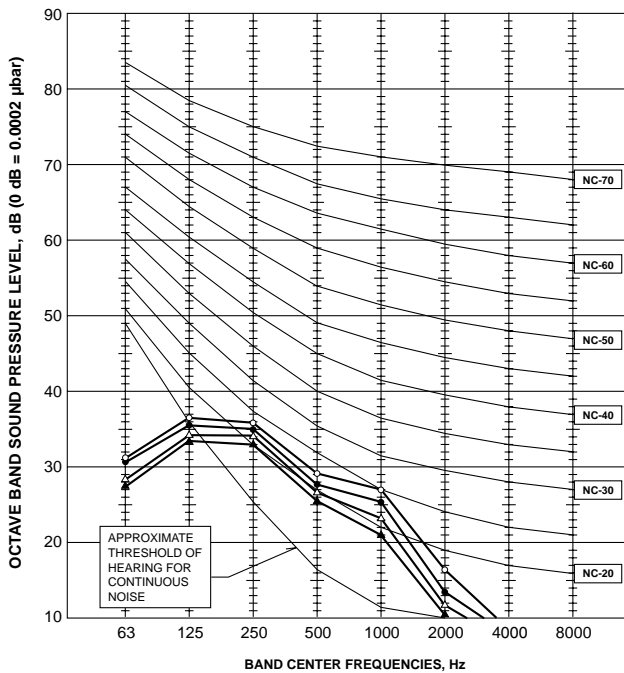

PLA-ZRP71BA.UK

NOTCH	SPL(dB)	LINE
High	36	○—○
Medium1	34	●—●
Medium2	30	△—△
Low	28	▲—▲

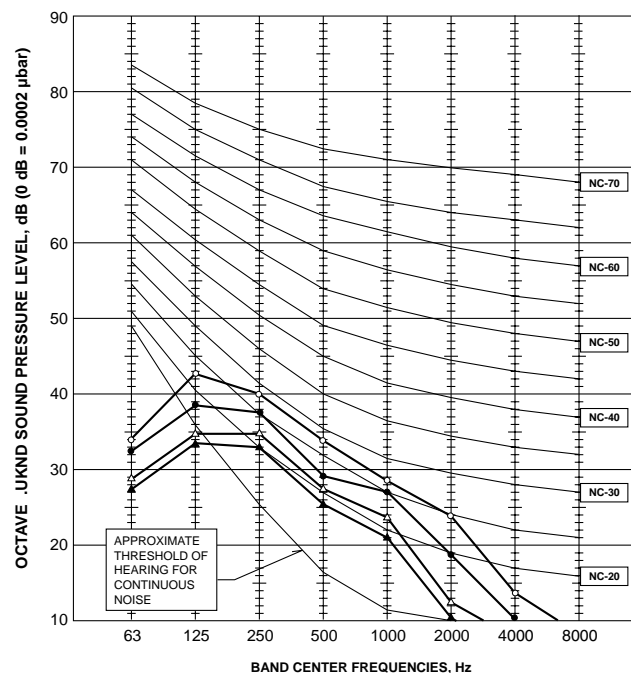

PLA-ZRP125BA.UK

NOTCH	SPL(dB)	LINE
High	41	○—○
Medium1	39	●—●
Medium2	36	△—△
Low	34	▲—▲

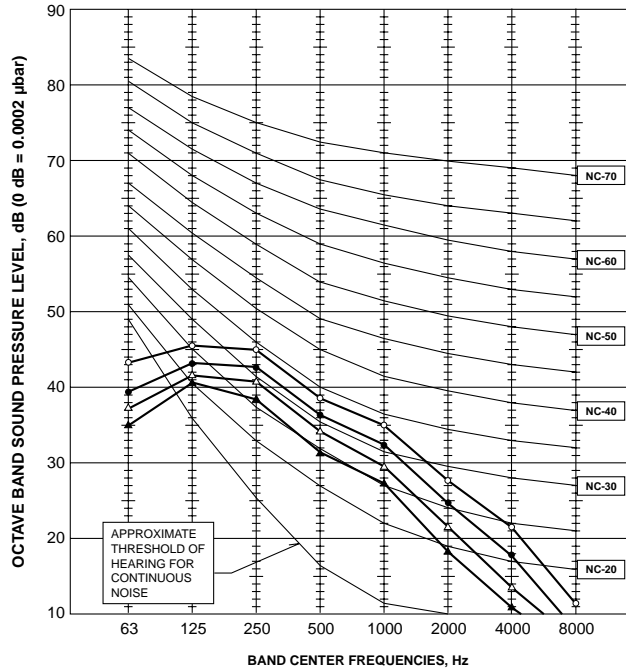

PLA-ZRP140BA.UK

NOTCH	SPL(dB)	LINE
High	44	○—○
Medium1	42	●—●
Medium2	39	△—△
Low	36	▲—▲

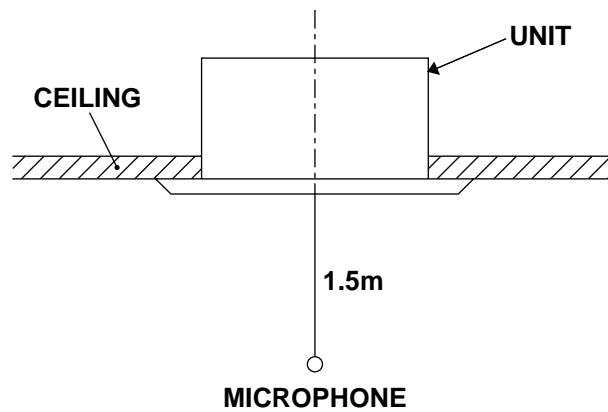
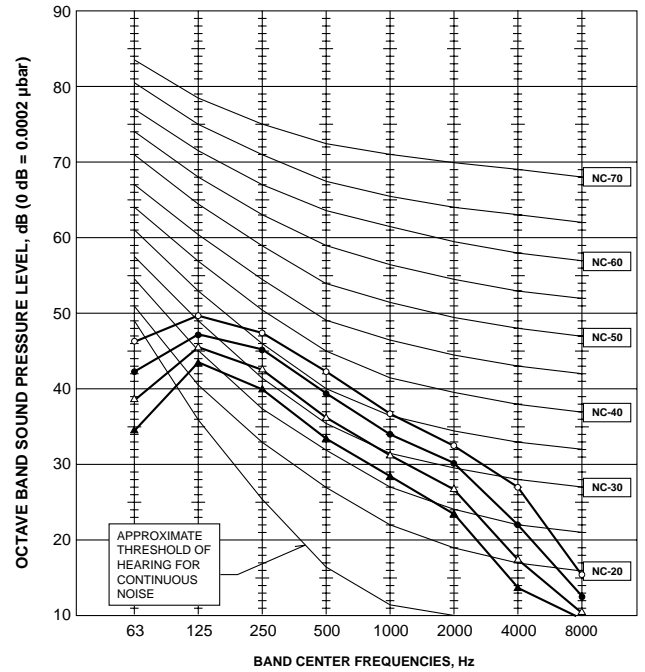

PLA-ZRP35BA.UK
PLA-ZRP71BA.UK

PLA-ZRP50BA.UK
PLA-ZRP125BA.UK

PLA-ZRP60BA.UK
PLA-ZRP140BA.UK

Unit: mm

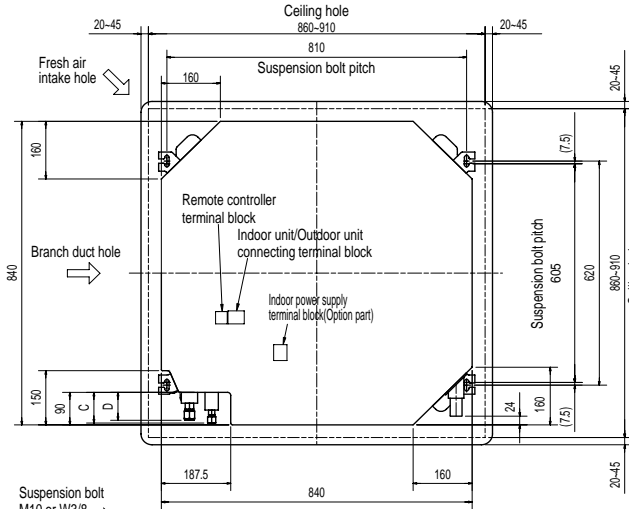

Detail connecting of branch duct(Both aspects)

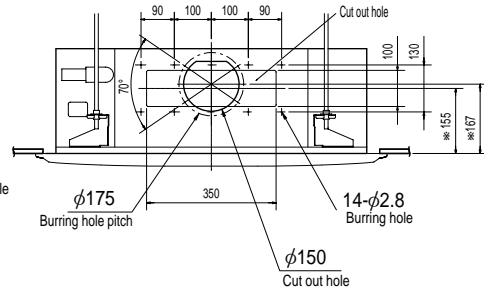

Detail drawing of fresh air intake hole

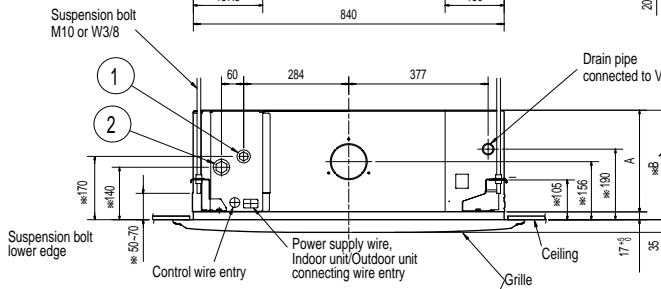
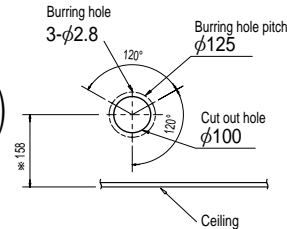

(Connected the attached flexible pipe or socket.)
Keep approximately 10 to 15mm space between unit ceiling and ceiling slab.

In case of standard grille : PLP-6BA / PLP-6BAMD



In case of auto-grille : PLP-6BAJ

In case of wireless remote controller : PLP-6BALM

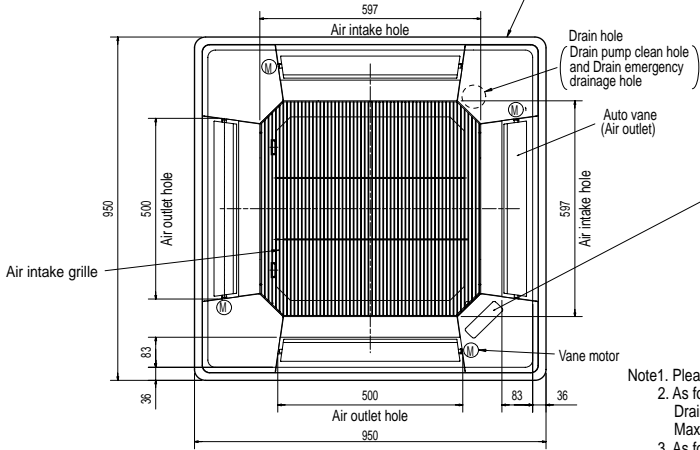
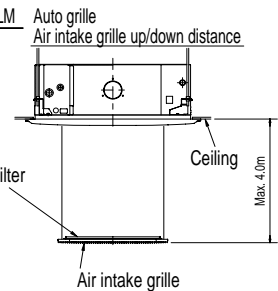
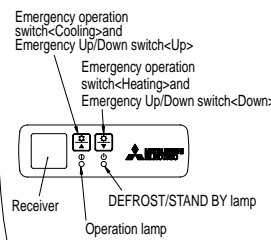

- Note1. Please choose the grille from a standard grille, auto-grille.
 2. As for drain pipe, please use VP-25(O.D. φ32 PVC TUBE). Drain pump is included. Max. lifting height is 850mm from the ceiling.
 3. As for suspension bolt, please use M10 or W3/8. (Procured at local site)
 4. Electrical box may be removed for the service purpose. Make sure to slack the electrical wire little bit for control/power wires connection.
 5. The height of the indoor unit is able to be adjusted with the grille attached.
 6. For the installation of the optional high efficiency filter or optional multi-functional casement.
 1) Requires E or more space between transom and ceiling for the installation.
 2) Add 135 mm to the dimensions * marked on the figure.
 3) The optional high efficiency filter must be used jointly with the optional multi-functional casement.
 7. When installing the branch ducts, be sure to insulate adequately. Otherwise condensation and dripping may occur. (It becomes the cause of dew drops/Water dew.)
 8. As for necessary installation/service space, please refer to the left figure.

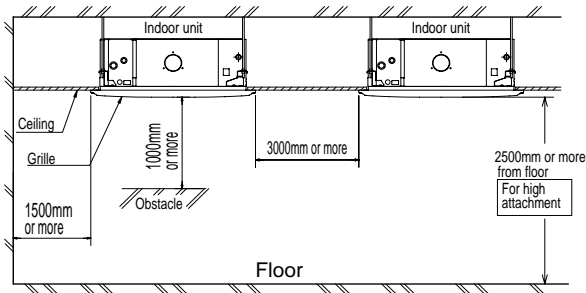

Models	①	②	A	B	C	D	E
PLA-ZRP35/50BA	Refrigerant pipe ---φ6.35 Flared connection ---1/4 inch	Refrigerant pipe ---φ12.7 Flared connection ---1/2 inch	241	258	80	74	400
PLA-ZRP60BA	Refrigerant pipe φ6.35 / φ9.52 Flared connection 1/4 inch/ 3/8 inch (compatible)	Refrigerant pipe ---φ15.88 Flared connection ---5/8 inch					
PLA-ZRP71/125/140BA	Refrigerant pipe ---φ9.52 Flared connection ---3/8 inch		281	298	85	77	440

PLA-ZRP35BA.UK
PLA-ZRP71BA.UK

PLA-ZRP50BA.UK
PLA-ZRP125BA.UK

PLA-ZRP60BA.UK
PLA-ZRP140BA.UK

[LEGEND]

SYMBOL	NAME	SYMBOL	NAME
I.B	INDOOR CONTROLLER BOARD	MF	FAN MOTOR
CN2L	CONNECTOR (LOSSNAV)	MV	VANE MOTOR
CN32	CONNECTOR (REMOTE SWITCH)	TB2	TERMINAL BLOCK (Indoor unit Power (option))
CN41	CONNECTOR (HA TERMINAL-A)	TB4	TERMINAL BLOCK (INDOOR/OUTDOOR CONNECTING LINE)
CN51	CONNECTOR (CENTRALLY CONTROL)	TB5, TB6	TERMINAL BLOCK (REMOTE CONTROLLER TRANSMISSION LINE)
FUSE	FUSE (T6.3A/250V)		
LED1	POWER SUPPLY (I.B)	TH1	ROOM TEMP. THERMISTOR (0°C / 15kΩ, 25°C / 5.4kΩ DETECT)
LED2	POWER SUPPLY (R.B)	TH2	PIPE TEMP. THERMISTOR/LIQUID (0°C / 15kΩ, 25°C / 5.4kΩ DETECT)
LED3	TRANSMISSION (INDOOR-OUTDOOR)	TH5	COND. / EVA. TEMP. THERMISTOR (0°C / 15kΩ, 25°C / 5.4kΩ DETECT)
SW1	SWITCH (MODEL SELECTION) * See table 1		
SW2	SWITCH (CAPACITY CODE) * See table 2		
SWE	CONNECTOR (EMERGENCY OPERATION)		
X1	RELAY (DRAIN PUMP)		
DCL	REACTOR		
DP	DRAIN PUMP		
FS	DRAIN FLOAT SWITCH		
		OPTION PART	
		W.B	PCB FOR WIRELESS REMOTE CONTROLLER
		BZ	BUZZER
		LED1	LED (OPERATION INDICATION : GREEN)
		LED2	LED (PREPARATION FOR HEATING : ORANGE)
		RU	RECEIVING UNIT
		SW1	EMERGENCY OPERATION (HEAT / DOWN)
		SW2	EMERGENCY OPERATION (COOL / UP)

<Table 2> SW2 (CAPACITY CODE)

SW2		SW2	
MODELS	Manufacture/Service	MODELS	Manufacture/Service
PLA-ZRP35BA	1 2 3 4 5 ON OFF	PLA-ZRP71BA	1 2 3 4 5 ON OFF
PLA-ZRP50BA	1 2 3 4 5 ON OFF	PLA-ZRP125BA	1 2 3 4 5 ON OFF
PLA-ZRP60BA	1 2 3 4 5 ON OFF	PLA-ZRP140BA	1 2 3 4 5 ON OFF

The black square (■) indicates a switch position.

<Table 1> SW1 (MODEL SELECTION)

SW1	
Manufacture/Service	1 2 3 4 5 ON OFF
	1 2 3 4 5 ON OFF

The black square (■) indicates a switch position.

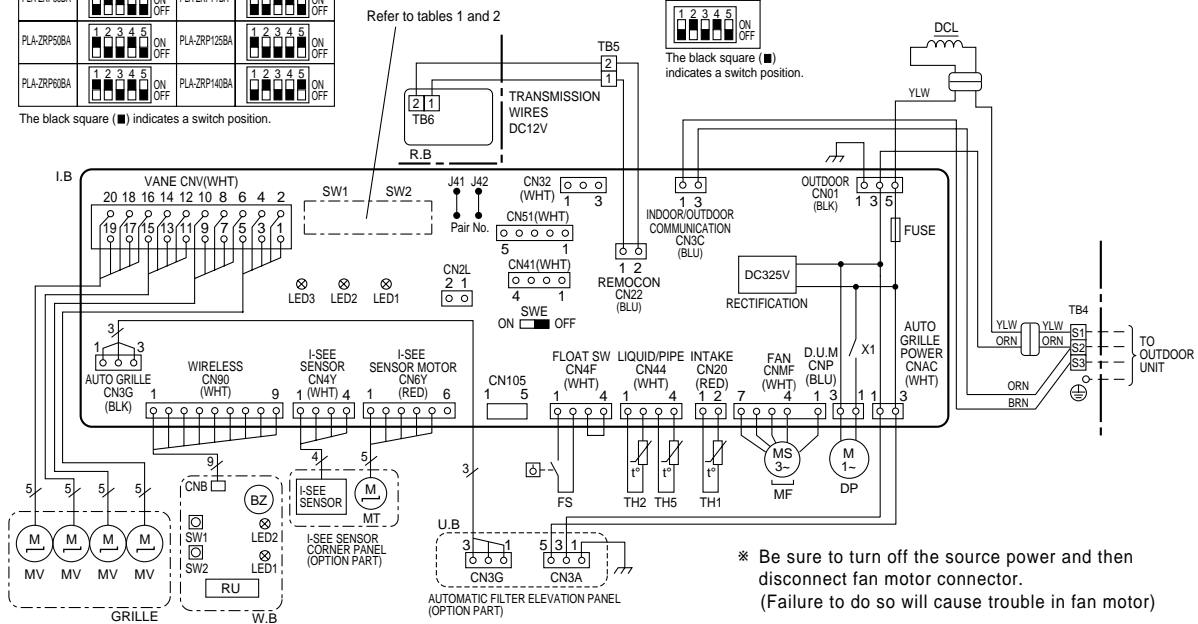

* Be sure to turn off the source power and then disconnect fan motor connector. (Failure to do so will cause trouble in fan motor)

- Notes: 1. Symbols used in wiring diagram above are, □○□○:Connector, □□□□ Terminal (block).
 2. Indoor and outdoor connecting wires are made with polarities, make wiring matching terminal numbers (S1, S2, S3).
 3. Since the outdoor side electric wiring may change be sure to check the outdoor unit electric wiring for servicing.
 4. This diagram shows the wiring of indoor and outdoor connecting wires (specification of 230V), adopting superimposed system of power and signal.
 *1: When work to Supply power separately to indoor and outdoor units was applied, refer to Fig 1.
 *2: For power supply system of this unit, refer to the caution label located near this diagram.

Please set the voltage using the remote controller. For the setting method, please refer to the indoor unit Installation Manual.

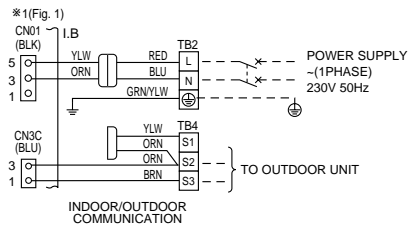

[Self-diagnosis]

- For details on how to operate self-diagnosis with the wireless remote control, refer to the technical manuals etc.
- For the wired remote control: When you quickly press twice the CHECK switch on the remote control, the unit begins self-diagnosis, and Check Codes generated in the past appear on the display. For Check Codes and Symptoms refer to the table below.

PLA-ZRP35BA.UK
PLA-ZRP71BA.UK

PLA-ZRP50BA.UK
PLA-ZRP125BA.UK

PLA-ZRP60BA.UK
PLA-ZRP140BA.UK

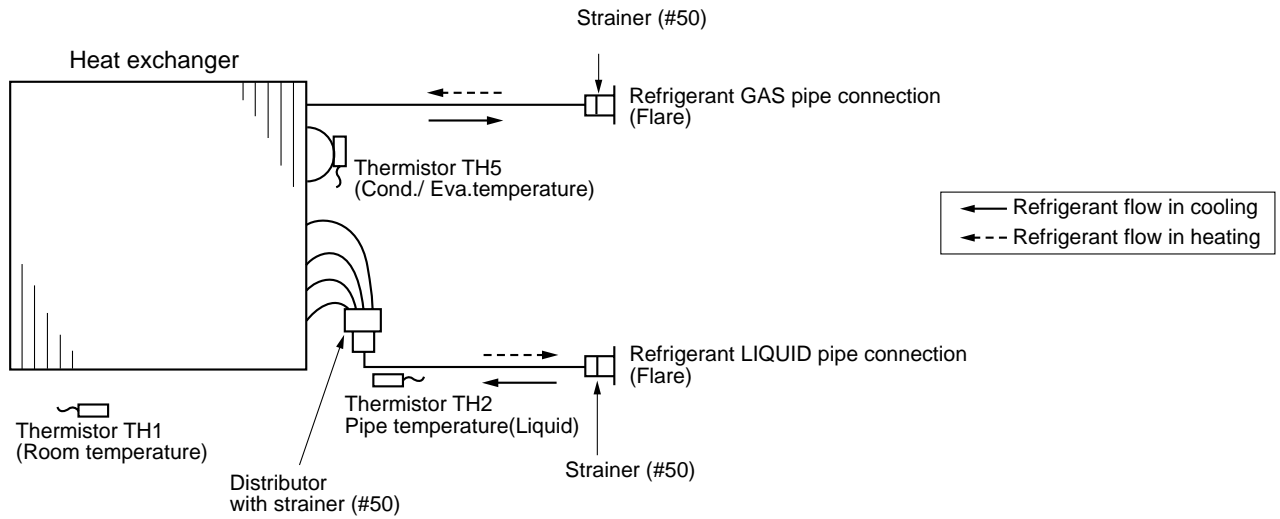

9-1. TROUBLESHOOTING

<Error code display by self-diagnosis and actions to be taken for service (summary)>

Present and past error codes are logged and displayed on the wired remote controller or controller board of outdoor unit. Actions to be taken for service and the trouble recurrence at field are summarized in the table below. Check the contents below before investigating details.

Unit conditions at service	Error code	Actions to be taken for service (summary)
The trouble is reoccurring.	Displayed	Judge what is wrong and take a corrective action according to "9-3. Self-diagnosis action table".
	Not displayed	Conduct troubleshooting and ascertain the cause of the trouble according to "9-4. Troubleshooting of problems".
The trouble is not reoccurring.	Logged	<ul style="list-style-type: none"> ① Consider the temporary defects such as the work of protection devices in the refrigerant circuit including compressor, poor connection of wiring, noise and etc. Re-check the symptom, and check the installation environment, refrigerant amount, weather when the trouble occurred, matters related to wiring and etc. ② Reset error code logs and restart the unit after finishing service. ③ There is no abnormality in electrical component, controller board, remote controller and etc.
	Not logged	<ul style="list-style-type: none"> ① Re-check the abnormal symptom. ② Conduct trouble shooting and ascertain the cause of the trouble according to "9-4. Troubleshooting of problems". ③ Continue to operate unit for the time being if the cause is not ascertained. ④ There is no abnormality concerning of parts such as electrical component, controller board, remote controller and etc.

9-2. MALFUNCTION-DIAGNOSIS METHOD BY REMOTE CONTROLLER

<In case of trouble during operation>

When a malfunction occurs to air conditioner, both indoor unit and outdoor unit will stop and operation lamp blinks to inform unusual stop.

<Malfunction-diagnosis method at maintenance service>

[Procedure]

1. Press the CHECK button twice.

- "CHECK" lights, and refrigerant address "00" flashes.
- Check that the remote controller's display has stopped before continuing.

2. Press the temperature \downarrow \uparrow buttons.

- Select the refrigerant address of the indoor unit for the self-diagnosis.
- Note: Set refrigerant address using the outdoor unit's DIP switch (SW1). (For more information, see the outdoor unit installation manual.)

3. Point the remote controller at the sensor on the indoor unit and press the HOUR button.

- If an air conditioner error occurs, the indoor unit's sensor emits an intermittent buzzer sound, the operation light flashes, and the error code is output. (It takes 3 seconds at most for error code to appear.)

4. Point the remote controller at the sensor on the indoor unit and press the ON/OFF button.

- The check mode is cancelled.

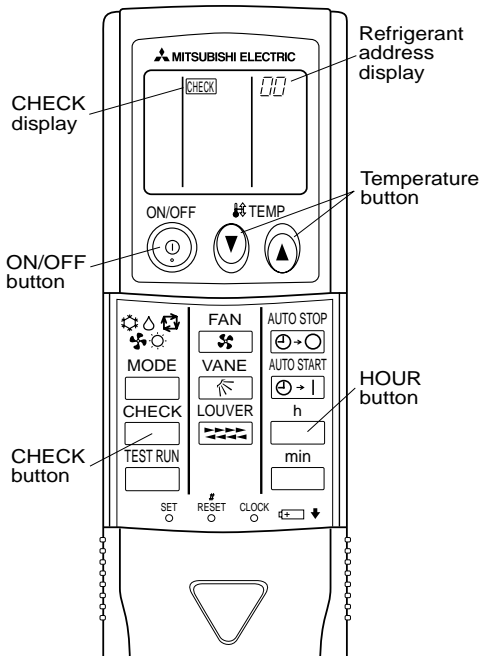

• Refer to the following tables for details on the check codes.

[Output pattern A]

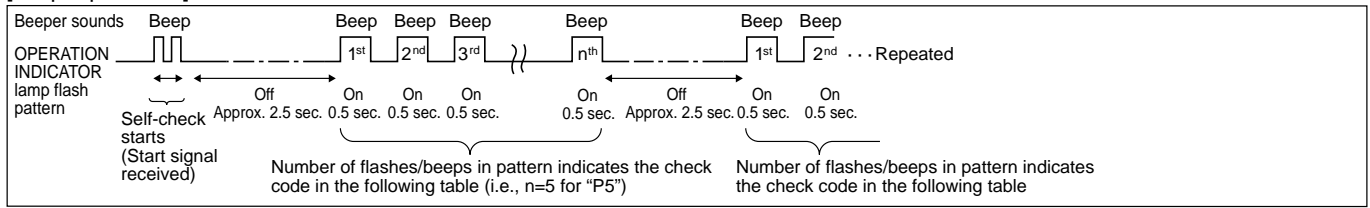

[Output pattern B]

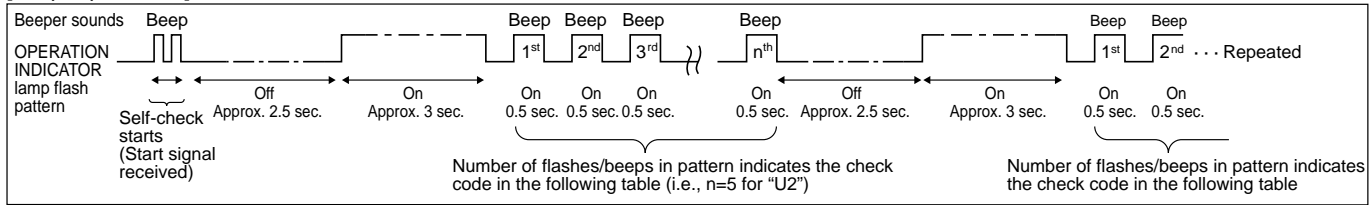

[Output pattern A] Errors detected by indoor unit

Wireless remote controller Beeper sounds/OPERATION INDICATOR lamp flashes (Number of times)	Wired remote controller Check code	Symptom	Remark
1	P1	Intake sensor error	—
2	P2	Pipe (TH2) sensor error	
	P9	Pipe (TH5) sensor error	
3	E6, E7	Indoor/outdoor unit communication error	
4	P4	Drain sensor error/Float switch connector (CN4F) open	
5	P5	Drain pump error	
	PA	Forced compressor stop(due to water leakage abnormality)	
6	P6	Freezing/Overheating protection operation	
7	EE	Communication error between indoor and outdoor units	
8	P8	Pipe temperature error	
9	E4, E5	Remote controller signal receiving error	
10	—	—	
11	—	—	
12	Fb	Indoor unit control system error (memory error, etc.)	
14	PL	Refrigerant circuit abnormal	
—	E0, E3	Remote controller transmission error	
—	E1, E2	Remote controller control board error	

[Output pattern B] Errors detected by unit other than indoor unit (outdoor unit, etc.)

Wireless remote controller Beeper sounds/OPERATION INDICATOR lamp flashes (Number of times)	Wired remote controller Check code	Symptom	Remark
1	E9	Indoor/outdoor unit communication error (Transmitting error) (Outdoor unit)	For details, check the LED display of the outdoor controller board. As for outdoor unit, refer to outdoor unit's service manual.
2	UP	Compressor overcurrent interruption	
3	U3, U4	Open/short of outdoor unit thermistors	
4	UF	Compressor overcurrent interruption (When compressor locked)	
5	U2	Abnormal high discharging temperature/49C operated/ insufficient refrigerant	
6	U1, Ud	Abnormal high pressure (63H operated)/Overheating protection operation	
7	U5	Abnormal temperature of heat sink	
8	U8	Outdoor unit fan protection stop	
9	U6	Compressor overcurrent interruption/Abnormal of power module	
10	U7	Abnormality of super heat due to low discharge temperature	
11	U9, UH	Abnormality such as overvoltage or voltage shortage and abnormal synchronous signal to main circuit/Current sensor error	
12	—	—	
13	—	—	
14	Others	Other errors (Refer to the technical manual for the outdoor unit.)	

*1 If the beeper does not sound again after the initial 2 beeps to confirm the self-check start signal was received and the OPERATION INDICATOR lamp does not come on, there are no error records.

*2 If the beeper sounds 3 times continuously "beep, beep, beep (0.4 + 0.4 + 0.4 sec.)" after the initial 2 beeps to confirm the self-check start signal was received, the specified refrigerant address is incorrect.

- On wireless remote controller
The continuous buzzer sounds from receiving section of indoor unit.
Blink of operation lamp
- On wired remote controller
Check code displayed in the LCD.

- On wireless remote controller
The continuous buzzer sounds from receiving section of indoor unit.
Blink of operation lamp
- On wired remote controller
Check code displayed in the LCD.

• If the unit cannot be operated properly after test run, refer to the following table to find the cause.

Symptom		Cause
Wired remote controller	LED 1, 2 (PCB in outdoor unit)	
PLEASE WAIT	For about 2 minutes after power-on	After LED 1, 2 are lighted, LED 2 is turned off, then only LED 1 is lighted. (Correct operation)
PLEASE WAIT → Error code	Subsequent to about 2 minutes after power-on	Only LED 1 is lighted. → LED 1, 2 blink.
Display messages do not appear even when operation switch is turned ON (operation lamp does not light up).		Only LED 1 is lighted. → LED 1 blinks twice, LED 2 blinks once.

On the wireless remote controller with condition above, following phenomena take place.

- No signals from the remote controller can be received.
- Operation lamp is blinking.
- The buzzer makes a short ping sound.

Note:

Operation is not possible for about 30 seconds after cancellation of function selection. (Correct operation)

For description of each LED (LED1, 2, 3) provided on the indoor controller, refer to the following table.

LED1 (power for microprocessor)	Indicates whether control power is supplied. Make sure that this LED is always lit.
LED2 (power for remote controller)	Indicates whether power is supplied to the remote controller. This LED lights only in the case of the indoor unit which is connected to the outdoor unit refrigerant addresses "0".
LED3 (communication between indoor and outdoor units)	Indicates state of communication between the indoor and outdoor units. Make sure that this LED is always blinking.

Note: Refer to the manual of outdoor unit for the details of display such as F, U, and other E.

9-3. SELF-DIAGNOSIS ACTION TABLE

Error Code	Abnormal point and detection method	Cause	Countermeasure										
P1	<p>Room temperature thermistor (TH1)</p> <p>① The unit is in 3-minute resume prevention mode if short/open of thermistor is detected. Abnormal if the unit does not reset normally after 3 minutes. (The unit returns to normal operation, if it has been reset normally.)</p> <p>② Constantly detected during cooling, drying, and heating operation. Short: -90°C or more Open: -40°C or less</p>	<p>① Defective thermistor characteristics</p> <p>② Contact failure of connector (CN20) on the indoor controller board (Insert failure)</p> <p>③ Breaking of wire or contact failure of thermistor wiring</p> <p>④ Defective indoor controller board</p>	<p>①-③ Check resistance value of thermistor.</p> <table border="1"> <tr> <td>0°C</td> <td>15.0kΩ</td> </tr> <tr> <td>10°C</td> <td>9.6kΩ</td> </tr> <tr> <td>20°C</td> <td>6.3kΩ</td> </tr> <tr> <td>30°C</td> <td>4.3kΩ</td> </tr> <tr> <td>40°C</td> <td>3.0kΩ</td> </tr> </table> <p>If you put force on (draw or bend) the lead wire while measuring resistance value of thermistor, breaking of wire or contact failure can be detected.</p> <p>② Check contact failure of connector (CN20) on the indoor controller board. Refer to 9-7. Turn the power on again and check restart after inserting connector again.</p> <p>④ Check room temperature display on remote controller. Replace indoor controller board if there is abnormal difference with actual room temperature.</p> <p>Turn the power off, and on again to operate after check.</p>	0°C	15.0kΩ	10°C	9.6kΩ	20°C	6.3kΩ	30°C	4.3kΩ	40°C	3.0kΩ
0°C	15.0kΩ												
10°C	9.6kΩ												
20°C	6.3kΩ												
30°C	4.3kΩ												
40°C	3.0kΩ												
P2	<p>Pipe temperature thermistor/Liquid (TH2)</p> <p>① The unit is in 3-minute resume prevention mode if short/open of thermistor is detected. Abnormal if the unit does not reset normally after 3 minutes. (The unit returns to normal operation, if it has been reset normally.)</p> <p>② Constantly detected during cooling, drying, and heating (except defrosting) operation Short: 90°C or more Open: -40°C or less</p>	<p>① Defective thermistor characteristics</p> <p>② Contact failure of connector (CN44) on the indoor controller board (Insert failure)</p> <p>③ Breaking of wire or contact failure of thermistor wiring</p> <p>④ Defective refrigerant circuit is causing thermistor temperature of 90°C or more or -40°C or less.</p> <p>⑤ Defective indoor controller board</p>	<p>①-③ Check resistance value of thermistor. For characteristics, refer to (P1) above.</p> <p>② Check contact failure of connector (CN44) on the indoor controller board. Refer to 9-7. Turn the power on and check restart after inserting connector again.</p> <p>④ Check pipe <liquid> temperature with remote controller in test run mode. If pipe <liquid> temperature is extremely low (in cooling mode) or high (in heating mode), refrigerant circuit may have defective.</p> <p>⑤ Check pipe <liquid> temperature with remote controller in test run mode. If there is extremely difference with actual pipe <liquid> temperature, replace indoor controller board.</p> <p>Turn the power off, and on again to operate after check.</p>										
P4	<p>Contact failure of drain float switch (CN4F)</p> <ul style="list-style-type: none"> Extract when the connector of drain float switch is disconnected. (③ and ④ of connector CN4F is not short-circuited.) Constantly detected during operation 	<p>① Contact failure of connector (Insert failure)</p> <p>② Defective indoor controller board</p>	<p>① Check contact failure of float switch connector. Turn the power on again and check after inserting connector again.</p> <p>② Operate with connector (CN4F) short-circuited. Replace indoor controller board if abnormality reappears.</p>										
P5	<p>Drain over flow protection operation</p> <p>① Suspensive abnormality, if drain float switch is detected to be underwater for 1 minute and 30 seconds continuously with drain pump on. Compressor and indoor fan will be turned off.</p> <p>② Drain pump is abnormal if the condition above is detected during suspensive abnormality.</p> <p>③ Constantly detected during drain pump operation</p>	<p>① Malfunction of drain pump</p> <p>② Defective drain Clogged drain pump Clogged drain pipe</p> <p>③ Defective drain float switch Jamming of the drain float switch or malfunction of moving parts causing the drain float switch to be detected under water (Switch On)</p> <p>④ Defective indoor-controller board</p>	<p>① Check if drain pump works.</p> <p>② Check drain function.</p> <p>③ Remove drain float switch connector CN4F and check if it is short (Switch On) with the moving part of float switch UP, or OPEN with the moving part of float switch down. Replace float switch if it is short with the moving part of float switch down.</p> <p>④ Replace indoor controller board if it is short-circuited between ③-④ of the drain float switch connector CN4F and abnormality reappears.</p> <p>It is not abnormal if there is no problem about the above-mentioned Turn the power off, and on again to operate after check.</p>										



Error Code	Abnormal point and detection method	Cause	Countermeasure
P6	<p>Freezing/overheating protection is operating</p> <p>① Freezing protection (Cooling mode) The unit is in 6-minute resume prevention mode if pipe <liquid or condenser/evaporator> temperature stays under -15°C for 3 minutes, 3 minutes after the compressor started. Abnormal if it stays under -15°C for 3 minutes again within 16 minutes after 6-minute resume prevention mode.</p> <p>② Overheating protection (Heating mode) The units is in 6 minute resume prevention mode if pipe <liquid or condenser/evaporator> temperature is detected as over 70°C after the compressor started. Abnormal if the temperature of over 70°C is detected again within 30 minutes after 6 minute resume prevention mode.</p>	<p>(Cooling or drying mode)</p> <p>① Clogged filter (reduced airflow) ② Short cycle of air path ③ Low-load (low temperature) operation out of the tolerance range ④ Defective indoor fan motor • Fan motor is defective. • Indoor controller board is defective.</p> <p>⑤ Defective outdoor fan control ⑥ Overcharge of refrigerant ⑦ Defective refrigerant circuit (clogs)</p> <p>(Heating mode)</p> <p>① Clogged filter (reduced airflow) ② Short cycle of air path ③ Over-load (high temperature) operation out of the tolerance range ④ Defective indoor fan motor • Fan motor is defective. • Indoor controller board is defective. ⑤ Defective outdoor fan control ⑥ Overcharge of refrigerant ⑦ Defective refrigerant circuit (clogs) ⑧ Bypass circuit of outdoor unit is defective.</p>	<p>(Cooling or drying mode)</p> <p>① Check clogs of the filter. ② Remove blockage.</p> <p>④ Refer to 9-6.</p> <p>⑤ Check outdoor fan motor. ⑥⑦ Check operating condition of refrigerant circuit.</p> <p>(Heating mode)</p> <p>① Check clogs of the filter. ② Remove blockage.</p> <p>④ Refer to 9-6.</p> <p>⑤ Check outdoor fan motor. ⑥~⑧ Check operating condition of refrigerant circuit.</p>
P8	<p>Pipe temperature <Cooling mode> Detected as abnormal when the pipe temperature is not in the cooling range 3 minutes after compressor start and 6 minutes after the liquid or condenser/evaporator pipe is out of cooling range. Note 1) It takes at least 9 minutes to detect. Note 2) Abnormality P8 is not detected in drying mode. Cooling range : -3 °C ≥ (TH-TH1) TH: Lower temperature between: liquid pipe temperature (TH2) and condenser/evaporator temperature (TH5) TH1: Intake temperature</p> <p><Heating mode> When 10 seconds have passed after the compressor starts operation and the hot adjustment mode has finished, the unit is detected as abnormal when condenser/evaporator pipe temperature is not in heating range within 20 minutes.</p> <p>Note 3) It takes at least 27 minutes to detect abnormality. Note 4) It excludes the period of defrosting. (Detection restarts when defrosting mode is over.) Heating range : 3 °C ≤ (TH5-TH1)</p>	<p>① Slight temperature difference between indoor room temperature and pipe <liquid or condenser/evaporator> temperature thermistor • Shortage of refrigerant • Disconnected holder of pipe <liquid or condenser/evaporator> thermistor • Defective refrigerant circuit</p> <p>② Converse connection of extension pipe (on plural units connection)</p> <p>③ Converse wiring of indoor/outdoor unit connecting wire (on plural units connection)</p> <p>④ Defective detection of indoor room temperature and pipe <condenser/evaporator> temperature thermistor</p> <p>⑤ Stop valve is not opened completely.</p>	<p>①~④ Check pipe <liquid or condenser/evaporator> temperature with room temperature display on remote controller and outdoor controller circuit board. Pipe <liquid or condenser/evaporator> temperature display is indicated by setting SW2 of outdoor controller circuit board as follows.</p> <p>(Conduct temperature check with outdoor controller circuit board after connecting 'A-Control Service Tool(PAC-SK52ST)').</p> <p>②③ Check converse connection of extension pipe or converse wiring of indoor/outdoor unit connecting wire.</p>



Error Code	Abnormal point and detection method	Cause	Countermeasure
P9	<p>Pipe temperature thermistor/ Condenser-Evaporator (TH5)</p> <p>① The unit is in 3-minute resume protection mode if short/open of thermistor is detected. Abnormal if the unit does not get back to normal within 3 minutes. (The unit returns to normal operation, if it has been reset normally.)</p> <p>② Constantly detected during cooling, drying, and heating operation (except defrosting) Short: 90°C or more Open: -40°C or less</p>	<p>① Defective thermistor characteristics</p> <p>② Contact failure of connector (CN44) on the indoor controller board (Insert failure)</p> <p>③ Breaking of wire or contact failure of thermistor wiring</p> <p>④ Temperature of thermistor is 90°C or more or -40°C or less caused by defective refrigerant circuit.</p> <p>⑤ Defective indoor controller board</p>	<p>①-③ Check resistance value of thermistor. For characteristics, refer to (P1) above.</p> <p>② Check contact failure of connector (CN44) on the indoor controller board. Refer to 9-7. Turn the power on and check restart after inserting connector again.</p> <p>④ Operate in test run mode and check pipe <condenser/evaporator> temperature with outdoor controller circuit board. If pipe <condenser/evaporator> temperature is extremely low (in cooling mode) or high (in heating mode), refrigerant circuit may have defect.</p> <p>⑤ Operate in test run mode and check pipe <condenser/evaporator> temperature with outdoor control circuit board. If there is extreme difference with actual pipe <condenser / evaporator> temperature, replace indoor controller board. There is no abnormality if none of above comes within the unit. Turn the power off and on again to operate.</p> <p>(In case of checking pipe temperature with outdoor controller circuit board, be sure to connect A-control service tool (PAC-SK52ST).)</p>
E0 or E4	<p>Remote controller transmission error(E0)/signal receiving error(E4)</p> <p>① Abnormal if main or sub remote controller cannot receive any transmission normally from indoor unit of refrigerant address "0" for 3 minutes. (Error code : E0)</p> <p>② Abnormal if sub remote controller could not receive any signal for 2 minutes. (Error code: E0)</p> <p>① Abnormal if indoor controller board can not receive any data normally from remote controller board or from other indoor controller board for 3 minutes. (Error code: E4)</p> <p>② Indoor controller board cannot receive any signal from remote controller for 2 minutes. (Error code: E4)</p>	<p>① Contact failure at transmission wire of remote controller</p> <p>② All remote controllers are set as "sub" remote controller. In this case, E0 is displayed on remote controller, and E4 is displayed at LED (LED1, LED2) on the outdoor controller circuit board.</p> <p>③ Miswiring of remote controller</p> <p>④ Defective transmitting receiving circuit of remote controller</p> <p>⑤ Defective transmitting receiving circuit of indoor controller board of refrigerant addresses "0".</p> <p>⑥ Noise has entered into the transmission wire of remote controller.</p>	<p>① Check disconnection or looseness of indoor unit or transmission wire of remote controller.</p> <p>② Set one of the remote controllers "main" if there is no problem with the action above.</p> <p>③ Check wiring of remote controller. • Total wiring length: max. 500m (Do not use cable x 3 or more.) • The number of connecting indoor units: max. 16 units • The number of connecting remote controller: max. 2 units</p> <p>When it is not the above-mentioned problem of ①-③</p> <p>④ Diagnose remote controllers. a) When "RC OK" is displayed, Remote controllers have no problem. Turn the power off, and on again to check. If abnormality generates again, replace indoor controller board. b) When "RC NG" is displayed, Replace remote controller. c) When "RC E3" or "ERC 00-66" is displayed, noise may be causing abnormality. * If the unit is not normal after replacing indoor controller board in group control, indoor controller board of address "0" may be abnormal.</p>
E3 or E5	<p>Remote controller transmission error(E3)/signal receiving error(E5)</p> <p>① Abnormal if remote controller could not find blank of transmission path for 6 seconds and could not transmit. (Error code: E3)</p> <p>② Remote controller receives transmitted data at the same time and compares the received and transmitted data. Abnormal if these data are judged to be different 30 continuous times. (Error code: E3)</p> <p>① Abnormal if indoor controller board could not find blank of transmission path. (Error code: E5)</p> <p>② Indoor controller board receives transmitted data at the same time and compares the received and transmitted data. Abnormal if these data are judged to be different 30 continuous times. (Error code: E5)</p>	<p>① 2 remote controllers are set as "main." (In case of 2 remote controllers)</p> <p>② Remote controller is connected with 2 indoor units or more.</p> <p>③ Repetition of refrigerant address</p> <p>④ Defective transmitting receiving circuit of remote controller</p> <p>⑤ Defective transmitting receiving circuit of indoor controller board</p> <p>⑥ Noise has entered into transmission wire of remote controller.</p>	<p>① Set a remote controller to main, and the other to sub.</p> <p>② Remote controller is connected with only one indoor unit.</p> <p>③ The address changes to a separate setting.</p> <p>④-⑥ Diagnose remote controller. a) When "RC OK" is displayed, remote controllers have no problem. Turn the power off, and on again to check. When becoming abnormal again, replace indoor controller board. b) When "RC NG" is displayed, replace remote controller. c) When "RC E3" or "ERC 00-66" is displayed, noise may be causing abnormality.</p>



Error Code	Abnormal point and detection method	Cause	Countermeasure
E6	<p>Indoor/outdoor unit communication error (Signal receiving error)</p> <p>① Abnormal if indoor controller board cannot receive any signal normally for 6 minutes after turning the power on.</p> <p>② Abnormal if indoor controller board cannot receive any signal normally for 3 minutes.</p> <p>③ Consider the unit abnormal under the following condition: When 2 or more indoor units are connected to an outdoor unit, indoor controller board cannot receive a signal for 3 minutes from outdoor controller circuit board, a signal which allows outdoor controller circuit board to transmit signals.</p>	<p>① Contact failure, short circuit or, miswiring (converse wiring) of indoor/outdoor unit connecting wire</p> <p>② Defective transmitting receiving circuit of indoor controller board</p> <p>③ Defective transmitting receiving circuit of indoor controller board</p> <p>④ Noise has entered into indoor/outdoor unit connecting wire.</p>	<p>* Check LED display on the outdoor control circuit board. (Connect A-control service tool, PAC-SK52ST.) Refer to outdoor unit service manual.</p> <p>① Check disconnection or looseness of indoor/outdoor unit connecting wire of indoor unit or outdoor unit. Check all the units in case of twin triple indoor unit system.</p> <p>②-④ Turn the power off, and on again to check. If abnormality generates again, replace indoor controller board or outdoor controller circuit board.</p> <p>* Other indoor controller board may have defect in case of twin triple indoor unit system.</p>
E7	<p>Indoor/outdoor unit communication error (Transmitting error)</p> <p>Abnormal if "1" receiving is detected 30 times continuously though indoor controller board has transmitted "0".</p>	<p>① Defective transmitting receiving circuit of indoor controller board</p> <p>② Noise has entered into power supply.</p> <p>③ Noise has entered into outdoor control wire.</p>	<p>①-③ Turn the power off, and on again to check. If abnormality generates again, replace indoor controller board.</p>
Fb	<p>Indoor controller board</p> <p>Abnormal if data cannot be read normally from the nonvolatile memory of the indoor controller board.</p>	<p>① Defective indoor controller board</p>	<p>① Replace indoor controller board.</p>
E1 or E2	<p>Remote controller control board</p> <p>① Abnormal if data cannot be read normally from the nonvolatile memory of the remote controller control board. (Error code: E1)</p> <p>② Abnormal if the clock function of remote controller cannot be operated normally. (Error code: E2)</p>	<p>① Defective remote controller</p>	<p>① Replace remote controller.</p>
PA	<p>Forced compressor stop (due to water leakage abnormality)</p> <p>① The unit has a water leakage abnormality when the following conditions, a) and b), are satisfied while the above-mentioned detection is performed.</p> <p>a) The intake temperature subtracted with liquid pipe temperature detects to be less than -10°C for a total of 30 minutes. (When the drain sensor is detected to be NOT soaked in the water, the detection record of a) and b) will be cleared.)</p> <p>b) Drain float switch detects to be in the water for more than 15 minutes.</p> <p>*Once the water leakage abnormality is detected, abnormality state will not be released until the main power is reset.</p>	<p>① Drain pump trouble</p> <p>② Drain defective · Drain pump clogging · Drain pipe clogging</p> <p>③ Open circuit of float switch</p> <p>④ Contact failure of float switch connector</p> <p>⑤ Dew condensation on float switch · Drain water descends along lead wire. · Drain water waving due to filter clogging.</p> <p>⑥ Extension piping connection difference at twin, triple, quadruple system.</p> <p>⑦ Miswiring of indoor/ outdoor connecting at twin, triple, quadruple system.</p> <p>⑧ Room temperature thermistor/ liquid pipe temperature thermistor detection is defective.</p>	<p>① Check the drain pump.</p> <p>② Check whether water can be drained.</p> <p>③ Check the resistance of the float switch.</p> <p>④ Check the connector contact failure.</p> <p>⑤ Check the float switch leadwire mounted. Check the filter clogging.</p> <p>⑥ Check the piping connection.</p> <p>⑦ Check the indoor/outdoor connecting wires.</p> <p>⑧ Check the room temperature display of remote controller. Check the indoor liquid pipe temperature display of outdoor controller board.</p>



Error Code	Abnormal point and detection method	Cause	Countermeasure
PL	<p>Abnormal refrigerant circuit During Cooling, Dry, or Auto Cooling operation, when the following are regarded as failures when detected for one second.</p> <p>a)The compressor continues to run for 30 or more seconds.</p> <p>b)The liquid pipe temperature or the condense/evaporator temperature is 75°C or more.</p> <p>* These detected errors will not be cancelled until the power source is reset.</p>	<p>① Abnormal operation of 4-way valve</p> <p>② Disconnection of or leakage in refrigerant pipes</p> <p>③ Air into refrigerant piping</p> <p>④ Abnormal operation (no rotation) of indoor fan</p> <ul style="list-style-type: none">· Defective fan motor.· Defective indoor control board. <p>⑤ Defective refrigerant circuit (clogging)</p>	<p>① <u>When this error occurs, be sure to replace the 4-way valve.</u></p> <p>② Check refrigerant pipes for disconnection or leakage.</p> <p>③ After the recovery of refrigerant, vacuum dry the whole refrigerant circuit.</p> <p>④ Refer to section 9-6-2.</p> <p>⑤ Check refrigerant circuit for operation.</p> <p>* <u>To avoid entry of moisture or air into refrigerant circuit which could cause abnormal high pressure, purge air in refrigerant circuit or replace refrigerant.</u></p>

9-4. TROUBLESHOOTING OF PROBLEMS

Note: Refer to the manual of outdoor unit for the detail of remote controller.

Phenomena	Cause	Countermeasure
<p>(1) LED2 on indoor controller board is off.</p>	<ul style="list-style-type: none"> • When LED1 on indoor controller board is also off. ① Power supply of rated voltage is not supplied to outdoor unit. ② Defective outdoor controller circuit board ③ Power supply of 220~240V is not supplied to indoor unit. ④ Defective indoor controller board <p>(For the separate indoor/outdoor unit power supply system)</p> <ul style="list-style-type: none"> ① Power supply of 220~240V AC is not supplied to indoor unit. ② The connectors of the optional replacement kit are not used. ③ Defective indoor controller board 	<ul style="list-style-type: none"> ① Check the voltage of outdoor power supply terminal block (L, N) or (L₃, N). <ul style="list-style-type: none"> • When AC 220~240V is not detected, check the power wiring to outdoor unit and the breaker. • When AC 220~240V is detected, check ② (below). ② Check the voltage between outdoor terminal block S1 and S2. <ul style="list-style-type: none"> • When AC 220~240V is not detected, —check the fuse on outdoor controller circuit board. —check the wiring connection. • When AC 220~240V is detected, check ③ (below). ③ Check the voltage between indoor terminal block S1 and S2. <ul style="list-style-type: none"> • When AC 220~240V is not detected, check indoor/outdoor unit connecting wire for miswiring. • When AC 220~240V is detected, check ④ (below). ④ Check the fuse on indoor controller board. Check the wiring connection. If no problem are found, indoor controller board is defective. <ul style="list-style-type: none"> ① Check the voltage of indoor power supply terminal block (L,N). <ul style="list-style-type: none"> • When AC220~240V is not detected, check the power supply wiring. • When AC220~240V is detected, check ② (below). ② Check that there is no problem in the method of connecting the connectors. <ul style="list-style-type: none"> • When there are problems in the method of connecting the connectors, connect the connector correctly referring to installation manual of an optional kit. • When there is no problem in the method of connecting the connectors, check ③ (below). ③ Check the fuse on indoor controller board. Check the wiring connection. If no problem are found, indoor controller board is defective.
	<ul style="list-style-type: none"> • When LED1 on indoor controller board is lit. ① Mis-setting of refrigerant address for outdoor unit (There is no unit corresponding to refrigerant address "0".) 	<ul style="list-style-type: none"> ① Check again the setting of refrigerant address for outdoor unit. Set the refrigerant address to "0". (For grouping control system under which 2 or more outdoor units are connected, set one of the units to "0".) Set refrigerant address using SW1 (3-6) on outdoor controller circuit board.

Note: Refer to the manual of outdoor unit for the detail of remote controller.

Phenomena	Cause	Countermeasure
(2) LED2 on indoor controller board is blinking.	<ul style="list-style-type: none"> • When LED1 on indoor controller board is also blinking. Connection failure of indoor/outdoor unit connecting wire 	Check indoor/outdoor unit connecting wire for connection failure.
	<ul style="list-style-type: none"> • When LED1 is lit. ① Miswiring of remote controller wires Under twin triple indoor unit system, 2 or more indoor units are wired together. ② Refrigerant address for outdoor unit is wrong or not set. Under grouping control system, there are some units whose refrigerant address is 0. ③ Short-cut of remote controller wires ④ Defective remote controller 	<ul style="list-style-type: none"> ① Check the connection of remote controller wires in case of twin triple indoor unit system. When 2 or more indoor units are wired in one refrigerant system, connect remote controller wires to one of those units. ② Check the setting of refrigerant address in case of grouping control system. If there are some units whose refrigerant addresses are 0 in one group, set one of the units to 0 using SW1 (3-6) on outdoor controller circuit board. ③④ Remove remote controller wires and check LED2 on indoor controller board. <ul style="list-style-type: none"> • When LED2 is blinking, check the short-cut of remote controller wires. • When LED2 is lit, connect remote controller wires again and: if LED2 is blinking, remote controller is defective; if LED2 is lit, connection failure of remote controller terminal block etc. has returned to normal.
(3) Upward/downward vane performance failure	<ul style="list-style-type: none"> ① The vane is not downward during defrosting and heat preparation and when the thermostat is OFF in HEAT mode. (Working of COOL protection function) ② Vane motor does not rotate. <ul style="list-style-type: none"> • Defective vane motor • Breaking of wire or connection failure of connector ③ Upward/downward vane does not work. <ul style="list-style-type: none"> • The vane is set to fixed position. 	<ul style="list-style-type: none"> ① Normal operation (The vane is set to horizontal regardless of remote control.) ② Check ② (left). <ul style="list-style-type: none"> • Check the vane motor. (Refer to “How to check the parts”.) • Check for breaking of wire or connection failure of connector. ③ Normal operation (Each connector on vane motor side is disconnected or setting the fixed vanes by wired remote controller.)
(4) Receiver for wireless remote controller	<ul style="list-style-type: none"> ① Weak batteries of wireless remote controller. ② Contact failure of connector (CNB) on wireless remote controller board (Insert failure) ③ Contact failure of connector (CN90) on indoor controller board (Insert failure) ④ Contact failure of connector between wireless remote controller board and indoor controller board 	<ul style="list-style-type: none"> ① Replace batteries of wireless remote controller. ②~④ Check contact failure of each connector. If no problems are found of connector, replace indoor controller board. When the same trouble occurs even if indoor controller board is replaced, replace wireless remote controller board.

9-5. EMERGENCY OPERATION

9-5-1. When wireless remote controller fails or its battery is exhausted

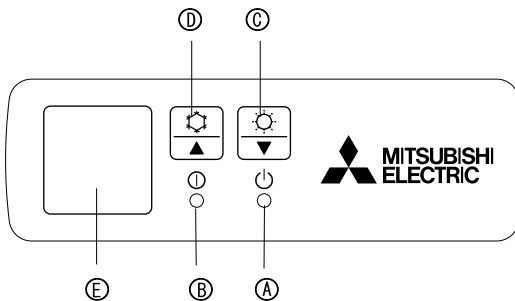

When the remote controller cannot be used

When the batteries of the remote controller run out or the remote controller malfunctions, the emergency operation can be done using the emergency buttons on the grille.

- Ⓐ DEFROST/STAND BY lamp
- Ⓑ Operation lamp
- Ⓒ Emergency operation switch (heating)
- Ⓓ Emergency operation switch (cooling)
- Ⓔ Receiver

Starting operation

- To operate the cooling mode, press the Ⓓ button for more than 2 seconds.
- To operate the heating mode, press the Ⓒ button for more than 2 seconds.

* Lighting of the Operation lamp Ⓑ means the start of operation.

Details of EMERGENCY MODE are as shown below.

Operation mode	COOL	HEAT
Set temperature	24°C	24°C
Fan speed	High	High
Air flow direction	Horizontal	Downward 5

Stopping operation

- To stop operation, press the Ⓓ button or the Ⓒ button.

9-5-2. When wired remote controller or indoor unit microprocessor fails

1. When the wired remote control or the indoor unit microprocessor has failed, but all other components work properly, if you set the switch (SWE) on the indoor controller board ON, the indoor unit will begin Emergency Operation.

When Emergency Operation is activated, the indoor unit operates as follows:

- (1) Indoor fan is running at high speed. (2) Drain pump is operating.

* Note on the wireless remote control

When the remote control does not function, it is possible to activate.

Emergency Operation by using the indoor unit Emergency operation switch (SW1, SW2 of the wireless signal receiver board).

However, if the indoor unit microprocessor has failed, it is necessary to proceed with points 2 and 3 below as in the case of the wired remote control.

2. When you activate Emergency operation of the cooling or heating, you have to set the switch (SWE) on the indoor controller board and activate Emergency operation of the outdoor unit.

For details on how to activate Emergency operation of the outdoor unit, refer to the outdoor unit wiring diagram.

Note: Emergency operation will not work unless outdoor unit is PU series.

3. Before you activate Emergency operation, check the following points:

- (1) Emergency operation cannot be activated when:

- the outdoor unit malfunctions. • the indoor fan malfunctions.
- the malfunction of drain pump is detected during self-diagnosing.

- (2) Emergency operation becomes continuous only by switching the power source on/off.

ON/OFF on the remote control or temperature control etc. does not function.

- (3) Avoid operating for a long time when the outdoor unit begins defrosting while Emergency operation of the heating is activated, because it will start to blow cold air.

- (4) Emergency cooling should be limited to 10 hours maximum (The indoor unit heat exchanger may freeze).

- (5) After Emergency operation has been deactivated, set the switches etc. to their original positions.

- (6) Movement of the vanes does not work in Emergency operation, therefore you have to slowly set them manually to the appropriate position.

9-6. HOW TO CHECK THE PARTS

PLA-ZRP35BA.UK
PLA-ZRP71BA.UK

PLA-ZRP50BA.UK
PLA-ZRP125BA.UK

PLA-ZRP60BA.UK
PLA-ZRP140BA.UK

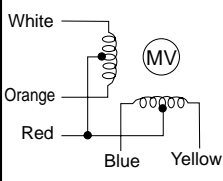
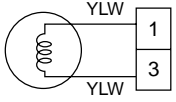
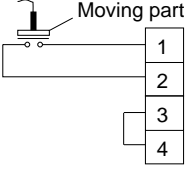
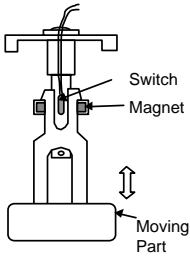
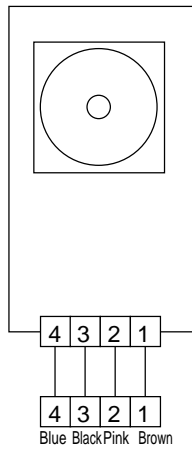
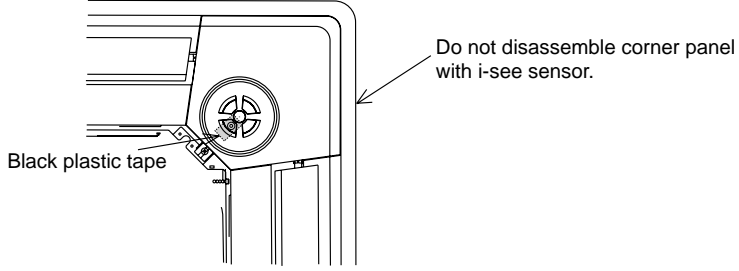
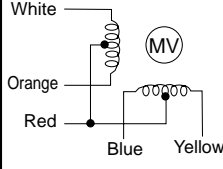
Parts name	Check points											
Room temperature thermistor (TH1) Pipe temperature thermistor/liquid(TH2) Condenser/Evaporator temperature thermistor (TH5)	Disconnect the connector then measure the resistance with a tester. (At the ambient temperature of 10°C~30°C) <table border="1" style="margin-left: 20px;"> <thead> <tr> <th>Normal</th> <th>Abnormal</th> </tr> </thead> <tbody> <tr> <td>4.3kΩ~9.6kΩ</td> <td>Open or short</td> </tr> </tbody> </table> (Refer to the thermistor.)			Normal	Abnormal	4.3kΩ~9.6kΩ	Open or short					
Normal	Abnormal											
4.3kΩ~9.6kΩ	Open or short											
Vane motor (MV) 	Measure the resistance between the terminals with a tester. (At the ambient temperature of 20°C~30°C) <table border="1" style="margin-left: 20px;"> <thead> <tr> <th>Connector</th> <th>Normal</th> <th>Abnormal</th> </tr> </thead> <tbody> <tr> <td>Red - Yellow (⑤-③, ⑩-⑧, ⑮-⑬, ⑳-⑱)</td> <td rowspan="4" style="text-align: center; vertical-align: middle;">300Ω</td> <td rowspan="4" style="text-align: center; vertical-align: middle;">Open or short</td> </tr> <tr> <td>Red - Blue (⑤-①, ⑩-⑥, ⑮-⑪, ⑳-⑯)</td> </tr> <tr> <td>Red - Orange (⑤-④, ⑩-⑨, ⑮-⑭, ⑳-⑲)</td> </tr> <tr> <td>Red - White (⑤-②, ⑩-⑦, ⑮-⑫, ⑳-⑰)</td> </tr> </tbody> </table>			Connector	Normal	Abnormal	Red - Yellow (⑤-③, ⑩-⑧, ⑮-⑬, ⑳-⑱)	300Ω	Open or short	Red - Blue (⑤-①, ⑩-⑥, ⑮-⑪, ⑳-⑯)	Red - Orange (⑤-④, ⑩-⑨, ⑮-⑭, ⑳-⑲)	Red - White (⑤-②, ⑩-⑦, ⑮-⑫, ⑳-⑰)
Connector	Normal	Abnormal										
Red - Yellow (⑤-③, ⑩-⑧, ⑮-⑬, ⑳-⑱)	300Ω	Open or short										
Red - Blue (⑤-①, ⑩-⑥, ⑮-⑪, ⑳-⑯)												
Red - Orange (⑤-④, ⑩-⑨, ⑮-⑭, ⑳-⑲)												
Red - White (⑤-②, ⑩-⑦, ⑮-⑫, ⑳-⑰)												
Drain pump (DP) 	Measure the resistance between the terminals with a tester. (Winding temperature 20°C) <table border="1" style="margin-left: 20px;"> <thead> <tr> <th>Normal</th> <th>Abnormal</th> </tr> </thead> <tbody> <tr> <td>290 Ω</td> <td>Open or short</td> </tr> </tbody> </table>			Normal	Abnormal	290 Ω	Open or short					
Normal	Abnormal											
290 Ω	Open or short											
Drain float switch (FS) 	Measure the resistance between the terminals with a tester. <table border="1" style="margin-left: 20px;"> <thead> <tr> <th>State of moving part</th> <th>Normal</th> <th>Abnormal</th> </tr> </thead> <tbody> <tr> <td>UP</td> <td>Short</td> <td>Other than short</td> </tr> <tr> <td>DOWN</td> <td>Open</td> <td>Other than open</td> </tr> </tbody> </table>		State of moving part	Normal	Abnormal	UP	Short	Other than short	DOWN	Open	Other than open	
State of moving part	Normal	Abnormal										
UP	Short	Other than short										
DOWN	Open	Other than open										
i-see sensor (Option) 	Turn on the indoor unit with the black plastic tape on the outside of i-see sensor controller board. With electricity being turned on, measure the power voltage between connectors with tester. i-see sensor rotates and pull out the connector of motor for i-see sensor.  i-see sensor (At the ambient temperature of 10°C~40°C) <table border="1" style="margin-left: 20px;"> <thead> <tr> <th>i-see sensor connector</th> <th>Normal</th> <th>Abnormal</th> </tr> </thead> <tbody> <tr> <td>②(-)—④(+)</td> <td>DC 1.857V ~ 3.132V</td> <td>Other than the normal</td> </tr> <tr> <td>①(+)—②(-)</td> <td>DC 0.939V ~ 1.506V</td> <td>Other than the normal</td> </tr> </tbody> </table> NOTE : Be careful not to discharge static electricity into electronics.			i-see sensor connector	Normal	Abnormal	②(-)—④(+)	DC 1.857V ~ 3.132V	Other than the normal	①(+)—②(-)	DC 0.939V ~ 1.506V	Other than the normal
i-see sensor connector	Normal	Abnormal										
②(-)—④(+)	DC 1.857V ~ 3.132V	Other than the normal										
①(+)—②(-)	DC 0.939V ~ 1.506V	Other than the normal										
Vane motor for i-see sensor (Option) 	Measure the resistance between the terminals with a tester. (At the ambient temperature of 20°C~30°C) <table border="1" style="margin-left: 20px;"> <thead> <tr> <th>Connector</th> <th>Normal</th> <th>Abnormal</th> </tr> </thead> <tbody> <tr> <td>Red - Yellow</td> <td rowspan="4" style="text-align: center; vertical-align: middle;">250 Ω</td> <td rowspan="4" style="text-align: center; vertical-align: middle;">Open or short</td> </tr> <tr> <td>Red - Blue</td> </tr> <tr> <td>Red - Orange</td> </tr> <tr> <td>Red - White</td> </tr> </tbody> </table>			Connector	Normal	Abnormal	Red - Yellow	250 Ω	Open or short	Red - Blue	Red - Orange	Red - White
Connector	Normal	Abnormal										
Red - Yellow	250 Ω	Open or short										
Red - Blue												
Red - Orange												
Red - White												

9-6-1. Thermistor

<Thermistor Characteristic graph>

Thermistor for lower temperature

Room temperature thermistor (TH1)
 Pipe temperature thermistor/liquid (TH2)
 Condenser/evaporator temperature thermistor (TH5)

Thermistor $R_0=15k\Omega \pm 3\%$

Fixed number of $B=3480 \pm 2\%$

$$R_t = 15 \exp \left\{ 3480 \left(\frac{1}{273+t} - \frac{1}{273} \right) \right\}$$

0°C	15kΩ
10°C	9.6kΩ
20°C	6.3kΩ
25°C	5.4kΩ
30°C	4.3kΩ
40°C	3.0kΩ

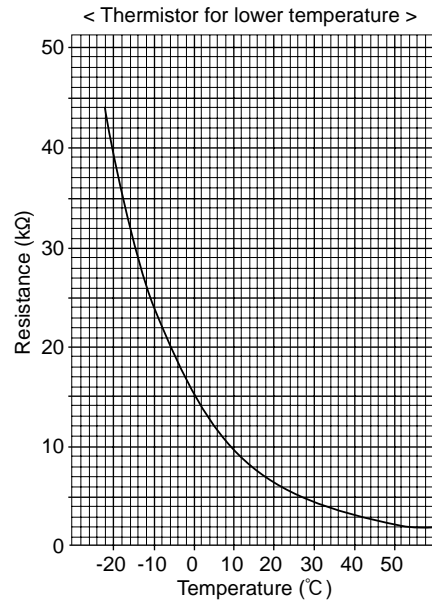

9-6-2. DC Fan motor (FAN MOTOR/INDOOR CONTROLLER BOARD)

Check method of DC fan motor (fan motor / indoor controller circuit board)

① Notes

- High voltage is applied to the connector (CNMF) for the fan motor. Pay attention to the service.
- Do not pull out the connector (CNMF) for the motor with the power supply on.
 (It causes trouble of the indoor controller circuit board and fan motor.)

② Self check

Symptom : The indoor fan cannot turn around.

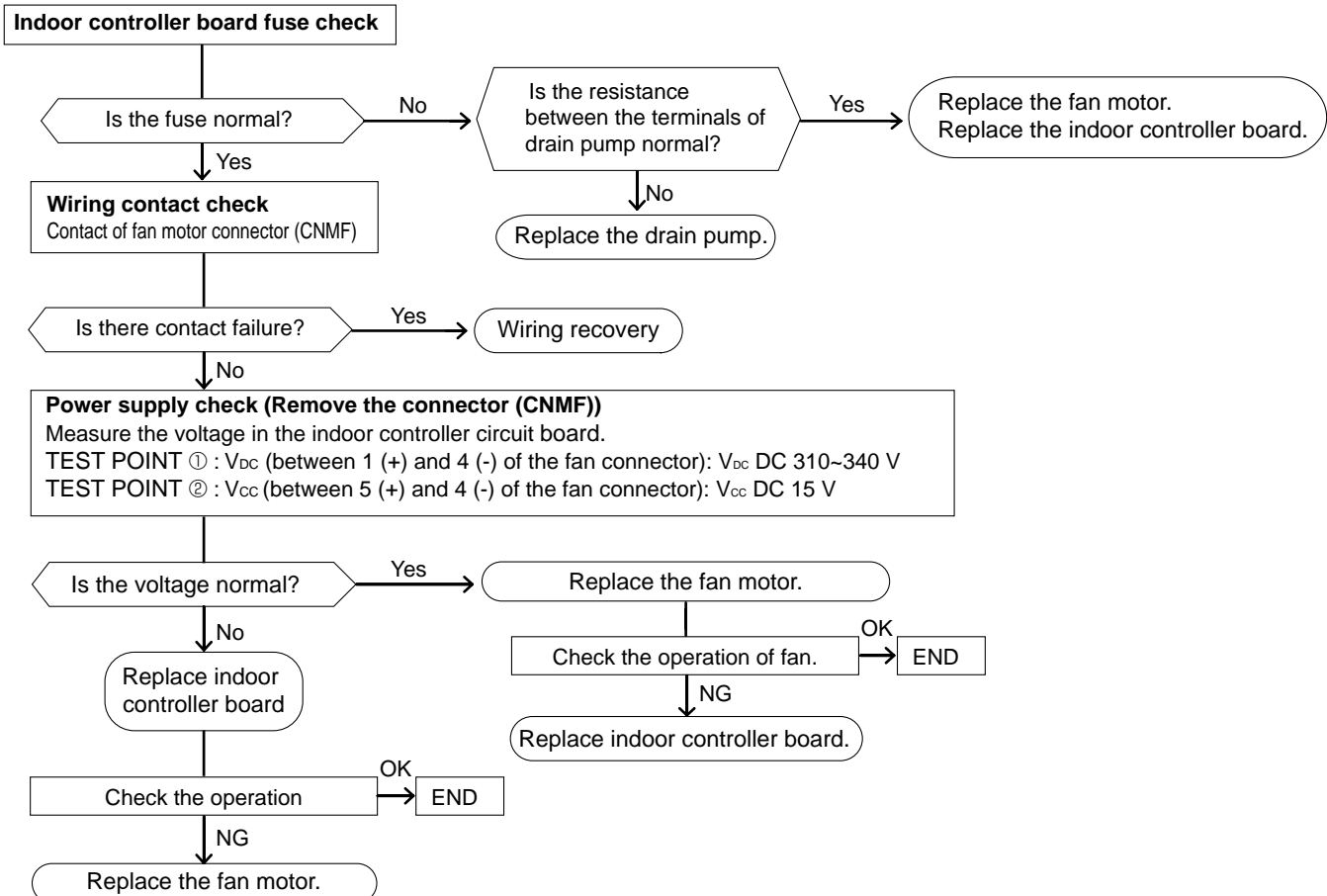

9-7. TEST POINT DIAGRAM

Indoor controller board

PLA-ZRP35BA.UK

PLA-ZRP50BA.UK

PLA-ZRP60BA.UK

PLA-ZRP71BA.UK

PLA-ZRP125BA.UK

PLA-ZRP140BA.UK

LED3
Transmission (Indoor/outdoor)

CN90
Connect to the wireless
remote controller board
(CNB)

CN4Y
i-see sensor

CN6Y
i-see sensor motor output
12V DC pulse output

CN105

LED2
Power supply (R.B)

CN4F
Drain float switch (FS)

CN44
Pipe temperature
thermistor
①-② : Liquid (TH2)
③-④ : Condenser/Evaporator (TH5)

CN20
Room temperature
thermistor (TH1)

LED1
Power supply (I.B)

CNMF
Fan motor
①-④: DC 310~340V
⑤-④: DC15V

CNP
Drain-pump output (DP)
(220-240V AC)

CNAC
Connect to the auto grille
controller board (CN3A)
(220-240V AC)

CN3G
Connect to the auto grille controller board (CN3G)
13V pulse output

CNV
Vane motor output (MV)
12V pulse output

SW1
Model selection

SW2
Capacity setting

CN2L
Connector (LOSSNAY)

Jumper wire J41, J42
Pair No. setting for wireless
remote controller

CN51
Centrally control
①-② : Control signal
13V pulse input (①:+)
③-④ : Operation indicator
13VDC (③:+)
③-⑤ : Malfunction indicator
13VDC (③:+)

CN41
Connector
(HA terminal-A)

CN32
Connector
(Remote switch)

SWE
Emergency operation

CN3C
Transmission
(Indoor/outdoor)
(0~24V DC)

CN22
Connect to the terminal
block (TB5)
(Remote controller connect-
ing wire)
(10.4~14.6V DC)

V_{CC} : Voltage between pins of
C955 15VDC
(Same as ⑤(+)-④(-) of CNMF)

CN01
Connect to the Terminal Block (TB4)
(Indoor/outdoor connecting line)
Between ③ and ⑤
220-240V AC

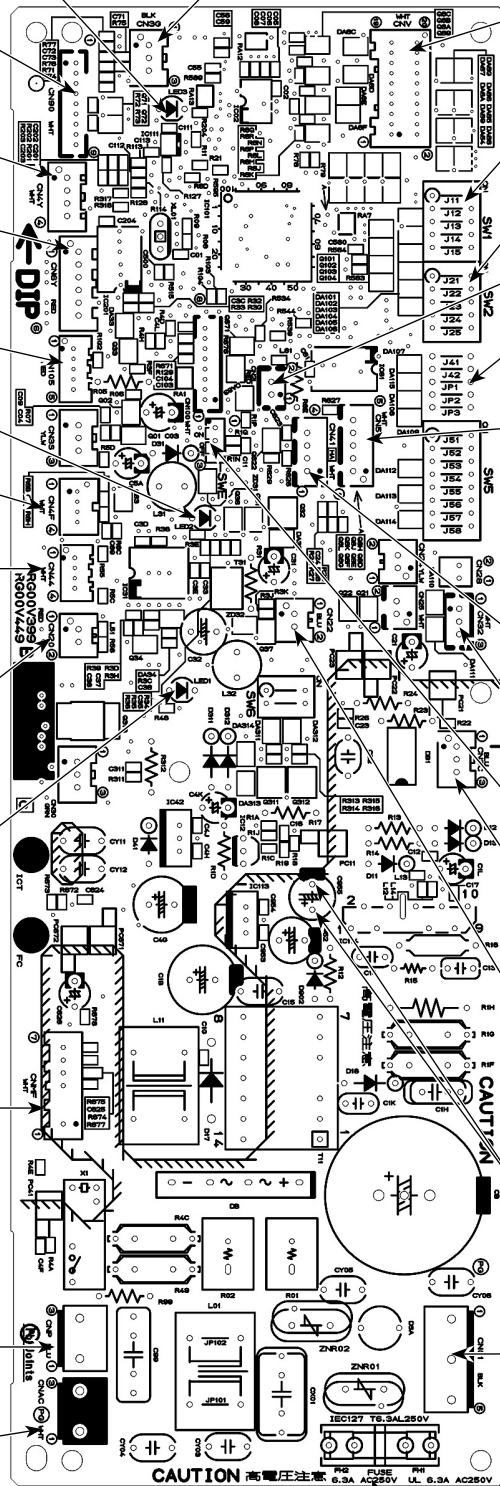













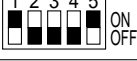



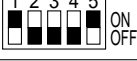

FUSE 6.3A/250V

9-8. FUNCTIONS OF DIP SWITCH AND JUMPER WIRE

Each function is controlled by the dip switch and the jumper wire on control P.C. board.

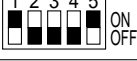
The black square (■) indicates a switch position
 Jumper wire (○: Short ×: Open)

Jumper wire	Functions	Setting by the dip switch and jumper wire	Remarks																	
SW1	Model settings																			
SW2	Capacity settings	<table border="1"> <thead> <tr> <th>MODELS</th> <th>SETTING</th> </tr> </thead> <tbody> <tr> <td>PLA-ZRP35BA</td> <td>  </td> </tr> <tr> <td>PLA-ZRP50BA</td> <td>  </td> </tr> <tr> <td>PLA-ZRP60BA</td> <td>  </td> </tr> <tr> <td>PLA-ZRP71BA</td> <td>  </td> </tr> <tr> <td>PLA-ZRP125BA</td> <td>  </td> </tr> <tr> <td>PLA-ZRP140BA</td> <td>  </td> </tr> </tbody> </table>	MODELS	SETTING	PLA-ZRP35BA		PLA-ZRP50BA		PLA-ZRP60BA		PLA-ZRP71BA		PLA-ZRP125BA		PLA-ZRP140BA					
MODELS	SETTING																			
PLA-ZRP35BA																				
PLA-ZRP50BA																				
PLA-ZRP60BA																				
PLA-ZRP71BA																				
PLA-ZRP125BA																				
PLA-ZRP140BA																				
J41 J42	Pair number setting with wireless remote controller	<table border="1"> <thead> <tr> <th rowspan="2">Wireless remote controller setting</th> <th colspan="2">Control PCB setting</th> </tr> <tr> <th>J41</th> <th>J42</th> </tr> </thead> <tbody> <tr> <td>0</td> <td>○</td> <td>○</td> </tr> <tr> <td>1</td> <td>×</td> <td>○</td> </tr> <tr> <td>2</td> <td>○</td> <td>×</td> </tr> <tr> <td>3 ~ 9</td> <td>×</td> <td>×</td> </tr> </tbody> </table>	Wireless remote controller setting	Control PCB setting		J41	J42	0	○	○	1	×	○	2	○	×	3 ~ 9	×	×	<p><Initial setting> Wireless remote controller: 0 Control PCB: ○ (for both J41 and J42) 4 pair number settings are supported. The pair number settings of the wireless remote controller and indoor control PCB (J41/J42) are given in the table on the left. ('×' in the table indicates the jumper wire is disconnected.)</p>
Wireless remote controller setting	Control PCB setting																			
	J41	J42																		
0	○	○																		
1	×	○																		
2	○	×																		
3 ~ 9	×	×																		
JP1	Unit type setting	<table border="1"> <thead> <tr> <th>Model</th> <th>JP1</th> </tr> </thead> <tbody> <tr> <td>Without TH5</td> <td>○</td> </tr> <tr> <td>With TH5</td> <td>×</td> </tr> </tbody> </table>	Model	JP1	Without TH5	○	With TH5	×	There is no jumper (JP1) because these models have the cond./eva. temperature thermistor (TH5).											
Model	JP1																			
Without TH5	○																			
With TH5	×																			
JP3	Indoor controller board type setting	<table border="1"> <thead> <tr> <th>Indoor controller board type</th> <th>JP3</th> </tr> </thead> <tbody> <tr> <td>For product</td> <td>○</td> </tr> <tr> <td>Service parts</td> <td>○</td> </tr> </tbody> </table>	Indoor controller board type	JP3	For product	○	Service parts	○												
Indoor controller board type	JP3																			
For product	○																			
Service parts	○																			

10-1. HOW TO PERFORM THE UP/DOWN OPERATION OF THE AIR INTAKE GRILLE

10-1-1. Setting up the lowering distance of air intake grille

You can set up 8 different stages of lowering distance for the air intake grille according to the set up location if desired.

* As a factory default, the decorative panel will automatically stop at 1.6 m from the ceiling level. The distance is a rough indication, check by actually lowering it.

- 1) Take the cover off the electric box of the decorative panel. (2 screws)
- 2) Set up the dip switches of SW22 or SW2 on the control board of the decorative panel as followed.

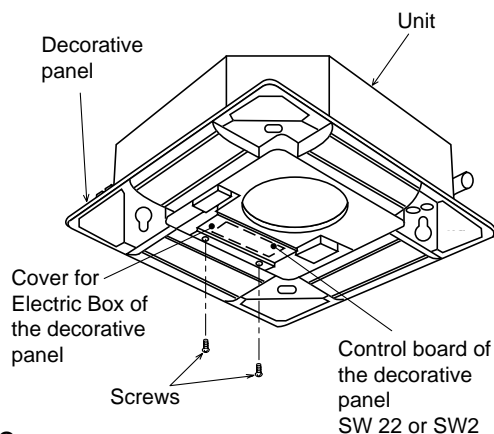

Dip SW 22

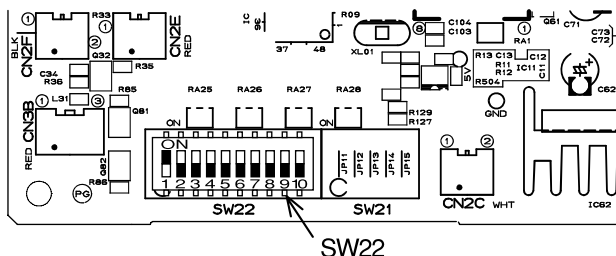

The black square (■) indicates a switch position.

Lowering distance (Rough indication of the ceiling height)	SW22 (Lowering distance)	Lowering distance (Rough indication of the ceiling height)	SW22 (Lowering distance)
1.2m (~ 2.4m)	ON OFF [10 switches: 1-9 ON, 10 OFF]	1.6m (2.4m ~ 2.8m)	Initial setting ON OFF [10 switches: 1-9 ON, 10 OFF]
2.0m (2.8m ~ 3.2m)	ON OFF [10 switches: 1-9 ON, 10 OFF]	2.4m (3.2m ~ 3.6m)	ON OFF [10 switches: 1-9 ON, 10 OFF]
2.8m (3.6m ~ 4.0m)	ON OFF [10 switches: 1-9 ON, 10 OFF]	3.2m (4.0m ~ 4.4m)	ON OFF [10 switches: 1-9 ON, 10 OFF]
3.6m (4.4m ~ 4.8m)	ON OFF [10 switches: 1-9 ON, 10 OFF]	4.0m (4.8m ~ 5.2m)	ON OFF [10 switches: 1-9 ON, 10 OFF]

* Airflow outreach distance is different depending on indoor units and air volume (ceiling height), so airflow may not reach the indicated ceiling height as shown in the above table.

- 3) Put the cover back on the electric box of the decorative panel.

Dip SW 2

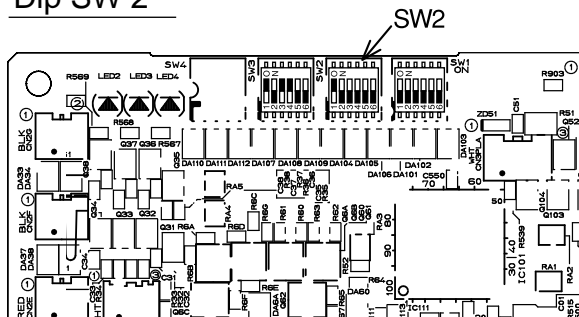

The black square (■) indicates a switch position.

Lowering distance (Rough indication of the ceiling height)	SW2 (Lowering distance)	Lowering distance (Rough indication of the ceiling height)	SW2 (Lowering distance)
1.2m (~ 2.4m)	ON OFF [6 switches: 1-5 ON, 6 OFF]	1.6m (2.4m ~ 2.8m)	Initial setting ON OFF [6 switches: 1-5 ON, 6 OFF]
2.0m (2.8m ~ 3.2m)	ON OFF [6 switches: 1-5 ON, 6 OFF]	2.4m (3.2m ~ 3.6m)	ON OFF [6 switches: 1-5 ON, 6 OFF]
2.8m (3.6m ~ 4.0m)	ON OFF [6 switches: 1-5 ON, 6 OFF]	3.2m (4.0m ~ 4.4m)	ON OFF [6 switches: 1-5 ON, 6 OFF]
3.6m (4.4m ~ 4.8m)	ON OFF [6 switches: 1-5 ON, 6 OFF]	4.0m (4.8m ~ 5.2m)	ON OFF [6 switches: 1-5 ON, 6 OFF]

* Airflow outreach distance is different depending on indoor units and air volume (ceiling height), so airflow may not reach the indicated ceiling height as shown in the above table.

10-1-2. How to perform the up/down operation using wireless remote controller

Warning: Ensure that the air-conditioner is not running.
• Otherwise, it may cause an injury or a failure.

1) Ensure that the air-conditioner is not running.

2) Press the "Down" button to lower the air intake grille.

* By default, the air intake grille will automatically stop at a lowering distance of 1.6 m from the ceiling level. The distance can be changed to 1.2 m, 2.0 m, 2.4 m, 2.8 m, 3.2 m, 3.6 m and 4.0 m. These should be used only as a guide. You should lower the air intake grille yourself to check the exact distance.

* When you want to stop the air intake grille while it is lowering, press the "Stop" or "Up" button on the remote controller to stop at that position.

3) Remove the filter or air intake grille and clean them.

4) Attach the filter and air intake grille.

5) Press the "Up" button on the remote controller to put the air intake grille in place.

* If the air intake grille is not placed in the correct position at a time, the operation is automatically retried.

* When you want to stop the air intake grille while it is rising, press the "Stop" or "Down" button on the remote controller to stop at that position.

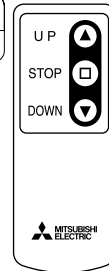

Wireless remote controller for Automatic Filter Elevation Panel

10-1-3. How to perform the up/down operation using wired remote controller (PAR-30MAA / PAR-31MAA)

① Select "Maintenance" from the Main menu, and press the button.



Select "Auto descending panel" with the **F1** or **F2** button, and press the button.

* When using the auto descending panel, always set the "Address" and "Unit No." with "Service" – "Function setting".

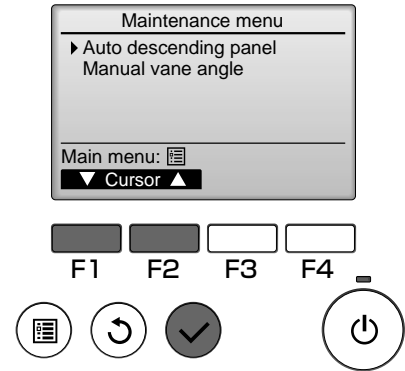

② Move the cursor to "Ref. address", "Unit No." or "Operation" with the **F1** button to select.



Select the refrigerant address and the unit number for the units to whose falls panel, with the **F2** or **F3** button, and press the button.

- Ref. address: Refrigerant address
- Unit No.: 1, 2, 3, 4, All
- Operation: Down / Up



Press the **F4** button to confirm the unit.

<Confirmation of target unit>
If the unit being set is unknown, make the setting and then press the **F4** button to confirm.
The air conditioner which is blowing downward is the target air conditioner.

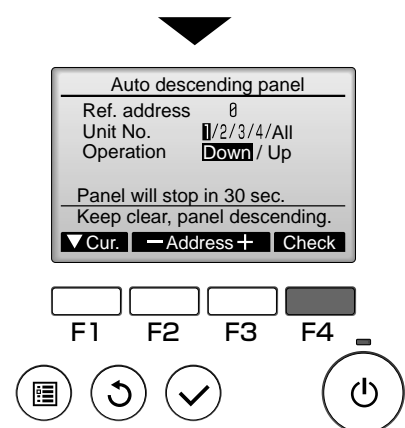
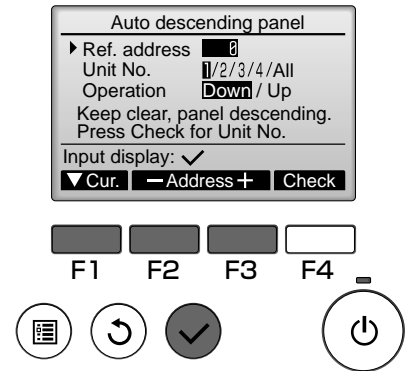

Navigating through the screens

- To go back to the Main menu button
- To return to the previous screen..... button

10-1-4. How to perform the up/down operation using wired remote controller (PAR-21MAA)

■ General Operation

- * Raise or lower all the air intake grilles managed by the remote controller at the same time.
- Install the remote controller in a place where you can observe all the air-conditioners. Otherwise, the lowering grille may make contact with something and cause damage to it.

1) Ensure that the air-conditioner is not running.

- * The up/down operation mode is only available when the air conditioner is "OFF".

Warning: Ensure that the air-conditioner is not running.
• Otherwise, it may cause an injury or a failure.

2) Press both the "FILTER" and "Ventilation" buttons simultaneously for 2 seconds or more to enter the up/down operation mode.

"Up/down operation mode" display



3) Press the TEMP. (▽) button. After a while, the air intake grille will begin lowering.

"Stand by for lowering" display

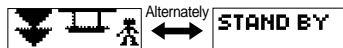

"Lowering" display (blinking)

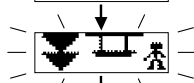

"Stopped" display (when finished lowering)

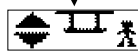

[Note:]

- You cannot stop the operation while the air intake grille is lowering.
- * If you press the (△) button while the air intake grille is moving down, the air intake grille may stop lowering, but it will not stop immediately.
- By default, the air intake grille will automatically stop at the lowering distance of 1.6 m from the ceiling level.
- * The distance can be changed to 1.2 m, 2.0 m, 2.4 m, 2.8 m, 3.2 m, 3.6 m, and 4.0 m. These should be used only as a guide. You should lower the air intake grille yourself to check the exact distance.

4) Remove the filter and/or air intake grille to clean them.

5) Press the TEMP. (△) button. After a while, the air intake grille will begin to rise and then be put back into place.

"Stand by for raising" display

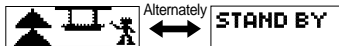

"Raising" display (blinking)



"Stopped" display (when the air intake grille has been put back into place)

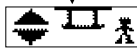

[Note:]

- You cannot stop the operation while the air intake grille is rising.
- * If you press the (▽) button while the intake grille is moving up, the air intake grille may stop rising, but it will not stop immediately.

6) Exit the up/down mode either by pressing the "ON/OFF" button or by pressing both the "FILTER" and "Ventilation" buttons simultaneously for 2 seconds or more.

- * After exiting the up/down mode, wait for about 30 seconds to perform the next operation. The remote controller will not accept any operation for that period.

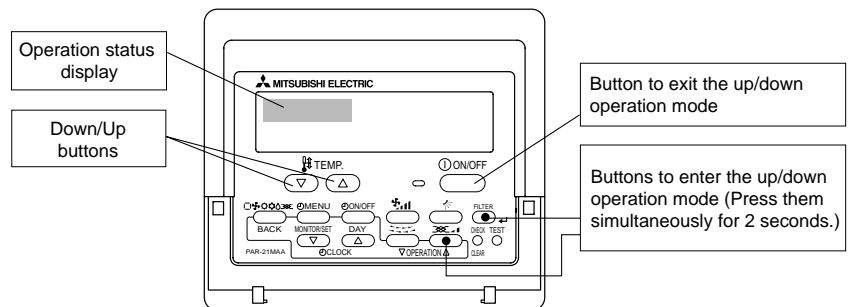

- Up/down operation with the individual specified air-conditioner (when used in combination with Mr. SLIM model)
- * Raise or lower the air intake grille of the specific air-conditioner that you select from all that are managed by that remote controller.

- 1) Ensure that the air-conditioner is not running.
 * The up/down operation mode is only available when the air-conditioner is "OFF".

Warning: Ensure that the air-conditioner is not running.
 • Otherwise, it may cause an injury or a failure.

- 2) Press both the "FILTER" and "Ventilation" buttons simultaneously for 2 seconds or more to enter the up/down operation mode.

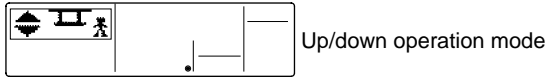

- 3) Press the "Ventilation" button. After a while, it will switch to the "individually-specified up/down operation mode".

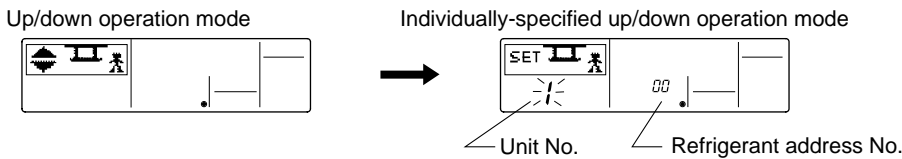

If the number of the target air-conditioner is unknown, go to 4).

In the upper right figure, the air-conditioner for which the refrigerant address is "00" and the unit No. is "1" is currently selected.

If the number of the target air-conditioner is known, go to 5).

- 4) If you press the "FILTER" button when the "Unit No." or "Refrigerant address No." is blinking, after a while, the up/down airflow direction of the displayed air-conditioner will be switched downward; and the airflow direction of the other vents will all be blocked.

- In Step 5) described below, identify the target air-conditioner by changing the "Unit No." and "Refrigerant address No." and by pressing the "FILTER" button to check the up/down airflow direction.

[Remarks:]
 ■ If "Err" is displayed when you press the "FILTER" button to check the target air-conditioner, the air-conditioner with that "Unit No." or "Refrigerant address" may not exist. Check and set that air-conditioner again.

- 5) Select the "Unit No." and "Refrigerant address No.".

- "Unit No." and "Refrigerant address No." can be changed by using the "TEMP." buttons (Δ) (▽) when the panel displays (a) or (b).
- Every time you press the "Mode selection" button, the target of operation will change as illustrated below.

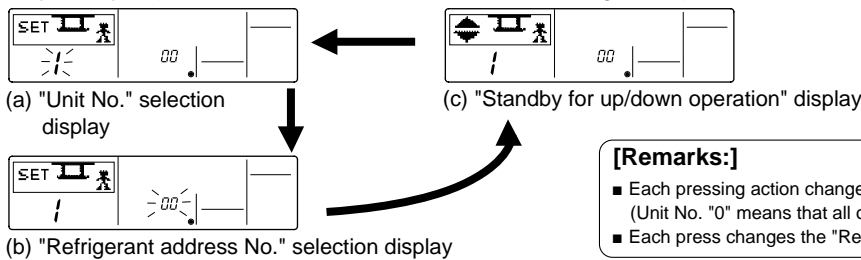

[Remarks:]
 ■ Each pressing action changes the unit No. from "1 - 4" to "0". (Unit No. "0" means that all of 1 - 4 are targeted.)
 ■ Each press changes the "Refrigerant address" from "0 to 15".

- 6) Continue to press the "Mode selection" button until "Waiting for up/down operation" is displayed.

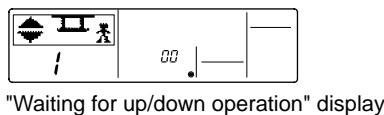

The following steps are the same as steps 3) - 6) described in the "General Operation" section. Refer to that section.

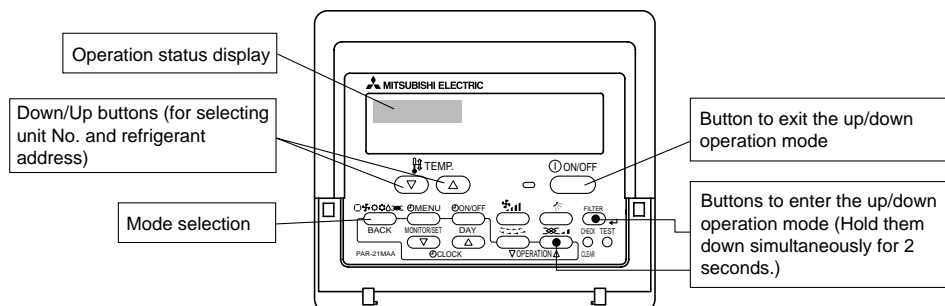

10-2. OPERATION (AUTO DESCENDING PANEL: PLP-6BAJ)

(1) Normal operation

① UP/DOWN

Air intake grille is raised/lowered by commands of UP and DOWN.

Air intake grille does not move under the state of no-load detection or obstacle detection.

Air intake grille stops automatically at the set lowering distance from the ceiling level.

② STOP

It stops in the cases below :

- When it reaches at the set lowering distance from the ceiling level.
It automatically stops after a predetermined period of lowering.
- When it is stored in the panel.

The air intake grille is judged to be stored in the panel when the storage detection switch is pressed for 3 seconds continuously.

- When receiving commands of STOP, DOWN while moving up or UP while moving down.

The STOP button is only available on the automatic filter elevation panel remote controller.

When the wired remote controller is used, there will be a slight delay in stopping due to transmission speed.

- When both wire 1b and 2b are not loaded.

Only the wire b in each UP/DOWN Machine has a tension detection switch.

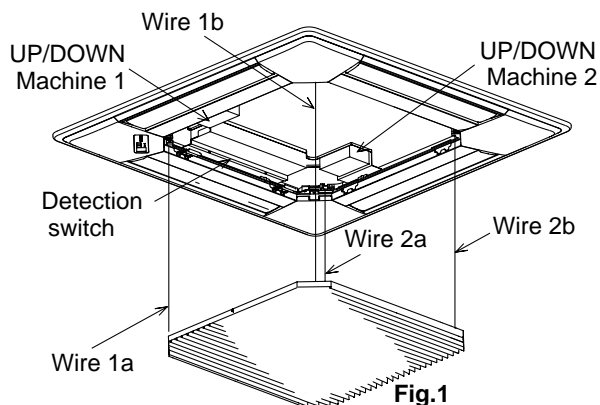

(2) Special operation

① Storage operation

Case : Obstruction of the raising grille before storage or malfunction of storage detection switch

Storage operation will be performed when the intake grille has been raised the set distance but the storage detection switch is not engaged.

In this case, the operation below will be repeated up to 4 times.

10 cm down → 30 cm up → ... → 10 cm down → 30 cm up

② No-load detection

Case : UP/DOWN commands with no grille suspended.

When both wire 1b and wire 2b are not loaded, the wires will not move.

③ Obstacle detection

Case : Making contact with something while lowering.

Should the loads on the wire 1b and wire 2b be removed due to the grille making contact with something while lowering, the lowering operation will stop. The grille will then be raised 10 cm and stop again.

[Emergency operation]

- When the wireless remote controller cannot be used (in the case of battery discharge, misplacing of the wireless remote controller, malfunctioning and so on), the emergency switch on the receiver can be used as an alternative.

* When doing this, particular caution must be taken not to fall.

To lower the air intake grille : Press the  button once.

(For emergency heating operation, press and hold this button.)

To raise the air intake grille : Press the  button once.

(For emergency cooling operation, press and hold this button.)

- To stop the air intake grille from moving, use the opposite buttons to those used to initiate movement.
(To stop it from lowering, press the UP button; To stop it from rising, press the Down button.)
 - If up/down machine is out of order, fix air intake grille temporarily and the indoor unit can be operated.
- * For details, refer to installation manual for the attachment of grille.

10-3. ELECTRICAL CIRCUIT (Controller board and wiring diagram (Panel))

10-3-1. Dip SW 22 type

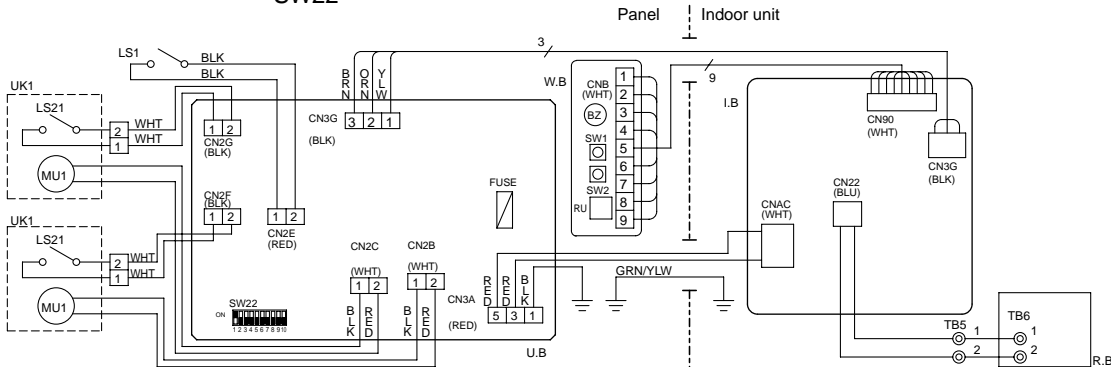
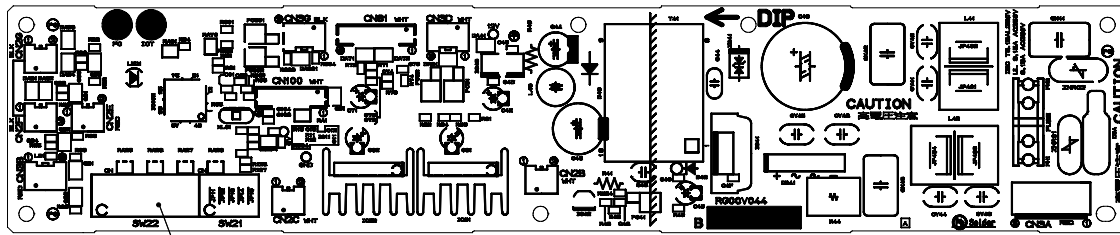

Symbol	Name	Symbol	Name
U.B	Auto grille controller board	W.B	Wireless remote controller board
FUSE	Fuse (3.15A)	BZ	Buzzer
SW22	Switch (Lowering distance set up)	RU	Receiver
UK1	Up/down machine	SW1	Emergency switch (heating/down)
MU1	Motor (Up/down)	SW2	Emergency switch (cooling/up)
LS21	Limit switch (tension detection)	LS1	Limit switch (storage detection)
I.B	Indoor controller board	R.B	Wired remote controller

10-3-2. Dip SW 2 type

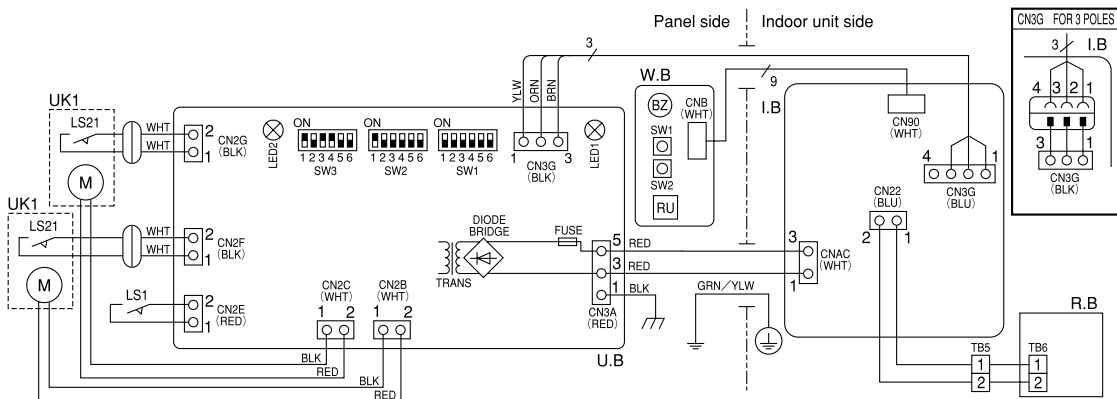
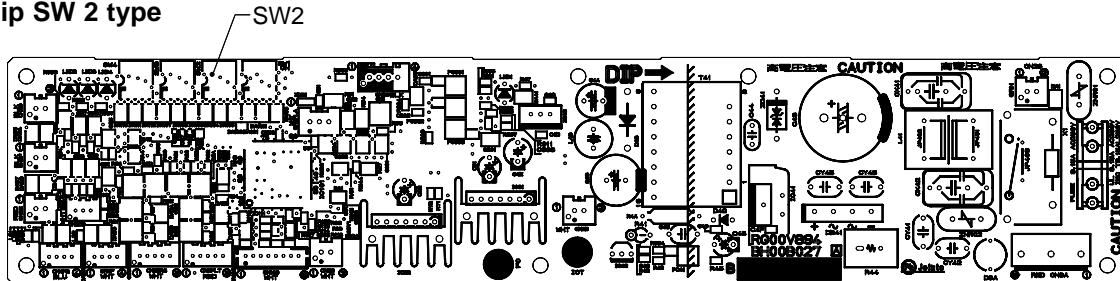

[LEGEND]

SYMBOL	NAME	SYMBOL	NAME	SYMBOL	NAME
U.B	CONTROLLER BOARD	I.B	INDOOR UNIT CONTROLLER BOARD	UK1	UP/DOWN MACHINE
FUSE	FUSE (T3.15A/250V)	W.B	WIRELESS SIGNAL RECEIVER BOARD	M	MOTOR (FOR GRILLE UP/DOWN)
SW1	SWITCH (MODEL SELECTION)	BZ	BUZZER	LS21	LIMIT SWITCH (TENSION DETECTION)
SW2	SWITCH (LOWERING DISTANCE)	RU	RECEIVING UNIT	LS1	LIMIT SWITCH (STORAGE DETECTION)
SW3	SWITCH (SYSTEM SELECTION)	SW1	EMERGENCY HEATING LONG PRESS FOR OVER 2 SEC)	R.B.	WIRED REMOTE CONTROLLER
LED1	LED RED (MICROCOMPUTER POWER)	SW2	EMERGENCY COOLING LONG PRESS FOR OVER 2 SEC)		
LED2	LED RED (GRILLE CONDITION)				

10-3-3. Check point of trouble

<LED (SW22 type) /LED2 (SW2 type) display>

Turn OFF	: No power supply
Blink	: Storage detection switch ON (short)
One blink	: Storage detection switch OFF (open)
Two blinks	: Tension detection switch OFF (open)

<controller board>

Check item	Check point	Normal	Remarks
Up/down controller P.C. board supply voltage	CN3A (between 3-5)	AC 198~264 V	—
Up/down machine supply voltage	CN2B, CN2C	DC 10~12 V	Check when instructing up/down with LED blinking once.

<Up/down machine>

Check item	Check point	Normal	Check contents
Storage detection switch	CN2E	open or short	Check if it is short when pressing push switch.
Tension detection switch	CN2F, CN2G	open or short	Check if it is short when wire b is tensioned.
Motor	CN2B, CN2C	5~20 Ω	Check if it is not open or short.
Entwining wires	Pull wire	Retention: about 2 kgf	Check if wire is drawn out by pulling with 3 kgf.

10-4. TROUBLESHOOTING

- Check the following points.

Problem	Possible Reason	Corrective Action
Air intake grille does not function with operation of the wireless remote controller.	Air-conditioner is running.	Stop running the air-conditioner and try again.
	Power failure	After recovering from power failure, try again.
	Batteries are not inserted into the wireless remote controller. Or battery power is running low.	Insert or replace the battery.
	There is something on the air intake grille. Or something is stuck in the air intake grille.	Remove the objects or obstacles from the air intake grille. Or, remove the stuck object.
Air intake grille cannot be fixed in place.	There is something on the air intake grille.	Remove the objects or obstacles from the air intake grille.
	Filter is not properly installed.	Lower the air intake grille again and check whether the filter is installed in the correct position.
	Air intake grille is not hung with all 4 hooks.	Lower the air intake grille again and hook on the air intake grille.
Air intake grille stops lowering. (Air intake grille would not lower any further.)	The air intake grille has finished lowering to the auto-stop position.	This is normal.
Noises are made during up/down operation. (While air intake grille is moving up/down.)	This is the noise made when the wire is wound and unwound.	This is normal.
Noises are made while putting the air intake grille into place.	This is the operational noise for putting the air intake grille into place.	
Air intake grille repeats rising and lowering several times while being put into place.	This is the operation for putting the air intake grille into place.	
Air intake grille leans toward one side during the up/down operation.	The speeds of winding/unwinding wires are slightly different for each wire.	

10-5. ROTATION FUNCTION (AND BACK-UP FUNCTION, 2ND STAGE CUT-IN FUNCTION)

10-5-1. Operation

(1) Rotation function (and Back-up function)

• Outline of functions

- Main and sub unit operate alternately according to the interval of rotation setting.
- * Main and sub unit should be set by refrigerant address. (Outdoor Dip switch setting)
Refrigerant address "00" → Main unit
Refrigerant address "01" → Sub unit
- When error occurs to one unit, another unit will start operation. (Back-up function)

• System constraint

- This function is available only by the grouping control system (INDOOR UNIT : OUTDOOR UNIT=1:1) of 2 refrigerant groups. (Refer to Fig. 1)
- Main indoor unit should be connected for wired remote controller and the transmission line (TB5) for main and sub unit should also be connected. (Refer to Fig. 1)
(This function cannot be set by wireless remote controller.)
- Set refrigerant address of each unit. (Dip switch on the outdoor unit ... Refrigerant address 00/01)

Operation pattern

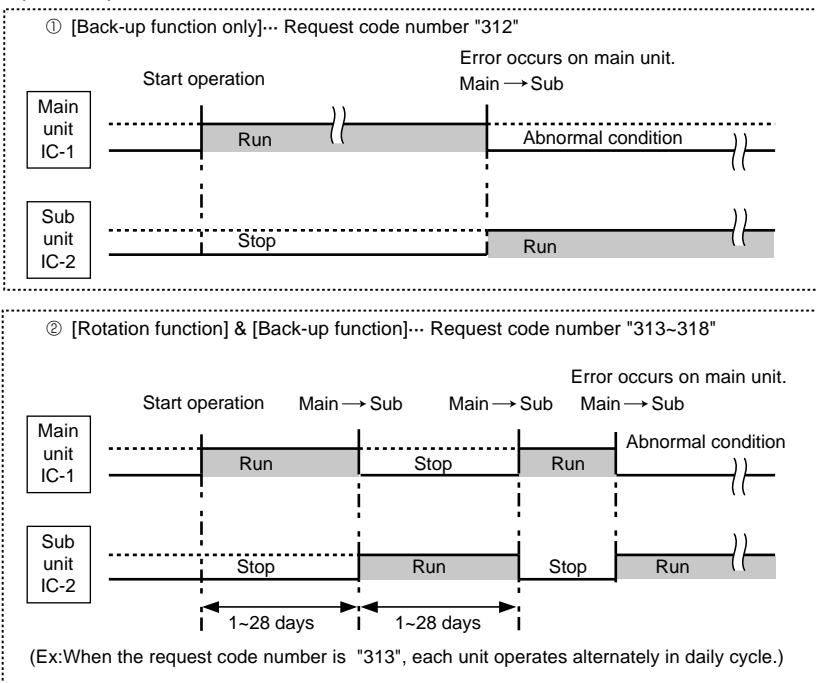
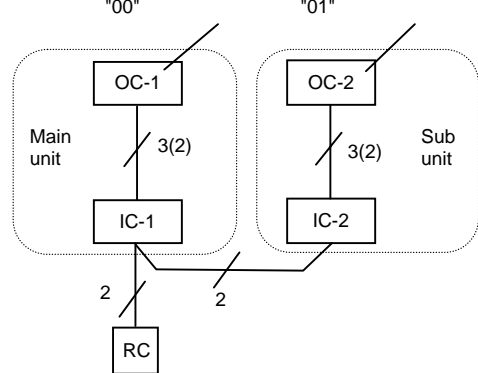

Fig. 1 Refrigerant address "00" Refrigerant address "01"



OC : Outdoor unit
IC : Indoor unit
RC : Wired remote controller

Note:

- When the unit is restarted to operate after turning off the power or OFF operation, the unit which was operating will start operation.
- To operate the main unit, refer to the 10-5-2. and set the request code No. which is not the same as the current one, and set again the former request code No.

(2) 2nd stage cut-in function

Outline of functions

- When the 1st unit can NOT supply with sufficient capacity for exceptionally high-demand conditions and the actual room temperature reaches set point *, the 2nd unit starts operation in conjunction with the 1st unit.
- Once the actual room temperature goes down to 4 degrees C below set point *, the 2nd unit stops operation automatically. (* set point = set temperature by R/C (remote controller) + 4, 6, 8°C (selectable))
- Number of operating units is determined according to the room temperature and set point.
- When room temperature becomes higher than set point, standby unit starts. (2 units operation)
- When room temperature falls below set point -4°C, standby unit stops. (1 unit operation)

• System constraint

- This function is available only in cooling mode.

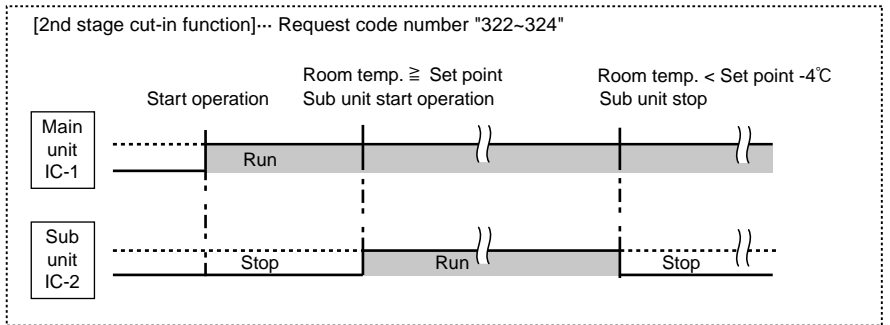
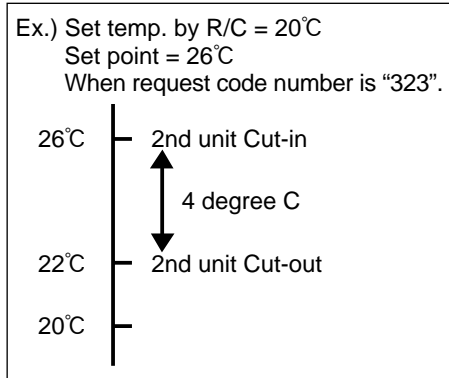

10-5-2. How to set rotation function (Back-up function, 2nd stage cut-in function)

You can set these functions by wired remote controller. (Maintenance monitor)

NOTICE

Both main and sub unit should be set in same setting.
 Every time replacing indoor controller board for servicing, the function should be set again.

(1) Request Code List

Rotation setting

Setting No. (Request code)	Setting contents	Initial setting
No.1 (310)	Monitoring the request code of current setting.	
No.2 (311)	Rotation and Back-up OFF (Normal group control operation)	☉
No.3 (312)	Back-up function only	
No.4 (313)	Rotation ON (Alternating interval = 1 day) and back-up function	
No.5 (314)	Rotation ON (Alternating interval = 3 days) and back-up function	
No.6 (315)	Rotation ON (Alternating interval = 5 days) and back-up function	
No.7 (316)	Rotation ON (Alternating interval = 7 days) and back-up function	
No.8 (317)	Rotation ON (Alternating interval = 14 days) and back-up function	
No.9 (318)	Rotation ON (Alternating interval = 28 days) and back-up function	

2nd unit cut-in setting

Setting No. (Request code)	Setting contents	Initial setting
No.1 (320)	Monitoring the request code of current setting.	
No.2 (321)	Cut-in function OFF	☉
No.3 (322)	Cut-in function ON(Set point = Set temp.+ 4°C (7.2°F))	
No.4 (323)	Cut-in function ON(Set point = Set temp.+ 6°C (10.8°F))	
No.5 (324)	Cut-in function ON(Set point = Set temp.+ 8°C (14.4°F))	

(3) Rotation and back up operation PAR-30MAA/PAR-31MAA

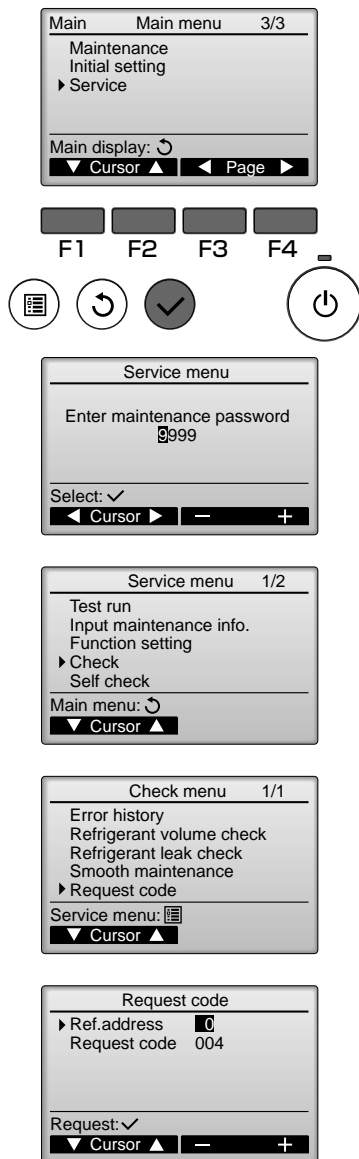

- ① Press the button.
- ② Select "Service" with the [Cursor] buttons (and) or the [Page] buttons (and), and press the button.
- ③ Enter the current maintenance password (4 numerical digits).
 - Move cursor to the digit you want to change with the or button.
 - Set each number (0 through 9) with the or button.
(Note: The initial maintenance password is "9999".)
- ④ Then, press the button.
- ⑤ Select "Check" with the or button, and press the button.
- ⑥ Select "Request code" with the or button, and press the button.
- ⑦ Set the Refrigerant address and Request code.
 - Select the item to be changed with the or button.
 - Select the required setting with the or button.
- ⑧ Press the or button to set the Refrigerant address "0".
- ⑨ Press the or button to set the desired request code No.
 - Rotation & Back up operation: Please match request code with 311 - 318 either.
 - 2nd stage cut-in operation: Please match request code with 321 - 324 either.
- ⑩ Press the button. Data will be collected and displayed.
- ⑪ Press the or button to set the Refrigerant address "1".
Please set above ⑨ - ⑩.
- ⑫ To return to the Main menu, press the button.

PAR-21MAA

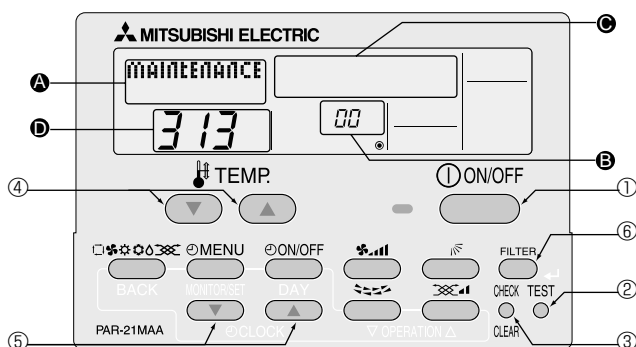

- Refrigerant address
- Data display area
- Request code display area

- ① To stop air conditioner, press the button.
- ② Press the button for three seconds so that "Maintenance mode" appears on the screen (at).
- ③ Press the button for three seconds to switch to [Maintenance monitor].
"00" (Refrigerant address) appears on the screen in a few minutes (at).
- ④ Press the [CLOCK] buttons (and) to set the desired request code No.
Rotation & Back up operation: Please match request code with 311 - 318 either.
2nd stage cut-in operation: Please match request code with 321 - 324 either.
- ⑤ Press the button to perform data request.
(The requested data will be displayed at in the same way as in maintenance mode.)
- ⑥ Press the [TEMP] buttons (and) to set the Refrigerant address 01.
"01" (Refrigerant address) appears on the screen in a few minutes (at).
Please set above ③ - ⑤.
- ⑦ To return to normal mode, press the button.

PLA-ZRP35BA.UK
PLA-ZRP71BA.UK

PLA-ZRP50BA.UK
PLA-ZRP125BA.UK

PLA-ZRP60BA.UK
PLA-ZRP140BA.UK

Be careful when removing heavy parts.

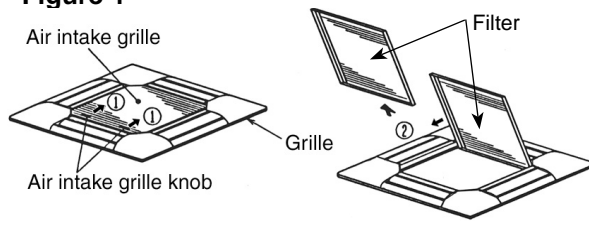
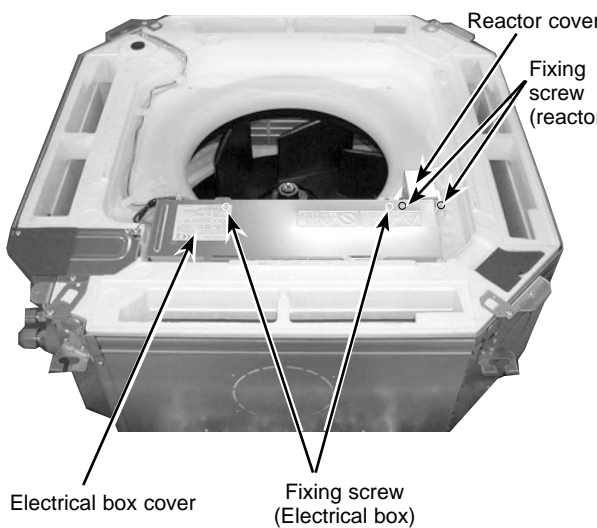
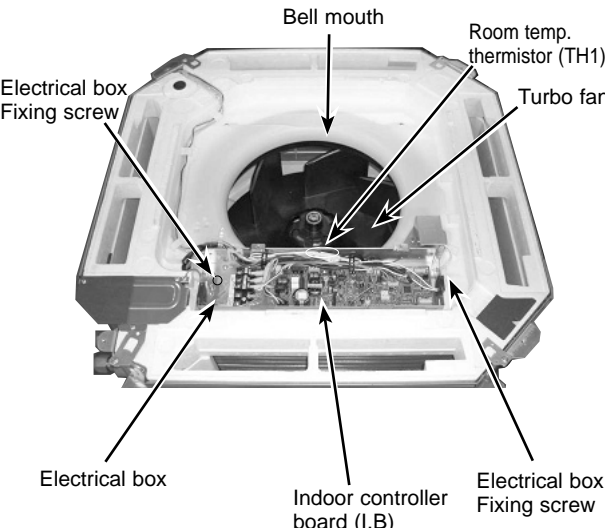
OPERATING PROCEDURE	PHOTOS & ILLUSTRATIONS
<p>1. Removing the air intake grille</p> <ol style="list-style-type: none"> (1) Slide the knob of air intake grille toward the arrow ① to open the air intake grille. (2) Remove drop prevention hook from the panel. (3) Slide the shaft in the hinge to the direction of the arrow ② and remove the air intake grille. 	<p>Figure 1</p>  <p>Air intake grille Air intake grille knob Grille Filter</p>
<p>2. Removing the room temperature thermistor (TH1)</p> <ol style="list-style-type: none"> (1) Remove the air intake grille and the filter. (See Figure 1) (2) Remove the 2 screws from the electrical box. (3) Disconnect the connector CN20 (Red) from the indoor controller board. (4) Remove the room temperature thermistor and holder. 	<p>Photo 1</p>  <p>Reactor cover Fixing screw (reactor) Electrical box cover Fixing screw (Electrical box)</p>
<p>3. Removing the reactor (DCL)</p> <ol style="list-style-type: none"> (1) Remove the air intake grille and the filter. (See Figure 1) (2) Remove the 2 screws from the reactor cover. (3) Disconnect the relay connector of reactor. (4) Remove 2 reactor fixing screws and remove the reactor. 	<p>Photo 2</p>  <p>Bell mouth Room temp. thermistor (TH1) Turbo fan Electrical box Indoor controller board (I.B.) Electrical box Fixing screw</p>
<p>4. Removing the indoor controller board (I.B)</p> <ol style="list-style-type: none"> (1) Remove the air intake grille and the filter. (See Figure 1) (2) Remove the 2 screws from the electrical box cover. (3) Disconnect the connectors : CNMF (White/7P) for fan motor CN44 (White/4P) for thermistor (TH2/TH5) CNP (Blue/3P) for drain pump CN4F (White/4P) for float switch CN01 (Black/5P) for earth and reactor CNV (White/20P) for vane motor (4) Remove the 6 supports from indoor controller board. (5) Remove the indoor controller board. 	
<p>5. Removing the electrical box</p> <ol style="list-style-type: none"> (1) Remove the air intake grille and the filter. (See Figure 1) (2) Remove the 2 screws from the electrical box cover. (3) Disconnect the connectors. (Refer to 4.) (4) Remove 2 electrical box fixing screws and remove 2 hooks. (5) Pull the electrical box. <p><Electrical parts in the electrical box> Indoor controller board Terminal block (TB4)(TB5)</p>	

OPERATING PROCEDURE

PHOTOS & ILLUSTRATIONS

6. Removing the fan and fan motor (MF)

- (1) Remove the electrical box. (See Photo 2)
- (2) Remove the bell mouth (3 screws). (See Photo 2)
- (3) Remove the turbo fan nut.
- (4) Pull out the turbo fan.
- (5) Remove the wire cover (3 screws).
- (6) Remove 2 wiring clamps.
- (7) Disconnect the connector of the fan motor (CNMF).
- (8) Remove the 3 nuts and washers and rubber mounts of the fan motor.

Photo 3

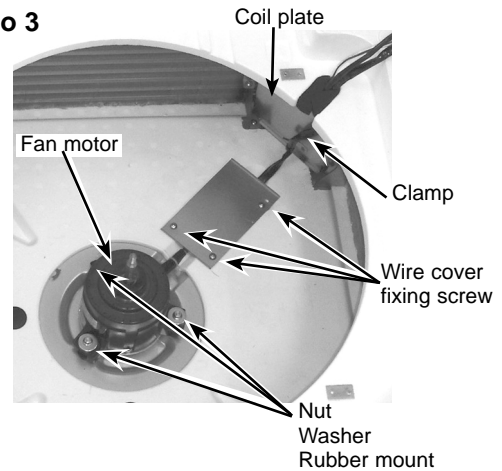

7. Removing the panel

- (1) Remove the air intake grille and the filter. (See Figure 1)
 - (2) Disconnect the connector CNV (White/20P).
- Corner panel (See Figure 2)**
- (3) Remove the corner screw.
 - (4) Slide the corner panel to the direction of the arrow ①, and remove the corner panel.
- Panel (See Photo 4, 5)**
- (5) Remove the 2 screws from the panel which fix to the oval holes.
 - (6) Rotate the panel a little to come to the bell shaped hole where the screw is large and remove the panel.

Figure 2

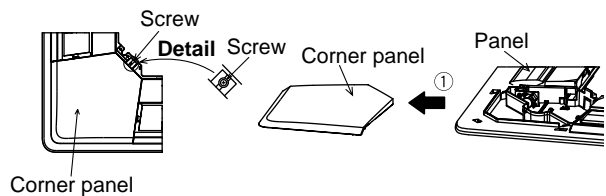

Photo 4

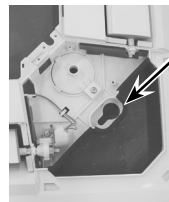
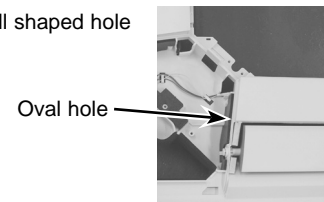

Photo 5



8. Removing the drain pan

- (1) Remove the air intake grille and the filter. (See Figure 1)
 - (2) Remove the 2 screws from the electrical box cover.
 - (3) Disconnect the connectors. (Refer to 4.)
 - (4) Remove the panel. (See Photo 4, 5)
 - (5) Remove the electrical wiring service panel (3 screws).
 - (6) Remove the electrical box. (See Photo 2)
 - (7) Remove the bell mouth. (See Photo 2)
 - (8) Remove the 4 screws and pull out the drain pan.
- * Pull out the left and right of the pan gradually.
Be careful not to crack or damage the pan.

Photo 6

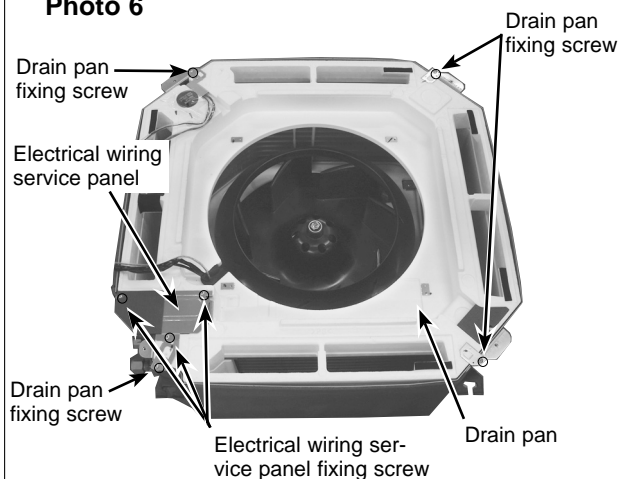

9. Removing the pipe temperature thermistor (TH2) and condenser evaporator temperature thermistor (TH5)

- (1) Remove the drain pan. (See Photo 6)
- (2) Remove the turbo fan. (See Photo 3)
- (3) Remove the 2 wiring clamps. (See Photo 3)
- (4) Remove the coil plate (2 screws).
- (5) Remove the thermistors which are inserted into the holders installed to the thin copper pipe.
- (6) Disconnect the 4-pin white connector (CN44).

Photo 7

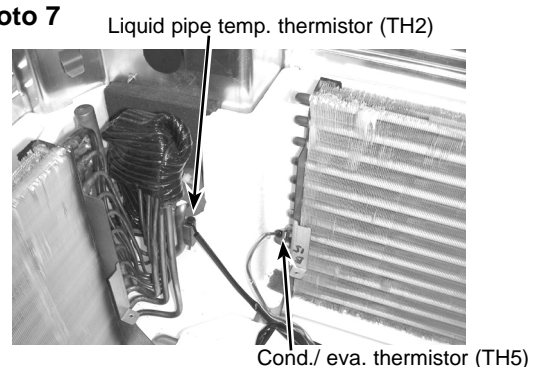

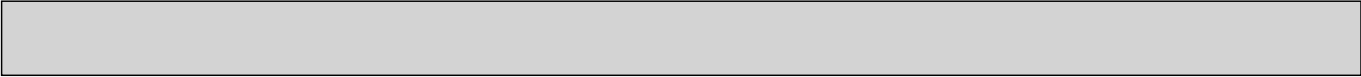

OPERATING PROCEDURE

10. Removing the drain pump (DP) and float switch (FS)

- (1) Remove the drain pan. (See Photo 6)
- (2) Cut the hose band and remove the hose.
- (3) Remove the drain pump assembly (3 screws and 2 hooks).
- (4) Remove the drain pump (3 screws).
- (5) Remove the float switch (2 screws).

PHOTOS & ILLUSTRATIONS

Photo 8

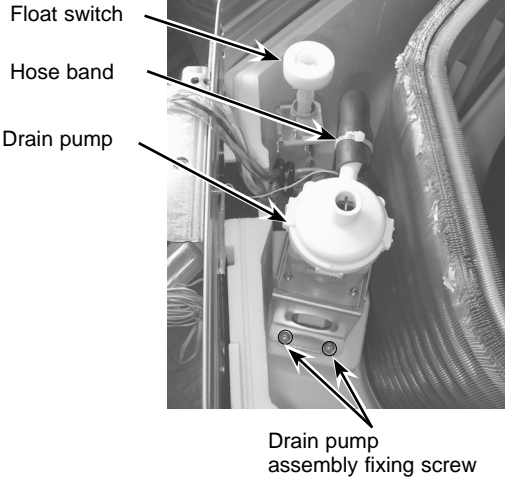
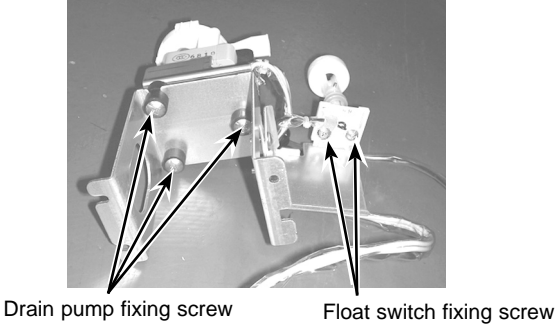

Photo 9



11. Removing the heat exchanger

- (1) Remove the drain pan. (See Photo 6)
- (2) Remove the 3 screws of the piping cover, and pull out piping cover.
- (3) Remove the 2 screws of coil plate.
- (4) Remove the 2 screws of the coil.
- (5) Remove the screw of the coil support.
- (6) Pull out the heat exchanger.

Photo 10

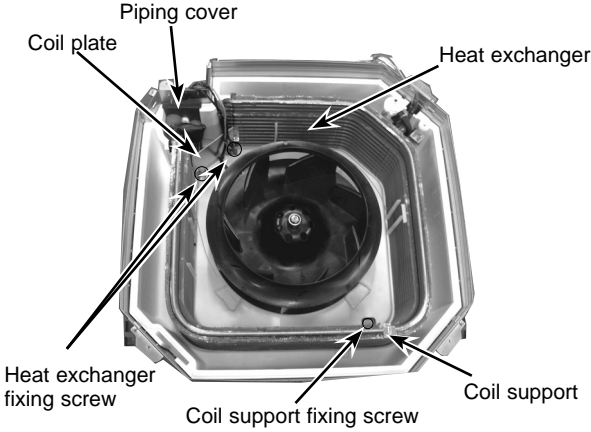

Mr. SLIM™

mitsubishi electric corporation

HEAD OFFICE : TOKYO BLDG., 2-7-3, MARUNOUCHI, CHIYODA-KU, TOKYO 100-8310, JAPAN