

SERVICE MANUAL

Series PSA Floor Standing R410A

Indoor unit
[Model names]

[Service Ref.]

PSA-RP71KA

PSA-RP71KA

PSA-RP100KA

PSA-RP100KA

PSA-RP125KA

PSA-RP125KA

PSA-RP140KA

PSA-RP140KA

Note:

- This manual describes only service data of the indoor units.
- RoHS compliant products have <G> mark on the spec name plate.

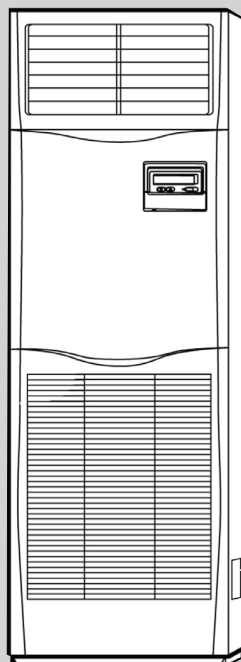

Model name
indication

CONTENTS

1. REFERENCE MANUAL	2
2. SAFETY PRECAUTION	3
3. PART NAMES AND FUNCTIONS	5
4. SPECIFICATIONS	7
5. NOISE CRITERION CURVES	9
6. OUTLINES AND DIMENSIONS	10
7. WIRING DIAGRAM	11
8. REFRIGERANT SYSTEM DIAGRAM	12
9. TROUBLESHOOTING	13
10. SPECIAL FUNCTION	23
11. DISASSEMBLY PROCEDURE	26

PARTS CATALOG (OCB528)

1-1. OUTDOOR UNIT'S SERVICE MANUAL

Service Ref.	Service Manual No.
PUHZ-ZRP71VHA PUHZ-ZRP100/125/140VKA PUHZ-ZRP100/125/140YKA	OCH527/OCB527
PUHZ-P100/125/140VHA3.UK PUHZ-P100/125/140VHA3R1.UK PUHZ-P100/125/140VHA3R2.UK PUHZ-P125/140VHA3R3.UK PUHZ-P100/125/140YHA.UK PUHZ-P100/125/140YHAR1.UK PUHZ-P125/140YHAR2.UK PUHZ-P100YHA2.UK	OCH415/OCB415
PU(H)-P71/100VHA#1.UK PU(H)-P71/100VHA#2.UK PU(H)-P71/100VHA#3.UK PU(H)-P71/100/125/140YHA#1.UK PU(H)-P71/100/125/140YHA#2.UK PU(H)-P71/100/125/140YHAR3.UK PU(H)-P125/140YHAR4.UK	OC379

1-2. TECHNICAL DATA BOOK

Series (Outdoor unit)	Manual No.
PUHZ-P • VHA PUHZ-P • YHA	OCS17
PU(H)-P • VHA PU(H)-P • YHA	OCS07

CAUTIONS RELATED TO NEW REFRIGERANT

Cautions for units utilising refrigerant R410A

Use new refrigerant pipes.

In case of using the existing pipes for R22, be careful with the followings.

- For RP71VHA3 and RP100, 125 and 140, be sure to perform replacement operation before test run.
- Change flare nut to the one provided with this product. Use a newly flared pipe.
- Avoid using thin pipes.

Make sure that the inside and outside of refrigerant piping is clean and it has no contamination such as sulfur hazardous for use, oxides, dirt, shaving particles, etc. In addition, use pipes with specified thickness.

Contamination inside refrigerant piping can cause deterioration of refrigerant oil etc.

Store the piping to be used during installation indoors and keep both ends of the piping sealed until just before brazing. (Leave elbow joints, etc. in their packaging.)

If dirt, dust or moisture enter into refrigerant cycle, that can cause deterioration of refrigerant oil or malfunction of compressor.

Use ester oil, ether oil or alkylbenzene oil (small amount) as the refrigerant oil applied to flares and flange connections.

If large amount of mineral oil enter, that can cause deterioration of refrigerant oil etc.

Charge refrigerant from liquid phase of gas cylinder.

If the refrigerant is charged from gas phase, composition change may occur in refrigerant and the efficiency will be lowered.

Do not use refrigerant other than R410A.

If other refrigerant (R22 etc.) is used, chlorine in refrigerant can cause deterioration of refrigerant oil etc.

Use a vacuum pump with a reverse flow check valve.

Vacuum pump oil may flow back into refrigerant cycle and that can cause deterioration of refrigerant oil etc.

Use the following tools specifically designed for use with R410A refrigerant.

The following tools are necessary to use R410A refrigerant.

Tools for R410A	
Gauge manifold	Flare tool
Charge hose	Size adjustment gauge
Gas leak detector	Vacuum pump adaptor
Torque wrench	Electronic refrigerant charging scale

Keep the tools with care.

If dirt, dust or moisture enter into refrigerant cycle, that can cause deterioration of refrigerant oil or malfunction of compressor.

Do not use a charging cylinder.

If a charging cylinder is used, the composition of refrigerant will change and the efficiency will be lowered.

Ventilate the room if refrigerant leaks during operation. If refrigerant comes into contact with a flame, poisonous gases will be released.

Use the specified refrigerant only.

Never use any refrigerant other than that specified.

Doing so may cause a burst, an explosion, or fire when the unit is being used, serviced, or disposed of.

Correct refrigerant is specified in the manuals and on the spec labels provided with our products.

We will not be held responsible for mechanical failure, system malfunction, unit breakdown or accidents caused by failure to follow the instructions.

[1] Cautions for service

- (1) Perform service after collecting the refrigerant left in unit completely.
- (2) Do not release refrigerant in the air.
- (3) After completing service, charge the cycle with specified amount of refrigerant.
- (4) When performing service, install a filter drier simultaneously.
Be sure to use a filter drier for new refrigerant.

[2] Additional refrigerant charge

When charging directly from cylinder

- Check that cylinder for R410A on the market is syphon type.
- Charging should be performed with the cylinder of syphon stood vertically. (Refrigerant is charged from liquid phase.)

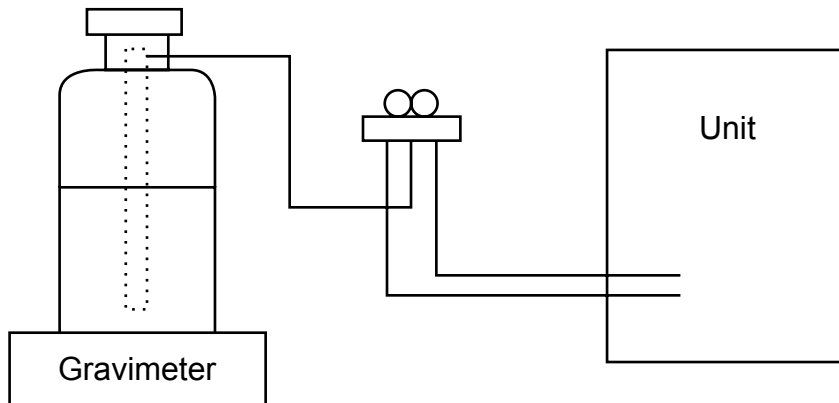

[3] Service tools

Use the below service tools as exclusive tools for R410A refrigerant.

No.	Tool name	Specifications
①	Gauge manifold	· Only for R410A
		· Use the existing fitting specifications. (UNF1/2)
		· Use high-tension side pressure of 5.3 MPa·G or over.
②	Charge hose	· Only for R410A
		· Use pressure performance of 5.09 MPa·G or over.
③	Electronic scale	—
④	Gas leak detector	· Use the detector for R134a, R407C or R410A.
⑤	Adaptor for reverse flow check	· Attach on vacuum pump.
⑥	Refrigerant charge base	—
⑦	Refrigerant cylinder	· Only for R410A
		Top of cylinder (Pink) Cylinder with syphon
⑧	Refrigerant recovery equipment	—

3

PART NAMES AND FUNCTIONS

● Indoor Unit

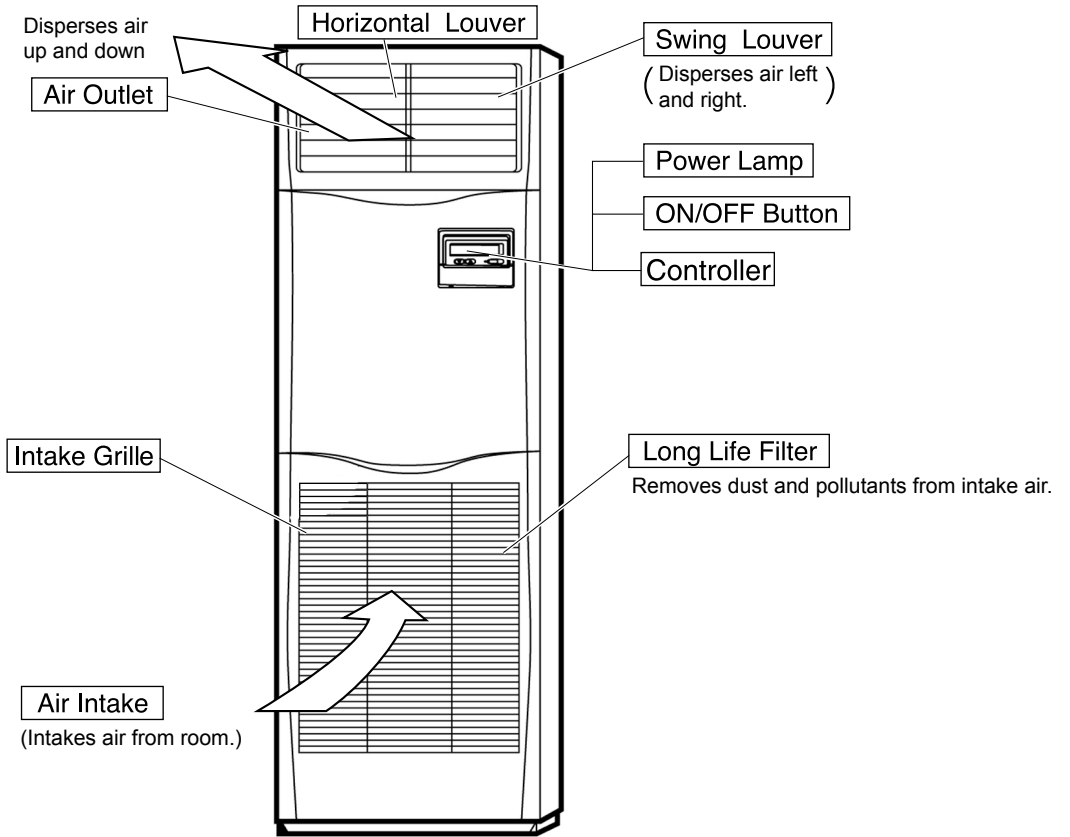

● Controller

Once the controls are set, the same operation mode can be repeated by simply pressing the ON/OFF button.

● Operation buttons

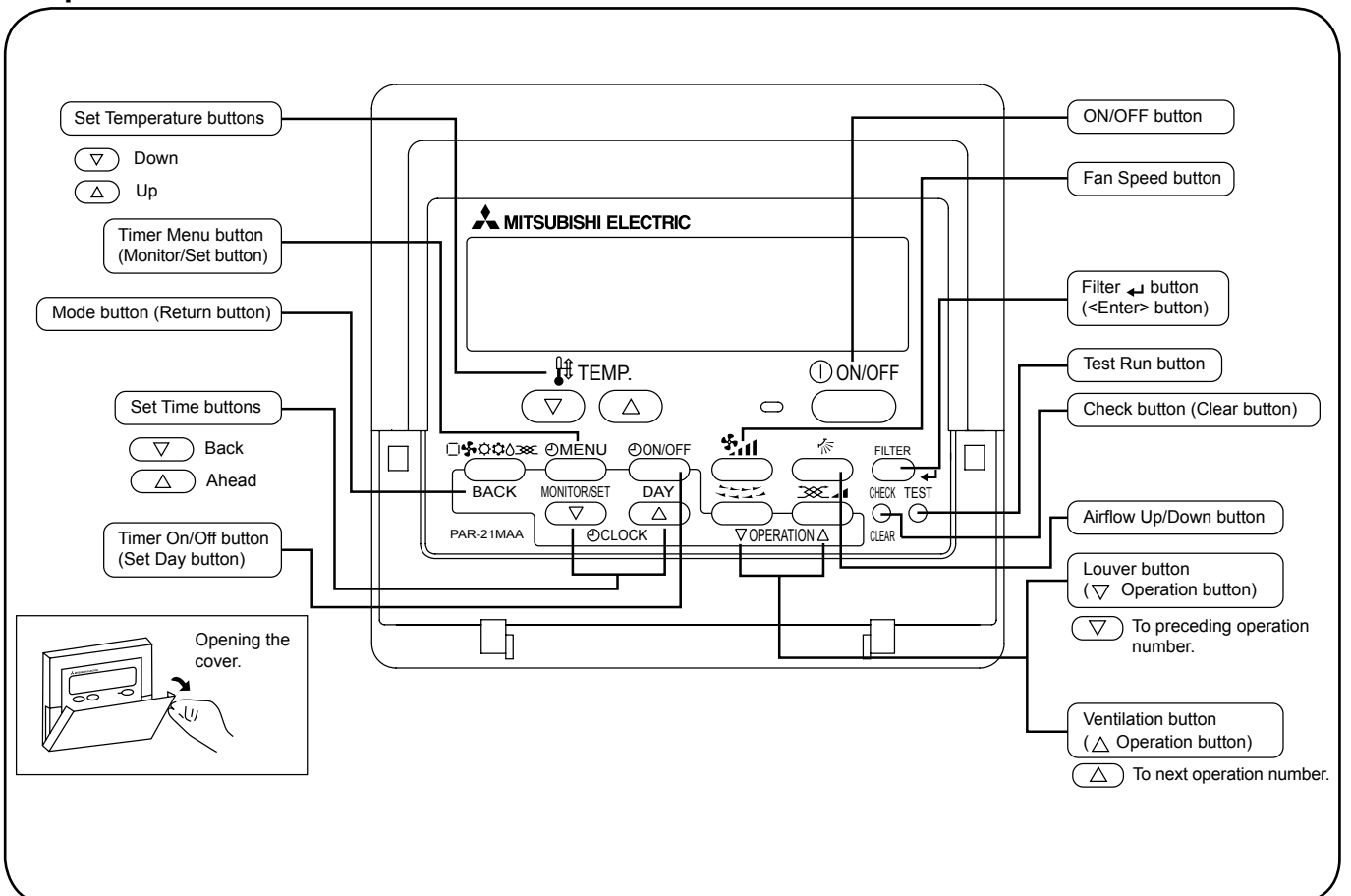

● Display

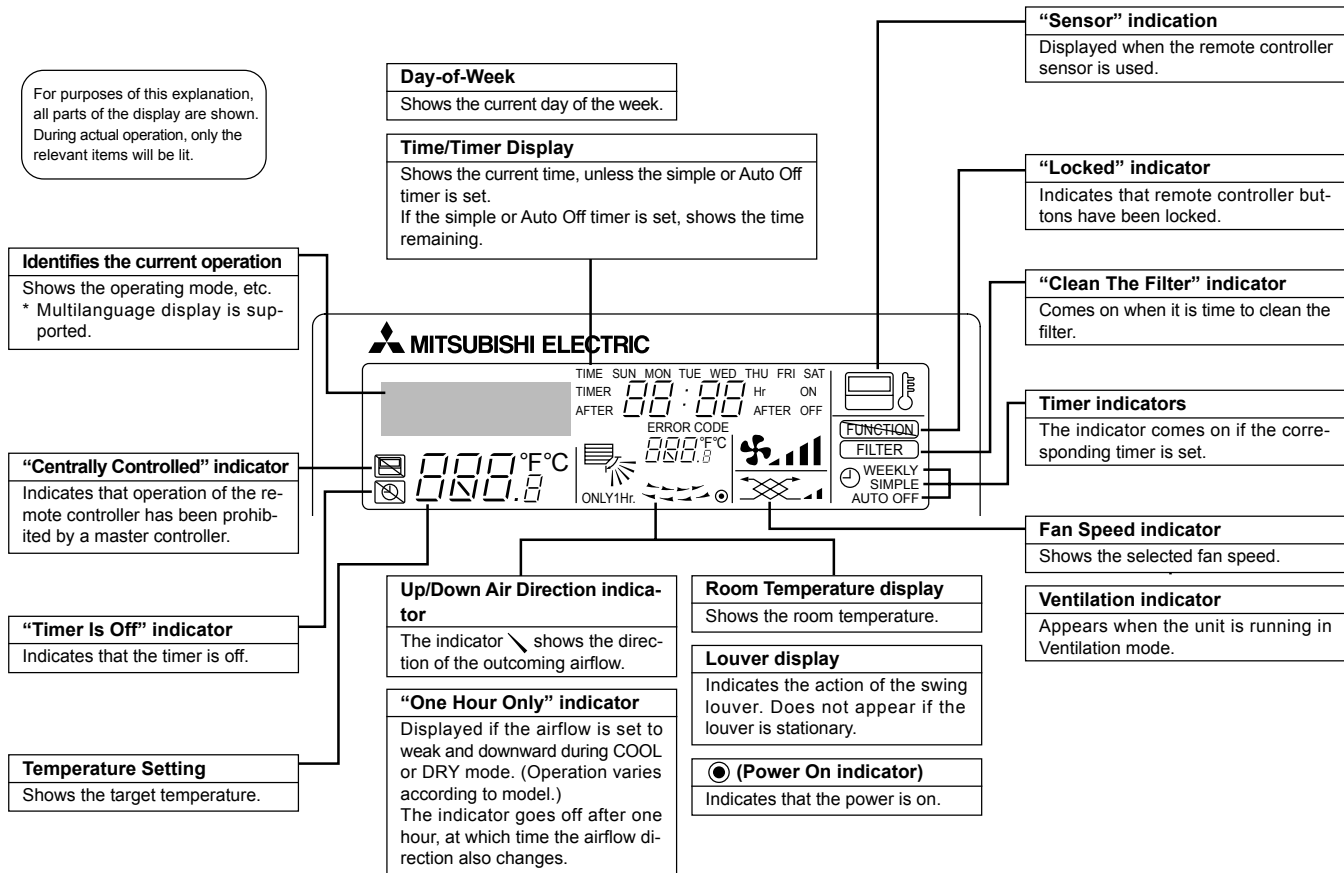

Caution

- Only the Power on indicator lights when the unit is stopped and power supplied to the unit.
- If you press a button for a feature that is not installed at the indoor unit, the remote controller will display the “Not Available” message.
If you are using the remote controller to drive multiple indoor units, this message will appear only if the feature is not present at the parent unit.
- When power is turned ON for the first time, it is normal that “PLEASE WAIT” is displayed on the room temperature indication (For max. 2 minutes). Please wait until this “PLEASE WAIT” indication disappears then start the operation.

4

SPECIFICATIONS

Service Ref.			PSA-RP71KA		
INDOOR UNIT	Mode		Cooling	Heating	
	Power supply(phase, cycle, voltage)		Single phase, 50Hz, 230V		
	Input	kW	0.06	0.06	
	Running current	A	0.40	0.40	
	External finish		Munsell 0.70Y 8.59/0.97		
	Heat exchanger		Plate fin coil		
	Fan	Fan(drive) × No.		Centrifugal (direct) × 1	
		Fan motor output	kW	0.12	
		Airflow(Low-Middle-High)	m ³ /min(CFM)	20-22-24(714-786-857)	
		External static pressure	Pa(mmAq)	0(direct blow)	
	Booster heater		kW	—	
	Operation control & Thermostat		Remote controller & built-in		
	Noise level(Low-Middle-High)		dB	40-42-44	
	Unit drain pipe O.D.		mm(in.)	20(13/16)	
	Dimensions	W	mm(in.)	600(23-5/8)	
D		mm(in.)	360(14-11/64)		
H		mm(in.)	1,900(74-13/16)		
Weight		kg(lbs)	46(102)		

Service Ref.			PSA-RP100KA		
INDOOR UNIT	Mode		Cooling	Heating	
	Power supply(phase, cycle, voltage)		Single phase, 50Hz, 230V		
	Input	kW	0.11	0.10	
	Running current	A	0.71	0.66	
	External finish		Munsell 0.70Y 8.59/0.97		
	Heat exchanger		Plate fin coil		
	Fan	Fan(drive) × No.		Centrifugal (direct) × 1	
		Fan motor output	kW	0.16	
		Airflow(Low-Middle-High)	m ³ /min(CFM)	25-28-30(893-1,000-1,071)	
		External static pressure	Pa(mmAq)	0(direct blow)	
	Booster heater		kW	—	
	Operation control & Thermostat		Remote controller & built-in		
	Noise level(Low-Middle-High)		dB	45-49-50	
	Unit drain pipe O.D.		mm(in.)	20(13/16)	
	Dimensions	W	mm(in.)	600(23-5/8)	
D		mm(in.)	360(14-11/64)		
H		mm(in.)	1,900(74-13/16)		
Weight		kg(lbs)	46(102)		

Service Ref.			PSA-RP125KA		
INDOOR UNIT	Mode		Cooling	Heating	
	Power supply(phase, cycle, voltage)		Single phase, 50Hz, 230V		
	Input	kW	0.11	0.11	
	Running current	A	0.73	0.73	
	External finish		Munsell 0.70Y 8.59/0.97		
	Heat exchanger		Plate fin coil		
	Fan	Fan(drive) × No.		Centrifugal (direct) × 1	
		Fan motor output	kW	0.16	
		Airflow(Low-Middle-High)	m ³ /min(CFM)	25-28-31(893-1,000-1,107)	
		External static pressure	Pa(mmAq)	0(direct blow)	
	Booster heater		kW	—	
	Operation control & Thermostat		Remote controller & built-in		
	Noise level(Low-Middle-High)		dB	45-49-51	
	Unit drain pipe O.D.		mm(in.)	20(13/16)	
	Dimensions	W	mm(in.)	600(23-5/8)	
D		mm(in.)	360(14-11/64)		
H		mm(in.)	1,900(74-13/16)		
Weight		kg(lbs)	46(102)		



Service Ref.			PSA-RP140KA	
Mode			Cooling	Heating
Power supply(phase, cycle, voltage)			Single phase, 50Hz, 230V	
Input		kW	0.11	0.11
Running current		A	0.73	0.73
External finish			Munsell 0.70Y 8.59/0.97	
Heat exchanger			Plate fin coil	
INDOOR UNIT	Fan		Centrifugal (direct) × 1	
	Fan(drive) x No.			
	Fan motor output		0.16	
	Airflow(Low-Middle-High)		25-28-31(893-1,000-1,107)	
External static pressure		Pa(mmAq)	0(direct blow)	
Booster heater		kW	—	
Operation control & Thermostat			Remote controller & built-in	
Noise level(Low-Middle-High)		dB	45-49-51	
Unit drain pipe O.D.		mm(in.)	20(13/16)	
Dimensions	W	mm(in.)	600(23-5/8)	
	D	mm(in.)	360(14-11/64)	
	H	mm(in.)	1,900(74-13/16)	
Weight		kg(lbs)	48(106)	

5

NOISE CRITERION CURVES

PSA-RP71KA

NOTCH	SPL(dB)	LINE
High	44	○—○
Middle	42	●—●
Low	40	●—●

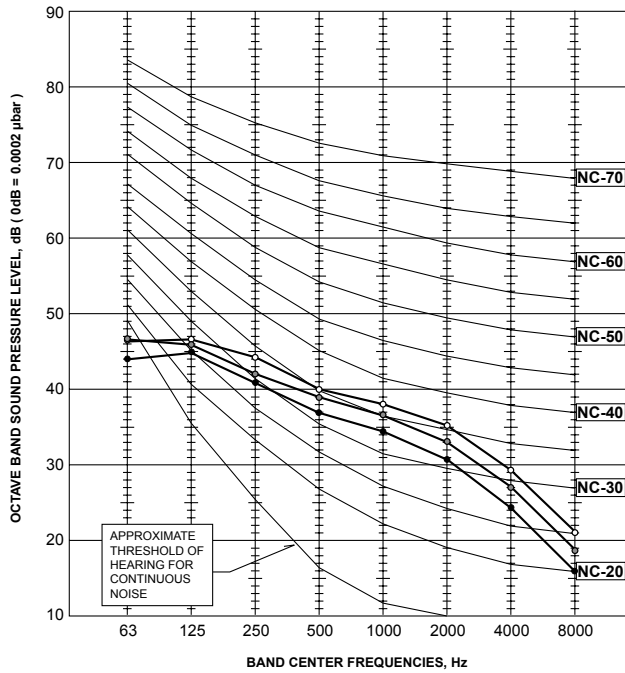

PSA-RP100KA

NOTCH	SPL(dB)	LINE
High	50	○—○
Middle	49	●—●
Low	45	●—●

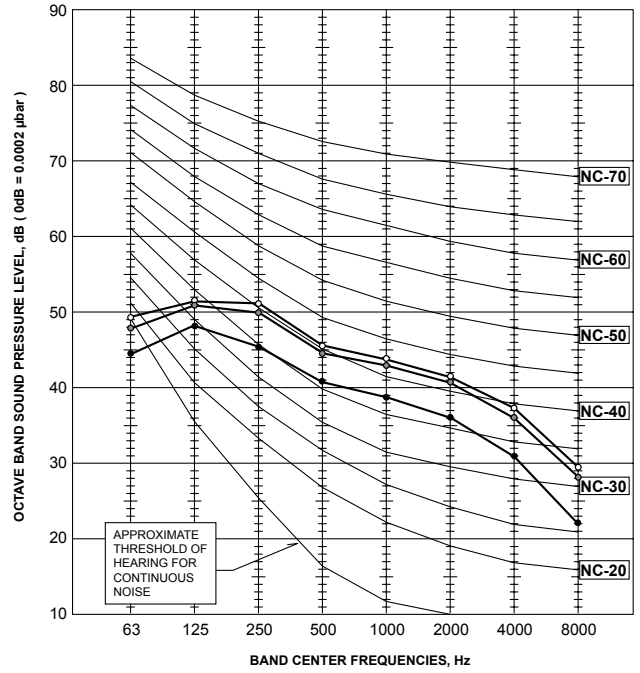

PSA-RP125KA

NOTCH	SPL(dB)	LINE
High	51	○—○
Middle	49	●—●
Low	45	●—●

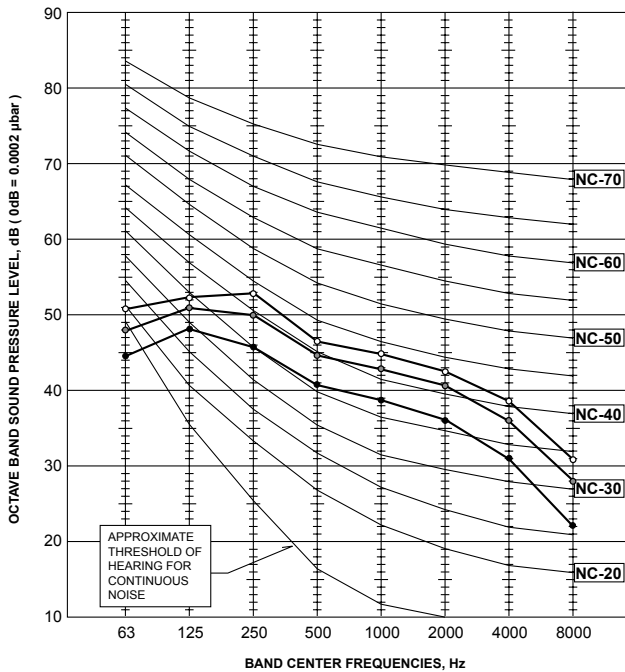

PSA-RP140KA

NOTCH	SPL(dB)	LINE
High	51	○—○
Middle	49	●—●
Low	45	●—●

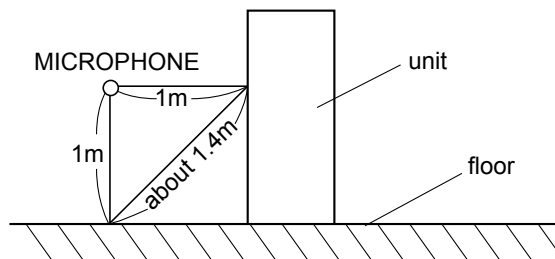
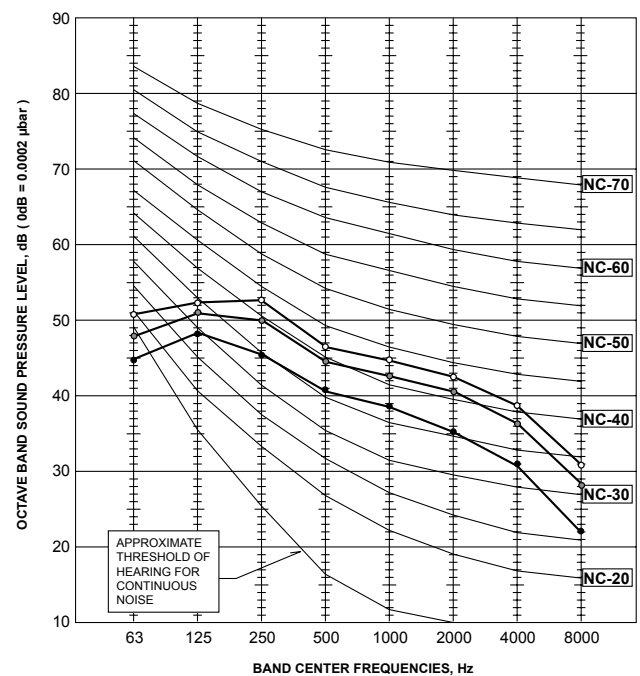

PSA-RP71KA
 PSA-RP100KA
 PSA-RP125KA
 PSA-RP140KA

Unit : mm

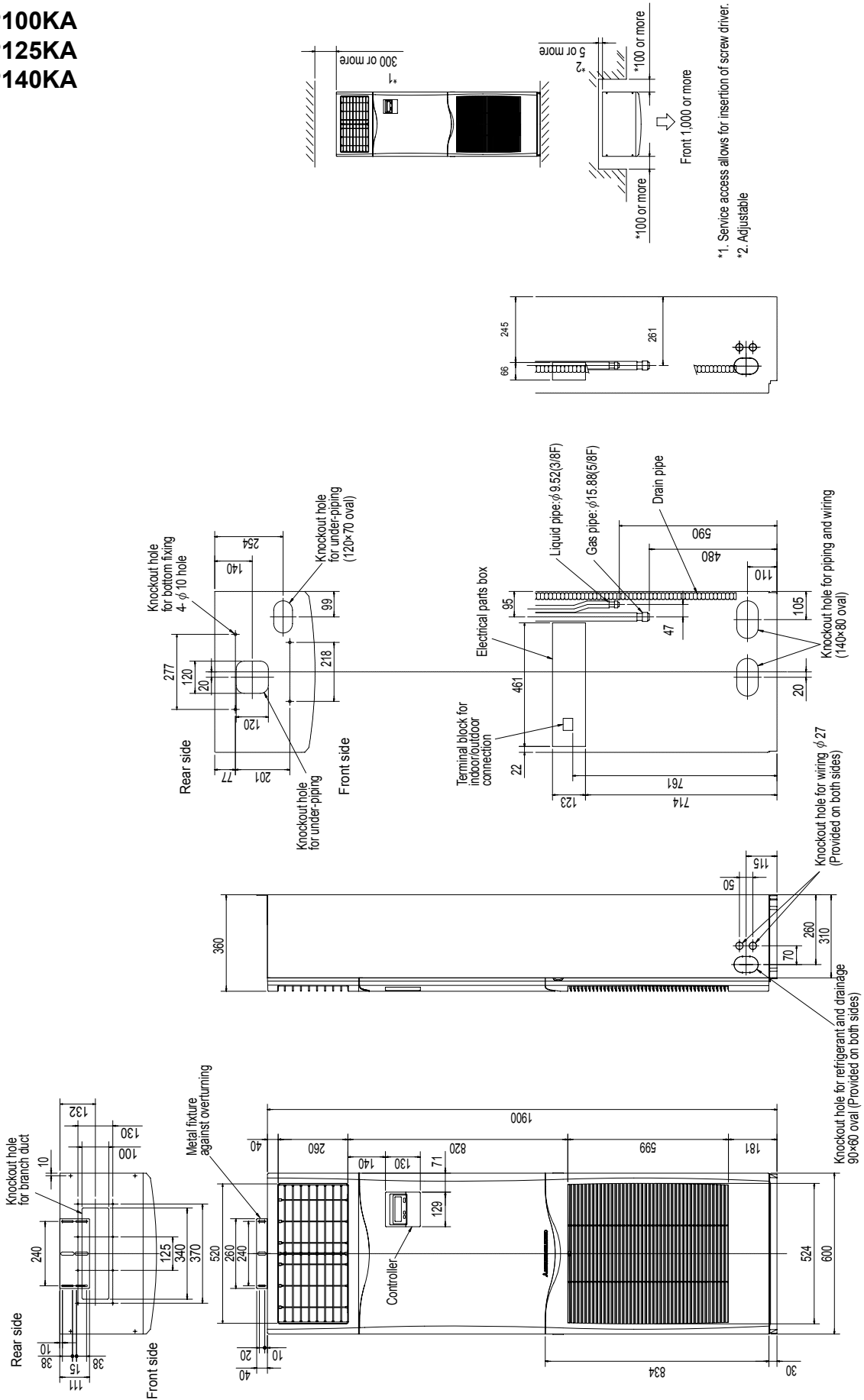

*1. Service access allows for insertion of screw driver.
 *2. Adjustable

PSA-RP71KA
 PSA-RP100KA
 PSA-RP125KA
 PSA-RP140KA

SYMBOL	NAME	SYMBOL	NAME
I.B	INDOOR CONTROLLER BOARD	R.B	WIRED REMOTE CONTROLLER BOARD
FUSE	FUSE (6.3A)	TB6	TERMINAL BLOCK<REMOTE CONTROLLER TRANSMISSION LINE>
CN2L	CONNECTOR<LOSSNAY>	DCL	REACTOR
CN32	CONNECTOR<REMOTE SWITCH>	MF	FAN MOTOR
CN41	CONNECTOR<HA TERMINAL-A>	ML	LOUVER MOTOR
CN51	CONNECTOR<CENTRALLY CONTROL>	TB2	TERMINAL BLOCK option for PSA-RP-KA models.
LED1	POWER SUPPLY<I.B>	TB4	TERMINAL BLOCK <INDOOR/OUTDOOR CONNECTING LINE>
LED2	POWER SUPPLY<R.B>	TH1	ROOM TEMPERATURE THERMISTOR <0°C/15kΩ, 25°C/5.4kΩ DETECT>
LED3	TRANSMISSION<INDOOR-OUTDOOR>	TH2	PIPE TEMPERATURE THERMISTOR/LIQUID <0°C/15kΩ, 25°C/5.4kΩ DETECT>
SW1	SWITCH <MODEL SELECTION> *See Table 1.	TH5	COND./EVA. TEMPERATURE THERMISTOR <0°C/15kΩ, 25°C/5.4kΩ DETECT>
SW2	SWITCH <CAPACITY CODE> *See Table 2.		
SWE	SWITCH<EMERGENCY OPERATION>		
X1	RELAY<LOUVER>		

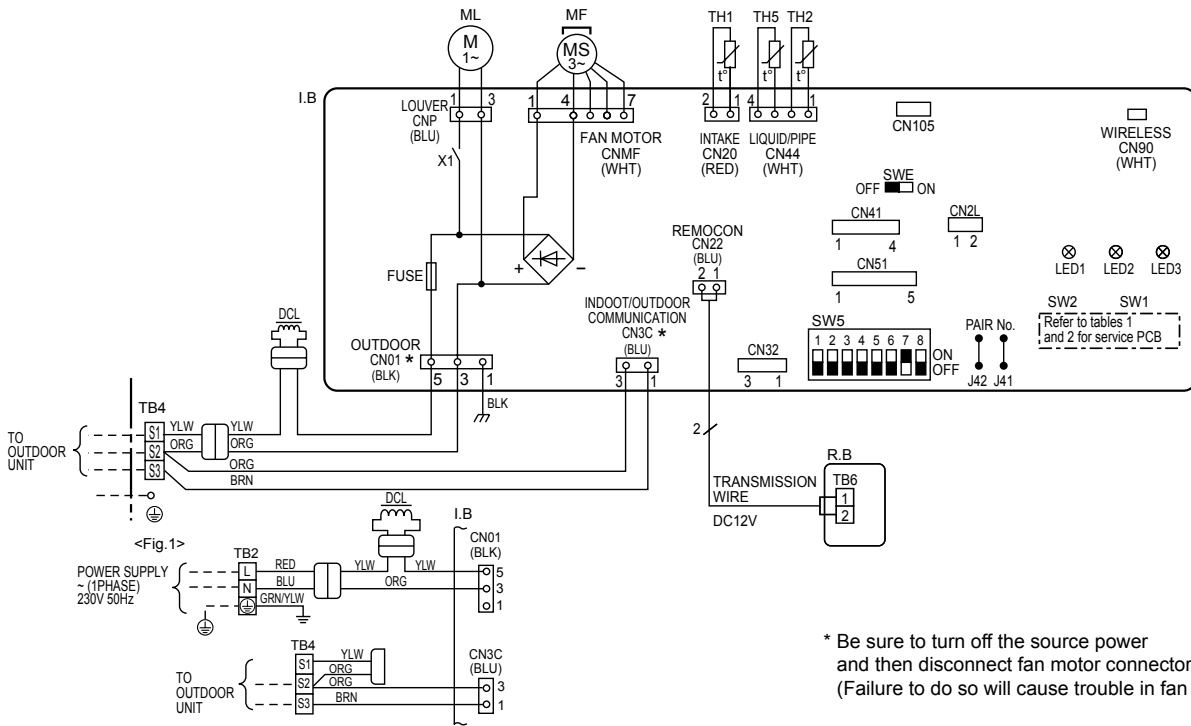

* Be sure to turn off the source power and then disconnect fan motor connector. (Failure to do so will cause trouble in fan motor)

*The black square (■) indicates a switch position.

Table 1

SW1																
MODELS	Manufacture/Service															
PSA-RP-KA	<table border="1"> <tr> <td>1</td><td>2</td><td>3</td><td>4</td><td>5</td> </tr> <tr> <td>■</td><td>■</td><td>■</td><td>■</td><td>■</td> </tr> <tr> <td>ON</td><td>OFF</td><td>OFF</td><td>OFF</td><td>OFF</td> </tr> </table>	1	2	3	4	5	■	■	■	■	■	ON	OFF	OFF	OFF	OFF
1	2	3	4	5												
■	■	■	■	■												
ON	OFF	OFF	OFF	OFF												

Table 2

SW2																
MODELS	Manufacture/Service															
PSA-RP71KA	<table border="1"> <tr> <td>1</td><td>2</td><td>3</td><td>4</td><td>5</td> </tr> <tr> <td>■</td><td>■</td><td>■</td><td>■</td><td>■</td> </tr> <tr> <td>ON</td><td>OFF</td><td>OFF</td><td>OFF</td><td>OFF</td> </tr> </table>	1	2	3	4	5	■	■	■	■	■	ON	OFF	OFF	OFF	OFF
1	2	3	4	5												
■	■	■	■	■												
ON	OFF	OFF	OFF	OFF												
PSA-RP100KA	<table border="1"> <tr> <td>1</td><td>2</td><td>3</td><td>4</td><td>5</td> </tr> <tr> <td>■</td><td>■</td><td>■</td><td>■</td><td>■</td> </tr> <tr> <td>ON</td><td>OFF</td><td>OFF</td><td>OFF</td><td>OFF</td> </tr> </table>	1	2	3	4	5	■	■	■	■	■	ON	OFF	OFF	OFF	OFF
1	2	3	4	5												
■	■	■	■	■												
ON	OFF	OFF	OFF	OFF												
PSA-RP125KA	<table border="1"> <tr> <td>1</td><td>2</td><td>3</td><td>4</td><td>5</td> </tr> <tr> <td>■</td><td>■</td><td>■</td><td>■</td><td>■</td> </tr> <tr> <td>ON</td><td>OFF</td><td>OFF</td><td>OFF</td><td>OFF</td> </tr> </table>	1	2	3	4	5	■	■	■	■	■	ON	OFF	OFF	OFF	OFF
1	2	3	4	5												
■	■	■	■	■												
ON	OFF	OFF	OFF	OFF												
PSA-RP140KA	<table border="1"> <tr> <td>1</td><td>2</td><td>3</td><td>4</td><td>5</td> </tr> <tr> <td>■</td><td>■</td><td>■</td><td>■</td><td>■</td> </tr> <tr> <td>ON</td><td>OFF</td><td>OFF</td><td>OFF</td><td>OFF</td> </tr> </table>	1	2	3	4	5	■	■	■	■	■	ON	OFF	OFF	OFF	OFF
1	2	3	4	5												
■	■	■	■	■												
ON	OFF	OFF	OFF	OFF												

* When work to supply power separately to indoor and outdoor unit was applied, refer to Fig 1. For power supply system of this unit, refer to the caution label located near this diagram.

[NOTES]

1. Symbols used in wiring diagram above are, □: Connector, ⊙: Terminal (block).
2. Indoor and outdoor connecting wires are made with polarities, make wiring matching terminal numbers (S1,S2,S3).
3. Since the outdoor side electric wiring may change be sure to check the outdoor unit electric wiring for servicing.
4. This diagram shows the wiring of indoor and outdoor connecting wires (specification of 230V), adopting superimposed system of power and signal.

PSA-RP71KA
 PSA-RP100KA
 PSA-RP125KA
 PSA-RP140KA

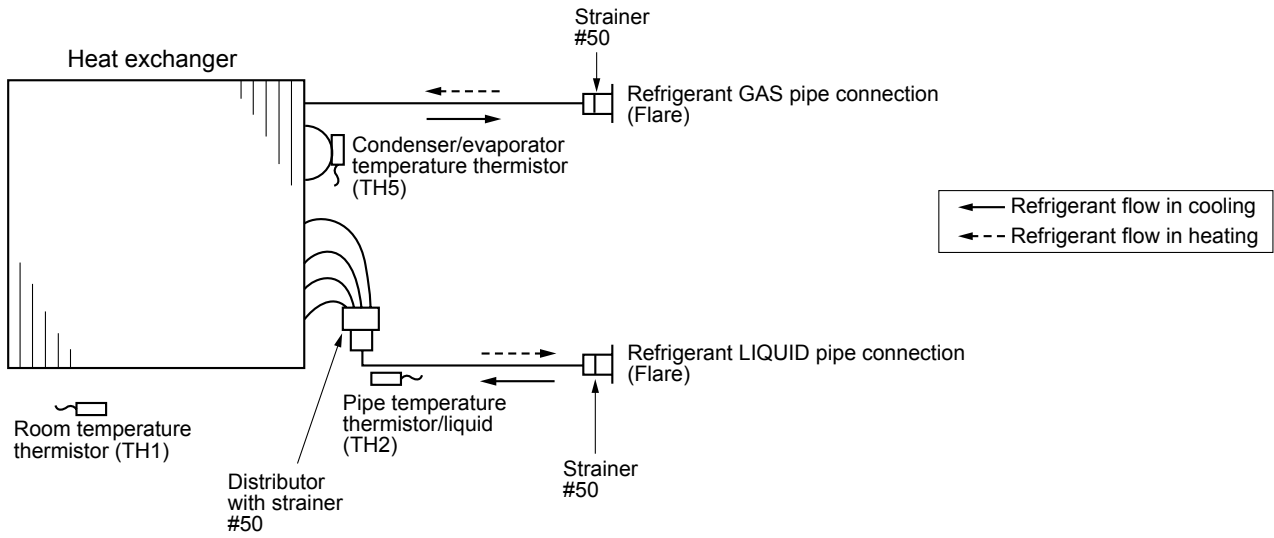

9-1. TROUBLESHOOTING

<Error code display by self-diagnosis and actions to be taken for service (summary)>

Present and past error codes are logged and displayed on the wired remote controller or controller board of outdoor unit. Actions to be taken for service and the trouble reoccurrence at field are summarized in the table below. Check the contents below before investigating details.

Unit conditions at service	Error code	Actions to be taken for service (summary)
The trouble is reoccurring.	Displayed	Judge what is wrong and take a corrective action according to "SELF-DIAGNOSIS ACTION TABLE" (9-2).
	Not displayed	Conduct troubleshooting and ascertain the cause of the trouble according to "TROUBLESHOOTING BY INFERIOR PHENOMENA" (9-3).
The trouble is not reoccurring.	Logged	<ul style="list-style-type: none"> ①Consider the temporary defects such as the work of protection devices in the refrigerant circuit including compressor, poor connection of wiring, noise and etc. Re-check the symptom, and check the installation environment, refrigerant amount, weather when the trouble occurred, and wiring related. ②Reset error code logs and restart the unit after finishing service. ③There is no abnormality in electrical components, controller boards, and remote controller.
	Not logged	<ul style="list-style-type: none"> ①Recheck the abnormal symptom. ②Identify the cause of the trouble and take a corrective action according to "TROUBLESHOOTING BY INFERIOR PHENOMENA" (9-3). ③Continue to operate unit for the time being if the cause is not ascertained. ④There is no abnormality in electrical components, controller boards, remote controller etc.

9-2. SELF-DIAGNOSIS ACTION TABLE

Note: Refer to the manual of outdoor unit for the details of display such as F, U, and other E.

Error Code	Abnormal point and detection method	Cause	Countermeasure
P1	<p>Room temperature thermistor (TH1)</p> <p>① The unit is in 3-minute resume prevention mode if short/open of thermistor is detected. Abnormal if the unit does not reset normally after 3 minutes. (The unit returns to normal operation, if it has been reset normally.)</p> <p>② Constantly detected during cooling, drying, and heating operation. Short: -90°C or more Open: -40°C or less</p>	<p>① Defective thermistor characteristics</p> <p>② Contact failure of connector (CN20) on the indoor controller board (Insert failure)</p> <p>③ Breaking of wire or contact failure of thermistor wiring</p> <p>④ Defective indoor controller board</p>	<p>①—③ Check resistance value of thermistor. 0°C 15.0kΩ 10°C 9.6kΩ 20°C 6.3kΩ 30°C 4.3kΩ 40°C 3.0kΩ</p> <p>If you put force on (draw or bend) the lead wire with measuring resistance value of thermistor, breaking of wire or contact failure can be detected.</p> <p>② Check contact failure of connector (CN20) on the indoor controller board. Refer to 9-6. Turn the power on again and check restart after inserting connector again.</p> <p>④ Check room temperature display on remote controller. Replace indoor controller board if there is abnormal difference with actual room temperature.</p> <p>Turn the power off, and on again to operate after check.</p>
P2	<p>Pipe temperature thermistor/Liquid (TH2)</p> <p>① The unit is in 3-minute resume prevention mode if short/open of thermistor is detected. Abnormal if the unit does not reset normally after 3 minutes. (The unit returns to normal operation, if it has been reset normally.)</p> <p>② Constantly detected during cooling, drying, and heating (except defrosting) operation Short: 90°C or more Open: -40°C or less</p>	<p>① Defective thermistor characteristics</p> <p>② Contact failure of connector (CN44) on the indoor controller board (Insert failure)</p> <p>③ Breaking of wire or contact failure of thermistor wiring</p> <p>④ Defective refrigerant circuit is causing thermistor temperature of 90°C or more or -40°C or less.</p> <p>⑤ Defective indoor controller board</p>	<p>①—③ Check resistance value of thermistor. For characteristics, refer to (P1) above.</p> <p>② Check contact failure of connector (CN44) on the indoor controller board. Refer to 9-6. Turn the power on and check restart after inserting connector again.</p> <p>④ Check pipe <liquid> temperature with remote controller in test run mode. If pipe <liquid> temperature is extremely low (in cooling mode) or high (in heating mode), refrigerant circuit may have defective.</p> <p>⑤ Check pipe <liquid> temperature with remote controller in test run mode. If there is extremely difference with actual pipe <liquid> temperature, replace indoor controller board.</p> <p>Turn the power off, and on again to operate after check.</p>
P6	<p>Freezing/overheating protection is operating</p> <p>① Freezing protection (Cooling mode) The unit is in 6-minute resume prevention mode if pipe <liquid or condenser/evaporator> temperature stays under -15°C for 3 minutes, 3 minutes after the compressor started. Abnormal if it stays under -15°C for 3 minutes again within 16 minutes after 6-minute resume prevention mode.</p> <p>② Overheating protection (Heating mode) The units is in 6 minute resume prevention mode if pipe <condenser / evaporator> temperature is detected as over 70°C after the compressor started. Abnormal if the temperature of over 70°C is detected again within 30 minutes after 6 minute resume prevention mode.</p>	<p>(Cooling or drying mode)</p> <p>① Clogged filter (reduced airflow)</p> <p>② Short cycle of air path</p> <p>③ Low-load (low temperature) operation out of the tolerance range</p> <p>④ Defective indoor fan motor • Fan motor is defective. • Indoor controller board is defective.</p> <p>⑤ Defective outdoor fan control</p> <p>⑥ Overcharge of refrigerant</p> <p>⑦ Defective refrigerant circuit (clogs)</p> <p>(Heating mode)</p> <p>① Clogged filter (reduced airflow)</p> <p>② Short cycle of air path</p> <p>③ Over-load (high temperature) operation out of the tolerance range</p> <p>④ Defective indoor fan motor • Fan motor is defective. • Indoor controller board is defective.</p> <p>⑤ Defective outdoor fan control</p> <p>⑥ Overcharge of refrigerant</p> <p>⑦ Defective refrigerant circuit (clogs)</p> <p>⑧ Bypass circuit of outdoor unit is defective.</p>	<p>(Cooling or drying mode)</p> <p>① Check clogs of the filter.</p> <p>② Remove blockage.</p> <p>④ Refer to 9-6.</p> <p>⑤ Check outdoor fan motor.</p> <p>⑥⑦ Check operating condition of refrigerant circuit.</p> <p>(Heating mode)</p> <p>① Check clogs of the filter.</p> <p>② Remove blockage.</p> <p>④ Refer to 9-6.</p> <p>⑤ Check outdoor fan motor.</p> <p>⑥~⑧ Check operating condition of refrigerant circuit.</p>



Error Code	Abnormal point and detection method	Cause	Countermeasure
P8	<p>Pipe temperature <Cooling mode> Detected as abnormal when the pipe temperature is not in the cooling range 3 minutes after compressor start and 6 minutes after the liquid or condenser/evaporator pipe is out of cooling range. Note 1) It takes at least 9 minutes to detect. Note 2) Abnormality P8 is not detected in drying mode. Cooling range : $-3\text{ }^{\circ}\text{C} \geq (\text{TH}-\text{TH1})$ TH: Lower temperature between: liquid pipe temperature (TH2) and condenser/evaporator temperature (TH5) TH1: Intake temperature</p> <p><Heating mode> When 10 seconds have passed after the compressor starts operation and the hot adjustment mode has finished, the unit is detected as abnormal when condenser/evaporator pipe temperature is not in heating range within 20 minutes.</p> <p>Note 3) It takes at least 27 minutes to detect abnormality. Note 4) It excludes the period of defrosting. (Detection restarts when defrosting mode is over.) Heating range : $3\text{ }^{\circ}\text{C} \leq (\text{TH5}-\text{TH1})$</p>	<p>① Slight temperature difference between indoor room temperature and pipe <liquid or condenser / evaporator> temperature thermistor</p> <ul style="list-style-type: none"> • Shortage of refrigerant • Disconnected holder of pipe <liquid or condenser / evaporator> thermistor • Defective refrigerant circuit <p>② Converse connection of extension pipe (on plural units connection)</p> <p>③ Converse wiring of indoor/outdoor unit connecting wire (on plural units connection)</p> <p>④ Defective detection of indoor room temperature and pipe <condenser / evaporator> temperature thermistor</p> <p>⑤ Stop valve is not opened completely.</p>	<p>①~④ Check pipe <liquid or condenser / evaporator> temperature with room temperature display on remote controller and outdoor controller circuit board. Pipe <liquid or condenser / evaporator> temperature display is indicated by setting SW2 of outdoor controller circuit board as follows.</p> <p>(Conduct temperature check with outdoor controller circuit board after connecting 'A-Control Service Tool(PAC-SK52ST)')</p> <p>②③ Check converse connection of extension pipe or converse wiring of indoor/outdoor unit connecting wire.</p>
P9	<p>Pipe temperature thermistor / Condenser-Evaporator (TH5)</p> <p>① The unit is in 3-minute resume protection mode if short/open of thermistor is detected. Abnormal if the unit does not get back to normal within 3 minutes. (The unit returns to normal operation, if it has been reset normally.)</p> <p>② Constantly detected during cooling, drying, and heating operation (except defrosting) Short: 90°C or more Open: -40°C or less</p>	<p>① Defective thermistor characteristics</p> <p>② Contact failure of connector (CN44) on the indoor controller board (Insert failure)</p> <p>③ Breaking of wire or contact failure of thermistor wiring</p> <p>④ Temperature of thermistor is 90°C or more or -40°C or less caused by defective refrigerant circuit.</p> <p>⑤ Defective indoor controller board</p>	<p>①~③ Check resistance value of thermistor. For characteristics, refer to (P1) above.</p> <p>② Check contact failure of connector (CN44) on the indoor controller board. Refer to 9-7. Turn the power on and check restart after inserting connector again.</p> <p>④ Operate in test run mode and check pipe <condenser / evaporator> temperature with outdoor controller circuit board. If pipe <condenser / evaporator> temperature is extremely low (in cooling mode) or high (in heating mode), refrigerant circuit may have defect.</p> <p>⑤ Operate in test run mode and check pipe <condenser / evaporator> temperature with outdoor control circuit board. If there is extreme difference with actual pipe <condenser / evaporator> temperature, replace indoor controller board. There is no abnormality if none of above comes within the unit. Turn the power off and on again to operate.</p> <p>(In case of checking pipe temperature with outdoor controller circuit board, be sure to connect A-control service tool (PAC-SK52ST).)</p>



Error Code	Abnormal point and detection method	Cause	Countermeasure
E0 or E4	<p>Remote controller transmission error(E0)/signal receiving error(E4)</p> <p>① Abnormal if main or sub remote controller cannot receive any transmission normally from indoor unit of refrigerant address "0" for 3 minutes. (Error code : E0)</p> <p>② Abnormal if sub remote controller could not receive any signal for 2 minutes. (Error code: E0)</p> <p>① Abnormal if indoor controller board can not receive any data normally from remote controller board or from other indoor controller board for 3 minutes. (Error code: E4)</p> <p>② Indoor controller board cannot receive any signal from remote controller for 2 minutes. (Error code: E4)</p>	<p>① Contact failure at transmission wire of remote controller</p> <p>② All remote controllers are set as "sub" remote controller. In this case, E0 is displayed on remote controller, and E4 is displayed at LED (LED1, LED2) on the outdoor controller circuit board.</p> <p>③ Miswiring of remote controller</p> <p>④ Defective transmitting receiving circuit of remote controller</p> <p>⑤ Defective transmitting receiving circuit of indoor controller board of refrigerant addresses "0".</p> <p>⑥ Noise has entered into the transmission wire of remote controller.</p>	<p>① Check disconnection or looseness of indoor unit or transmission wire of remote controller.</p> <p>② Set one of the remote controllers "main" if there is no problem with the action above.</p> <p>③ Check wiring of remote controller.</p> <ul style="list-style-type: none"> • Total wiring length: max. 500m (Do not use cable x 3 or more.) • The number of connecting indoor units: max. 16 units • The number of connecting remote controller: max. 2 units <p>When it is not the above-mentioned problem of ①~③</p> <p>④ Diagnose remote controllers.</p> <p>a) When "RC OK" is displayed, Remote controllers have no problem. Turn the power off, and on again to check. If abnormality generates again, replace indoor controller board.</p> <p>b) When "RC NG" is displayed, Replace remote controller.</p> <p>c) When "RC E3" or "ERC 00-66" is displayed, noise may be causing abnormality.</p> <p>* If the unit is not normal after replacing indoor controller board in group control, indoor controller board of address "0" may be abnormal.</p>
E3 or E5	<p>Remote controller transmission error(E3)/signal receiving error(E5)</p> <p>① Abnormal if remote controller could not find blank of transmission path for 6 seconds and could not transmit. (Error code: E3)</p> <p>② Remote controller receives transmitted data at the same time and compares the received and transmitted data. Abnormal if these data are judged to be different 30 continuous times. (Error code: E3)</p> <p>① Abnormal if indoor controller board could not find blank of transmission path. (Error code: E5)</p> <p>② Indoor controller board receives transmitted data at the same time and compares the received and transmitted data. Abnormal if these data are judged to be different 30 continuous times. (Error code: E5)</p>	<p>① 2 remote controllers are set as "main." (In case of 2 remote controllers)</p> <p>② Remote controller is connected with 2 indoor units or more.</p> <p>③ Repetition of refrigerant address</p> <p>④ Defective transmitting receiving circuit of remote controller</p> <p>⑤ Defective transmitting receiving circuit of indoor controller board</p> <p>⑥ Noise has entered into transmission wire of remote controller.</p>	<p>① Set a remote controller to main, and the other to sub.</p> <p>② Remote controller is connected with only one indoor unit.</p> <p>③ The address changes to a separate setting.</p> <p>④~⑥ Diagnose remote controller.</p> <p>a) When "RC OK" is displayed, remote controllers have no problem. Turn the power off, and on again to check. When becoming abnormal again, replace indoor controller board.</p> <p>b) When "RC NG" is displayed, replace remote controller.</p> <p>c) When "RC E3" or "ERC 00-66" is displayed, noise may be causing abnormality.</p>
E6	<p>Indoor/outdoor unit communication error (Signal receiving error)</p> <p>① Abnormal if indoor controller board can not receive any signal normally for 6 minutes after turning the power on.</p> <p>② Abnormal if indoor controller board can not receive any signal normally for 3 minutes.</p> <p>③ Consider the unit abnormal under the following condition: When 2 or more indoor units are connected to an outdoor unit, indoor controller board cannot receive a signal for 3 minutes from outdoor controller circuit board, a signal which allows outdoor controller circuit board to transmit signals.</p>	<p>① Contact failure, short circuit or, miswiring (converse wiring) of indoor/outdoor unit connecting wire</p> <p>② Defective transmitting receiving circuit of indoor controller board</p> <p>③ Defective transmitting receiving circuit of indoor controller board</p> <p>④ Noise has entered into indoor/outdoor unit connecting wire.</p>	<p>* Check LED display on the outdoor control circuit board. (Connect A-control service tool, PAC-SK52ST.) Refer to outdoor unit service manual.</p> <p>① Check disconnection or looseness of indoor/ outdoor unit connecting wire of indoor/ outdoor unit. Check all the units in case of twin triple indoor unit system.</p> <p>②-④ Turn the power off, and on again to check. If abnormality generates again, replace indoor controller board or outdoor controller circuit board.</p> <p>* Other indoor controller board may have defect in case of twin triple indoor unit system.</p>



Error Code	Abnormal point and detection method	Cause	Countermeasure
E7	Indoor/outdoor unit communication error (Transmitting error) Abnormal if "1" receiving is detected 30 times continuously though indoor controller board has transmitted "0".	① Defective transmitting receiving circuit of indoor controller board ② Noise has entered into power supply. ③ Noise has entered into outdoor control wire.	①-③ Turn the power off, and on again to check. If abnormality generates again, replace indoor controller board.
Fb	Indoor controller board Abnormal if data cannot be read normally from the nonvolatile memory of the indoor controller board.	① Defective indoor controller board	① Replace indoor controller board.
E1 or E2	Remote controller control board ① Abnormal if data cannot be read normally from the nonvolatile memory of the remote controller control board. (Error code: E1) ② Abnormal if the clock function of remote controller cannot be operated normally. (Error code: E2)	① Defective remote controller	① Replace remote controller.
PA	Forced compressor stop (due to water leakage abnormality) ① When the intake temperature subtracted with liquid pipe temperature is less than -10°C, drain sensor is detected whether it is soaked in the water or not at the interval of 90 seconds. (Drain pump will start operating when the drain sensor is detected to be soaked in the water.) ② The unit has a water leakage abnormality when the following conditions, a and b, are satisfied while the above-mentioned detection is performed. a) The drain sensor is detected to be soaked in the water 10 times in a row. b) The intake temperature subtracted with liquid pipe temperature is detected to be less than -10°C for a total of 30 minutes. (When the drain sensor is detected to be NOT soaked in the water, the detection record of a and b will be cleared.) ③ The drain sensor detection is performed in operations other than cooling. (When the unit stops operating, during heating or fan operation, when the unit stops because of some abnormality) *Once the water leakage abnormality is detected, abnormality state will not be released until the main power is reset.	① Drain pump trouble ② Drain defective · Drain pump clogging · Drain pipe clogging ③ Open circuit of drain sensor side heater ④ Contact failure of drain sensor connector ⑤ Dew condensation on drain sensor · Drain water descends along lead wire. · Drain water waving due to filter clogging. ⑥ Extension piping connection difference at twin, triple, quadruple system. ⑦ Mis-wiring of indoor/ outdoor connecting at twin, triple, quadruple system. ⑧ Room temperature thermistor/ liquid pipe temperature thermistor detection is defective.	① Check the drain pump. ② Please confirm whether water can be drained. ③ Confirm the resistance of the drain sensor. ④ Check the connector contact failure. ⑤ Check the drain sensor leadwire mounted. Check the filter clogging ⑥ Check the piping connection. ⑦ Check the indoor/ outdoor connecting wires. ⑧ Check the room temperature display of remote controller. Check the indoor liquid pipe temperature display of outdoor controller board.
PL	Abnormal refrigerant circuit During Cooling, Dry, or Auto Cooling operation, when the following are regarded as failures when detected for one second. a)The compressor continues to run for 30 or more seconds. b)The liquid pipe temperature or the condense/evaporator temperature is 75°C or more. *These detected errors will not be cancelled until the power source is reset.	① Abnormal operation of 4-way valve ② Disconnection of or leakage in refrigerant pipes ③ Air into refrigerant piping ④ Abnormal operation (no rotation) of indoor fan · Defective fan motor. · Defective indoor control board. ⑤ Defective refrigerant circuit (clogging)	① <u>When this error occurs, be sure to replace the 4-way valve.</u> ② Check refrigerant pipes for disconnection or leakage. ③ After the recovery of refrigerant, vacuum dry the whole refrigerant circuit. ④ Refer to section 10-6-2. ⑤ Check refrigerant circuit for operation. *To avoid entry of moisture or air into refrigerant circuit which could cause abnormal high pressure, purge air in refrigerant circuit or replace refrigerant.

9-3. TROUBLESHOOTING BY INFERIOR PHENOMENA

Note: Refer to the manual of outdoor unit for the detail of remote controller.

Phenomena	Cause	Countermeasure
<p>(1) LED2 on indoor controller board is off.</p>	<ul style="list-style-type: none"> • When LED1 on indoor controller board is also off. ① Power supply of rated voltage is not supplied to outdoor unit. ② Defective outdoor controller circuit board. ③ Power supply of 220~240V is not supplied to indoor unit. ④ Defective indoor power board. ⑤ Defective indoor controller board. <p>(For the separate indoor/outdoor unit power supply system)</p> <ul style="list-style-type: none"> ① Power supply of 220~240V AC is not supplied to indoor unit. ② The connectors of the optional replacement kit are not used. ③ Defective indoor controller board. ④ Defective indoor power board. 	<ul style="list-style-type: none"> ① Check the voltage of outdoor power supply terminal block (L, N) or (L3, N). <ul style="list-style-type: none"> • When AC 220~240V is not detected. Check the power wiring to outdoor unit and the breaker. • When AC 220~240V is detected. —Check ② (below). ② Check the voltage between outdoor terminal block S1 and S2. <ul style="list-style-type: none"> • When AC 220~240V is not detected. Check the fuse on outdoor controller circuit board. • When AC 220~240V is detected. Check the wiring connection. —Check ③ (below). ③ Check the voltage between indoor terminal block S1 and S2. <ul style="list-style-type: none"> • When AC 220~240V is not detected. Check indoor/outdoor unit connecting wire for mis-wiring. • When AC 220~240V is detected. —Check ④ (below). ④ Check voltage output from CN2S on indoor power board (DC13.1V). Refer to 10-6-1. <ul style="list-style-type: none"> • When no voltage is output. Check the wiring connection. • When output voltage is between DC12.5V and DC13.7V. —Check ⑤ (below). ⑤ Check the wiring connection between indoor controller board and indoor power board. Check the fuse on indoor controller board. If no problems are found, indoor controller board is defective. <ul style="list-style-type: none"> ① Check the voltage of indoor power supply terminal block (L,N). <ul style="list-style-type: none"> • When AC220~240V is not detected. Check the power supply wiring. • When AC220~240V is detected. —Check ② (below). ② Check that there is no problem in the method of connecting the connectors. <ul style="list-style-type: none"> • When there are problems in the method of connecting the connectors. Connect the connector correctly referring to installation manual of an optional kit. • When there is no problem in the method of connecting the connectors. —Check ③ (below). ③ Check voltage output from CNDK on indoor controller board. <ul style="list-style-type: none"> • When AC220~240V is not detected. Check the fuse on indoor controller board. Check the wiring connection between indoor power supply terminal block and CND on indoor controller board. • When AC220~240V is detected. —Check ④ (below). ④ Check voltage output from CN2S on indoor power board. <ul style="list-style-type: none"> • When no voltage output. Check the wiring connection between CNDK on indoor controller board and CNSK on indoor power board. If no problem are found, indoor power board is defective. • When DC12.5~13.7V is detected. Check the wiring connection between CN2S on indoor power board and CN2D on indoor power board. If no problem are found, indoor controller board is defective.
	<ul style="list-style-type: none"> • When LED1 on indoor controller board is lit. ① Mis-setting of refrigerant address for outdoor unit (There is no unit corresponding to refrigerant address "0".) 	<ul style="list-style-type: none"> ① Reconfirm the setting of refrigerant address for outdoor unit. Set the refrigerant address to "0". (For grouping control system under which 2 or more outdoor units are connected, set one of the units to "0".) Set refrigerant address using SW1 (3-6) on outdoor controller circuit board.

Note: Refer to the manual of outdoor unit for the detail of remote controller.

Phenomena	Cause	Countermeasure
(2) LED2 on indoor controller board is blinking.	<ul style="list-style-type: none"> When LED1 on indoor controller board is also blinking. Connection failure of indoor/outdoor unit connecting wire 	Check indoor/outdoor unit connecting wire for connection failure.
	<ul style="list-style-type: none"> When LED1 is lit. ① Mis-wiring of remote controller wires Under twin triple indoor unit system, 2 or more indoor units are wired together. ② Refrigerant address for outdoor unit is wrong or not set. Under grouping control system, there are some units whose refrigerant address is 0. ③ Short-cut of remote controller wires ④ Defective remote controller 	<ul style="list-style-type: none"> ① Check the connection of remote controller wires in case of twin triple indoor unit system. When 2 or more indoor units are wired in one refrigerant system, connect remote controller wires to one of those units. ② Check the setting of refrigerant address in case of grouping control system. If there are some units whose refrigerant addresses are 0 in one group, set one of the units to 0 using SW1 (3-6) on outdoor controller circuit board. ③④ Remove remote controller wires and check LED2 on indoor controller board. <ul style="list-style-type: none"> When LED2 is blinking, check the short-cut of remote controller wires. When LED2 is lit, connect remote controller wires again and: if LED2 is blinking, remote controller is defective; if LED2 is lit, connection failure of remote controller terminal block etc. has returned to normal.
(3) Upward/downward vane performance failure	<ul style="list-style-type: none"> ① The vane is not downward during defrosting and heat preparation and when the thermostat is OFF in HEAT mode. (Working of COOL protection function) ② Vane motor does not rotate. <ul style="list-style-type: none"> Defective vane motor Breaking of wire or connection failure of connector Up/down vane setting is "No vanes". ③ Upward/downward vane does not work. <ul style="list-style-type: none"> The vane is set to fixed position. 	<ul style="list-style-type: none"> ① Normal operation (The vane is set to horizontal regardless of remote control.) ② Check ② (left). <ul style="list-style-type: none"> Check the vane motor. (Refer to "How to check the parts".) Check for breaking of wire or connection failure of connector. Check "Up/down vane setting". (Unit function selection by remote controller). ③ Normal operation (Each connector on vane motor side is disconnected.)
(4) Receiver for wireless remote controller	<ul style="list-style-type: none"> ① Weak batteries of wireless remote controller. ② Contact failure of connector (CNB) on wireless remote controller board. (Insert failure) ③ Contact failure of connector (CN90) on indoor controller board. (Insert failure) ④ Contact failure of connector between wireless remote controller board and indoor controller board. 	<ul style="list-style-type: none"> ① Replace batteries of wireless remote controller. ②~④ Check contact failure of each connector. If no problems are found of connector, replace indoor controller board. When the same trouble occurs even if indoor controller board is replaced, replace wireless remote controller board.

9-4. HOW TO CHECK THE PARTS

PSA-RP71KA

PSA-RP100KA

PSA-RP125KA

PSA-RP140KA

Parts name	Check points				
Room temperature thermistor (TH1) Pipe temperature thermistor (TH2) Condenser/evaporator temperature thermistor (TH5)	Disconnect the connector then measure the resistance with a tester. (Surrounding temperature 10°C~30°C) <table border="1" style="margin-left: 20px;"> <thead> <tr> <th>Normal</th> <th>Abnormal</th> </tr> </thead> <tbody> <tr> <td>4.3kΩ~9.6kΩ</td> <td>Open or short</td> </tr> </tbody> </table> (Refer to "9-4-1. Thermistor" for a detail.)	Normal	Abnormal	4.3kΩ~9.6kΩ	Open or short
Normal	Abnormal				
4.3kΩ~9.6kΩ	Open or short				
Louver motor(ML)	Measure the resistance between the terminals with a tester. (Surrounding temperature 25°C) <table border="1" style="margin-left: 20px;"> <thead> <tr> <th>Normal</th> <th>Abnormal</th> </tr> </thead> <tbody> <tr> <td>11000~13000Ω</td> <td>Open or short</td> </tr> </tbody> </table>	Normal	Abnormal	11000~13000Ω	Open or short
Normal	Abnormal				
11000~13000Ω	Open or short				

9-4-1. Thermistor

<Thermistor Characteristic graph>

Thermistor for lower temperature

- Room temperature thermistor (TH1)
- Pipe temperature thermistor (TH2)
- Condenser/evaporator temperature thermistor (TH5)

Thermistor $R_0 = 15k\Omega \pm 3\%$
 Fixed number of $B = 3480 \pm 2\%$

$$R_t = 15 \exp \left\{ 3480 \left(\frac{1}{273+t} - \frac{1}{273} \right) \right\}$$

0°C	15kΩ
10°C	9.6kΩ
20°C	6.3kΩ
25°C	5.4kΩ
30°C	4.3kΩ
40°C	3.0kΩ

< Thermistor for lower temperature >

9-4-2. DC Fan motor (FAN MOTOR/ INDOOR CONTROLLER BOARD)

Check method of DC fan motor (fan motor / indoor controller circuit board)

① Notes

- High voltage is applied to the connector (CNMF) for the fan motor. Pay attention to the service.
- Do not pull out the connector (CNMF) for the motor with the power supply on.
 (It causes trouble to the indoor controller circuit board and fan motor.)

② Self check

Symptom : The indoor fan cannot rotate.

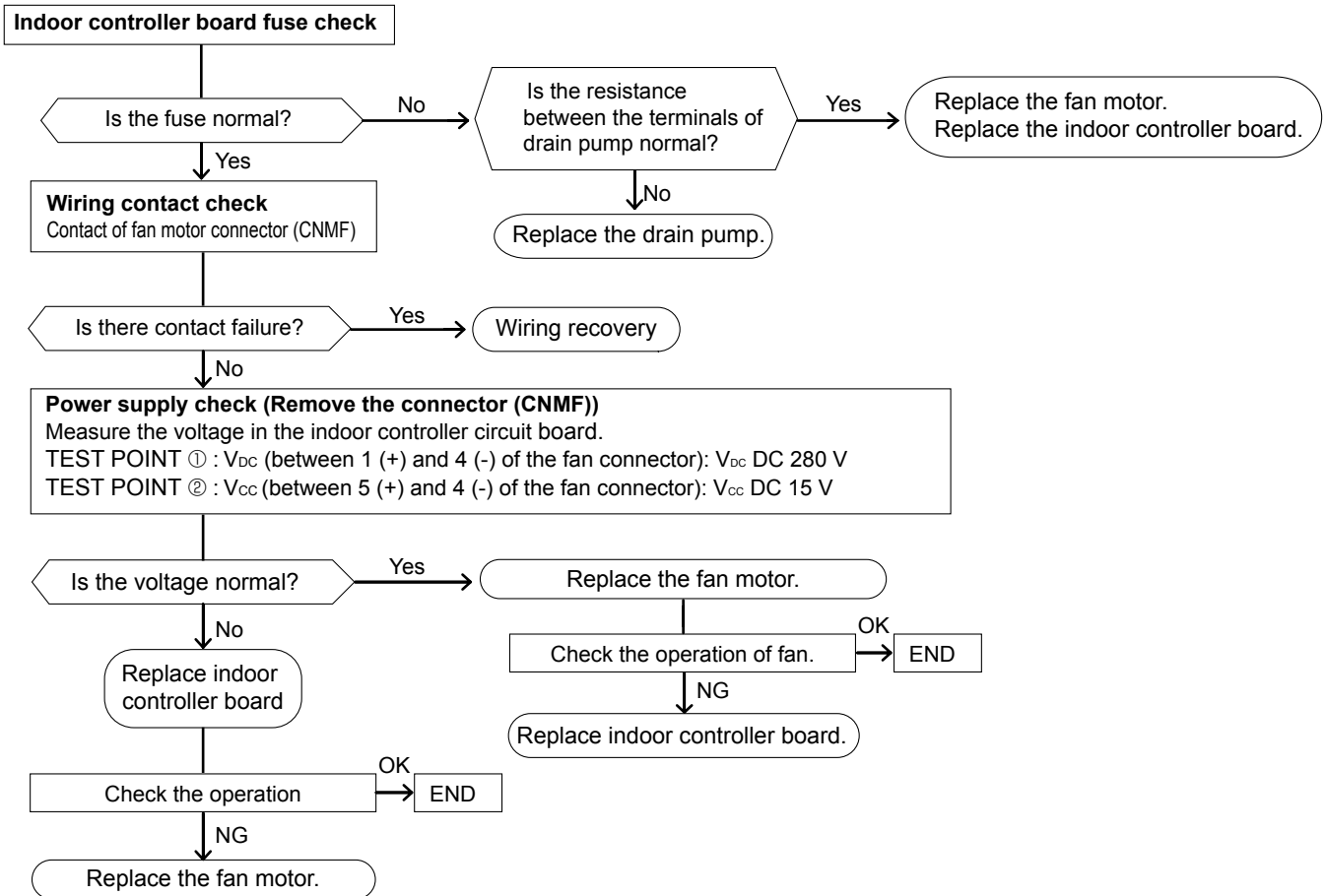

9-5. TEST POINT DIAGRAM
Indoor controller board
PSA-RP71KA
PSA-RP100KA
PSA-RP125KA
PSA-RP140KA

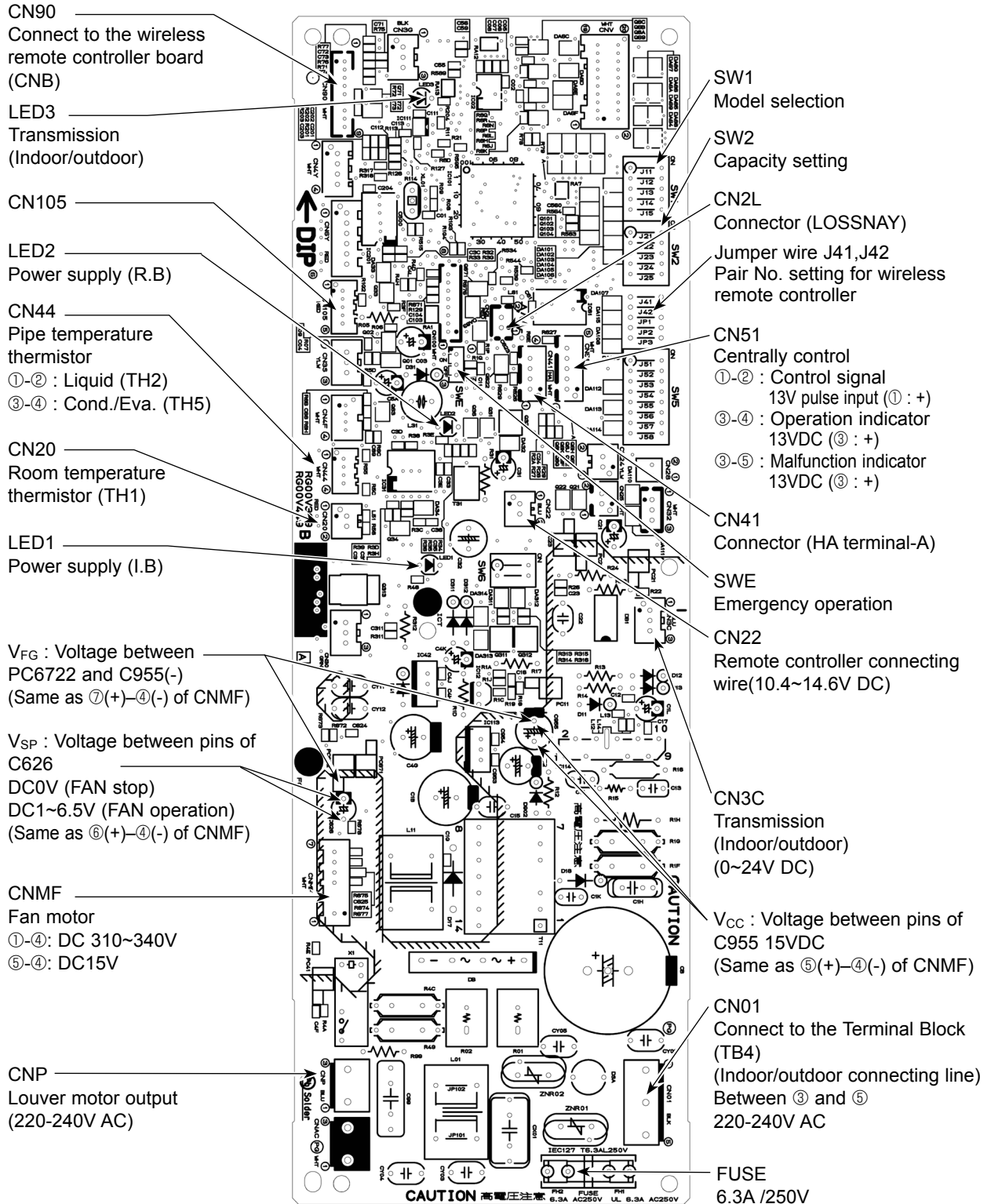











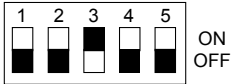



9-6. FUNCTIONS OF DIP SWITCH AND JUMPER WIRE

Each function is controlled by the dip switch and the jumper wire on control P.C. board.

Model setting and capacity setting are memorized in the nonvolatile memory of the control P.C. board of the unit.

(Marks in the table below) Jumper wire (○ : Short × : Open)

Jumper wire	Functions	Setting by the dip switch and jumper wire	Remarks																	
SW1	Model settings	For service board 																		
SW2	Capacity settings	<table border="1"> <thead> <tr> <th>MODELS</th> <th>Manufacture/Service</th> </tr> </thead> <tbody> <tr> <td>PSA-RP71KA</td> <td>  </td> </tr> <tr> <td>PSA-RP100KA</td> <td>  </td> </tr> <tr> <td>PSA-RP125KA</td> <td>  </td> </tr> <tr> <td>PSA-RP140KA</td> <td>  </td> </tr> </tbody> </table>	MODELS	Manufacture/Service	PSA-RP71KA		PSA-RP100KA		PSA-RP125KA		PSA-RP140KA									
MODELS	Manufacture/Service																			
PSA-RP71KA																				
PSA-RP100KA																				
PSA-RP125KA																				
PSA-RP140KA																				
J41 J42	Pair number setting with wireless remote controller	<table border="1"> <thead> <tr> <th rowspan="2">Wireless remote controller setting</th> <th colspan="2">Control PCB setting</th> </tr> <tr> <th>J41</th> <th>J42</th> </tr> </thead> <tbody> <tr> <td>0</td> <td>○</td> <td>○</td> </tr> <tr> <td>1</td> <td>×</td> <td>○</td> </tr> <tr> <td>2</td> <td>○</td> <td>×</td> </tr> <tr> <td>3 ~ 9</td> <td>×</td> <td>×</td> </tr> </tbody> </table>	Wireless remote controller setting	Control PCB setting		J41	J42	0	○	○	1	×	○	2	○	×	3 ~ 9	×	×	<p><Initial setting> Wireless remote controller: 0 Control PCB: ○ (for both J41 and J42) Four pair number settings are supported. The pair number settings of the wireless remote controller and indoor control PCB (J41/J42) are given in the table on the left. ('×' in the table indicates the jumper line is disconnected.)</p>
Wireless remote controller setting	Control PCB setting																			
	J41	J42																		
0	○	○																		
1	×	○																		
2	○	×																		
3 ~ 9	×	×																		
JP1	Unit type setting	<table border="1"> <thead> <tr> <th>Model</th> <th>JP1</th> </tr> </thead> <tbody> <tr> <td>Without TH5</td> <td>○</td> </tr> <tr> <td>With TH5</td> <td>×</td> </tr> </tbody> </table>	Model	JP1	Without TH5	○	With TH5	×	There is no jumper (JP1) because these models have the cond./eva. temperature thermistor (TH5).											
Model	JP1																			
Without TH5	○																			
With TH5	×																			
JP3	Indoor controller board type setting	<table border="1"> <thead> <tr> <th>Indoor controller board type</th> <th>JP3</th> </tr> </thead> <tbody> <tr> <td>For product</td> <td>○</td> </tr> <tr> <td>Service parts</td> <td>○</td> </tr> </tbody> </table>	Indoor controller board type	JP3	For product	○	Service parts	○												
Indoor controller board type	JP3																			
For product	○																			
Service parts	○																			

10-1. ROTATION FUNCTION (AND BACK-UP FUNCTION, 2ND STAGE CUT-IN FUNCTION)

For PSA-RP71/100/125/140KA

10-1-1. Operation

(1) Rotation function (and Back-up function)

• Outline of functions

- Main and sub unit operate alternately according to the interval of rotation setting.
- ※ Main and sub unit should be set by refrigerant address. (Outdoor Dip switch setting)
 Refrigerant address "00" → Main unit
 Refrigerant address "01" → Sub unit
- When error occurs to one unit, another unit will start operation. (Back-up function)

• System constraint

- This function is available only by the grouping control system (INDOOR UNIT : OUTDOOR UNIT=1:1) of 2 refrigerant groups. (Refer to Fig. 1)
- Main indoor unit should be connected for wired remote controller and the transmission line (TB5) for main and sub unit should also be connected. (Refer to Fig. 1)
 (This function cannot be set by wireless remote controller.)
- Set refrigerant address of each unit. (Dip switch on the outdoor unit→Refrigerant address 00/01)

Operation pattern

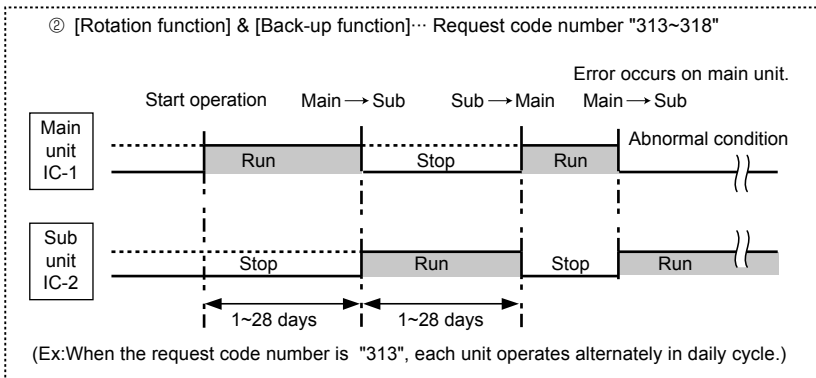
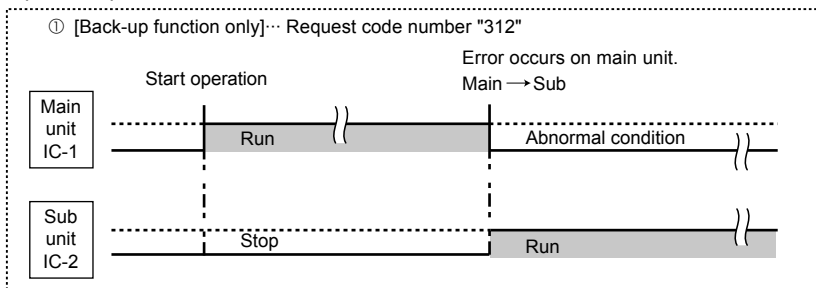

Note:

- When the unit is restarted to operate after turning off the power or OFF operation, the unit which was operating will start operation.
- To operate the main unit, refer to the 10-1-2. and set the request code No. which is not the same as the current one, and set again the former request code No.

(2) 2nd stage cut-in function

• Outline of functions

- Number of operating units is determined according to the room temperature and set point.
- When room temperature becomes higher than set point, standby unit starts. (2 units operation)
- When room temperature falls below set point -4°C, standby unit stops. (1 unit operation)

• System constraint

- This function is available only in rotation operation and back-up function in cooling mode.

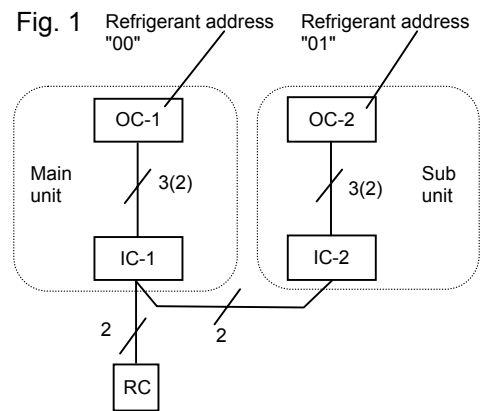
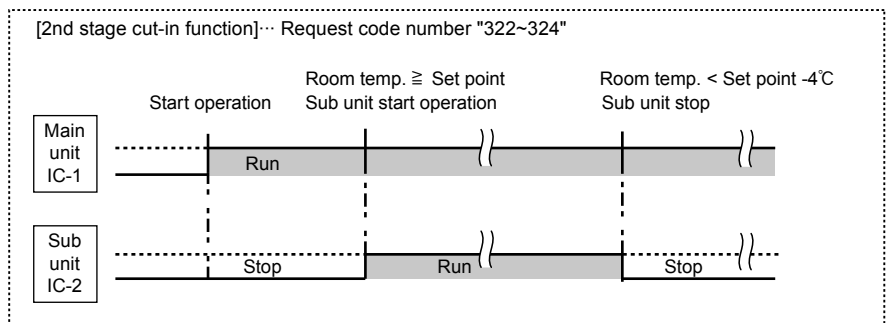

OC : Outdoor unit
 IC : Indoor unit
 RC : Wired remote controller

10-1-2. How to set rotation function (Back-up function, 2nd stage cut-in function)

You can set these functions by wired remote controller. (Maintenance monitor)

NOTICE

Both main and sub unit should be set in same setting.
Every time replacing indoor controller board for servicing, the function should be set again.

(1) Request Code List

Rotation setting

Setting No. (Request code)	Setting contents	Initial setting
No.1 (310)	Monitoring the request code of current setting.	
No.2 (311)	Rotation and Back-up OFF (Normal group control operation)	☉
No.3 (312)	Back-up function only	
No.4 (313)	Rotation ON (Alternating interval = 1day) and back up function	
No.5 (314)	Rotation ON (Alternating interval = 3day) and back up function	
No.6 (315)	Rotation ON (Alternating interval = 5day) and back up function	
No.7 (316)	Rotation ON (Alternating interval = 7day) and back up function	
No.8 (317)	Rotation ON (Alternating interval = 14day) and back up function	
No.9 (318)	Rotation ON (Alternating interval = 28day) and back up function	

2nd stage cut-in setting

Setting No. (Request code)	Setting contents	Initial setting
No.1 (320)	Monitoring the request code of current setting.	
No.2 (321)	Cut-in function OFF	☉
No.3 (322)	Cut-in Function ON(Set point = Set temp.+ 4°C(7.2°F))	
No.4 (323)	Cut-in Function ON(Set point = Set temp.+ 6°C(10.8°F))	
No.5 (324)	Cut-in Function ON(Set point = Set temp.+ 8°C(14.4°F))	

(2) Setting method of each function by wired remote controller

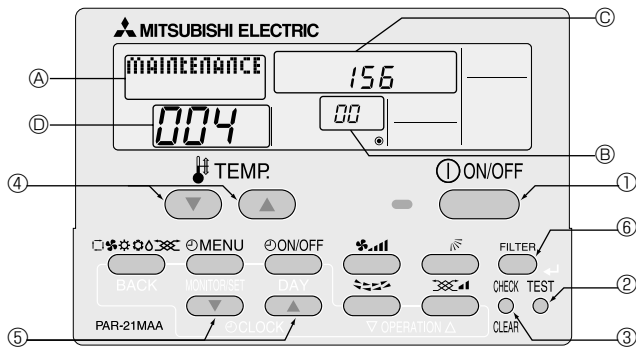

B: Refrigerant address
 C: Data display area
 D: Request code display area

1. Stop operation(①).
2. Press the **TEST** button (②) for 3 seconds so that [Maintenance mode] appears on the screen (Ⓐ).
 After a while, [00] appears in the refrigerant address number display area.(at Ⓑ)
3. Press the **CHECK** button (③) for 3 seconds to switch to [Maintenance monitor].
 Note) It is not possible to switch to [Maintenance monitor] during data request in maintenance mode (i.e., while "----" is blinking) since no buttons are operative.

[----] appears on the screen (Ⓒ) when [Maintenance monitor] is activated.
 (The display (Ⓒ) now allows you to set a request code No.)

4. Press the [TEMP (▽ and △)] buttons (④) to select the desired refrigerant address.



5. Press the [CLOCK (▽ and △)] buttons (⑤) to set the desired request code No.("311~318", "321~324")
6. Press the **FILTER** button (⑥) to perform function setting.
 If above setting operations are done correctly, "Request code number" will appear in data display area.(Ⓒ)
 [Example: When the "311" of "Request code number" is set, [311] appears on the screen.(Ⓒ)]

[Reference]

You can check current "request code number" setting by setting the "request code number"("310" or "320") and pressing the **FILTER** button.(⑥)

[Example: When the current setting is "Setting No.2(Request code 311)", [311] appears on the screen.(Ⓒ)]

7. To return to normal mode, press the **ON/OFF** button (①).

PSA-RP71KA

PSA-RP100KA

PSA-RP125KA

PSA-RP140KA

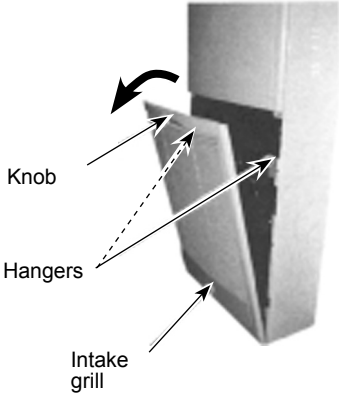
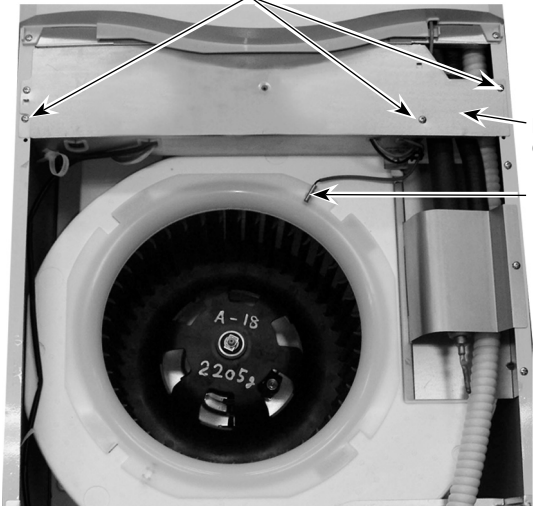
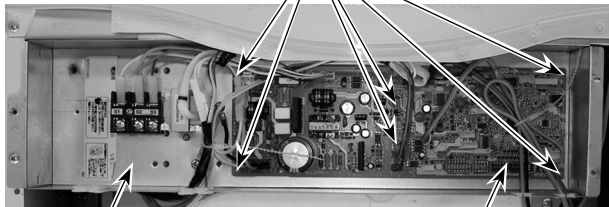
OPERATING PROCEDURE	PHOTOS
<p>1. Removing the intake grille</p> <p>(1) Remove the screw at the centre of the knob of the intake grille.</p> <p>(2) Pull the knob of the intake grille toward you.</p> <p>(3) Remove the 2 hangers.</p> <p>(4) Lift the intake grille to remove.</p>	<p>Photo 1</p>  <p>Knob</p> <p>Hangers</p> <p>Intake grille</p>
<p>2. Removing the indoor controller board</p> <p>(1) Remove the intake grille. (Refer to Procedure 1)</p> <p>(2) Remove the 3 screws of the electrical parts cover and remove the electrical parts cover.</p> <p>(3) Disconnect the fan motor connector and the other connectors on the indoor controller board. (See Photo 3)</p> <p>(4) Unhook the 6 catches of the controller case by opening, and remove the indoor controller board. (See Photo 3)</p>	<p>Photo 2</p>  <p>Screws</p> <p>Electrical parts cover</p> <p>Thermistor <Room temp.> (TH1)</p>
<p>3. Removing the room temperature thermistor</p> <p>(1) Remove the intake grille. (Refer to Procedure 1)</p> <p>(2) Remove the electrical parts cover. (Refer to Procedure 2)</p> <p>(3) Remove the room temperature thermistor. (See Photo 2)</p> <p>(4) Disconnect the red connector CN20 on the indoor controller board.</p>	<p>Photo 3</p>  <p>Catches</p> <p>Electrical parts box</p> <p>Indoor controller board</p>





OPERATING PROCEDURE

6. Removing the louver motor

- (1) Remove the intake grille. (Refer to Procedure 1)
- (2) Remove the electrical parts cover. (Refer to Procedure 2)
- (3) Remove the front panel. (Refer to Procedure 5)
- (4) Remove the 5 screws of the swing louver and remove the swing louver.
- (5) Remove the 2 screws of the louver motor and remove the louver motor.
- (6) Disconnect the blue connector CNP (LOUVER) on the indoor controller board.

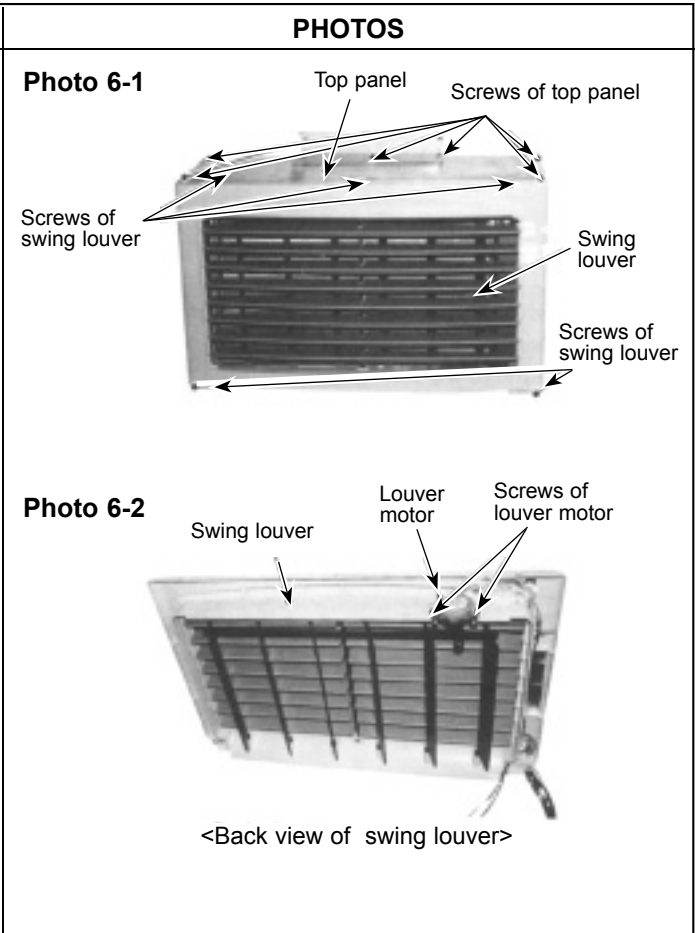

7. Removing the indoor coil thermistor

- (1) Remove the intake grille. (Refer to Procedure 1)
- (2) Remove the electrical parts cover. (Refer to Procedure 2)
- (3) Remove the front panel. (Refer to Procedure 5)
- (4) Remove the swing louver. (See Photo 6-1)
- (5) Remove the 10 screws of the insulation panel and remove the insulation panel .
- (6) Remove the screw of the piping cover and remove the piping cover.
- (7) Remove the indoor coil thermistor from the holder on the copper pipe.
- (8) Disconnect the connector CN44 on the indoor controller board.

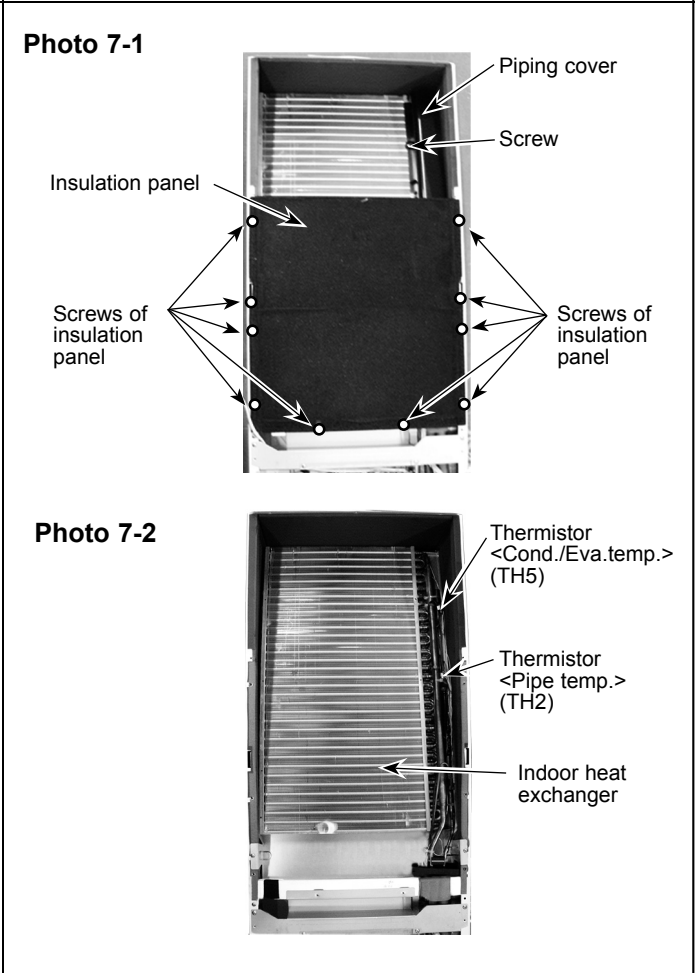



OPERATING PROCEDURE

8. Removing the indoor heat exchanger

- (1) Remove the intake grille. (Refer to Procedure 1)
- (2) Remove the front panel. (Refer to Procedure 5)
- (3) Remove the swing louver. (See Photos 6-1 and 6-2)
- (4) Remove the 6 screws of the top panel and remove the top panel. (See Photo 6-1)
- (5) Remove the insulation panel. (See Photo 7-1)
- (6) Remove the electrical parts cover and electrical parts box. (Refer to Procedure 2)
- (7) Remove the 2 screws of the drain pan support and remove the drain pan support. (See Photos 8-2 and 9)
- (8) Remove the screw of pipe support and remove the pipe support.
- (9) Remove the 4 screws of the indoor heat exchanger.
- (10) Remove the indoor heat exchanger.

Photo 8-2

Screws of electrical parts box

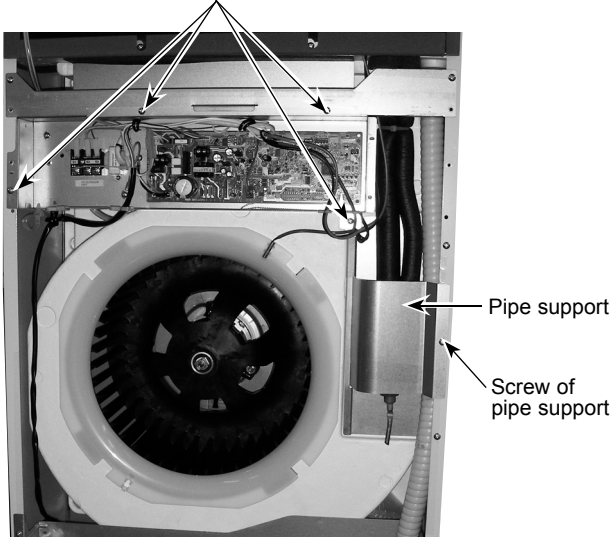

PHOTOS

Photo 8-1

Screws of indoor heat exchanger

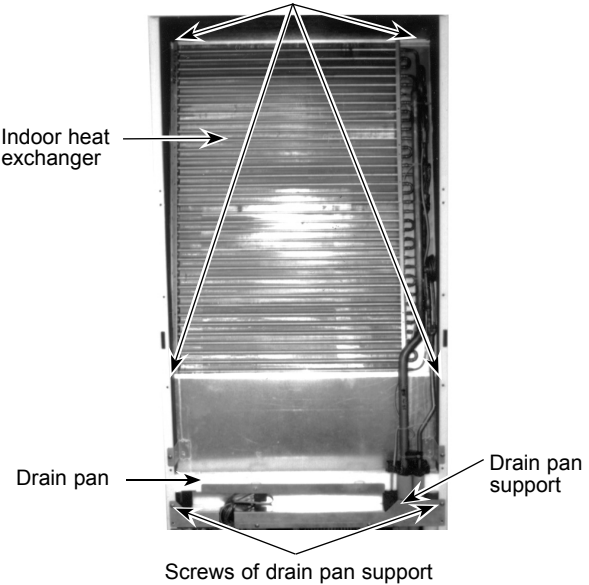

9. Removing the drain pan

- (1) Remove the intake grille. (Refer to Procedure 1)
- (2) Remove the front panel. (Refer to Procedure 5)
- (3) Remove the swing louver. (See Photo 6-1 and 6-2)
- (4) Remove the top panel. (See Photos 6-1)
- (5) Remove the insulation panel. (See Photo 7-1)
- (6) Remove the electrical parts cover, electrical parts box and the drain pan support. (See Photo 8-1)
- (7) Remove the pipe support. (See Photo 8-2)
- (8) Remove the indoor heat exchanger. (See Photo 8-1)
- (9) Remove the drain pan.

Photo 9

Indoor heat exchanger Drain pan

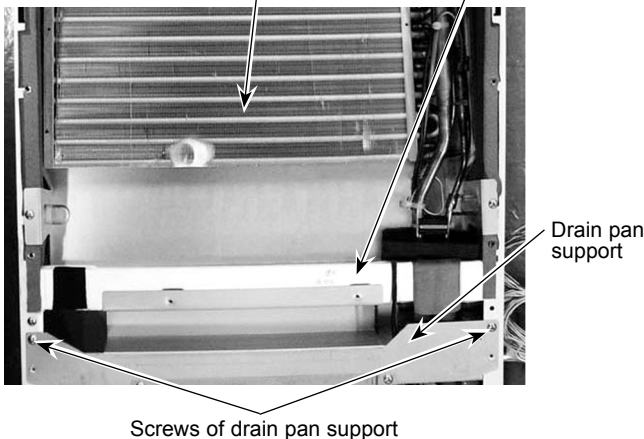

Mr. SLIM™

mitsubishi electric corporation

HEAD OFFICE : TOKYO BLDG., 2-7-3, MARUNOUCHI, CHIYODA-KU, TOKYO 100-8310, JAPAN