



TECHNICAL & SERVICE MANUAL

R410A

Outdoor unit
[Model Name]

[Service Ref.]

SUZ-KA25VA4

SUZ-KA25VA4.TH

SUZ-KA35VA4

SUZ-KA35VA4.TH

SUZ-KA50VA4

SUZ-KA50VA4.TH

SUZ-KA60VA4

SUZ-KA60VA4.TH

SUZ-KA71VA4

SUZ-KA71VA4.TH

Note:

- This service manual describes technical data of the outdoor units.

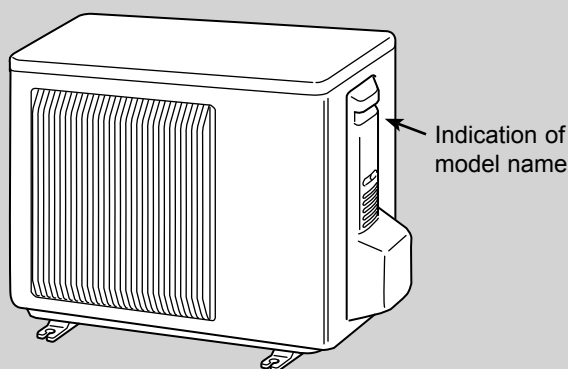

SUZ-KA25VA4.TH
SUZ-KA35VA4.TH

CONTENTS

1. COMBINATION OF INDOOR AND OUTDOOR UNITS	2
2. TECHNICAL CHANGES	3
3. PARTS NAMES AND FUNCTIONS	7
4. SPECIFICATION	8
5. NOISE CRITERIA CURVES	10
6. OUTLINES AND DIMENSIONS	11
7. WIRING DIAGRAM	13
8. REFRIGERANT SYSTEM DIAGRAM	16
9. ACTUATOR CONTROL	19
10. SERVICE FUNCTIONS	20
11. TROUBLESHOOTING	20
12. DISASSEMBLY INSTRUCTIONS	36

PARTS CATALOG (OCB545)

1 COMBINATION OF INDOOR AND OUTDOOR UNITS

INDOOR UNIT SERVICE MANUAL

	Indoor unit		Outdoor unit				
			Heat pump type				
	Service Ref.	Service Manual No.	SUZ-				
KA25VA4.TH			KA35VA4.TH	KA50VA4.TH	KA60VA4.TH	KA71A4.TH	
Heat pump without electric heater	SLZ-KA25VAL2.TH	OC320	○	—	—	—	—
	SLZ-KA35VALR3.TH		—	○	—	—	—
	SLZ-KA50VALR3.TH		—	—	○	—	—
	SLZ-KA25VAQ2.TH	OCH493	○	—	—	—	—
	SLZ-KA35VAQR2.TH		—	○	—	—	—
	SLZ-KA50VAQR2.TH		—	—	○	—	—
	SEZ-KD25VA(L)R2.TH	HWE0711 BWE102050	○	—	—	—	—
	SEZ-KD35VA(L)R2.TH		—	○	—	—	—
	SEZ-KD50VA(L)R2.TH		—	—	○	—	—
	SEZ-KD60VA(L)R2.TH		—	—	—	○	—
	SEZ-KD71VA(L)R2.TH		—	—	—	—	○
	SEZ-KD25VAQR2.TH	HWE1008 BWE102040	○	—	—	—	—
	SEZ-KD35VAQR2.TH		—	○	—	—	—
	SEZ-KD50VAQR2.TH		—	—	○	—	—
	SEZ-KD60VAQR2.TH		—	—	—	○	—
SEZ-KD71VAQR2.TH	—		—	—	—	○	

Note: Please refer to the service manual of indoor unit or the technical data book for the combination data.

INFORMATION FOR THE AIR CONDITIONER WITH R410A REFRIGERANT

- This room air conditioner adopts an HFC refrigerant (R410A) which never destroys the ozone layer.
- Pay particular attention to the following points, though the basic installation procedure is same as that for R22 conditioners.
 - ① As R410A has working pressure approximate 1.6 times as high as that of R22, some special tools and piping parts/materials are required. Refer to the table below.
 - ② Take sufficient care not to allow water and other contaminations to enter the R410A refrigerant during storage and installation, since it is more susceptible to contaminations than R22.
 - ③ For refrigerant piping, use clean, pressure-proof parts/materials specifically designed for R410A. (Refer to 2. Refrigerant piping.)
 - ④ Composition change may occur in R410A since it is a mixed refrigerant. When charging, charge liquid refrigerant to prevent composition change.

		New refrigerant	Previous refrigerant
Refrigerant	Refrigerant	R410A	R22
	Composition (Ratio)	HFC-32: HFC-125 (50%:50%)	R22 (100%)
	Refrigerant handling	Pseudo-azeotropic refrigerant	Single refrigerant
	Chlorine	Not included	Included
	Safety group (ASHRAE)	A1/A1	A1
	Molecular weight	72.6	86.5
	Boiling point (°C)	-51.4	-40.8
	Steam pressure [25°C](Mpa)	1.557	0.94
	Saturated steam density [25°C](Kg/m ³)	64	44.4
	Combustibility	Non combustible	Non combustible
	ODP *1	0	0.055
	GWP *2	1730	1700
	Refrigerant charge method	From liquid phase in cylinder	Gas phase
	Additional charge on leakage	Possible	Possible
Refrigerant oil	Kind	Incompatible oil	Compatible oil
	Color	None	Light yellow
	Smell	None	None

*1: Ozone Depletion Potential : based on CFC-11

*2: Global Warming Potential : based on CO₂

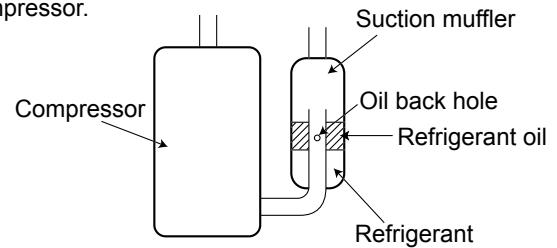
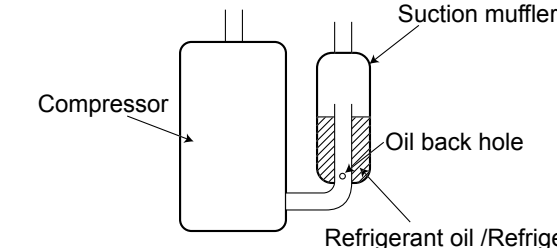
	New Specification	Current Specification
Compressor	<p>The incompatible refrigerant oil easily separates from refrigerant and is in the upper layer inside the suction muffler. Raising position of the oil back hole enables to back the refrigerant oil of the upper layer to flow back to the compressor.</p> 	<p>Since refrigerant and refrigerant oil are compatible with each other, refrigerant oil backs to the compressor through the lower position oil back hole.</p> 

NOTE : The unit of pressure has been changed to MPa on the international system of units (SI unit system).

The conversion factor is: **1 (MPa [Gauge]) =10.2 (kgf/cm² [Gauge])**

Conversion chart of refrigerant temperature and pressure

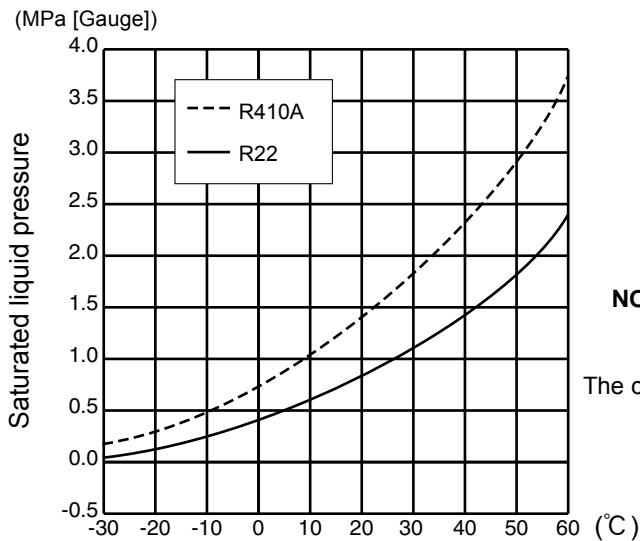

NOTE: The unit of pressure has been changed to MPa on the international system of units (SI unit system).

The conversion factor is: **1 (MPa [Gauge]) = 10.2 (kgf/cm² [Gauge])**

1. Tools dedicated for the air conditioner with R410A refrigerant

The following tools are required for R410A refrigerant. Some R22 tools can be substituted for R410A tools.

The diameter of the service port on the stop valve in outdoor unit has been changed to prevent any other refrigerant being charged into the unit. Cap size has been changed from 7/16 UNF with 20 threads to 1/2 UNF with 20 threads.

R410A tools	Can R22 tools be used?	Description
Gauge manifold	No	R410A has high pressures beyond the measurement range of existing gauges. Port diameters have been changed to prevent any other refrigerant from being charged into the unit.
Charge hose	No	Hose material and cap size have been changed to improve the pressure resistance.
Gas leak detector	No	Dedicated for HFC refrigerant.
Torque wrench	Yes	6.35 mm and 9.52 mm
	No	12.7 mm and 15.88 mm
Flare tool	Yes	Clamp bar hole has been enlarged to reinforce the spring strength in the tool.
Flare gauge	New	Provided for flaring work (to be used with R22 flare tool).
Vacuum pump adapter	New	Provided to prevent the back flow of oil. This adapter enables you to use vacuum pumps.
Electronic scale for refrigerant charging	New	It is difficult to measure R410A with a charging cylinder because the refrigerant bubbles due to high pressure and high-speed vaporization

No: Not substitutable for R410A Yes: Substitutable for R410A

2. Refrigerant piping

① Specifications

Use the refrigerant pipes that meet the following specifications.

Pipe	Outside diameter	Wall thickness	Insulation material
	mm	mm	
For liquid	6.35	0.8	Heat resisting foam plastic Specific gravity 0.045 Thickness 8 mm
	9.52	0.8	
For gas	9.52	0.8	
	12.7	0.8	
	15.88	1.0	

- Use a copper pipe or a copper-alloy seamless pipe with a thickness of 0.8 mm. Never use any pipe with a thickness less than 0.8mm, as the pressure resistance is insufficient.

② Flaring work and flare nut

Flaring work for R410A pipe differs from that for R22 pipe.

For details of flaring work, refer to Installation manual "FLARING WORK".

Pipe diameter (mm)	Dimension of flare nut (mm)	
	R410A	R22
6.35	17	17
9.52	22	22
12.7	26	24
15.88	29	27

3. Refrigerant oil

Apply the special refrigerant oil (accessories: packed with indoor unit) to the flare and the union seat surfaces.

4. Air purge

- Do not discharge the refrigerant into the atmosphere.
Take care not to discharge refrigerant into the atmosphere during installation, reinstallation, or repairs to the refrigerant circuit.
- Use the vacuum pump for air purging for the purpose of environmental protection.

5. Additional charge

For additional charging, charge the refrigerant from liquid phase of the gas cylinder.

If the refrigerant is charged from the gas phase, composition change may occur in the refrigerant inside the cylinder and the outdoor unit. In this case, ability of the refrigerating cycle decreases or normal operation can be impossible. However, charging the liquid refrigerant all at once may cause the compressor to be locked. Thus, charge the refrigerant slowly.

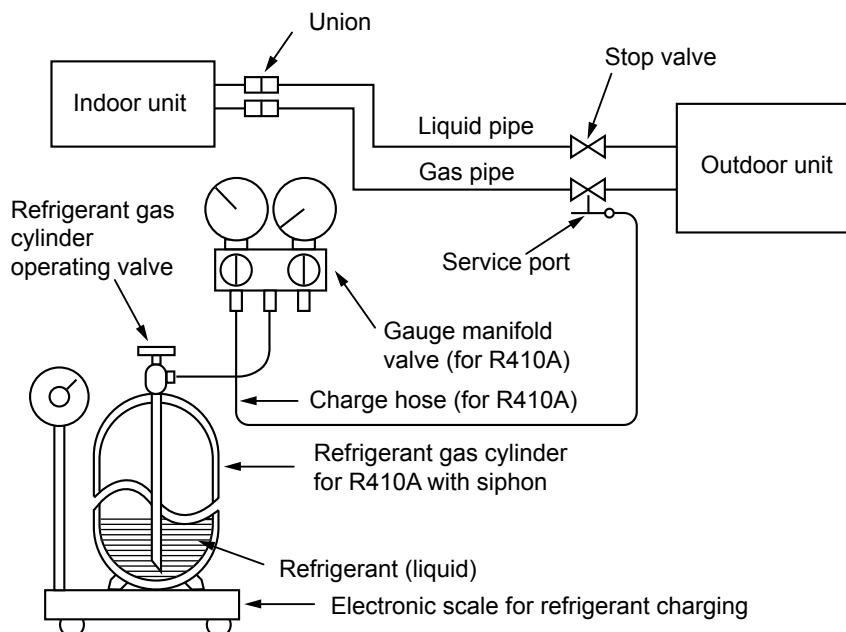

6. Pumping Down

When relocating or disposing of the air conditioner, pump down the system by following the procedure below so that no refrigerant is released into the atmosphere.

- ① Turn off the power supply (circuit breaker).
- ② Connect the gauge manifold valve to the service port of the stop valve on the gas pipe side of the outdoor unit.
- ③ Fully close the stop valve on the liquid pipe side of the outdoor unit.
- ④ Supply power (circuit breaker).
- ⑤ Perform the refrigerant collecting operation (cooling test run).
 - For the PAR-31MAA, select "Service" → "TestRun" from the main menu to start the test run, and then select the cooling mode.
 - For details or for other information about starting the test run when using remote controllers, refer to the installation manual for the indoor unit or the remote controller.
- ⑥ Fully close the stop valve on the gas pipe side of the outdoor unit when the pressure gauge shows 0.05 to 0 MPa [Gauge] (approx. 0.5 to 0 kgf/cm²) and quickly stop the air conditioner.
 - Push the "ON/OFF" button on the remote controller to stop the air conditioner.

Note:

When the extension piping is very long with a large refrigerant amount, it may not be possible to perform a pump down operation. In this case, use refrigerant recovery equipment to collect all of the refrigerant in the system.

- ⑦ Turn off the power supply (circuit breaker), remove the gauge manifold valve, and then disconnect the refrigerant pipes.

⚠ Warning: When pumping down the refrigerant, stop the compressor before disconnecting the refrigerant pipes.

- **If the refrigerant pipes are disconnected while the compressor is operating and the stop valve (ball valve) is open, the pressure in the refrigeration cycle could become extremely high if air is drawn in, causing the pipes to burst, personal injury, etc.**

3

PARTS NAMES AND FUNCTIONS

SUZ-KA25VA4.TH
 SUZ-KA35VA4.TH

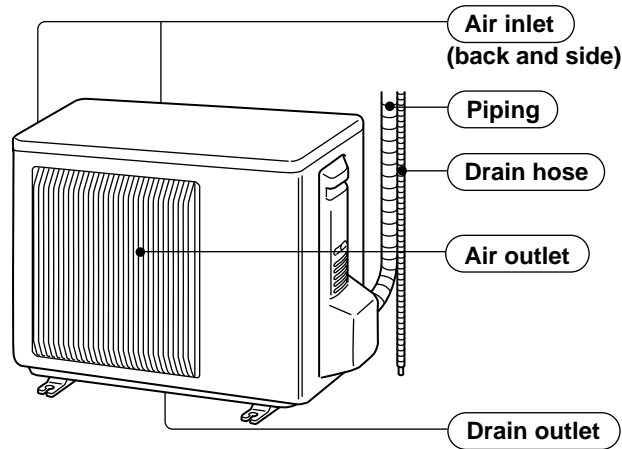

SUZ-KA50VA4.TH
 SUZ-KA60VA4.TH
 SUZ-KA71VA4.TH

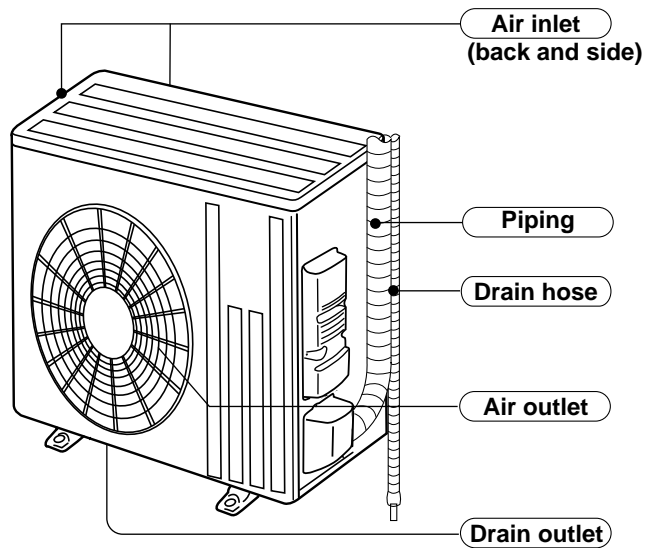

Model	SUZ-KA-VA4.TH
Drain socket	1

4

SPECIFICATION

Outdoor model				SUZ-KA25VA4.TH	SUZ-KA35VA4.TH	SUZ-KA50VA4.TH	SUZ-KA60VA4.TH	SUZ-KA71VA4.TH	
Power supply				Single phase 230V, 50Hz					
Compressor	Model			KNB073FKFMC	KNB092FFAMC	SNB130FGBMT		SNB172FEKMT	
	Output		W	550	650	900		1,200	
	Current*	Cooling	A	2.76	4.06	5.58	6.62	8.02	
		Heating		3.24	4.09	5.75	6.37	8.13	
Refrigeration oil (Model)			L	0.31 (FV50S)	0.27 (FV50S)	0.35 (FV50S)		0.4 (FV50S)	
Fan motor	Model			RC0J50-FA		RC0J60-BD	RC0J60-BC		
	Current*	Cooling	A	0.24	0.29	0.84	0.84	0.83	
		Heating		0.27	0.28	0.93	0.93	0.82	
Dimensions W × H × D			mm	800 × 550 × 285		840 × 880 × 330			
Weight			kg	30	35	54	50	53	
Special remarks	Air flow*	Cooling	High	m ³ /h	1,806		2,868	3,492	3,426
			Med.		1,806		2,868	3,066	3,006
			Low		1,170	1,038	1,602	1,692	1,512
		Heating	High		2,106		2,778	2,952	2,892
			Med.		1,806	1,770	2,778	2,952	2,892
			Low		1,452	1,326	2,124	2,226	2,280
	Sound level*		Cooling	dB(A)	47	49	52	55	
			Heating		48	50	52	55	
	Fan speed	Cooling	High	rpm	740	810	840	950	
			Med.		740	810	840		
			Low		740	490	480		450
		Heating	High		860	900	810		
			Med.		740	770	810		
			Low		600	610	620		650
Fan speed regulator				3					
Refrigerant filling capacity (R410A)			kg	0.80	1.15	1.60	1.80	1.80	

NOTE: Test conditions are based on ISO 5151

Cooling : Indoor D.B. 27°C W.B. 19°C

Outdoor D.B. 35°C

Heating : Indoor D.B. 20°C

Outdoor D.B. 7°C W.B. 6°C

Refrigerant piping length (one way): 5 m

*Measured under rated operating frequency.

Specifications and rating conditions of main electric parts

SUZ-KA25VA4.TH
SUZ-KA50VA4.TH
SUZ-KA71VA4.TH

SUZ-KA35VA4.TH
SUZ-KA60VA4.TH

Item	Model	SUZ-KA25VA4.TH	SUZKA35VA4.TH	SUZ-KA50VA4.TH	SUZ-KA60VA4.TH	SUZ-KA71VA4.TH
	Smoothing capacitor	(C61)	—	—	620μF 420V	—
(C62, C63)		620μF 420V	620μF 420V	620μF420V	—	—
(CB1, 2, 3)		—	—	—	560μF 450V	560μF 350V
Diode module	(DB61)	15A 600V	15A 600V	25A 600V	—	—
Fuse	(F61)	T20A L250V	T20A L250V	T20A L250V	—	—
	(F62)	—	—	—	T20A L250V	T20A L250V
	(F701, F801, F901)	T3.15A L250V	T3.15A L250V	T3.15A L250V	—	—
	(IC700)	15A 600V	15A 600V	20A 600V	—	—
Intelligent power module	(IPM)	—	—	—	20A 600V	
	(IC932)	8A 600V	8A 600V	8A 600V	5A 600V	5A 600V
Power factor controller	(PFC)	—	—	—	20A 600V	20A 600V
	(IC820)	20A 600V	20A 600V	20A 600V	—	—
Expansion valve coil	(LEV)	DC12V				
Reactor	(L61)	18mH	23mH	23mH	—	—
	(L)	—	—	—	340μH 20A	340μH 20A
Current-Limiting PTC thermistoe	(PTC64, PTC65)	33Ω				
Terminal block	(TB1, TB2)	—	—	—	3P	3P
	(TB)	5P	5P	5P	—	—
Relay	(X63)	3A 250V	3A 250V	3A 250V	—	—
	(X64)	20A 250V				
	(X601)	—	—	—	3A 250V	3A 250V
	(X602)	—	—	—	3A 250V	3A 250V
R.V. coil	(21S4)	AC220-240V				

SUZ-KA25VA4.TH

FAN SPEED	FUNCTION	SPL(dB(A))	LINE
High Med.	COOLING	47	●—●
	HEATING	48	○—○

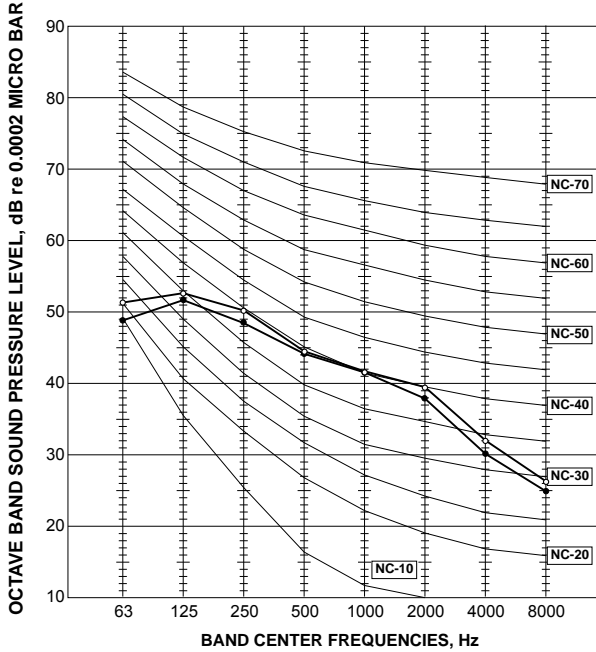

SUZ-KA35VA4.TH

FAN SPEED	FUNCTION	SPL(dB(A))	LINE
High Med.	COOLING	49	●—●
	HEATING	50	○—○

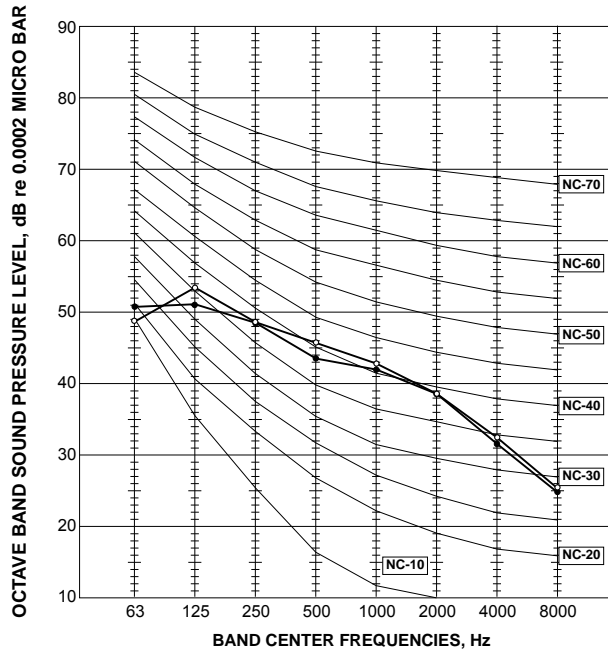

SUZ-KA50VA4.TH

FAN SPEED	FUNCTION	SPL(dB(A))	LINE
High	COOLING	52	●—●
	HEATING	52	○—○

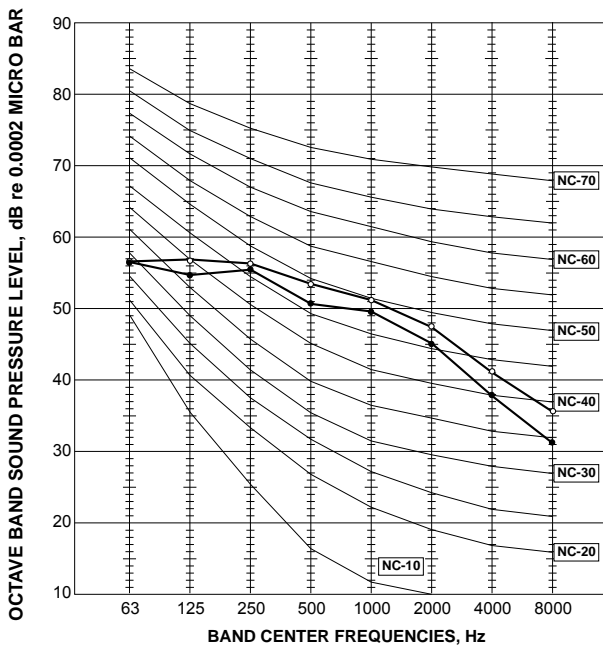

SUZ-KA60VA4.TH

SUZ-KA71VA4.TH

FAN SPEED	FUNCTION	SPL(dB(A))	LINE
High	COOLING	55	●—●
	HEATING	55	○—○

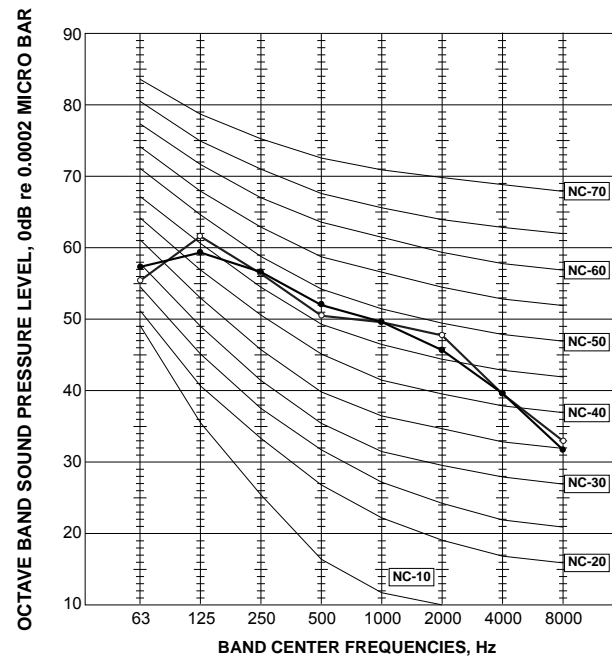

Test conditions

Cooling: Dry-bulb temperature 35°C
 Heating: Dry-bulb temperature 7°C
 Wet-bulb temperature 6°C

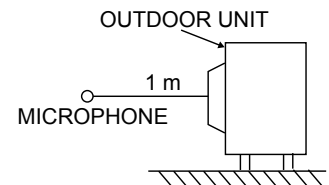

SUZ-KA25VA4.TH
 SUZ-KA35VA4.TH

Unit: mm

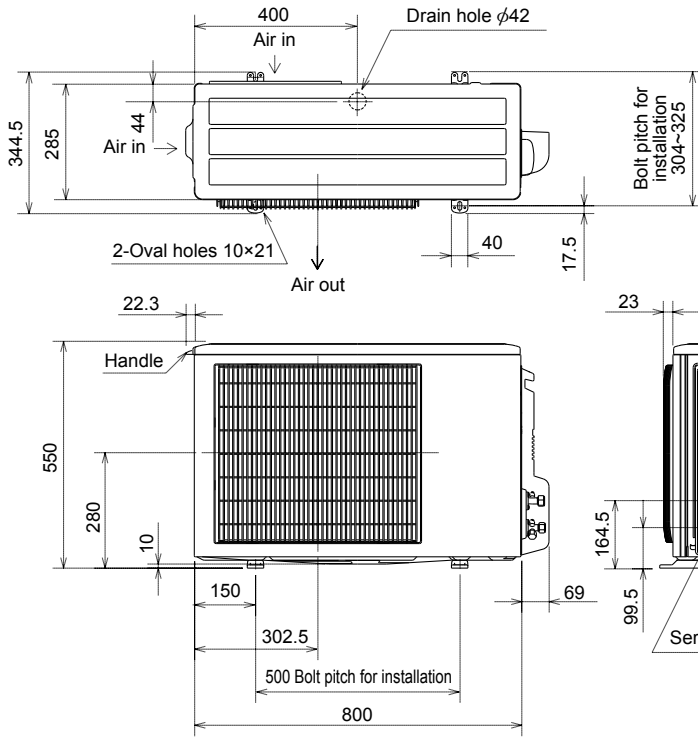

REQUIRED SPACE

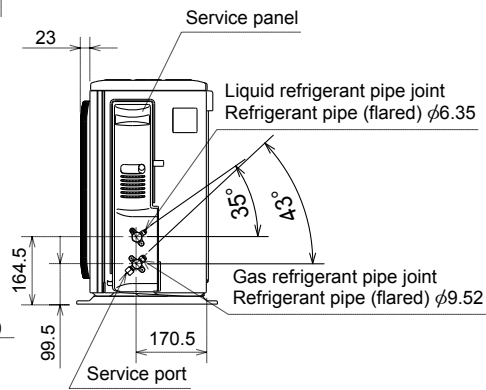
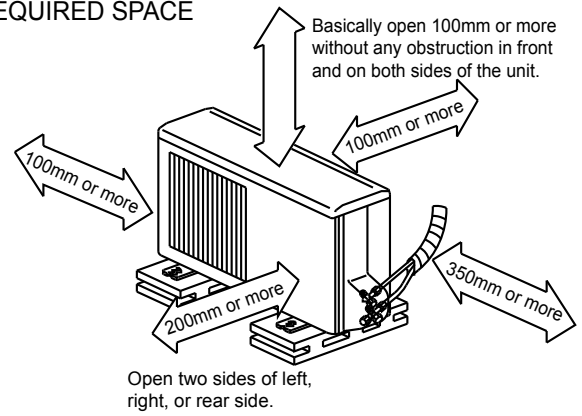

SUZ-KA50VA4.TH
SUZ-KA60VA4.TH
SUZ-KA71VA4.TH

Unit: mm

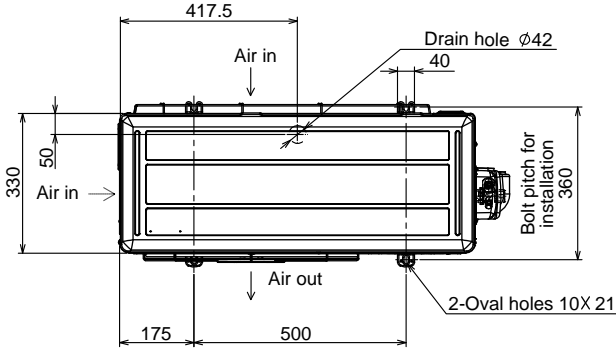

REQUIRED SPACE

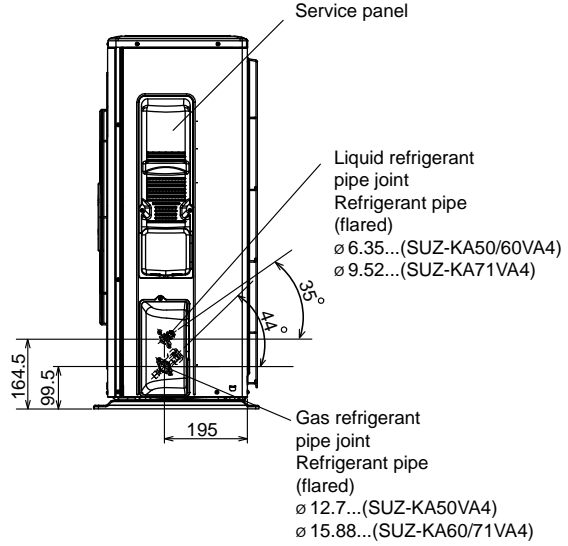
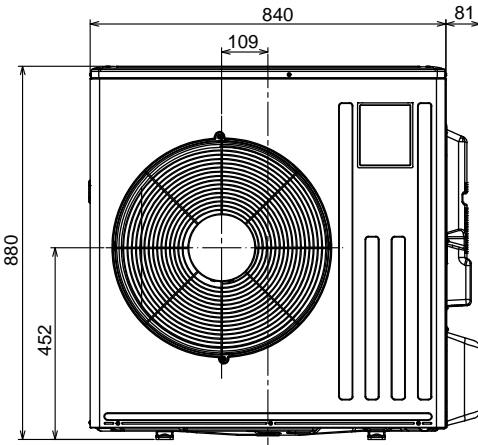
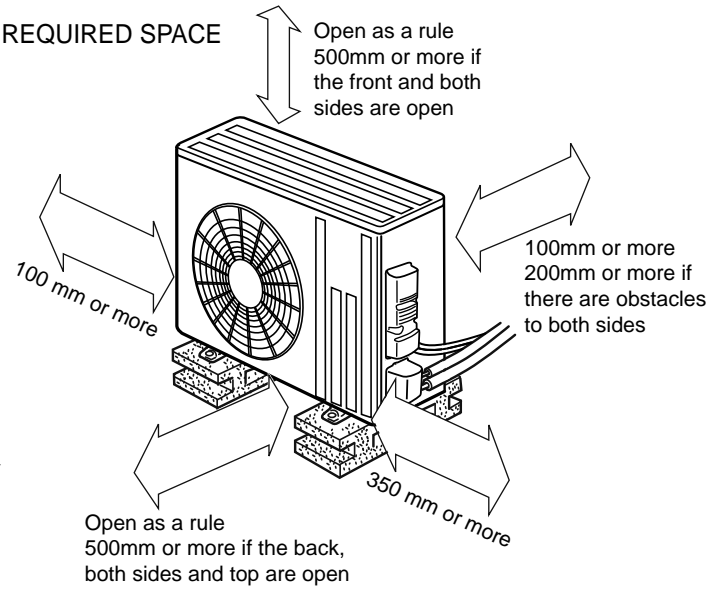

SUZ-KA25VA4.TH
 SUZ-KA35VA4.TH

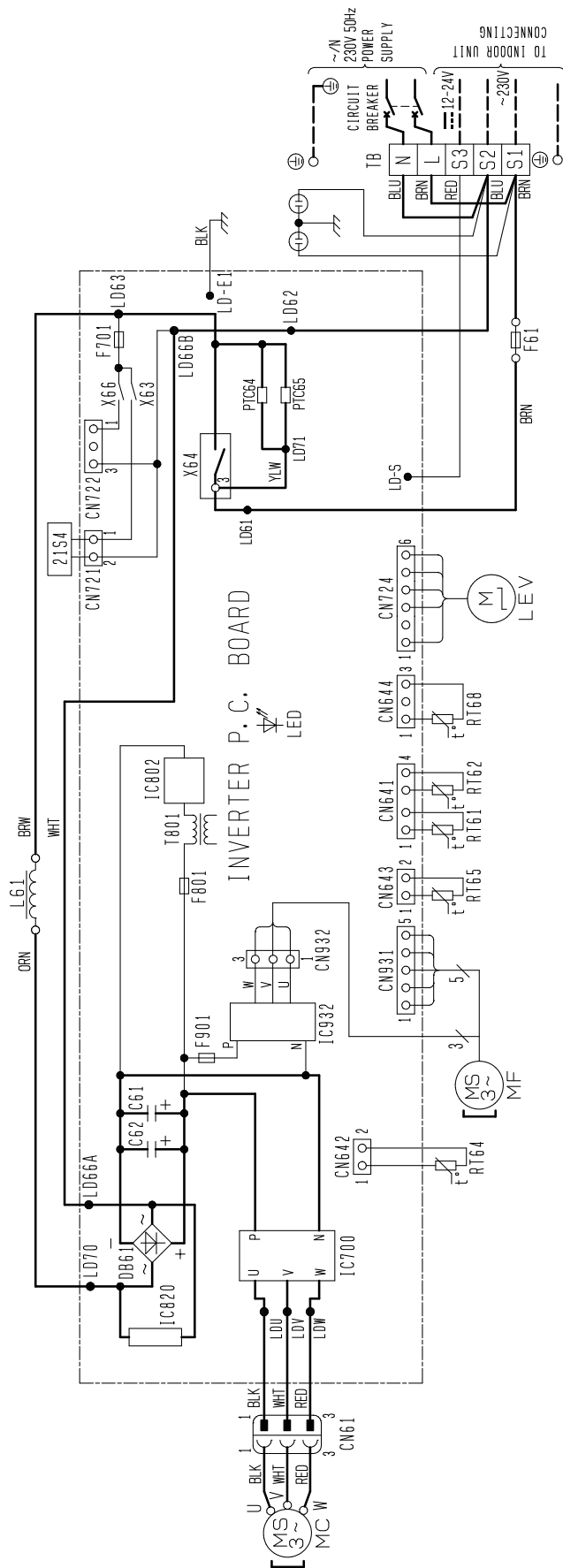

NOTES:
 1. About the indoor side electric wiring refer to the indoor unit electric wiring diagram for servicing.
 2. Use copper conductors only. (For field wiring).

SYMBOL	NAME	SYMBOL	NAME
L61	SMOOTHING CAPACITOR	L61	REACTOR
DB61	DIODE MODULE	MC	COMPRESSOR
F61	FUSE (T20AL/250V)	MF	FAN MOTOR
F701, F801, F901	FUSE (T3, 15A/250V)	PTC64, PTC65	CIRCUIT PROTECTION
IC801, IC802, IC802	POWER MODULE	RT61	DEFROST THERMISTOR
IC802	POWER DEVICE	RT62	DISCHARGE TEMP. THERMISTOR
LD70	LED	RT64	FIN TEMP. THERMISTOR
LEV	EXPANSION VALVE COIL	RT65	AMBIENT TEMP. THERMISTOR
		RT66	OUTDOOR HEAT EXCHANGER TEMP. THERMISTOR.
		TB	TERMINAL BLOCK
		T801	TRANSFORMER
		X63, X64, X66	RELAY
		21S4	REVERSING VALVE COIL

SUZ-KA50VA4.TH

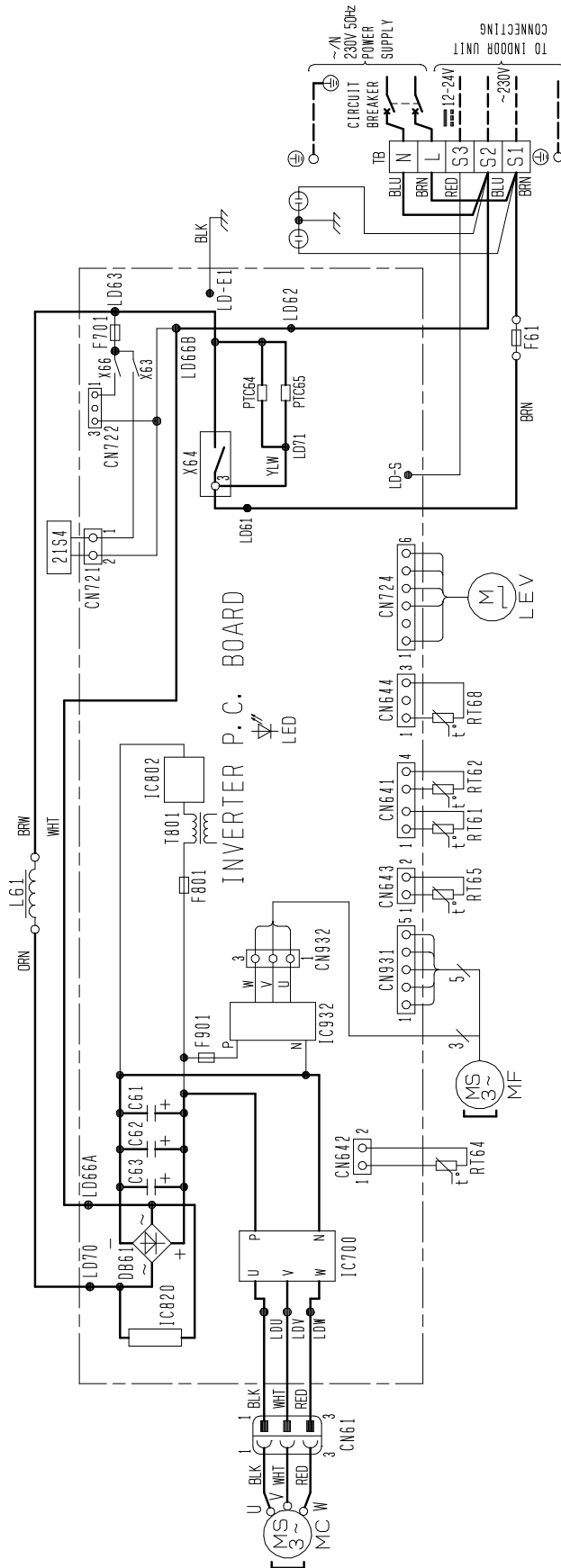

- NOTES:
- About the indoor side electric wiring refer to the indoor unit electric wiring diagram for servicing.
 - Use copper conductors only. (For field wiring).

SYMBOL	NAME	SYMBOL	NAME	SYMBOL	NAME
C61, C62, C63	SMOOTHING CAPACITOR	L61	REACTOR	RT68	OUTDOOR HEAT EXCHANGER TEMP. THERMISTOR.
DB61	DIODE MODULE	MC	COMPRESSOR	TB	TERMINAL BLOCK
F61	FUSE (T20AL250V)	MF	FAN MOTOR	T801	TRANSFORMER
F701, F801, F901	FUSE (T3, 15A, 250V)	PTC64, PTC65	CIRCUIT PROTECTION	X63, X64, X66	RELAY
IC700, IC820, IC932	POWER MODULE	RT61	DEFROST THERMISTOR	2154	REVERSING VALVE COIL
IC802	POWER DEVICE	RT62	DISCHARGE TEMP. THERMISTOR		
LED	LED	RT64	F.I.N. TEMP. THERMISTOR		
LEV	EXPANSION VALVE COIL	RT65	AMBIENT TEMP. THERMISTOR		

SUZ-KA60VA4.TH
SUZ-KA71VA4.TH

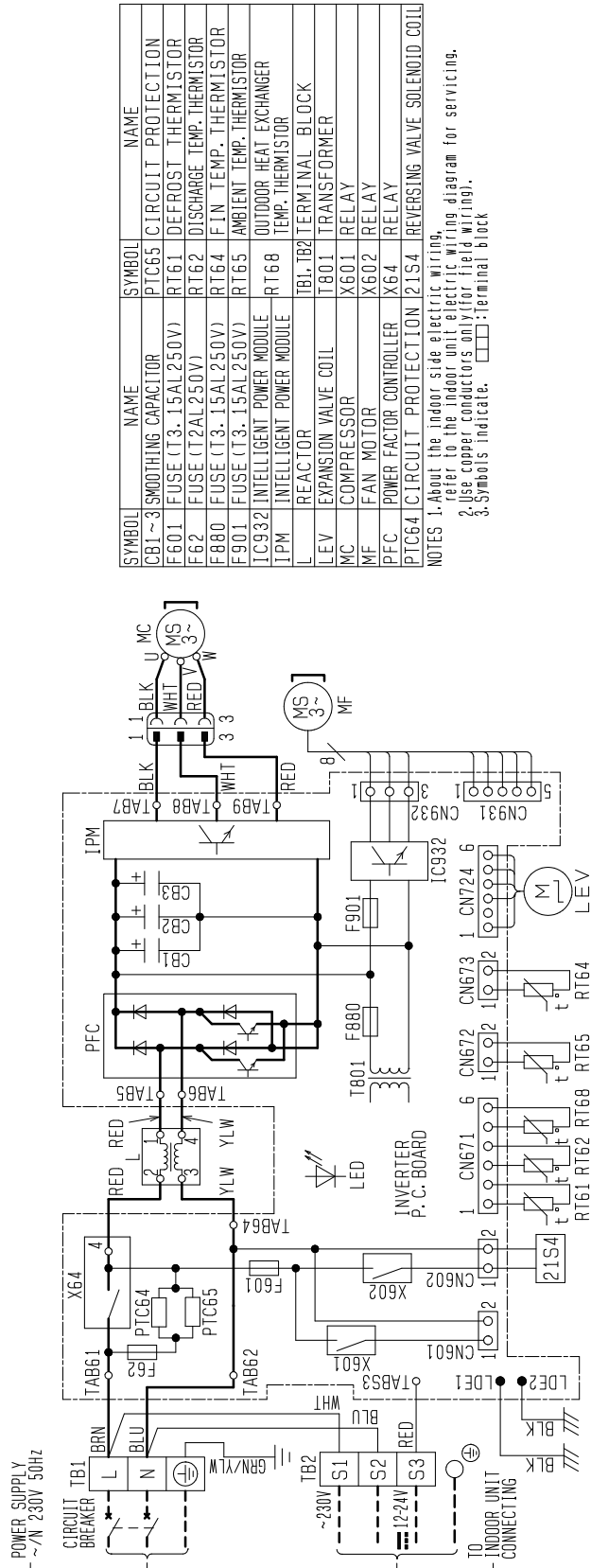

SYMBOL	NAME	SYMBOL	NAME
CB1~3	SMOOTHING CAPACITOR	PTC65	CIRCUIT PROTECTION
F601	FUSE (T3-15A/250V)	RT61	DEFROST THERMISTOR
F62	FUSE (T2A/250V)	RT62	DISCHARGE TEMP. THERMISTOR
F880	FUSE (T3-15A/250V)	RT64	FIN TEMP. THERMISTOR
F901	FUSE (T3-15A/250V)	RT65	AMBIENT TEMP. THERMISTOR
IC932	INTELLIGENT POWER MODULE	RT68	OUTDOOR HEAT EXCHANGER TEMP. THERMISTOR
IPM	INTELLIGENT POWER MODULE	TB1, TB2	TERMINAL BLOCK
L	REACTOR	T801	TRANSFORMER
LEV	EXPANSION VALVE COIL	X601	RELAY
MC	COMPRESSOR	X602	RELAY
MF	FAN MOTOR	X64	RELAY
PFC	POWER FACTOR CONTROLLER	21S4	REVERSING VALVE SOLENOID COIL
PTC64	CIRCUIT PROTECTION		

NOTES 1. About the indoor side electric wiring, refer to the indoor unit electric wiring diagram for servicing.
 2. Use copper conductors only (for field wiring).
 3. Symbols indicate. □□: terminal block

SUZ-KA25VA4.TH

Unit: mm

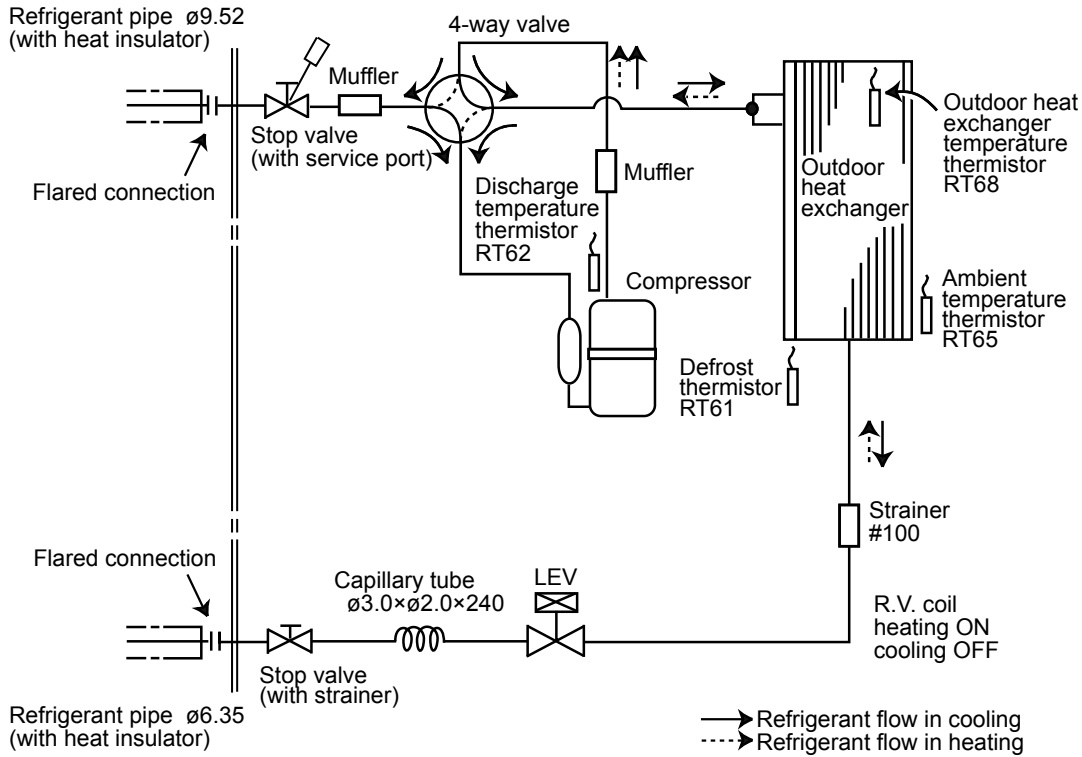

SUZ-KA35VA4.TH

Unit: mm

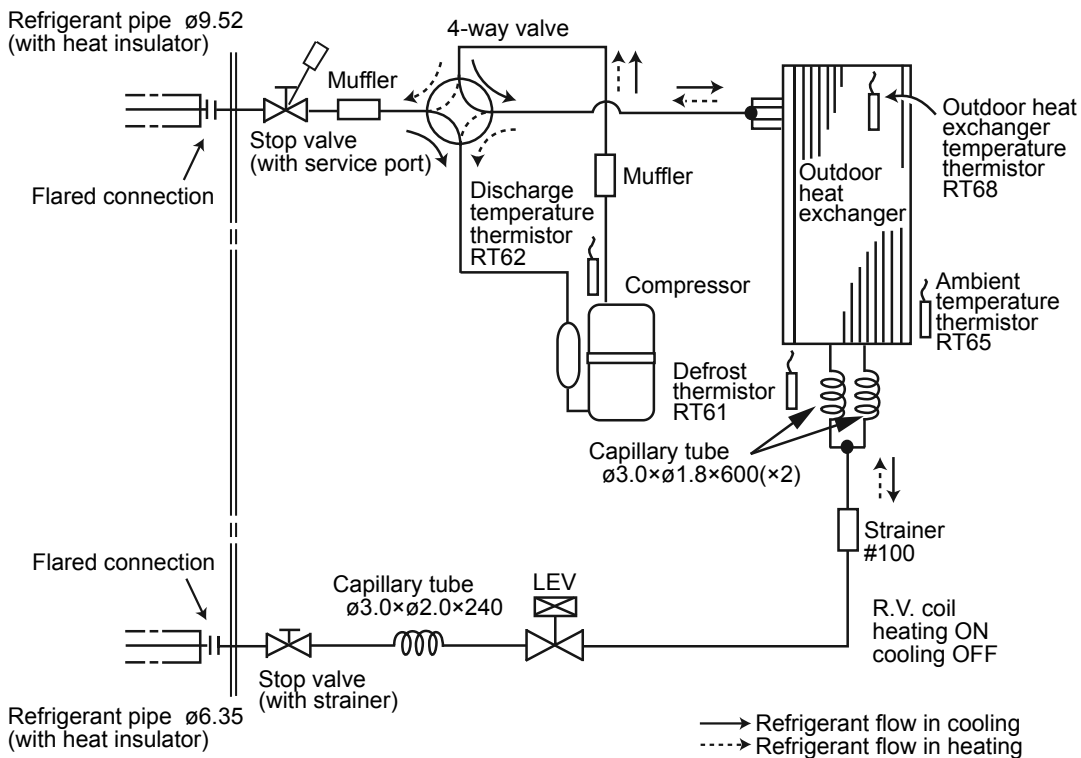

SUZ-KA50VA4.TH

Unit: mm

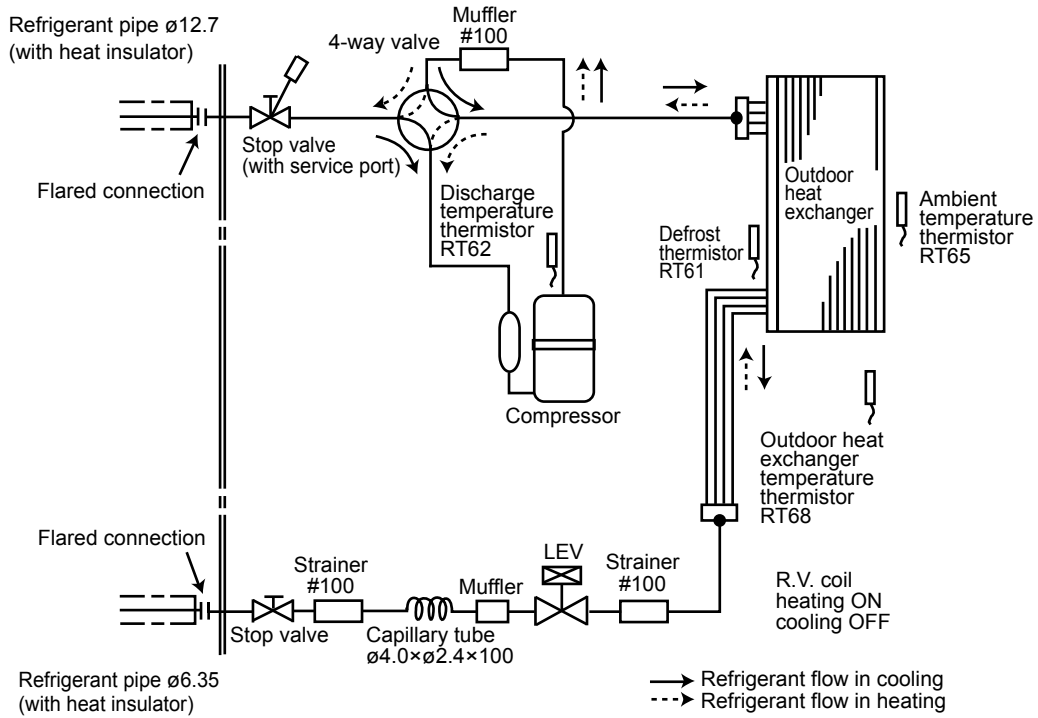

SUZ-KA60VA4.TH SUZ-KA71VA4.TH

Unit: mm

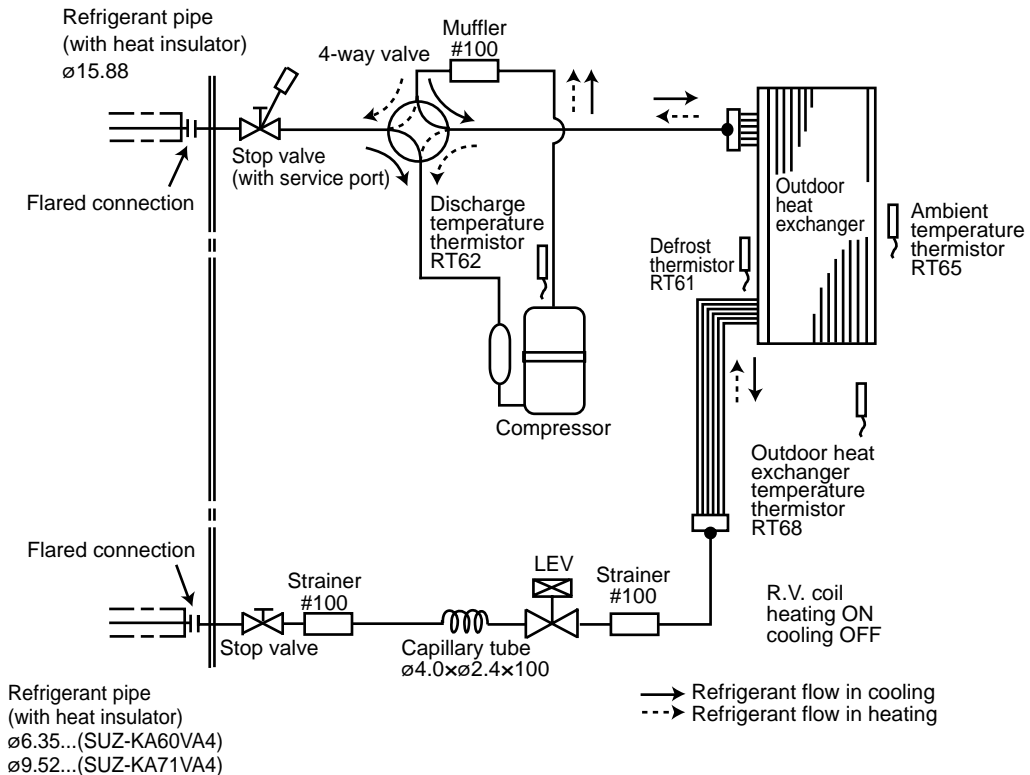

SUZ-KA25VA4.TH
SUZ-KA60VA4.TH

SUZ-KA35VA4.TH
SUZ-KA71VA4.TH

SUZ-KA50VA4.TH

MAX. REFRIGERANT PIPING LENGTH

Model	Refrigerant piping: m		Piping size O.D: mm	
	Max. Length A	Max. Height difference B	Gas	Liquid
SUZ-KA25VA4.TH	20	12	9.52	6.35
SUZ-KA35VA4.TH				
SUZ-KA50VA4.TH	30	30	12.7	9.52
SUZ-KA60VA4.TH				
SUZ-KA71VA4.TH				

MAX. HEIGHT DIFFERENCE

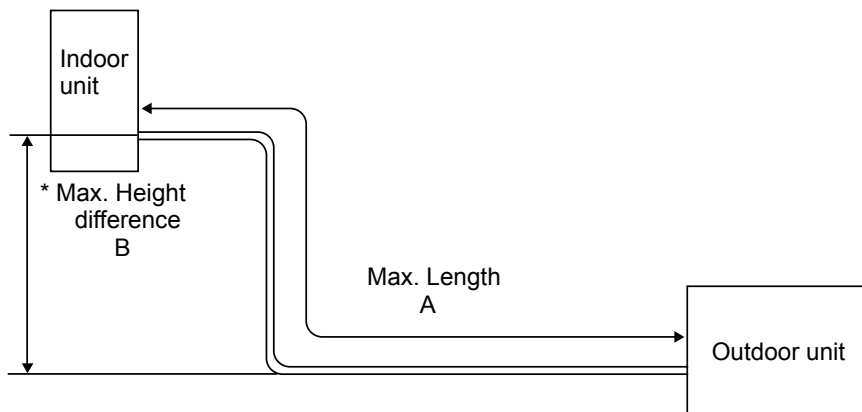

* Height difference limitations are binding regardless of which unit, indoor or outdoor, is position high.

ADDITIONAL REFRIGERANT CHARGE (R410A: g)

Model	Outdoor unit precharged	Refrigerant piping length (one way)									
		7m	8m	9m	10m	11m	12m	13m	14m	15m	20m
SUZ-KA25VA4.TH	800	0	30	60	90	120	150	180	210	240	390
SUZ-KA35VA4.TH	1,150	0	30	60	90	120	150	180	210	240	390

Calculation: $Xg=30g/m \times (\text{Refrigerant piping length}(m)-7)$

Model	Outdoor unit precharged	Refrigerant piping length (one way)					
		7m	10m	15m	20m	25m	30m
SUZ-KA50VA4.TH	1,600	0	60	160	260	360	460
SUZ-KA60VA4.TH	1,800	0	60	160	260	360	460

Calculation : $Xg=20g/m \times (\text{Refrigerant piping length}(m)-7)$

Model	Outdoor unit precharged	Refrigerant piping length (one way)					
		7m	10m	15m	20m	25m	30m
SUZ-KA71VA4.TH	1,800	0	165	440	715	990	1,265

Calculation : $Xg=55g/m \times (\text{Refrigerant piping length}(m)-7)$

SUZ-KA25VA4.TH
SUZ-KA60VA4.TH

SUZ-KA35VA4.TH
SUZ-KA71VA4.TH

SUZ-KA50VA4.TH

9-1. OUTDOOR FAN MOTOR CONTROL

The fan motor turns ON/OFF, interlocking with the compressor.

[ON] The fan motor turns ON 5 seconds before the compressor starts up.

[OFF] The fan motor turns OFF 15 seconds after the compressor has stopped running.

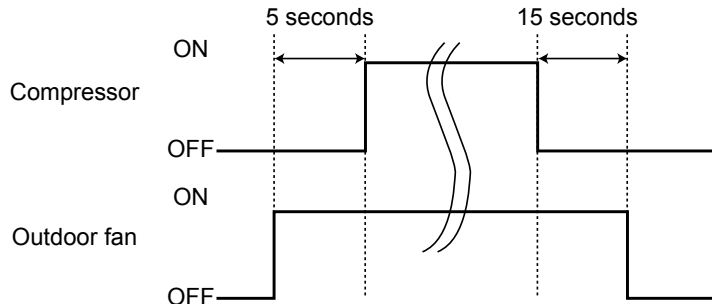

9-2. R.V. COIL CONTROL

Heating ON
Cooling OFF
Dry OFF

NOTE: The 4-way valve reverses for 5 seconds right before start-up of the compressor.

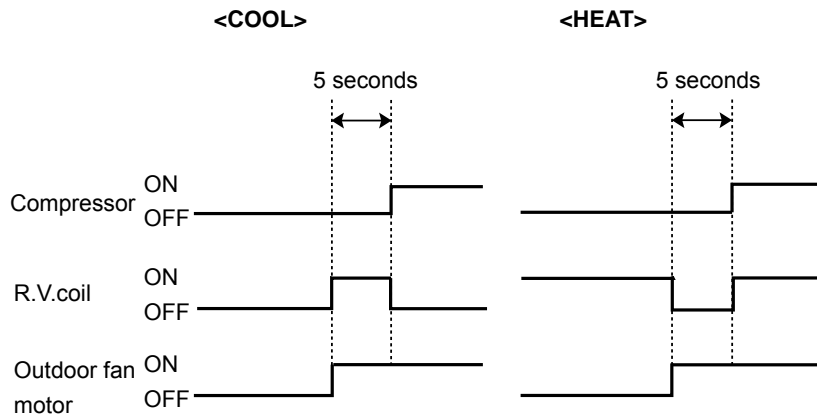

9-3. RELATION BETWEEN MAIN SENSOR AND ACTUATOR

Sensor	Purpose	Actuator				
		Compressor	LEV	Outdoor fan motor	R.V.coil	Indoor fan motor
Discharge temperature thermistor	Protection	○	○			
Indoor coil temperature thermistor	Cooling: Coil frost prevention	○				
	Heating: High pressure protection	○	○			
Defrost thermistor	Heating: Defrosting	○	○	○	○	○
Fin temperature thermistor	Protection	○		○		
Ambient temperature thermistor	Cooling: Low ambient temperature operation	○	○	○		
Outdoor heat exchanger temperature thermistor	Cooling: Low ambient temperature operation	○	○	○		
	Cooling: High pressure protection	○	○	○		

10

SERVICE FUNCTIONS

SUZ-KA25VA4.TH
SUZ-KA60VA4.TH

SUZ-KA35VA4.TH
SUZ-KA71VA4.TH

SUZ-KA50VA4.TH

CHANGE IN DEFROST SETTING

Changing defrost finish temperature

<JS> To change the defrost finish temperature, cut/solder the JS wire of the outdoor inverter P.C. board. (Refer to 11-6-1.)

Jumper wire		Defrost finish temperature (°C)		
		SUZ-KA25VA4.TH SUZ-KA35VA4.TH	SUZ-KA50VA4.TH	SUZ-KA60VA4.TH SUZ-KA71VA4.TH
JS	Soldered (Initial setting)	5	9	10
	None (cut)	10	18	18

11

TROUBLESHOOTING

SUZ-KA25VA4.TH
SUZ-KA60VA4.TH

SUZ-KA35VA4.TH
SUZ-KA71VA4.TH

SUZ-KA50VA4.TH

11-1. CAUTIONS ON TROUBLESHOOTING

1. Before troubleshooting, check the following:

- 1) Check the power supply voltage.
- 2) Check the indoor/outdoor connecting wire for miswiring.

2. Take care the following during servicing.

- 1) Before servicing the air conditioner, be sure to turn OFF the main unit first with the remote controller, and turn off the breaker.
- 2) Be sure to turn OFF the power supply before removing the front panel, the cabinet, the top panel, and the electronic control P.C. board.
- 3) When removing the electrical parts, be careful of the residual voltage of smoothing capacitor.
- 4) When removing the electronic control P.C. board, hold the edge of the board with care NOT to apply stress on the components.
- 5) When connecting or disconnecting the connectors, hold the housing of the connector. DO NOT pull the lead wires.

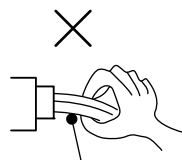

Lead wire

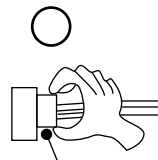

Housing point

3. Troubleshooting procedure

- 1) Check if the OPERATION INDICATOR lamp on the outdoor P.C. board is blinking on and off to indicate an abnormality. To make sure, check how many times the abnormality indication is blinking on and off before starting service work.
- 2) Before servicing check that the connector and terminal are connected properly.
- 3) If the electronic control P.C. board is supposed to be defective, check the copper foil pattern for disconnection and the components for bursting and discoloration.
- 4) When troubleshooting, refer to 11-2. and 11-3.

11-2. TROUBLE SHOOTING CHECK TABLE

SUZ-KA25VA4.TH SUZ-KA35VA4.TH SUZ-KA50VA4.TH SUZ-KA60VA4.TH SUZ-KA71VA4.TH

No.	Symptoms	LED indication	check code	Abnormal point/Condition	Condition	Remedy
1	Outdoor unit does not operate.	1-time flash every 2.5 seconds	UP	Outdoor power system	Overcurrent protection cut-out operates 3 consecutive times within 1 minute after the compressor gets started.	•Reconnect connector of compressor. •Refer to 11-5. ⑥ "How to check inverter/compressor". •Check stop valve.
2			U3	Outdoor thermistors	Discharge temperature thermistor shorts, or opens during compressor running.	•Refer to 11-5. ⑥ "Check of outdoor thermistors".
			U4	Fin temperature thermistor, defrost thermistor, P.C. board temperature thermistor, outdoor heat exchanger temperature thermistor or ambient temperature thermistor shorts, or opens during compressor running.		
3			FC	Outdoor control system	Nonvolatile memory data cannot be read properly.	•Replace inverter P.C. board.
4		6-time flash every 2.5 seconds OFF	E8 / E9	Serial signal	The communication fails between the indoor and outdoor unit for 3 minutes.	•Check of indoor/outdoor connecting wire. •Replace indoor or outdoor P.C. board if abnormality is displayed again.
5	11-time flash every 2.5 seconds OFF	UE	Stop valve/ Closed valve	Closed valve is detected by compressor current.	• Check stop valve.	
6	'Outdoor unit stops and restarts 3 minutes later' is repeated.	2-time flash every 2.5 seconds OFF		Overcurrent protection	Large current flows into intelligent power module.	Reconnect connector of compressor. •Refer to 11-5. ⑥ "How to check inverter/compressor". •Check stop valve.
7		3-time flash every 2.5 seconds OFF		Discharge temperature overheat protection	Temperature of discharge temperature thermistor exceeds 116°C, compressor stops. Compressor can restart if discharge temperature thermistor reads 100°C or less 3 minutes later.	•Check refrigerant circuit and refrigerant amount. •Refer to 11-5. ① "Check of LEV".
8		4-time flash every 2.5 seconds OFF		Fin temperature /P.C. board temperature thermistor overheat protection	Temperature of fin temperature thermistor on the heat sink exceeds 72 ~ 86°C or temperature of P.C. board temperature thermistor on the inverter P.C. board exceeds 72 ~ 85°C.	•Check around outdoor unit. •Check outdoor unit air passage. •Refer to 11-5. ⑥ "Check of outdoor fan motor".
9		5-time flash every 2.5 seconds OFF		High pressure protection	Indoor coil thermistor exceeds 70°C in HEAT mode. Defrost thermistor exceeds 70°C in COOL mode.	•Check refrigerant circuit and refrigerant amount. •Check stop valve.
10		8-time flash every 2.5 seconds OFF		Compressor synchronous abnormality	The waveform of compressor current is distorted.	•Reconnect connector of compressor. •Refer to 11-5. ⑥ "How to check inverter/compressor".
11		10-time flash every 2.5 seconds OFF		Outdoor fan motor	Outdoor fan has stopped 3 times in a row within 30 seconds after outdoor fan start-up.	•Refer to 11-5. ⑥ "Check of outdoor fan motor". •Refer to 11-5. ⑥ "Check of inverter P.C. board".
12		12-time flash every 2.5 seconds OFF		Each phase current of compressor	Each phase current of compressor cannot be detected normally.	•Refer to 11-5. ⑥ "How to check inverter/compressor".
13		13-time flash every 2.5 seconds OFF		DC voltage	DC voltage of inverter cannot be detected normally.	•Refer to 11-5. ⑥ "How to check inverter/compressor".
14		1-time flash every 2.5 seconds OFF		Frequency drop by current protection	When the input current exceeds approximately 7A(KA25)/8A(KA35)/12A(KA50)/14A(KA60)/16A(KA71), compressor frequency lowers.	The unit is normal, but check the following. •Check if indoor filters are clogged. •Check if refrigerant is short. •Check if indoor/outdoor unit air circulation is short cycled.
15		3-time flash every 2.5 seconds OFF		Frequency drop by high pressure protection	Temperature of indoor coil thermistor exceeds 55°C in HEAT mode, compressor frequency lowers.	
			Frequency drop by defrosting in COOL mode	Indoor coil thermistor reads 8°C or less in COOL mode, compressor frequency lowers.		
16	4-time flash every 2.5 seconds OFF		Frequency drop by discharge temperature protection	Temperature of discharge temperature thermistor exceeds 111°C, compressor frequency lowers.	•Check refrigerant circuit and refrigerant amount. •Refer to 11-5. ① "Check of LEV". •Refer to 11-5. ⑥ "Check of outdoor thermistors".	
17	7-time flash every 2.5 seconds OFF		Low discharge temperature protection	Temperature of discharge temperature thermistor has been 50°C or less for 20 minutes.	•Refer to 11-5. ① "Check of LEV". •Check refrigerant circuit and refrigerant amount.	
18	8-time flash every 2.5 seconds OFF		(KA25/35/50) PAM protection PAM: Pulse Amplitude Modulation	The overcurrent flows into PFC (Power factor correction : IC820) or the bus-bar voltage reaches 394 V or more, PAM stops and restarts.	This is not malfunction. PAM protection will be activated in the following cases: 1. Instantaneous power voltage drop. (Short time power failure) 2. When the power supply voltage is high.	
			(KA60/71) Zero cross detecting circuit	Zero cross signal for PAM control cannot be detected.		
19	9-time flash every 2.5 seconds OFF		Inverter check mode	The connector of compressor is disconnected, inverter check mode starts.	• Check if the connector of the compressor is correctly connected. • Refer to 11-5. ⑥ "How to check inverter/compressor".	

NOTE: 1. The location of LED is illustrated at the right figure. Refer to 11-6-1.
2. LED is lighted during normal operation.

The flashing frequency shows the number of times the LED blinks after every 2.5-second OFF.
(Example) When the flashing frequency is "2".

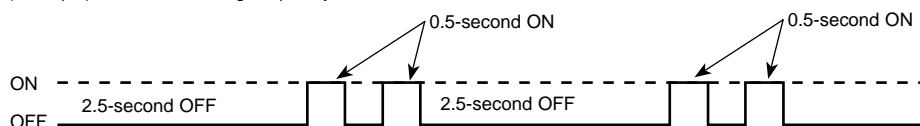

Inverter P.C. board

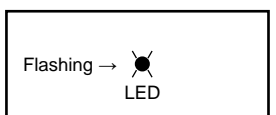

11-3. HOW TO PROCEED "SELF-DIAGNOSIS"

As this air conditioner has a function to memorize all the failures that had occurred, the latest failure detail can be recalled by following the procedure below.

Use this function when the check code is not displayed with wired remote controller or the remote controller at use is wireless type.

11-3-1. Self-diagnosis <PAR-30MAA> <PAR-31MAA>

① Select "Service" from the Main menu, and press the  button.



Select "Self check" with the **F1** or **F2** button, and press the  button.

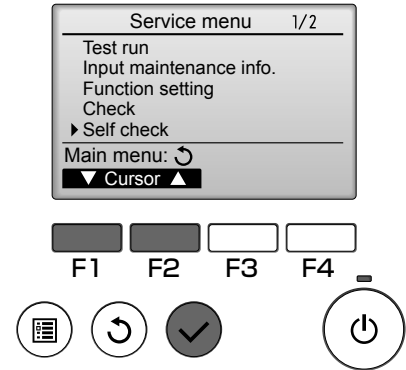

② With the **F1** or **F2** button, enter the refrigerant address, and press the  button.



③ Error code, unit number, attribute will appear.
"-" will appear if no error history is available.

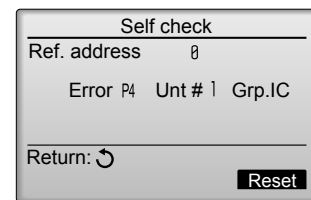

When there is no error history

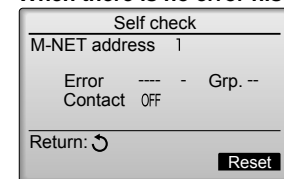

④ Resetting the error history.

Press the **F4** button (Reset) on the screen that shows the error history.



A confirmation screen will appear asking if you want to delete the error history.



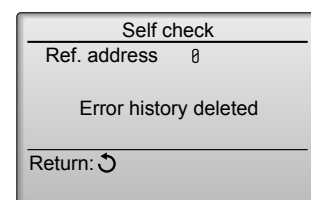

Press the **F4** button (OK) to delete the error history.

If deletion fails, "Request rejected" will appear.
"Unit not exist" will appear if no indoor units that are correspond to the entered address are found.





Navigating through the screens

- To go back to the Main menu  button
- To return to the previous screen  button

11-3-2. Remote controller check <PAR-30MAA> <PAR-31MAA>



If operations cannot be completed with the remote controller, diagnose the remote controller with this function.

- ① Select "Service" from the Main menu, and press the  button.

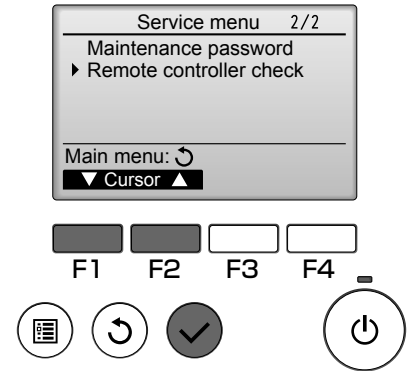
Select "Remote controller check" with the **F1** or **F2** button, and press the  button.



- ② Select "Remote controller check" from the Service menu, and press the  button to start the remote controller check and see the check results.

To cancel the remote controller check and exit the Remote controller check menu screen, press the  or the  button.

The remote controller will not reboot itself.

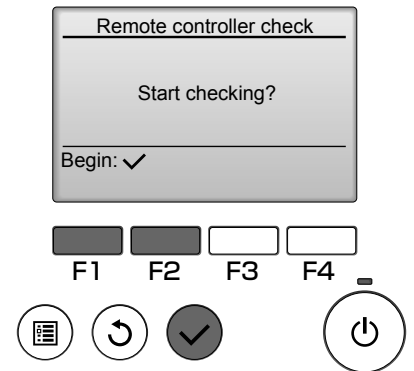

- ③
- OK: No problems are found with the remote controller. Check other parts for problems.
 - E3, 6832: There is noise on the transmission line, or the indoor unit or another remote controller is faulty. Check the transmission line and the other remote controllers.
 - NG (ALL0, ALL1): Send-receive circuit fault. Remote controller needs replacing.
 - ERC: The number of data errors is the discrepancy between the number of bits in the data transmitted from the remote controller and that of the data that was actually transmitted over the transmission line. If data errors are found, check the transmission line for external noise interference.

Remote controller check results screen

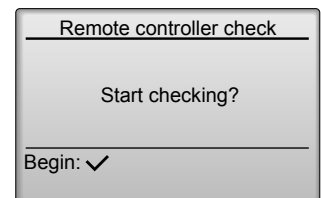

If the  button is pressed after the remote controller check results are displayed, remote controller check will end, and the remote controller will automatically reboot itself.

Check the remote controller display and see if anything is displayed (including lines). Nothing will appear on the remote controller display if the correct voltage (8.5 – 12 VDC) is not supplied to the remote controller. If this is the case, check the remote controller wiring and indoor units.

11-3-3. Self-diagnosis <PAR-21MAA>

When a problem occurs to the air conditioner, the indoor and outdoor units will stop, and the problem is shown in the remote controller display.

[CHECK] and the refrigerant address are displayed on the temperature display, and the error code and unit number are displayed alternately as shown below.

- ① (If the outdoor unit is malfunctioning, the unit number will be "00".)
- ② In the case of group control, for which one remote controller controls multiple refrigerant systems, the refrigerant address and error code of the unit that first experienced trouble (i.e., the unit that transmitted the error code) will be displayed.
- ③ To clear the error code, press the **ON/OFF** button.

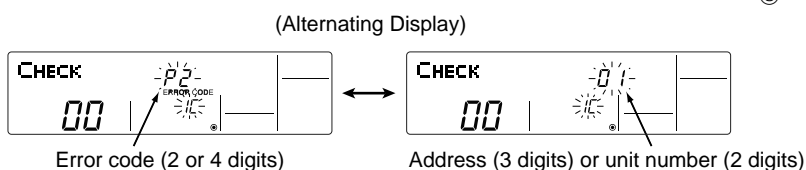
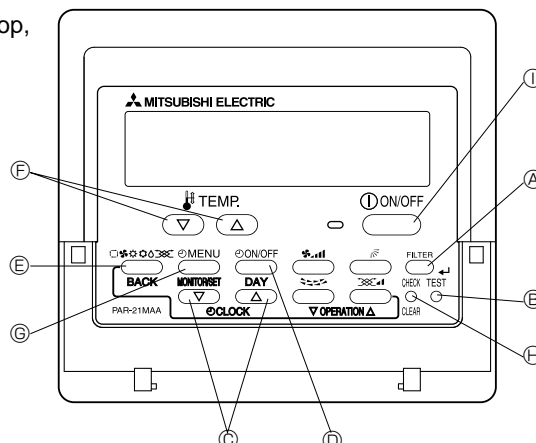

When using remote-/local-controller combined operation, cancel the error code after turning off remote operation.
 During central control by a MELANS controller, cancel the error code by pressing the **ON/OFF** button.

11-3-4. Self-Diagnosis During Maintenance or Service <PAR-21MAA>

Since each unit has a function that stores error codes, the latest check code can be recalled even if it is cancelled by the remote controller or power is turned off.

Check the error code history for each unit using the remote controller.

- ① Switch to self-diagnosis mode.

Press the **CHECK** button (Ⓜ in the picture above) twice within 3 seconds.
 The display content will change as shown below.

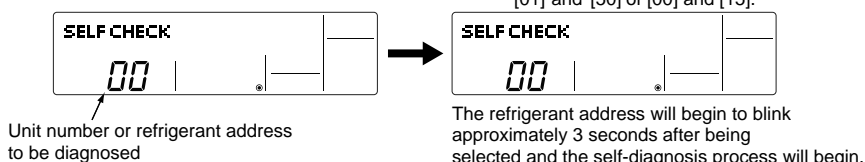

- ② Set the unit number or refrigerant address you want to diagnose.

Press the [TEMP] buttons (▽ and △) (Ⓧ in the picture above) to select the desired number or address. The number (address) changes between [01] and [50] or [00] and [15].

- ③ Display self-diagnosis results.

<When there is error code history>

(For the definition of each error code, refer to the indoor unit's installation manual or service handbook.)

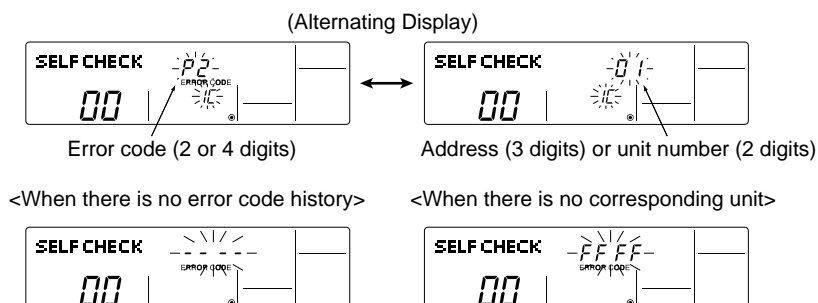

- ④ Reset the error history.

Display the error history in the diagnosis result display screen (see step ③).

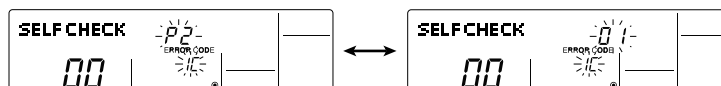

Press the **ON/OFF** button (Ⓞ in the picture in the previous page) twice within 3 seconds. The self-diagnosis address or refrigerant address will blink.

When the error history is reset, the display will look like the one shown below. However, if you fail to reset the error history, the error content will be displayed again.

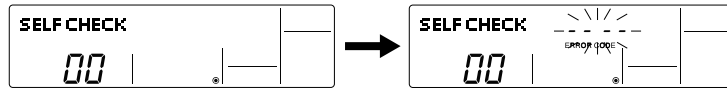

⑤ Cancel self-diagnosis.

Self-diagnosis can be cancelled by the following 2 methods.

Press the **CHECK** button (Ⓢ in the picture in the previous page) → Self-diagnosis will be cancelled and the screen will return to the previous state in effect before the start of self-diagnosis.

Press the **ON/OFF** button (Ⓞ in the picture in the previous page). → Self-diagnosis will be cancelled and the indoor unit will stop.

11-3-5. Remote controller check <PAR-21MAA>

If the air conditioner cannot be operated from the remote controller, diagnose the remote controller as explained below.

① First, check that the power-on indicator is lit.

If the correct voltage (DC12 V) is not supplied to the remote controller, the indicator will not light.
If this occurs, check the remote controller's wiring and the indoor unit.

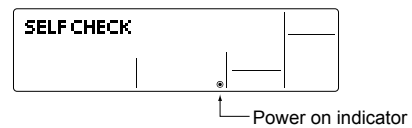

② Switch to the remote controller self-diagnosis mode.

Press the **CHECK** button (Ⓢ in the picture in the previous page) for 5 seconds or more. The display content will change as shown below.

Press the **FILTER** button (Ⓞ in the picture in the previous page) to start self-diagnosis.

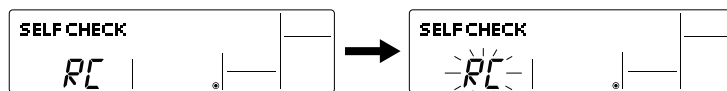

③ Remote controller self-diagnosis result

[When the remote controller is functioning correctly]

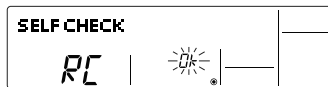

Check for other possible causes, as there is no problem with the remote controller.

[When the remote controller malfunctions]

(Error display 1) "NG" blinks. → The remote controller's transmitting-receiving circuit is defective.

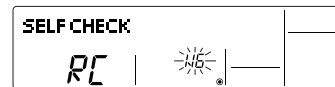

The remote controller must be replaced with a new one.

[Where the remote controller is not defective, but cannot be operated.]
(Error display 2) [E3], [6833] or [6832] blinks. → Transmission is not possible.

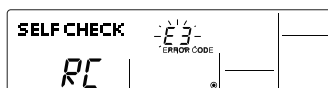

There might be noise or interference on the transmission path, or the indoor unit or other remote controllers are defective. Check the transmission path and other controllers.

(Error display 3) "ERC" and the number of data errors are displayed.
→ Data error has occurred.

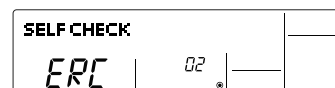

The number of data errors is the difference between the number of bits sent from the remote controller and the number actually transmitted through the transmission path. If such a problem is occurring, the transmitted data is affected by noise, etc. Check the transmission path.

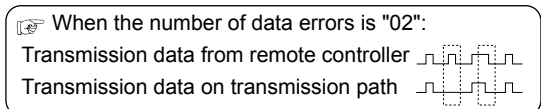

④ To cancel remote controller diagnosis

Press the **CHECK** button (Ⓢ in the picture in the previous page) for 5 seconds or more. Remote controller diagnosis will be cancelled, "PLEASE WAIT" and operation lamp will blink. After approximately 30 seconds, the state in effect before the diagnosis will be restored.

11-3-6. Self-diagnosis <Wireless remote controller>

<In case of trouble during operation>

When a malfunction occurs to air conditioner, both indoor unit and outdoor unit will stop and operation lamp blinks to inform unusual stop.

<Malfunction-diagnosis method at maintenance service>

[Procedure]

1. Press the CHECK button twice.

- "CHECK" lights, and refrigerant address "00" flashes.
- Check that the remote controller's display has stopped before continuing.

2. Press the temperature \downarrow \uparrow buttons.

- Select the refrigerant address of the indoor unit for the self-diagnosis.
- Note: Set refrigerant address using the outdoor unit's DIP switch (SW1). (For more information, see the outdoor unit installation manual.)

3. Point the remote controller at the sensor on the indoor unit and press the HOUR button.

- If an air conditioner error occurs, the indoor unit's sensor emits an intermittent buzzer sound, the operation light flashes, and the error code is output. (It takes 3 seconds at most for error code to appear.)

4. Point the remote controller at the sensor on the indoor unit and press the ON/OFF button.

- The check mode is cancelled.

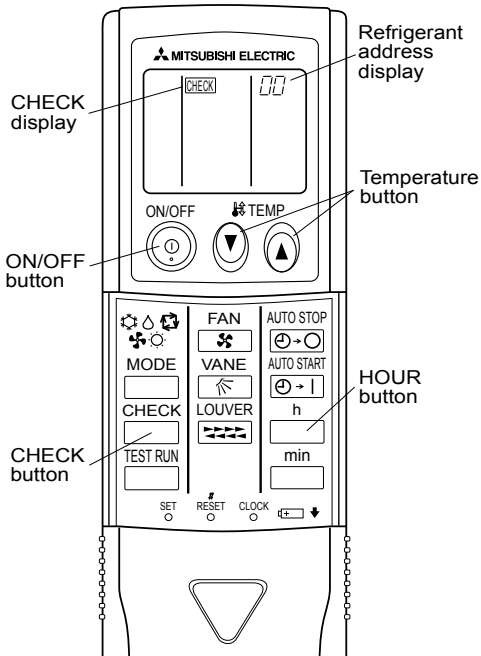

• Refer to the following tables for details on the check codes.

[Output pattern A]

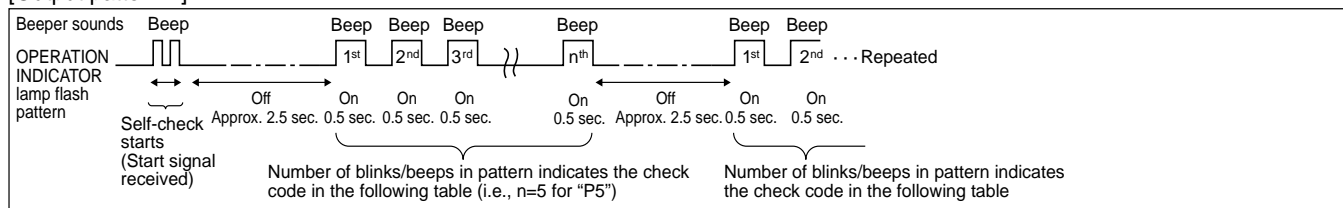

[Output pattern B]

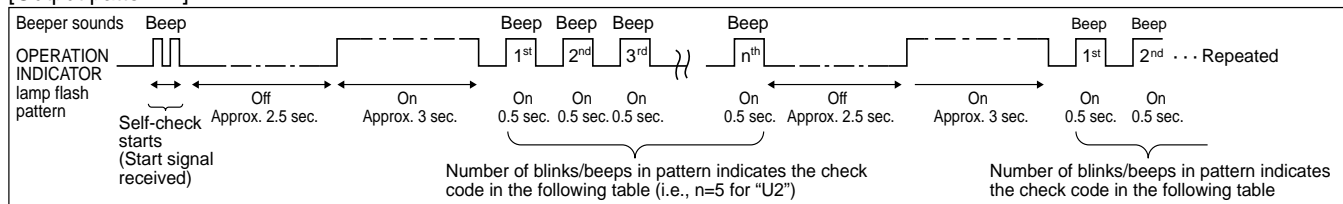

[Output pattern A] Errors detected by indoor unit

Wireless remote controller	Wired remote controller	Symptom	Remark
Beeper sounds/OPERATION INDICATOR lamp flashes (Number of times)	Check code		
1	P1	Intake sensor error	As for indoor unit, refer to indoor unit's service manual.
2	P2	Pipe (TH2) sensor error	
	P9	Pipe (TH5) sensor error	
3	E6,E7	Indoor/outdoor unit communication error	
4	P4	Drain sensor error/Float switch connector (CN4F) open	
	P5	Drain pump error	
5	PA	Forced compressor stop (due to water leakage abnormality)	
6	P6	Freezing/Overheating protection operation	
7	EE	Communication error between indoor and outdoor units	
9	E4, E5	Remote controller signal receiving error	
12	Fb (FB)*	Indoor unit control system error (memory error, etc.)	
14	PL	Abnormality of refrigerant circuit	
–	E0, E3	Remote controller transmission error	
–	E1, E2	Remote controller control board error	

[Output pattern B] Errors detected by unit other than indoor unit (outdoor unit, etc.)

Wireless remote controller	Wired remote controller	Symptom
Beeper sounds/OPERATION INDICATOR lamp flashes (Number of times)	Check code	
1	E9	Indoor/outdoor unit communication error (Transmitting error) (Outdoor unit)
2	UP	Compressor overcurrent interruption
3	U3,U4	Open/short of outdoor unit thermistors
14	Others	Other errors (Refer to the technical manual for the outdoor unit.)

Notes: 1. If the beeper does not sound again after the initial 2 beeps to confirm the self-check start signal was received and the OPERATION INDICATOR lamp does not come on, there are no error records.

2. If the beeper sounds 3 times continuously "beep, beep, beep (0.4 + 0.4 + 0.4 sec.)" after the initial 2 beeps to confirm the self-check start signal was received, the specified refrigerant address is incorrect.

*The check code in the parenthesis indicates PAR-30MAA model.

11-4. TROUBLE CRITERION OF MAIN PARTS

SUZ-KA25VA4.TH SUZ-KA35VA4.TH SUZ-KA50VA4.TH SUZ-KA60VA4.TH SUZ-KA71VA4.TH

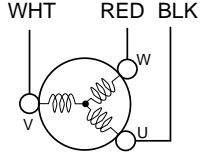
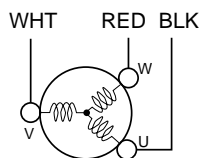
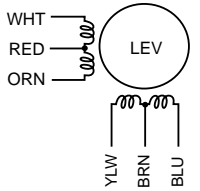
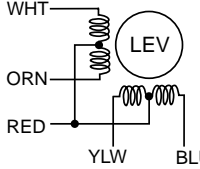
Parts name	Check method and criterion	Figure																
Defrost thermistor (RT61) Fin temperature thermistor (RT64) Ambient temperature thermistor (RT65) Outdoor heat exchanger temperature thermistor(RT68)	Measure the resistance with a tester. Refer to 11-6. "Test point diagram and voltage", 11-6-1. (KA25/35/50) or 11-6-2. (KA60/71) "Inverter P.C. board", for the chart of thermistor.																	
Discharge temperature thermistor (RT62)	Measure the resistance with a tester. Before measurement, hold the thermistor with your hands to warm it up. Refer to 11-6. "Test point diagram and voltage", 11-6-1. (KA25/35/50) or 11-6-2. (KA60/71) "Inverter P.C. board", for the chart of thermistor.																	
Compressor	Measure the resistance between terminals with a tester. (Temperature: -10°C ~ 40°C) <table border="1"> <thead> <tr> <th rowspan="2"></th> <th colspan="4">Normal</th> </tr> <tr> <th>SUZ-KA25VA4.TH</th> <th>SUZ-KA35VA4.TH</th> <th>SUZ-KA50/60VA4.TH</th> <th>SUZ-KA71VA4.TH</th> </tr> </thead> <tbody> <tr> <td>U-V</td> <td rowspan="3">1.36 Ω ~ 1.93 Ω</td> <td rowspan="3">1.52 Ω ~ 2.17 Ω</td> <td rowspan="3">0.78 Ω ~ 1.11 Ω</td> <td rowspan="3">0.92 Ω ~ 1.12 Ω</td> </tr> <tr> <td>U-W</td> </tr> <tr> <td>V-W</td> </tr> </tbody> </table>		Normal				SUZ-KA25VA4.TH	SUZ-KA35VA4.TH	SUZ-KA50/60VA4.TH	SUZ-KA71VA4.TH	U-V	1.36 Ω ~ 1.93 Ω	1.52 Ω ~ 2.17 Ω	0.78 Ω ~ 1.11 Ω	0.92 Ω ~ 1.12 Ω	U-W	V-W	
	Normal																	
	SUZ-KA25VA4.TH	SUZ-KA35VA4.TH	SUZ-KA50/60VA4.TH	SUZ-KA71VA4.TH														
U-V	1.36 Ω ~ 1.93 Ω	1.52 Ω ~ 2.17 Ω	0.78 Ω ~ 1.11 Ω	0.92 Ω ~ 1.12 Ω														
U-W																		
V-W																		
Outdoor fan motor	Measure the resistance between terminals with a tester. (Temperature: -10°C ~ 40°C) <table border="1"> <thead> <tr> <th rowspan="2">Color of the lead wire</th> <th colspan="2">Normal</th> </tr> <tr> <th>SUZ-KA25/35VA4.TH</th> <th>SUZ-KA50/60/71VA4.TH</th> </tr> </thead> <tbody> <tr> <td>WHT - BLK</td> <td rowspan="3">29 Ω ~ 42 Ω</td> <td rowspan="3">12 Ω ~ 17 Ω</td> </tr> <tr> <td>BLK - RED</td> </tr> <tr> <td>RED - WHT</td> </tr> </tbody> </table>	Color of the lead wire	Normal		SUZ-KA25/35VA4.TH	SUZ-KA50/60/71VA4.TH	WHT - BLK	29 Ω ~ 42 Ω	12 Ω ~ 17 Ω	BLK - RED	RED - WHT							
Color of the lead wire	Normal																	
	SUZ-KA25/35VA4.TH	SUZ-KA50/60/71VA4.TH																
WHT - BLK	29 Ω ~ 42 Ω	12 Ω ~ 17 Ω																
BLK - RED																		
RED - WHT																		
R.V. coil (21S4)	Measure the resistance between terminals with a tester. (Temperature : -10°C ~ 40°C) <table border="1"> <thead> <tr> <th>Normal</th> </tr> </thead> <tbody> <tr> <td>1.19 kΩ ~ 1.78 kΩ</td> </tr> </tbody> </table>	Normal	1.19 kΩ ~ 1.78 kΩ															
Normal																		
1.19 kΩ ~ 1.78 kΩ																		
Expansion valve coil (LEV)	Measure the resistance with a tester. (Temperature : -10°C ~ 40°C) SUZ-KA25/35VA4.TH <table border="1"> <thead> <tr> <th>Color of the lead wire</th> <th>Normal</th> </tr> </thead> <tbody> <tr> <td>WHT - RED</td> <td rowspan="4">37 Ω ~ 54 Ω</td> </tr> <tr> <td>RED - ORN</td> </tr> <tr> <td>YLW - BRN</td> </tr> <tr> <td>BRN - BLU</td> </tr> </tbody> </table>	Color of the lead wire	Normal	WHT - RED	37 Ω ~ 54 Ω	RED - ORN	YLW - BRN	BRN - BLU										
	Color of the lead wire	Normal																
WHT - RED	37 Ω ~ 54 Ω																	
RED - ORN																		
YLW - BRN																		
BRN - BLU																		
Measure the resistance with a tester. (Temperature : -10°C ~ 40°C) SUZ-KA50/60/71VA4.TH <table border="1"> <thead> <tr> <th>Color of the lead wire</th> <th>Normal</th> </tr> </thead> <tbody> <tr> <td>RED - ORN</td> <td rowspan="4">37 Ω ~ 54 Ω</td> </tr> <tr> <td>RED - WHT</td> </tr> <tr> <td>RED - BLU</td> </tr> <tr> <td>RED - YLW</td> </tr> </tbody> </table>	Color of the lead wire	Normal	RED - ORN	37 Ω ~ 54 Ω	RED - WHT	RED - BLU	RED - YLW											
Color of the lead wire	Normal																	
RED - ORN	37 Ω ~ 54 Ω																	
RED - WHT																		
RED - BLU																		
RED - YLW																		

11-5. TROUBLESHOOTING FLOW

A How to check inverter/compressor

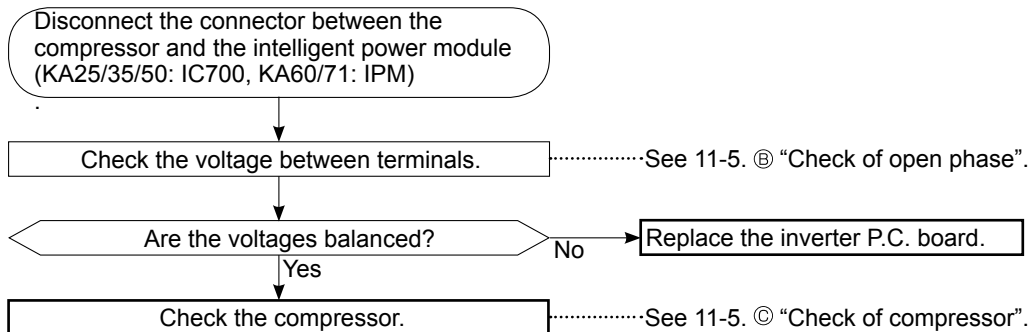

B Check of open phase

- With the connector between the compressor and the intelligent power module disconnected, activate the inverter and check if the inverter is normal by measuring the **voltage balance** between the terminals.

Output voltage is 50 - 130V. (The voltage may differ according to the tester.)

<< Operation method (Test run operation)>>

- For the PAR-31MAA, select “Service” → “Test Run” from the main menu to start the test run, and then select the cooling mode.
- For details or for other information about starting the test run when using remote controllers, refer to the installation manual for the indoor unit or the remote controller.

<<Measurement point>>

At 3 points

BLK (U) - WHT (V)

BLK (U) - RED (W)

WHT (V) - RED (W)

* Measure AC voltage between the lead wires at 3 points.

NOTE: 1. Output voltage varies according to power supply voltage.

2. Measure the voltage by analog type tester.

3. During this check, LED of the inverter P.C. board flashes 9 times. (KA25/35/50: Refer to 11-6-1, KA60/71: 11-6-2)

C Check of compressor

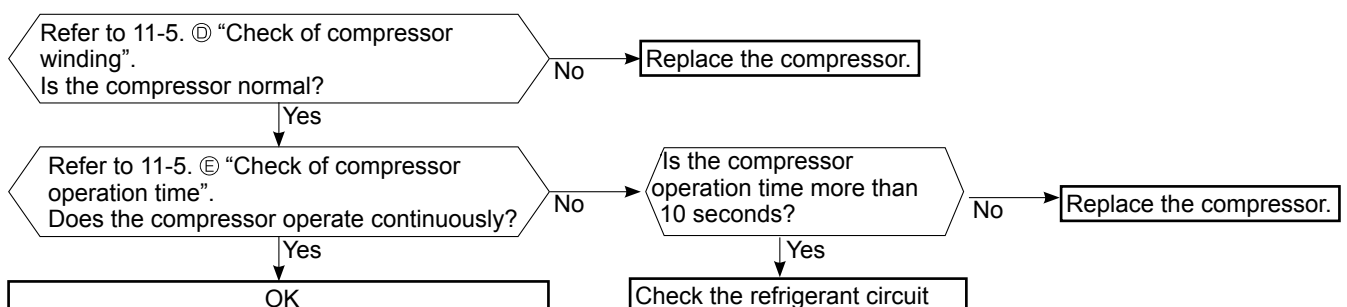

D Check of compressor winding

- Disconnect the connector between the compressor and intelligent power module, and measure the resistance between the compressor terminals.

<<Measurement point>>

at 3 points

BLK-WHT

BLK-RED

WHT-RED

* Measure the resistance between the lead wires at 3 points.

<<Judgement>>

Refer to 11-4.

0 [Ω]Abnormal [short]

Infinite [Ω]Abnormal [open]

NOTE: Be sure to zero the ohmmeter before measurement.

E Check of compressor operation time

- Connect the compressor and activate the inverter. Then measure the time until the inverter stops due to over current.

<<Operation method>>

Start heating or cooling test run.

(TEST RUN OPERATION : Refer to 11-5 ③.)

<<Measurement>>

Measure the time from the start of compressor to the stop of compressor due to overcurrent.

<<Judgement>>

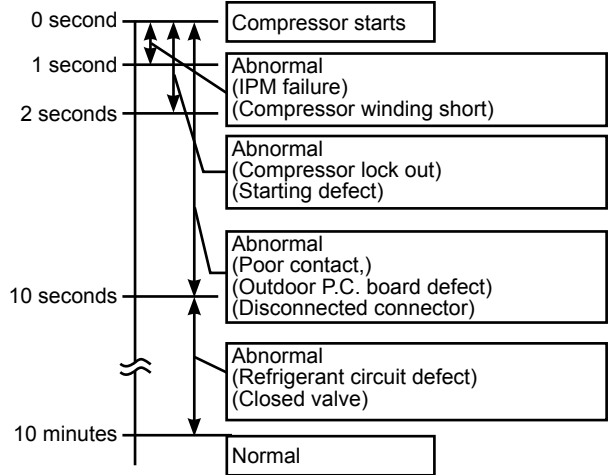

F Check of outdoor thermistors

Disconnect the connector of thermistor in the outdoor P.C. board (see below table), and measure the resistance of thermistor.

Is the resistance of thermistor normal?

(KA25/35/50: Refer to 11-6-1, KA60/71: 11-6-2.)

No

Replace the thermistor except RT64.
When RT64 is abnormal, replace the inverter P.C. board.

Yes

Reconnect the connector of thermistor.

Turn ON the power supply and press EMERGENCY OPERATION switch.

Does the unit operate for 10 minutes or more without showing thermistor abnormality?

No

Replace the inverter P.C. board.

Yes

OK.
(Cause is poor contact.)

Thermistor	Symbol	Connector, Pin No.		Board
		SUZ-KA25/35/50VA4.TH	SUZ-KA60/71VA4.TH	
Defrost	RT61	Between CN641 pin1 and pin2	Between CN671 pin1 and pin2	Inverter P.C. board
Discharge temperature	RT62	Between CN641 pin3 and pin4	Between CN671 pin3 and pin4	
Fin temperature	RT64	Between CN642 pin1 and pin2	Between CN673 pin1 and pin2	
Ambient temperature	RT65	Between CN643 pin1 and pin2	Between CN672 pin1 and pin2	
Outdoor heat exchanger temperature	RT68	Between CN644 pin1 and pin3	Between CN671 pin5 and pin6	

G Check of R.V. coil

First of all, measure the resistance of R.V. coil to check if the coil is defective. Refer to 11-4.
 In case CN721(KA25/35/50)/CN602(KA60/71) is not connected or R.V. coil is open, voltage is generated between the terminal pins of the connector although any signal is not being transmitted to R.V. coil.
 Check if CN721(KA25/35/50)/CN602(KA60/71) is connected.

Unit operates COOL mode even if it is set to HEAT mode.

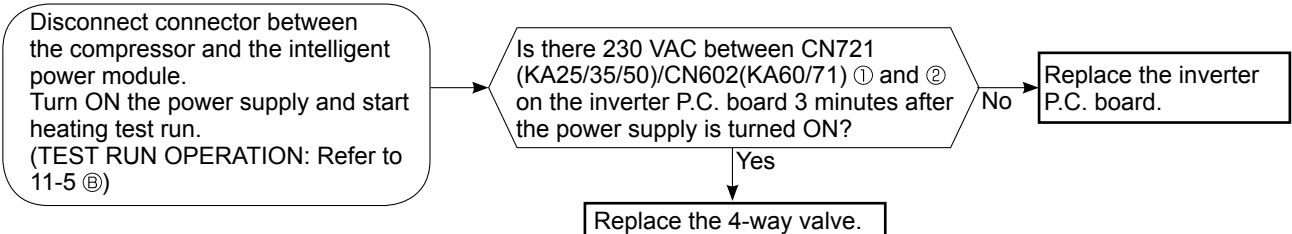

Unit operates HEAT mode even if it is set to COOL mode.

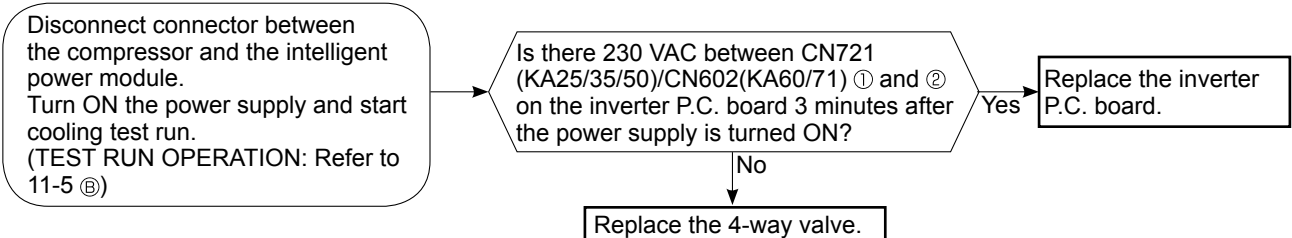

H Check of outdoor fan motor

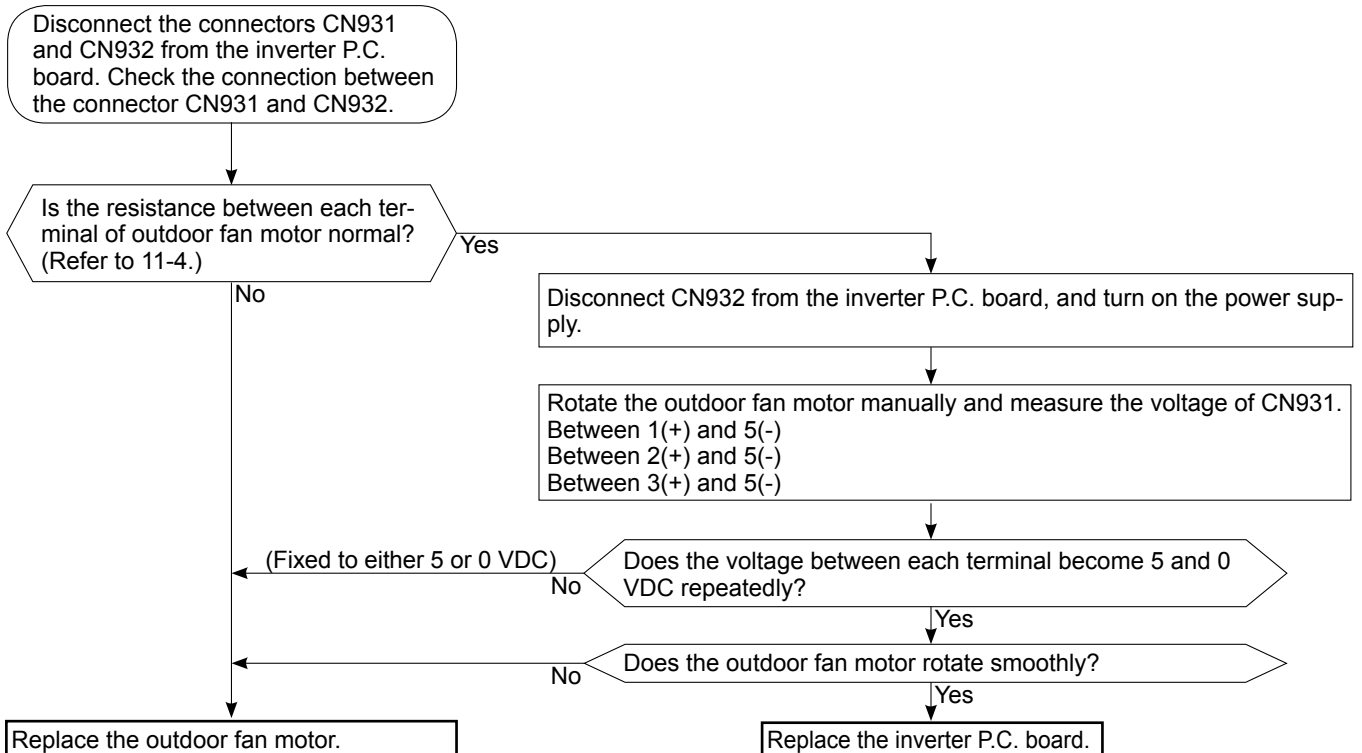

① Check of LEV

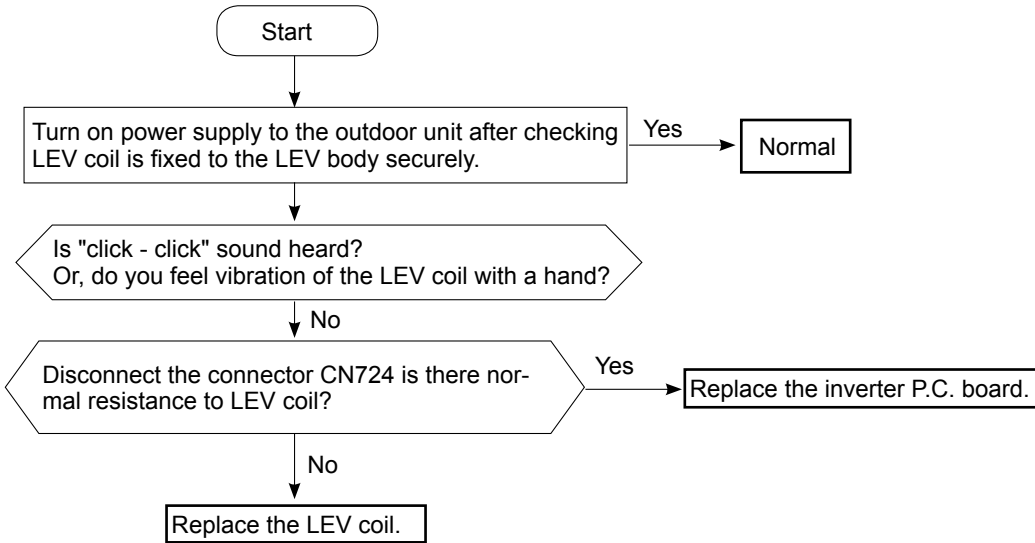

② Check of inverter P.C. board

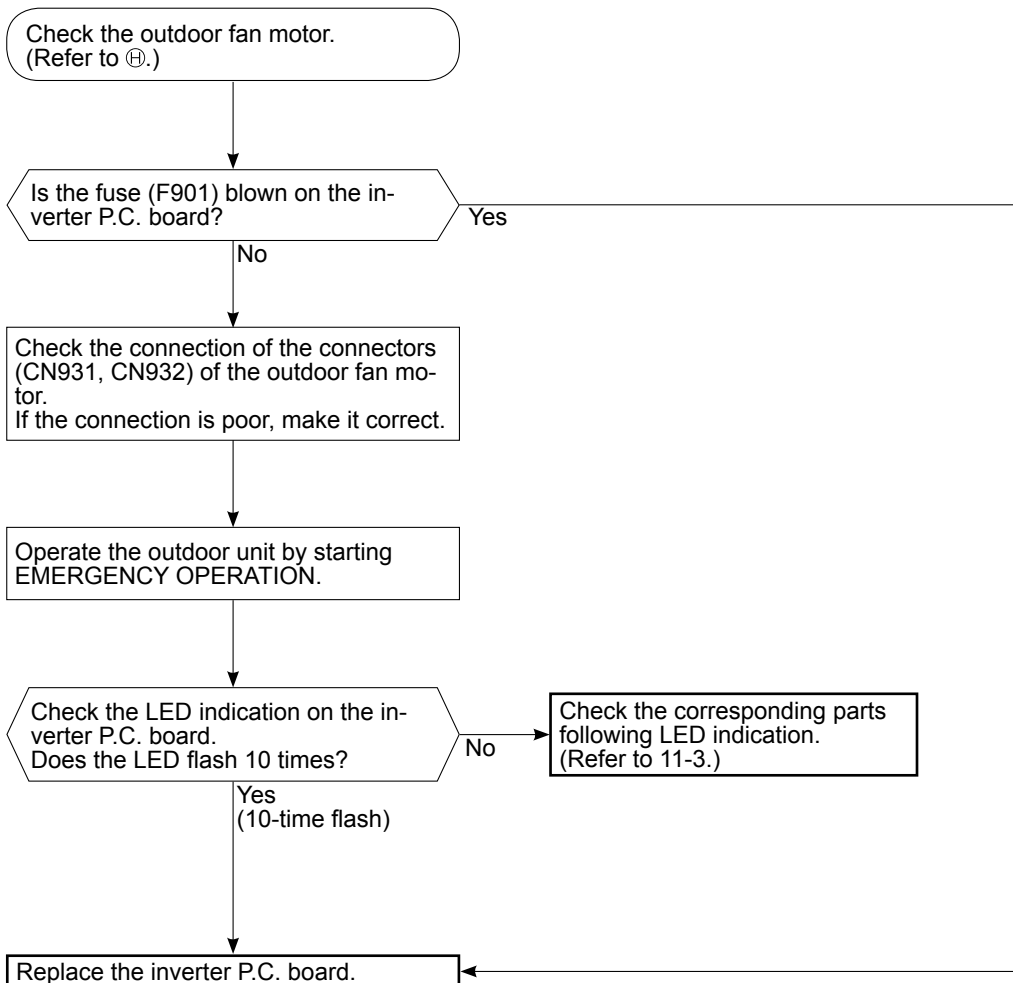

K Electromagnetic noise enters into TV sets or radios

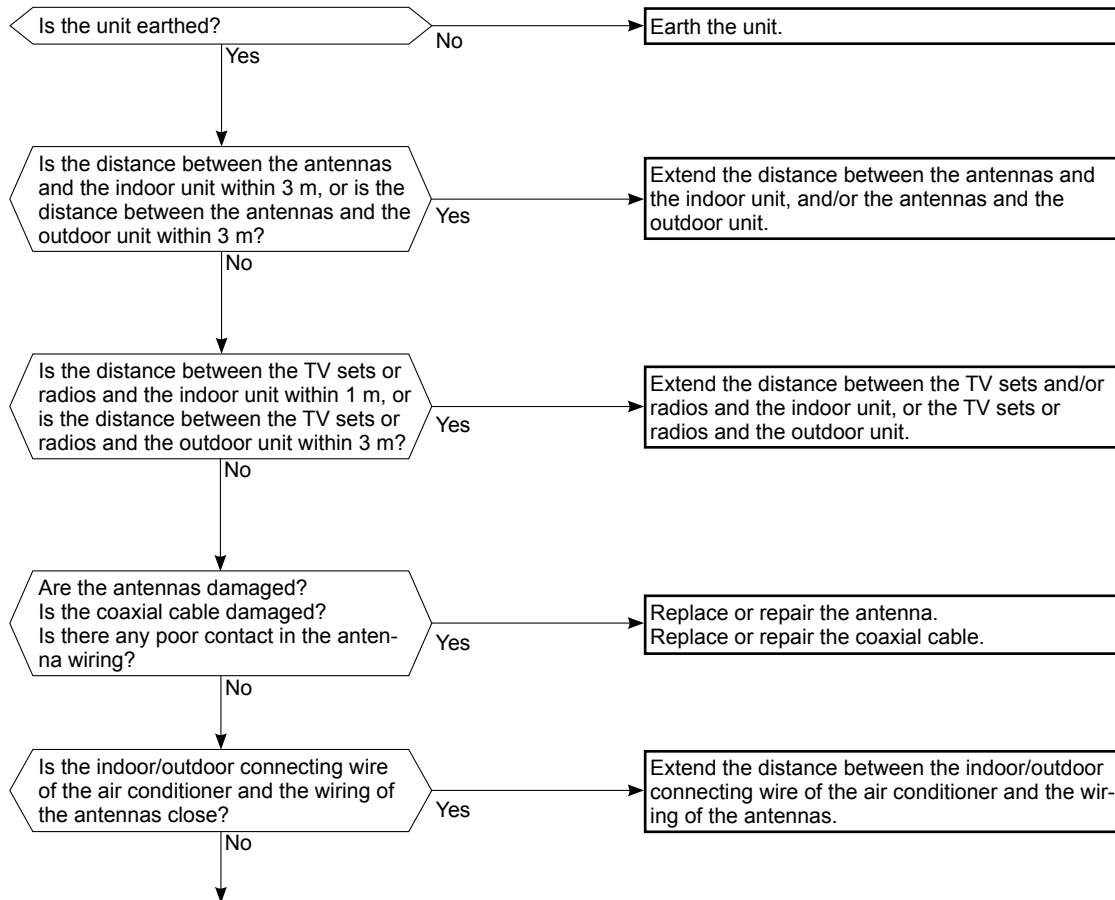

Even if all of the above conditions are fulfilled, the electromagnetic noise may enter, depending on the electric field strength or the installation condition (combination of specific conditions such as antennas or wiring).

Check the following before asking for service.

1. Devices affected by the electromagnetic noise
TV sets, radios (FM/AM broadcast, shortwave)
2. Channel, frequency, broadcast station affected by the electromagnetic noise
3. Channel, frequency, broadcast station unaffected by the electromagnetic noise
4. Layout of ;
indoor/outdoor unit of the air conditioner, indoor/outdoor wiring, earth wire, antennas, wiring from antennas, receiver
5. Electric field intensity of the broadcast station affected by the electromagnetic noise
6. Presence or absence of amplifier such as booster
7. Operation condition of air conditioner when the electromagnetic noise enters in
 - 1) Turn OFF the power supply once, and then turn ON the power supply. In this situation, check for the electromagnetic noise.
 - 2) Within 3 minutes after turning ON the power supply, press OPERATE/STOP (ON/OFF) button on the remote controller for power ON, and check for the electromagnetic noise.
 - 3) After a short time (3 minutes later after turning ON), the outdoor unit starts running. During operation, check for the electromagnetic noise.
 - 4) Press OPERATE/STOP (ON/OFF) button on the remote controller for power OFF, when the outdoor unit stops but the indoor/outdoor communication still runs on. In this situation, check for the electromagnetic noise.

11-6. TEST POINT DIAGRAM AND VOLTAGE

11-6-1. Inverter P.C. board

SUZ-KA25VA4.TH

SUZ-KA35VA4.TH

SUZ-KA50VA4.TH

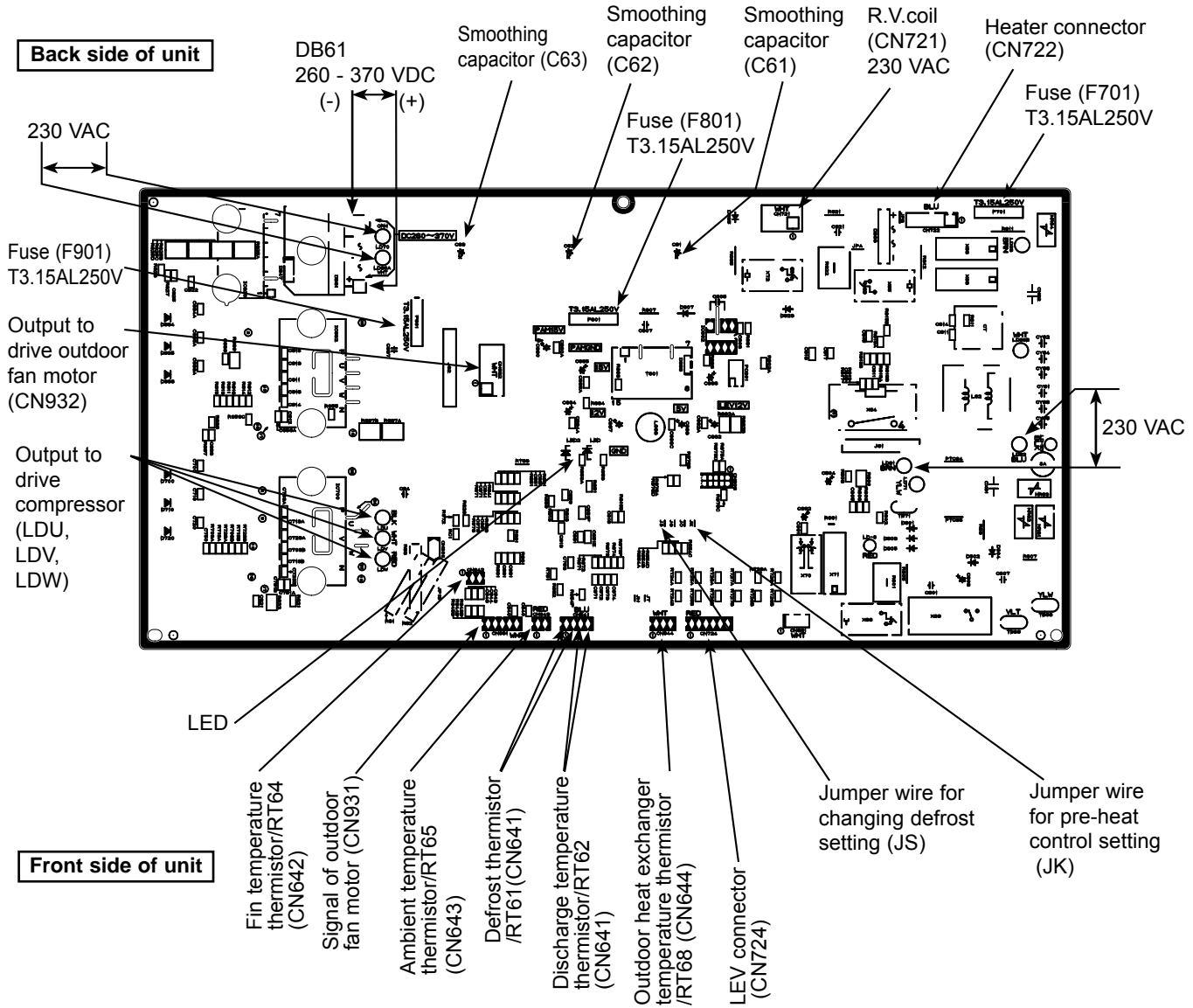

Defrost thermistor (RT61)
Ambient temperature thermistor (RT65)
Outdoor heat exchanger temperature thermistor (RT68)

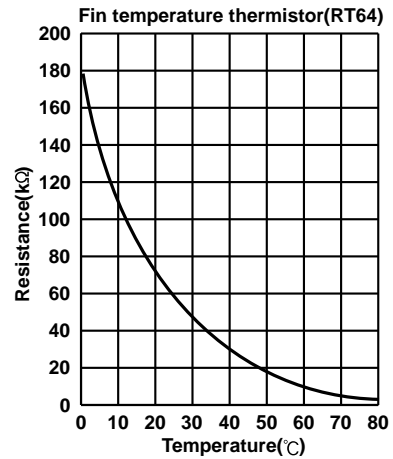
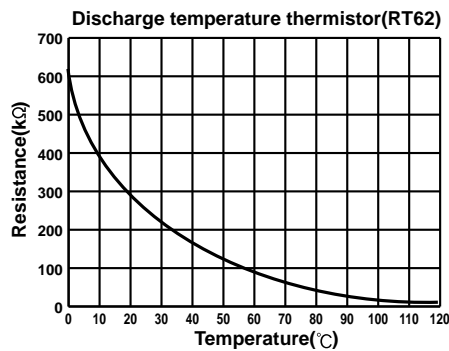
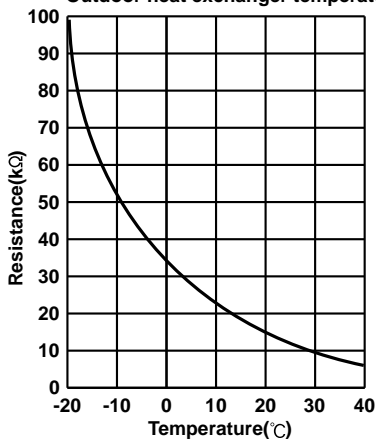

11-6-2. Inverter P.C. board
SUZ-KA60VA4.TH SUZ-KA71VA4.TH

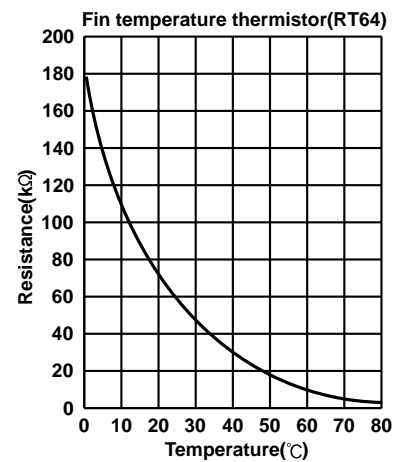
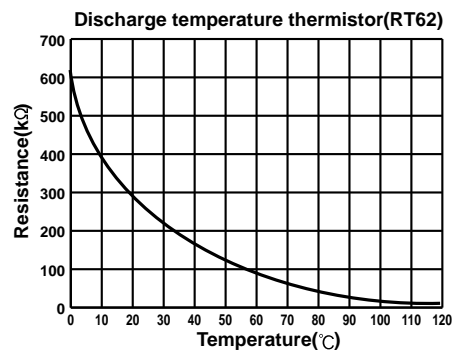
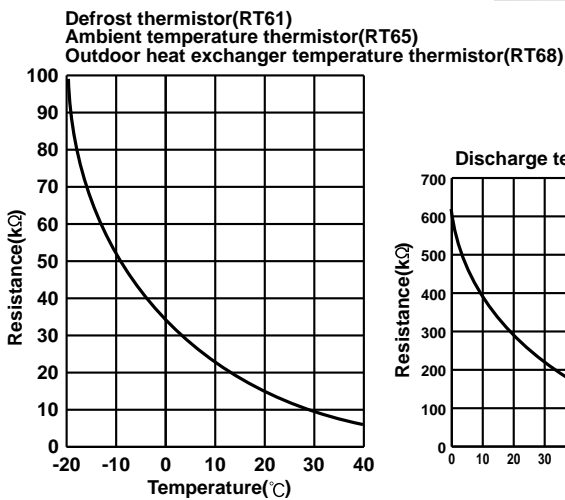
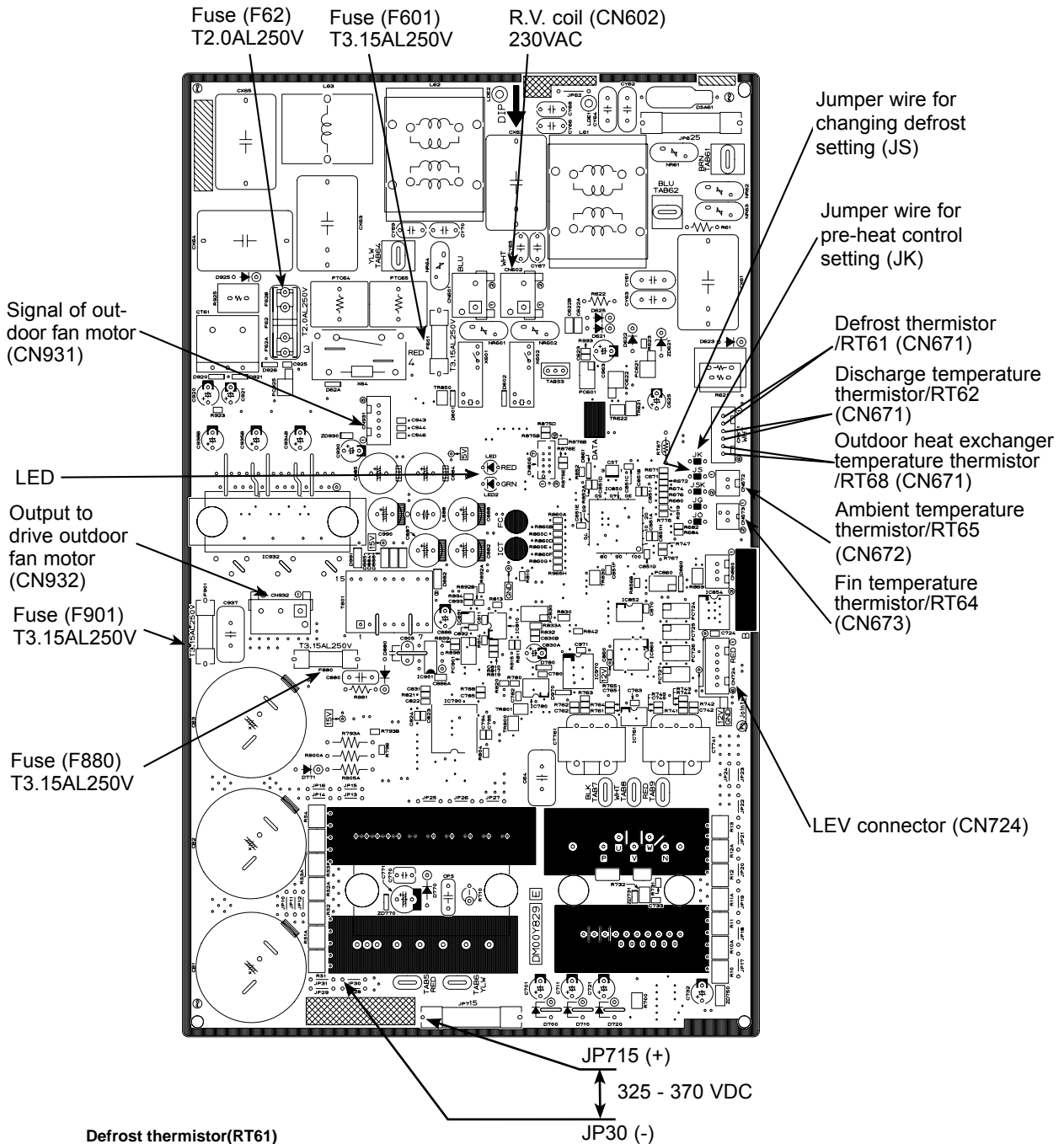

<"Terminal with locking mechanism" Detaching points>

The terminal which has the locking mechanism can be detached as shown below.
 There are two types (Refer to (1) and (2)) of the terminal with locking mechanism.
 The terminal without locking mechanism can be detached by pulling it out.
 Check the shape of the terminal before detaching.

(1) Slide the sleeve and check if there is a locking lever or not.

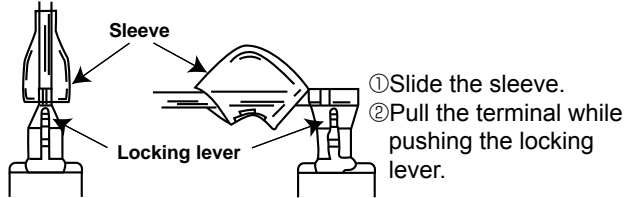

(2) The terminal with this connector has the locking mechanism.

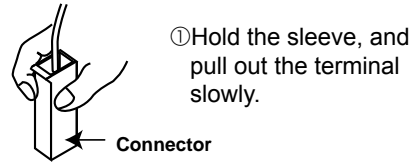

**SUZ-KA25VA4.TH
 OUTDOOR UNIT**

SUZ-KA35VA4.TH

NOTE: Turn OFF power supply before disassembling.

OPERATING PROCEDURE	PHOTOS
<p>1. Removing the cabinet</p> <p>(1) Remove the screw fixing the service panel. (2) Pull down the service panel and remove it. (3) Disconnect the power supply and indoor/outdoor connecting wire. (4) Remove the screws fixing the top panel. (5) Remove the top panel. (6) Remove the screws fixing the cabinet. (7) Remove the cabinet. (8) Remove the screws fixing the back panel. (9) Remove the back panel.</p>	<p>Photo 1</p> <p>Screws of the top panel Screws of the top panel Back panel Screws of the back panel Screws of the cabinet Service panel</p> <p>Photo 2</p> <p>Screw of the cabinet Screw of the service panel Direction to remove Hooks Screws of the cabinet</p>

OPERATING PROCEDURE

2. Removing the inverter assembly, inverter P.C. board

- (1) Remove the cabinet and panels. (Refer to procedure 1.)
- (2) Disconnect the lead wire to the reactor and the following connectors:
<Inverter P.C. board>
CN721 (R.V. coil)
CN932 (Fan motor)
CN641 (Defrost thermistor and discharge temperature thermistor)
CN643 (Ambient temperature thermistor)
CN644 (Outdoor heat exchanger temperature thermistor)
CN724 (LEV)
- (3) Remove the compressor connector (CN61).
- (4) Remove the screws fixing the relay panel. (Photo 3)
- (5) Remove the inverter assembly. (Photo 4)
- (6) Remove the screw of the earth wire and screw of the T.B.support. (Photo 4)
- (7) Remove the relay panel from the inverter assembly.
- (8) Remove the inverter P.C. board from the relay panel.

3. Removing R.V. coil

- (1) Remove the cabinet and panels. (Refer to procedure 1.)
- (2) Disconnect the following connectors:
<Inverter P.C. board>
CN721 (R.V. coil)
- (3) Remove the R.V. coil. (Photo 5)

4. Removing the discharge temperature thermistor, defrost thermistor, outdoor heat exchanger temperature thermistor and ambient temperature thermistor

- (1) Remove the cabinet and panels. (Refer to procedure 1.)
- (2) Disconnect the lead wire to the reactor and the following connectors:
<Inverter P.C. board>
CN641 (Defrost thermistor and discharge temperature thermistor)
CN643 (Ambient temperature thermistor)
CN644 (Outdoor heat exchanger temperature thermistor)
- (3) Pull out the discharge temperature thermistor from its holder. (Photo 5)
- (4) Pull out the defrost thermistor from its holder. (Photo 6)
- (5) Pull out the outdoor heat exchanger temperature thermistor from its holder. (Photo 6)
- (6) Pull out the ambient temperature thermistor from its holder.

PHOTOS

Photo 3

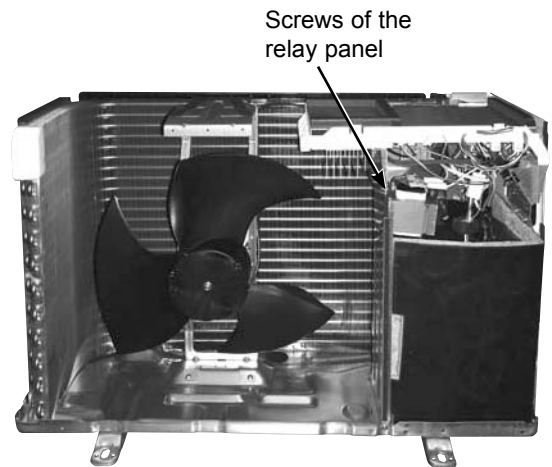

Photo 4 (Inverter assembly)

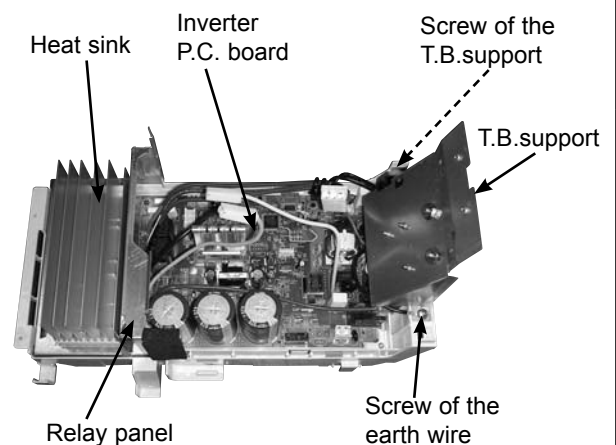

Photo 5



OPERATING PROCEDURE

5. Removing outdoor fan motor

- (1) Remove the cabinet and panels. (Refer to procedure 1.)
- (2) Disconnect the following connectors:
<Inverter P.C. board>
CN932 (Fan motor)
- (3) Remove the propeller nut. (Photo 7)
- (4) Remove the propeller. (Photo 7)
- (5) Remove the screws fixing the fan motor. (Photo 7)
- (6) Remove the fan motor.

6. Removing the compressor and 4-way valve

- (1) Remove the cabinet and panels. (Refer to procedure 1.)
- (2) Remove the inverter assembly. (Refer to procedure 2.)
- (3) Recover gas from the refrigerant circuit.
NOTE: Recover gas from the pipes until the pressure gauge shows 0 kg/cm² (0 MPa).
- (4) Detach the welded part of the suction and the discharge pipe connected with compressor.
- (5) Remove the nuts of compressor legs.
- (6) Remove the compressor.
- (7) Detach the welded part of pipes connected with 4-way valve. (Photo 8)

PHOTOS

Photo 6

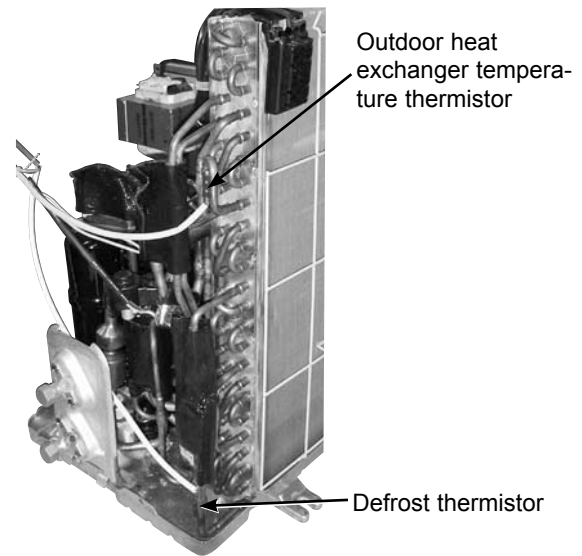

Photo 7

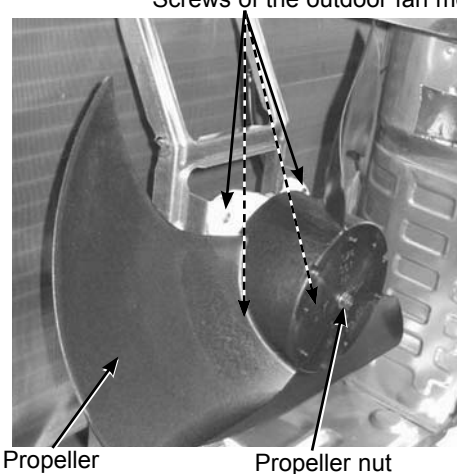
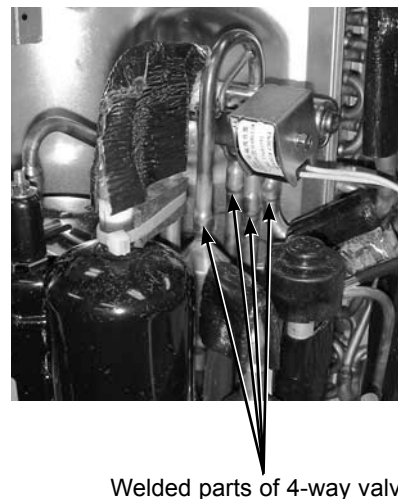
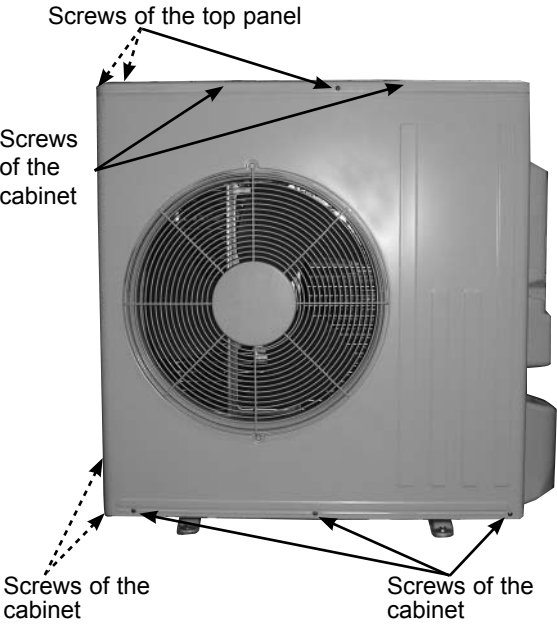
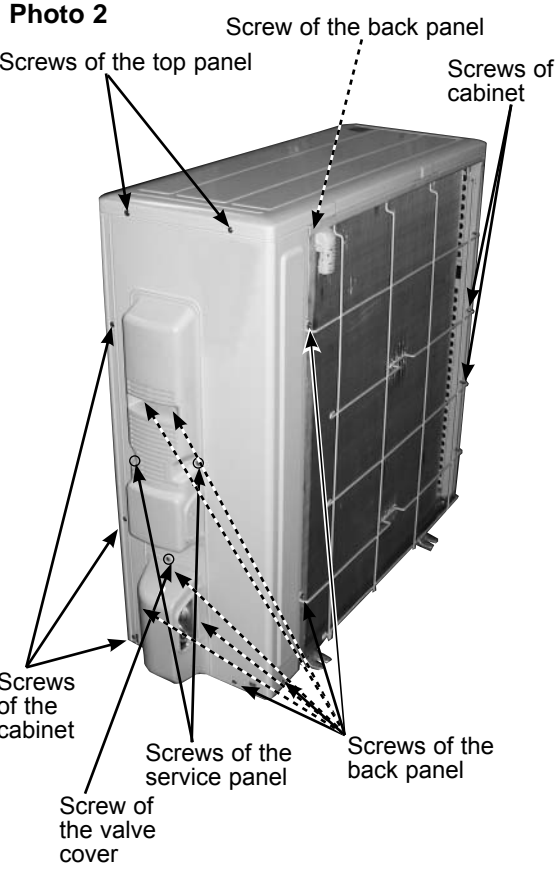

Photo 8



SUZ-KA50VA4.TH

NOTE: Turn OFF power supply before disassembly.

OPERATING PROCEDURE	PHOTOS
<p>1. Removing the cabinet</p> <ol style="list-style-type: none">(1) Remove the screws of the service panel.(2) Remove the screws of the top panel.(3) Remove the screw of the valve cover.(4) Remove the service panel.(5) Remove the top panel.(6) Remove the valve cover.(7) Disconnect the power supply and indoor/outdoor connecting wire.(8) Remove the screws of the cabinet.(9) Remove the cabinet.(10) Remove the screws of the back panel.(11) Remove the back panel.	<p>Photo 1</p>  <p>Screws of the top panel</p> <p>Screws of the cabinet</p> <p>Screws of the cabinet</p> <p>Screws of the cabinet</p> <p>Photo 2</p>  <p>Screw of the back panel</p> <p>Screws of the top panel</p> <p>Screws of the cabinet</p> <p>Screws of the cabinet</p> <p>Screws of the cabinet</p> <p>Screws of the service panel</p> <p>Screws of the back panel</p> <p>Screw of the valve cover</p>

OPERATING PROCEDURE

2. Removing the inverter assembly, inverter P.C. board

- (1) Remove the cabinet and panels. (Refer to procedure 1.)
- (2) Disconnect the lead wire to the reactor and the following connectors:
<Inverter P.C. board>
CN721 (R.V. coil)
CN931, CN932 (Fan motor)
CN641 (Defrost thermistor and discharge temperature thermistor)
CN643 (Ambient temperature thermistor)
CN644 (Outdoor heat exchanger temperature thermistor)
CN724 (LEV)
- (3) Remove the compressor connector.
- (4) Remove the screws fixing the heat sink support and the separator.
- (5) Remove the fixing screws of the terminal block support and the back panel.
- (6) Remove the inverter assembly.
- (7) Remove the screw of the earth wire, screw of the P.C. board cover and screws of the terminal block support.
- (8) Remove the heat sink support from the P.C. board support.
- (9) Remove the screw of the inverter P.C. board and the inverter P.C. board from the P.C. board support.

3. Removing R.V. coil

- (1) Remove the cabinet and panels. (Refer to procedure 1.)
- (2) Disconnect the following connector:
<Inverter P.C. board>
CN721 (R.V. coil)
- (3) Remove the R.V. coil.

PHOTOS

Photo 3

Screw of the heat sink support and the separator

Screw of the terminal block support and the back panel

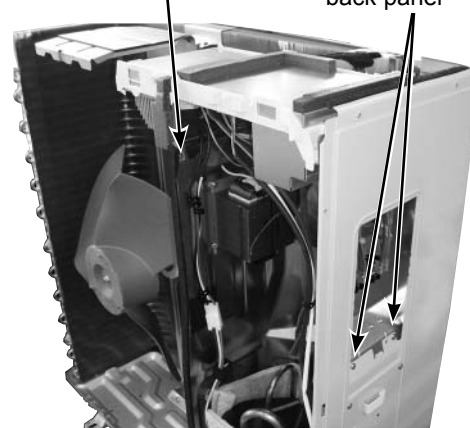

Photo 4

Heat sink

Heat sink support

P.C. board support

Screw of the P.C. board cover

Screw of the inverter P.C. board

Screw of the earth wire

Screws of the terminal block support

Photo 5

Screw of the R.V. coil

Brazed parts of 4-way valve

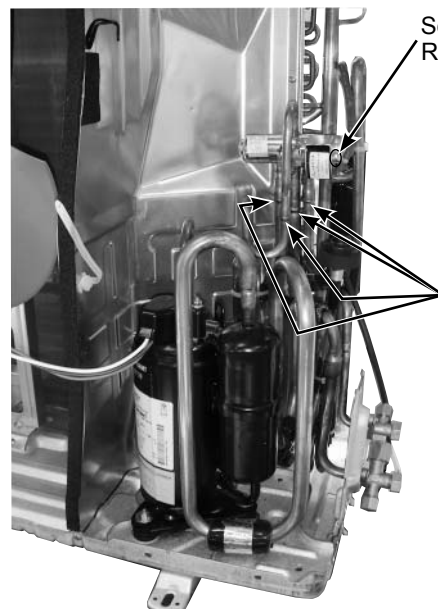

OPERATING PROCEDURE

4. Removing the discharge temperature thermistor, defrost thermistor, outdoor heat exchanger temperature thermistor and ambient temperature thermistor

- (1) Remove the cabinet and panels. (Refer to procedure 1.)
- (2) Disconnect the lead wire to the reactor and the following connectors:
 - <Inverter P.C. board>
 - CN641 (Defrost thermistor and discharge temperature thermistor)
 - CN643 (Ambient temperature thermistor)
 - CN644 (Outdoor heat exchanger temperature thermistor)
- (3) Pull out the discharge temperature thermistor from its holder.
- (4) Pull out the defrost thermistor from its holder.
- (5) Pull out the outdoor heat exchanger temperature thermistor from its holder.
- (6) Pull out the ambient temperature thermistor from its holder.

5. Removing outdoor fan motor

- (1) Remove the top panel, cabinet and service panel. (Refer to procedure 1.)
- (2) Disconnect the following connectors:
 - <Inverter P.C. board>
 - CN931 and CN932 (Fan motor)
- (3) Remove the propeller nut.
- (4) Remove the propeller.
- (5) Remove the screws fixing the fan motor.
- (6) Remove the fan motor.

6. Removing the compressor and 4-way valve

- (1) Remove the top panel, cabinet and service panel. (Refer to procedure 1.)
- (2) Remove the back panel. (Refer to procedure 1.)
- (3) Remove the inverter assembly. (Refer to procedure 2.)
- (4) Recover gas from the refrigerant circuit.

NOTE: Recover gas from the pipes until the pressure gauge shows 0 kg/cm² (0 MPa).
- (5) Detach the brazed part of the suction and the discharge pipe connected with compressor.
- (6) Remove the rieCONNECTOR: Yellow nuts.
- (7) Remove the compressor.
- (8) Detach the brazed part of 4-way valve and pipe. (Photo 5)

PHOTOS

Photo 6

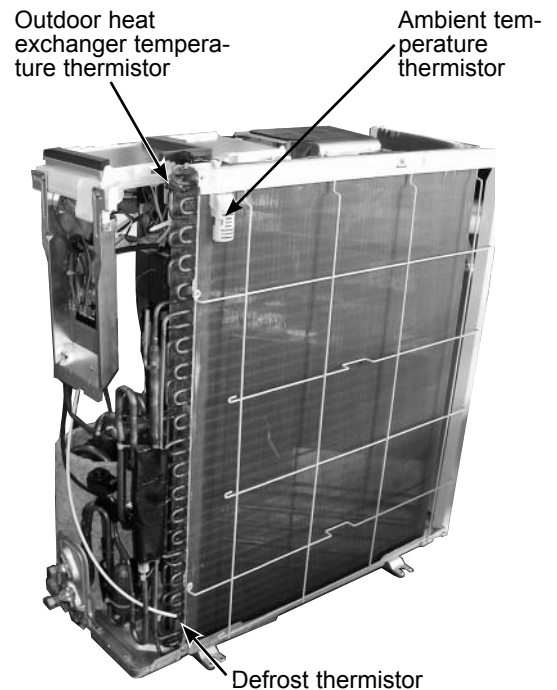

Photo 7

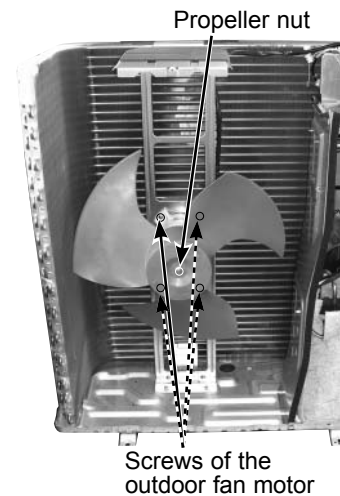
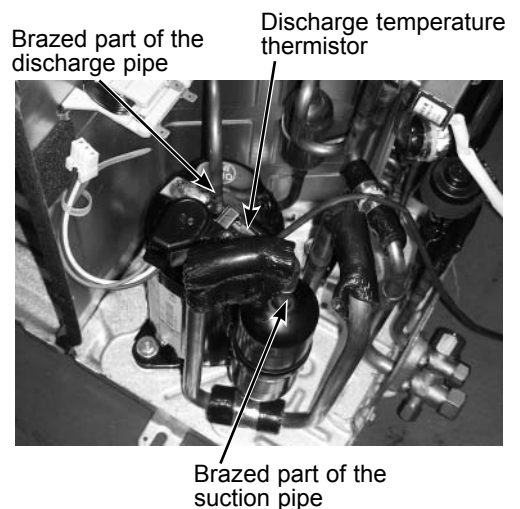
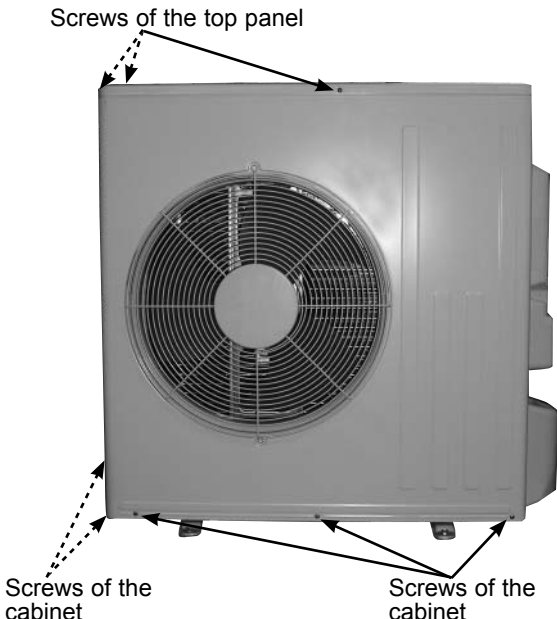
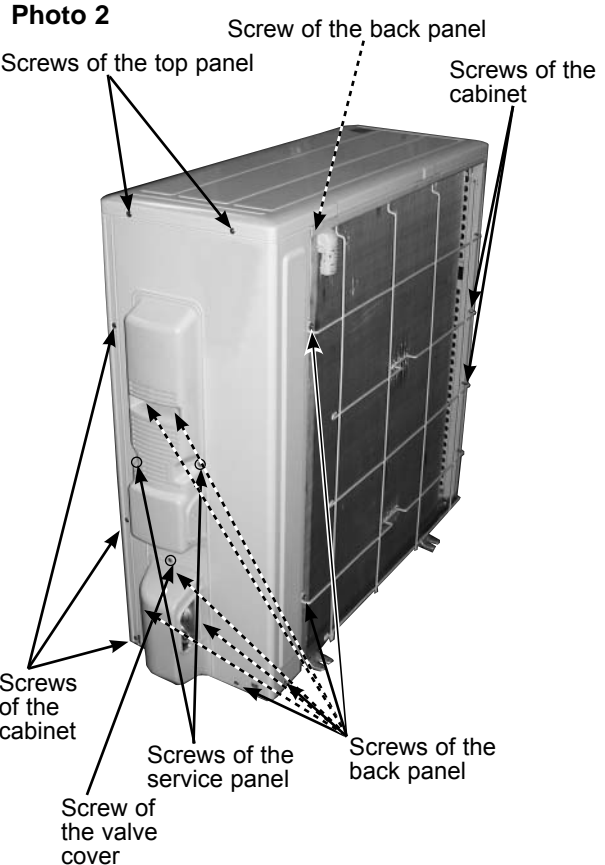

Photo 8



SUZ-KA60VA4.TH
SUZ-KA71VA4.TH

NOTE: Turn OFF power supply before disassembling.

OPERATING PROCEDURE	PHOTOS
<p>1. Removing the cabinet</p> <ol style="list-style-type: none"> (1) Remove the screws of the service panel. (2) Remove the screws of the top panel. (3) Remove the screw of the valve cover. (4) Remove the service panel. (5) Remove the top panel. (6) Remove the valve cover. (7) Disconnect the power supply and indoor/outdoor connecting wire. (8) Remove the screws of the cabinet. (9) Remove the cabinet. (10) Remove the screws of the back panel. (11) Remove the back panel. 	<p>Photo 1</p>  <p>Screws of the top panel</p> <p>Screws of the cabinet</p> <p>Screws of the cabinet</p> <p>Photo 2</p>  <p>Screw of the back panel</p> <p>Screws of the top panel</p> <p>Screws of the cabinet</p> <p>Screws of the cabinet</p> <p>Screws of the back panel</p> <p>Screws of the service panel</p> <p>Screw of the valve cover</p> <p>Screws of the cabinet</p>

OPERATING PROCEDURE

2. Removing the inverter assembly, inverter P.C. board

- (1) Remove the cabinet and panels. (Refer to procedure 1.)
- (2) Disconnect the lead wire to the reactor and the following connectors:
<Inverter P.C. board>
CN602 (R.V. coil)
CN931, CN932 (Fan motor)
CN671 (Defrost thermistor, discharge temperature thermistor and outdoor heat exchanger temperature thermistor)
CN672 (Ambient temperature thermistor)
CN724 (LEV)
- (3) Remove the compressor connector.
- (4) Remove the screws fixing the relay panel.
- (5) Remove the relay panel.
- (6) Remove the earth wires and the lead wires of the inverter P.C. board.
- (7) Remove the screw of the PB support.
- (8) Remove the inverter P.C. board from the relay panel.

3. Removing R.V. coil

- (1) Remove the cabinet and panels. (Refer to procedure 1.)
- (2) Disconnect the following connector:
<Inverter P.C. board>
CN602 (R.V. coil)
- (3) Remove the R.V. coil.

PHOTOS

Photo 3

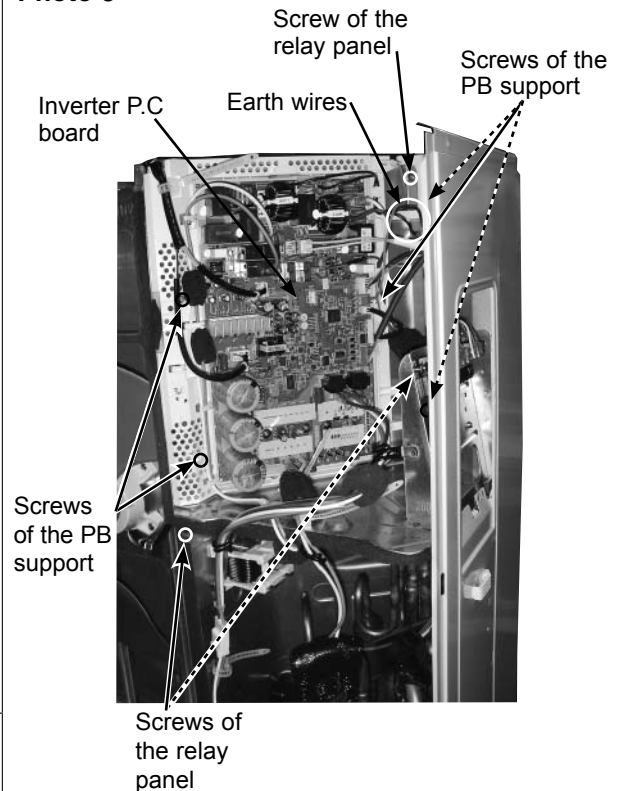
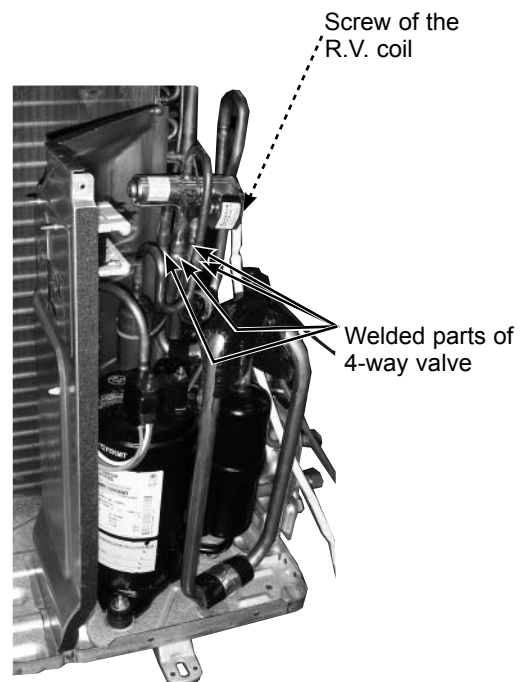

Photo 4



OPERATING PROCEDURE

4. Removing the discharge temperature thermistor, defrost thermistor, outdoor heat exchanger temperature thermistor and ambient temperature thermistor

- (1) Remove the cabinet and panels. (Refer to procedure 1.)
- (2) Disconnect the lead wire to the reactor and the following connectors:
<Inverter P.C. board>
CN671 (Defrost thermistor, discharge temperature thermistor and outdoor heat exchanger temperature thermistor)
CN672 (Ambient temperature thermistor)
- (3) Pull out the discharge temperature thermistor from its holder. (Photo 7)
- (4) Pull out the defrost thermistor from its holder.
- (5) Pull out the outdoor heat exchanger temperature thermistor from its holder.
- (6) Pull out the ambient temperature thermistor from its holder.

5. Removing outdoor fan motor

- (1) Remove the top panel, cabinet and service panel. (Refer to 1.)
- (2) Disconnect the following connectors:
<Inverter P.C. board>
CN931 and CN932 (Fan motor)
- (3) Remove the propeller.
- (4) Remove the screws fixing the fan motor.
- (5) Remove the fan motor.

6. Removing the compressor and 4-way valve

- (1) Remove the top panel, cabinet and service panel. (Refer to procedure 1.)
- (2) Remove the back panel. (Refer to procedure 1.)
- (3) Remove the inverter assembly. (Refer to procedure 2.)
- (4) Recover gas from the refrigerant circuit.
NOTE: Recover gas from the pipes until the pressure gauge shows 0 kg/cm² (0 MPa).
- (5) Detach the welded part of the suction and the discharge pipe connected with compressor.
- (6) Remove the compressor nuts.
- (7) Remove the compressor.
- (8) Detach the welded part of 4-way valve and pipe. (Photo 4)

PHOTOS

Photo 5

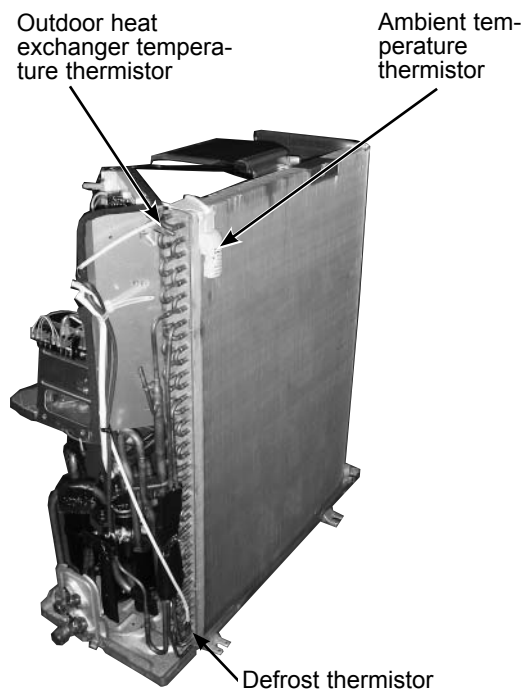

Photo 6

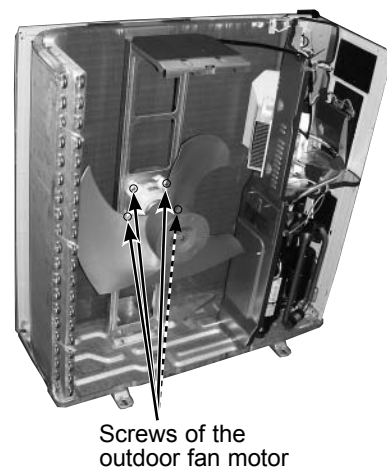
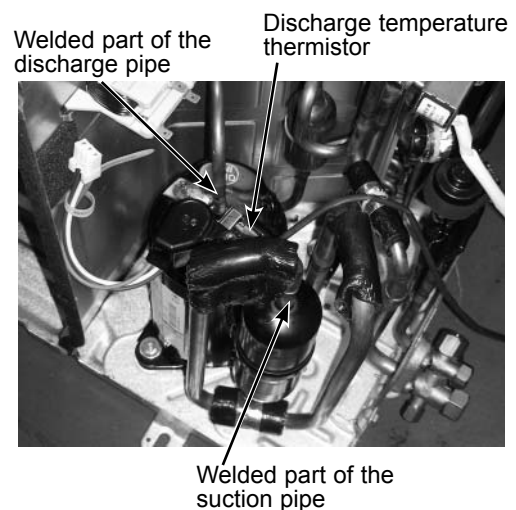

Photo 7



Mr. SLIM™

mitsubishi electric corporation

HEAD OFFICE: TOKYO BLDG., 2-7-3, MARUNOUCHI, CHIYODA-KU, TOKYO100-8310, JAPAN
