

# Air-Conditioners



## SEZ-KD25, KD35, KD50, KD60, KD71 VAQ

### OPERATION MANUAL

**FOR USER**

For safe and correct use, please read this operation manual thoroughly before operating the air-conditioner unit.

### BEDIENUNGSHANDBUCH

**FÜR BENUTZER**

Zum sicheren und einwandfreien Gebrauch der Klimaanlage dieses Bedienungshandbuch vor Inbetriebnahme gründlich durchlesen.

### MANUEL D'UTILISATION

**POUR L'UTILISATEUR**

Pour une utilisation correcte sans risques, veuillez lire le manuel d'utilisation en entier avant de vous servir du climatiseur.

### MANUAL DE INSTRUCCIONES

**PARA EL USUARIO**

Lea este manual de instrucciones hasta el final antes de poner en marcha la unidad de aire acondicionado para garantizar un uso seguro y correcto.

### ISTRUZIONI DI FUNZIONAMENTO

**PER L'UTENTE**

Leggere attentamente questi istruzioni di funzionamento prima di avviare l'unità, per un uso corretto e sicuro della stessa.

### BEDIENINGSHANDLEIDING

**VOOR DE GEBRUIKER**

Voor een veilig en juist gebruik moet u deze bedieningshandleiding grondig doorlezen voordat u de airconditioner gebruikt.

### DRIFTSMANUAL

**FÖR ANVÄNDAREN**

Läs denna driftsmanual noga för säkert och korrekt bruk innan luftkonditioneringen används.

### DRIFTSMANUAL

**TIL BRUGER**

Læs venligst denne driftsmanual grundigt før airconditionanlægget betjenes af hensyn til sikker og korrekt brug.

### MANUAL DE OPERAÇÃO

**PARA O UTILIZADOR**

Para segurança e utilização correctas, leia atentamente o manual de operação antes de pôr a funcionar a unidade de ar condicionado.

### ΕΓΧΕΙΡΙΔΙΟ ΟΔΗΓΙΩΝ ΧΡΗΣΕΩΣ

**ΓΙΑ ΤΟΝ ΧΡΗΣΤΗ**

Για ασφάλεια και σωστή χρήση, παρακαλείστε διαβάσετε προσεκτικά αυτό το εγχειρίδιο χρήσεως πριν θέσετε σε λειτουργία τη μονάδα κλιματισμού.

### РУКОВОДСТВО ПО ЭКСПЛУАТАЦИИ

**ДЛЯ ПОЛЬЗОВАТЕЛЯ**

Для обеспечения правильного и безопасного использования следует ознакомиться с инструкциями, указанными в данном руководстве по эксплуатации, тщательным образом до того, как приступить к использованию кондиционера.

### İŞLETME ELKİTABI

**KULLANICI İÇİN**

Emniyetli ve doğru biçimde nasıl kullanılacağını öğrenmek için lütfen klima cihazını işletmeden önce bu elkitabını dikkatle okuyunuz.

**English****Deutsch****Français****Español****Italiano****Nederlands****Svenska****Dansk****Português****Ελληνικά****Русский****Türkçe**

# Contents

1. Safety Precautions .....	2	7. Other Functions .....	9
2. Parts Names .....	2	8. Function Selection .....	10
3. Screen Configuration .....	4	9. Care and Cleaning .....	14
4. Setting the Day of the Week and Time .....	4	10. Trouble Shooting .....	15
5. Operation .....	5	11. Installation, relocation and inspection .....	16
6. Timer .....	6	12. Specifications .....	17

Note (Marking for WEEE)



**This symbol mark is for EU countries only.**

**This symbol mark is according to the directive 2002/96/EC Article 10 Information for users and Annex IV.**

Your MITSUBISHI ELECTRIC product is designed and manufactured with high quality materials and components which can be recycled and reused.

This symbol means that electrical and electronic equipment, at their end-of-life, should be disposed of separately from your household waste.

Please, dispose of this equipment at your local community waste collection/recycling centre.

In the European Union there are separate collection systems for used electrical and electronic product.

Please, help us to conserve the environment we live in!

**Note:** The phrase "Wired remote controller" in this operation manual refers only to the PAR-21MAA. If you need any information for the PAR-30MAA, please refer to the instruction book included in PAR-30MAA box.

## 1. Safety Precautions

- ▶ Before installing the unit, make sure you read all the "Safety Precautions".
- ▶ The "Safety Precautions" provide very important points regarding safety. Make sure you follow them.
- ▶ Please report to or take consent by the supply authority before connection to the system.

### Symbols used in the text

**⚠ Warning:**

Describes precautions that should be observed to prevent danger of injury or death to the user.

**⚠ Caution:**

Describes precautions that should be observed to prevent damage to the unit.

### Symbols used in the illustrations

**⊥** : Indicates a part which must be grounded.

**⚠ Warning:**

- The unit must not be installed by the user. Ask the dealer or an authorized company to install the unit. If the unit is installed improperly, water leakage, electric shock or fire may result.
- Do not stand on, or place any items on the unit.
- Do not splash water over the unit and do not touch the unit with wet hands. An electric shock may result.
- Do not spray combustible gas close to the unit. Fire may result.
- Do not place a gas heater or any other open-flame appliance where it will be exposed to the air discharged from the unit. Incomplete combustion may result.
- Do not remove the front panel or the fan guard from the outdoor unit when it is running.

- When you notice exceptionally abnormal noise or vibration, stop operation, turn off the power switch, and contact your dealer.
- Never insert fingers, sticks etc. into the intakes or outlets.
- If you detect odd smells, stop using the unit, turn off the power switch and consult your dealer. Otherwise, a breakdown, electric shock or fire may result.
- This air conditioner is NOT intended for use by children or infirm persons without supervision.
- Young children must be supervised to ensure that they do not play with the air conditioner.
- If the refrigeration gas blows out or leaks, stop the operation of the air conditioner, thoroughly ventilate the room, and contact your dealer.

**⚠ Caution:**

- Do not use any sharp object to push the buttons, as this may damage the remote controller.
- Never block or cover the indoor or outdoor unit's intakes or outlets.

### Disposing of the unit

When you need to dispose of the unit, consult your dealer.

## 2. Parts Names

### ■ Indoor Unit

	SEZ-KD-VAQ
Fan steps	3 steps
Vane	—
Louver	—
Filter	Normal
Filter cleaning indication	—

### ■ SEZ-KD-VAQ

Ceiling Concealed

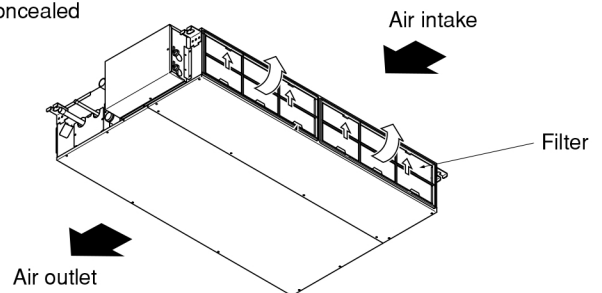

## 2. Parts Names

### ■ Wired Remote-Controller (option)

#### Display Section

For purposes of this explanation, all parts of the display are shown as lit. During actual operation, only the relevant items will be lit.

#### Identifies the current operation

Shows the operating mode, etc.  
\* Multilanguage display is supported.

#### “Centrally Controlled” indicator

Indicates that operation of the remote controller has been prohibited by a master controller.

#### “Timer is Off” indicator

Indicates that the timer is off.

#### Temperature Setting

Shows the target temperature.

#### Day-of-Week

Shows the current day of the week.

#### Time/Timer Display

Shows the current time, unless the simple or Auto Off timer is set.  
If the simple or Auto Off timer is set, shows the time remaining.

#### “Sensor” indication

Displayed when the remote controller sensor is used.

#### “Locked” indicator

Indicates that remote controller buttons have been locked.

#### “Clean The Filter” indicator

Comes on when it is time to clean the filter.

#### Timer indicators

The indicator comes on if the corresponding timer is set.

#### Fan Speed indicator

Shows the selected fan speed.

#### Ventilation indicator

Appears when the unit is running in Ventilation mode.

#### Up/Down Air Direction indicator

The indicator shows the direction of the outgoing airflow.

#### “One Hour Only” indicator

Displayed if the airflow is set to weak and downward during COOL or DRY mode. (Operation varies according to model.)  
The indicator goes off after one hour, at which time the airflow direction also changes.

#### Room Temperature display

Shows the room temperature. The room temperature display range is 8–39°C. The display flashes if the temperature is less than 8 °C or 39 °C or more.

#### Louver display

Indicates the action of the swing louver. Does not appear if the louver is stationary.

#### ● (Power On indicator)

Indicates that the power is on.

#### Operation Section

##### Set Temperature buttons

- ▽ Down
- △ Up

##### Timer Menu button (Monitor/Set button)

##### Mode button (Return button)

##### Set Time buttons

- ▽ Back
- △ Ahead

##### Timer On/Off button (Set Day button)

##### ON/OFF button

##### Fan Speed button

##### Filter button (<Enter> button)

##### Test Run button

##### Check button (Clear button)

##### Airflow Up/Down button

##### Louver button (▽ Operation button)

##### ▽ To preceding operation number.

##### Ventilation button (△ Operation button)

##### △ To next operation number.

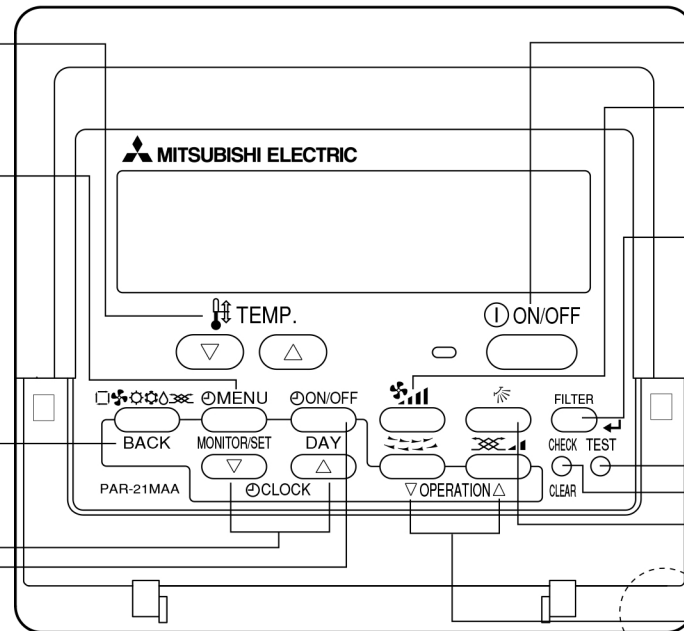
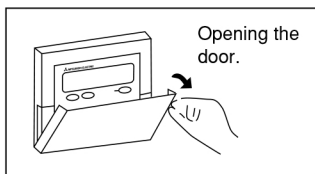

#### Note:

- “PLEASE WAIT” message  
This message is displayed for approximately 3 minutes when power is supplied to the indoor unit or when the unit is recovering from a power failure.
- “NOT AVAILABLE” message  
This message is displayed if a button is pressed to operate a function that the indoor unit does not have.  
If a single remote controller is used to simultaneously operate multiple indoor units that are different models, this message will not be displayed if any of the indoor units is equipped with the function.

## 2. Parts Names

### Outdoor unit

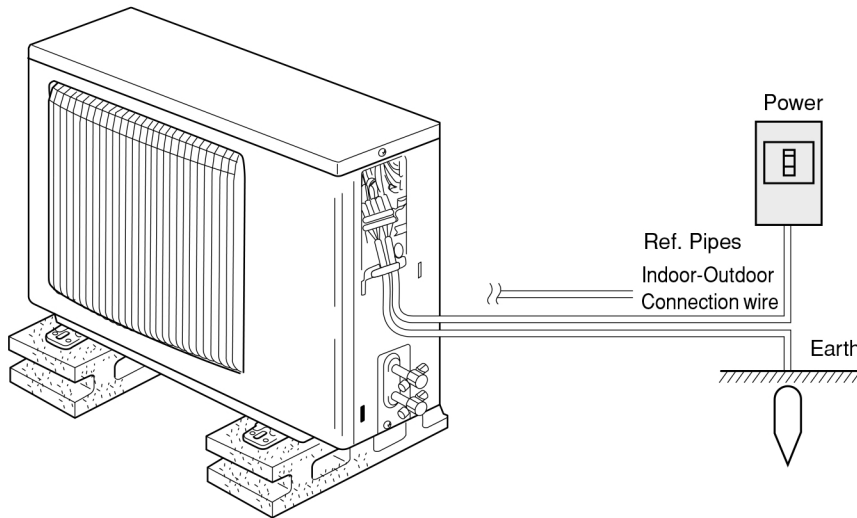

## 3. Screen Configuration

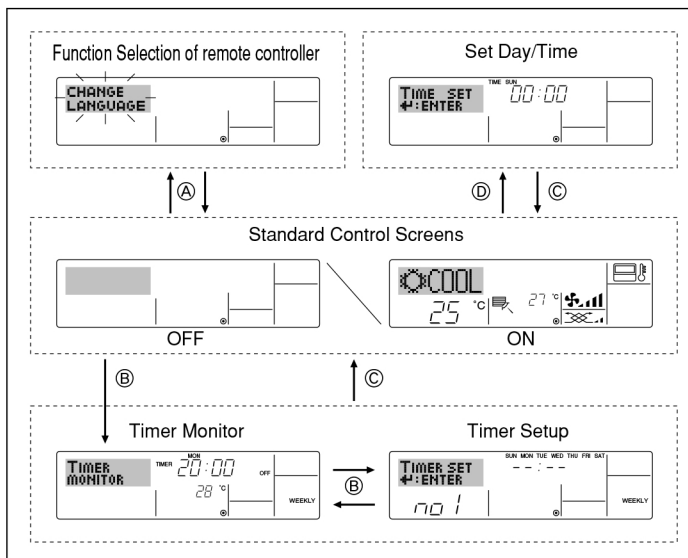

### <Screen Types>

For details on setting the language for the remote controller display, refer to section 8. Function Selection.

The initial language setting is English.

#### ● Function Selection of remote controller:

Set the functions and ranges available to the remote controller (timer functions, operating restrictions, etc.)

#### ● Set Day/Time:

Set the current day of the week or time.

#### ● Standard Control Screens:

View and set the air conditioning system's operating status

#### ● Timer Monitor:

View the currently set timer (weekly timer, simple timer, or Auto Off timer)

#### ● Timer Setup:

Set the operation of any of the timers (weekly timer, simple timer, or Auto Off timer).

### <How to change the screen>

Ⓐ: Hold down both the Mode button and the Timer On/Off button for 2 seconds.

Ⓑ: Press the Timer Menu button.

Ⓒ: Press the Mode (Return) button.

Ⓓ: Press either of the Set Time buttons (▽ or △).

## 4. Setting the Day of the Week and Time

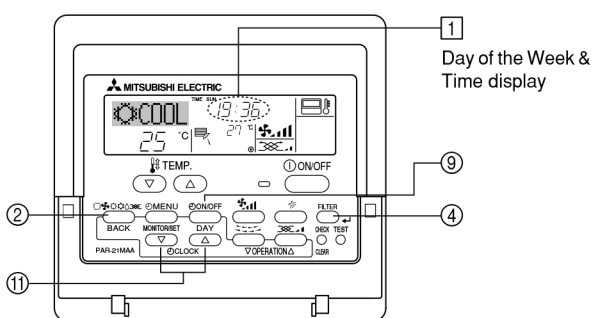

### Note:

- The day and time will not appear if clock use has been disabled at Function Selection of remote controller.
- After the power supply returns, the indoor unit does not operate for three minutes. Above operation is normal.

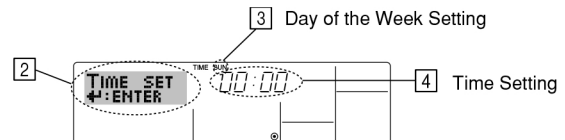

1. Press the ▽ or △ Set Time button ⑪ to show display ②.

2. Press the Timer On/Off (Set Day) button ⑨ to set the day.

\* Each press advances the day shown at ③: Sun → Mon → ... → Fri → Sat.

3. Press the appropriate Set Time button ⑪ as necessary to set the time.

\* As you hold the button down, the time (at ④) will increment first in minute intervals, then in ten-minute intervals, and then in one-hour intervals.

4. After making the appropriate settings at Steps 2 and 3, press the Filter button ④ to lock in the values.

### Note:

- Your new entries at Steps 2 and 3 will be cancelled if you press the Mode (Return) button ② before pressing the Filter button ④.

5. Press the Mode (Return) button ② to complete the setting procedure. This will return the display to the standard control screen, where ① will now show the newly set day and time.

## 5. Operation

### 5.1. Description of "AUTO RESTART FUNCTION"

- This unit is equipped with the auto restart function. When the main power is turned on, the air conditioner will start operation automatically in the same mode as set with the remote controller before the shutoff of main power.
- If the unit was set to off with the remote controller before the shutoff of main power, it will remain stopped even after the main power is turned on.
- If the unit was in the TEST RUN before the shutoff of main power, it will start operation, at main power on, in the same mode as set with the remote controller before the TEST RUN.

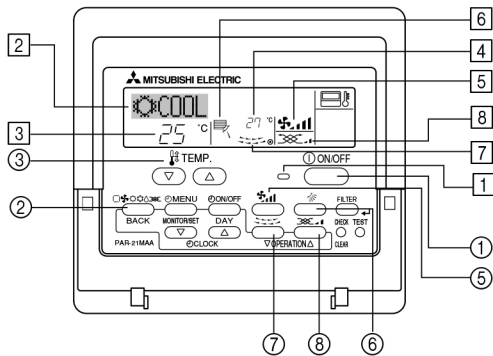

### 5.2. Turning ON/OFF

#### <To Start Operation>

- Press the ON/OFF button ①.
  - The ON lamp ① and the display area come on.

#### Note:

- When the unit is restarted, initial settings are as follows.

		Remote Controller settings	
Mode		Last operation mode	
Temperature setting		Last set temperature	
Fan speed		Last set fan speed	
Airflow up/down	Mode	COOL or DRY	Horiz. outlet
		HEAT	Last setting
		FAN	Horiz. outlet

#### <To Stop Operation>

- Press the ON/OFF button ① again.
  - The ON lamp ① and the display area go dark.

#### Note:

Even if you press the ON/OFF button immediately after shutting down the operation is progress, the air conditioner will not start for about three minutes. This is to prevent the internal components from being damaged.

### 5.3. Mode select

- If the unit is off, press the ON/OFF button to turn it on.
  - The ON indicator should light up.
- Press the operation mode ( ) button ② and select the operation mode ②.

- Cooling mode
- Drying mode
- Fan mode
- Heating mode
- Automatic (cooling/heating) mode
- Ventillation mode

Only indicated on the following condition  
Wired remote controller used  
LOSSNAY connected

### Information for multi system air conditioner (Outdoor unit: MXZ series)

► Multi system air conditioner (Outdoor unit: MXZ series) can connect two or more indoor units with one outdoor unit. According to the capacity, two or more units can operate simultaneously.

- When you try to operate two or more indoor units with one outdoor unit simultaneously, one for the cooling and the other for heating, the operation mode of the indoor unit that operates earlier is selected. The other indoor units that will start the operation later cannot operate, indicating

an operation state in flashing.

In this case, please set all the indoor units to the same operation mode.

- There might be a case that the indoor unit, which is operating in (AUTO) mode. Cannot change over to the operating mode (COOL ↔ HEAT) and becomes a state of standby.
- When indoor unit starts the operation while the defrosting of outdoor unit is being done, it takes a few minutes (max. about 15 minutes) to blow out the warm air.
- In the heating operation, though indoor unit that does not operate may get warm or the sound of refrigerant flowing may be heard, they are not malfunction. The reason is that the refrigerant continuously flows into it.

### Automatic operation

- According to a set temperature, cooling operation starts if the room temperature is too hot and heating operation starts if the room temperature is too cold.
- During automatic operation, if the room temperature changes and remains 2 °C or more above the set temperature for 15 minutes, the air conditioner switches to cooling mode. In the same way, if the room temperature remains 2 °C or more below the set temperature for 15 minutes, the air conditioner switches to heating mode.

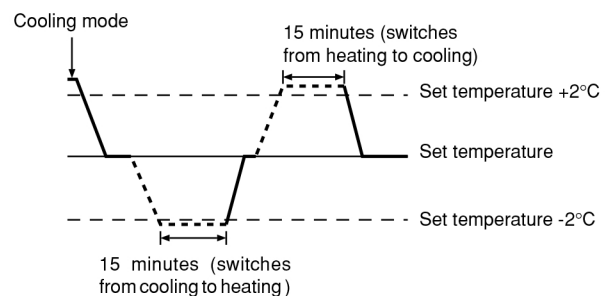

- Because the room temperature is automatically adjusted in order to maintain a fixed effective temperature, cooling operation is performed a few degrees warmer and heating operation is performed a few degrees cooler than the set room temperature once the temperature is reached (automatic energy-saving operation).

### 5.4. Temperature setting

#### ► To decrease the room temperature:

- Press button ③ to set the desired temperature.
  - The selected temperature is displayed ③.

- Each time you press the button, the temperature value decreases by 1 °C.

#### ► To increase the room temperature:

- Press button ③ to set the desired temperature.
  - The selected temperature is displayed ③.

- Each time you press the button, the temperature value decreases by 1 °C.

- Available temperature ranges are as follows:

Cooling/Drying:	19 - 30 °C
Heating:	17 - 28 °C
Automatic:	19 - 28 °C

- The display flashes either 8 °C - 39 °C to inform you if the room temperature is lower or higher than the displayed temperature.

### 5.5. Fan speed setting

- Press button ⑤ to select a desired fan speed.

- Each time you press the button, available options change with the display ⑤ on the remote controller, as shown below.

Fan speed	Remote controller display			
	Low	Medium	High	Auto
3-stage	( ) ↓ ↘	( ) →	( ) →	( )

## 5. Operation

The display and the fan speed of the unit will differ in the following situations:

- When STAND BY and DEFROST are displayed.
- Just after the heating mode (while waiting to change to another mode).
- When the temperature of the room is higher than the temperature setting of the unit operating in the heating mode.
- In the dry operation, the indoor fan automatically turns to low-speed operation. Switching of fan speed is impossible.
- When the temperature of the heat exchanger is low in the heating mode (e.g., immediately after heating operation starts).

### Note:

- In the following cases, the actual fan speed generated by the unit will differ from the speed shown the remote controller display.
  1. While the display is showing "STAND BY" or "DEFROST".
  2. When the temperature of the heat exchanger is low in the heating mode. (e.g. immediately after heating operation starts)
  3. In HEAT mode, when room temperature is higher than the temperature setting.
  4. When the unit is in DRY mode.

## 5.6. Ventillation

### ► For LOSSNAY combination

#### 5.6.1. For Wired Remote-controller

- To run the ventilator together with the indoor unit:
  - Press the ON/OFF button ①.
    - The Vent indication appears on the screen (at ⑧). The ventilator will now automatically operate whenever the indoor unit is running.
- To run the ventilator independently:
  - Press the Mode button ② until  appears on the display. This will cause the ventilator to start.
- To change the ventilator force:
  - Press the Ventilation button ⑧ as necessary.
    - Each press toggles the setting, as shown below.

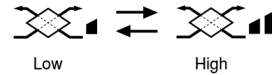

## 6. Timer

### 6.1. For Wired Remote-controller

This section explains how to set and use the timer. You can use Function Selection of remote controller to select which of three types of timer to use: ① Weekly timer, ② Simple timer, or ③ Auto Off timer.

For information about how to set the Function Selection of remote controller, refer to section 8. [4]-3 (3).

#### 6.1.1. Weekly Timer

- The weekly timer can be used to set up to eight operations for each day of the week.
  - Each operation may consist of any of the following: ON/OFF time together with a temperature setting, or ON/OFF time only, or temperature setting only.
  - When the current time reaches a time set at this timer, the air conditioner carries out the action set by the timer.
- Time setting resolution for this timer is 1 minute.

### Note:

- \*1. Weekly Timer/Simple Timer/Auto Off Timer cannot be used at the same time.
- \*2. The weekly timer will not operate when any of the following conditions is in effect.

The timer feature is off; the system is in a malfunction state; a test run is in progress; the remote controller is undergoing self-check or remote controller check; the user is in the process of setting a function; the user is in the process of setting the timer; the user is in the process of setting the current day of the week or time; the system is under central control. (Specifically, the system will not carry out operations (unit on, unit off, or temperature setting) that are prohibited during these conditions.)

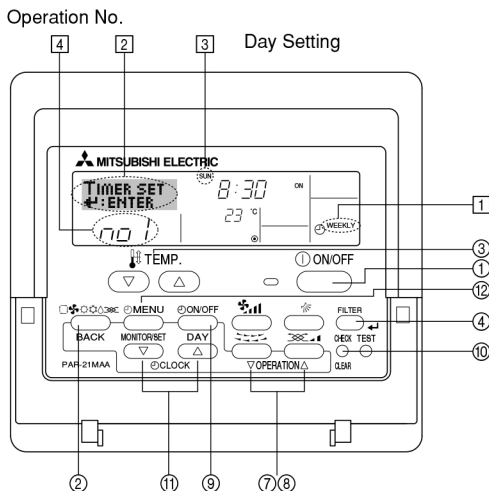

### <How to Set the Weekly Timer>

1. Be sure that you are at a standard control screen, and that the weekly timer indicator ① is shown in the display.
  2. Press the Timer Menu button ②, so that the "Set Up" appears on the screen (at ②). (Note that each press of the button toggles the display between "Set Up" and "Monitor".)
  3. Press the Timer On/Off (Set Day) button ③ to set the day. Each press advances the display at ③ to the next setting, in the following sequence: "Sun Mon Tues Wed Thurs Fri Sat" → "Sun" → ... → "Fri" → "Sat" → "Sun Mon Tues Wed Thurs Fri Sat"...
  4. Press the  $\nabla$  or  $\triangle$  Operation button (⑦ or ⑧) as necessary to select the appropriate operation number (1 to 8) ④.
    - \* Your inputs at Steps 3 and 4 will select one of the cells from the matrix illustrated below.
- (The remote-controller display at left shows how the display would appear when setting Operation 1 for Sunday to the values indicated below.)

### Setup Matrix

Op No.	Sunday	Monday	...	Saturday
No. 1	• 8:30 • ON • 23 °C			
No. 2	• 10:00 • OFF	• 10:00 • OFF	• 10:00 • OFF	• 10:00 • OFF
...				
No. 8				

<Operation 1 settings for Sunday>  
Start the air conditioner at 8:30, with the temperature set to 23 °C.

<Operation 2 settings for every day>  
Turn off the air conditioner at 10:00.

### Note:

By setting the day to "Sun Mon Tues Wed Thurs Fri Sat", you can set the same operation to be carried out at the same time every day. (Example: Operation 2 above, which is the same for all days of the week.)

### <Setting the Weekly Timer>

- Shows the time setting ⑤
- Shows the selected operation (ON or OFF) ⑥  
\* Does not appear if operation is not set.
- Shows the temperature setting ⑦  
\* Does not appear if temperature is not set.

## 6. Timer

5. Press the appropriate Set Time button ⑪ as necessary to set the desired time (at ⑤).
  - \* As you hold the button down, the time first increments in minute intervals, then in ten-minute intervals, and then in one-hour intervals.
6. Press the ON/OFF button ① to select the desired operation (ON or OFF), at ⑥.
  - \* Each press changes the next setting, in the following sequence: No display (no setting) → “ON” → “OFF”
7. Press the appropriate Set Temperature button ③ to set the desired temperature (at ⑦).
  - \* Each press changes the setting, in the following sequence: No display (no setting) ↔ 24 ↔ 25 ↔ ... ↔ 29 ↔ 30 ↔ 12 ↔ ... ↔ 23 ↔ No display.  
(Available range: The range for the setting is 12 °C to 30 °C. The actual range over which the temperature can be controlled, however, will vary according to the type of the connected unit.)
8. After making the appropriate settings at Steps 5, 6 and 7, press the Filter ↵ button ④ to lock in the values.
 

To clear the currently set values for the selected operation, press and quickly release the Check (Clear) button ⑩ once.

  - \* The displayed time setting will change to “—:—”, and the On/Off and temperature settings will all disappear.  
(To clear all weekly timer settings at once, hold down the Check (Clear) button ⑩ for two seconds or more. The display will begin flashing, indicating that all settings have been cleared.)

### Note:

Your new entries will be cancelled if you press the Mode (Return) button ② before pressing the Filter ↵ button ④.

If you have set two or more different operations for exactly the same time, only the operation with the highest Operation No. will be carried out.

9. Repeat Steps 3 to 8 as necessary to fill as many of the available cells as you wish.
10. Press the mode (Return) button ② to return to the standard control screen and complete the setting procedure.
11. To activate the timer, press the Timer On/Off button ⑨, so that the “Timer Off” indication disappears from the screen. **Be sure that the “Timer Off” indication is no longer displayed.**
  - \* If there are no timer settings, the “Timer Off” indication will flash on the screen.

### <How to View the Weekly Timer Settings>

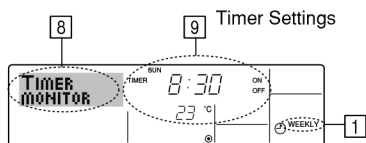

1. Be sure that the weekly timer indicator is visible on the screen (at ①).
2. Press the Timer Menu button ② so that “Monitor” is indicated on the screen (at ⑧).
3. Press the Timer On/Off (Set Day) button ⑨ as necessary to select the day you wish to view.
4. Press the ∇ or ∆ Operation button (⑦ or ⑧) as necessary to change the timer operation shown on the display (at ⑨).
  - \* Each press will advance to the next timer operation, in order of time setting.
5. To close the monitor and return to the standard control screen, press the Mode (Return) button ②.

### <To Turn Off the Weekly Timer>

Press the Timer On/Off button ⑨ so that “Timer Off” appears at ⑩.

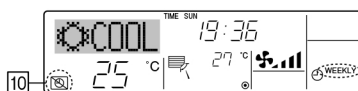

### <To Turn On the Weekly Timer>

Press the Timer On/Off button ⑨ so that the “Timer Off” indication (at ⑩) goes dark.

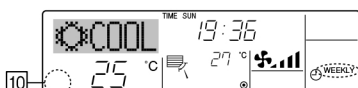

### 6.1.2. Simple Timer

■ You can set the simple timer in any of three ways.

- Start time only:  
The air conditioner starts when the set time has elapsed.
- Stop time only:  
The air conditioner stops when the set time has elapsed.
- Start & stop times:  
The air conditioner starts and stops at the respective elapsed times.

■ The simple timer (start and stop) can be set only once within a 72-hour period.

The time setting is made in hour increments.

### Note:

- \*1. Weekly Timer/Simple Timer/Auto Off Timer cannot be used at the same time.
- \*2. The simple timer will not operate when any of the following conditions is in effect.

The timer is off; the system is in malfunction state; a test run is in progress; the remote controller is undergoing self-check or remote controller check; the user is in the process of selecting a function; the user is in the process of setting the timer; the system is under central control. (Under these conditions, On/Off operation is prohibited.)

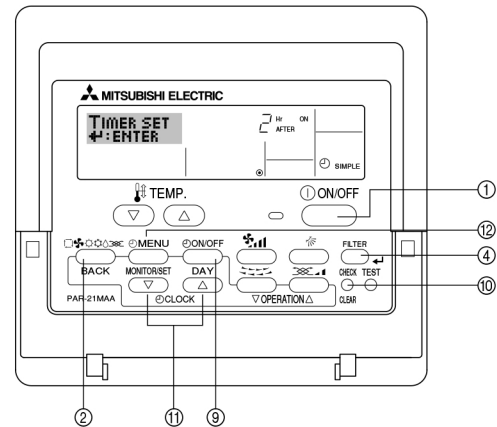

### <How to Set the Simple Timer>

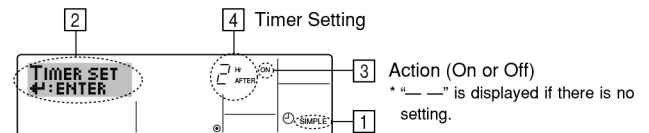

1. Be sure that you are at a standard control screen, and that the simple timer indicator is visible in the display (at ①).  
When something other than the Simple Timer is displayed, set it to SIMPLE TIMER using the function selection of remote controller (see 8.[4]-3 (3)) timer function setting.
2. Press the Timer Menu button ⑫, so that the “Set Up” appears on the screen (at ②). (Note that each press of the button toggles the display between “Set Up” and “Monitor”.)
3. Press the ON/OFF button ① to display the current ON or OFF simple timer setting. Press the button once to display the time remaining to ON, and then again to display the time remaining to OFF. (The ON/OFF indication appears at ③).
  - “ON” timer:  
The air conditioner will start operation when the specified number of hours has elapsed.
  - “OFF” timer:  
The air conditioner will stop operation when the specified number of hours has elapsed.
4. With “ON” or “OFF” showing at ③: Press the appropriate Set Time button ⑪ as necessary to set the hours to ON (if “ON” is displayed) or the hours to OFF (if “OFF” is displayed) at ④.
  - Available Range: 1 to 72 hours
5. To set both the ON and OFF times, repeat Steps 3 and 4.
  - \* Note that ON and OFF times cannot be set to the same value.
6. To clear the current ON or OFF setting: Display the ON or OFF setting (see step 3) and then press the Check (Clear) button ⑩ so that the time setting clears to “—” at ④. (If you want to use only an ON setting or only an OFF setting, be sure that the setting you do not wish to use is shown as “—”.)

## 6. Timer

7. After completing steps 3 to 6 above, press the Filter  $\leftarrow$  button (4) to lock in the value.

### Note:

Your new settings will be cancelled if you press the Mode (Return) button (2) before pressing the Filter  $\leftarrow$  button (4).

8. Press the Mode (Return) button (2) to return to the standard control screen.

9. Press the Timer On/Off button (9) to start the timer countdown. When the timer is running, the timer value is visible on the display. **Be sure that the timer value is visible and appropriate.**

### <Viewing the Current Simple Timer Settings>

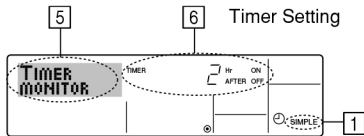

1. Be sure that the simple timer indicator is visible on the screen (at 1).
2. Press the Timer Menu button (12), so that the "Monitor" appears on the screen (at 5).
  - If the ON or OFF simple timer is running, the current timer value will appear at 6.
  - If ON and OFF values have both been set, the two values appear alternately.
3. Press the Mode (Return) button (2) to close the monitor display and return to the standard control screen.

### <To Turn Off the Simple Timer...>

Press the Timer On/Off button (9) so that the timer setting no longer appears on the screen (at 7).

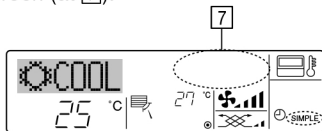

### <To Turn On the Simple Timer...>

Press the Timer On/Off button (9) so that the timer setting becomes visible at 7.

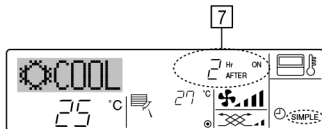

### Examples

If ON and OFF times have both been set at the simple timer, operation and display are as indicated below.

#### Example 1:

Start the timer, with ON time set sooner than OFF time  
 ON Setting: 3 hours  
 OFF Setting: 7 hours

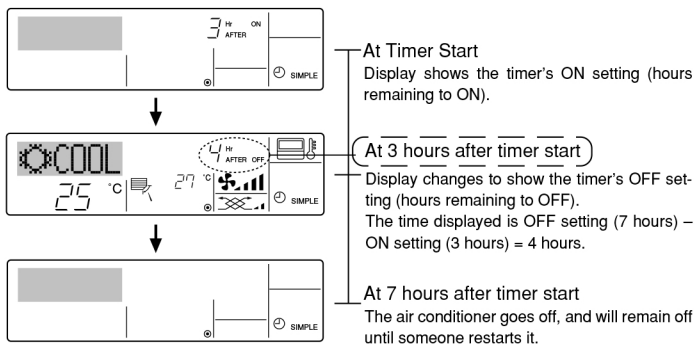

#### Example 2:

Start the timer, with OFF time is sooner than ON time  
 ON Setting: 5 hours  
 OFF Setting: 2 hours

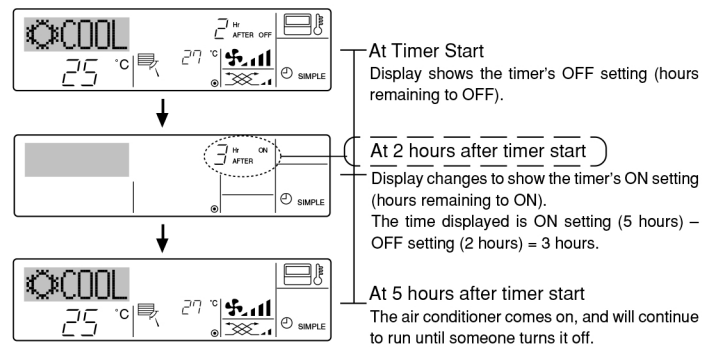

### 6.1.3. Auto Off Timer

■ This timer begins countdown when the air conditioner starts, and shuts the air conditioner off when the set time has elapsed.

■ Available settings run from 30 minutes to 4 hours, in 30-minute intervals.

#### Note:

- \*1. Weekly Timer/Simple Timer/Auto Off Timer cannot be used at the same time.
- \*2. The Auto Off timer will not operate when any of the following conditions is in effect.

The timer is off; the system is in malfunction state; a test run is in progress; the remote controller is undergoing self-check or remote controller check; the user is in the process of selecting a function; the user is in the process of setting the timer; the system is under central control. (Under these conditions, On/Off operation is prohibited.)

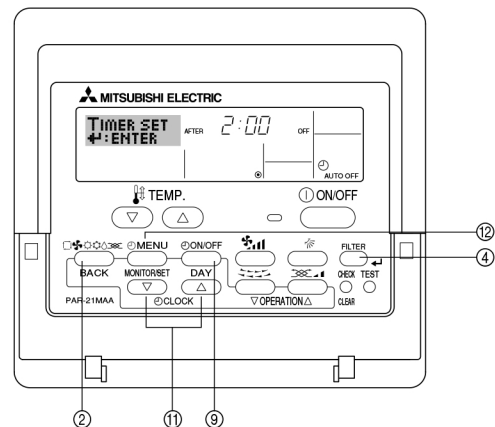

### <How to Set the Auto Off Timer>

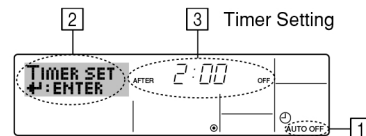

1. Be sure that you are at a standard control screen, and that the Auto Off timer indicator is visible in the display (at 1). When something other than the Auto Off Timer is displayed, set it to AUTO OFF TIMER using the function selection of remote controller (see 8.[4]-3 (3)) timer function setting.
2. Hold down the Timer Menu button (12) for **3 seconds**, so that the "Set Up" appears on the screen (at 2). (Note that each press of the button toggles the display between "Set Up" and "Monitor".)
3. Press the appropriate Set Time button (11) as necessary to set the OFF time (at 3).
4. Press the Filter  $\leftarrow$  button (4) to lock in the setting.

#### Note:

Your entry will be cancelled if you press the Mode (Return) button (2) before pressing the Filter  $\leftarrow$  button (4).

5. Press the Mode (Return) button (2) to complete the setting procedure and return to the standard control screen.
6. If the air conditioner is already running, the timer starts countdown immediately. **Be sure to check that the timer setting appears correctly on the display.**



## 6. Timer

### <Checking the Current Auto Off Timer Setting>

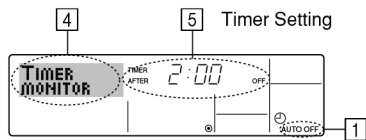

1. Be sure that the "Auto Off" is visible on the screen (at ①).
2. Hold down the Timer Menu button ⑫ for **3 seconds**, so that "Monitor" is indicated on the screen (at ④).
  - The timer remaining to shutdown appears at ⑤.
3. To close the monitor and return to the standard control screen, press the Mode (Return) button ②.

### <To Turn Off the Auto Off Timer...>

- Hold down the Timer On/Off button ⑨ for **3 seconds**, so that "Timer Off" appears (at ⑥) and the timer value (at ⑦) disappears.

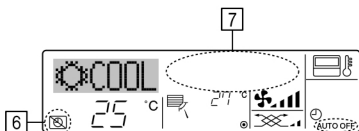

- Alternatively, turn off the air conditioner itself. The timer value (at ⑦) will disappear from the screen.

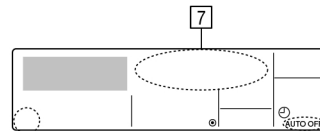

### <To Turn On the Auto Off Timer...>

- Hold down the Timer On/Off button ⑨ for **3 seconds**. The "Timer Off" indication disappears (at ⑥), and the timer setting comes on the display (at ⑦).
- Alternatively, turn on the air conditioner. The timer value will appear at ⑦.

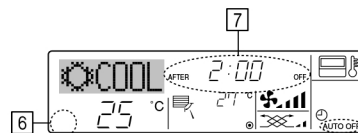

## 7. Other Functions

### 7.1. Locking the Remote Controller Buttons (Operation function limit controller)

- If you wish, you can lock the remote controller buttons. You can use the Function Selection of remote controller to select which type of lock to use. (For information about selecting the lock type, see section 8, item [4]-2 (1)).

Specifically, you can use either of the following two lock types.

- ① Lock All Buttons:  
Locks all of the buttons on the remote controller.
- ② Lock All Except ON/OFF:  
Locks all buttons other than the ON/OFF button.

#### Note:

The "Locked" indicator appears on the screen to indicate that buttons are currently locked.

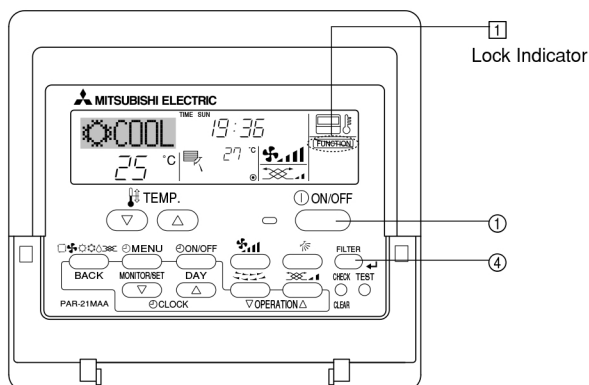

### <How to Lock the Buttons>

1. While holding down the Filter button ④, press and hold down the ON/OFF button ① for 2 seconds. The "Locked" indication appears on the screen (at ①), indicating that the lock is now engaged.
  - \* If locking has been disabled in Function Selection of remote controller, the screen will display the "Not Available" message when you press the buttons as described above.



- If you press a locked button, the "Locked" indication (at ①) will blink on the display.



### <How to Unlock the Buttons>

1. While holding down the Filter button ④, press and hold down the ON/OFF button ① for 2 seconds—so that the "Locked" indication disappears from the screen (at ①).

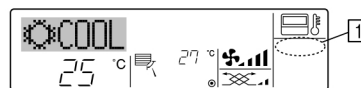

## 7.2. Other indications

### 7.2.1. Centrally Controlled

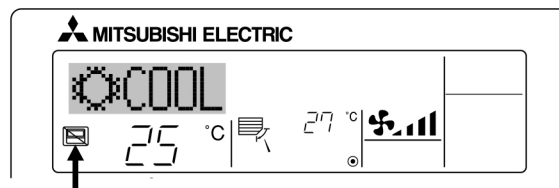

- Displayed when operation is controlled by central controller, etc. Restricted operations are shown below.
  - ON/OFF (including timer operation)
  - Operation mode
  - Set temperature

#### Note:

May also be individually restricted.

### 7.2.2. Flashing Mode Indicator

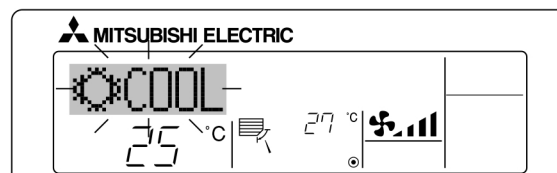

- When flashes continuously  
Displayed when another indoor unit connected to the outdoor unit is already operating in a different operation mode. Match with the operation mode of the other indoor unit.
- When mode switched after display flashes  
Displayed when operation mode is restricted for each season by central controller, etc. Use another operation mode.

## 7. Other Functions

### 7.2.3. Error Codes indication

If you have entered contact number to be called in the event of a problem, the screen displays this number. (You can set this up under Function Selection of remote controller. For information, refer to section 8.)

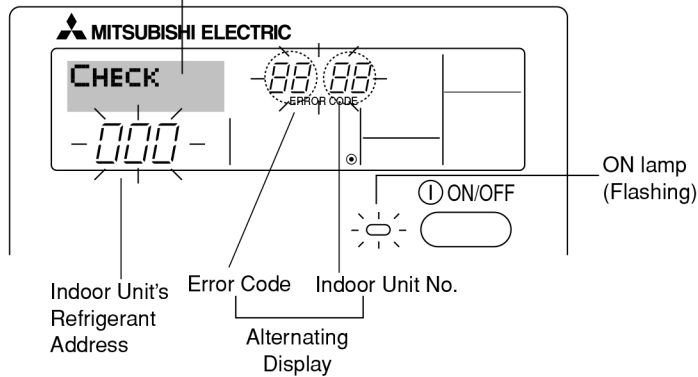

When the Check button is pressed:

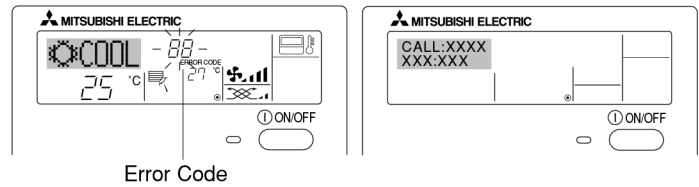

- If the ON lamp and error code are both flashing: This means that the air conditioner is out of order and operation has been stopped (and cannot resume). Take note of the indicated unit number and error code, then switch off the power to the air conditioner and call your dealer or servicer.
- If only the error code is flashing (while the ON lamp remains lit): Operation is continuing, but there may be a problem with the system. In this case, you should note down the error code and then call your dealer or servicer for advice.
  - \* If you have entered contact number to be called in the event of a problem, push the Check button to display it on the screen. (You can set this up under Function Selection of remote controller. For information, refer to section 8.)

## 8. Function Selection

### Function selection of remote controller

The setting of the following remote controller functions can be changed using the remote controller function selection mode. Change the setting when needed.

Item 1	Item 2	Item 3 (Setting content)
1. Change Language ("CHANGE LANGUAGE")	Language setting to display	<ul style="list-style-type: none"> <li>• Display in multiple languages is possible</li> </ul>
2. Function limit ("FUNCTION SELECTION")	(1) Operation function limit setting (operation lock) ("LOCKING FUNCTION")	<ul style="list-style-type: none"> <li>• Setting the range of operation limit (operation lock)</li> </ul>
	(2) Use of automatic mode setting ("SELECT AUTO MODE")	<ul style="list-style-type: none"> <li>• Setting the use or non-use of "automatic" operation mode</li> </ul>
	(3) Temperature range limit setting ("LIMIT TEMP FUNCTION")	<ul style="list-style-type: none"> <li>• Setting the temperature adjustable range (maximum, minimum)</li> </ul>
	(4) Use of automatic filter elevation panel up/down operation mode setting	(For this model, this function is not available.)
	(5) Use of fixed airflow direction mode setting	(For this model, this function is not available.)
3. Mode selection ("MODE SELECTION")	(1) Remote controller main/sub setting ("CONTROLLER MAIN/SUB")	<ul style="list-style-type: none"> <li>• Selecting main or sub remote controller</li> <li>* When two remote controllers are connected to one group, one controller must be set to sub.</li> </ul>
	(2) Use of clock setting ("CLOCK")	<ul style="list-style-type: none"> <li>• Setting the use or non-use of clock function</li> </ul>
	(3) Timer function setting ("WEEKLY TIMER")	<ul style="list-style-type: none"> <li>• Setting the timer type</li> </ul>
	(4) Contact number setting for error situation ("CALL.")	<ul style="list-style-type: none"> <li>• Contact number display in case of error</li> <li>• Setting the telephone number</li> </ul>
4. Display change ("DISP MODE SETTING")	(1) Temperature display °C/°F setting ("TEMP MODE °C/°F")	<ul style="list-style-type: none"> <li>• Setting the temperature unit (°C or °F) to display</li> </ul>
	(2) Suction air temperature display setting ("ROOM TEMP DISP SELECT")	<ul style="list-style-type: none"> <li>• Setting the use or non-use of the display of indoor (suction) air temperature</li> </ul>
	(3) Automatic cooling/heating display setting ("AUTO MODE DISP C/H")	<ul style="list-style-type: none"> <li>• Setting the use or non-use of the display of "Cooling" or "Heating" display during operation with automatic mode</li> </ul>

# 8. Function Selection

**[Function selection flowchart]**  
Setting language (English)

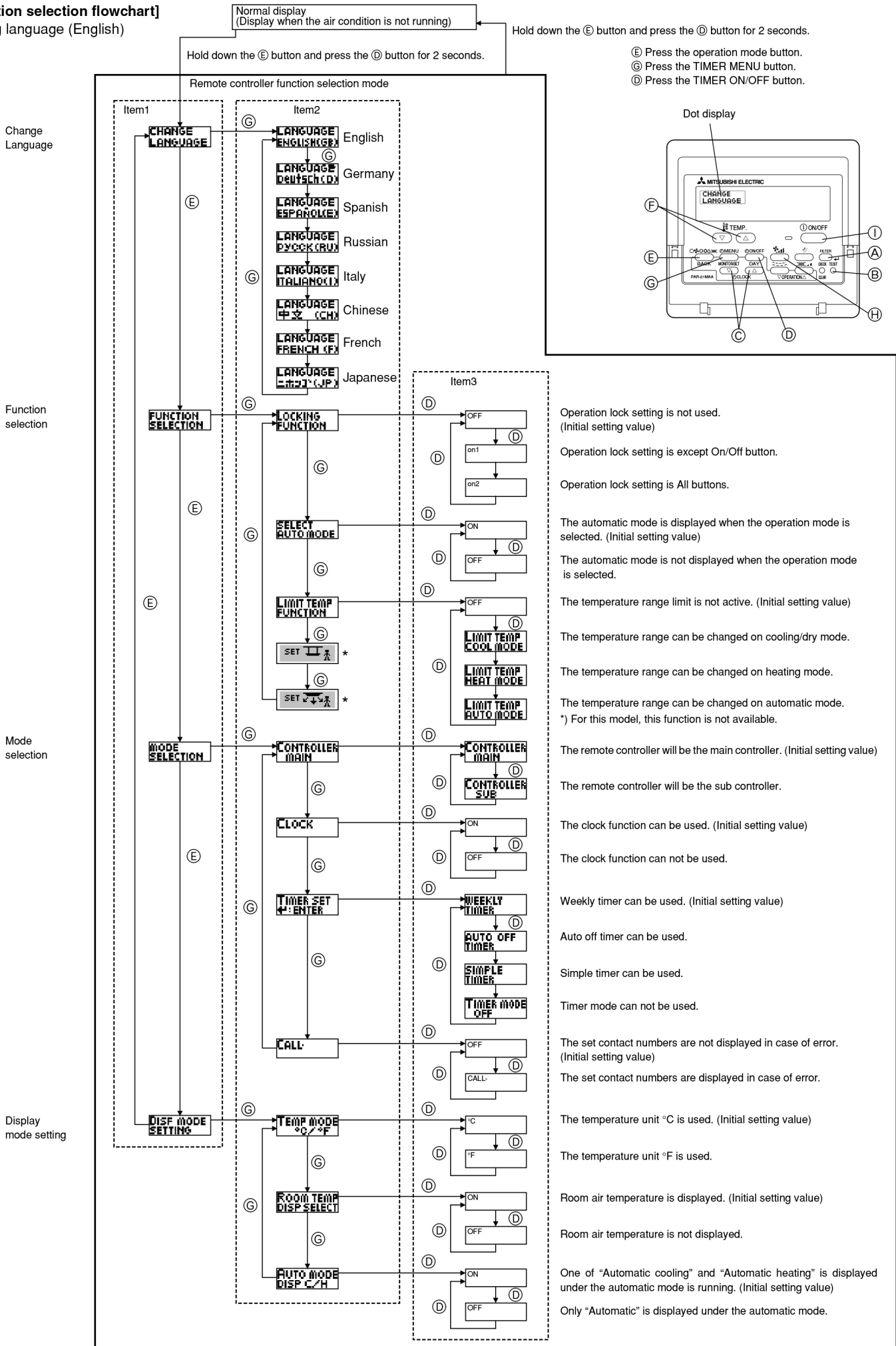

## 8. Function Selection

### [Detailed setting]

#### [4]-1. CHANGE LANGUAGE setting

The language that appears on the dot display can be selected.

- Press the [⊖MENU] button ⑥ to change the language.
  - ① English (GB), ② German (D), ③ Spanish (E), ④ Russian (RU),
  - ⑤ Italian (I), ⑥ Chinese (CH), ⑦ French (F), ⑧ Japanese (JP)

Refer to the dot display table.

#### [4]-2. Function limit

##### (1) Operation function limit setting (operation lock)

- To switch the setting, press the [⊖ON/OFF] button ⑩.
  - ① no1: Operation lock setting is made on all buttons other than the [⊖ON/OFF] button.
  - ② no2: Operation lock setting is made on all buttons.
  - ③ OFF (Initial setting value): Operation lock setting is not made.- \* To make the operation lock setting valid on the normal screen, it is necessary to press buttons (Press and hold down the [FILTER] and [⊖ON/OFF] buttons at the same time for two seconds.) on the normal screen after the above setting is made.

##### (2) Use of automatic mode setting

When the remote controller is connected to the unit that has automatic operation mode, the following settings can be made.

- To switch the setting, press the [⊖ON/OFF] button ⑩.
  - ① ON (Initial setting value):  
The automatic mode is displayed when the operation mode is selected.
  - ② OFF:  
The automatic mode is not displayed when the operation mode is selected.

##### (3) Temperature range limit setting

After this setting is made, the temperature can be changed within the set range.

- To switch the setting, press the [⊖ON/OFF] button ⑩.
  - ① LIMIT TEMP COOL MODE:  
The temperature range can be changed on cooling/dry mode.
  - ② LIMIT TEMP HEAT MODE:  
The temperature range can be changed on heating mode.
  - ③ LIMIT TEMP AUTO MODE:  
The temperature range can be changed on automatic mode.
  - ④ OFF (initial setting): The temperature range limit is not active.- \* When the setting, other than OFF, is made, the temperature range limit setting on cooling, heating and automatic mode is made at the same time. However, the range cannot be limited when the set temperature range has not changed.
- To increase or decrease the temperature, press the [TEMP. (▽) or (△)] button ⑨.
- To switch the upper limit setting and the lower limit setting, press the [TEMP. (▽) or (△)] button ⑨. The selected setting will flash and the temperature can be set.
- Settable range

Cooling/Dry mode:	Lower limit:19°C ~ 30°C	Upper limit:30°C ~ 19°C
Heating mode:	Lower limit:17°C ~ 28°C	Upper limit:28°C ~ 17°C
Automatic mode:	Lower limit:19°C ~ 28°C	Upper limit:28°C ~ 19°C
- \* The settable range varies depending on the unit to connect (Mr. Slim units, CITY MULTI units, and intermediate temperature units)

##### (4) Use of automatic filter elevation panel up/down operation mode setting

For this model, this function is not available.

##### (5) Use of fixed airflow direction mode setting

For this model, this function is not available.

#### [4]-3. Mode selection setting

##### (1) Remote controller main/sub setting

- To switch the setting, press the [⊖ON/OFF] button ⑩.
  - ① Main: The controller will be the main controller.
  - ② Sub: The controller will be the sub controller.

##### (2) Use of clock setting

- To switch the setting, press the [⊖ON/OFF] button ⑩.
  - ① ON: The clock function can be used.
  - ② OFF: The clock function cannot be used.

##### (3) Timer function setting

- To switch the setting, press the [⊖ON/OFF] button ⑩ (Choose one of the followings.).
  - ① WEEKLY TIMER (initial setting value):  
The weekly timer can be used.
  - ② AUTO OFF TIMER:  
The auto off timer can be used.
  - ③ SIMPLE TIMER:  
The simple timer can be used.
  - ④ TIMER MODE OFF:  
The timer mode cannot be used.- \* When the use of clock setting is OFF, the "WEEKLY TIMER" cannot be used.

##### (4) Contact number setting for error situation

- To switch the setting, press the [⊖ON/OFF] button ⑩.
  - ① CALL OFF:  
The set contact numbers are not displayed in case of error.
  - ② CALL \*\*\*\* \*  
The set contact numbers are displayed in case of error.  
CALL\_:  
The contact number can be set when the display is as shown on the left.- Setting the contact numbers  
To set the contact numbers, follow the following procedures. Move the flashing cursor to set numbers. Press the [TEMP. (▽) and (△)] button ⑨ to move the cursor to the right (left). Press the [⊖CLOCK (▽) and (△)] button ⑩ to set the numbers.

#### [4]-4. Display change setting

##### (1) Temperature display °C/°F setting

- To switch the setting, press the [⊖ON/OFF] button ⑩.
  - ① °C: The temperature unit °C is used.
  - ② °F: The temperature unit °F is used.

##### (2) Suction air temperature display setting

- To switch the setting, press the [⊖ON/OFF] button ⑩.
  - ① ON: The suction air temperature is displayed.
  - ② OFF: The suction air temperature is not displayed.

##### (3) Automatic cooling/heating display setting

- To switch the setting, press the [⊖ON/OFF] button ⑩.
  - ① ON:  
One of "Automatic cooling" and "Automatic heating" is displayed under the automatic mode is running.
  - ② OFF:  
Only "Automatic" is displayed under the automatic mode.

## 8. Function Selection

[Dot display table]

Selecting language	English	Germany	Spanish	Russian	Italy	Chinese	French	Japanese	
Waiting for start-up	PLEASE WAIT	←	←	←	←	←	←	←	
Operation mode	Cool	COOL	Kühlen	FRÍO	Холод	COOL	制冷	FROID	冷房
	Dry	DRY	Trocknen	DESHUMIDIFICACION	Сушка	DRY	除湿	DESHU	ドライ
	Heat	HEAT	Heizen	CALOR	Тепло	HEAT	制热	CHAUD	暖房
	Auto	AUTO	AUTO	AUTOMÁTICO	Авто	AUTO	自动	AUTO	自動
	Auto(Cool)	COOL	Kühlen	FRÍO	Холод	COOL	制冷	FROID	冷房
	Auto(Heat)	HEAT	Heizen	CALOR	Тепло	HEAT	制热	CHAUD	暖房
	Fan	FAN	Lüfter	VENTILACION	Вент	VENTILAZIONE	送风	VENTILATION	送風
	Ventilation	VENTILATION	Gebläsebetrieb	VENTILACION	Вентиляция	ARIA ESTERNA	换气	VENTILATION	換気
	Stand by (Hot adjust) Defrost	STAND BY DEFROST	STAND BY Abtauen	CALENTANDO DESCONGELACION	ОБОГРЕВ: ПАУЗА ОТТАВЛИВАНИЕ	STAND BY SBRINAMENTO	准备中 除霜中	PRE CHAUFFAGE DEGIVRAGE	準備中 霜取中
Set temperature	SET TEMP	TEMP einstellen	TEMP. CONSIGNA	ЦЕЛЕВАЯ ТЕМПЕРАТУРА	IMPOSTAZIONE TEMPERATURA	设定温度	REGLAGE TEMPERATURE	設定温度	
Fan speed	FAN SPEED	Lüftergeschwindigkeit	VELOCIDAD VENTILADOR	СКОРОСТЬ ВЕНТИЛЯТОРА	VELOCITA' VENTILATORE	风速	VITESSE DE VENTILATION	風速	
Not use button	NOT AVAILABLE	nicht verfügbar	NO DISPONIBLE	НЕ ДОСТУПНО	NON DISPONIBILE	无效按钮	NON DISPONIBLE	無効ボタン	
Check (Error)	CHECK	Prüfen	COMPROBAR	ПРОВЕРКА	CHECK	检查	CONTROLE	点検	
Test run	TEST RUN	Testbetrieb	TEST FUNCIONAMIENTO	ТЕСТОВЫЙ ЗАПУСК	TEST RUN	试运行	TEST	試運転	
Self check	SELF CHECK	Selbst-diagnose	AUTO REVISION	САМОДИАГНОСТИКА	SELF CHECK	自我诊断	AUTO CONTROLE	自己診断	
Unit function selection	FUNCTION SELECTION	Funktion Auswahl	SELECCIÓN DE FUNCION	ВЫБОР ФУНКЦИИ	SELEZIONE FUNZIONI	功能选择	SELECTION FONCTIONS	メニュー選択	
Setting of ventilation	SETTING OF VENTILATION	Lüfterstufen wählen	CONFIG. VENTILACION	НАСТРОЙКА ВЕНТУСТАИ.	IMPOSTAZIONE ARIA ESTERNA	换气设定	SELECTION VENTILATION	換気設定	

Selecting language	English	Germany	Spanish	Russian	Italy	Chinese	French	Japanese
CHANGE LANGUAGE	CHANGE LANGUAGE	←	←	←	←	←	←	←
Function selection	FUNCTION SELECTION	Funktion auswählen	SELECCIÓN DE FUNCIONES	ВЫБОР ФУНКЦИИ	SELEZIONE FUNZIONI	功能限制	SELECTION FONCTIONS	メニュー制限
Operation function limit setting	LOCKING FUNCTION	Sperr-Funktion	FUNCION BLOQUEADA	ФУНКЦИЯ БЛОКИРОВКИ	BLOCCO FUNZIONI	操作限制	BLOCAGE FONCTIONS	操作ロック
Use of automatic mode setting	SELECT AUTOMODE	Auswahl auto Betrieb	SELECCIÓN MODO AUTO	ВЫБОР РЕЖИМА АВТО	SELEZIONE MODO AUTO	自动模式	SELECTION DU MODO AUTO	自動モード
Temperature range limit setting	LIMIT TEMP FUNCTION	Limit Temp Funktion	LIMIT TEMP CONSIGNA	ОГРАНИЧЕНИЕ УСТ.ТЕМПЕРАТ	LIMITAZIONE TEMPERATURA	温度限制	LIMITATION TEMPERATURE	温度制限
Use of automatic filter elevation panel up/down operation mode setting	SET	←	←	←	←	←	←	←
Use of fixed airflow direction mode setting	SET	←	←	←	←	←	←	←
Limit temperature cooling/day mode	LIMIT TEMP COOL MODE	Limit Kühl Temp	LIMIT TEMP MODO FRIO	ОГРАНИЧЕНО ОХЛАЖДЕНИЕ	LIMITAZIONE MODO COOL	制冷范围	LIMITE TEMP MODO FROID	制冷范围
Limit temperature heating mode	LIMIT TEMP HEAT MODE	Limit Heiz Temp	LIMIT TEMP MODO CALOR	ОГРАНИЧЕН ОБОГРЕВ	LIMITAZIONE MODO HEAT	制热范围	LIMITE TEMP MODO CHAUD	制热范围
Limit temperature auto mode	LIMIT TEMP AUTO MODE	Limit Auto Temp	LIMIT TEMP MODO AUTO	ОГРАНИЧЕН РЕЖИМ АВТО	LIMITAZIONE MODO AUTO	自动范围	LIMITE TEMP MODO AUTO	自動范围
Mode selection	MODE SELECTION	Betriebsart wählen	SELECCIÓN DE MODO	ВЫБОР РЕЖИМА	SELEZIONE MODO	基本模式	SELECTION DU MODO	基本メニュー
Remote controller setting MAIN	CONTROLLER MAIN	Haupt Controller	CONTROL PRINCIPAL	Основной пульт	CONTROLLO MAIN	遥控主	TECOMMANDE MAITRE	リモコン 主
Remote controller setting SUB	CONTROLLER SUB	Neben Controller	CONTROL SECUNDARIO	Дополнительный пульт	CONTROLLO SUB	遥控辅	TECOMMANDE ESCLAVE	リモコン 副
Use of clock setting	CLOCK	Uhr	RELOJ	Часы	OROLOGIO	时钟	AFFICHAGE HORLOGE	時計
Setting the day of the week and time	TIME SET ←:ENTER	Uhr stellen ←:einstellen	CONFIG RELOJ ←:CONFIG	Часы: УСТ. ←: ВВОД	OROLOGIO ←: ENTER	时间 ←:ENTER	HORLOGE ←: ENTRER	トケイセッテイ ←: カクテイ
Timer set	TIMER SET ←:ENTER	Zeitschaltuhr ←:einstellen	TEMPORIZA - DOR←:CONFIG	Таймер: УСТ. ←: ВВОД	TIMER ←: ENTER	定时器 ←:ENTER	PROG HORAIRES ←: ENTRER	タイマーセッテイ ←: カクテイ
Timer monitor	TIMER MONITOR	Uhrzeit Anzeige	VISUALIZAR TEMPORIZAD.	ПРОСМОТР ТАЙМЕРА	VISUALIZ TIMER	定时器状态	AFFICHAGE PROG HORAIRES	タイマーモニター
Weekly timer	WEEKLY TIMER	Wochenzeit schalt Uhr	TEMPORIZA - DOR SEMANAL	НЕДЕЛЬНЫЙ ТАЙМЕР	TIMER SETTIMANALE	每周定时器	PROG HEBDO MADAIRES	タイマー 週間
Timer mode off	TIMER MODE OFF	Zeitschaltuhr AUS	TEMPORIZA - DOR APAGADO	ТАЙМЕР ВЫКЛ.	TIMER OFF	定时器无效	PROG HORAIRES INACTIF	タイマー 無効
Auto off timer	AUTO OFF TIMER	AUTO Zeit funktion AUS	APAGADO AUTOMÁTICO	АВТОМАТИЧ. ПО ТАЙМЕРУ	AUTO OFF TIMER	解除定时	PROG HORAIRES ARRET AUTO	タイマー-キャンセル ボタン
Simple timer	SIMPLE TIMER	Einfache Zeitfunktion	TEMPORIZA - DOR SIMPLE	ПРОСТЫЙ ТАЙМЕР	TIMER SEMPLIFICATO	简易定时器	PROG HORAIRES SIMPLIFIE	タイマー-カンイ
Contact number setting of error situation	CALL	←	←	←	←	←	←	←
Display change	DISP MODE SETTING	Anzeige Betriebsart	MOSTRAR MODO	НАСТРОЙКА ИЛИ РЕЖИМА	IMPOSTAZIONE MODO DISPLAY	转换表示	AFFICHAGE SOUS MENU	表示切替
Temperature display °C/°F setting	TEMP MODE °C/°F	Wechsel °C/°F	TEMPERADOS °C/°F	ЕДИН.ТЕМП. °C/°F	TEMPERATURA °C/°F	温度 °C/°F	TEMPERATURE °C/°F	温度 °C/°F

## 8. Function Selection

Selecting language	English	Germany	Spanish	Russian	Italy	Chinese	French	Japanese
Room air temperature display setting	ROOM TEMP DISP SELECT	ROOM TEMP zeWA.hit	MOSTRAR TEMP.	ПОКАЗЫВАТЬ ТЕМП. В КОМН.	TEMPERATURA AMBIENTE	吸入温度	TEMPERATURE AMBIANTE	スリコエオド 温度
Automatic cooling/heating display setting	AUTO MODE DISP C/H	Auto Betrieb C/H	MOSTRAR F/C EN AUTO	МНД. Т/Х В РЕЖИМЕ АВТО	AUTO C/H	自动力表示	AFFICHAGE AUTO F/C	自動力表示

## 9. Care and Cleaning

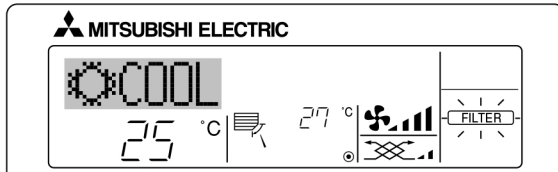

- Indicates that the filter needs cleaning. Clean the filter.

- When resetting "FILTER" display  
When the [FILTER] button is pressed two times successively after cleaning the filter, the display goes off and is reset.

### Note:

- When two or more different types of indoor unit are controlled, the cleaning period differs with the type of filter. When the master unit cleaning period arrives, "FILTER" is displayed. When the filter display goes off, the cumulative time is reset.
- "FILTER" indicates the cleaning period when the air conditioner was used under general indoor air conditions by criteria time. Since the degree of dirtiness depends on the environmental conditions, clean the filter accordingly.
- The filter cleaning period cumulative time differs with the model.
- This indication is not available for wireless remote controller.

### ▶ Cleaning the filters

- Clean the filters using a vacuum cleaner. If you do not have a vacuum cleaner, tap the filters against a solid object to knock off dirt and dust.
- If the filters are especially dirty, wash them in lukewarm water. Take care to rinse off any detergent thoroughly and allow the filters to dry completely before putting them back into the unit.

### ⚠ Caution:

- Do not dry the filters in direct sunlight or by using a heat source, such as an electric heater: this may warp them.
- Do not wash the filters in hot water (above 50°C), as this may warp them.
- Make sure that the air filters are always installed. Operating the unit without air filters can cause malfunction.

### ⚠ Caution:

- Before you start cleaning, stop operation and turn OFF the power supply.
- Indoor units are equipped with filters to remove the dust of sucked-in air. Clean the filters using the methods shown in the following sketches.

### ▶ Filter removal

#### ⚠ Caution:

- In removing the filter, precautions must be taken to protect your eyes from dust. Also, if you have to climb up on a stool to do the job, be careful not to fall.
- When the filter is removed, do not touch the metallic parts inside the indoor unit, otherwise injury may result.



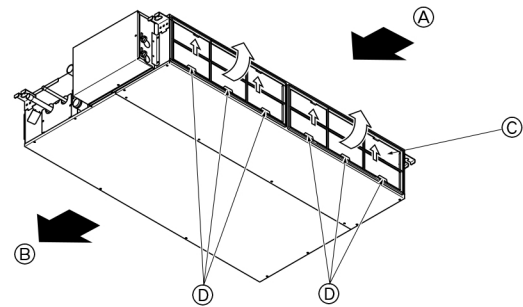

### ■ SEZ-KD-VAQ



- While lifting the filter knob, pull it.

Ⓐ Air intake Ⓑ Air outlet Ⓒ Filter Ⓓ Knob

## 10. Trouble Shooting

Having trouble?	Here is the solution. (Unit is operating normally.)
Air conditioner does not heat or cool well.	<ul style="list-style-type: none"> <li>■ Clean the filter. (Airflow is reduced when the filter is dirty or clogged.)</li> <li>■ Check the temperature adjustment and adjust the set temperature.</li> <li>■ Make sure that there is plenty of space around the outdoor unit. Is the indoor unit air intake or outlet blocked?</li> <li>■ Has a door or window been left open?</li> </ul>
When heating operation starts, warm air does not blow from the indoor unit soon.	<ul style="list-style-type: none"> <li>■ Warm air does not blow until the indoor unit has sufficiently warmed up.</li> </ul>
During heating mode, the air conditioner stops before the set room temperature is reached.	<ul style="list-style-type: none"> <li>■ When the outdoor temperature is low and the humidity is high, frost may form on the outdoor unit. If this occurs, the outdoor unit performs a defrosting operation. Normal operation should begin after approximately 10 minutes.</li> </ul>
When the airflow direction is changed, the vanes always move up and down past the set position before finally stopping at the position.	<ul style="list-style-type: none"> <li>■ When the airflow direction is changed, the vanes move to the set position after detecting the base position.</li> </ul>
A flowing water sound or occasional hissing sound is heard.	<ul style="list-style-type: none"> <li>■ These sounds can be heard when refrigerant is flowing in the air conditioner or when the refrigerant flow is changing.</li> </ul>
A cracking or creaking sound is heard.	<ul style="list-style-type: none"> <li>■ These sounds can be heard when parts rub against each due to expansion and contraction from temperature changes.</li> </ul>
The room has an unpleasant odor.	<ul style="list-style-type: none"> <li>■ The indoor unit draws in air that contains gases produced from the walls, carpeting, and furniture as well as odors trapped in clothing, and then blows this air back into the room.</li> </ul>
A white mist or vapor is emitted from the indoor unit.	<ul style="list-style-type: none"> <li>■ If the indoor temperature and the humidity are high, this condition may occur when operation starts.</li> <li>■ During defrosting mode, cool airflow may blow down and appear like a mist.</li> </ul>
Water or vapor is emitted from the outdoor unit.	<ul style="list-style-type: none"> <li>■ During cooling mode, water may form and drip from the cool pipes and joints.</li> <li>■ During heating mode, water may form and drip from the heat exchanger.</li> <li>■ During defrosting mode, water on the heat exchanger evaporates and water vapor may be emitted.</li> </ul>
The operation indicator does not appear in the remote controller display.	<ul style="list-style-type: none"> <li>■ Turn on the power switch. "●" will appear in the remote controller display.</li> </ul>
"  " appears in the remote controller display.	<ul style="list-style-type: none"> <li>■ During central control, "" appears in the remote controller display and air conditioner operation cannot be started or stopped using the remote controller.</li> </ul>
When restarting the air conditioner soon after stopping it, it does not operate even though the ON/OFF button is pressed.	<ul style="list-style-type: none"> <li>■ Wait approximately three minutes. (Operation has stopped to protect the air conditioner.)</li> </ul>
Air conditioner operates without the ON/OFF button being pressed.	<ul style="list-style-type: none"> <li>■ Is the on timer set? Press the ON/OFF button to stop operation.</li> <li>■ Is the air conditioner connected to a central remote controller? Consult the concerned people who control the air conditioner.</li> <li>■ Does "" appear in the remote controller display? Consult the concerned people who control the air conditioner.</li> <li>■ Has the auto recovery feature from power failures been set? Press the ON/OFF button to stop operation.</li> </ul>
Air conditioner stops without the ON/OFF button being pressed.	<ul style="list-style-type: none"> <li>■ Is the off timer set? Press the ON/OFF button to restart operation.</li> <li>■ Is the air conditioner connected to a central remote controller? Consult the concerned people who control the air conditioner.</li> <li>■ Does "" appear in the remote controller display? Consult the concerned people who control the air conditioner.</li> </ul>
Remote controller timer operation cannot be set.	<ul style="list-style-type: none"> <li>■ Are timer settings invalid? If the timer can be set, (WEEKLY), (SIMPLE), or (AUTO OFF) appears in the remote controller display.</li> </ul>
"PLEASE WAIT" appears in the remote controller display.	<ul style="list-style-type: none"> <li>■ The initial settings are being performed. Wait approximately 3 minutes.</li> </ul>
An error code appears in the remote controller display.	<ul style="list-style-type: none"> <li>■ The protection devices have operated to protect the air conditioner.</li> <li>■ Do not attempt to repair this equipment by yourself. Turn off the power switch immediately and consult your dealer. Be sure to provide the dealer with the model name and information that appeared in the remote controller display.</li> </ul>
Draining water or motor rotation sound is heard.	<ul style="list-style-type: none"> <li>■ When cooling operation stops, the drain pump operates and then stops. Wait approximately 3 minutes.</li> </ul>

## 10. Trouble Shooting

Having trouble?	Here is the solution. (Unit is operating normally.)												
Noise is louder than specifications.	<p>■ The indoor operation sound level is affected by the acoustics of the particular room as shown in the following table and will be higher than the noise specification, which was measured in an echo-free room.</p> <table border="1"> <thead> <tr> <th></th> <th>High sound-absorbing rooms</th> <th>Normal rooms</th> <th>Low sound-absorbing rooms</th> </tr> </thead> <tbody> <tr> <td>Location examples</td> <td>Broadcasting studio, music room, etc.</td> <td>Reception room, hotel lobby, etc.</td> <td>Office, hotel room</td> </tr> <tr> <td>Noise levels</td> <td>3 to 7 dB</td> <td>6 to 10 dB</td> <td>9 to 13 dB</td> </tr> </tbody> </table>		High sound-absorbing rooms	Normal rooms	Low sound-absorbing rooms	Location examples	Broadcasting studio, music room, etc.	Reception room, hotel lobby, etc.	Office, hotel room	Noise levels	3 to 7 dB	6 to 10 dB	9 to 13 dB
	High sound-absorbing rooms	Normal rooms	Low sound-absorbing rooms										
Location examples	Broadcasting studio, music room, etc.	Reception room, hotel lobby, etc.	Office, hotel room										
Noise levels	3 to 7 dB	6 to 10 dB	9 to 13 dB										
Nothing appears in the wireless remote controller display, the display is faint, or signals are not received by the indoor unit unless the remote controller is close.	<p>■ The batteries are low. Replace the batteries and press the Reset button.</p> <p>■ If nothing appears even after the batteries are replaced, make sure that the batteries are installed in the correct directions (+, -).</p>												
The operation lamp near the receiver for the wireless remote controller on the indoor unit is flashing.	<p>■ The self diagnosis function has operated to protect the air conditioner.</p> <p>■ Do not attempt to repair this equipment by yourself. Turn off the power switch immediately and consult your dealer. Be sure to provide the dealer with the model name.</p>												

## 11. Installation, relocation and inspection

### Installation place

Avoid installing the air conditioner in the following places.

- Where flammable gas could leak.

#### ⚠ Caution:

**Do not install the unit where flammable gas could leak. If gas leaks and collects around the unit, it may cause an explosion.**

- Where there is much machine oil.
- Salty place such as the seaside.
- Where sulfide gas is generated such as a hot spring.
- Where there is oil splashing or much oily smoke.

#### ⚠ Warning:

**If the air conditioner operates but does not cool or heat (depending on model) the room, consult your dealer since there may be a refrigerant leak. Be sure to ask the service representative whether there is refrigerant leakage or not when repairs are carried out.**

**The refrigerant charged in the air conditioner is safe. Refrigerant normally does not leak, however, if refrigerant gas leaks indoors, and comes into contact with the fire of a fan heater, space heater, stove, etc., harmful substances will be generated.**

### Electrical work

- Provide an exclusive circuit for power supply of the air conditioner.
- Be sure to observe the breaker capacity.

#### ⚠ Warning:

- **The customer should not install this unit. If the unit is installed incorrectly, fire, electric shock, injury due to a falling unit, water leakage, etc. may result.**
- **Do not connect using branched outlet or an extension cord, and do not attach many loads to one electric outlet. A fire or electric shock may result from poor contact, poor insulation, exceeding the permissible current, etc. Consult your dealer.**

#### ⚠ Caution:

- **Apply grounding**  
Do not connect a grounding wire to a gas pipe, water pipe, lightning rod or ground wire of a telephone.  
If a grounding is incorrect, it may cause an electric shock.
- **Install an earth leakage breaker depending on the place where the air conditioner is to be installed (humid place, etc.).**  
If the earth leakage breaker is not installed, it may cause an electric shock.

### Inspection and maintenance

- When the air conditioner is used for several seasons, the capacity may be lowered due to dirt inside the unit.
- Depending upon the conditions of use, an odor may be generated or dirt, dust, etc. may prevent proper drainage.
- It is recommended to apply inspection and maintenance (charged) by a specialist in addition to normal maintenance. Consult your dealer.

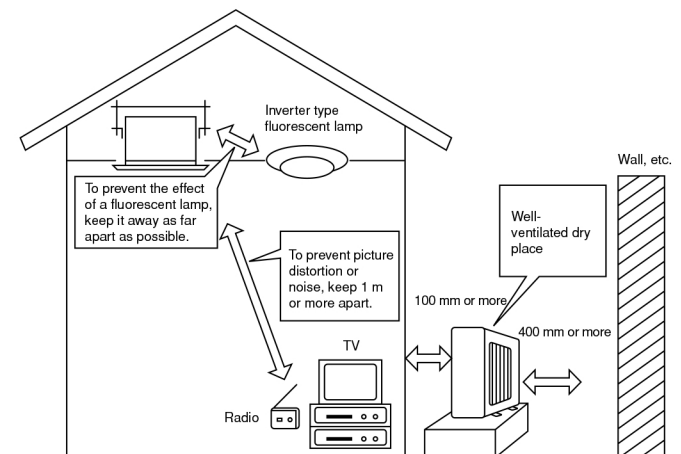



## 11. Installation, relocation and inspection

### Also consider operation sound

- Do not put an object around the air outlet of the outdoor unit. It may cause lowering of capacity or increase operating sound.
- If abnormal sound is heard during operation, consult your dealer.

### Relocation

- When the air conditioner is to be removed or reinstalled because of rebuilding, moving, etc., special techniques and work are required.

### ⚠ Warning:

Repair or relocation should not be done by the customer.

If this is done incorrectly, it may cause a fire, electric shock, injury by dropping of the unit, water leakage, etc. Consult your dealer.

### Disposal

- To dispose of this product, consult your dealer.

If you have any question, consult your dealer.

## 12. Specifications

Model		SEZ-KD25VAQ	SEZ-KD35VAQ	SEZ-KD50VAQ	SEZ-KD60VAQ	SEZ-KD71VAQ
Power supply		~/N, 230V, 50Hz/220-230V, 60Hz				
Input (Indoor only)	kW	0.04	0.05	0.07	0.07	0.10
Current (Indoor only)	A	0.39	0.46	0.63	0.63	0.84
Airflow (Lo-Mid-Hi)	CMM	5.5-7-9	7-9-11	10-12.5-15	12-15-18	12-16-20
Ext. static pressure	Pa	5/15/35/50	5/15/35/50	5/15/35/50	5/15/35/50	5/15/35/50
Noise level (Lo-Mid-Hi)	dB	23-26-30	23-28-33	30-34-37	30-34-38	30-35-40
Dimension (H×W×D)	mm	200×790×700	200×990×700	200×990×700	200×1190×700	200×1190×700
Weight	kg	18	21	23	27	27

- Notes: 1. Specifications subject to change without notice.  
2. The external static pressure is set to 15 Pa at factory shipment.

### Guaranteed operating range

		Indoor	Outdoor	
			SUZ-KA25, 35VA	SUZ-KA50, 60, 71VA   SUZ-KA-NA
Cooling	Upper limit	32°C DB, 23°C WB	46°C DB, –	43°C DB, –
	Lower limit	21°C DB, 15°C WB	-10°C DB, –   18°C DB, –	
Heating	Upper limit	27°C DB, –	24°C DB, 18°C WB	
	Lower limit	20°C DB, –	-10°C DB, -11°C WB	

Units should be installed by licensed electric contractor accordingly to local code requirement.