

# OPERATING INSTRUCTIONS

## INDOOR UNIT

MS-A18WV  
MS-A24WV  
MS-A30WV  
MSH-A18WV  
MSH-A24WV  
MSH-A30WV



## OPERATING INSTRUCTIONS

For customers

- To use this unit correctly and safely, be sure to read this operating instructions before use.

## Bedienungsanleitung

Für Kunden

- Um diese Einheit richtig und sicher zu verwenden, unbedingt diese Bedienungsanleitung vor der Inbetriebnahme durchlesen.

## NOTICE D'UTILISATION

A l'attention des clients

- Pour avoir la certitude d'utiliser cet appareil correctement et en toute sécurité, veuillez lire attentivement cette notice d'instructions avant de mettre l'appareil en fonction.

## GEBRUIKSAANWIJZING

Voor de klant

- Om dit apparaat op de juiste manier en veilig te gebruiken, dient u eerst deze gebruiksaanwijzing aandachtig door te lezen.

## MANUAL DE INSTRUCCIONES

Para los clientes

- Para emplear correctamente este aparato y por razones de seguridad debe leer este manual de instrucciones de manejo antes de su utilización.

## LIBRETTO D'ISTRUZIONI

Per gli utenti

- Per utilizzare correttamente quest'unità, leggere questo libretto d'istruzioni attentamente e per intero.

## ΟΔΗΓΙΕΣ ΛΕΙΤΟΥΡΓΙΑΣ

Για τον πελάτη

- Για να χρησιμοποιήσετε αυτή την μονάδα σωστά και με ασφάλεια, βεβαιωθείτε ότι έχετε διαβάσει αυτό το εγχειρίδιο οδηγιών πριν από την χρήση.

## INSTRUÇÕES DE OPERAÇÃO

Para os clientes

- Para utilizar esta unidade correctamente, certifique-se de que lê estas instruções de operação antes da utilização.

## BRUGSANVISNING

Til kunden

- Læs denne brugsanvisning før brugen så korrekt og forsvarlig anvendelse af klimaanlægget sikres.

## BRUKSANVISNING

För kunder

- För att använda enheten på rätt och säkert sätt ska denna bruksanvisning läsas innan enheten tas i bruk.

## İŞLETME TALİMATLARI

Satın alıcılar için

- Bu birimi doğru ve güvenli olarak çalıştırmak için, kullanmadan önce bu işletme talimatlarını mutlaka okuyun.

## РУКОВОДСТВО ПО ЭКСПЛУАТАЦИИ

Для пользователей

- Для обеспечения правильного и безопасного использования прибора следует до начала его эксплуатации внимательно прочитать данное руководство.

English

Deutsch

Français

Nederlands

Español

Italiano

Ελληνικά

Português

Dansk

Svenska

Türkçe

Русский

# CONTENTS

SAFETY PRECAUTIONS .....	2
NAME OF EACH PART .....	3
PREPARATION BEFORE OPERATION .....	4
I FEEL... AUTO OPERATION .....	6
MANUAL OPERATION (COOL, DRY, HEAT/FAN) .....	7
AIR FLOW VELOCITY AND DIRECTION ADJUSTMENT .....	7
LONG OPERATION .....	8
ECONO COOL OPERATION .....	8
TIMER OPERATION (ON/OFF TIMER) .....	8
WHEN THE AIR CONDITIONER IS NOT GOING TO BE USED FOR A LONG TIME .....	9
MAINTENANCE .....	9
CLEANING THE CATECHIN AIR FILTER .....	10
REPLACEMENT OF THE AIR CLEANING FILTER (OPTION) .....	10
BEFORE CONTACTING THE SERVICE REPRESENTATIVE, CHECK THE FOLLOWING AGAIN .....	11
WHEN YOU THINK THAT TROUBLE HAS OCCURRED .....	11
INSTALLATION, RELOCATION AND INSPECTION .....	12
SPECIFICATIONS .....	12

## SAFETY PRECAUTIONS

- Since rotating parts and parts which could cause an electric shock are used in this product, be sure to read these "Safety Precautions" before use.
- Since the cautionary items shown here are important for safety, be sure to observe them.

### Marks and their meanings

- ⚠ **WARNING:** Incorrect handling could cause a serious hazard, such as death, serious injury, etc. with a high probability.
- ⚠ **CAUTION:** Incorrect handling could cause a serious hazard depending on the conditions.

### Meanings of symbols used in this manual

- The colour of the sticker affixed to the unit is written in the parentheses.

- ⊘ : Be sure not to do.
- ⚡ : Be sure to follow the instruction.
- ⊘ (Black) : Never insert your finger or stick, etc.
- ⊘ (Black) : Never step onto the indoor/outdoor unit and do not put anything on them.
- ⚡ (Yellow) : Danger of electric shock. Be careful.
- ⚡ (Blue) : Be sure to disconnect the power supply plug from the power outlet.
- ⚡ (Blue) : Be sure to shut off the power.

- After reading this manual, keep it together with the installation manual in a handy place for easy reference.

### Warning mark positions and safety devices

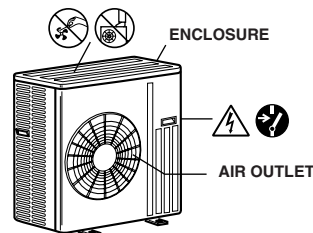
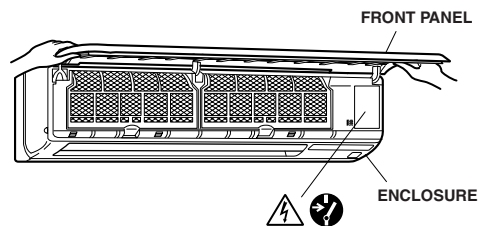

- This air conditioner is NOT intended for use by children or infirm persons without supervisions.

<b>⚠ WARNING</b>	
⊘	<p><b>Do not use intermediate connection of the power supply cord or the extension cord and do not connect many devices to one AC outlet.</b></p> <ul style="list-style-type: none"> <li>• A fire or an electric shock may result from poor contact, poor insulation, exceeding the permissible current, etc.</li> </ul>
	<p><b>Do not scratch or process the power supply cord, etc.</b></p> <ul style="list-style-type: none"> <li>• Do not put heavy object on the power supply cord and do not scratch or process the cord. The cord may be damaged and this may cause a fire or an electric shock.</li> </ul>
	<p><b>Do not turn the breaker off/on or disconnect/connect the power supply plug during operation.</b></p> <ul style="list-style-type: none"> <li>• This may cause a fire due to spark, etc.</li> <li>• Be sure to turn off the breaker or disconnect the power supply plug absolutely after switching the indoor unit off with the remote controller.</li> </ul>
	<p><b>Do not expose your skin directly to cool air for a long time.</b></p> <ul style="list-style-type: none"> <li>• This could damage your health.</li> </ul>
	<p><b>The customer should not install this unit.</b></p> <ul style="list-style-type: none"> <li>• If this is done incorrectly, it may cause a fire, an electric shock, or injury from the unit falling, water leaking, etc. Consult your dealer.</li> </ul>
⊘ ⊘	<p><b>Do not insert your finger or a stick, etc. into the air inlet/outlet.</b></p> <ul style="list-style-type: none"> <li>• Since the fan rotates at high speed, this may cause an injury.</li> <li>• Young children should be supervised to ensure that they do not play with the air conditioner.</li> </ul>
⚡ ⚡	<p><b>When an abnormality (burning smell, etc.) occurs, stop the air conditioner and disconnect the power supply plug or turn off the breaker.</b></p> <ul style="list-style-type: none"> <li>• If the unit continues to be operated in an abnormal condition, it may cause a fire, trouble, etc. In this case, consult your dealer.</li> </ul>
	<p><b>Repairs or relocation should not be done by the customer.</b></p> <ul style="list-style-type: none"> <li>• If this is done incorrectly, it may cause a fire, an electric shock, or injury from the unit falling, water leaking, etc. Consult your dealer.</li> <li>• If the power supply cord is damaged, it must be replaced by the manufacturer or its service agent in order to avoid a hazard.</li> </ul>

<b>⚠ CAUTION</b>	
⊘	<p><b>When the air filter is to be removed, do not touch the metal parts of the indoor unit.</b></p> <ul style="list-style-type: none"> <li>• This may cause an injury.</li> </ul>
	<p><b>Do not use an insecticide or flammable spray.</b></p> <ul style="list-style-type: none"> <li>• This may cause a fire or deformation of the cabinet.</li> </ul>
	<p><b>Do not put a pet or houseplant where it will be exposed to direct airflow.</b></p> <ul style="list-style-type: none"> <li>• This could injure the pet or plant.</li> </ul>
	<p><b>Do not leave the unit on an installation stand which is damaged.</b></p> <ul style="list-style-type: none"> <li>• The unit may fall and this may cause an injury.</li> </ul>
	<p><b>Do not step onto an unstable bench when maintaining the unit, etc.</b></p> <ul style="list-style-type: none"> <li>• This may cause an injury, etc. if you fall down.</li> </ul>
	<p><b>Do not pull the power supply cord.</b></p> <ul style="list-style-type: none"> <li>• The core wire of the power supply cord may be disconnected and this may cause a fire.</li> </ul>
	<p><b>Do not charge or disassemble the batteries and do not throw them into a fire.</b></p> <ul style="list-style-type: none"> <li>• This may result in leakage, fire or an explosion.</li> </ul>
	<p><b>Do not operate the unit for a long time in high humidity, e.g. leaving a door or window open.</b></p> <ul style="list-style-type: none"> <li>• In the cooling mode, if the unit is operated in a room with high humidity (80% RH or more) for a long time, water condensed in the air conditioner may drop and wet or damage furniture, etc.</li> </ul>
	<p><b>Do not use the unit for special purposes.</b></p> <ul style="list-style-type: none"> <li>• Do not use this air conditioner to preserve precision devices, food, animals, plants and art objects. This may cause deterioration of quality, etc.</li> </ul>
	<p><b>Do not put a stove, etc. where they are exposed to direct airflow.</b></p> <ul style="list-style-type: none"> <li>• This may cause imperfect combustion.</li> </ul>

# SAFETY PRECAUTIONS

## ⚠ CAUTION



**When the unit is to be cleaned, switch it off and disconnect the power supply plug or turn off the breaker.**

- Since the fan rotates at high speed during operation, this may cause an injury.

**When the unit is not going to be used for a long time, disconnect the power supply plug or turn off the breaker.**

**Replace the 2 batteries with new ones of same type.**

- Using an old battery together with a new one may result in heat generation, leakage or an explosion.

**If liquid from the batteries gets onto your skin or clothes, wash it well with clean water.**

- If liquid from the batteries gets into your eyes, wash them well with clean water and consult a doctor at once.

**Ventilate well in using the unit with a stove, etc.**

- An oxygen shortage may occur.



**Do not operate switches with wet hands.**

- This may cause an electric shock.

**Do not clean the air conditioner with water.**

- Water may enter the unit and degrade the insulation. This may cause an electric shock.



**Do not step or put anything on the indoor/outdoor unit.**

- This may cause an injury, etc. if you or something falls down.

## For installation

## ⚠ WARNING

- Consult your dealer for installation of the air conditioner.

## ⚠ CAUTION



**Do not install the unit where flammable gas could leak.**

- If gas leaks and collects around the unit, it may cause an explosion.



**Earth the unit.**

- Do not connect the earth to a gas pipe, water pipe, lightning rod or the earth of a telephone. If the earthing is incorrect, it may cause an electric shock.

**Install an earth leakage breaker depending on the place where the air conditioner is to be installed (humid places, etc.).**

- If the earth leakage breaker is not installed, it may cause an electric shock.

**Drain should be fully drained.**

- If the drainage route is incomplete, water may drop from the unit. This may wet and damage the furniture.

# NAME OF EACH PART

## Indoor unit

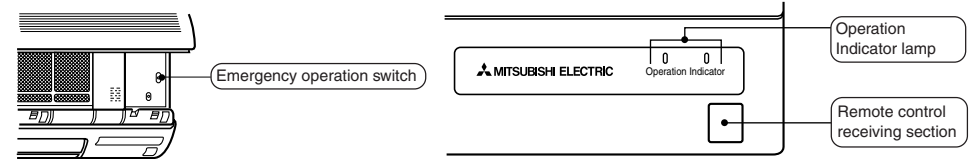
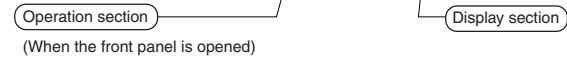
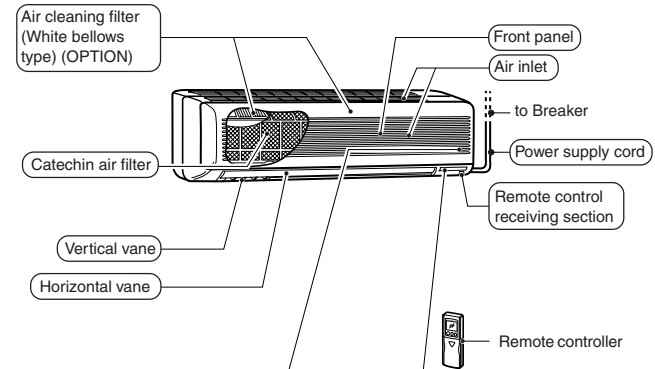

## Outdoor unit

MUH-A24WV  
MUH-A30WV  
MUH-A30WV

MU-A18WV  
MUH-A18WV  
MUH-A24WV

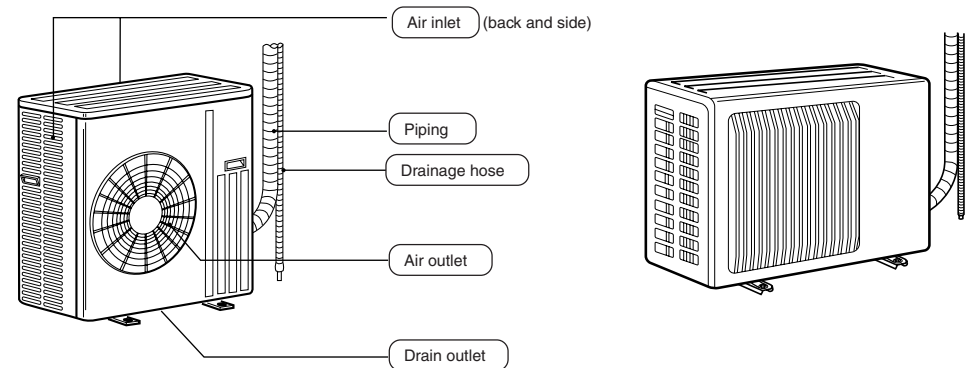

# NAME OF EACH PART

## Remote controller

### COOL & HEAT type (MSH series)

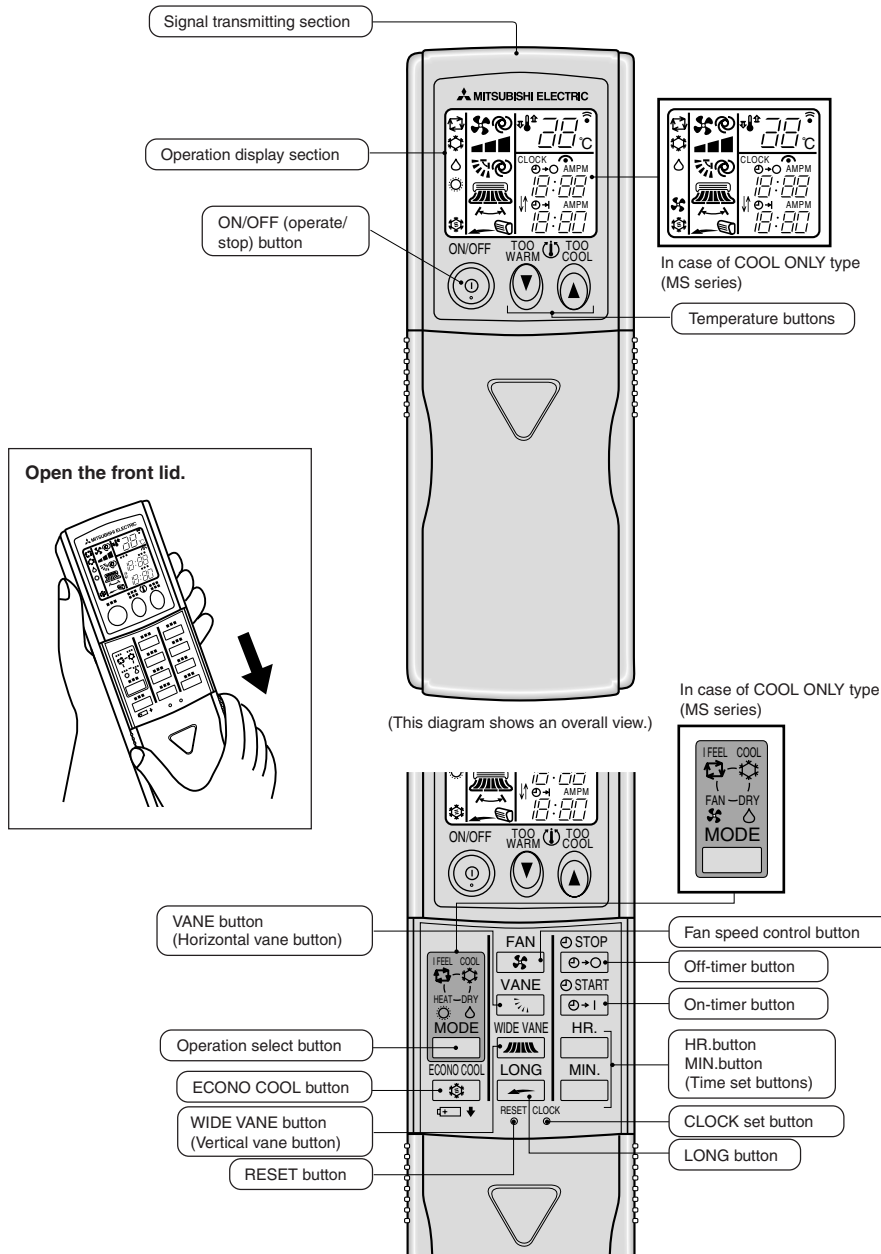

(Refer to PREPARATION BEFORE OPERATION for details.)

# PREPARATION BEFORE OPERATION

## Auto restart function

These models are equipped with an auto restart function. If you do not want to use this function, please consult the service representative because the setting of the unit needs to be changed.

### Auto restart function is ...

When the indoor unit is controlled with the remote controller, the operation mode, the set temperature and the fan speed are stored in the memory. If a power failure occurs or the main power is turned off during operation, "Auto restart function" sets automatically to start operating in the same mode as the one set with the remote controller just before the shutoff of the main power. (Refer to page 6 for details.)

## Indoor unit

Insert the power supply plug into the power outlet and/or turn the breaker on.

### WARNING:

Remove dirt from the power supply plug and insert the plug securely.

If dirt adheres to the plug or insertion is incomplete, it may cause a fire or an electric shock.

Check the type of air conditioner.

Type	Model Name
COOL & HEAT	MSH-A18/24/30WV
COOL ONLY	MS-A18/24/30WV

### NOTE:

This operating instructions manual has different contents for the COOL & HEAT type air conditioner and COOL ONLY type.

Follow the appropriate instructions for each type of air conditioner.

## Remote controller

The remote controller used for the COOL ONLY type air conditioner is different from the one used for the COOL & HEAT type as shown in the illustrations to the left.

Check the difference of operation mode.

Type	Operation Mode
COOL & HEAT	(I FEEL...), (COOL), (DRY), (HEAT)
COOL ONLY	(I FEEL...), (COLL), (DRY), (FAN)

### NOTE:

Only the remote controller for the COOL & HEAT type air conditioner is illustrated as an example in this operating instructions manual.

# PREPARATION BEFORE OPERATION

## Remote controller

### How to set the batteries and the current time

- 1 Remove the front lid and insert batteries. Then reattach the front lid.

Insert the minus pole of the batteries first. Check if the polarity of the batteries is correct.

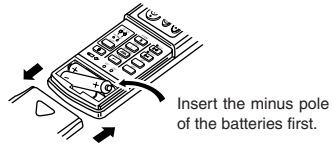

- 2 Press the RESET button.

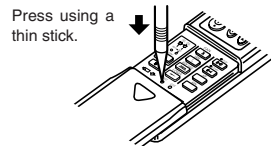

- If the RESET button is not pressed, the remote controller may not operate correctly.

- 3 Press the CLOCK set button.

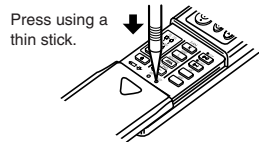

- 4 Press the  HR. and  MIN. buttons (TIME SET buttons) to set the current time.

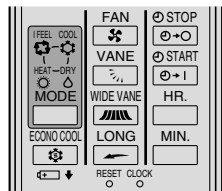

- Each time the  button is pressed, the set time increases by 1 hour, and each time the  button is pressed, the set time increases by 1 minute.

- 5 Press the CLOCK set button again and close the front lid.

### Handling of the remote controller

- The range that the signal can reach is about 6 m when the remote controller is pointed at the front of the indoor unit.
- When a button is pressed, one or two beeps will be heard from the indoor unit. If no sound is heard, operate again.
- Use the remote controller carefully. If it is dropped, thrown or it gets wet, the remote controller may not operate.

### When installing on a wall, etc.

- Install the remote controller holder in a position where the signal reception sound (beep) can be heard from the indoor unit when the button is pressed.

### How to install/remove the remote controller

Installing : Insert the remote controller downward.  
Removing : Pull it up.

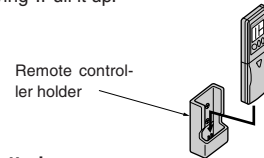

### Dry-cell batteries

#### ■ Reference for replacing batteries

Replace the batteries with new AAA alkaline batteries in the following cases:

- When the indoor unit does not respond to the remote control signal.
- When the display on the remote controller becomes dim.
- When a button of the remote controller is pressed, all displays appear on the screen, and then disappear immediately.

Do not use manganese batteries. The remote controller could malfunction.

- The service life of an alkaline battery is about 1 year. However, a battery whose time limit is approaching may be exhausted soon. The recommended usable time limit is indicated (month/year) on the bottom of the battery.
- To prevent liquid leakage, take out all batteries when the remote controller is not going to be used for a long time.

#### ⚠ CAUTION:

If liquid from the batteries gets onto your skin or clothes, wash it well with clean water.

If liquid from the batteries gets into your eyes, wash them well with clean water and consult a doctor at once.

- Do not use rechargeable batteries.
- Replace the 2 batteries with new ones of the same type.
- Dispose of exhausted batteries in the correct manner.

## When the remote controller cannot be used (emergency operation)

When the batteries of the remote controller run out or the remote controller malfunctions, the emergency operation can be done using the EMERGENCY OPERATION switch.

### COOL & HEAT type (MSH series)

- 1 Press the EMERGENCY OPERATION switch.

- Each time the EMERGENCY OPERATION switch is pressed, the unit will operate in order of EMERGENCY COOL MODE, EMERGENCY HEAT MODE and STOP MODE.

However, when the EMERGENCY OPERATION switch is once pressed, the unit will operate in test run for 30 minutes and then the operation mode shifts to EMERGENCY MODE.

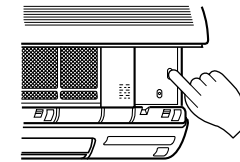

- Details of EMERGENCY MODE are as shown below. However, the temperature control does not work for 30 minutes in test run and the unit is set to High in test run and shifts to Medium after 30 minutes.

Operation mode	COOL	HEAT
Set temperature	24°C	24°C
Fan speed	Medium	Medium
Horizontal vane	Auto	Auto
Vertical vane	Front	Front

- The operation mode is indicated by the Operation Indicator lamp on the indoor unit as following figure.

#### Operation Indicator lamp

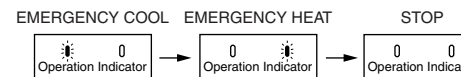

- To stop the emergency operation, press the EMERGENCY OPERATION switch once (in case of EMERGENCY HEAT MODE) or twice (in case of EMERGENCY COOL MODE).

### COOL ONLY type (MS series)

- 1 Press the EMERGENCY OPERATION switch.

- When the EMERGENCY OPERATION switch is pressed, the unit will operate in test run for 30 minutes at first and then the operation mode shifts to EMERGENCY COOL MODE.

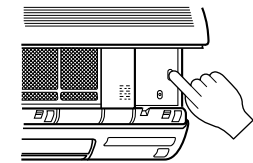

- Details of EMERGENCY COOL MODE are as shown below. However, the temperature control does not work for 30 minutes in test run and the unit is set to continuous operation. The fan speed is set to High in test run and shifts to Medium after 30 minutes.

Operation mode	COOL
Set temperature	24°C
Fan speed	Medium
Horizontal vane	Auto
Vertical vane	Front

- The operation mode is indicated by the Operation Indicator lamp on the indoor unit as following figure.

#### Operation Indicator lamp

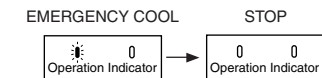

- To stop the EMERGENCY COOL MODE, press the EMERGENCY OPERATION switch again.

Each time the switch is pressed, the operation mode alternates between the EMERGENCY COOL MODE and STOP MODE.

# I FEEL... AUTO OPERATION

With the “I FEEL...” auto operation mode, the optimum room condition can be set automatically with a one-touch operation.



### To start operation:

Press the button.

When the “I FEEL...” mode is selected, the air conditioner is automatically controlled at the optimum temperature.

### To stop operation:

Press the button.

### If you feel slightly warm:

Press the button to lower the temperature.

One press lowers the temperature by about 1°C.

### If you feel slightly cool:

Press the button to raise the temperature.

One press raises the temperature by about 1°C.

When “I FEEL...” is not selected, press the button until it is set.

Each time the button is pressed, the operation mode is changed in sequence: (I FEEL...) → (COOL) → (DRY) → (HEAT: MSH series) / (FAN: MS series)

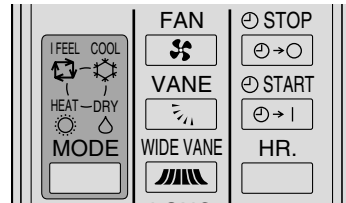

## Description of “AUTO RESTART FUNCTION”

- These units are equipped with an auto restart function. When the main power is turned on, the air conditioner will start operation automatically in the same mode as the one set with the remote controller before the shutoff of the main power.
- If the unit was set to off with the remote controller before the shutoff of the main power, it will remain stopped even after the main power is turned on.
- If the unit was in the emergency operation before the shutoff of the main power, it will start operation, when main power comes on, in the same mode as the one set with the remote controller before the emergency operation.
- If the unit is operated in “I FEEL...” mode before power failure, the operation is not stored in the memory. In “I FEEL...” mode, the operation is decided by the initial room temperature at (re)start.

## Description of “I FEEL...” mode

### Details of operation

According to the room temperature when the operation starts, the operation mode is automatically set to COOL, DRY or HEAT. However, when operation is started again within 2 hours after it is stopped, the same operation mode before the operation is stopped is selected. The operation mode selected first is not changed even if the room temperature changes. If the operation mode does not match the room condition, select the appropriate operation mode by pressing the button.

### Details of auto operation

	COOL & HEAT type (MSH series)		COOL ONLY type (MS series)	
Room temperature when started	Operation mode	Target temperature (initial state)	Operation mode	Target temperature (initial state)
About 25°C or higher	COOL	About 24°C	COOL	About 24°C
About 25°C - 23°C	DRY	—	DRY	—
About 23°C or lower	HEAT	About 26°C	DRY	—

### NOTE:

**COOL:** When the room temperature is 2°C higher than the set temperature, the set temperature may not be changed since the air conditioner is operating to reach the target (set) temperature. In this case, please wait until the room temperature drops to within 2°C of the set temperature and then change the set temperature.

**HEAT:** When the room temperature is 2°C lower than the set temperature, the set temperature may not be changed since the air conditioner is operating to reach the target (set) temperature. In this case, please wait until the room temperature rises to within 2°C of the set temperature and then change the set temperature.

### Details of display on the indoor unit

The operation indicator at the right side of the indoor unit indicates the operation state.

	Lighted
	Blinking
	Not lighted

### Operation indicator lamp

Indication	Operation state	Difference between target temperature and room temperature
	This shows that the air conditioner is operating to reach the target temperature. Please wait until the target temperature is obtained.	About 2°C or more
	This shows that the room temperature is approaching the target temperature.	About 2°C or less
	(In case of outdoor unit MXZ series only) Please refer to Information for multi system air conditioner. (Page 7)	—

# MANUAL OPERATION (COOL, DRY, HEAT/FAN)

# AIR FLOW VELOCITY AND DIRECTION ADJUSTMENT

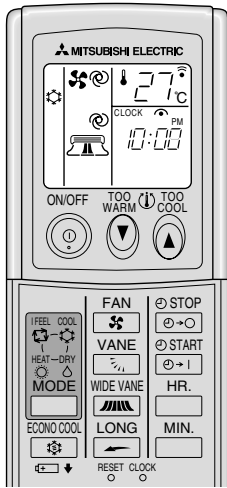

## To select the COOL, DRY or HEAT/FAN mode:

- 1 Press the button.
- 2 Select the operation mode by pressing the button.  
Each time this button is pressed, the operation mode is changed in sequence: → → → / (I FEEL...)

## HEAT mode or FAN mode

Check the type of the air conditioner. (Refer to page 4.)

Type	Operation mode
COOL & HEAT	HEAT
COOL ONLY	FAN

## To stop operation:

- Press the button.  
After the operation mode is set once, the operation starts in the same mode as the one set previously from the next time by simply pressing the button.

## When the set temperature is to be changed:

- Press the button to lower the temperature. One press lowers the temperature by about 1°C.
- Press the button to raise the temperature. One press raises the temperature by about 1°C.

## In HEAT operation

- If the air conditioner absorbs too much heat from the air, it may be overloaded. Following a judgement made by the microprocessor, the fan in the outdoor unit is automatically stopped to protect the air conditioner. When the outdoor unit's fan is stopped, frost may form on the outdoor unit, but this is not a problem.

## In DRY operation

- The temperature control (temperature setting) cannot be done.
- The room temperature is slightly lowered in this operation mode.

## The details of the display on the indoor unit are explained on page 6.

### NOTE:

When the ambient temperature is too high, the room temperature may not reach the set temperature since the unit operates to cool the room under a high load.

## Information for multi system air conditioner (Outdoor unit: MXZ series)

Multi system air conditioner (Outdoor unit: MXZ series) can connect two or more indoor units with one outdoor unit. According to the capacity, two or more units can operate simultaneously.

- When you try to operate two or more indoor units with one outdoor unit simultaneously, one for the cooling and the other for heating, the operation mode of the indoor unit that operates earlier is selected. The other indoor units that will start the operation later cannot operate, indicating an operation state. (Refer to the table of Operation Indicator lamp on page 6.) In this case, please set all the indoor units to the same operation mode.
- When indoor unit starts the operation while the defrosting of outdoor unit is being done, it takes a few minutes (max. 10 minutes) to blow out the warm air.
- In the heating operation, the indoor unit that does not operate may get warm or the sound of refrigerant flowing may be heard. This is not a malfunction since the refrigerant continuously flows into the indoor unit that does not operate.

## Description of "AUTO RESTART FUNCTION"

Refer to page 6.

AIR FLOW velocity and direction can be selected as required.

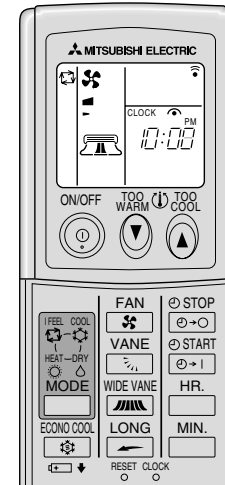

## To change the AIR FLOW velocity, press the button.

Each time the button is pressed, the fan speed is changed in sequence:  
■ (Low) → ■ (Med.) → ■ (High) → (AUTO)

- Use the ■ (High) notch to cool/heat the room more.
- If the operating sound of the air conditioner disturbs your sleep, use the ■ (Low) notch.

## To change the AIR FLOW blowing direction vertically, press the button.

Each time the button is pressed, the angle of the horizontal vane is changed in sequence: (1) → (2) → (3) → (4) → (5) → (SWING) → (AUTO)

## SWING OPERATION

Use the swing operation for the air flow to reach all corners of the room.

## Recommended horizontal vane range

Use the (AUTO) position usually.  
Use position (1) or (2) in the COOL or DRY mode and use positions (3) to (5) in the HEAT mode when adjusting to your requirements.

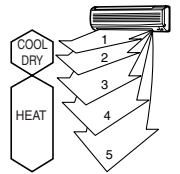

### NOTE:

- In the cooling operation, when the air conditioner is operated with setting the horizontal vane to (4) or (5) for 1 hour, the AIR FLOW direction is automatically set to horizontal to prevent condensed water from dropping.
- Adjust the vertical AIR FLOW direction using the remote controller. If the horizontal vane is moved manually, it may cause trouble.
- In the heating operation, if the air flow temperature is too low or when defrosting is being done, the horizontal vane position is set to (1).

## Auto air flow direction control operation

When the AUTO mode is selected with the button, the position of the horizontal vane is automatically set to correspond to the operation mode for effective operation.

- (1) HEAT: When the air flow temperature is too low, the air is blown out horizontally.  
When the air flow temperature rises, the air is blown out downwards.
- (2) COOL, DRY: The air is blown out horizontally.
- (3) FAN: The air is blown out downwards.

## To change the AIR FLOW blowing direction horizontally, press the button.

Each time the button is pressed, the angle of the VERTICAL VANE is changed in sequence:



## SWING OPERATION

Use the swing operation for the air flow to reach all corners of the room.

## Horizontal AIR FLOW blowing range

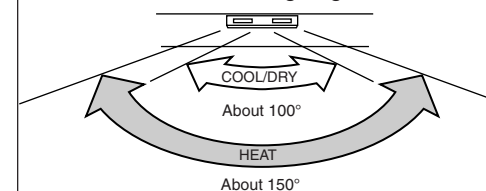

### NOTE:

Adjust the horizontal AIR FLOW direction using the remote controller. If the VERTICAL VANE is moved manually, it may cause trouble.

# LONG OPERATION

Use this operation when you want the air flow to reach a long distance.

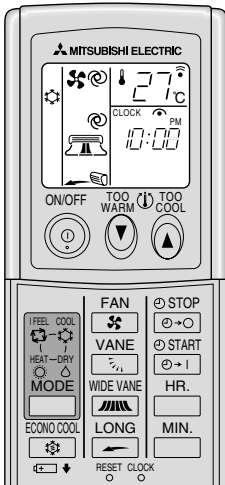

Perform the following operations while the unit is operating.

Press the **LONG** button.

The fan speed increases.  
When the fan speed is set to **(AUTO)**, the fan speed is higher than a fan speed determined by the room temperature and the set temperature.  
In addition, the HORIZONTAL VANE moves to the position for LONG mode.

### Mechanism of the LONG operation

In the following example, the VERTICAL VANE is set to (front).

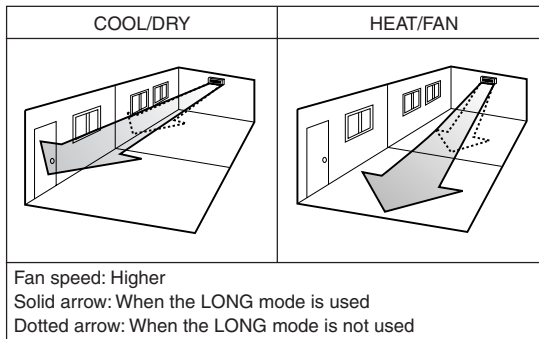

### To release the LONG mode:

Press the **LONG** button again.

LONG mode is also released in the following ways.

- By pressing the **VANE** button
- By pressing the **ECONO COOL** button (only during COOL mode)

Even when the LONG mode is being used, the air may not reach a long distance due to the installation location of the air conditioner.

In this case, press the **FAN** button to set the fan speed to (High), and then press the **LONG** button.

MODE, **FAN**, and **WIDE VANE** buttons, temperature buttons and the ON/OFF timer are available.

# ECONO COOL OPERATION

Use this operation when you want to be comfortable in COOL mode even with energy saved.

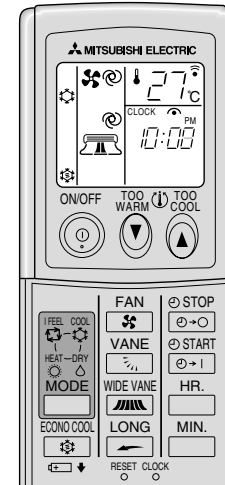

Perform the following operations while the unit is operating in the MANUAL COOL mode.

Press the **ECONO COOL** button.

When the (ECONO COOL) operation is selected in COOL mode, the air conditioner performs swing operation in various cycle according to the temperature of air conditioner.  
Also SET TEMPERATURE is automatically set 2°C higher than in COOL mode.

### To release the ECONO COOL operation:

Press the **ECONO COOL** button again.

- When the **VANE** button or the **LONG** button is pressed or the operation mode is changed during the ECONO COOL operation, ECONO COOL operation is released.
- The **FAN** button, the **TOO WARM** or **TOO COOL** button and ON/OFF timer (explained below) are available.

### What is "ECONO COOL"?

Swing air flow (change of air flow) makes you feel cooler than constant air flow. So, even though the set temperature is automatically set 2°C higher, it is possible to perform cooling operation with keeping comfort. As a result, energy can be saved.

# TIMER OPERATION (ON/OFF TIMER)

It is convenient to set the timer when you go to bed, when you get home, when you get up, etc.

### How to set the ON timer

1 Press the **START** button during operation.

Each time the button is pressed, the ON timer mode alternates between ON and OFF.

2 Set the time of the timer using the **HR.** and **MIN.** buttons.

Each time the **HR.** button is pressed, the set time increases by 1 hour; each time the **MIN.** button is pressed, the set time increases by 10 minutes.

### To release the ON timer:

Press the **START** button.

### Programming timer operation

The ON timer and the OFF timer can be used in combination. The timer of the set time that is reached first will operate first. ("1" mark indicates the order of timer operations.)

- If the current time has not been set, the timer operation cannot be used.

### NOTE:

If the main power is turned off or a power failure occurs while AUTO START/STOP timer is active, the timer setting is cancelled. As these models are equipped with an auto restart function, the air conditioner starts operating with timer cancelled at the same time that power is restored.

### How to set the OFF timer

1 Press the **STOP** button during operation.

Each time the button is pressed, the OFF timer mode alternates between ON and OFF.

2 Set the time of the timer using the **HR.** and **MIN.** buttons.

Each time the **HR.** button is pressed, the set time increases by 1 hour; each time the **MIN.** button is pressed, the set time increases by 10 minutes.

### To release the OFF timer:

Press the **STOP** button.



# WHEN THE AIR CONDITIONER IS NOT GOING TO BE USED FOR A LONG TIME

## When it is not going to be used for a long time:

- 1 Perform the FAN operation for 3 or 4 hours to dry the inside of the air conditioner.

### COOL & HEAT type:

- To perform FAN operation, set the remote controller to the highest temperature in the MANUAL COOL mode. (Refer to page 7.)

### COOL ONLY type:

- Select the FAN mode. (Refer to page 7.)

- 2 Turn off the breaker and/or disconnect the power supply plug.



**CAUTION:**  
Turn off the breaker or disconnect the power supply plug when the air conditioner is not going to be used for a long time. Dirt may collect and this may cause a fire.

- 3 Remove the batteries from the remote controller.

**CAUTION:**  
To prevent liquid leakage, take out all batteries when the remote controller is not going to be used for a long time.

## When the air conditioner is to be used again:

- 1 Clean the air filter and install it in the indoor unit.

(Refer to page 10 for cleaning instructions.)

- 2 Check that the air inlet and outlet of the indoor/outdoor units are not blocked with any obstacles.

- 3 Check that the earth is connected correctly.

**CAUTION:**  
Earth the unit.

Do not connect the earth to a gas pipe, water pipe, lightning rod or the earth of a telephone. If the earthing is incorrect, it may cause an electric shock.

# MAINTENANCE

## Before starting maintenance

- Turn off the breaker and/or disconnect the power supply plug.



**CAUTION:**  
When the unit is to be cleaned, switch it off and disconnect the power supply plug or turn off the breaker. Since the fan rotates at high speed during operation, it may cause an injury.

## Cleaning the indoor unit

- Clean the unit using a soft dry cloth.
  - If the dirt is noticeable, wipe the unit with a cloth soaked in a solution of mild detergent diluted in lukewarm water.
  - Do not use gasoline, benzene, polishing powder, or insecticide. The unit may be damaged.

## CAUTION

**Do not open the front panel up past the level position. The panel may come off in order to prevent it from being damaged.**

- The front panel may also come off if the upper part of the front panel is pulled down.

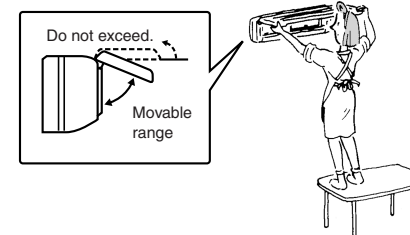

- If the front panel comes off, attach it as explained below. Keeping the front panel level with one hand, insert the hinges one by one with the other hand into the notches at the left, right and center of the top of the indoor unit until they click into place. (1) Then, close the front panel. (2)

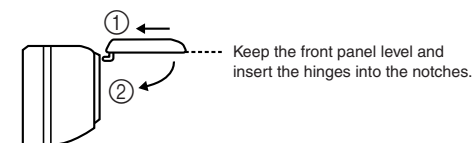

- Do not step onto an unstable bench when maintaining the unit, etc. This may cause an injury, etc. if you fall down.

# CLEANING THE CATECHIN AIR FILTER

Do not open the front panel up past the level position.  
The panel may come off in order to prevent it from being damaged.

## Cleaning the catechin air filter (about once every 2 weeks)

**1** Remove the catechin air filter.

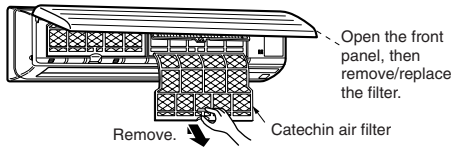

**3** After washing with water/lukewarm water, dry the catechin air filter well in the shade.

- Do not expose the catechin air filter to direct sunlight or heat from a fire when drying it.

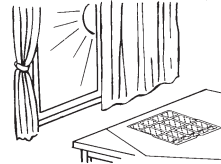

**4** Install the catechin air filter.

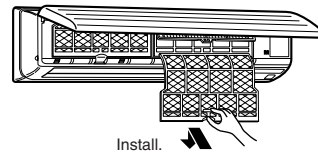

**CAUTION:**  
When the catechin air filter is to be removed, do not touch the metal parts of the indoor unit. This may cause an injury.

**2** Remove dirt from the catechin air filter using a vacuum cleaner or by washing the filter with water.

- If the dirt is noticeable, wash the filter with a solution of mild detergent diluted in lukewarm water.
- If hot water (50 °C or more) is used, the filter may be deformed.

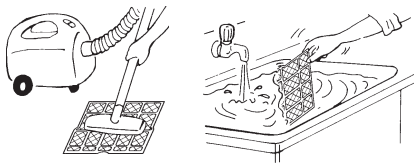

### What is "Catechin air filter"?

The air filter is dyed with a natural material, catechin, that is contained in tea. The catechin air filter deodorizes odor and noxious gases such as formaldehyde, ammonia, and acetaldehyde. Moreover, it restrains the activity of the viruses adhering to the filter.

# REPLACEMENT OF THE AIR CLEANING FILTER (OPTION)

When the capacity is lowered because of dirt, etc., it is necessary to replace the air cleaning filter.

## Air cleaning filter replacement

**1** Remove the catechin air filter.

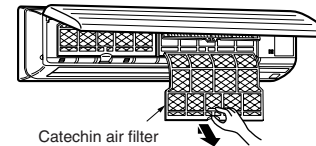

**2** Remove the air cleaning filter (White bellows type).

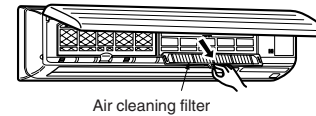

## About once every 4 months

**1** Install a new air cleaning filter.

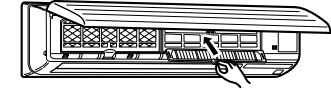

**2** Install the catechin air filter and securely close the front panel.

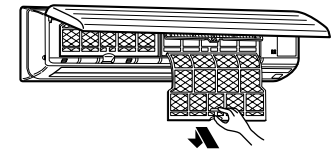

### Air cleaning filter

- If the air cleaning filter is clogged, it may lower the unit's capacity or cause condensation at the air outlet.
- The air cleaning filter is disposable. The standard usable term is about 4 months. However, if the colour of the filter turns to dark brown, replace the filter at once.

**Optional parts** Optional parts are available from your local dealer.

Name of parts	AIR CLEANING FILTER
Parts number	MAC-1700FT

- Please purchase the optional parts (MAC-1700FT) as a set (2 pcs) for the first time use.

## BEFORE CONTACTING THE SERVICE REPRESENTATIVE, CHECK THE FOLLOWING AGAIN

Question	Check points or Remedy
<b>The air conditioner cannot be operated.</b>	<ul style="list-style-type: none"> <li>Is the breaker turned on?</li> <li>Is the fuse blown?</li> <li>Is the ON timer set? (Page 8)</li> </ul>
<b>The room cannot be cooled or heated sufficiently.</b>	<ul style="list-style-type: none"> <li>Is the temperature setting correct? (Page 7)</li> <li>Is the filter clean? (Page 10)</li> <li>Are there any obstacles blocking the air inlet or outlet of the indoor or outdoor unit?</li> <li>Is a window or door open?</li> </ul>
<b>The air from the indoor unit smells strange.</b>	<ul style="list-style-type: none"> <li>Is the filter clean? (Page 10)</li> </ul>
<b>The display on the remote controller does not appear or it is dim. The indoor unit does not respond to the remote control signal.</b>	<ul style="list-style-type: none"> <li>Are the batteries exhausted? (Page 5)</li> <li>Is the polarity (+, -) of the batteries correct? (Page 5)</li> <li>Are any buttons on the remote controller of other electric appliances being pressed?</li> </ul>
<b>When a power failure occurs.</b>	<ul style="list-style-type: none"> <li>Does the air conditioner start operating again? If the air conditioner had operated before the power failure, as these models are equipped with an auto restart function, the air conditioner should start operating again. (Refer to Description of "AUTO RESTART FUNCTION" on page 6.)</li> </ul>

**Even if the above items are checked, when the air conditioner does not recover from the trouble, stop using the air conditioner and consult your dealer.**

### In the following cases, stop using the air conditioner and consult your dealer.

- When water leaks from the indoor unit.
- When the left operation indicator lamp blinks.
- When the breaker trips frequently.
- The remote control signal may not be received in a room where an electronic ON/OFF type fluorescent lamp (inverter-type fluorescent lamp, etc.) is used.
- Operation of the air conditioner may interfere with radio or TV reception in areas where the reception is weak. An amplifier may be required for the affected device.
- When thunder is heard, stop operation and disconnect the power supply plug or turn off the breaker. Otherwise, the electrical parts may be damaged.

## WHEN YOU THINK THAT TROUBLE HAS OCCURRED

Question	Answer (not a malfunction)
<b>The air conditioner cannot be operated for about 3 minutes when restarted.</b>	<ul style="list-style-type: none"> <li>This protects the air conditioner according to instructions from the microprocessor. Please wait.</li> </ul>
<b>Cracking sound is heard.</b>	<ul style="list-style-type: none"> <li>This sound is generated by the expansion/contraction of the front panel, etc. due to change in temperature.</li> </ul>
<b>The air from the indoor unit smells strange.</b>	<ul style="list-style-type: none"> <li>The air conditioner may suck in an odor adhering to the wall, carpet, furniture, cloth, etc. and blow it out with the air.</li> </ul>
<b>The fan stops during the DRY operation.</b>	<ul style="list-style-type: none"> <li>In DRY operation, the unit operates using the same refrigerant circuit as in COOL operation. DRY operation time has to be reduced in order to lower humidity without much room temperature decreasing. So the compressor sometimes stops, and at the same time the indoor fan stops. This prevents water condensed on the heat exchanger from evaporating again.</li> </ul>
<b>The sound of water flowing is heard.</b>	<ul style="list-style-type: none"> <li>This is the sound of refrigerant flowing inside the air conditioner.</li> <li>This is the sound of condensed water flowing in the heat exchanger.</li> <li>This is the sound of the heat exchanger defrosting.</li> </ul>
<b>The sound as burbling is heard.</b>	<ul style="list-style-type: none"> <li>This sound is heard when the outside air is absorbed from the drain hose in turning on the range hood or the ventilation fan and that makes water flowing in the drain hose spout out. This sound is also heard when the outside air blows into the drain hose in case the outside wind is strong.</li> </ul>
<b>The room cannot be cooled sufficiently.</b>	<ul style="list-style-type: none"> <li>When a ventilation fan or a gas cooker is used in a room, the cooling load increases, resulting in an insufficient cooling effect.</li> <li>When the outside air temperature is high, the cooling effect may not be sufficient.</li> </ul>
<b>Mist is discharged from the air outlet of the indoor unit.</b>	<ul style="list-style-type: none"> <li>The cool air from the air conditioner rapidly cools moisture in the air inside the room, and it turns into mist.</li> </ul>
<b>The air flow direction changes during operation. The direction of the horizontal vane cannot be adjusted with the remote controller.</b>	<ul style="list-style-type: none"> <li>When the air conditioner is operated in COOL or DRY mode, if the operation continues with air blowing down for 1 hour, the direction of the air flow is automatically set to horizontal to prevent condensed water from dropping.</li> <li>In the heating operation, if the air flow temperature is too low or when defrosting is being done, the horizontal vane position is automatically set to horizontal.</li> </ul>

Question	Answer (not a malfunction)
<b>Water leaks from the outdoor unit.</b>	<ul style="list-style-type: none"> <li>During COOL and DRY operations, pipe or pipe connecting sections are cooled and this causes water to condense.</li> <li>In the heating operation, the defrosting operation makes water frozen on the outdoor unit melt and drip down.</li> <li>In the heating operation, water condensed on the heat exchanger drips down.</li> </ul>
<b>White smoke is discharged from the outdoor unit.</b>	<ul style="list-style-type: none"> <li>In the heating operation, vapor generated by the defrosting operation looks like white smoke.</li> </ul>
<b>Air does not blow out soon in the heating operation.</b>	<ul style="list-style-type: none"> <li>Please wait as the air conditioner is preparing to blow out warm air.</li> </ul>
<b>The operation is stopped for about 10 minutes in the heating operation.</b>	<ul style="list-style-type: none"> <li>Defrosting of the outdoor unit is being done (Defrosting operation). Since this is completed in 10 minutes, please wait. (When the external temperature is too low and humidity is too high, frost is formed.)</li> </ul>
<b>Hissing sound is sometimes heard.</b>	<ul style="list-style-type: none"> <li>This is the sound when the flow of refrigerant inside the air conditioner is switched.</li> </ul>
<b>The room cannot be heated sufficiently.</b>	<ul style="list-style-type: none"> <li>When the outside air temperature is low, the heating effect may not be sufficient.</li> </ul>
<b>The swing operation of the VERTICAL VANE is suspended for about 15 seconds, then restarted.</b>	<ul style="list-style-type: none"> <li>This is for the swing operation of the VERTICAL VANE to be performed normally.</li> </ul>
<b>In a multi-unit system, the indoor unit which is not operating becomes warm and a sound, similar to water flowing, is heard from the unit.</b>	<ul style="list-style-type: none"> <li>A small amount of refrigerant continues to flow into the indoor unit even though it is not operating.</li> </ul>
<b>The air conditioner starts the operation only with the main power turned on, though you do not operate the unit with the remote controller.</b>	<ul style="list-style-type: none"> <li>These models are equipped with an auto restart function. When the main power is turned off without stopping the air conditioner with the remote controller and is turned on again, the air conditioner will start operation automatically in the same mode as the one set with the remote controller just before the shutoff of the main power.</li> </ul>

# INSTALLATION, RELOCATION AND INSPECTION

## Installation place

Avoid installing the air conditioner in the following places.

- Where flammable gas could leak.

### ⚠ CAUTION:

**Do not install the unit where flammable gas could leak. If gas leaks and collects around the unit, it may cause an explosion.**

- Where there is much machine oil.
- Salty places such as the seaside.
- Where sulfide gas is generated such as a hot spring.
- Where oil is splashed or where the area is filled with oily smoke.
- Where there is high-frequency or wireless equipment.

### ⚠ WARNING :

**If the air conditioner operates but does not cool or heat (depending on model) the room, consult your dealer since there may be a refrigerant leak. Be sure to ask the service representative whether there is refrigerant leakage or not when repairs are carried out.**

**The refrigerant charged in the air conditioner is safe. Refrigerant normally does not leak, however, if refrigerant gas leaks indoors, and comes into contact with the fire of a fan heater, space heater, stove, etc., harmful substances will be generated.**

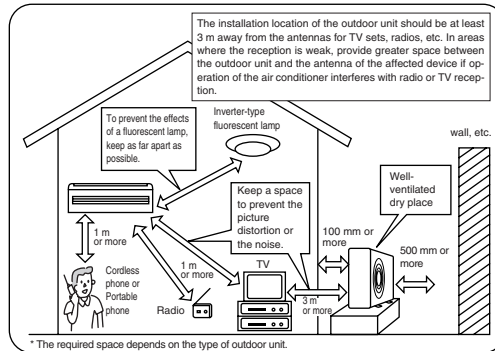

### ⚠ CAUTION:

- **Earth the unit. Do not connect the earth to a gas pipe, water pipe, lightning rod or the earth of a telephone. If the earthing is incorrect, it may cause an electric shock.**
- **Install an earth leakage breaker depending on the place where the air conditioner is to be installed (humid places, etc.). If the earth leakage breaker is not installed, it may cause an electric shock.**

## Inspection and maintenance

- When the air conditioner is used for several seasons, the capacity may be lowered due to dirt inside the unit.
- Depending on the condition, an odor may be generated or dehumidified water may not drain out smoothly due to dirt, dust, etc.
- It is recommended that the unit be inspected and maintained (charged) by specialist in addition to normal maintenance. Consult your dealer.

## Operating sound considerations

- Do not put an object around the air outlet of the outdoor unit. This may lower the capacity or increase the volume of the operating sound.
- If an abnormal sound is heard during operation, consult your dealer.

## Relocation

- When the air conditioner is to be removed or re-installed because of rebuilding, moving, etc., special techniques and work are required.

### ⚠ WARNING :

**Repairs or relocation should not be done by the customer. If this is done incorrectly, it may cause a fire, an electric shock, or an injury from the unit falling, water leaking, etc. Consult your dealer.**

## Disposal

To dispose of this product, consult your dealer.

If you have any questions, consult your dealer.

## Electrical work

- Provide an exclusive circuit for the power supply of the air conditioner.
- Be sure to observe the breaker capacity.

### ⚠ WARNING :

- **The customer should not install this unit. If installation is done incorrectly, it may cause a fire, an electric shock, or injury from the unit falling, water leaking, etc.**
- **Do not use intermediate connection of the power supply cord or the extension cord and do not connect many devices to one AC outlet. A fire or an electric shock may result from poor contact, poor insulation, exceeding the permissible current, etc. Consult your dealer.**

# SPECIFICATIONS

Model	Set name		MS-A18WV	MS-A24WV	MS-A30WV	MSH-A18WV		MSH-A24WV		MSH-A30WV	
	Indoor		MS-A18WV	MS-A24WV	MS-A30WV	MSH-A18WV		MSH-A24WV		MSH-A30WV	
	Outdoor		MU-A18WV	MU-A24WV	MU-A30WV	MUH-A18WV		MUH-A24WV		MUH-A30WV	
Function	Cooling					Cooling	Heating	Cooling	Heating	Cooling	Heating
Power supply	~ /N, 230V, 50Hz										
Capacity	kW	5.0	6.5	8.5	5.0	5.2	6.3	7.2	8.5	9.4	
Input	kW	1.81	2.48	3.26	1.78	1.61	2.41	2.48	3.26	3.43	
Weight	Indoor	kg	16								
	Outdoor	kg	44	60	75	47		74		77	
Refrigerant filling capacity (R410A)	kg	1.40	1.90	2.30	1.75		2.15		2.30		
IP code	Indoor	IP20									
	Outdoor	IP24									
Permissible excessive operating pressure	LP ps	MPa	1.64								
	HP ps	MPa	4.15								
Noise level	Indoor (High/Med./Low)	dB(A)	42/38/34	45/41/37	47/42/37	42/38/34	45/41/37	45/40/34	47/42/37		
	Outdoor	dB(A)	52	53	55	52		53		55	

### NOTE:

#### 1. Rating condition

Cooling	Indoor:	27°C DB, 19°C WB
	Outdoor:	35°C DB
Heating	Indoor:	20°C DB
	Outdoor:	7°C DB, 6°C WB

#### 2. Guaranteed operating range

		Indoor	Outdoor
Cooling	Upper limit	32°C DB 23°C WB	43°C DB —
	Lower limit	21°C DB 15°C WB	21°C DB —
Heating	Upper limit	27°C DB —	24°C DB 18°C WB
	Lower limit	20°C DB —	-10°C DB -11°C WB

This product is designed and intended for use in the residential, commercial and light-industrial environment.

The product at hand is based on the following EU regulations:

- Low Voltage Directive 73/23/ EEC
- Electromagnetic Compatibility Directive 89/336/ EEC



---

SG79Y259H03