

Revision A:

• Another type of the electronic control P.C. board (TYPE 2) has been added to the original one (TYPE 1). They are both compatible with MS/MSH-GE50VB-**E1**.

Please void OBH529.

INDOOR UNIT SERVICE MANUAL

No. OBH529
REVISED EDITION-A

Models

- MSC-GE20VB** **E1**
- MSC-GE25VB** **E1**
- MSC-GE35VB** **E1**
- MS-GE50VB** **E1**
- MSH-GE50VB** **E1**

Outdoor unit service manual
MU-GA•VB Series (OB386)
MUH-GA•VB Series (OB387)
MUX-A•VB Series (OB384)
MXZ-A•WV Series (OB319)
MU/MUH-GE•VB Series (OBH530)

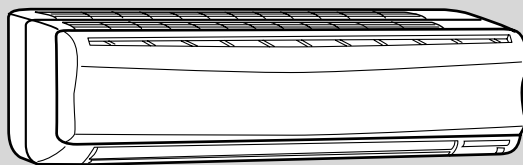

CONTENTS

1. TECHNICAL CHANGES	2
2. PART NAMES AND FUNCTIONS	2
3. SPECIFICATION	4
4. NOISE CRITERIA CURVES	5
5. OUTLINES AND DIMENSIONS	7
6. WIRING DIAGRAM	9
7. REFRIGERANT SYSTEM DIAGRAM	10
8. SERVICE FUNCTIONS	11
9. MICROPROCESSOR CONTROL	14
10. TROUBLESHOOTING	22
11. DISASSEMBLY INSTRUCTIONS	33

PARTS CATALOG (OBB529)

NOTE:

RoHS compliant products have <G> mark on the spec name plate.



Use the specified refrigerant only

Never use any refrigerant other than that specified.

Doing so may cause a burst, an explosion, or fire when the unit is being used, serviced, or disposed of.

Correct refrigerant is specified in the manuals and on the spec labels provided with our products.

We will not be held responsible for mechanical failure, system malfunction, unit breakdown or accidents caused by failure to follow the instructions.

Revision A:

- Another type of the electronic control P.C. board (TYPE 2) has been added to the original one (TYPE 1). They are both compatible with MS/MSH-GE50VB-**E1**.

1 TECHNICAL CHANGES

MSC-GA20VB -E1**** → **MSC-GE20VB -**E1****

MSC-GA25VB -E1**** → **MSC-GE25VB -**E1****

MSC-GA35VB -E1**** → **MSC-GE35VB -**E1****

1. Front panel has been changed.

MS-GA50VB -E1**** → **MS-GE50VB -**E1****

1. Indoor fan motor has been changed. (RC4V32-AA → RC4V32-BA)

MSH-GA50VB -E1**** → **MSH-GE50VB -**E1****

1. Indoor fan motor has been changed. (RC4V32-AA → RC4V32-BA)

2 PART NAMES AND FUNCTIONS

MSC-GE20VB MSC-GE25VB MSC-GE35VB

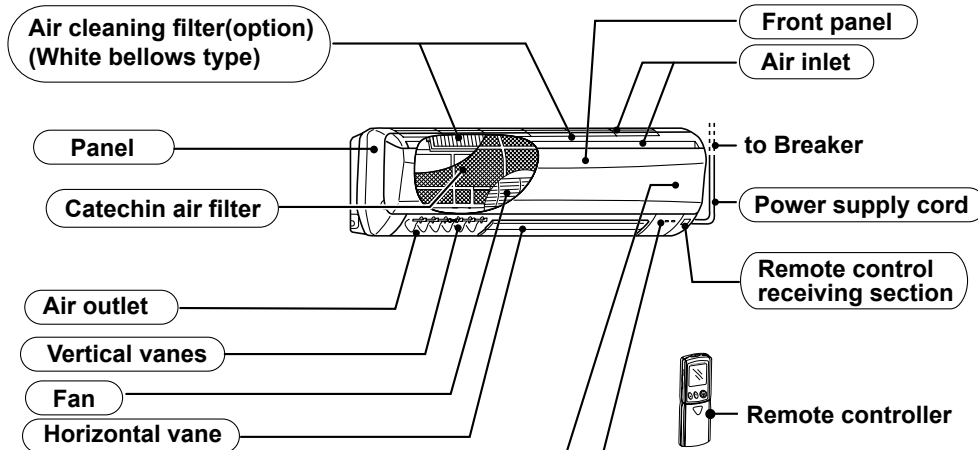

Operation section
(When the front panel is opened)

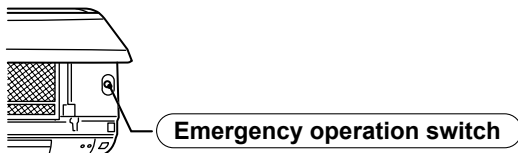

Display section

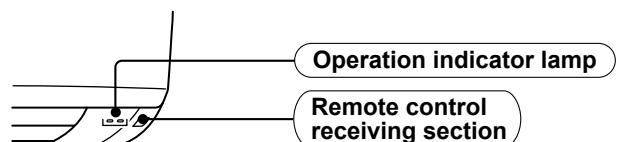

MS-GE50VB MSH-GE50VB

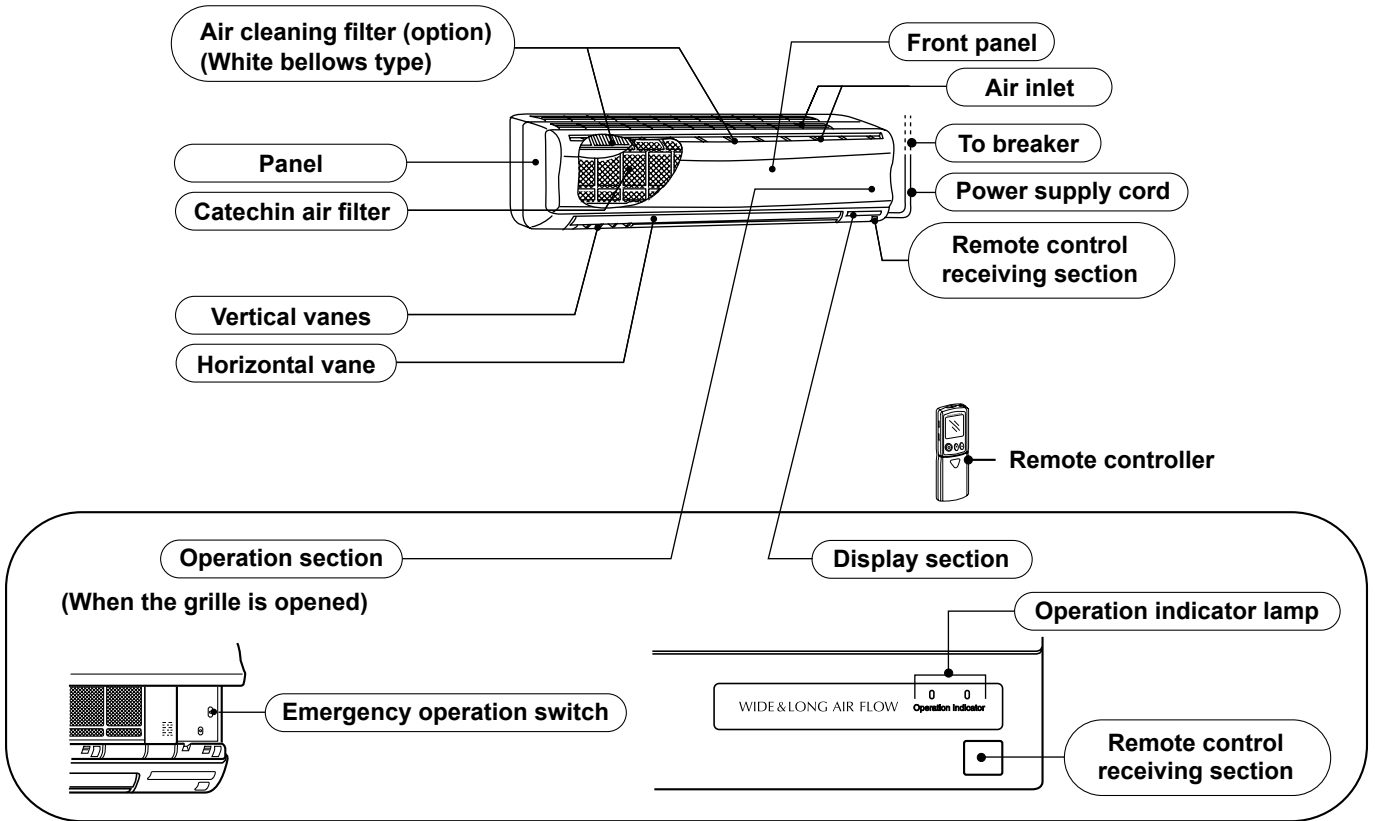

ACCESSORIES

		MSC-GE20VB MSC-GE25VB MSC-GE35VB	MS-GE50VB MSH-GE50VB
①	Installation plate	1	1
②	Installation plate fixing screw 4 × 25 mm	5	7
③	Remote controller holder	1	1
④	Fixing screw for ③ × 3.5 × 1.6 mm (Black)	2	2
⑤	Battery (AAA) for remote controller	2	2
⑥	Wireless remote controller	1	1
⑦	Felt tape (Used for left or left-rear piping)	1	1

Indoor model			MSC-GE20VB		MSC-GE25VB		MSC-GE35VB	
Function			Cooling	Heating	Cooling	Heating	Cooling	Heating
Power supply			Single phase 230 V, 50 Hz		Single phase 230 V, 50 Hz		Single phase 230 V, 50 Hz	
Electrical data	Breaker capacity	A	10		10		10	
	Running current	A	0.17		0.17		0.19	
	Power input	W	35		35		40	
	Power factor	%	90		90		92	
Fan motor	Model		RC4V19-JA		RC4V19-JA		RC4V19-HA	
	Fan motor current	A	0.17		0.17		0.19	
Dimensions W×H×D			mm 815×278×244		mm 815×278×244		mm 815×278×244	
Weight			kg 9		kg 9		kg 10	
Special remarks	Air direction		5		5		5	
	Air flow (High/Med./Low)	m ³ /h	474/372/276	510/420/342	474/384/306	588/456/342	582/444/324	606/498/396
	Sound level (High/Med./Low)	dB	36/31/25	36/31/25	36/31/25	39/32/25	40/33/26	39/33/26
	Fan speed (High/Med./Low)	rpm	900/750/600	950/820/700	900/770/650	1,050/870/700	930/760/600	960/830/700
	Fan speed regulator			3		3		3
Remote controller model			KM04F		KM04F		KM04F	

Indoor model			MS-GE50VB		MSH-GE50VB	
Function			Cooling	Cooling	Heating	
Power supply			Single phase 230 V, 50 Hz		Single phase 230 V, 50 Hz	
Electrical data	Breaker capacity	A	10		10	
	Running current	A	0.3		0.3	
	Power input	W	60		60	
	Power factor	%	87		87	
Fan motor	Model		RC4V32-BA		RC4V32-BA	
	Fan motor current	A	0.3		0.3	
Dimensions W×H×D			mm 1,100×325×258		mm 1,100×325×258	
Weight			kg 16		kg 16	
Special remarks	Air direction		5		5	
	Air flow (High/Med./Low)	m ³ /h	768/642/516		768/642/516	
	Sound level (High/Med./Low)	dB	42/38/34		42/38/34	
	Fan speed (High/Med./Low)	rpm	1,070/920/780		1,070/920/780	
	Fan speed regulator			3		3
Remote controller model			KM04B		KM04A	

NOTE: Test conditions are based on ISO 5151.

Cooling: Indoor Dry-bulb temperature 27°C Wet-bulb temperature 19°C

Outdoor Dry-bulb temperature 35°C Wet-bulb temperature 24°C

Heating: Indoor Dry-bulb temperature 20°C Wet-bulb temperature - °C

Outdoor Dry-bulb temperature 7°C Wet-bulb temperature 6°C

Indoor-Outdoor piping length: 5 m

MSC-GE20VB

FAN SPEED	FUNCTION	SPL(dB(A))	LINE
High	COOLING	36	●—●
	HEATING		○- - -○

Test conditions,
 Cooling : Dry-bulb temperature 27°C Wet-bulb temperature 19°C
 Heating : Dry-bulb temperature 20°C Wet-bulb temperature - °C

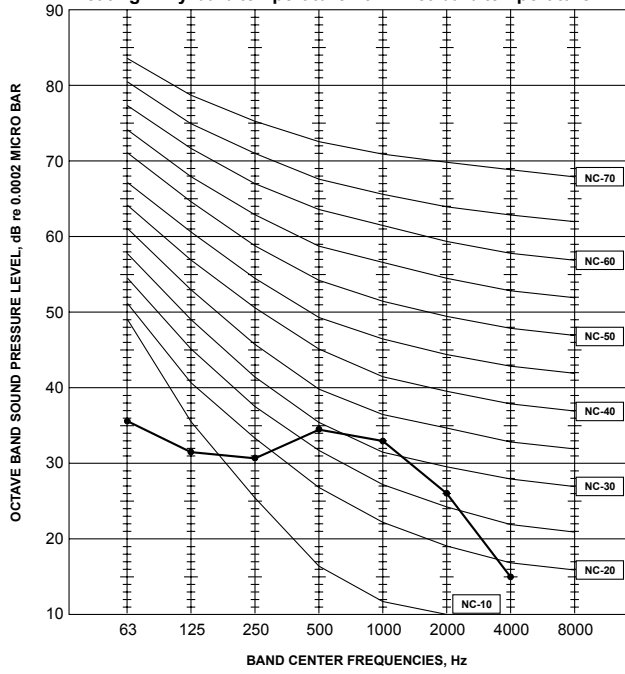

MSC-GE25VB

FAN SPEED	FUNCTION	SPL(dB(A))	LINE
High	COOLING	36	●—●
	HEATING	39	○- - -○

Test conditions,
 Cooling : Dry-bulb temperature 27°C Wet-bulb temperature 19°C
 Heating : Dry-bulb temperature 20°C Wet-bulb temperature - °C

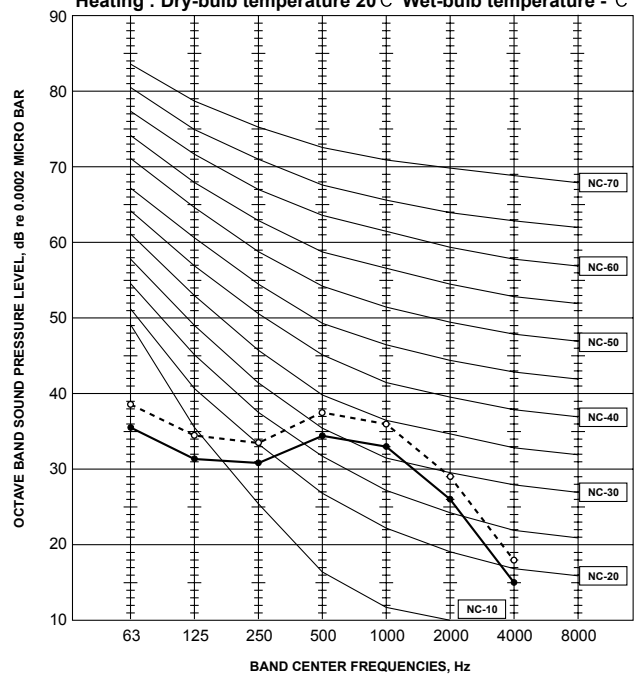

MSC-GE35VB

FAN SPEED	FUNCTION	SPL(dB(A))	LINE
High	COOLING	40	●—●
	HEATING	39	○- - -○

Test conditions.
 Cooling : Dry-bulb temperature 27°C Wet-bulb temperature 19°C
 Heating : Dry-bulb temperature 20°C Wet-bulb temperature - °C

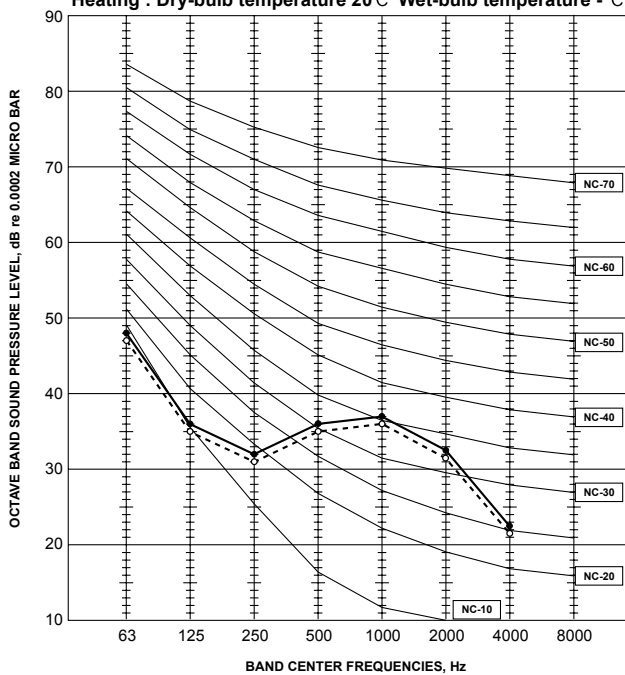

MS-GE50VB

FAN SPEED	FUNCTION	SPL(dB(A))	LINE
High	COOLING	42	●—●

Test conditions,
Cooling : Dry-bulb temperature 27°C Wet-bulb temperature 19°C

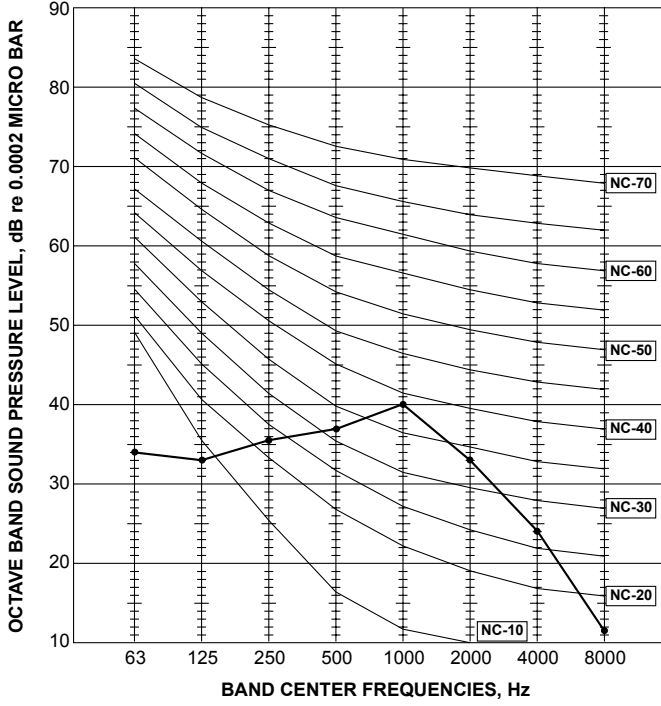

MSH-GE50VB

FAN SPEED	FUNCTION	SPL(dB(A))	LINE
High	COOLING	42	●—●
	HEATING		

Test conditions,
Cooling : Dry-bulb temperature 27°C Wet-bulb temperature 19°C
Heating : Dry-bulb temperature 20°C Wet-bulb temperature - °C

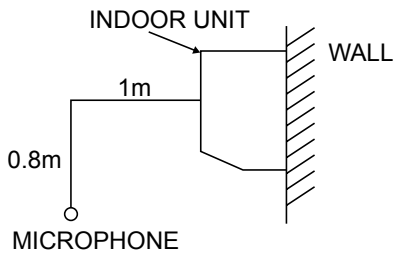
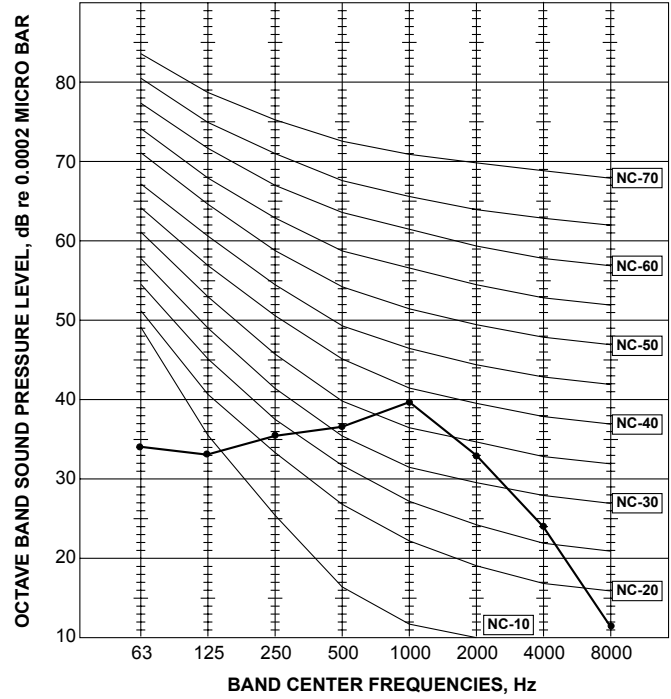

5

OUTLINES AND DIMENSIONS

**MSC-GE20VB
MSC-GE25VB**

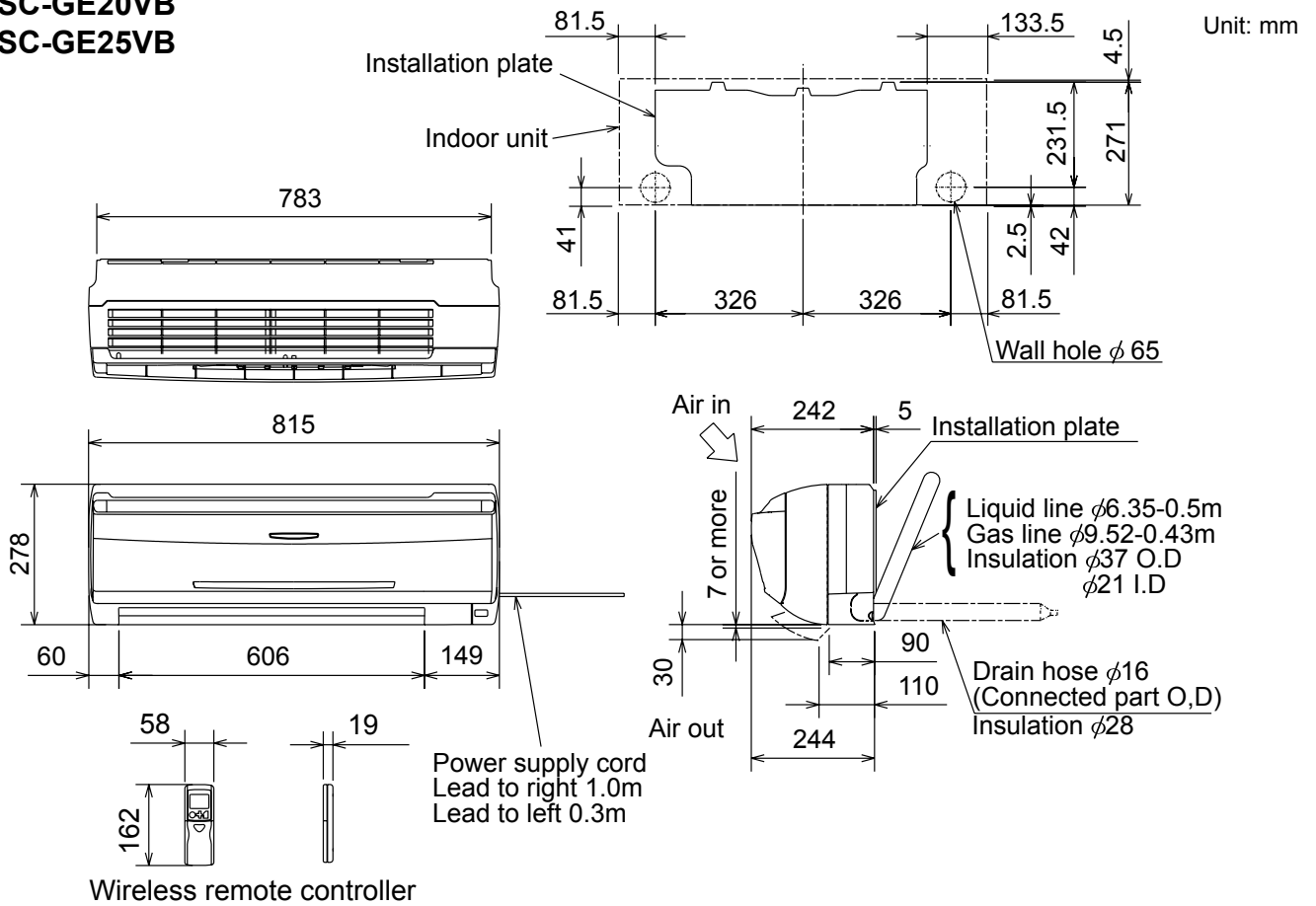

MSC-GE35VB

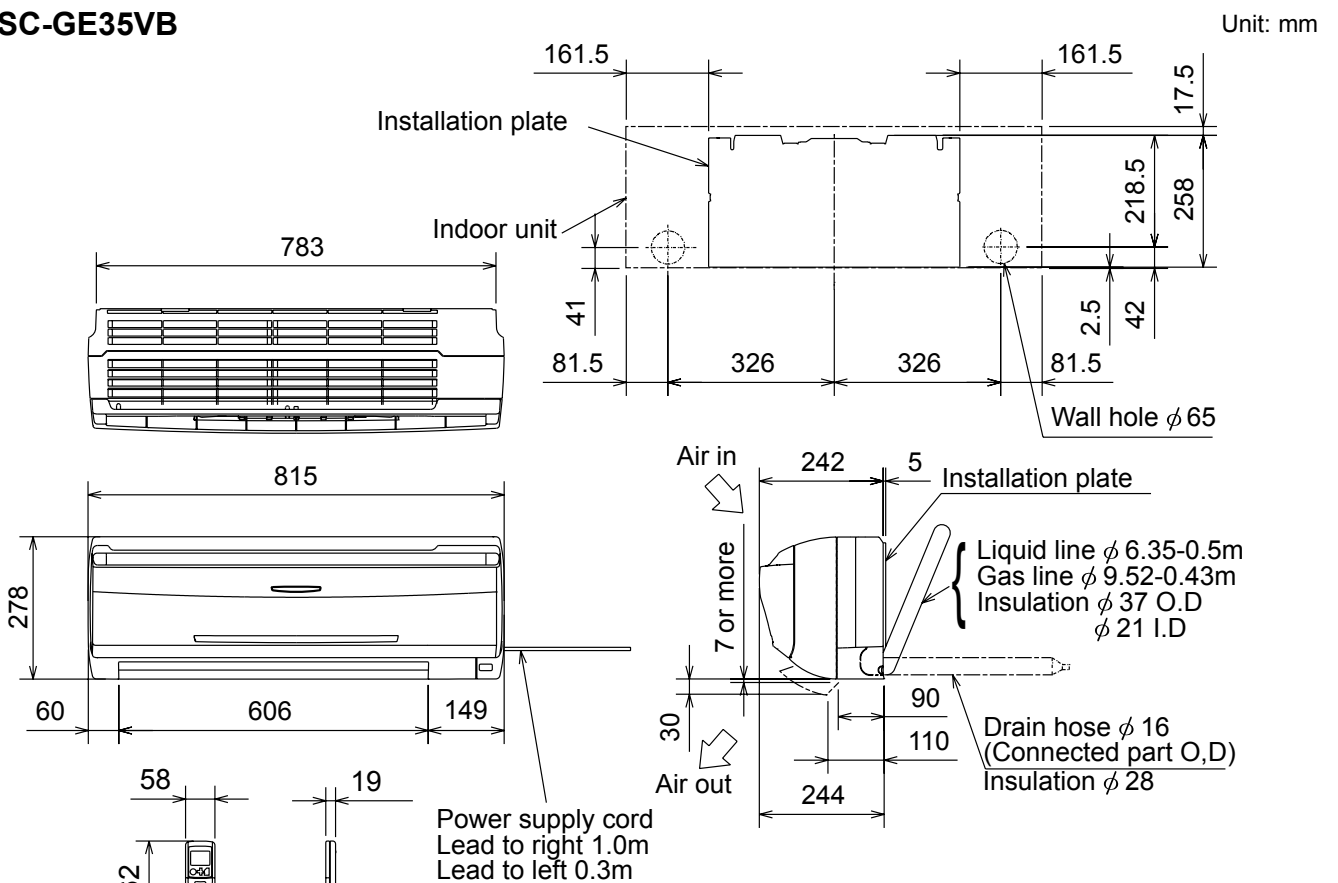

Wireless remote controller

OBH529A

MS-GE50VB
MSH-GE50VB

Unit: mm

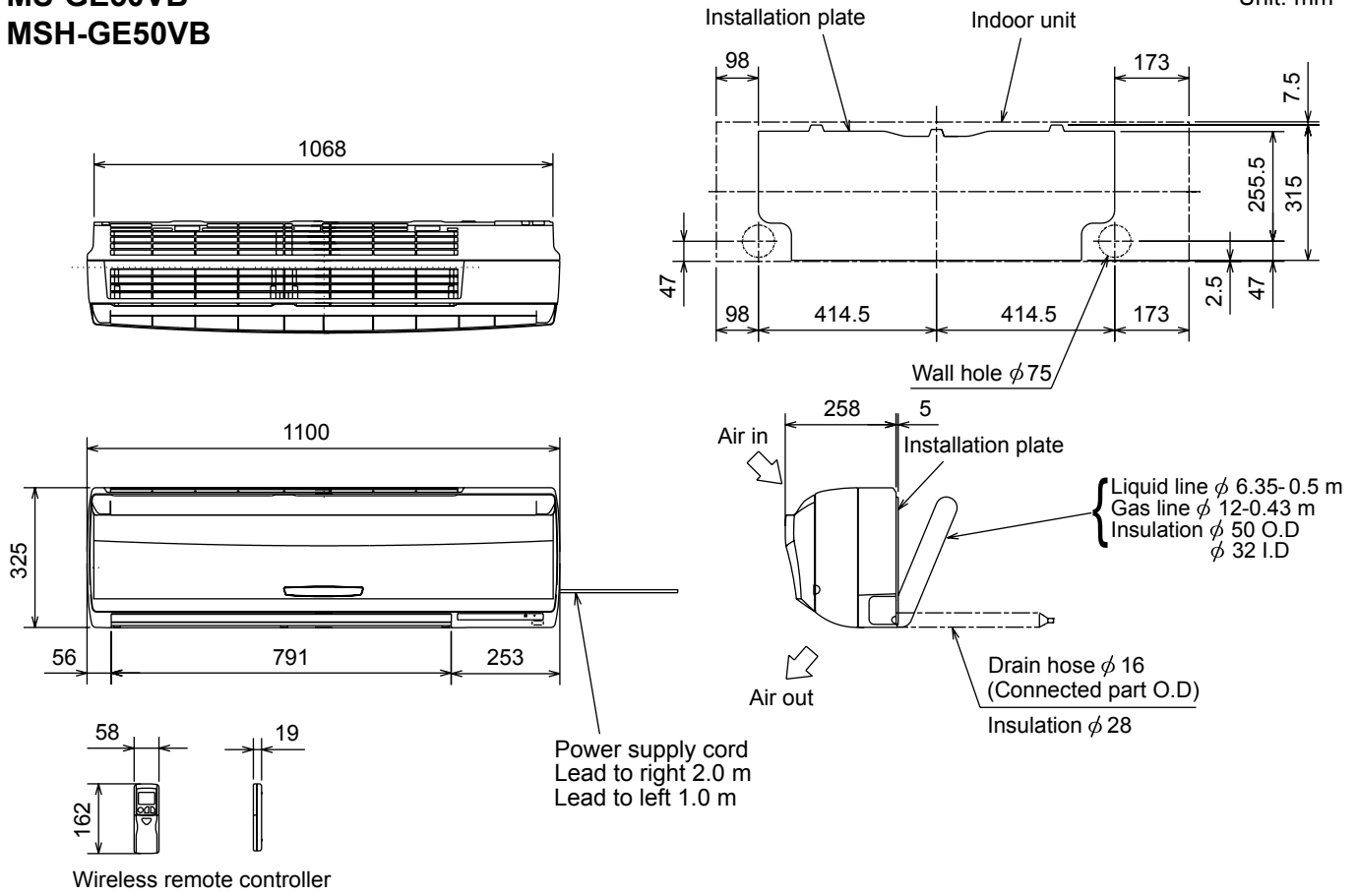

6

WIRING DIAGRAM

MSC-GE20VB MSC-GE25VB MSC-GE35VB

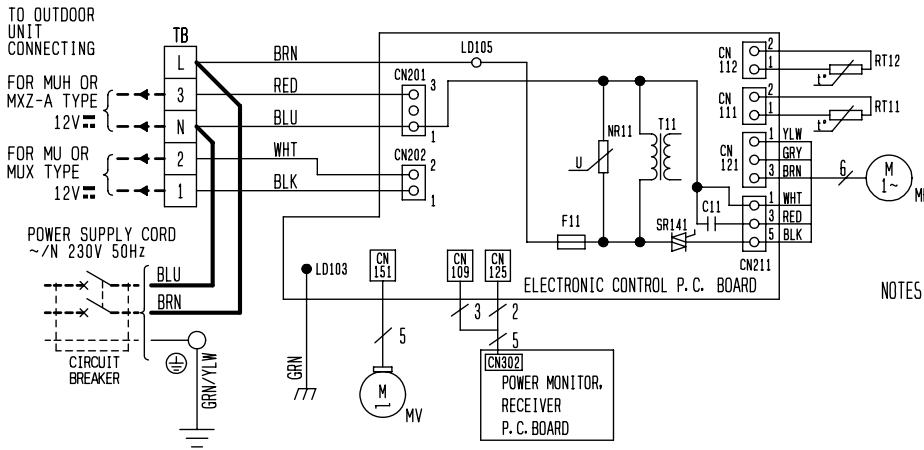

SYMBOL	NAME	SYMBOL	NAME
C11	FAN MOTOR CAPACITOR	RT11	ROOM TEMP. THERMISTOR
F11	FUSE (T3.15A/250V)	RT12	COIL TEMP. THERMISTOR
MF	FAN MOTOR (INNER FUSE)	SR141	SOLID STATE RELAY
MV	VANE MOTOR	TB	TERMINAL BLOCK
NR11	VARIATOR	T11	TRANSFORMER

- NOTES
- About the outdoor side electric wiring refer to the outdoor unit electric wiring diagram for servicing.
 - Use copper conductors only. (For field wiring)
 - Symbols below indicate.
 : Terminal block
 : Connector

MS-GE50VB

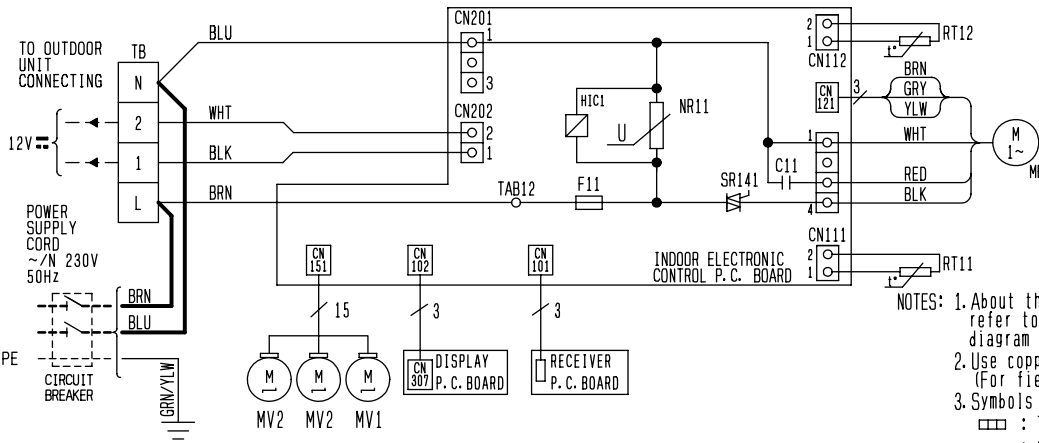

SYMBOL	NAME	SYMBOL	NAME
C11	FAN MOTOR CAPACITOR	NR11	VARIATOR
F11	FUSE (T3.15A/250V)	RT11	ROOM TEMP. THERMISTOR
HIC1	DC/DC CONVERTER	RT12	COIL TEMP. THERMISTOR
MF	FAN MOTOR (INNER FUSE)	SR141	SOLID STATE RELAY
MV1	VANE MOTOR (HORIZONTAL)	TB	TERMINAL BLOCK
MV2	VANE MOTOR (VERTICAL)		

- NOTES
- About the outdoor side electric wiring refer to the outdoor unit electric wiring diagram for servicing.
 - Use copper conductors only. (For field wiring)
 - Symbols below indicate.
 : Terminal block
 : Connector

MSH-GE50VB

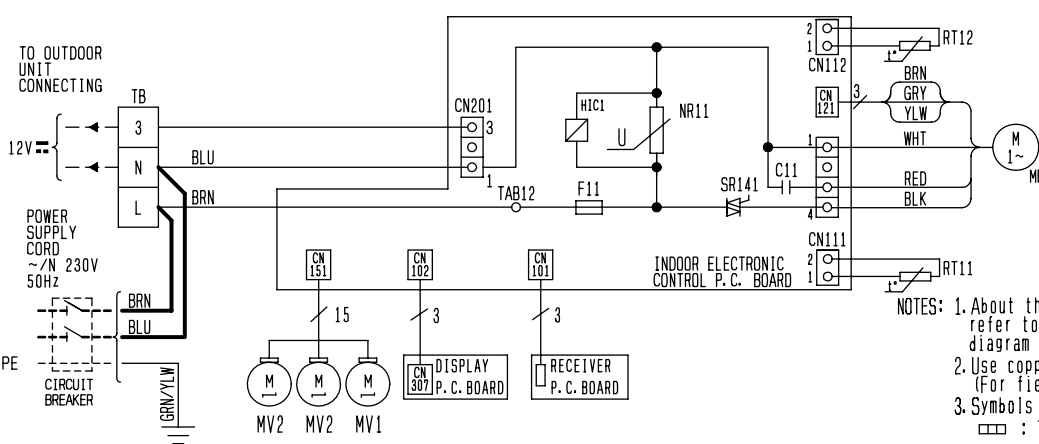

SYMBOL	NAME	SYMBOL	NAME
C11	FAN MOTOR CAPACITOR	NR11	VARIATOR
F11	FUSE (T3.15A/250V)	RT11	ROOM TEMP. THERMISTOR
HIC1	DC/DC CONVERTER	RT12	COIL TEMP. THERMISTOR
MF	FAN MOTOR (INNER FUSE)	SR141	SOLID STATE RELAY
MV1	VANE MOTOR (HORIZONTAL)	TB	TERMINAL BLOCK
MV2	VANE MOTOR (VERTICAL)		

- NOTES
- About the outdoor side electric wiring refer to the outdoor unit electric wiring diagram for servicing.
 - Use copper conductors only. (For field wiring)
 - Symbols below indicate.
 : Terminal block
 : Connector

MSC-GE20VB MSC-GE25VB MSC-GE35VB

Refrigerant pipe $\phi 9.52$
(with heat insulator)

Unit:mm

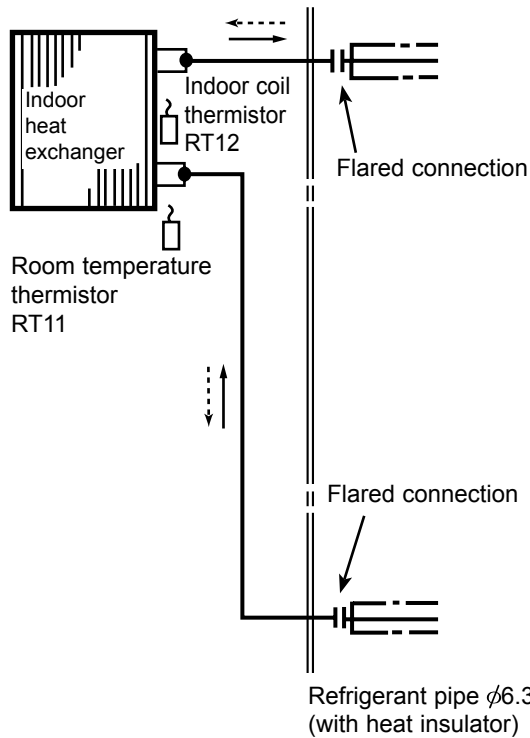

MS-GE50VB MSH-GE50VB

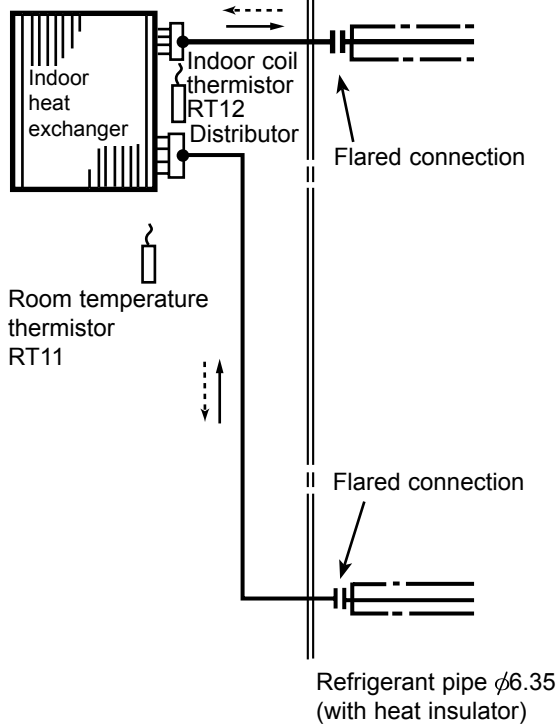
Refrigerant pipe $\phi 12.7$
(with heat insulator)

————→ Refrigerant flow in cooling
 - - - - -> Refrigerant flow in heating (MSC,MSH)

MSC-GE20VB MS-GE50VB
MSC-GE25VB MSH-GE50VB
MSC-GE35VB

8-1. TIMER SHORT MODE

For service, set time can be shortened by short circuit of JPG and JPS on the electronic control P.C. board. (Refer to 10-6.)
 The time will be shortened as follows.

Set time: 1 minute → 1-second

Set time: 3 minute → 3-second (It takes 3 minutes for the compressor to start operation. However, the starting time is shortened by short circuit of JPG and JPS.)

8-2. P.C. BOARD MODIFICATION FOR INDIVIDUAL OPERATION

A maximum of 4 indoor units with wireless remote controllers can be used in a room.

In this case, to operate each indoor unit individually by each remote controller, P.C. boards of remote controller must be modified according to the number of the indoor unit.

How to modify the remote controller P.C. board

Remove batteries before modification.

The board has a print as shown below:

NOTE: For modification, take out the batteries and press the OPERATE/STOP (ON/OFF) button 2 or 3 times at first.
 After modification, put back the batteries then press the RESET button.

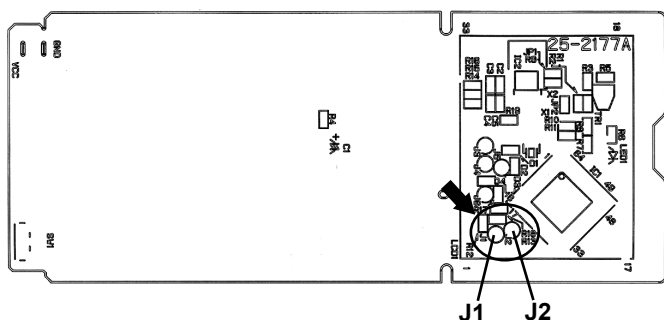

The P.C. board has the print "J1" and "J2". Solder "J1" and "J2" according to the number of indoor unit as shown in Table 1.
 After modification, press the RESET button.

Table 1

	1 unit operation	2 units operation	3 units operation	4 units operation
No. 1 unit	No modification	Same as at left	Same as at left	Same as at left
No. 2 unit	—	Solder J1	Same as at left	Same as at left
No. 3 unit	—	—	Solder J2	Same as at left
No. 4 unit	—	—	—	Solder both J1 and J2

How to set the remote controller exclusively for particular indoor unit

After you turn the breaker ON, the first remote controller that sends the signal to the indoor unit will be regarded as the remote controller for the indoor unit.

The indoor unit will only accept the signal from the remote controller that has been assigned to the indoor unit once they are set. The setting will be cancelled if the breaker has turned off, or the power supply has shut down.



Please conduct the above setting once again after the power has restored.

8-3. REMOTE CONTROLLER (How to set the type) MSC-GE

This remote controller setting needs to be switched according to the type of air conditioner (COOL & HEAT or COOL ONLY).

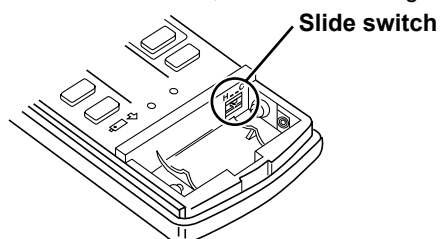
If the setting is incorrect, the air conditioner does not operate normally. Therefore, check if the setting corresponds to the type of-air conditioner. If not, correct the setting as shown below.



Type	COOL & HEAT	COOL ONLY
The position of the slide switch		

8-4. MU & MUX TYPE/MUH & MXZ TYPE SWITCH OVER AND AUTO RESTART FUNCTION

1. MU & MUX TYPE/MUH & MXZ TYPE SWITCH OVER <MSC-GE20VB MSC-GE25VB MSC-GE35VB>

The indoor units for MU & MUX type and MUH & MXZ type are common specifications. Set switch according to the type of outdoor unit. The units are set for MUH & MXZ type when they are shipped from the factory.

How to switch over MU & MUX TYPE/MUH & MXZ TYPE

- (1) Turn OFF the main power for the unit.
- (2) Pull out the electronic control P.C. board, and change switch (SW2-②) on the indoor electronic control P.C. board according to the type of outdoor unit as following figures. (Refer to 10-6.)

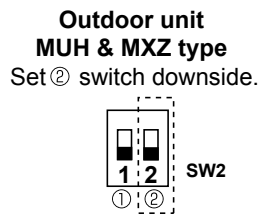
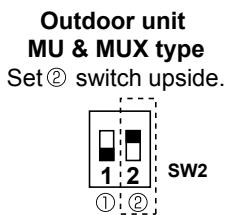

SW2-① sets the AUTO RESTART FUNCTION ON/OFF.
SW2-② switches over the MU & MUX type/MUH & MXZ type.

When the units are shipped from the factory, SW2 is as follows.
SW2-① AUTO RESTART FUNCTION ON
SW2-② MUH & MXZ type

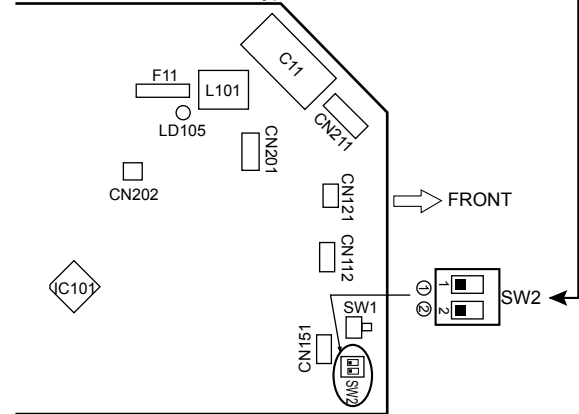

<MSC-GE20VB MSC-GE25VB MSC-GE35VB>

- NOTE:**
- If the indoor-outdoor connecting wire is incorrectly connected on the terminal block, the unit does not operate normally.
 - If the earth is incorrect, it may cause an electric shock.

2. AUTO RESTART FUNCTION

When the indoor unit is controlled with the remote controller, the operation mode, set temperature, and the fan speed are memorized by the indoor electronic control P.C. board. "AUTO RESTART FUNCTION" automatically starts operation in the same mode just before the shutoff of the main power. However if the unit is operated in "I FEEL CONTROL" mode before power failure, the operation is not memorized. In "I FEEL CONTROL" mode, the operation is decided by the initial room temperature.

Operation

- ① If the main power has been cut, the operation settings remain.
- ② After the power is restored, the unit restarts automatically according to the memory. (However, it takes at least 3 minutes for the compressor to start running.)

How to disable "AUTO RESTART FUNCTION"

**MSC-GE20VB
MSC-GE25VB
MSC-GE35VB**

- (1) Turn OFF the main power for the unit.
- (2) Pull out the electronic control P.C. board, and change switch (SW2-①) on the indoor electronic control P.C. board as following figures. (Refer to 10-6.)

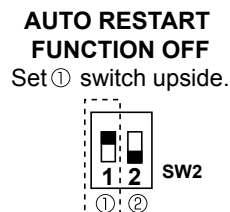
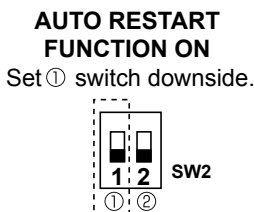

MS-GE50VB
MSH-GE50VB

- (1) Turn OFF the main power for the unit.
- (2) Solder jumper wire to JR07 on the indoor electronic control P.C. board. (Refer to 10-6.)

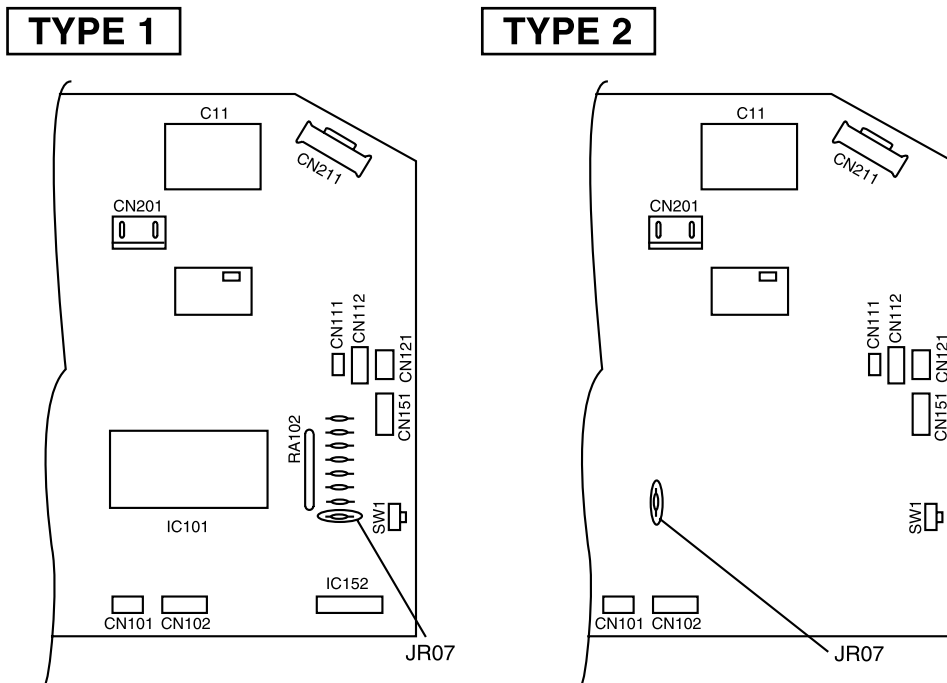

<MS-GE50VB MSH-GE50VB>

NOTE:

- The operation settings are memorized when 10 seconds have passed after the indoor unit was operated with the remote controller.
- If main power is turned OFF or a power failure occurs while AUTO START/STOP timer is active, the timer setting is cancelled.
- If the unit has been OFF with the remote controller before power failure, the auto restart function does not work as the power button of the remote controller is OFF.
- To prevent breaker OFF due to the rush of starting current, systematize other home appliances not to turn ON at the same time.
- When some air conditioners are connected to the same supply system, if they are operated before power failure, the starting current of all the compressors may flow simultaneously at restart. Therefore, the special counter-measures are required to prevent the main voltage-drop or the rush of the starting current by adding to the system that allows the units to start one by one.

WIRELESS REMOTE CONTROLLER

MSC-GE20VB MSC-GE25VB MSC-GE35VB

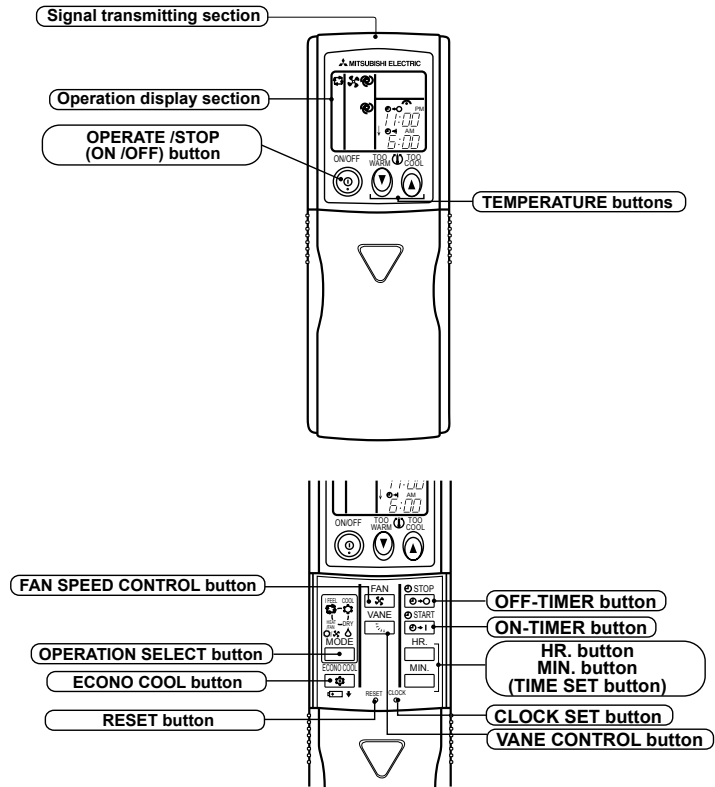

MS-GE50VB

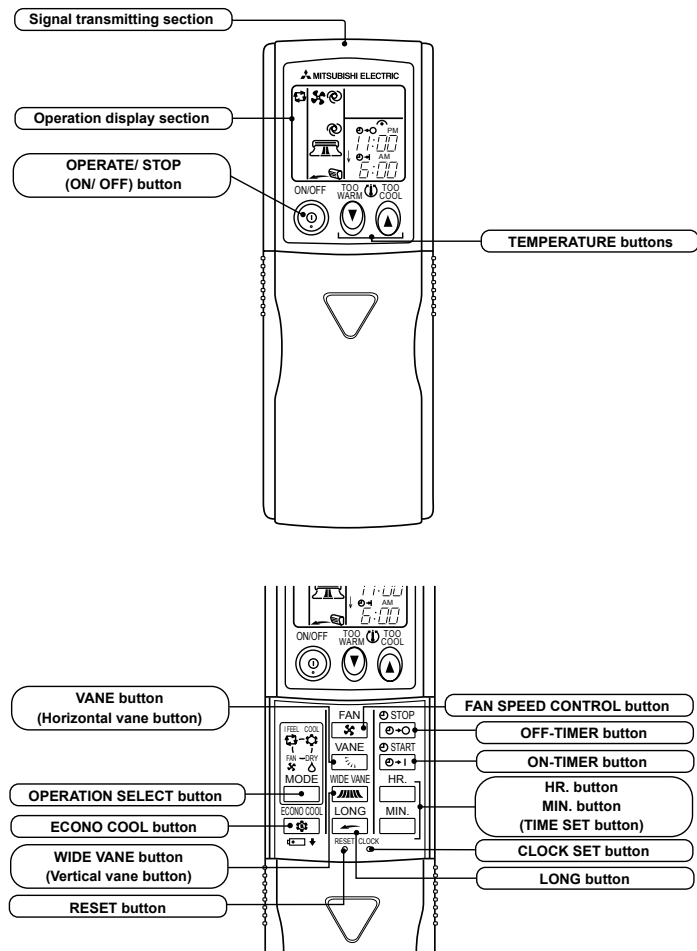

MSH-GE50VB

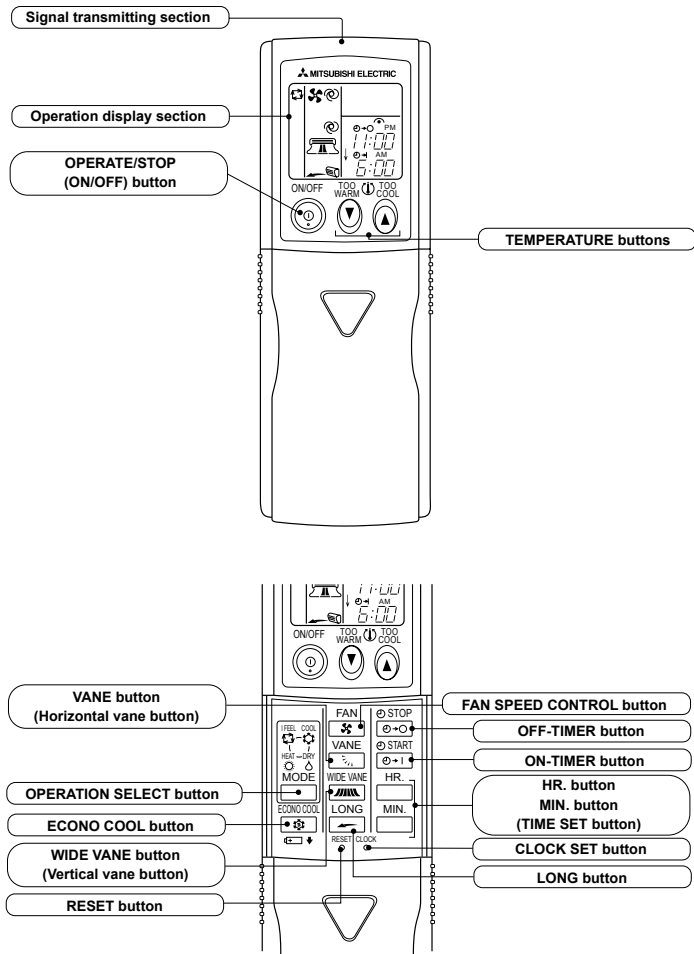

NOTE:

- The last setting will be stored after the unit is turned OFF with the remote controller.
- Indoor unit receives the signal of the remote controller with beeps.

INDOOR UNIT DISPLAY SECTION

OPERATION INDICATOR lamp

The OPERATION INDICATOR at the right side of the indoor unit indicates the operation state.

- The following indication applies regardless of shape of the indicator.

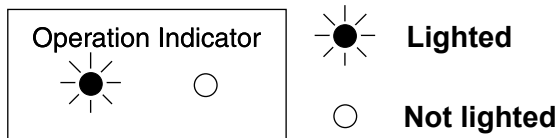

Indication	Operation state	Difference between target temperature and room temperature
	This shows that the air conditioner is operating to reach the target temperature. Please wait until the target temperature is obtained.	Approx. 2 °C or more
	This shows that the room temperature is approaching the target temperature.	Approx. 2 °C or less

9-1. COOL (❄️) OPERATION

- (1) Press OPERATE/STOP (ON/OFF) button.
OPERATION INDICATOR lamp of the indoor unit turns ON with a beep tone.
- (2) Select COOL mode with OPERATION SELECT button.
- (3) Press TEMPERATURE buttons.
(TOO WARM or TOO COOL button) to select the desired temperature.
The setting range is 16 ~ 31°C.
* Indoor fan continues to operate regardless of thermostat's OFF-ON at set speed.

1. Coil frost prevention

When the temperature of indoor heat exchanger becomes too low, the coil frost prevention mode works.
The indoor fan operates at the set speed and the compressor stops. This mode continues until the temperature of indoor heat exchanger rises.

9-2. DRY (☀️) OPERATION

- (1) Press OPERATE/STOP (ON/OFF) button.
OPERATION INDICATOR lamp of the indoor unit turns ON with a beep tone.
- (2) Select DRY mode with OPERATION SELECT button.
- (3) The set temperature is determined from the initial room temperature.
- (4) DRY operation will not function when the room temperature is 13°C or below.

1. Indoor fan speed control

Indoor fan operates at the set speed by FAN SPEED CONTROL button.
However, in AUTO fan operation, fan speed becomes Low.

2. The operation of the compressor and indoor/outdoor fan <MU,MUX,MUH>

Compressor operates by room temperature control and time control.
Indoor fan and outdoor fan operate in the same cycle as the compressor.

3. Coil frost prevention

- The operation is as same as coil frost prevention during COOL mode.
However, when the coil frost prevention works while the indoor fan is OFF, the indoor fan speed becomes set speed.

9-3. FAN (🌀) OPERATION <MU/MUX>

- (1) Press OPERATE/STOP (ON/OFF) button. OPERATION INDICATOR lamp of the indoor unit turns ON with a beep tone.
- (2) Select FAN mode with OPERATION SELECT button.
- (3) Select the desired fan speed. When AUTO, it becomes Low.
Only indoor fan operates.
Outdoor unit does not operate.

9-4. HEAT (🔥) OPERATION <MUH>

- (1) Press OPERATE/STOP (ON/OFF) button.
OPERATION INDICATOR lamp of the indoor unit turns ON with a beep tone.
- (2) Select HEAT mode with OPERATION SELECT button.
- (3) Press TEMPERATURE buttons (TOO WARM or TOO COOL button) to select the desired temperature.
The setting range is 16 ~ 31°C.

1. Cold air prevention control

When the compressor is not operating or is starting, and the temperature of indoor heat exchanger and/or the room temperature is low or when defrosting is being done, the indoor fan will stop or rotate in Very Low speed.

2. Defrosting

Defrosting starts when the temperature of outdoor heat exchanger becomes too low.
The compressor stops once, the indoor/outdoor fans stop, the 4-way valve reverses, and the compressor re-starts.
This mode continues until the temperature of outdoor heat exchanger rises or the fixed time passes.

9-5. "I FEEL CONTROL" (☐) OPERATION

- (1) Press OPERATE/STOP (ON/OFF) button on the remote controller.
OPERATION INDICATOR lamp of the indoor unit turns ON with a beep tone.
- (2) Select "I FEEL CONTROL" mode with OPERATION SELECT button.
- (3) The operation mode is determined by the room temperature at start-up of the operation.

Initial room temperature	Mode
25°C or more	COOL mode of "I FEEL CONTROL"
23°C to 25°C	DRY mode of "I FEEL CONTROL"
<MUH> Less than 23°C	HEAT mode of "I FEEL CONTROL"

- Once the mode is fixed, the mode does not change by room temperature afterwards.
- Under ON-TIMER (⊖→|) operation, mode is determined as follows.

When the system is stopped on the remote controller, and restarted within 2 hours in "I FEEL CONTROL" (□) mode, the system operates in previous mode automatically regardless of the room temperature.

Operation time chart

Example

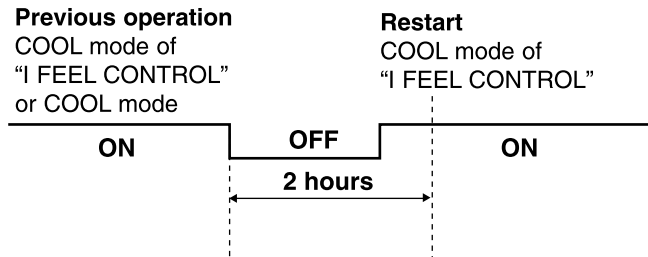

When the system is restarted after 2 hours and more, the operation mode is determined by the room temperature at start-up of the operation.

Operation time chart

Example

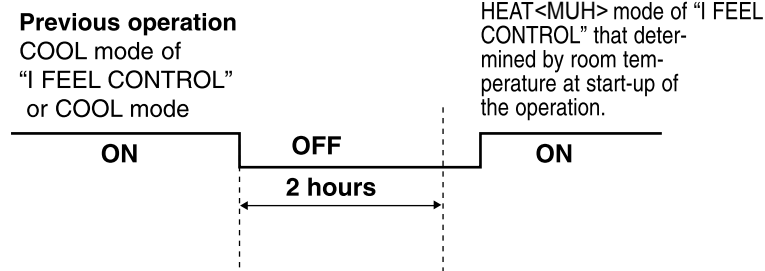

(4) The initial set temperature is decided by the initial room temperature.

Model	Initial room temperature	Initial set temperature	
COOL mode of "I FEEL CONTROL"	26°C or more	24°C	*1
	25°C to 26°C	Initial room temperature minus 2°C	
DRY mode of "I FEEL CONTROL"	23°C to 25°C	Initial room temperature minus 2°C	
<MUH> HEAT mode of "I FEEL CONTROL"	Less than 23°C	26°C	

*1 When the system is restarted with the remote controller, the system operates with the previous set temperature regardless of room temperature at restart.

The set temperature is calculated by the previous set temperature.

(5) TEMPERATURE buttons

In "I FEEL CONTROL" (□) mode, set temperature is decided by the microprocessor based on the room temperature. In addition, set temperature can be controlled by TOO WARM or TOO COOL buttons when you feel too cool or too warm. Each time TOO WARM or TOO COOL button is pressed, the indoor unit receives the signal and emits a beep tone.

• Fuzzy control

When TOO COOL or TOO WARM button is pressed, the microprocessor changes the set temperature, considering the room temperature, the frequency of pressing TOO COOL or TOO WARM button and the user's preference to heat or cool. So this is called "Fuzzy control", and works only in "I FEEL CONTROL" mode.

In DRY mode of "I FEEL CONTROL", the set temperature doesn't change.



...To raise the set temperature 1~2°C



...To lower the set temperature 1~2°C

9-6. AUTO VANE OPERATION

1. Horizontal vane

(1) Vane motor drive

These models are equipped with a stepping motor for the horizontal vane. The rotating direction, speed, and angle of the motor are controlled by pulse signals (approximate 12V) transmitted from indoor microprocessor.

(2) The horizontal vane angle and mode change as follows by pressing the VANE CONTROL or VANE button.

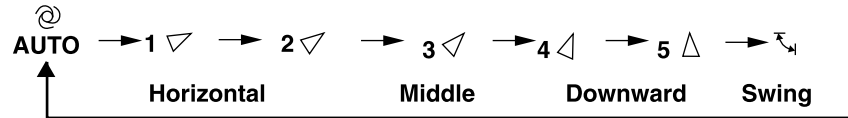

(3) Positioning

To confirm the standard position, the vane moves until it touches the vane stopper. Then the vane is set to the desired angle. Confirming of standard position is performed in the following case:

- When the power supply turns ON.
- When the operation starts or finishes (including timer operation).
- When the test run starts.
- When the vane control is changed AUTO to MANUAL (except SWING).
- When SWING is finished (including ECONO COOL).
- When multi-standby starts or finishes.

(4) VANE AUTO (Ⓐ) mode

In VANE AUTO mode, the microprocessor automatically determines the horizontal vane angle and operation to make the optimum room-temperature distribution.

① In COOL and DRY operation

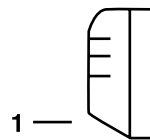

Vane angle is fixed to Angle 1.

② In FAN operation <MU,MUX> In HEAT operation <MUH>

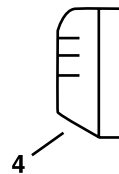

Vane angle is fixed to Angle 4.

(5) STOP (operation OFF) and ON-TIMER standby

When the following cases occur, the horizontal vane returns to the closed position.

- When OPERATE/STOP (ON/OFF) button is pressed (POWER OFF).
- When the operation is stopped by the emergency operation.
- When ON-TIMER is on standby.

(6) Dew prevention

During COOL or DRY operation at Vane Angle 4 or 5 when the compressor cumulative operation time of compressor exceeds 1 hour, the vane angle automatically changes to Angle 1 for dew prevention.

(7) SWING mode (⌘)

By selecting SWING mode with VANE CONTROL or VANE button, the horizontal vane swings vertically.

The remote controller displays “⌘”.

SWING mode is cancelled when VANE CONTROL or VANE button is pressed once again.

(8) Cold air prevention in HEAT operation <MUH>

The horizontal vane position is set to Upward.

(9) ECONO COOL () operation (ECONOmical operation)

When ECONO COOL button is pressed in COOL mode, set temperature is automatically set 2 C higher.

Also the horizontal vane swings in various cycles.

SWING operation makes you feel cooler than set temperature. So, even though the set temperature is higher, the air conditioner can keep comfort. As a result, energy can be saved.

To cancel this operation, select a different mode or press one of the following buttons in ECONO COOL operation: ECONO COOL, VANE CONTROL, VANE or LONG button.

(10) LONG mode () <MS-GE50 / MSH-GE50>

By pressing LONG button indoor fan speed becomes faster than setting fan speed on the remote controller, and the horizontal vane moves to the position for LONG mode. The remote controller displays “ ”.

To cancel this operation, press one of the following buttons:

ECONO COOL button in COOL mode, VANE or LONG button.

- In the following example, the vertical vane is set to (front.).

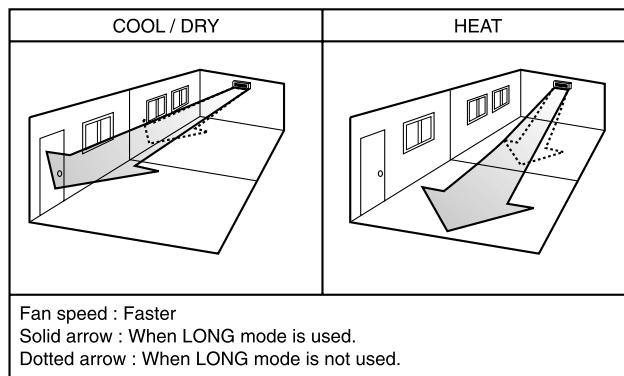

2. Vertical vane <MS-GE50 / MSH-GE50>

(1) Vane motor drive

These models are equipped with a stepping motor for the vertical vane. The rotating direction, speed, and angle of the motor are controlled by pulse signals (approximate 12V) transmitted from microprocessor.

(2) The vertical vane angle and mode change as follows by pressing the WIDE VANE button.

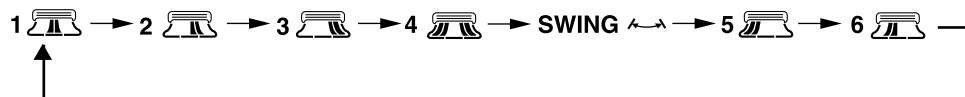

(3) Positioning

To confirm the standard position, the vane moves until it touches the vane stopper. Then the vane is set to the desired angle.

Confirming of standard position is performed in the following case:

- When OPERATE/STOP(ON/OFF) button is pressed (POWER ON/OFF).
- When SWING is started or finished.
- When the power supply turns ON.

(4) SWING mode ()

By selecting SWING mode with WIDE VANE button, the vertical vane swings horizontally. The remote controller displays “ ”. The vane moves right and left in the width of Angle 4 repeatedly.

(5) WIDE mode ()

By selecting WIDE mode with WIDE VANE button, indoor fan speed becomes faster than setting fan speed on the remote controller (*). The remote controller displays “ ”.

NOTE : The position of vane angle 3, angle 4 and angle 5 are different in COOL operation and HEAT<MSH>operation.

- * Indoor fan speed becomes faster than setting fan speed on the remote controller even when or is selected.

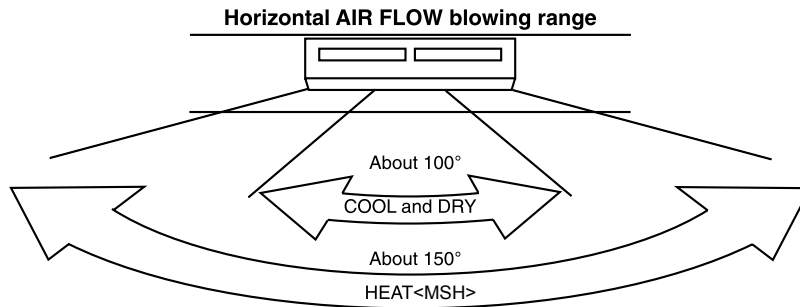

9-7. TIMER OPERATION

1. How to set the timer

- (1) Press OPERATE/STOP (ON/OFF) button to start the air conditioner.
- (2) Check that the current time is set correctly.

NOTE : Timer operation will not work without setting the current time. Initially "AM0:00" blinks at the current time display of TIME MONITOR, so set the current time correctly with CLOCK SET button.

- (3) Press ON/OFF TIMER buttons to select the operation.
 "ON-TIMER" button... AUTO START operation (ON timer)
 "OFF-TIMER" button... AUTO STOP operation (OFF timer)

- (4) Press HR. and MIN. button to set the timer. Time setting is 10-minute units.

HR. and MIN. button will work when "⌚→| " or "⌚→○" mark is flashing.
 These marks disappear in 1 minute.

After setting the ON timer, check that OPERATION INDICATOR lamp of the indoor unit lights.

NOTE1 : Be sure to place the remote controller at the position where its signal can reach the air conditioner even during TIMER operation, or the set time may deviate within the range of about 10 minutes.

NOTE2 : Reset the timer in the following cases, or the set time may deviate and other malfunctions may occur.

- A power failure occurs.
- The circuit breaker functions.

2. Cancel

TIMER setting can be cancelled with the ON/OFF TIMER buttons.

To cancel ON timer, press "ON-TIMER" button.

To cancel OFF timer, press "OFF-TIMER" button.

TIMER is cancelled and the display of set time disappears.

PROGRAM TIMER

- OFF timer and ON timer can be used in combination.
- "↑" and "↓" display shows the order of OFF timer and ON timer operation.

(Example 1) The current time is 8:00 PM.

The unit turns OFF at 11:00 PM, and ON at 6:00 AM.

(Example 2) The current time is 11:00 AM.

The unit turns ON at 5:00 PM, and OFF at 9:00 PM.

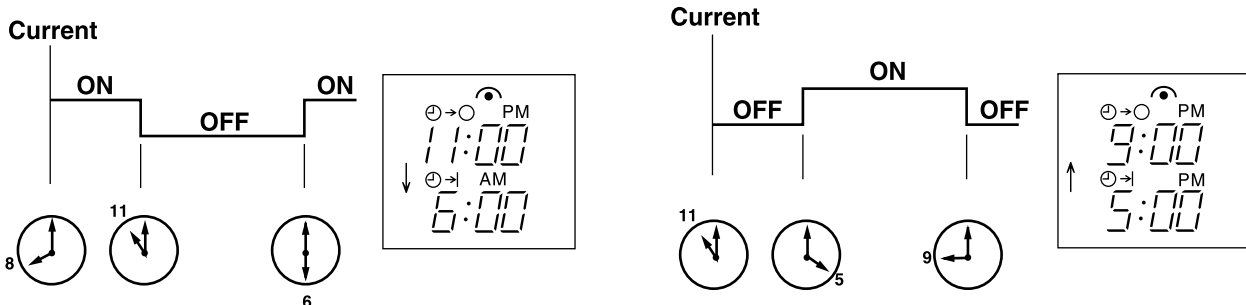

NOTE : TIMER setting will be cancelled by power failure or breaker functioning.



9-8. EMERGENCY/TEST OPERATION

In case of test run operation or emergency operation, use EMERGENCY OPERATION switch on the front of the indoor unit. Emergency operation is available when the remote controller is missing, has failed or the batteries of remote controller run down. The unit will start and OPERATION INDICATOR lamp will light.

The first 30 minutes of operation is the test run operation. This operation is for servicing.

The indoor fan runs at High speed and the temperature control does not work.

After 30 minutes of test run operation, the system shifts to EMERGENCY COOL/(HEAT MODE <MUH>) with a set temperature of 24 °C.

The fan speed shifts to Med. speed.

The coil frost prevention works even in the test run or the emergency operation,(and defrosting also <MUH>).









In the test run or emergency operation, the horizontal vane operates in VANE AUTO (@) mode.

Emergency operation continues until EMERGENCY OPERATION switch is pressed once (or twice <MUH>) or the unit receives any signal from the remote controller. In case of latter, normal operation will start.

NOTE : Do not press EMERGENCY OPERATION switch during normal operation.

- The following indication applies regardless of shape of the indicator.

OPERATION INDICATOR lamp

	Press once	<Cool>			 Lighted  Not Lighted
	Press again	<Heat>			
	Press once again	<Stop>			

*Heat is a vailable only in MUH.

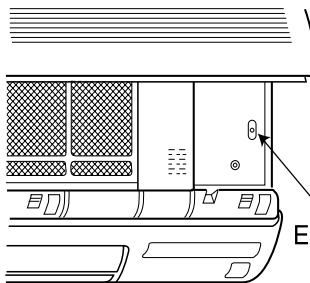

EMERGENCY OPERATION switch

9-9. 3-MINUTE TIME DELAY OPERATION

When the system turns OFF, compressor will not restart for 3 minutes as 3-minute time delay function operates to protect compressor form overload.

MSC-GE20VB MS-GE50VB
MSC-GE25VB MSH-GE50VB
MSC-GE35VB

10-1. CAUTIONS ON TROUBLESHOOTING

1. Before troubleshooting, check the following:

- (1) Check the power supply voltage.
- (2) Check the indoor/outdoor connecting wire for mis-wiring.

2. Take care the following during servicing.

- (1) Before servicing the air conditioner, be sure to turn OFF the main unit first with the remote controller, and after confirming the horizontal vane is closed, turn OFF the breaker and/or disconnect the power plug.
- (2) Be sure to turn OFF the power supply before removing the front panel, the cabinet, the top panel, and the electronic control P.C. board.
- (3) When removing the electronic control P.C. board, hold the edge of the board with care NOT to apply stress on the components.
- (4) When connecting or disconnecting the connectors, hold the housing of the connector. DO NOT pull the lead wires.

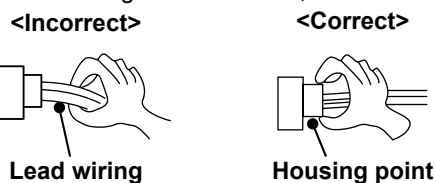

3. Troubleshooting procedure

- (1) First, check if the OPERATION INDICATOR lamp on the indoor unit is flashing ON and OFF to indicate an abnormality. To make sure, check how many times the OPERATION INDICATOR lamp is flashing ON and OFF before starting service work.
- (2) Before servicing, check that the connector and terminal are connected properly.
- (3) When the electronic control P.C. board seems to be defective, check the copper foil pattern for disconnection and the components for bursting and discoloration.
- (4) When troubleshooting, refer to 10-2. and 10-3.

4. How to replace batteries

Weak batteries may cause the remote controller malfunction.

In this case, replace the batteries to operate the remote controller normally.

- ① Remove the front lid and insert batteries. Then reattach the front lid.

- ② Press RESET button with a thin instrument, and then use the remote controller.

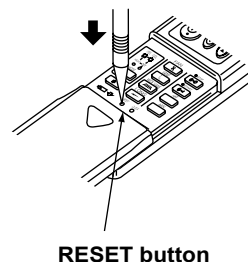
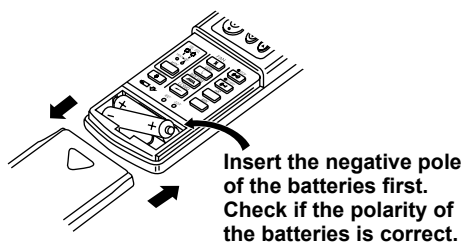

NOTE1: If the RESET button is not pressed, the remote controller may not operate correctly.

NOTE2 : INFORMATION FOR MULTI SYSTEM AIR CONDITIONER (OUTDOOR UNIT : MXZ type)

Multi system air conditioner can connect two or more indoor units with one outdoor unit.

According to the capacity, two or more units can operate simultaneously.

- When you try to operate two or more indoor units with one outdoor unit simultaneously, one for the cooling and the other for heating, the operation mode of the indoor unit that operates earlier is selected. The other indoor units cannot operate, indicating as shown in the figure below. In this case, please set all the indoor units to the same operation mode.

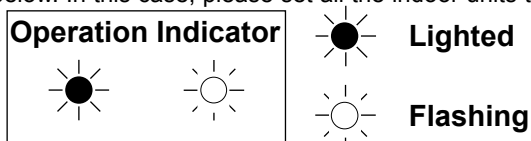

- When indoor units start the operation while the defrosting of outdoor unit is being done, it takes a few minutes (max. 10 minutes) to blow out the warm air.
- In the heating operation, though indoor unit that does not operate may get warm or the sound of refrigerant flowing may be heard, they are not malfunction. The reason is that the refrigerant continuously flows into it.

NOTE3 : This remote controller has a circuit to automatically reset the microcomputer when batteries are replaced.

This function is equipped to prevent the microcomputer from malfunctioning due to the voltage drop caused by the battery replacement.

NOTE4 : Do not use the leaking batteries.

10-2. INSTRUCTION OF TROUBLESHOOTING

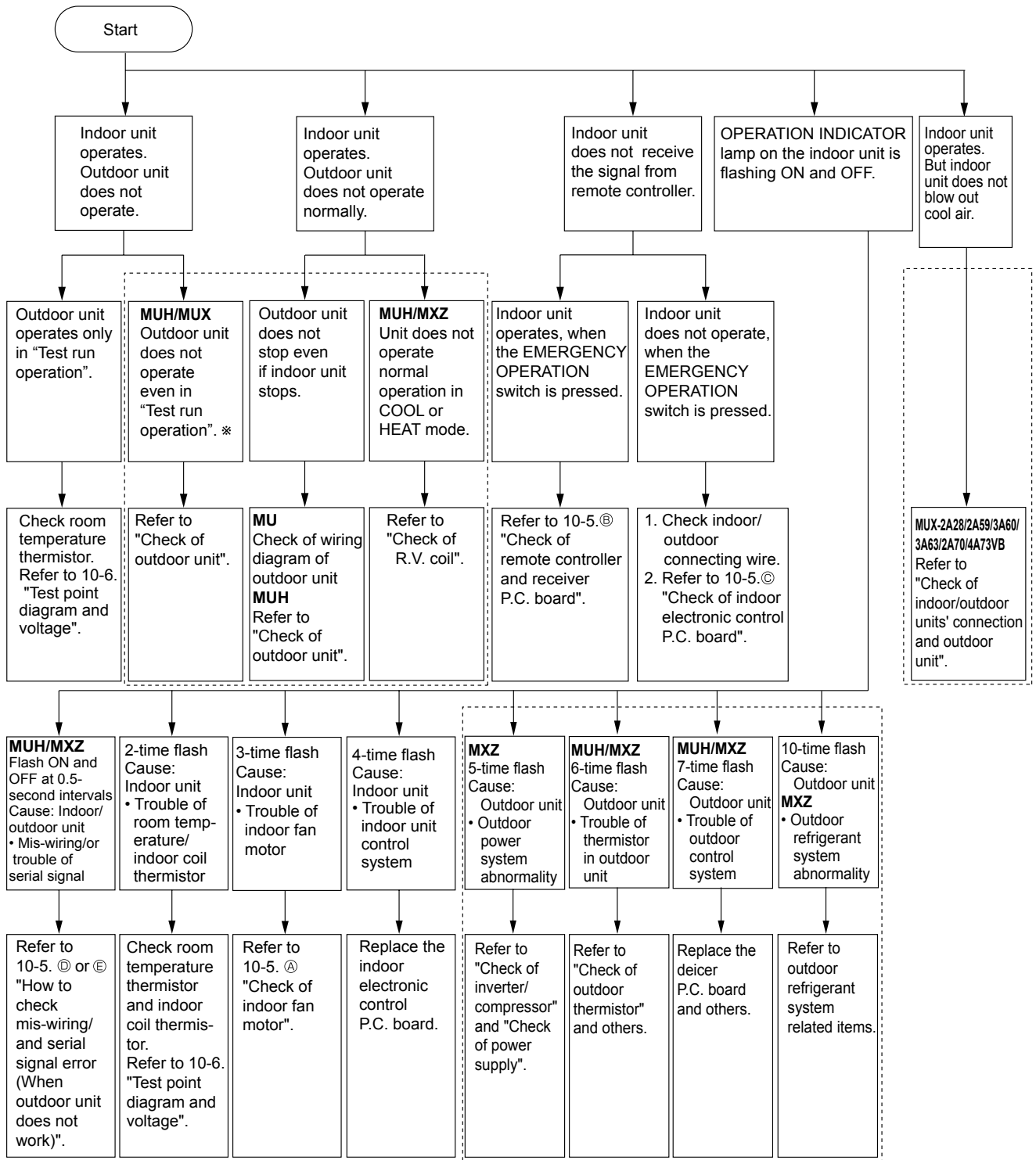

*1.<The case of the trouble of the serial signal>

When the power is turned off and turned on again, the indication shows "the trouble of mis-wiring".

*2."Test run operation" means the operation within 30 minutes after EMERGENCY OPERATION switch is pressed.

⋯ Refer to outdoor unit service manual.

10-3. TROUBLESHOOTING CHECK TABLE

- Before taking measures, make sure that the symptom reappears for accurate troubleshooting.
- When the indoor unit has started operation and the following detection method has detected an abnormality (the first detection after the power ON), the indoor electronic control P.C. board turns OFF the indoor fan motor with the OPERATION INDICATOR lamp flashing.

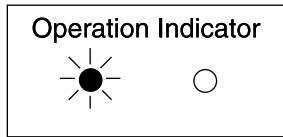

Lighted



Not lighted

• Flashing of the OPERATION INDICATOR lamp (the left-hand side lamp) indicates possible abnormalities.

No.	Abnormal point	Operation indicator lamp	Symptom	Condition	Remedy
1	MUH-GA/ MXZ Mis-wiring/ or Serial signal	0.5-second ON ●○●○●○●○ 0.5-second OFF	Outdoor unit does not run.	Serial signal from outdoor unit stops for 4 to 5 seconds.	<ul style="list-style-type: none"> • Check switch SW2-②.(MU & MUX type or MUH & MXZ type) • Check wiring (visual check and conductivity check). • Check indoor electronic control P.C.board. • Check outdoor DEICER P.C. board and others. • Check electrical parts.
	MUH-GE Mis-Wiring	0.5-second ON ●○●○●○●○ 0.5-second OFF	Outdoor unit does not operate.	3 minutes after power supply turns ON, serial signal is not received.	<ul style="list-style-type: none"> • Refer to 10-5. ⑥ "How to check mis-wiring".
2	Indoor coil thermistor	2-time flash ●○●○●○●○●○●○ 2.5-second OFF	Outdoor unit does not operate.	Indoor coil/room temperature thermistor detects short or open circuit every 8 seconds during operation.	<ul style="list-style-type: none"> • Refer to the characteristics of indoor coil thermistor, and room temperature thermistor on 10-6.
	Room temperature thermistor				
3	Indoor fan motor	3-time flash ●○●○●○●○●○●○●○ 2.5-second OFF	Indoor fan repeats 12 seconds ON and 3minutes OFF. When the indoor fan breaks, the fan keeps stopping.	The rotational frequency feedback signal is not emitted for 12 seconds after indoor fan motor is operated.	<ul style="list-style-type: none"> • Refer to 10-5. ④ "Check of indoor fan motor".
4	Indoor control system	4-time flash ●○●○●○●○●○●○●○●○ 2.5-second OFF	Outdoor unit does not operate.	It cannot properly read data in the nonvolatile memory of the indoor electronic control P.C. board.	<ul style="list-style-type: none"> • Check the indoor electronic control P.C. board.
5	MXZ Outdoor power system	5-time flash ●○●○●○●○●○●○●○●○ 2.5-second OFF	Outdoor unit does not run.	The compressor operation is continuously three times interrupted by over current protection within 1 minute after start-up, it stops operation.	<ul style="list-style-type: none"> • Check the inverter output. • Check the compressor.
6	MUH/ MXZ Outdoor thermistor	6-time flash ●○●○●○●○●○●○●○●○ 2.5-second OFF	Outdoor unit does not operate.	<Thermistor short> Thermistors are abnormal when they short after compressor start-up.	<ul style="list-style-type: none"> • Shortage of refrigerant • Check the deicer P.C. board and others. Refer to "Check of outdoor thermistor". Refer to outdoor service manual.
				<Thermistor open> Thermistors are abnormal when they open after compressor start-up. However, discharge temperature thermistor is abnormal when open circuit is detected more than 10 minutes after compressor start-up.	
7	MUH/ MXZ Outdoor control system	7-time flash ●○●○●○●○●○●○●○●○●○ 2.5-second OFF	Outdoor unit does not operate.	It cannot properly read data in the nonvolatile memory of the outdoor P.C. board.	<ul style="list-style-type: none"> • Check the deicer P.C. board and others. Refer to outdoor service manual.
8	MXZ Outdoor refrigerant system error	10-time flash ●○●○●○●○●○●○●○●○●○ 2.5-second OFF	Outdoor unit does not run.	The compressor operation has been interrupted by LEV protection continuously 5 minutes, the compressor stops operation.	<ul style="list-style-type: none"> • Refer to "Check of LEV". • Check refrigerant circuit and refrigerant amount. • Check outdoor electronic control P.C. board. Refer to outdoor unit service manual.
9	MXZ Operation mode setting	Operation Indicator ●○●○●○●○●○●○ Lighted Flashing 2.5-second OFF	Outdoor unit operates but indoor unit does not run.	The operation mode of each indoor unit is differently set to COOL(includes DRY) and HEAT at same time, the operation mode of indoor unit that has operated at first has the priority.	<ul style="list-style-type: none"> • Unify the operation mode.

10-4. TROUBLE CRITERION OF MAIN PARTS

MSC-GE20VB MS-GE50VB
MSC-GE25VB MSH-GE50VB
MSC-GE35VB

Part name	Check method and criterion	Figure													
Room temperature thermistor (RT11)	Measure the resistance with a tester. (Part temperature 10°C ~ 30°C)														
Indoor coil thermistor (RT12)	Refer to 10-6. "Test point diagram and voltage", "Indoor electronic control P.C. board", for the chart of thermistor.														
Indoor fan motor (MF) MSC-GE20/25/35VB INNER FUSE 145°C CUT OFF MS-GE50VB MSH-GE50VB INNER FUSE 140°C CUT OFF	Measure the resistance between the terminals with a tester. (Part temperature 10°C ~ 30°C)														
	<table border="1"> <thead> <tr> <th rowspan="2">Color of lead wire</th> <th colspan="3">Normal</th> </tr> <tr> <th>MSC-GE20/25VB</th> <th>MSC-GE35VB</th> <th>MS-GE50VB MSH-GE50VB</th> </tr> </thead> <tbody> <tr> <td>WHT – BLK</td> <td>271 Ω ~ 295 Ω</td> <td>215 Ω ~ 233 Ω</td> <td>284 Ω ~ 307 Ω</td> </tr> <tr> <td>BLK – RED</td> <td>180 Ω ~ 196 Ω</td> <td>305 Ω ~ 331 Ω</td> <td>142 Ω ~ 154 Ω</td> </tr> </tbody> </table>		Color of lead wire	Normal			MSC-GE20/25VB	MSC-GE35VB	MS-GE50VB MSH-GE50VB	WHT – BLK	271 Ω ~ 295 Ω	215 Ω ~ 233 Ω	284 Ω ~ 307 Ω	BLK – RED	180 Ω ~ 196 Ω
Color of lead wire	Normal														
	MSC-GE20/25VB	MSC-GE35VB	MS-GE50VB MSH-GE50VB												
WHT – BLK	271 Ω ~ 295 Ω	215 Ω ~ 233 Ω	284 Ω ~ 307 Ω												
BLK – RED	180 Ω ~ 196 Ω	305 Ω ~ 331 Ω	142 Ω ~ 154 Ω												
	Measure the voltage power ON.														
	<table border="1"> <thead> <tr> <th>Color of lead wire</th> <th>Normal</th> </tr> </thead> <tbody> <tr> <td>BRN – YLW</td> <td>4.5 ~ 5.5V</td> </tr> <tr> <td>YLW – GRY</td> <td>(When fan revolved one time) 0V → 5V → 0V (Approx.)</td> </tr> </tbody> </table>	Color of lead wire	Normal	BRN – YLW	4.5 ~ 5.5V	YLW – GRY	(When fan revolved one time) 0V → 5V → 0V (Approx.)								
Color of lead wire	Normal														
BRN – YLW	4.5 ~ 5.5V														
YLW – GRY	(When fan revolved one time) 0V → 5V → 0V (Approx.)														
Vane motor (MV) Horizontal vane motor (MV1) Vertical vane motor (MV2)	Measure the resistance between the terminal with a tester. (Part temperature 10°C ~ 30°C)														
	<table border="1"> <thead> <tr> <th colspan="2">Normal</th> </tr> </thead> <tbody> <tr> <td>MSC-GE20/25/35VB</td> <td>MS-GE50VB MSH-GE50VB</td> </tr> <tr> <td>240 Ω ~ 260 Ω</td> <td>283 Ω ~ 306 Ω</td> </tr> </tbody> </table>	Normal		MSC-GE20/25/35VB	MS-GE50VB MSH-GE50VB	240 Ω ~ 260 Ω	283 Ω ~ 306 Ω								
Normal															
MSC-GE20/25/35VB	MS-GE50VB MSH-GE50VB														
240 Ω ~ 260 Ω	283 Ω ~ 306 Ω														

10-5. TROUBLESHOOTING FLOW

When OPERATION INDICATOR lamp flashes 3-time. Indoor fan motor does not operate.

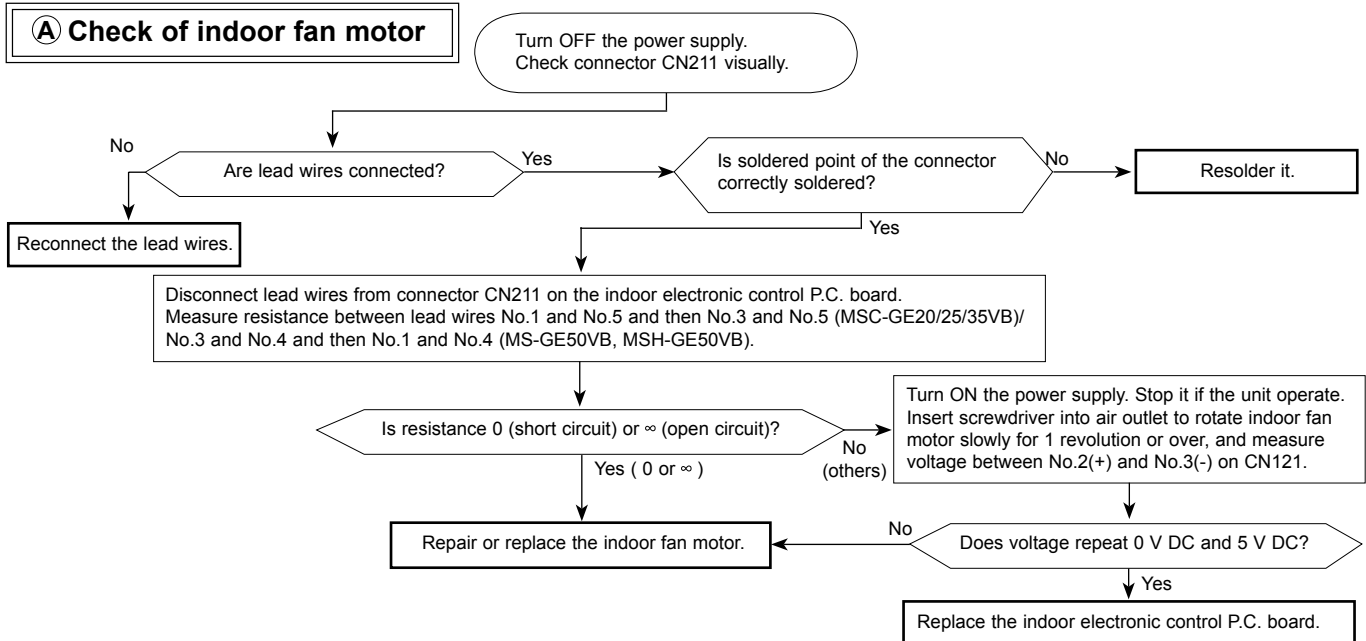

Indoor unit operates by pressing the EMERGENCY OPERATION switch, but does not operate with the remote controller.

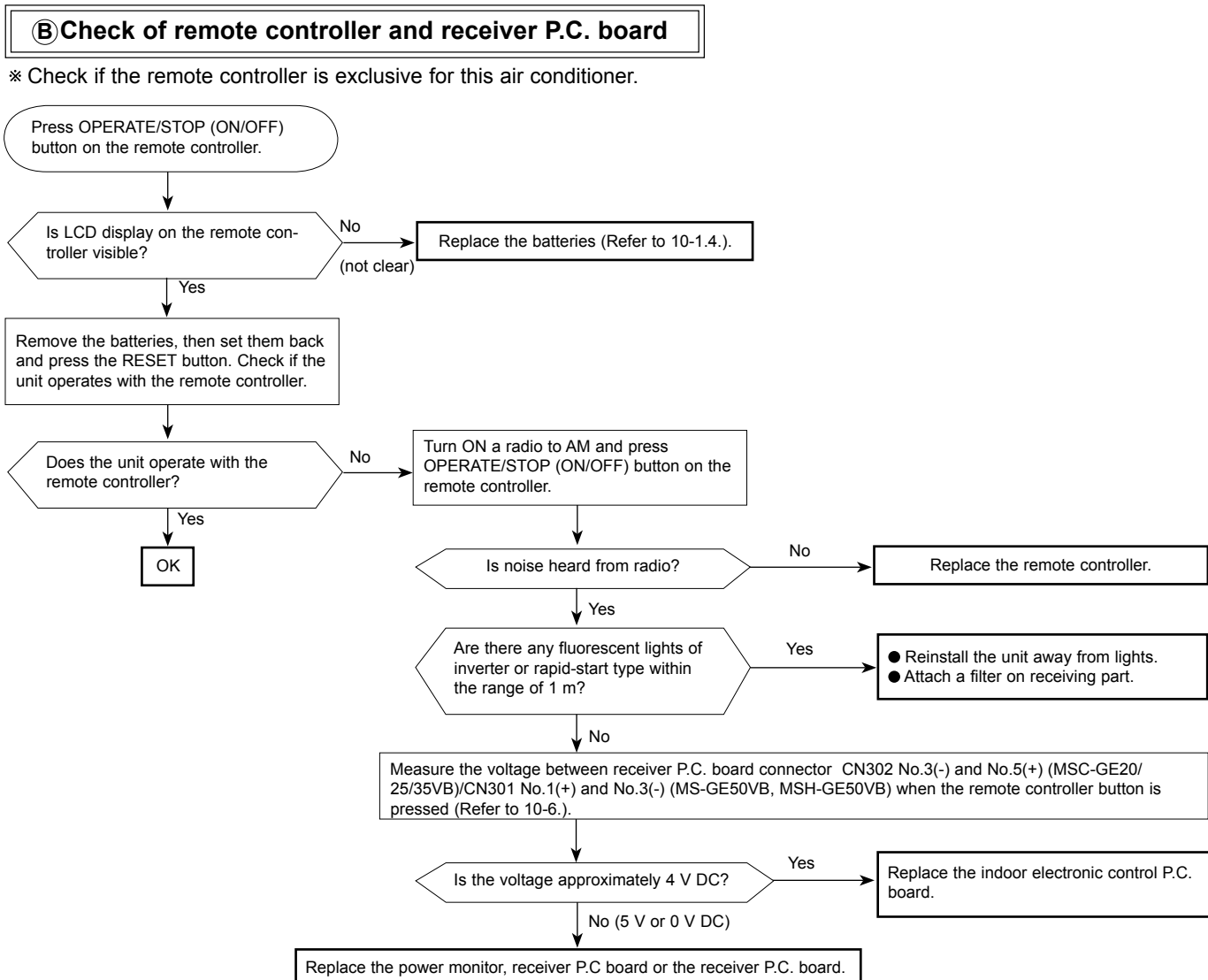

The unit does not operate with the remote controller. Also, the OPERATION INDICATOR lamp does not light up by pressing the EMERGENCY OPERATION switch.

© Check of indoor electronic control P.C. board

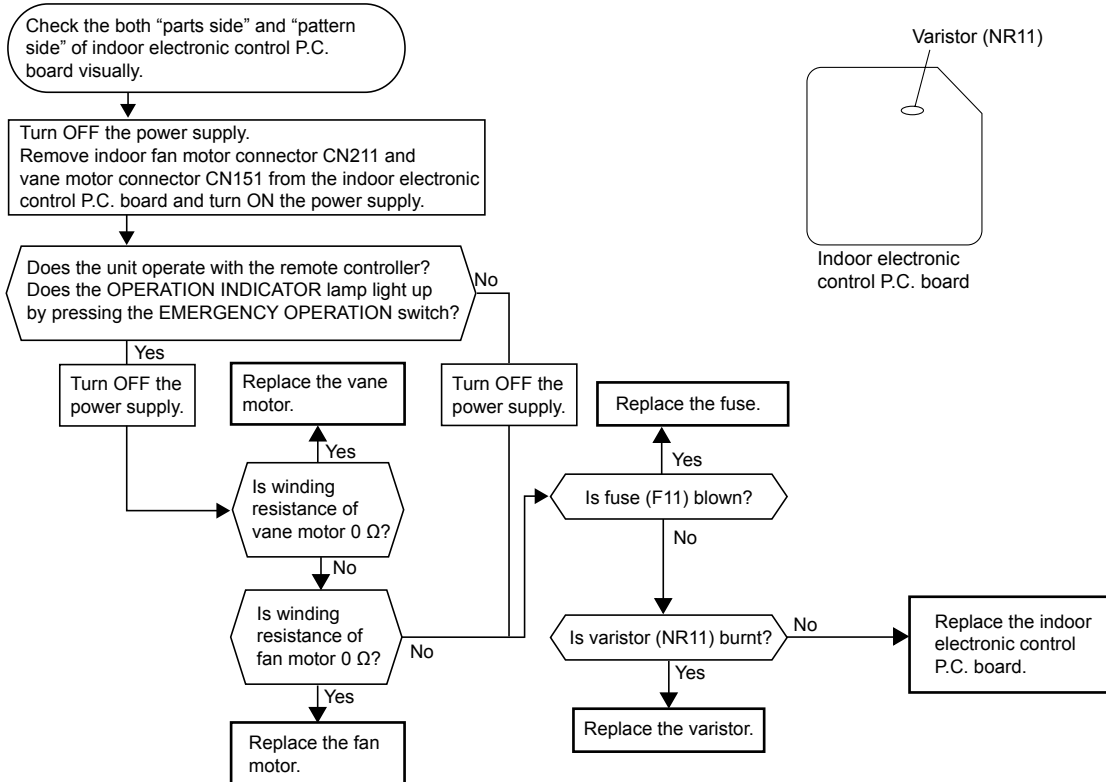

When OPERATION INDICATOR lamp flashes 0.5-second intervals or 1-time.
Outdoor unit does not operate.

① How to check mis-wiring and serial signal error MUH (Except MUH-GE50VB), MXZ

- ※1 Set the switch(SW2-②) on indoor electronic control P.C. board to MU or MUX type, when the outdoor unit is MU or MUX type. If the setting is MUH or MXZ type, the unit does not work.
- ※2 Short circuit of JPG and JPS on the indoor electronic control P.C. board enables self-check to be displayed in 3 seconds.

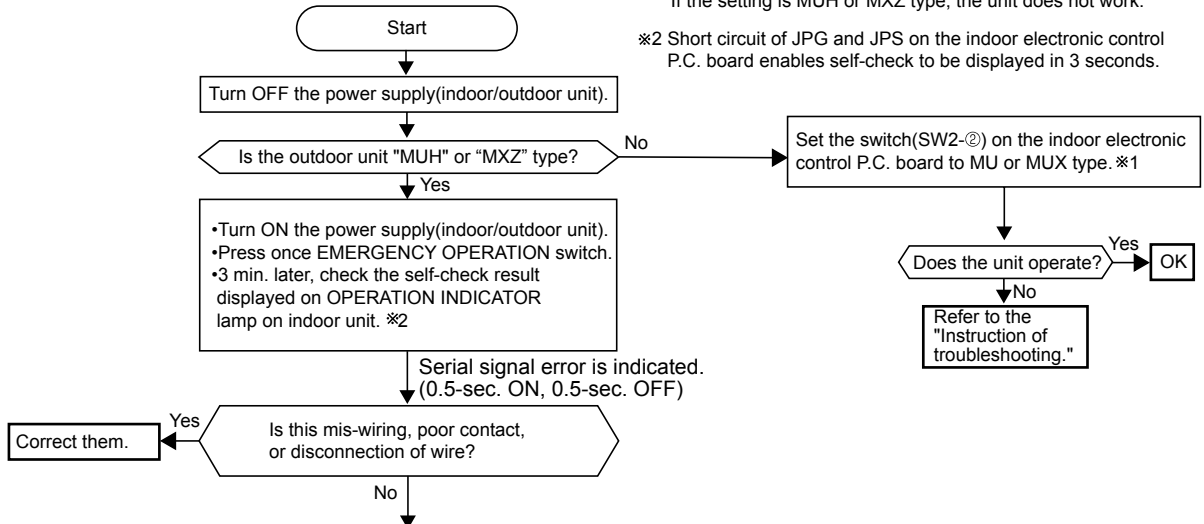

1. Turn OFF the power supply(indoor/outdoor unit) and disconnect indoor and outdoor connecting wire on indoor side.
2. Short-circuit between indoor terminal block ④ and ③.
3. Turn ON the power supply(indoor unit) and press once EMERGENCY OPERATION switch.

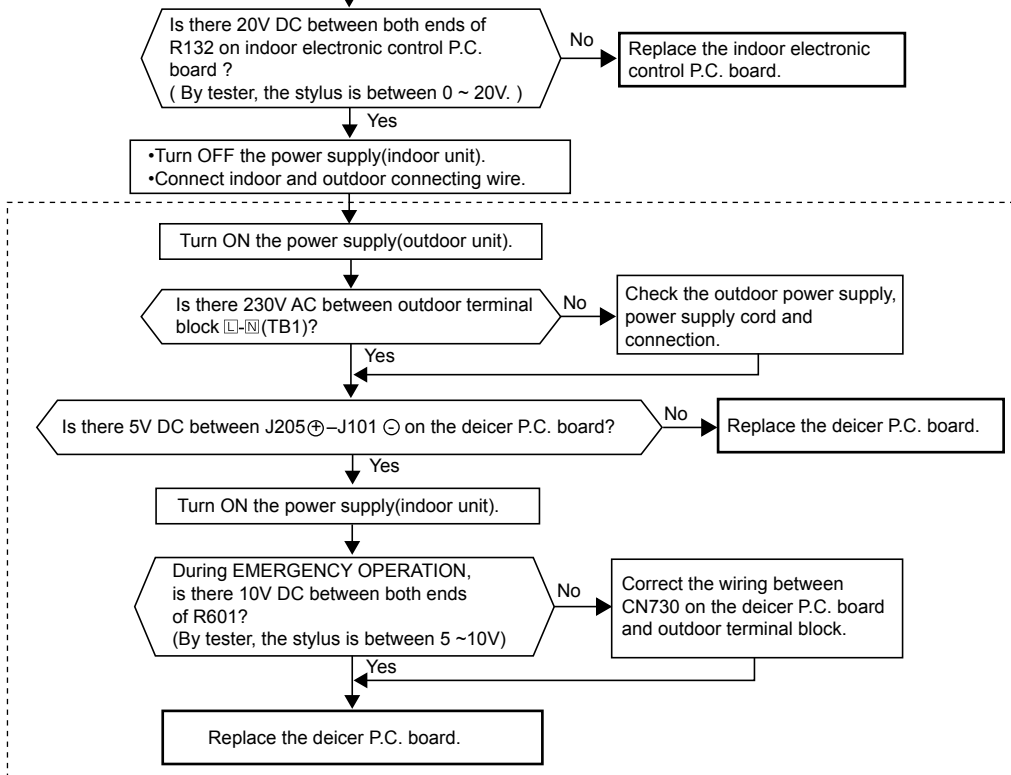

Refer to outdoor unit service manual.

When OPERATION INDICATOR lamp flashes ON and OFF in every 0.5-second.
Outdoor unit does not operate.

E) How to check mis-wiring

MUH-GE50VB

* Short circuit of JPG and JPS on the indoor electronic control P.C. board enables self-check to be displayed in 3 seconds.

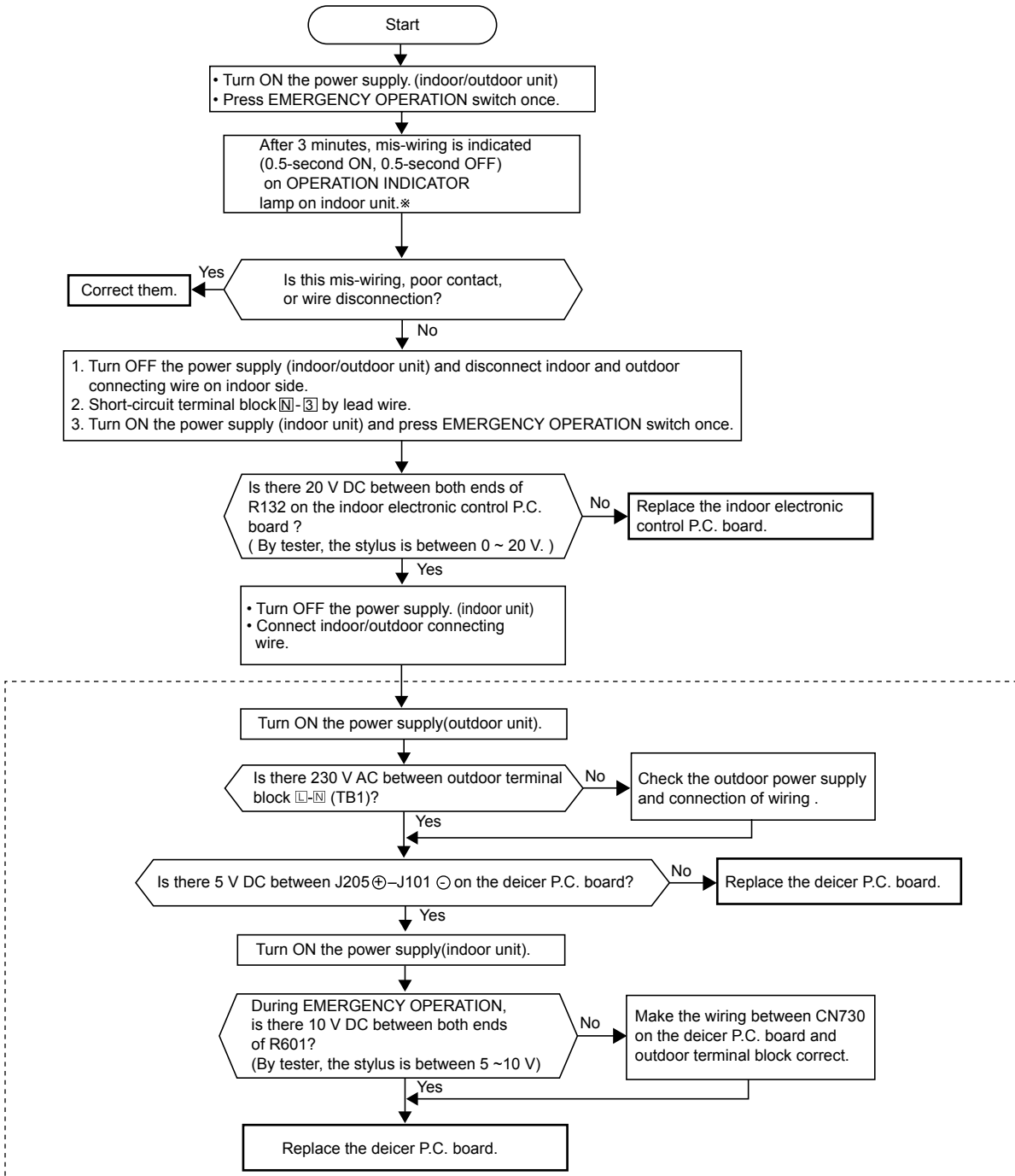

Refer to outdoor unit service manual.

10-6. TEST POINT DIAGRAM AND VOLTAGE

MSC-GE20VB

MSC-GE25VB

MSC-GE35VB

Indoor electronic control P.C. board

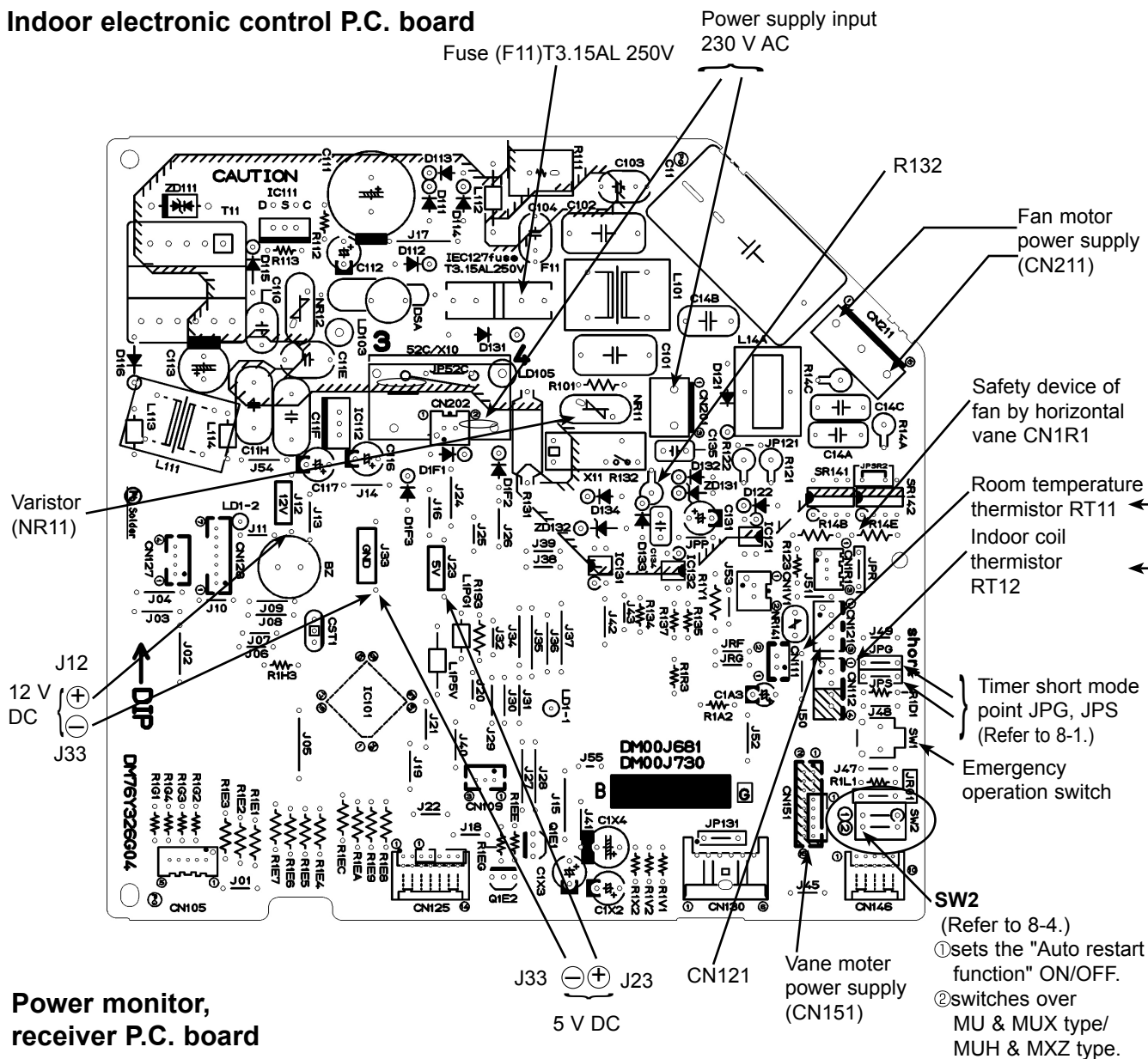

Power monitor, receiver P.C. board

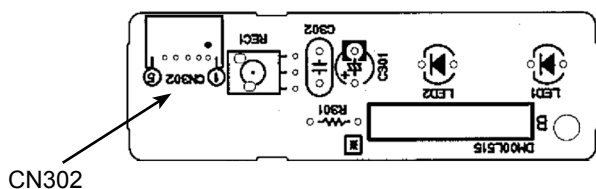

Indoor coil thermistor (RT12)
Room temperature thermistor (RT11)

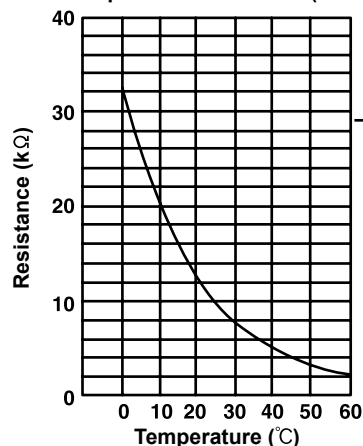

MS-GE50VB
MSH-GE50VB
Indoor electronic control P.C. board

NOTE: There are two types of electronic control P.C. boards (TYPE 1/TYPE 2). They are both compatible with MS/MSH-GE50VB.

TYPE 1

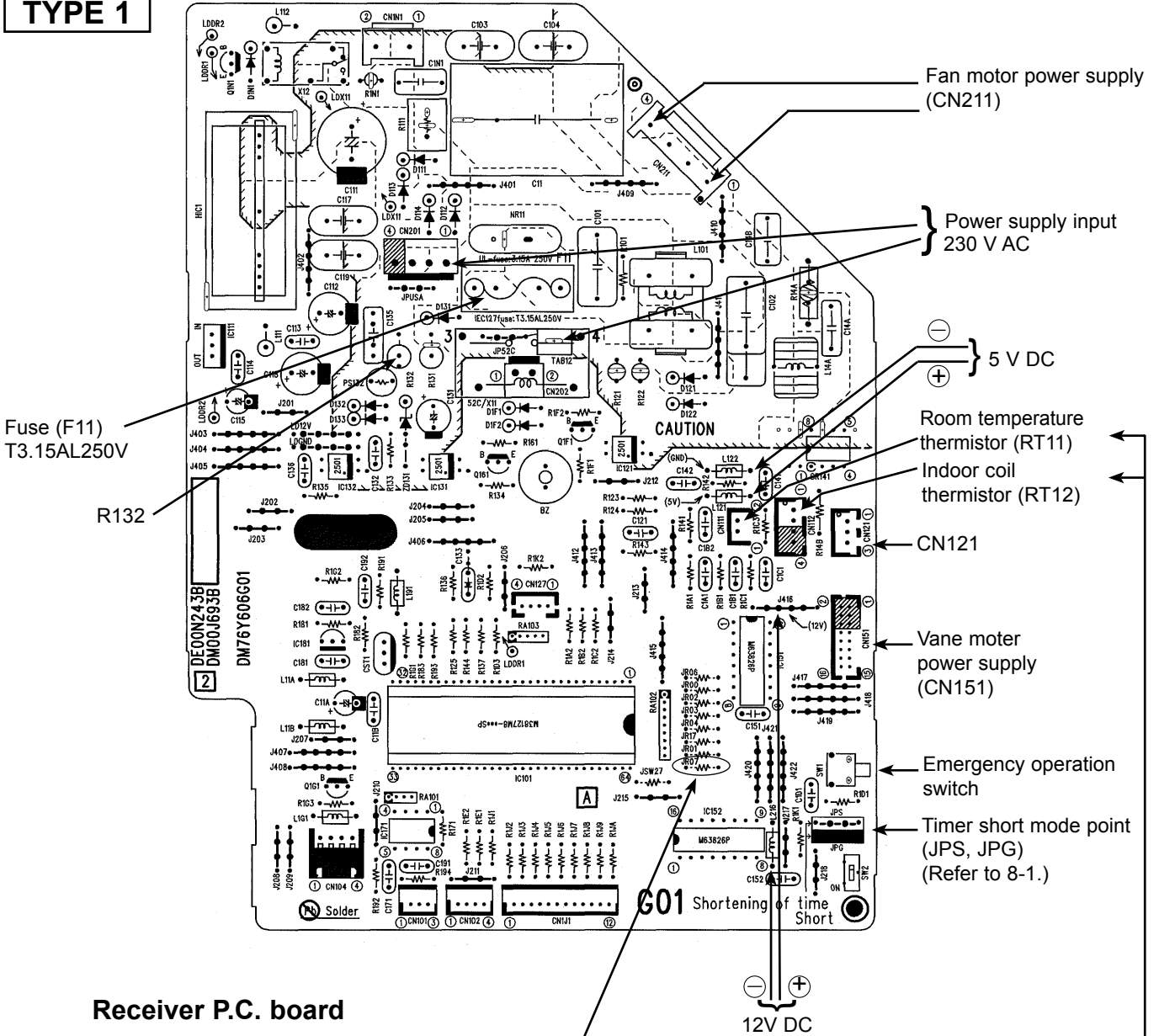

Receiver P.C. board

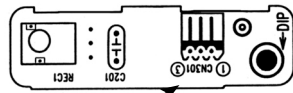

CN301

To disable "Auto restart function", solder jumper wire to JR07. (Refer to 8-4.2.)

Indoor coil thermistor (RT12)
Room temperature thermistor (RT11)

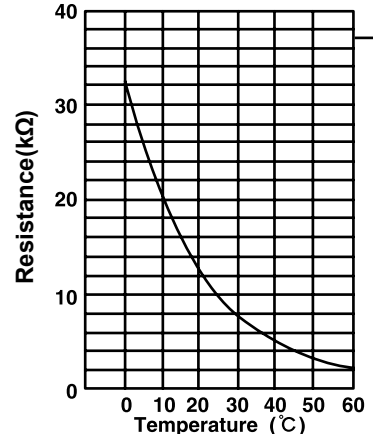

MS-GE50VB
MSH-GE50VB
Indoor electronic control P.C. board

TYPE 2

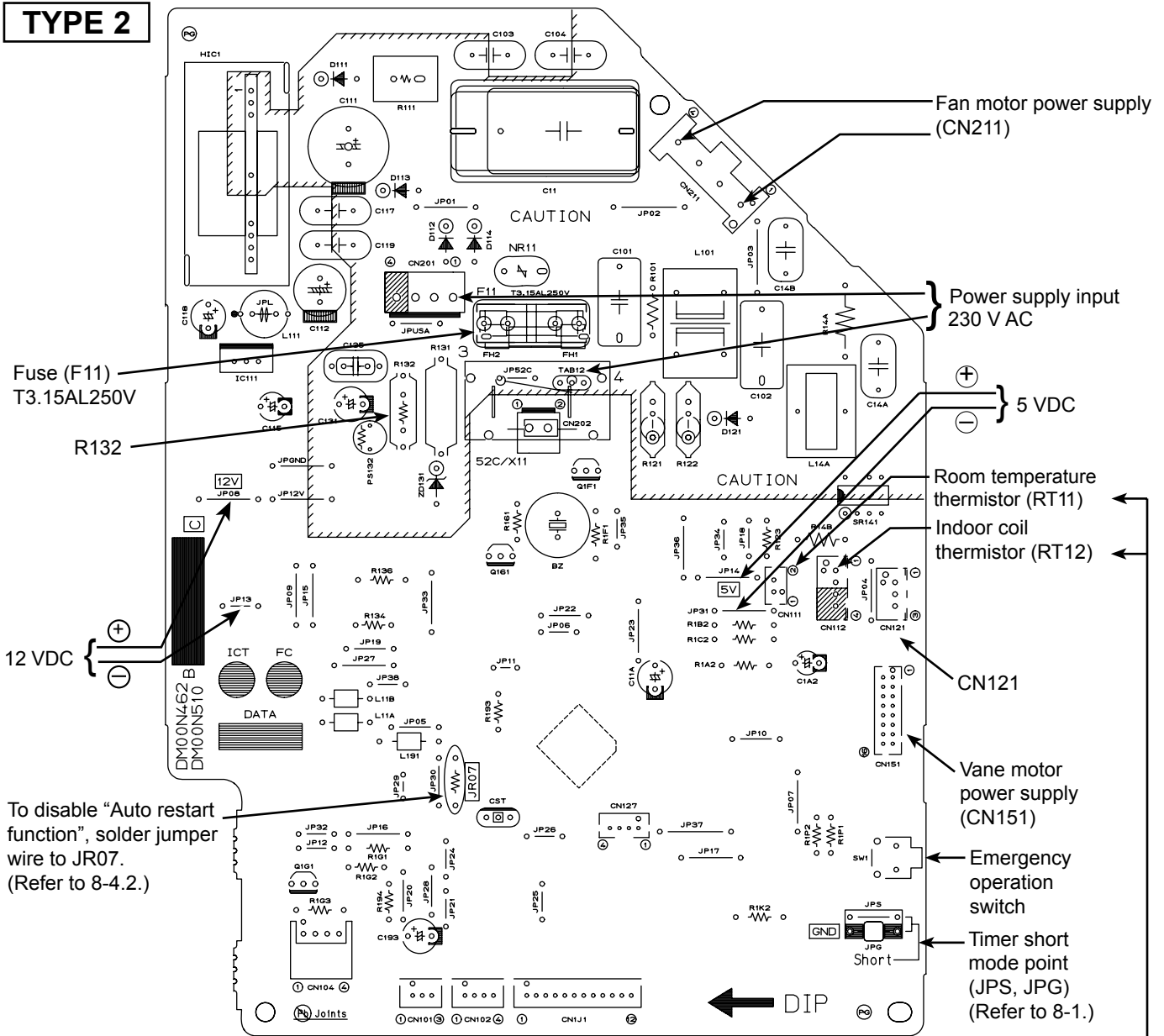

Receiver P.C. board

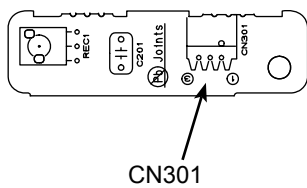

Indoor coil thermistor (RT12)
Room temperature thermistor (RT11)

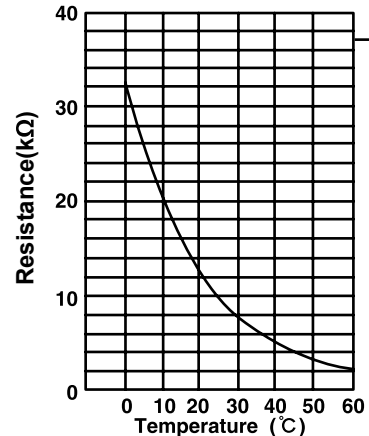

<"Terminal with locking mechanism" Detaching points>

The terminal which has the locking mechanism can be detached as shown below. There are two types (Refer to (1) and (2)) of the terminal with locking mechanism. The terminal without locking mechanism can be detached by pulling it out. Check the shape of the terminal before detaching.

(1) Slide the sleeve and check if there is a locking lever or not.

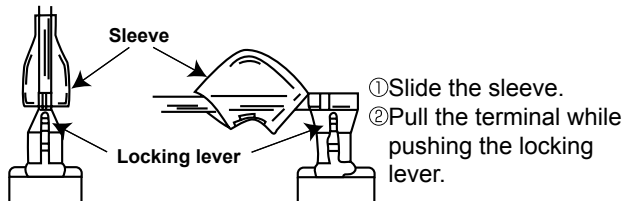

(2) The terminal with this connector has the locking mechanism.

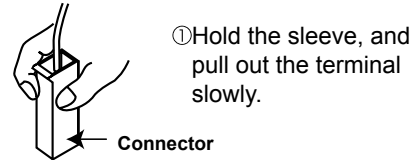
**11-1. MSC-GE20VB MSC-GE25VB MSC-GE35VB**

NOTE: Turn OFF power supply before disassembly.

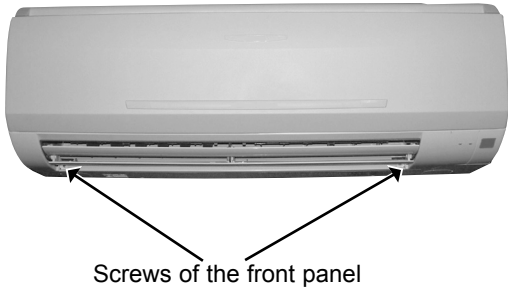
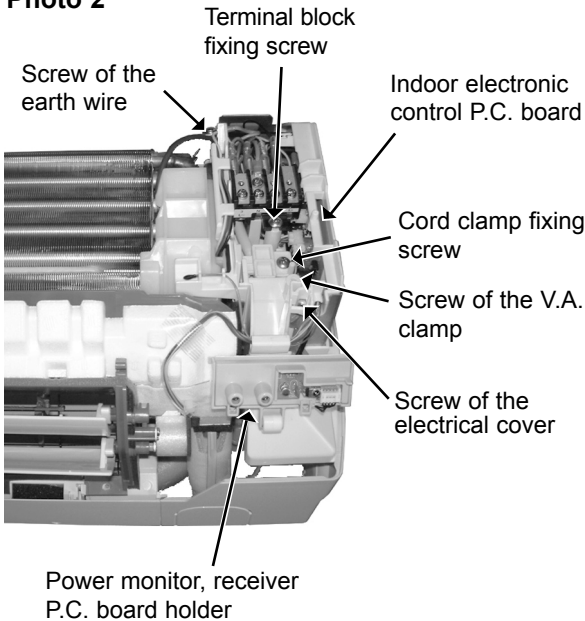
OPERATING PROCEDURE	PHOTOS
<p>1. Removing the front panel</p> <p>(1) Remove the screw caps of the front panel. Remove the screws.</p> <p>(2) Pull the panel down to your side slightly and unhook the catches at the top.</p>	<p>Photo 1</p> 
<p>2. Removing the electronic control P.C. board and the power monitor, receiver P.C. board</p> <p>NOTE : In case of removing only indoor electronic control P.C. board, work (3) is not necessary.</p> <p>(1) Remove the front panel. (Refer to 1.)</p> <p>(2) Remove the power monitor, receiver P.C. board holder from the bottom of electrical box.</p> <p>(3) Open the power monitor, receiver P.C. board holder and remove the power monitor, receiver P.C. board.</p> <p>(4) Remove the screw of the electrical cover and the electrical cover.</p> <p>(5) Remove the screw of the V.A. clamp and the V.A. clamp.</p> <p>(6) Remove the screw of the cord clamp and the cord clamp.</p> <p>(7) Remove the screw of the terminal block.</p> <p>(8) Remove the screw of the earth wire.</p> <p>(9) Pull out indoor electronic control P.C. board slightly.</p> <p>(10) Disconnect all the connectors on the electronic control P.C. board.</p> <p>(11) Remove the electronic control P.C. board and the power monitor, receiver P.C. board.</p>	<p>Photo 2</p> 

OPERATING PROCEDURE

3. Removing the electrical box

- (1) Remove the front panel. (Refer to 1.)
- (2) Remove the electrical cover. (Refer to 2.)
- (3) Remove the V.A. clamp. (Refer to 2.)
- (4) Remove the cord clamp. (Refer to 2.)
- (5) Remove the terminal block. (Refer to 2.)
- (6) Remove the screw of earth wire. (Refer to 2.)
- (7) Disconnect the connector of the indoor coil thermistor (CN112), the fan motor connector (CN211 and CN121) and the vane motor connector (CN151) on the electronic control P.C. board.
- (8) Remove the fan motor lead wire and indoor coil thermistor from the electrical box.
- (9) Remove the lead wire of vane motor from the bottom of electrical box.
- (10) Remove the screw fixing the electrical box, remove the electrical box.

4. Removing the nozzle assembly and the vane motor

- (1) Remove the front pane and the corner box. (Refer to 1.)
- (2) Remove the electrical box. (Refer to 3.)
- (3) Pull out the drain hose from the nozzle assembly, remove the nozzle assembly.
- (4) Remove the screws of the vane motor, disconnect the vane motor connector.
- (5) Remove the vane motor.

5. Removing the indoor fan motor and the line flow fan

- (1) Remove the front panel the corner box. (Refer to 1.)
- (2) Remove the electrical box. (Refer to 3.)
- (3) Pull out the drain hose from the nozzle assembly, remove the nozzle assembly. (Refer to 4.)
- (4) Remove the screw of the lead cover and lead cover.
- (5) Release the hooks to open the motor band slightly.
- (6) Loosen the hexagon socket set screw from the line flow fan.
- (7) Remove the screws fixing the motor bed, remove the fan motor with motor band and the motor bed.
- (8) Remove the screws fixing the left side of the heat exchanger.
- (9) Lift the left side of the heat exchanger.
- (10) Remove the line flow fan.

Photo 6

Hexagon socket set screw

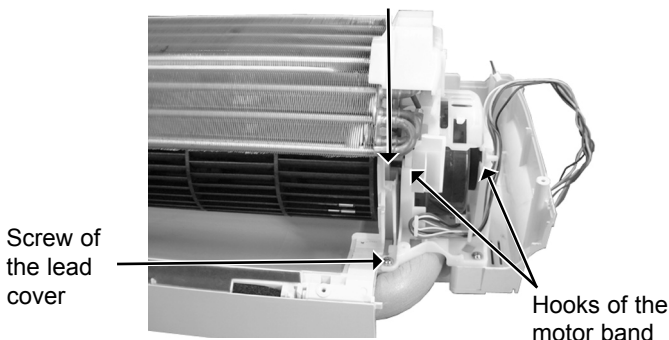

PHOTOS

Photo 3

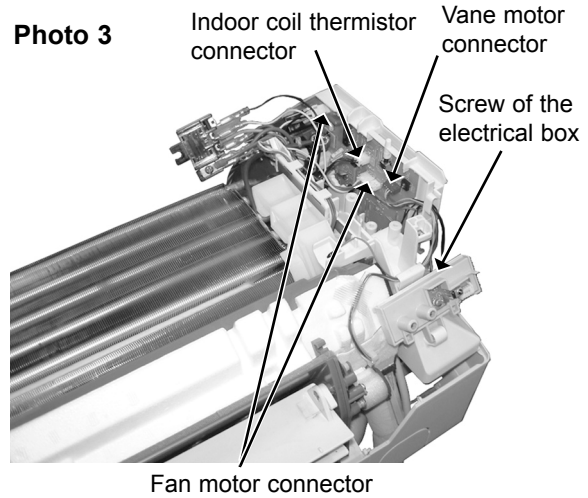

Photo 4

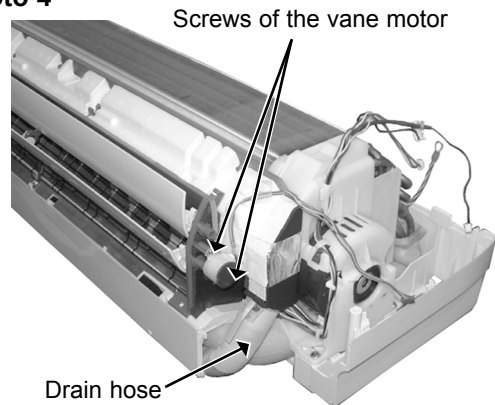

Photo 5

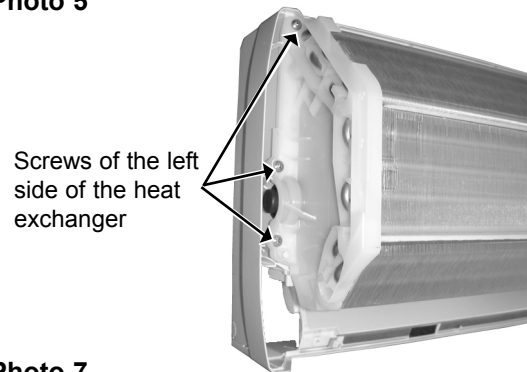
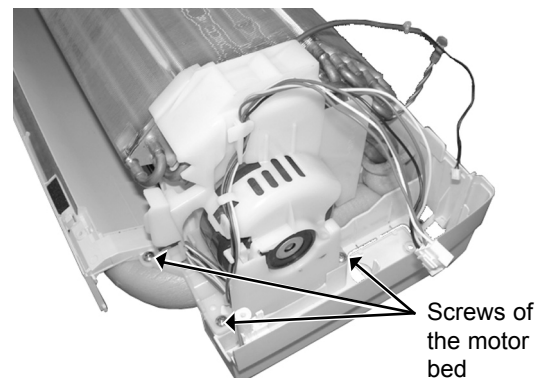
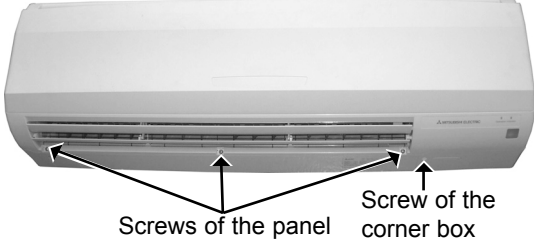
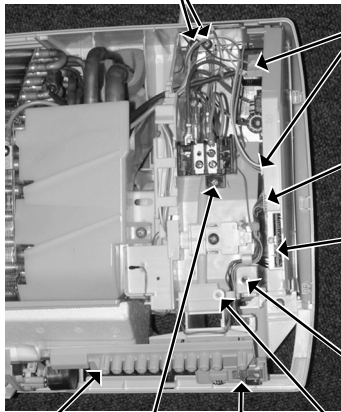
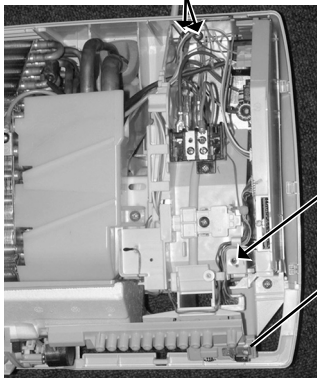

Photo 7



11-2. MS-GE50VB MSH-GE50VB

NOTE: Turn OFF power supply before disassembly.

OPERATING PROCEDURE	PHOTOS
<p>1. Removing the panel</p> <ol style="list-style-type: none"> (1) Remove the screw caps of the panel. Remove the screws of the panel. (2) Pull the panel down to your side slightly and unhook the catches at the top. (3) Remove the screw of the corner box. Remove the corner box. 	<p>Photo 1</p>  <p>Screws of the panel Screw of the corner box</p>
<p>2. Removing the electronic control P.C. board, the receiver P.C. board and the display P.C. board</p> <ol style="list-style-type: none"> (1) Remove the panel and the corner box. (Refer to 1.) (2) Remove the screw of the electrical cover. Remove the electrical cover. (3) Remove the screws of the V.A. clamp. Remove the V.A. clamp. (4) Remove the screw of the terminal block. (5) Remove the screws of the earth wire. (6) Disconnect all the connectors and all the lead wires on the electronic control P.C. board. (7) Remove the R.L holder. (8) Remove the electronic control P.C. board. (9) Open the R.L holder, remove the receiver P.C. board and the display P.C. board. 	<p>Photo 2</p> <p>Screws of the earth wire</p>  <p>Fan motor connectors Vane motor connector Indoor electronic control P.C. board Screw of the electrical cover Screw of the V.A. clamp R.L holder Screw of the terminal block Receiver P.C. board</p>
<p>3. Removing the electrical box</p> <ol style="list-style-type: none"> (1) Remove the panel and the corner box. (Refer to 1.) (2) Remove the electrical cover. (Refer to 2.) (3) Disconnect the connector of the indoor coil thermistor. (4) Disconnect the motor connector (CN211 and CN121) and the vane motor connector (CN151) on the electronic control P.C. board. (5) Remove the screws of earth wire. (6) Remove the fan motor lead wire and indoor coil thermistor from the electrical box. (7) Remove the lead wire of vane motor from the bottom of electrical box. (8) Remove the screw of the electrical box and remove the electrical box. 	<p>Photo 3</p> <p>Screws of the earth wire</p>  <p>Screw of the electrical cover Screw of the electrical box</p>

OPERATING PROCEDURE

4. Removing the vane motor

- (1) Remove the panel and the corner box. (Refer to 1.)
- (2) Remove the electrical cover. (Refer to 2.)
- (3) Remove the lead wire of vane motor. (Refer to 3.)
- (4) Remove the R.L. holder.
- (5) Pull out the drain hose from the nozzle assembly and remove the nozzle assembly.
- (6) Remove the screws of the vane motor and disconnect the connector.
- (7) Remove the vane motor.

Photo 5 Screws of the vane motor

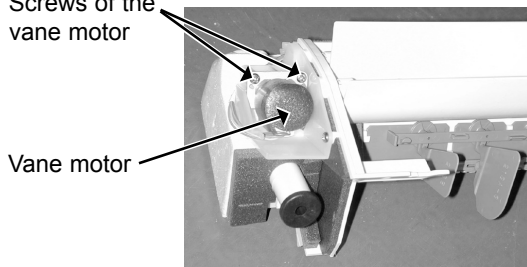

PHOTOS

Photo 4

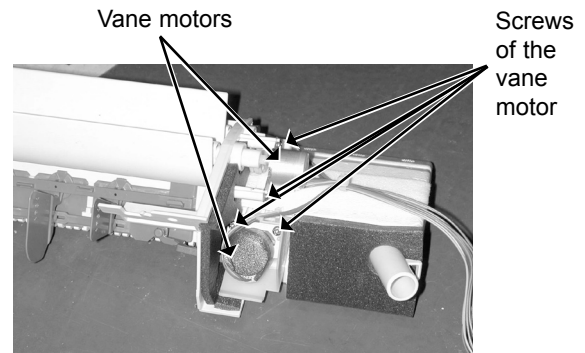

5. Removing the line flow fan and the indoor fan motor

- (1) Remove the panel and the corner box. (Refer to 1.)
- (2) Remove the electrical box. (Refer to 3.)
- (3) Pull out the drain hose from the nozzle assembly and remove the nozzle assembly.
- (4) Remove the water cut.
- (5) Slide the hole cover and remove the hole cover.
- (6) Remove the hexagon socket set screw from the line flow fan.
- (7) Remove the screws of the fan motor and remove the fan motor. (Be careful not to drop the fan motor because it is heavy.)
- (8) Remove the screws of the left side of the heat exchanger.
- (9) Lift the left side of the heat exchanger.
- (10) Remove the line flow fan.

Photo 8

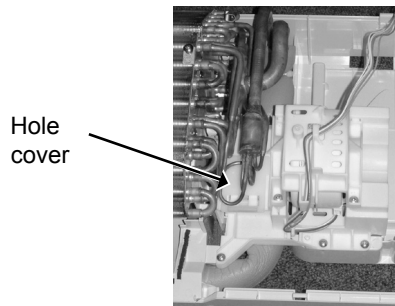

Photo 6

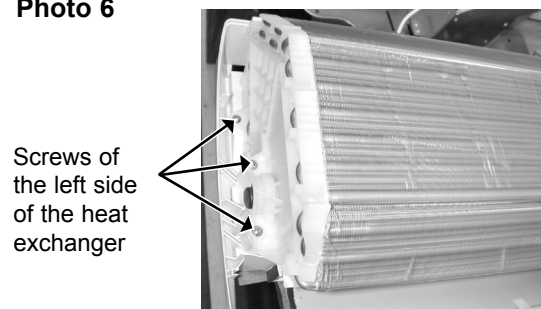
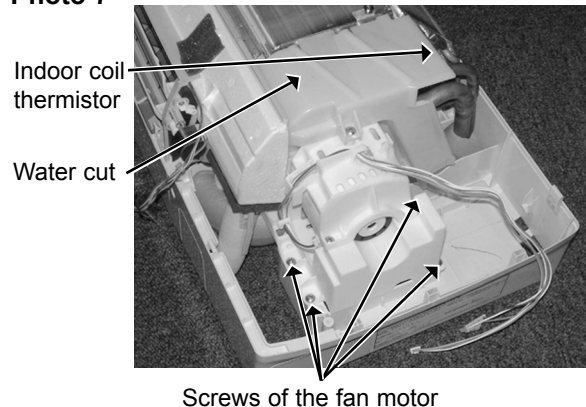

Photo 7



 **MITSUBISHI ELECTRIC CORPORATION**

HEAD OFFICE: TOKYO BLDG., 2-7-3, MARUNOUCHI, CHIYODA-KU, TOKYO 100-8310, JAPAN