



AIR CONDITIONERS CITY MULTI

Models **PUHY-200YMF-C, 250YMF-C**
PUHY-P200YMF-C, P250YMF-C
PUY-200YMF-C, 250YMF-C
PUY-P200YMF-C, P250YMF-C

PURY-200YMF-C, 250YMF-C
PURY-P200YMF-C, P250YMF-C

CMB-P104, P105, P106, P108, P1010, P1013, P1016V-E

Service Handbook

CITY MULTI

Contents

①	PRECAUTIONS FOR DEVICES THAT USE R407C REFRIGERANT	3
	[1] Storage of Piping Material	4
	[2] Piping Machining	5
	[3] Necessary Apparatus and Materials and Notes on Their Handling ..	6
	[4] Brazing	7
	[5] Airtightness Test	8
	[6] Vacuuming	8
	[7] Charging of Refrigerant	9
	[8] Dryer	9
②	COMPONENT OF EQUIPMENT	10
	[1] Appearance of Components	10
	[2] Refrigerant Circuit Diagram and Thermal Sensor	18
	[3] Electrical Wiring Diagram	24
	[4] Standard Operation Data	33
	[5] Function of Dip SW and Rotary SW	41
③	TEST RUN	47
	[1] Before Test Run	47
	[2] Test Run Method	51
④	GROUPING REGISTRATION OF INDOOR UNITS WITH REMOTE CONTROLLER	52
⑤	CONTROL	58
	[1] Control of Outdoor Unit	58
	[2] Control of BC Controller	63
	[3] Operation Flow Chart	64
	[4] List of Major Component Functions	70
	[5] Resistance of Temperature Sensor	73
⑥	REFRIGERANT AMOUNT ADJUSTMENT	74
	[1] Refrigerant Amount and Operating Characteristics	74
	[2] Adjustment and Judgement of Refrigerant Amount	74
⑦	TROUBLESHOOTING	84
	[1] Principal Parts	84
	[2] BC Controller Disassembly Procedure	113
	[3] Self-diagnosis and Countermeasures Depending on the Check Code Displayed	119
	[4] LED Monitor Display	142
⑧	PREPARATION, REPAIRS AND REFRIGERANT REFILLING WHEN REPAIRING LEAKS	161
	[1] Location of leaks: Extension piping or indoor units (when cooling)	161
	[4] Location of leaks: Outdoor unit (when heating)	163
⑨	CHECK THE COMPOSITION OF THE REFRIGERANT (PURY-P200-250YMF-C only)	164

Safety precautions

Before installation and electric work

- ▶ Before installing the unit, make sure you read all the “Safety precautions”.
- ▶ The “Safety precautions” provide very important points regarding safety. Make sure you follow them.
- ▶ This equipment may not be applicable to EN61000-3-2: 1995 and EN61000-3-3: 1995.
- ▶ This equipment may have an adverse effect on equipment on the same electrical supply system. Please report to or take consent by the supply authority before connection to the system.

Symbols used in the text





Warning:

Describes precautions that should be observed to prevent danger of injury or death to the user.

Caution:

Describes precautions that should be observed to prevent damage to the unit.

Symbols used in the illustrations

-  : Indicates an action that must be avoided.
-  : Indicates that important instructions must be followed.
-  : Indicates a part which must be grounded.
-  : Beware of electric shock (This symbol is displayed on the main unit label.) <Color: Yellow>

Warning:

Carefully read the labels affixed to the main unit.

Warning:

- **Use the specified cables for wiring. Make the connections securely so that the outside force of the cable is not applied to the terminals.**
 - Inadequate connection and fastening may generate heat and cause a fire.
- **Have all electric work done by a licensed electrician according to “Electric Facility Engineering Standard” and “Interior Wire Regulations” and the instructions given in this manual and always use a special circuit.**
 - If the power source capacity is inadequate or electric work is performed improperly, electric shock and fire may result.
- **Securely install the cover of control box and the panel.**
 - If the cover and panel are not installed properly, dust or water may enter the outdoor unit and fire or electric shock may result.
- **After completing service work, make sure that refrigerant gas is not leaking.**
 - If the refrigerant gas leaks and is exposed to a fan heater, stove, oven, or other heat source, it may generate noxious gases.
- **Do not reconstruct or change the settings of the protection devices.**
 - If the pressure switch, thermal switch, or other protection device is shorted and operated forcibly, or parts other than those specified by Mitsubishi Electric are used, fire or explosion may result.

1 PRECAUTIONS FOR DEVICES THAT USE R407C REFRIGERANT

Caution

Do not use the existing refrigerant piping.

- The old refrigerant and refrigerator oil in the existing piping contains a large amount of chlorine which may cause the refrigerator oil of the new unit to deteriorate.

Use refrigerant piping made of phosphorus deoxidized copper and copper alloy seamless pipes and tubes". In addition, be sure that the inner and outer surfaces of the pipes are clean and free of hazardous sulphur, oxides, dust/dirt, shaving particles, oils, moisture, or any other contaminant.

- Contaminants on the inside of the refrigerant piping may cause the refrigerant residual oil to deteriorate.

Store the piping to be used during installation indoors and keep both ends of the piping sealed until just before brazing. (Store elbows and other joints in a plastic bag.)

- If dust, dirt, or water enters the refrigerant cycle, deterioration of the oil and compressor trouble may result.

Use ester oil, ether oil or alkylbenzene (small amount) as the refrigerator oil to coat flares and flange connections.

- The refrigerator oil will degrade if it is mixed with a large amount of mineral oil.

Use liquid refrigerant to seal the system.

- If gas refrigerant is used to seal the system, the composition of the refrigerant in the cylinder will change and performance may drop.

Do not use a refrigerant other than R407C.

- If another refrigerant (R22, etc.) is used, the chlorine in the refrigerant may cause the refrigerator oil to deteriorate.

Use a vacuum pump with a reverse flow check valve.

- The vacuum pump oil may flow back into the refrigerant cycle and cause the refrigerator oil to deteriorate.

Do not use the following tools that have been used with conventional refrigerants.

(Gauge manifold, charge hose, gas leak detector, reverse flow check valve, refrigerant charge base, vacuum gauge, refrigerant recovery equipment)

- If the conventional refrigerant and refrigerator oil are mixed in the R407C, the refrigerant may deteriorate.
- If water is mixed in the R407C, the refrigerator oil may deteriorate.
- Since R407C does not contain any chlorine, gas leak detectors for conventional refrigerants will not react to it.

Do not use a charging cylinder.

- Using a charging cylinder may cause the refrigerant to deteriorate.

Be especially careful when managing the tools.

- If dust, dirt, or water gets in the refrigerant cycle, the refrigerant may deteriorate.

If the refrigerant leaks, recover the refrigerant in the refrigerant cycle, then recharge the cycle with the specified amount of the liquid refrigerant indicated on the air conditioner.

- Since R407C is a nonazeotropic refrigerant, if additionally charged when the refrigerant leaked, the composition of the refrigerant in the refrigerant cycle will change and result in a drop in performance or abnormal stopping.

[1] Storage of Piping Material

(1) Storage location



Store the pipes to be used indoors. (Warehouse at site or owner's warehouse)
Storing them outdoors may cause dirt, waste, or water to infiltrate.

(2) Pipe sealing before storage

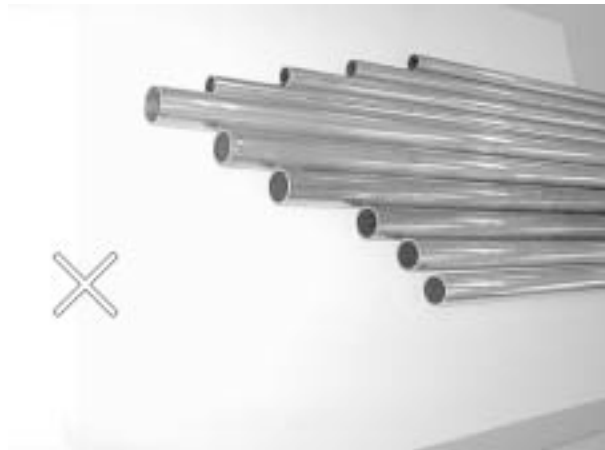
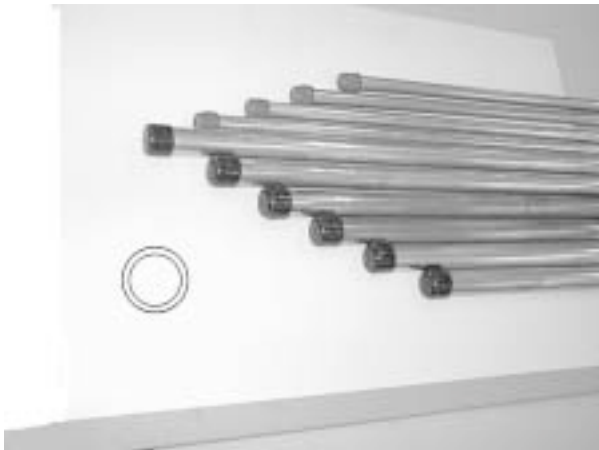

Both ends of the pipes should be sealed until immediately before brazing.
Wrap elbows and T's in plastic bags for storage.

* The new refrigerator oil is 10 times more hygroscopic than the conventional refrigerator oil (such as Suniso). Water infiltration in the refrigerant circuit may deteriorate the oil or cause a compressor failure. Piping materials must be stored with more care than with the conventional refrigerant pipes.

[2] Piping Machining

Use ester oil, ether oil or alkylbenzene (small amount) as the refrigerator oil to coat flares and flange connections.



Use only the necessary minimum quantity of oil !

Reason :

1. The refrigerator oil used for the equipment is highly hygroscopic and may introduce water inside.

Notes :

- Introducing a great quantity of mineral oil into the refrigerant circuit may also cause a compressor failure.
- Do not use oils other than ester oil, ether oil or alkylbenzene.

[3] Necessary Apparatus and Materials and Notes on Their Handling

The following tools should be marked as dedicated tools for R407C.

<<Comparison of apparatus and materials used for R407C and for R22>>

Apparatus Used	Use	R22	R407C
Gauge manifold	Evacuating, refrigerant filling	Current product	⊙
Charging hose	Operation check	Current product	⊙
Charging cylinder	Refrigerant charging	Current product	⊙ Do not use.
Gas leakage detector	Gas leakage check	Current product	⊙ Shared with R134a
Refrigerant collector	Refrigerant collection	R22	⊙ For R407C use only
Refrigerant cylinder	Refrigerant filling	R22	⊙ Identification of dedicated use for R407C : Record refrigerant name and put brown belt on upper part of cylinder.
Vacuum pump	Vacuum drying	Current product	△ Can be used by attaching an adapter with a check valve.
Vacuum pump with a check valve		Current product	△
Flare tool	Flaring of pipes	Current product	△
Bender	Bending of pipes	Current product	△
Application oil	Applied to flared parts	Current product	⊙ Ester oil or Ether oil or Alkybenzene (Small amount)
Torque wrench	Tightening of flare nuts	Current product	△
Pipe cutter	Cutting of pipes	Current product	△
Welder and nitrogen cylinder	Welding of pipes	Current product	△
Refrigerant charging meter	Refrigerant charging	Current product	△
Vacuum gauge	Checking the vacuum degree	Current product	△

Symbols : ⊙ To be used for R407C only.

△ Can also be used for conventional refrigerants.

Tools for R407C must be handled with more care than those for conventional refrigerants. They must not come into contact with any water or dirt.

[4] Brazing

No changes from the conventional method, but special care is required so that foreign matter (ie. oxide scale, water, dirt, etc.) does not enter the refrigerant circuit.

Example : Inner state of brazed section

When non-oxide brazing was not used

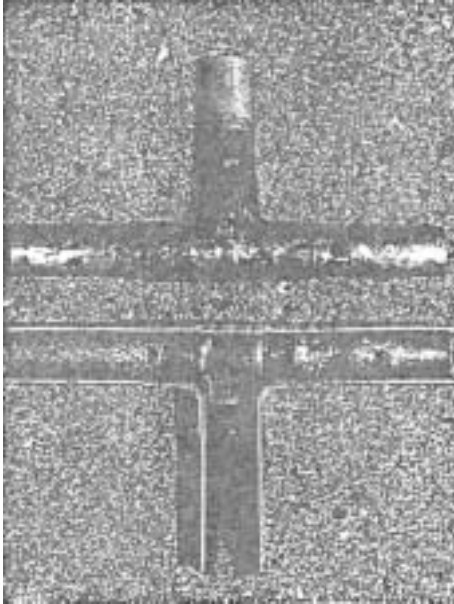

When non-oxide brazing was used

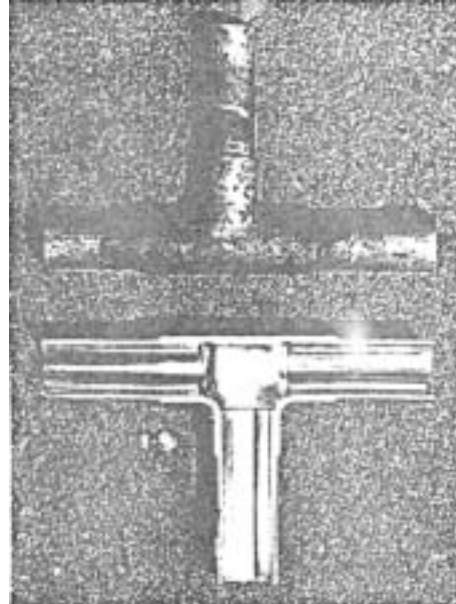

Items to be strictly observed :

1. Do not conduct refrigerant piping work outdoors on a rainy day.
2. Apply non-oxide brazing.
3. Use a brazing material (Bcup-3) which requires no flux when brazing between copper pipes or between a copper pipe and copper coupling.
4. If installed refrigerant pipes are not immediately connected to the equipment, then braze and seal both ends of them.

Reasons :

1. The new refrigerant oil is 10 times more hygroscopic than the conventional oil. The probability of a machine failure if water infiltrates is higher than with conventional refrigerant oil.
2. A flux generally contains chlorine. A residual flux in the refrigerant circuit may generate sludge.

Note :

- Commercially available antioxidants may have adverse effects on the equipment due to its residue, etc. When applying non-oxide brazing, use nitrogen.

[5] Airtightness Test

No changes from the conventional method. Note that a refrigerant leakage detector for R22 cannot detect R407C leakage.

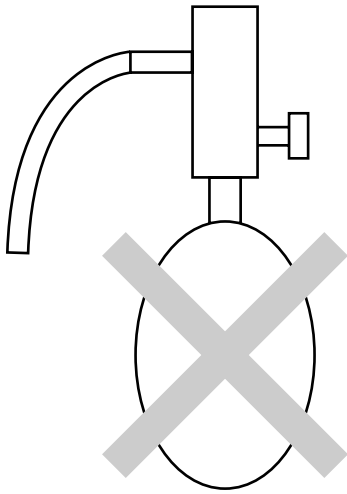

Halide torch

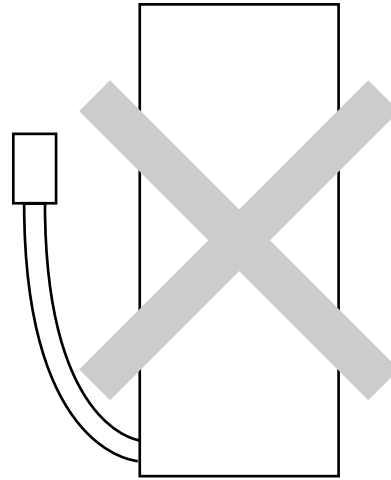

R22 leakage detector

Items to be strictly observed :

1. Pressurize the equipment with nitrogen up to the design pressure and then judge the equipment's airtightness, taking temperature variations into account.
2. When investigating leakage locations using a refrigerant, be sure to use R407C.
3. Ensure that R407C is in a liquid state when charging.

Reasons :

1. Use of oxygen as the pressurized gas may cause an explosion.
2. Charging with R407C gas will lead the composition of the remaining refrigerant in the cylinder to change and this refrigerant can then not be used.

Note :

- A leakage detector for R407C is sold commercially and it should be purchased.

[6] Vacuuming

1. Vacuum pump with check valve

A vacuum pump with a check valve is required to prevent the vacuum pump oil from flowing back into the refrigerant circuit when the vacuum pump power is turned off (power failure).

It is also possible to attach a check valve to the actual vacuum pump afterwards.

2. Standard degree of vacuum for the vacuum pump

Use a pump which reaches 0.5 Torr (500 MICRON) or below after 5 minutes of operation.

In addition, be sure to use a vacuum pump that has been properly maintained and oiled using the specified oil. If the vacuum pump is not properly maintained, the degree of vacuum may be too low.

3. Required accuracy of the vacuum gauge

Use a vacuum gauge that can measure up to 5 Torr. Do not use a general gauge manifold since it cannot measure a vacuum of 5 Torr.

4. Evacuating time

- Evacuate the equipment for 1 hour after -755 mmHg (5 Torr) has been reached.
- After evacuating, leave the equipment for 1 hour and make sure the that vacuum is not lost.

5. Operating procedure when the vacuum pump is stopped

In order to prevent a backflow of the vacuum pump oil, open the relief valve on the vacuum pump side or loosen the charge hose to drawn in air before stopping operation.

The same operating procedure should be used when using a vacuum pump with a check valve.

[7] Charging of Refrigerant

R407C must be in a liquid state when charging, because it is a non-azeotropic refrigerant.

For a cylinder with a syphon attached

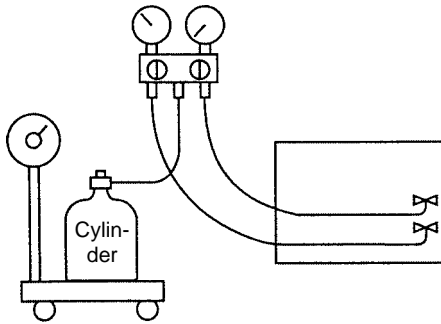

For a cylinder without a syphon attached

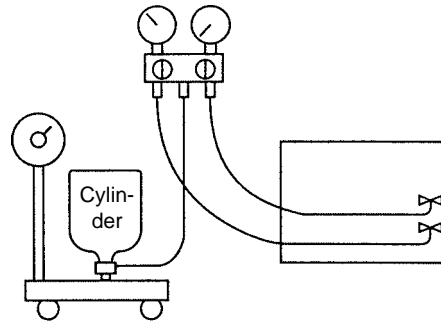

Cylinder color identification
R407C-Gray
R410A-Pink

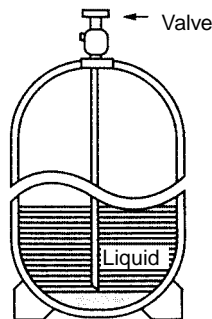

Charged with liquid refrigerant

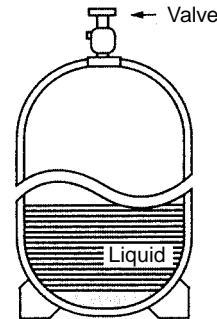

Reasons :

1. R407C is a mixture of 3 refrigerants, each with a different evaporation temperature. Therefore, if the equipment is charged with R407C gas, then the refrigerant whose evaporation temperature is closest to the outside temperature is charged first while the rest of refrigerants remain in the cylinder.

Note :

- In the case of a cylinder with a syphon, liquid R407C is charged without turning the cylinder up side down. Check the type of cylinder before charging.

[8] Dryer

1. Replace the dryer when the refrigerant circuit is opened (Ex. Change the compressor, full gas leakage). Be sure to replace the dryer with a CITY MULTI Series Y (For use with R407C).

If any other product is used, the unit will be damaged.

2. Opening the refrigerant circuit after changing to a new dryer is less than 1 hour. The replacement of the dryer should be the last operation performed.

2 COMPONENT OF EQUIPMENT

[1] Appearance of Components

Outdoor unit

- PU(H)Y-(P)200, 250YMF-C

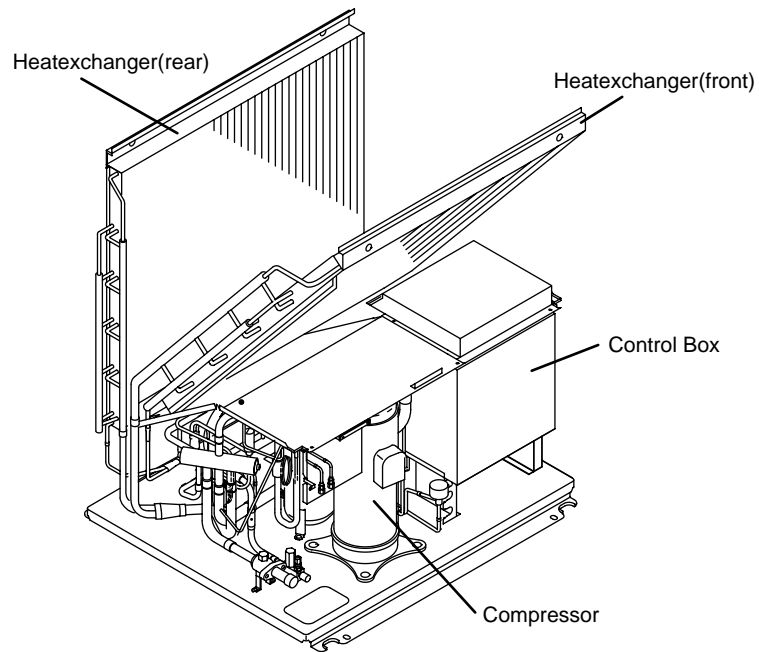
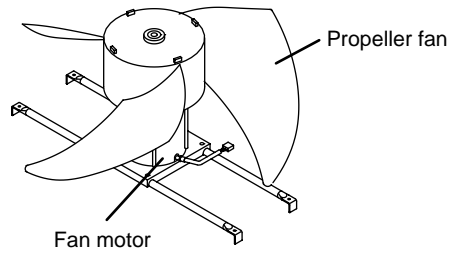

PUHY-YMF-C

PUY-P-YMF-C

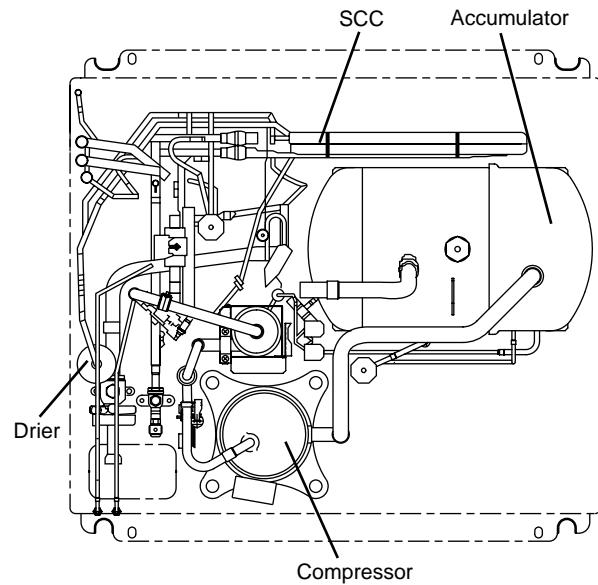
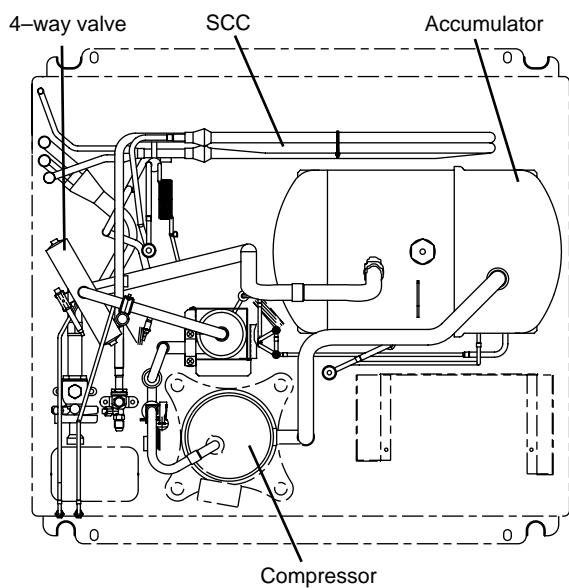

• PURY-P200-250YMF-C

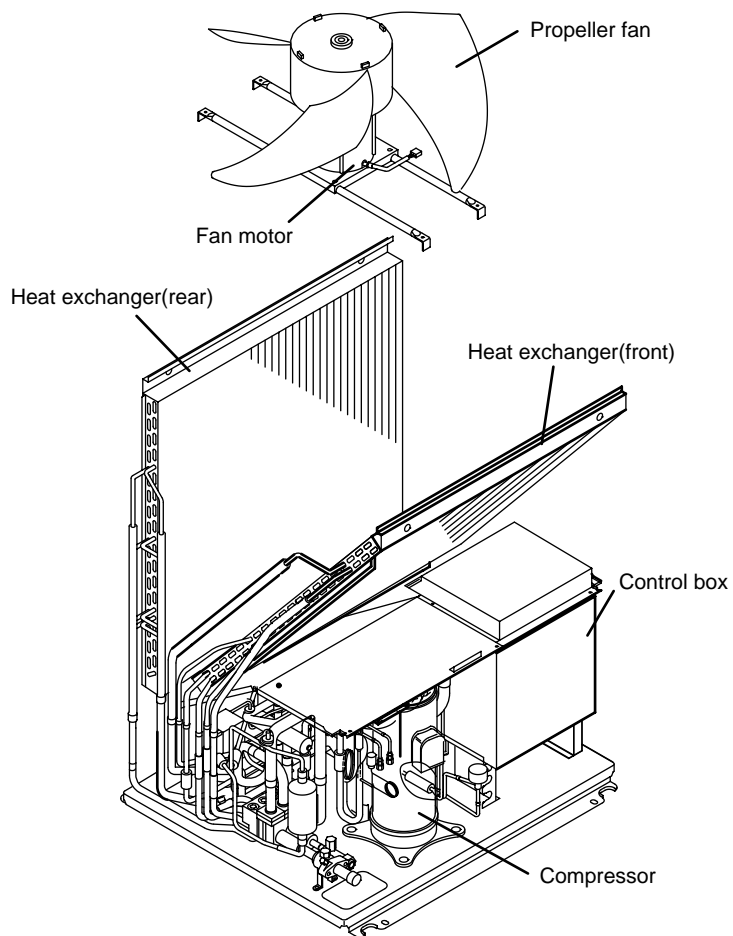

PURY-YMF-C

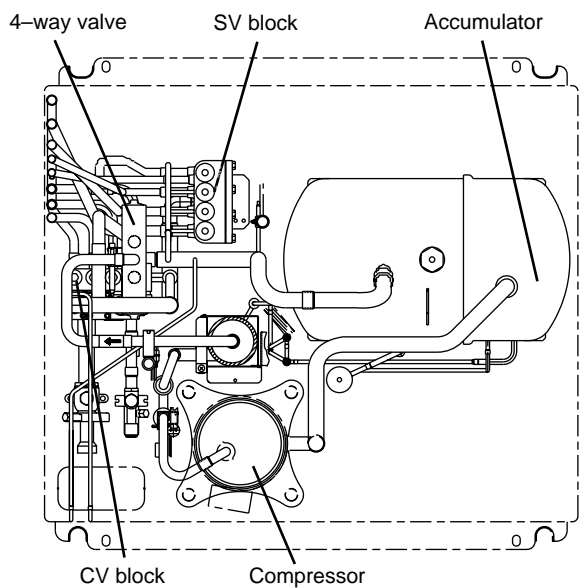

PURY-P-YMF-C

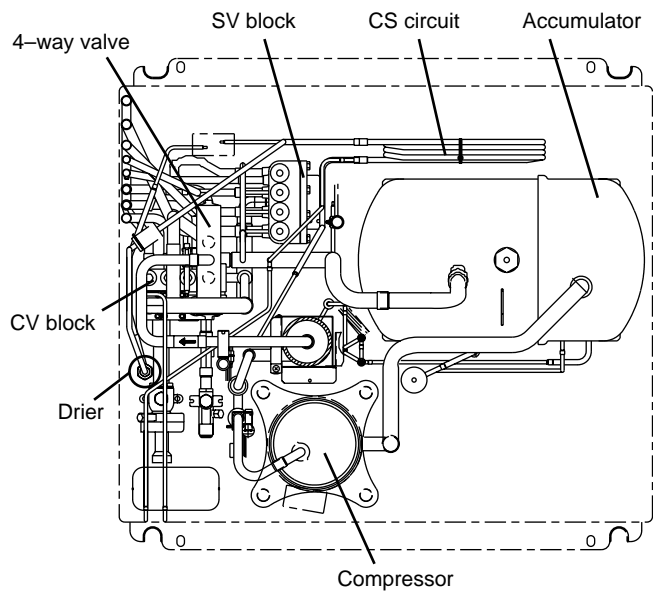

Controller Box

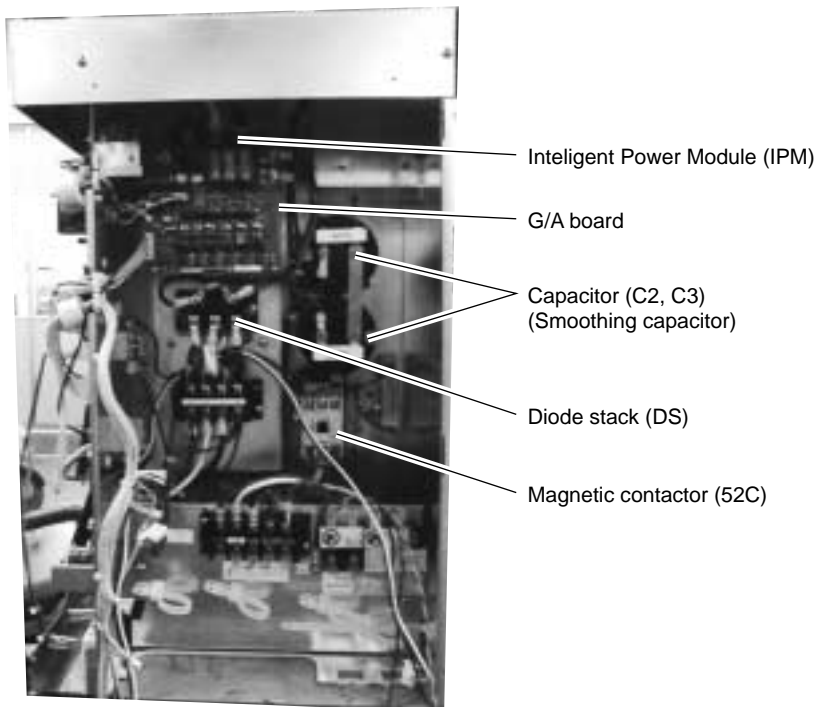
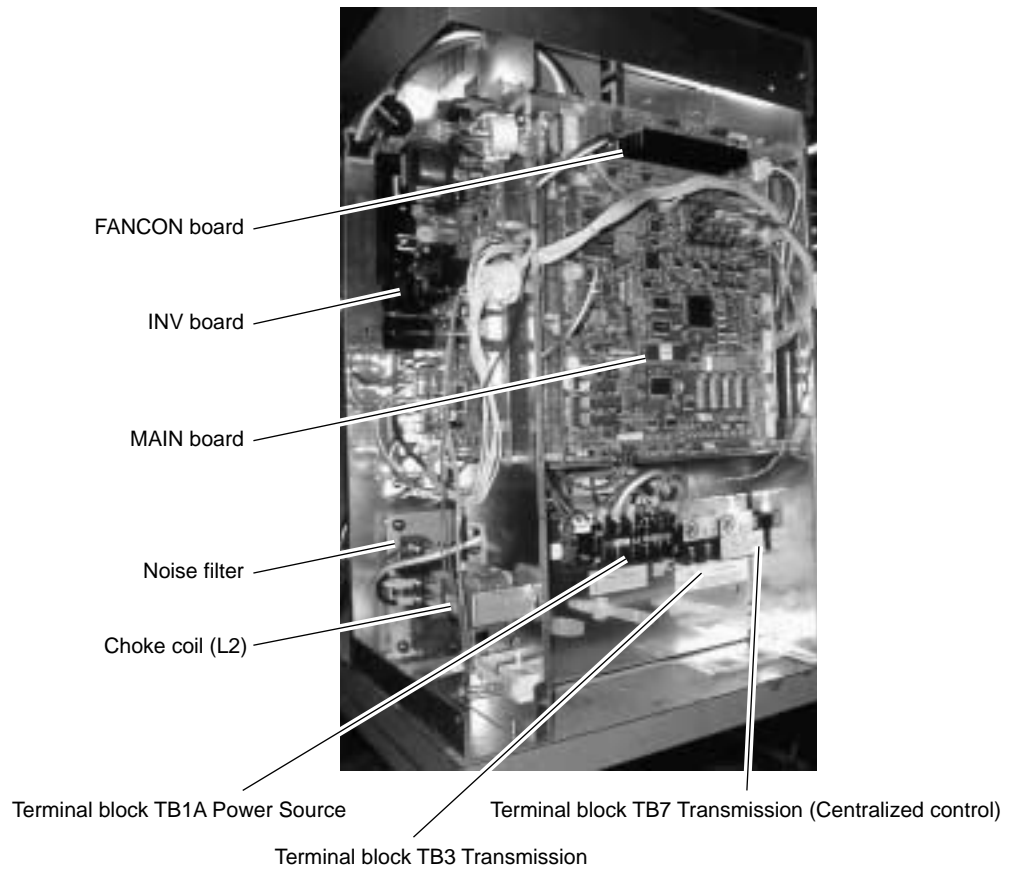

MAIN board

• PUHY / PURY

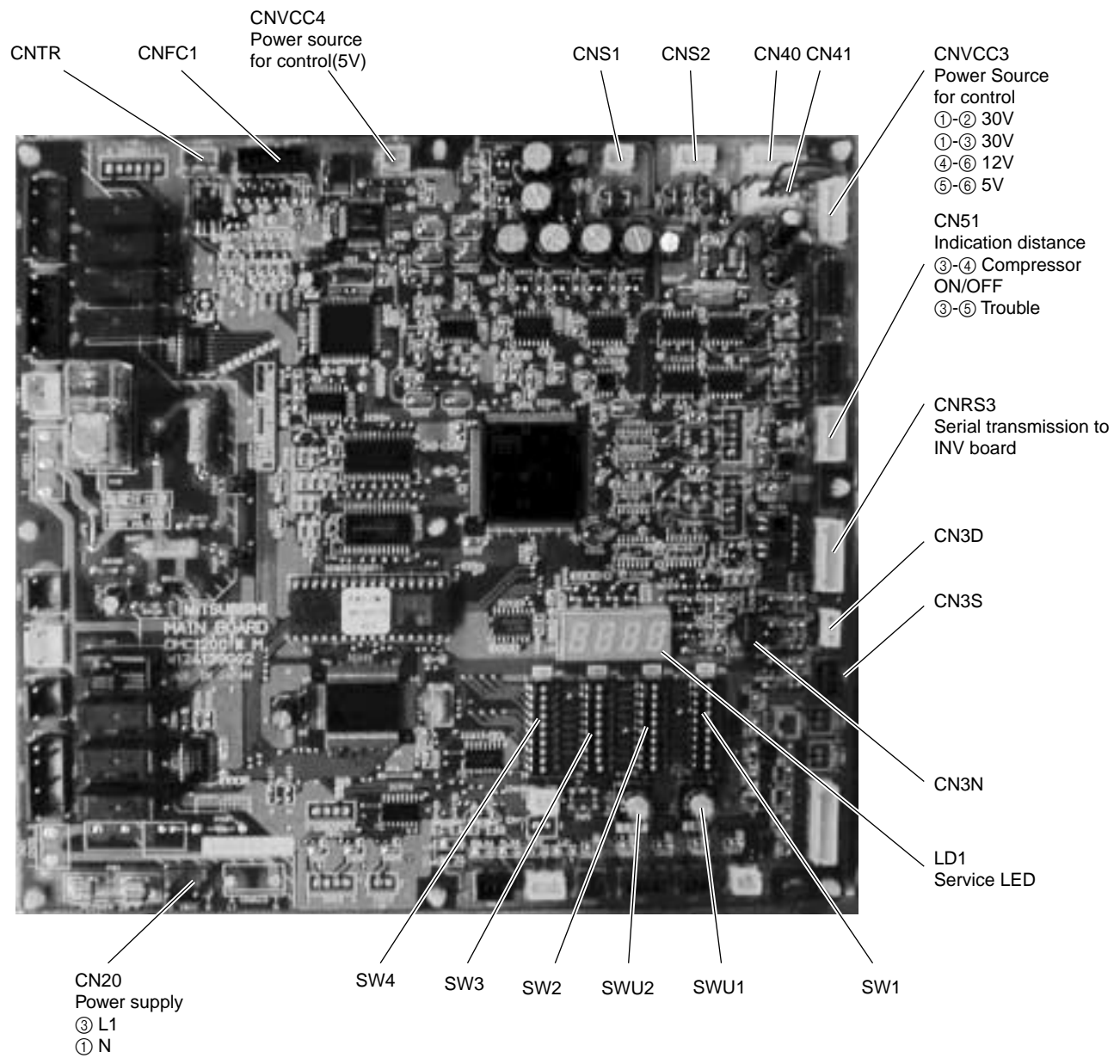

INV board

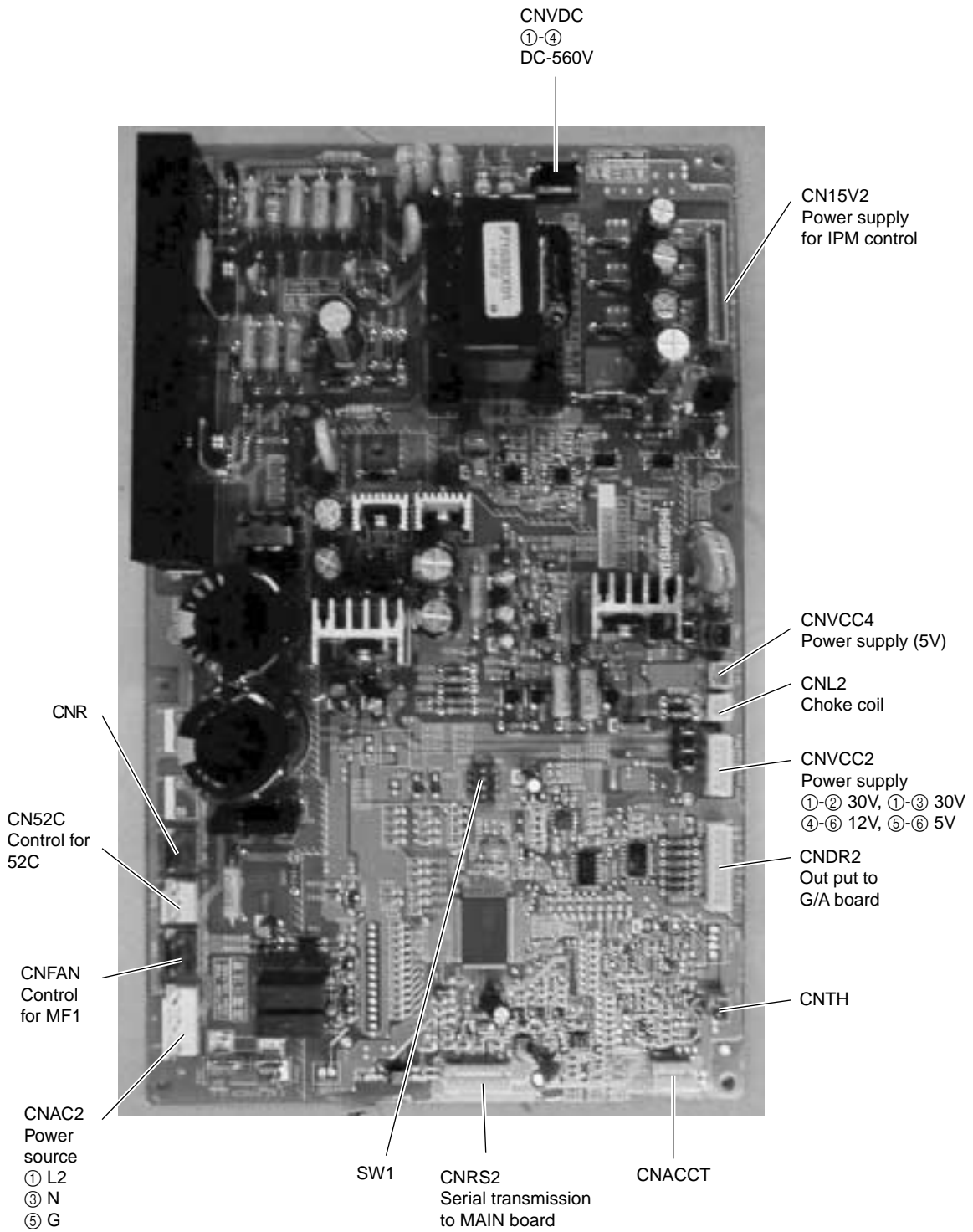

FANCON board

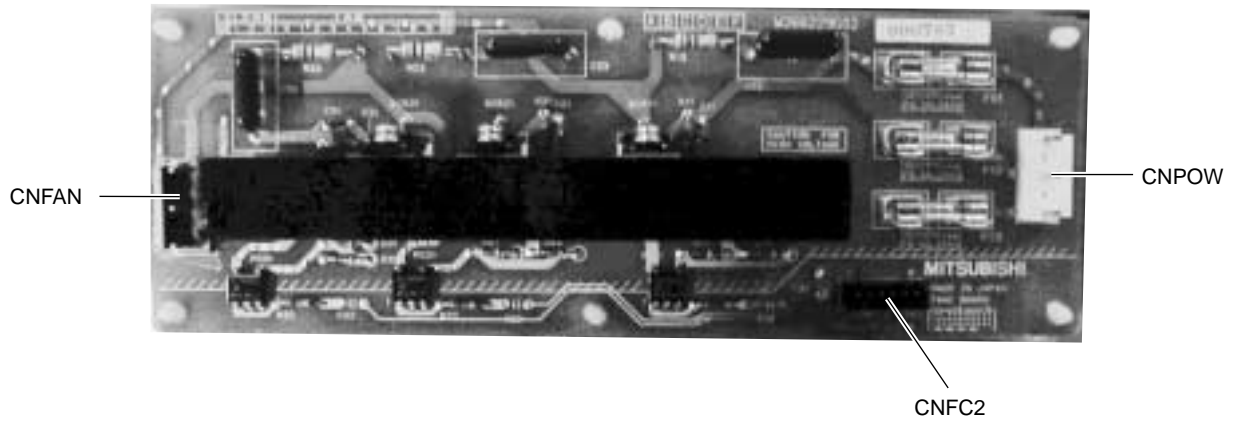

G/A board

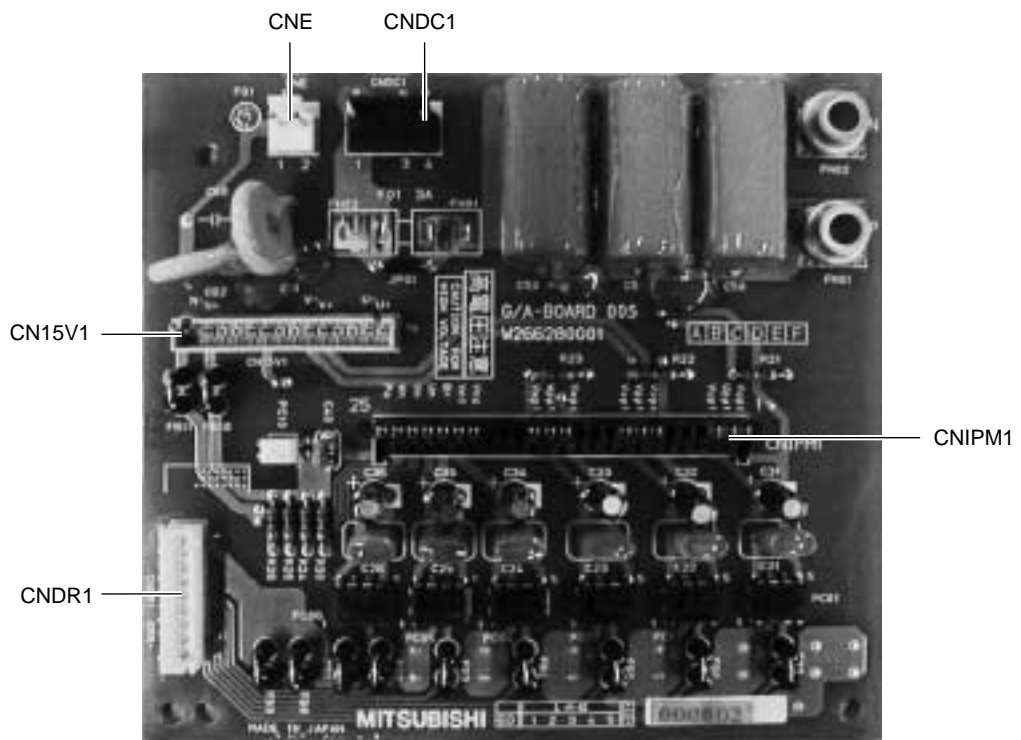

BC controller

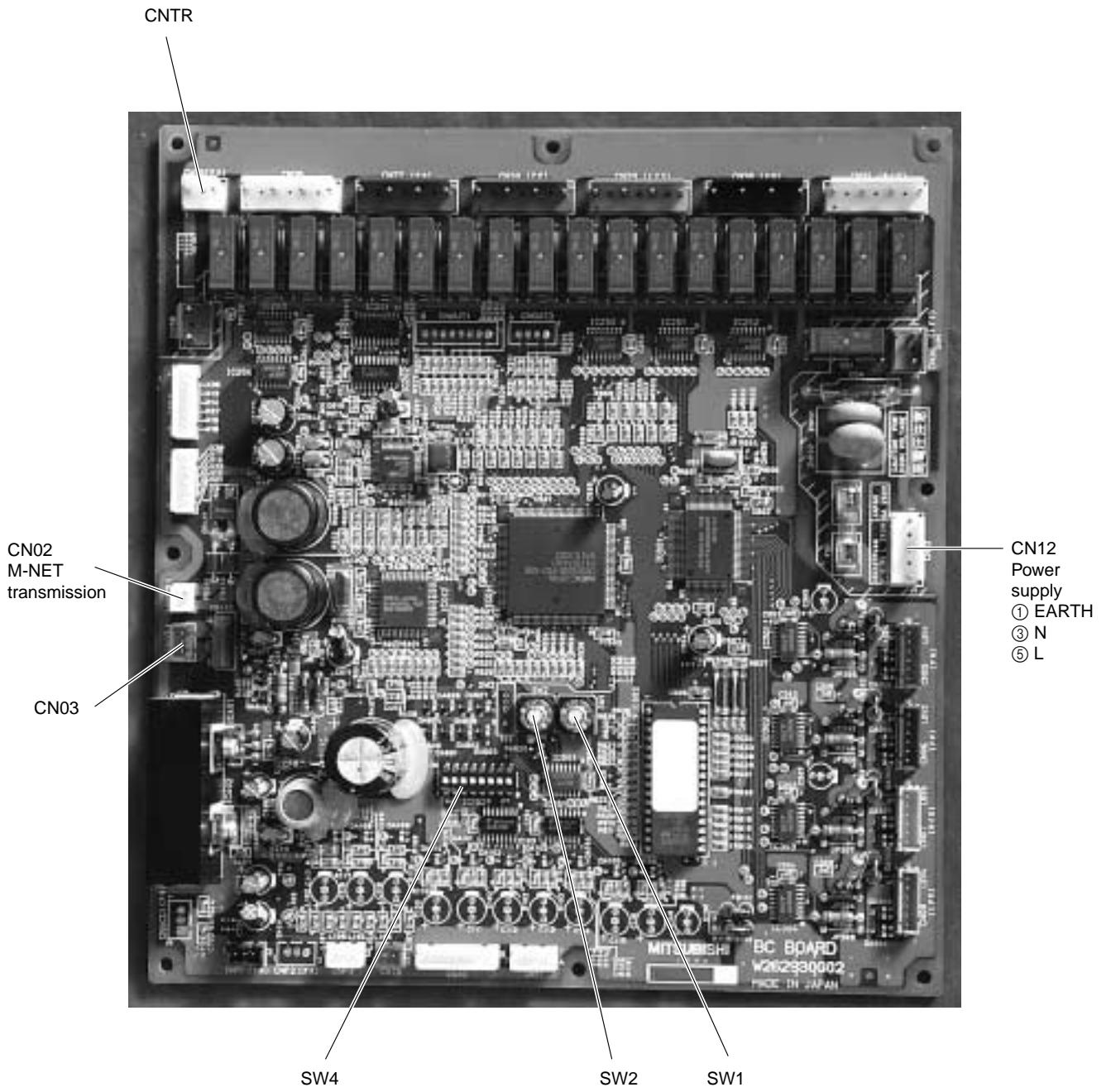



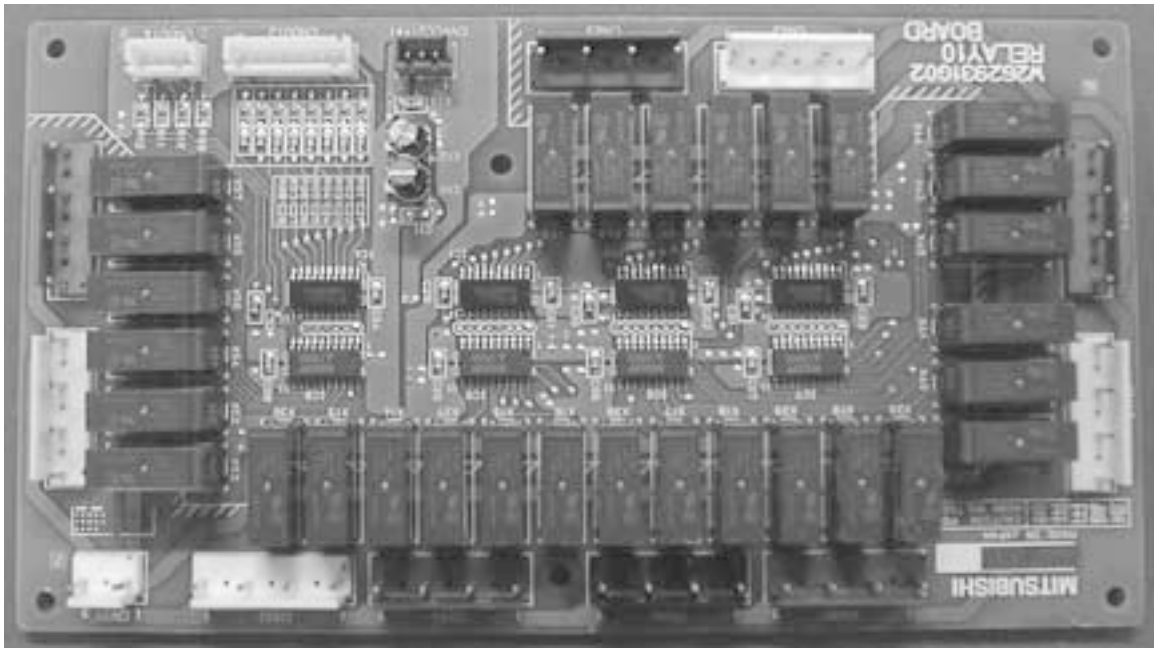

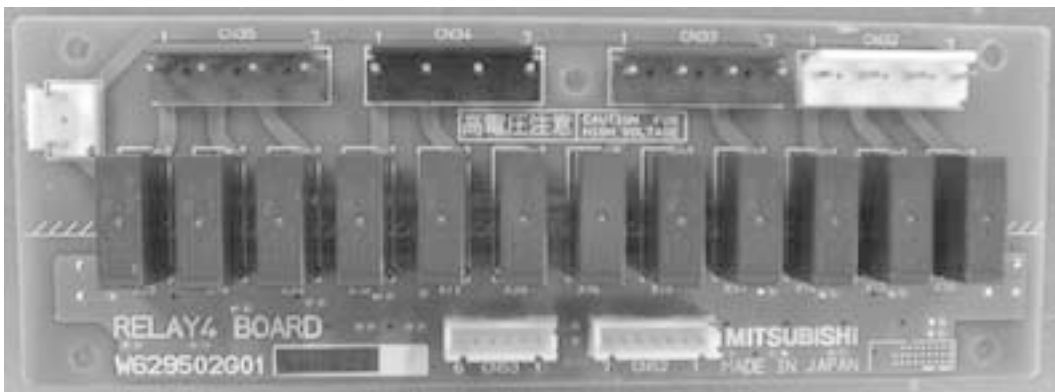

RELAY 10 board



RELAY 4 board







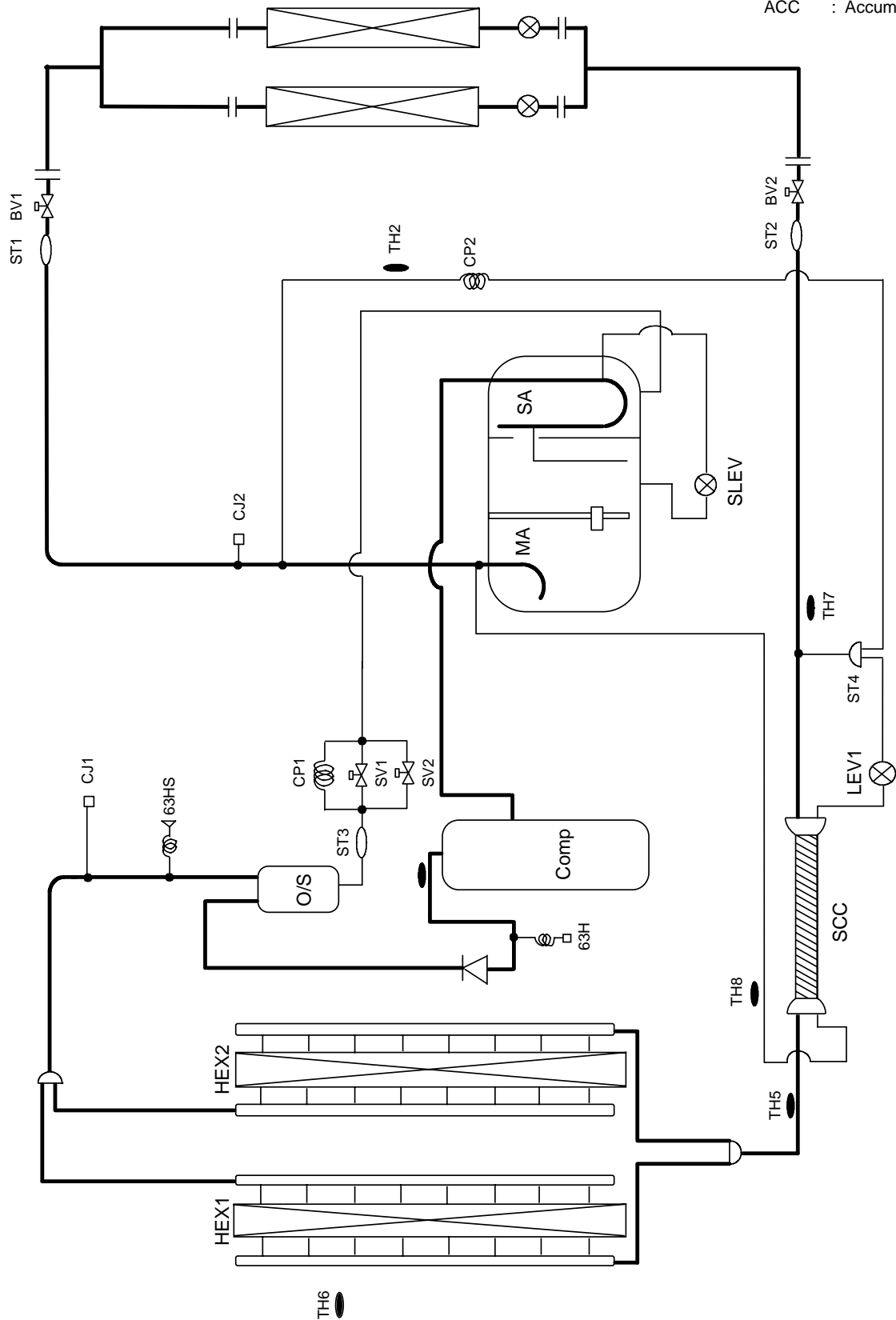

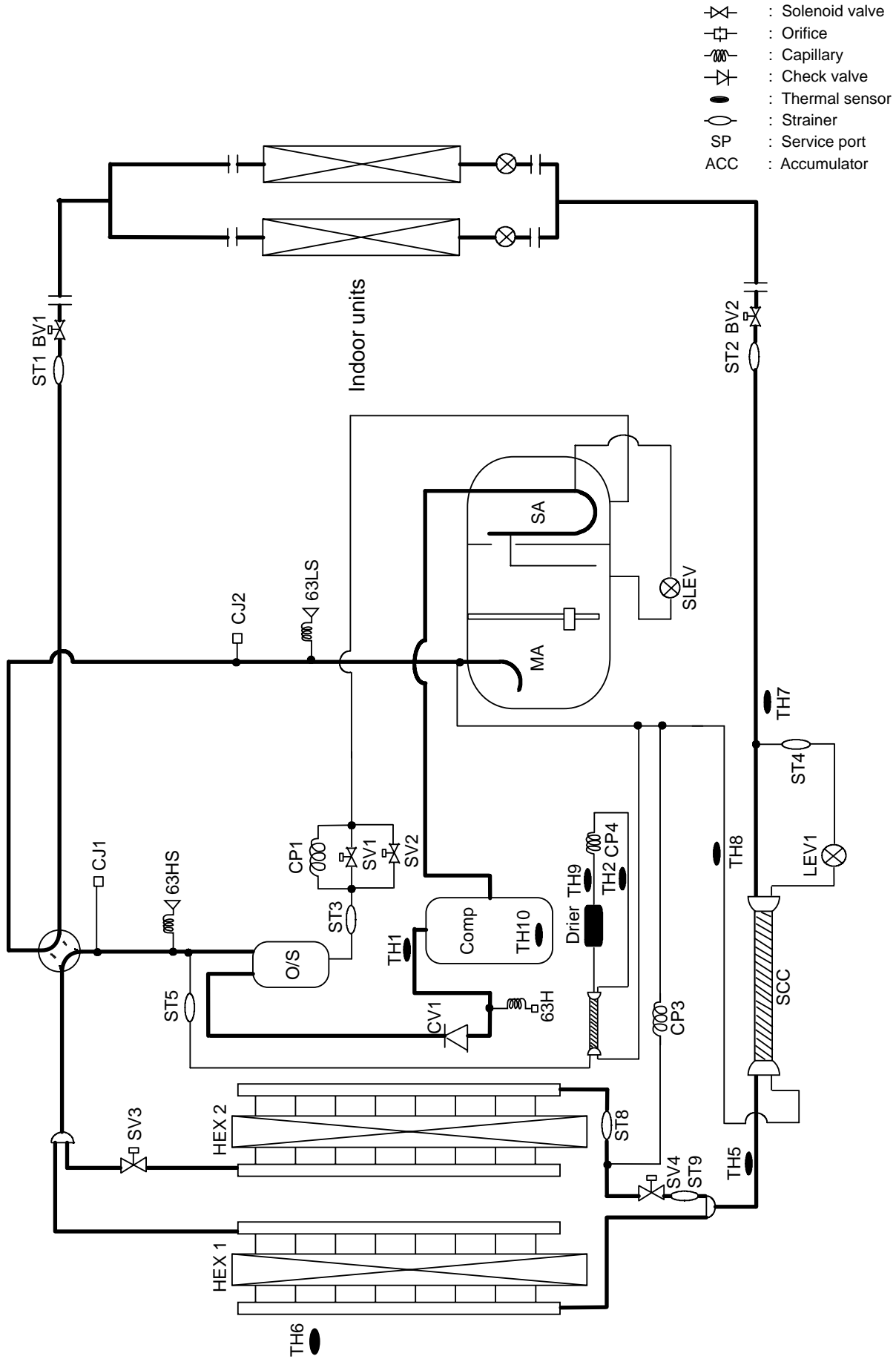

② PUY-200YMF-C, 250YMF-C

-  : Solenoid valve
-  : Orifice
-  : Capillary
-  : Check valve
-  : Thermal sensor
-  : Strainer
- SP : Service port
- ACC : Accumulator











③ PUHY-P200YMF-C, P250YMF-C



-  : Solenoid valve
-  : Orifice
-  : Capillary
-  : Check valve
-  : Thermal sensor
-  : Strainer
-  : Service port
-  : Accumulator

⑥ PURY-P200YMF-C, P250YMF-C

-  : Solenoid valve
-  : Orifice
-  : Capillary
-  : Check valve
-  : Thermal sensor
-  : Strainer
-  : Service port
-  : Accumulator

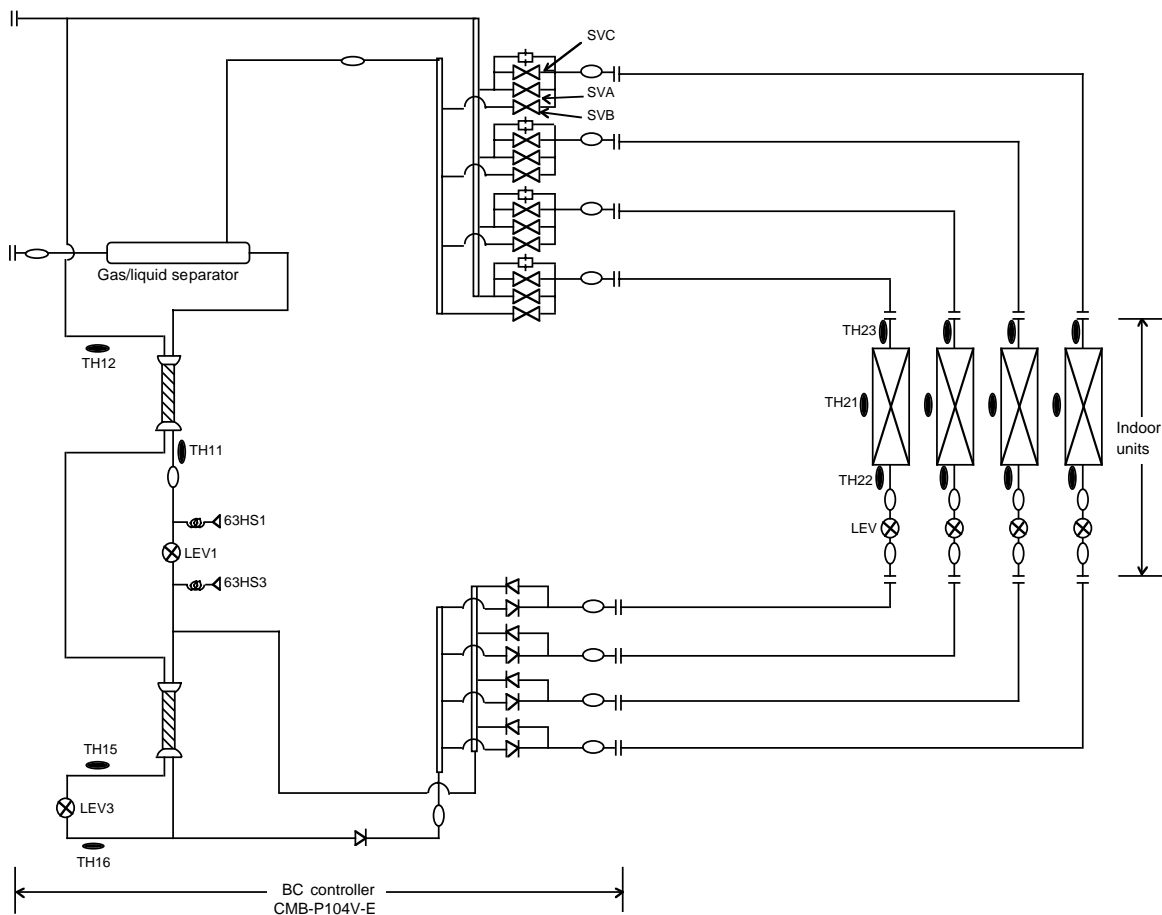
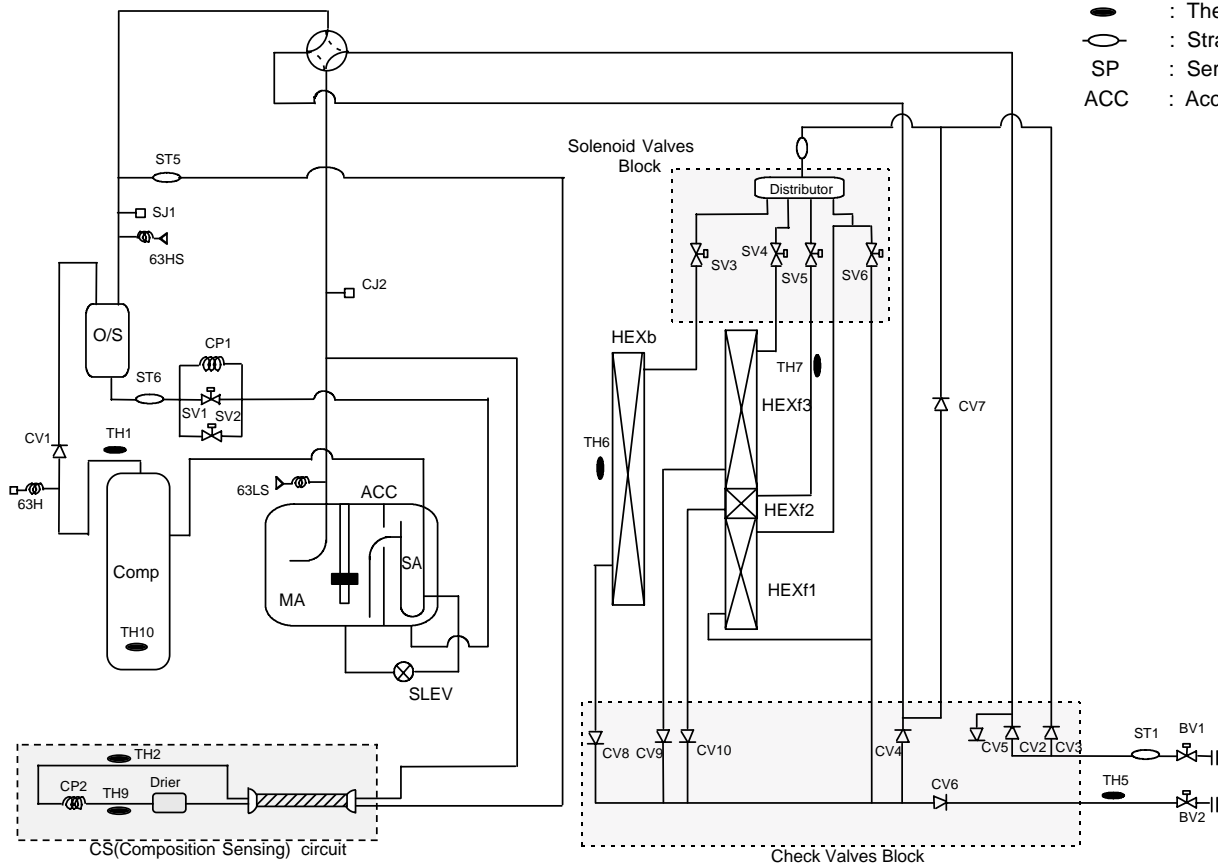

[3] Electrical Wiring Diagram

① PU(H)Y-(P)200-250YMF-C

<Difference of appliance>

Appliance	Name
PUHY-P200/250YMF-C	All exists
PUHY-P200/250YMF-C	*"1" are not existed
PUHY- 200/250YMF-C	*"2" are not existed
PUY - 200/250YMF-C	*"1" and *"2" are not existed

<Symbol explanation>

Symbol	Name
DCL	DC reactor (Power factor improvement)
ACCT-U, W	Current Sensor
ZNR4	Varistor
52C	Magnetic contactor (Inverter main circuit)
MF1	Fan motor (Radiator panel)
21S4 *1	4-way valve
SV1, SV2	Solenoid valve (Discharge-suction bypass)
SV3 *2	Solenoid valve (Heat exchanger capacity control)
SV4 *1, *2	Solenoid valve (Heat exchanger capacity control)
LEV1	Electronic expansion valve (Sub-cool coil bypass)
SLEV	Electronic expansion valve (Oil return)
63LS *2	High pressure sensor
L2	Choke coil (Transmission)
IPM	Intelligent power module
TH1	Thermistor
TH2	Discharge pipe temp. detect
TH5	Saturation evapo. temp. detect
TH6	Pipe temp. detect
TH7	O.A temp. detect
TH8	liquid outlet temp. detect at Sub-cool coil bypass outlet temp. detect at Sub-cool coil
TH9 *2	High pressure liquid temp.
TH10 *2	Compressor shell temp.
THHS	Radiator panel temp. detect
LD	Accumulator liquid level detect
X1-10	Aux. relay
FB1-4	Ferrite core
⊕	Earth terminal

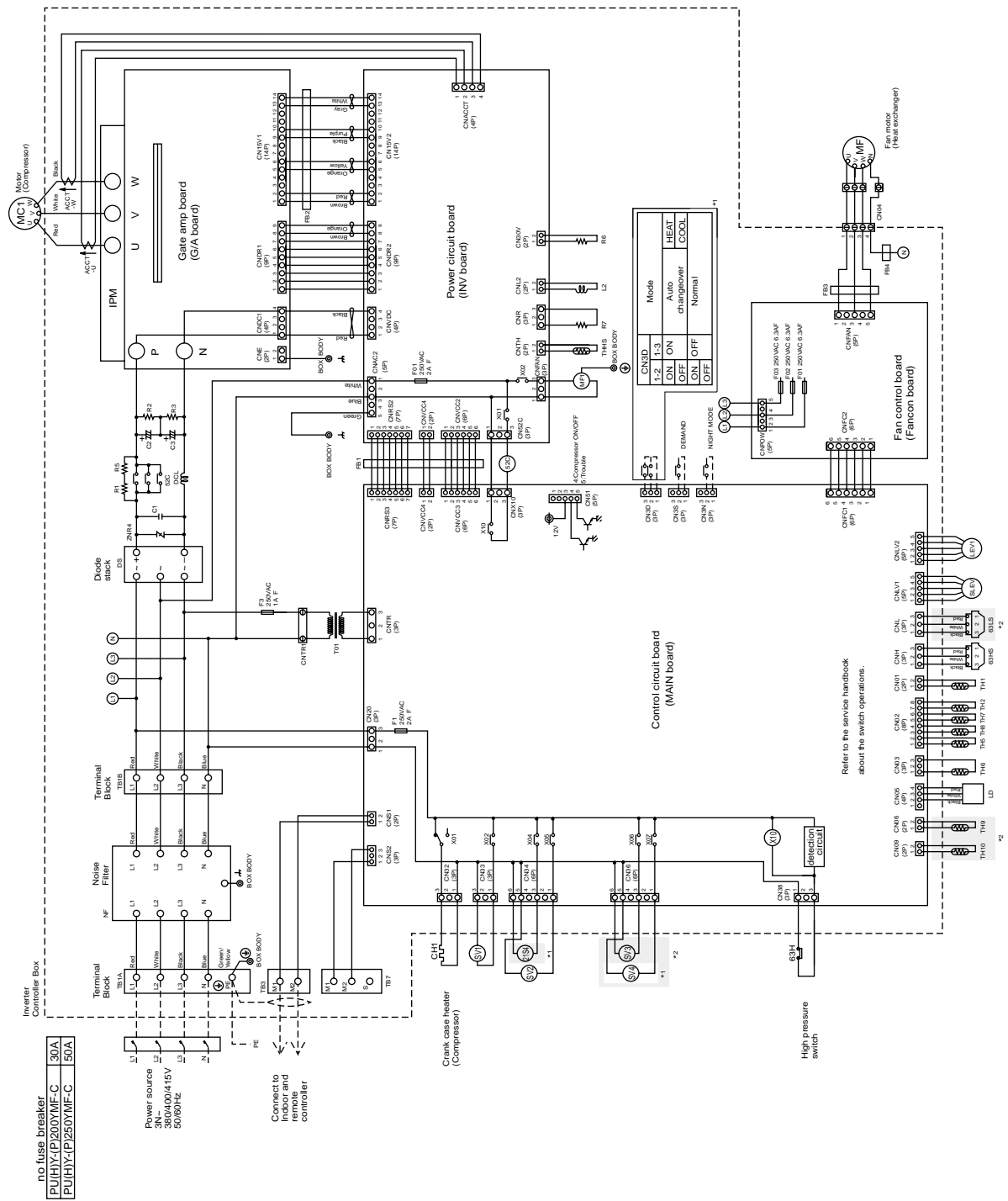

no fuse breaker
 PUHY-P200YMF-C 30A
 PUHY-P250YMF-C 50A

Power source
 3N 380/400/415V
 50/60Hz

Connect to
 indoor and
 outdoor
 controller

Crank case heater
 (Compressor)

High pressure
 switch

Refer to the service handbook
 about the switch operations.

② PURY-(P)200-250YMF-C

<Difference of appliance>

Appliance	Name
PURY-P200/250YMF-C	All exists
PURY-(P)200/250YMF-C	"*,1" are not existed

<Symbol explanation>

Symbol	Name
DCL	DC reactor (Power factor improvement)
ACCT-U, W	Current Sensor
ZNR4	Varistor
52C	Magnetic contactor (Inverter main circuit)
MF1	Fan motor (Radiator panel)
21S4	4-way valve
SV1, SV2	Solenoid valve (Discharge-suction bypass)
SV3-6	Solenoid valve (Heat exchanger capacity control)
SLEV	Electronic expansion valve (Oil return)
63HS	High pressure sensor
63LS	Low pressure sensor
L2	Choke coil (Transmission)
IPM	Intelligent power module
TH1	Thermistor Discharge pipe temp. detect
TH2	Saturation evapo. temp. detect
TH5	Pipe temp. detect
TH6	OA temp. detect
TH7	liquid outlet temp. detect at Sub-cool coil
TH9	*1 High pressure liquid temp.
TH10	*1 Compressor shell temp.
THHS	Radiator panel temp. detect
LD	Accumulator liquid level detect
X1, 2, 4-10	Aux. relay
FB1-4	Ferrite core
⊕	Earth terminal

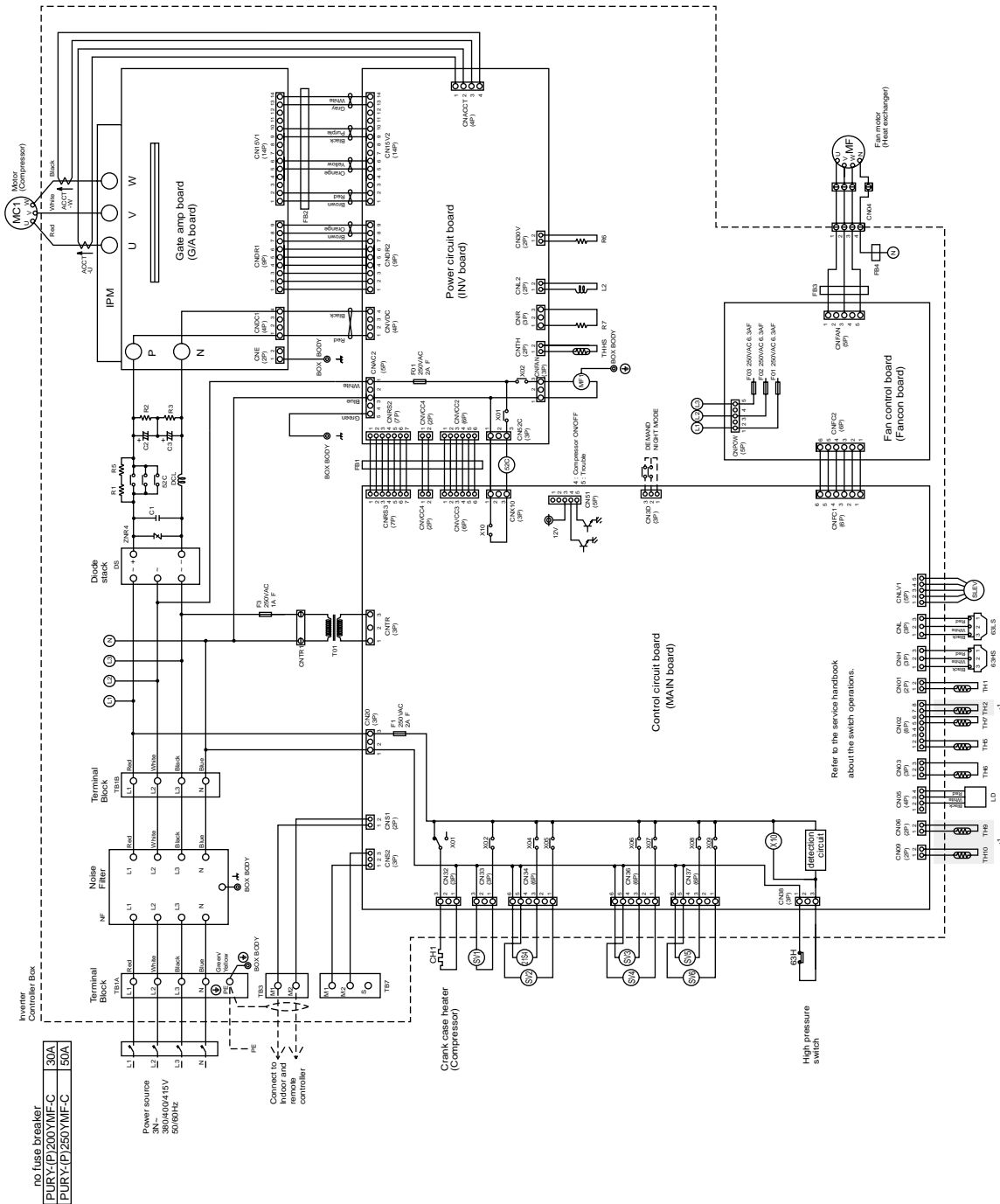

③ CMB-P104V-E

Symbol explanation

Symbol	Name	Symbol	Name
TR	Transformer	SV1 ~ 4A	Solenoid valve
TH11 ~ 16	Thermister sensor	SV1 ~ 4B	Solenoid valve
LEV1,3	Expansion valve	SV1 ~ 4C	Solenoid valve
PS1,3	Pressure sensor	SVM *1	Solenoid valve
TB01	Terminal block (for power source)		
TB02	Terminal block (for Transmission)		

Note:1.TB02 is terminal block for transmission.
Never connect power line to it.
2.*1:SVM is not built in depending on models.

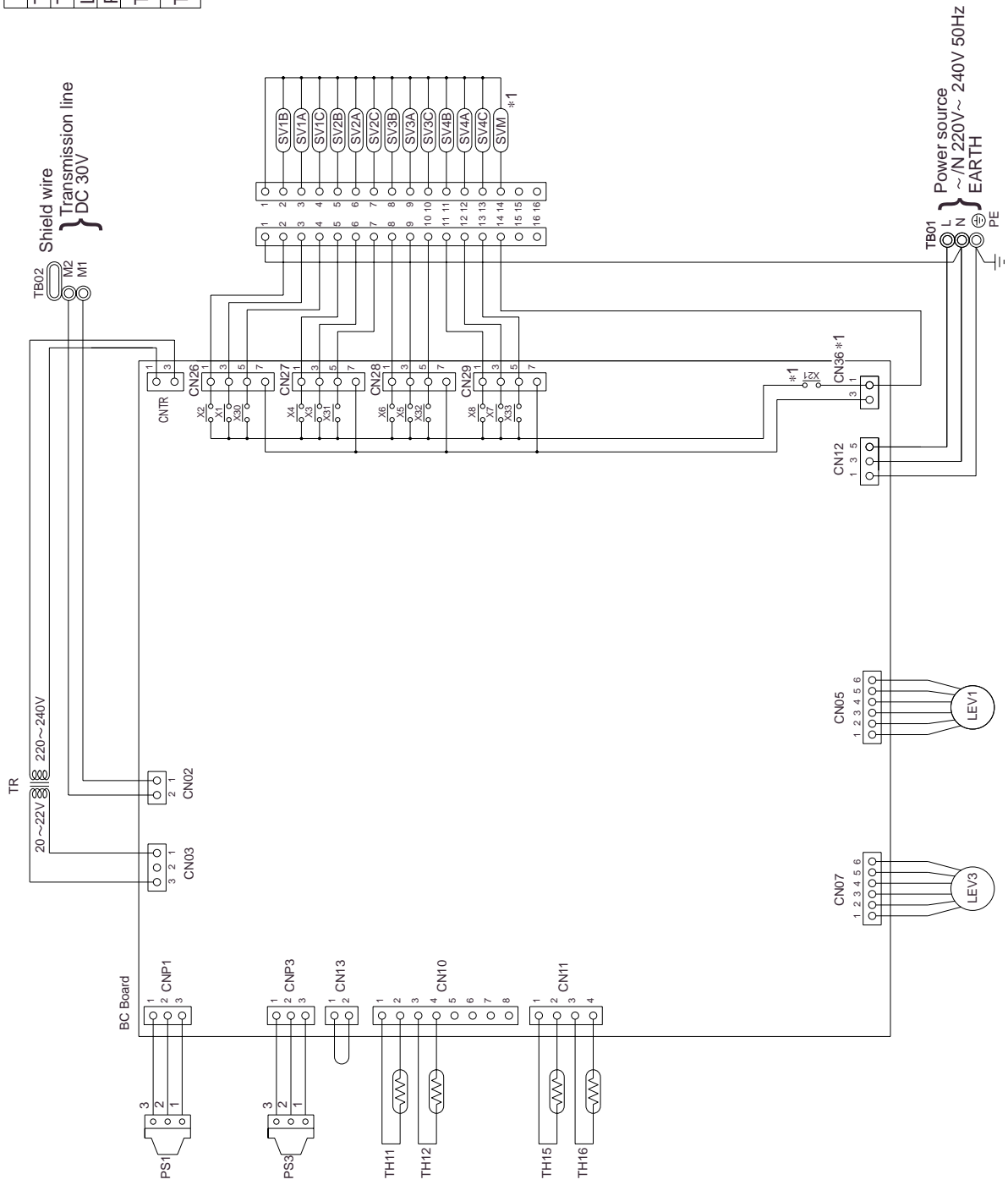

Symbol explanation

Symbol	Name	Symbol	Name
TR	Transformer	SV1 ~ 5A	Solenoid valve
TH11 ~ 16	Thermister sensor	SV1 ~ 5B	Solenoid valve
LEV1,3	Expansion valve	SV1 ~ 5C	Solenoid valve
PS1,3	Pressure sensor	SVM *1	Solenoid valve
TB01	Terminal block (for power source)		
TB02	Terminal block (for Transmission)		

Note:1.TB02 is terminal block for transmission.
Never connect power line to it.
2.*1:SVM is not built in depending on models.

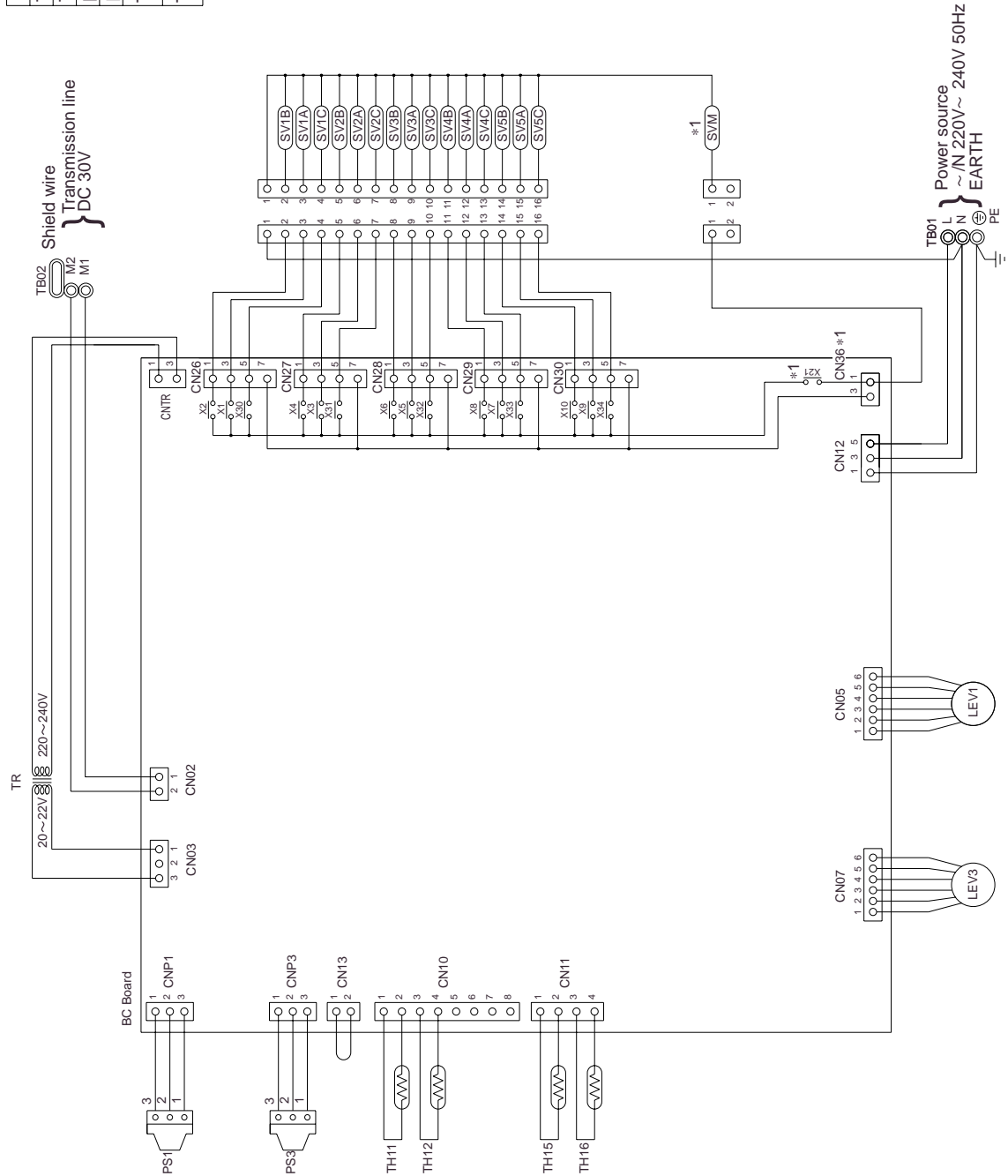

⑤ CMB-P106V-E

Symbol explanation

Symbol	Name	Symbol	Name
TR	Transformer	SV1 ~ 6A	Solenoid valve
TH11 ~ 16	Thermister sensor	SV1 ~ 6B	Solenoid valve
LEV1,3	Expansion valve	SV1 ~ 6C	Solenoid valve
PS1,3	Pressure sensor	SVM *1	Solenoid valve
TB01	Terminal block (for power source)		
TB02	Terminal block (for Transmission)		

Note:1.TB02 is terminal block for transmission.
Never connect power line to it.

2.*1:SVM is not built in depending on models.

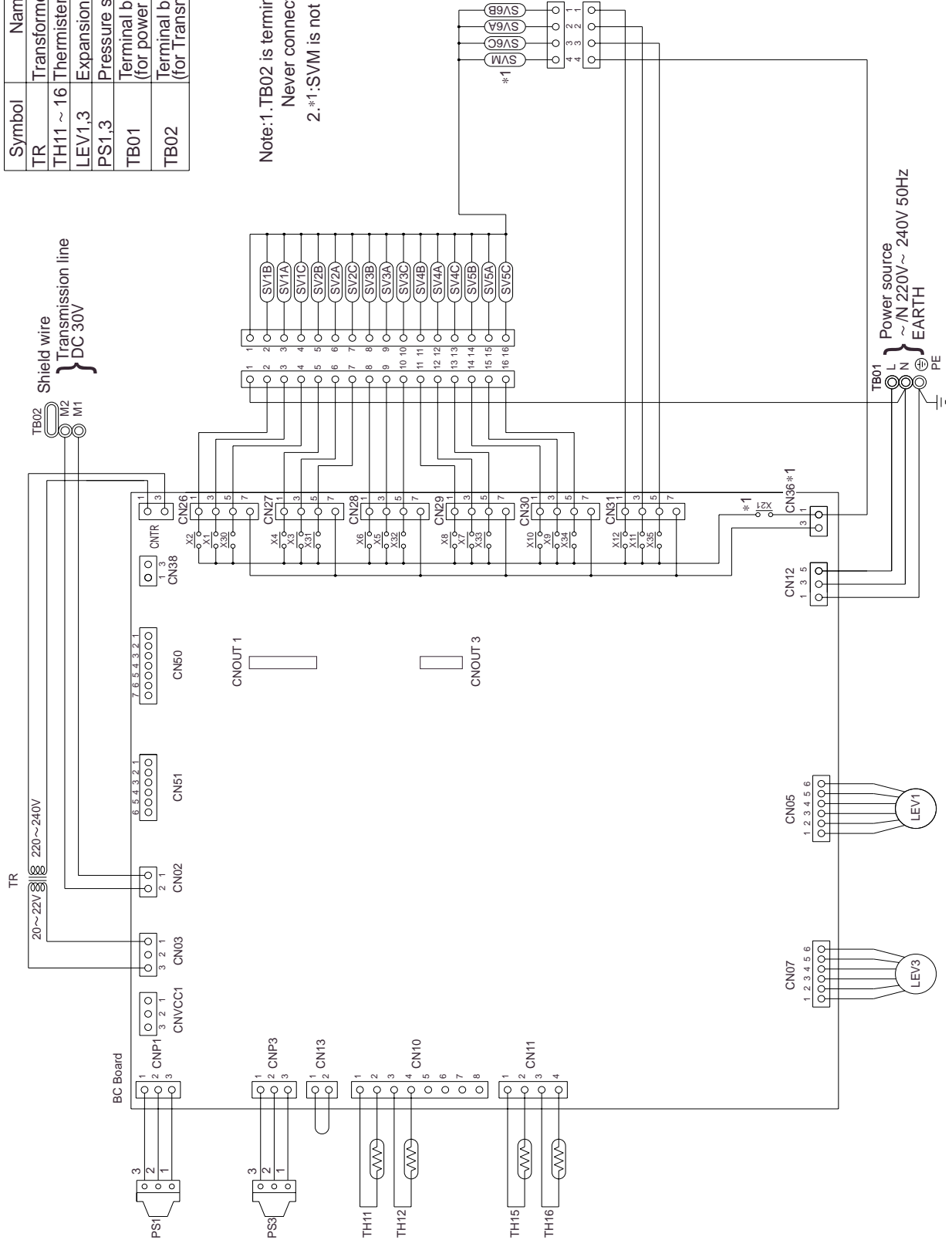

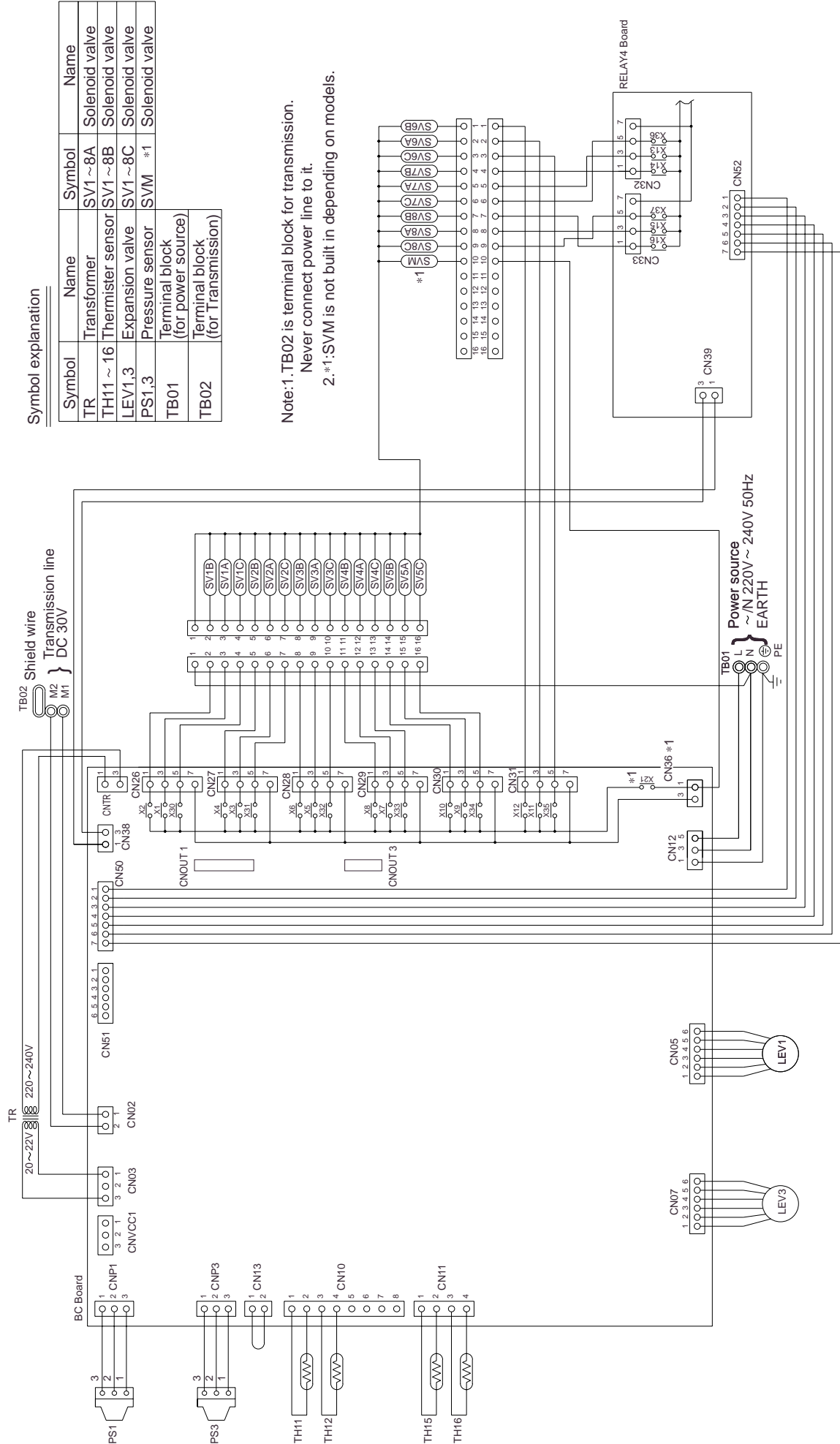

Symbol explanation

Symbol	Name	Symbol	Name
TR	Transformer	SV1 ~ 8A	Solenoid valve
TH11 ~ 16	Thermister sensor	SV1 ~ 8B	Solenoid valve
LEV1,3	Expansion valve	SV1 ~ 8C	Solenoid valve
PS1,3	Pressure sensor	SVM #1	Solenoid valve
TB01	Terminal block (for power source)		
TB02	Terminal block (for Transmission)		

Note:1. TB02 is terminal block for transmission.
Never connect power line to it.
2. #1: SVM is not built in depending on models.

⑦ CMB-P1010V-E

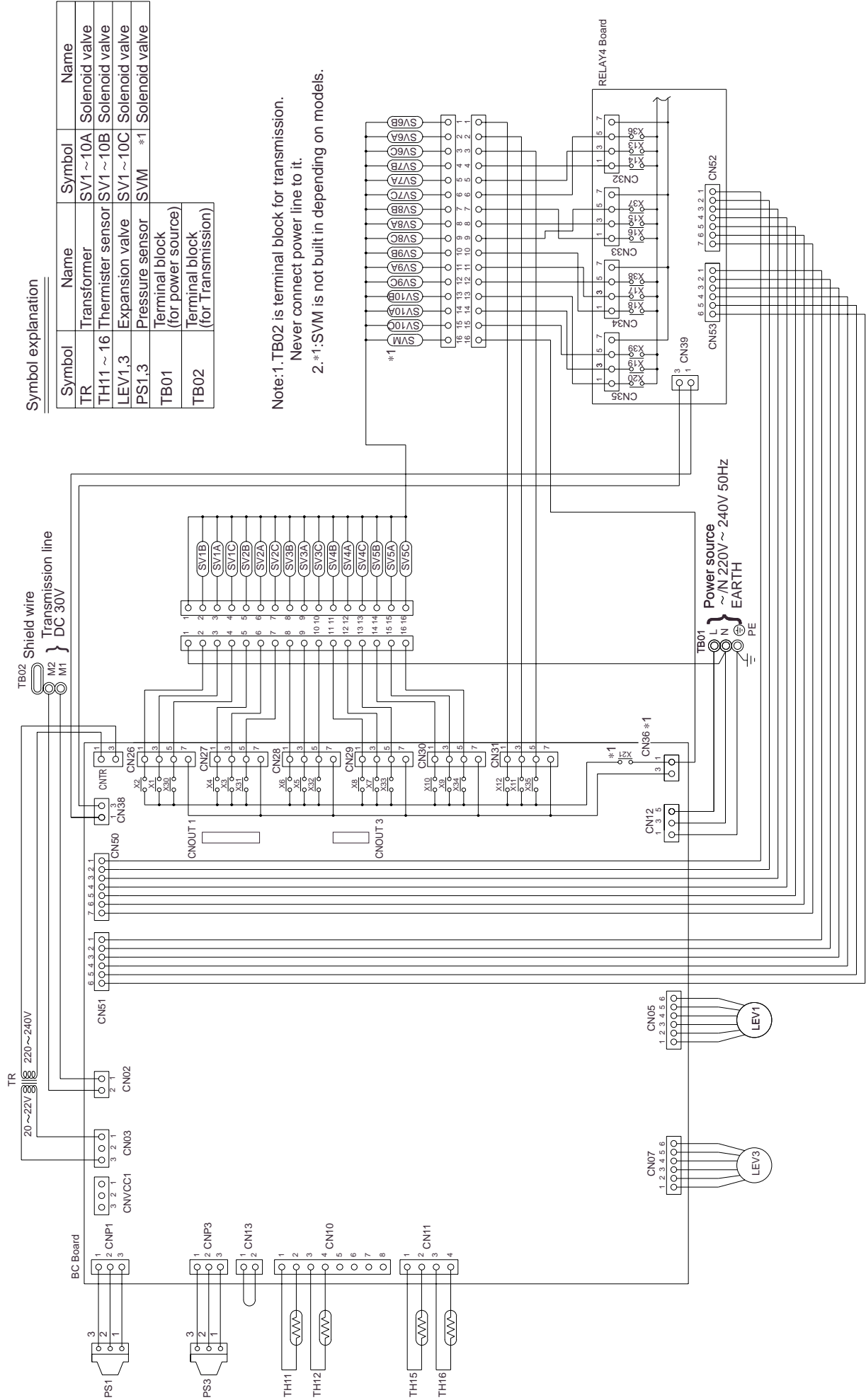

Symbol explanation

Symbol	Name	Symbol	Name
TR	Transformer	SV1 ~ 10A	Solenoid valve
TH11 ~ 16	Thermister sensor	SV1 ~ 10B	Solenoid valve
LEV1,3	Expansion valve	SV1 ~ 10C	Solenoid valve
PS1,3	Pressure sensor	SVM *1	Solenoid valve
TB01	Terminal block (for power source)		
TB02	Terminal block (for Transmission)		

Note:1. TB02 is terminal block for transmission.
Never connect power line to it.
2. *1: SVM is not built in depending on models.

Symbol	Name	Symbol	Name
TR	Transformer	TB01	Terminal block (for power source)
TH11~16	Thermister sensor	TB02	Terminal block (for Transmission)
LEV1,3	Expansion valve	SV1~13A	Solenoid valve
PS1,3	Pressure sensor	SV1~13B	Solenoid valve
		SV1~13C	Solenoid valve
		SVM *1	Solenoid valve

Note : 1. TB02 is transmission terminal block.
Never connect power line to it.

2. *1:SVM is not built in depending on models.

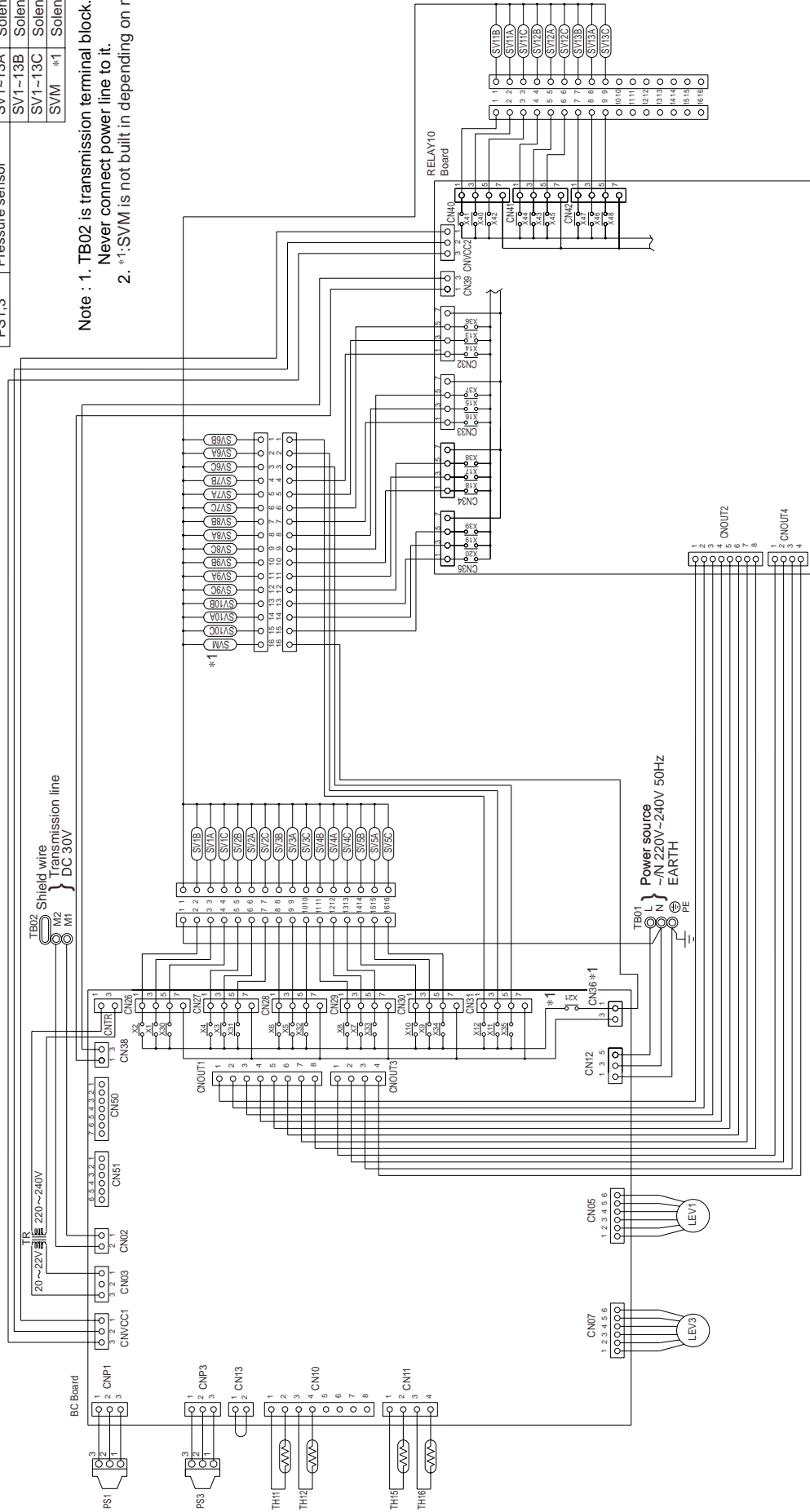

Symbol	Name	Symbol	Name
TR	Transformer	TB01	Terminal block (for power source)
TH11~16	Thermister sensor	TB02	Terminal block (for Transmission)
LEV1,3	Expansion valve	SV1~16A	Solenoid valve
PS1,3	Pressure sensor	SV1~16B	Solenoid valve
		SV1~16C	Solenoid valve
		SVM *1	Solenoid valve

Note : 1. TB02 is transmission terminal block.

Never connect power line to it.

2. *1:SVM is not built in depending on models.

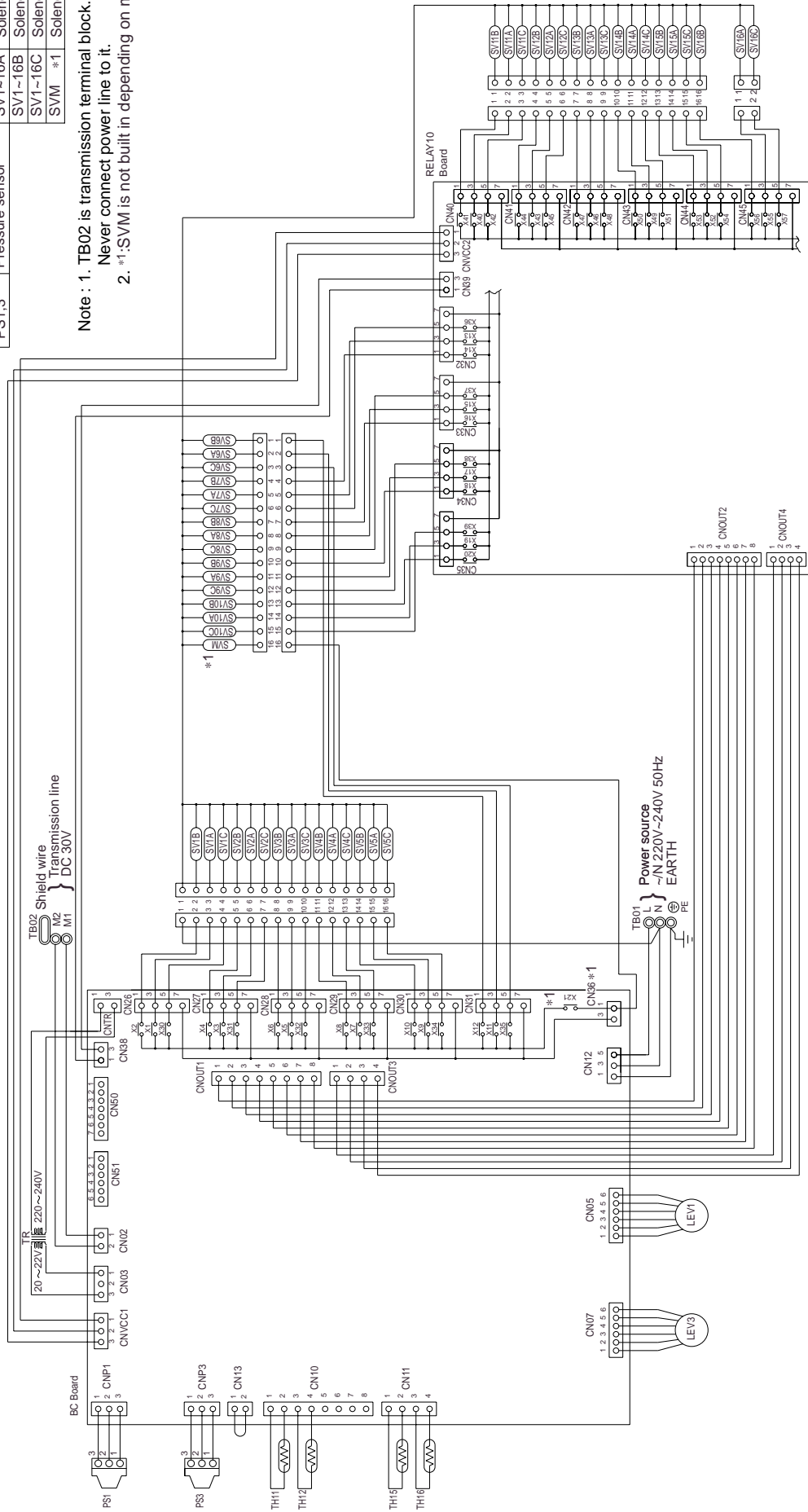

[4] Standard Operation Data

(1) Cooling operation

① PU(H)Y-200-250YMF-C

Items			Outdoor unit	PUHY-200YMF-C PUY-200YMF-C				PUHY-250YMF-C PUY-250YMF-C				
Condition	Ambient temp.	Indoor	DB/WB	27.0/19.0				27.0/19.0				
		Outdoor		35.0/24.0				35.0/24.0				
	Indoor unit	Quantity	Set	4				4				
		Quantity in operation		4				4				
		Model	—	63	63	50	25	125	40	63	25	
	Piping	Main pipe	m	5				5				
		Branch pipe		10	10	10	10	10	10	10	10	
		Total piping length		45				45				
	Indoor unit fan notch		—	Hi	Hi	Hi	Hi	Hi	Hi	Hi	Hi	
	Refrigerant volume		kg	11.2				12.7				
Outdoor unit	Total current		A	14.5		13.3		18.3		16.8		
	Volts/Frequency		V	380		415		380		415		
			V/Hz	270/75		270/75		340/95		340/95		
LEV opening	Indoor unit		Pulse	440	440	380	280	430	350	440	280	
	SC (LEV1)			130				140				
	Oil return (SLEV)			235				235				
Pressure	High pressure/Low pressure (after O/S) (before MA)		kg/cm ² G (MPa)	22.0/4.80 (2.16/0.47)				20.3/4.7 (1.99/0.46)				
Sectional temperature	Outdoor unit	Discharge (TH1)		°C	93				95			
		Heat exchanger outlet (TH5)			40				42			
		Accumulator	Inlet		7				5			
			Outlet		9				7			
		Suction (Comp)			7				10			
		TH2			6				4			
		Shell bottom (Comp)			69				60			
		SCC outlet (TH7)			27				27			
		Bypass outlet (TH8)			8				6			
	Indoor unit	LEV inlet			26				26			
Heat exchanger outlet		10				10						

Items			Outdoor unit	PUHY-P200YMF-C PUY-P200YMF-C				PUHY-P250YMF-C PUY-P250YMF-C				
Condition	Ambient temp.	Indoor	DB/WB	27.0/19.0				27.0/19.0				
		Outdoor		35.0/24.0				35.0/24.0				
	Indoor unit	Quantity	Set	4				4				
		Quantity in operation		4				4				
		Model	-	63	63	50	25	125	40	63	25	
	Piping	Main pipe	m	5				5				
		Branch pipe		10	10	10	10	10	10	10	10	
		Total piping length		45				45				
	Indoor unit fan notch		-	Hi	Hi	Hi	Hi	Hi	Hi	Hi	Hi	
	Refrigerant volume		kg	11.7				13.2				
Outdoor unit	Total current		A	14.5		13.3		18.3		16.8		
	Volts/Frequency		V	380		415		380		415		
			V/Hz	270/75		270/75		340/95		340/95		
LEV opening	Indoor unit		Pulse	440	440	380	280	430	350	440	280	
	SC (LEV1)			130				140				
	Oil return (SLEV)			235				235				
Pressure	High pressure/Low pressure (after O/S) (before MA)		kg/cm ² G (MPa)	20.5/4.0 (2.01/0.39)				21.9/3.9 (2.15/0.38)				
Sectional temperature	Outdoor unit	Discharge (TH1)		°C	96				96			
		Heat exchanger outlet (TH5)			40				42			
		Accumulator	Inlet		7				7			
			Outlet		10				10			
		Suction (Comp)			12				15			
		CS circuit (TH2)			-1				-1			
		CS circuit (TH9)			11				11			
		Shell bottom (Comp)			80				85			
		SCC outlet (TH7)			27				27			
		Bypass outlet (TH8)			8				6			
	Indoor unit	LEV inlet			26				26			
Heat exchanger outlet		10				10						
αOC				0.23				0.23				

PURY-200-250YMF-C

Items			Outdoor unit		PURY-P200YMF-C				PURY-P250YMF-C			
Condition	Ambient temp.	Indoor	DB/WB	27.0/19.0				27.0/19.0				
		Outdoor		35.0/24.0				35.0/24.0				
	Indoor unit	Quantity	Q'ty	4				4				
		Quantity in operation		4				4				
		Model	–	63	63	50	25	125	40	63	25	
	Piping	Main pipe	m	5				5				
		Branch pipe		5	5	5	5	5	5	5	5	
		Total piping length		25				25				
	Indoor unit fan notch		–	Hi	Hi	Hi	Hi	Hi	Hi	Hi	Hi	Hi
	Refrigerant volume		kg	13.9				14.4				
Compressor volts / Frequency		V	380		415		380		415			
		V/Hz	270/75		270/75		340/95		340/95			
Outdoor unit		A	14.5		13.3		18.3		16.8			
LEV opening	Indoor unit		Pulse	330	460	430	300	410	330	460	300	
	BC controller (1, 3)			2000		140		2000		150		
	Oil return			235				235				
Pressure	High pressure/Low pressure		kg/cm ² G (MPa)	20.7/5.0 (2.03/0.49)				19.4/4.0 (1.90/0.39)				
	BC controller liquid/Intermediate			19.6/19.6 (1.92/1.92)				18.3/18.3 (1.79/1.79)				
Sectional temperature	Outdoor unit	Discharge (TH1)		°C	107				110			
		Heat exchanger outlet (TH5)			50				47			
		Accumulator	Inlet		7				7			
			Outlet		10				10			
		Suction (Comp)			12				12			
		Shell bottom (Comp)			75				70			
	Indoor unit	LEV inlet			26				30			
		Heat exchanger outlet			15				15			

PURY-P200-250YMF-C

Items			Outdoor unit		PURY-P200YMF-C				PURY-P250YMF-C			
Condition	Ambient temp.	Indoor	DB/WB	27.0/19.0				27.0/19.0				
		Outdoor		35.0/24.0				35.0/24.0				
	Indoor unit	Quantity	Q'ty	4				4				
		Quantity in operation		4				4				
		Model	-	63	63	50	25	125	40	63	25	
	Piping	Main pipe	m	5				5				
		Branch pipe		5	5	5	5	5	5	5	5	
		Total piping length		25				25				
	Indoor unit fan notch		-	Hi	Hi	Hi	Hi	Hi	Hi	Hi	Hi	Hi
	Refrigerant volume		kg	14.4				14.9				
Compressor volts / Frequency		V	380		415		380		415			
		V/Hz	270/75		270/75		340/95		340/95			
Outdoor unit		A	14.5		13.3		18.3		16.8			
LEV opening	Indoor unit		Pulse	330	460	430	300	410	330	460	300	
	BC controller (1, 3)			2000		140		2000		150		
	Oil return			235				235				
Pressure	High pressure/Low pressure		kg/cm ² G (MPa)	23.5/5.3 (2.30/0.52)				23.0/5.1 (2.25/0.50)				
	BC controller liquid/Intermediate			22.4/22.4 (2.20/2.20)				21.9/21.9 (2.15/2.15)				
Sectional temperature	Outdoor unit	Discharge (TH1)		°C	97				105			
		Heat exchanger outlet (TH5)			50				47			
		Accumulator	Inlet		7				7			
			Outlet		10				10			
		Suction (Comp)			12				12			
		CS circuit (TH2)			7				5			
		Shell bottom (Comp)			75				70			
	Indoor unit	LEV inlet			26				30			
		Heat exchanger outlet			15				15			
αOC			0.23				0.23					

② Heating operation
PUHY-200-250YMF-C

Items			Outdoor unit		PUHY-200YMF-C				PUHY-250YMF-C			
Condition	Ambient temp.	Indoor	DB/WB	20.0/-				20.0/-				
		Outdoor		7.0/6.0				7.0/6.0				
	Indoor unit	Quantity	Set	4				4				
		Quantity in operation		4				4				
		Model	-	63	63	50	25	125	40	63	25	
	Piping	Main pipe	m	5				5				
		Branch pipe		10	10	10	10	10	10	10	10	
		Total piping length		45				45				
	Indoor unit fan notch		-	Hi	Hi	Hi	Hi	Hi	Hi	Hi	Hi	Hi
	Refrigerant volume		kg	11.2				12.7				
Outdoor unit	Total current		A	13.4		12.3		17.1		15.6		
	Volts/Frequency		V	380		415		380		415		
			V/Hz	280/83		280/83		355/102		355/102		
LEV opening	Indoor unit		Pulse	510	510	450	280	440	420	510	280	
	SC (LEV1)			0				0				
	Oil return (SLEV)			150				235				
Pressure	High pressure/Low pressure (after O/S) (before MA)		kg/cm ² G (MPa)	17.5/3.7 (1.72/0.36)				17.5/3.7 (1.72/0.36)				
Sectional temperature	Outdoor unit	Discharge (TH1)		°C	80				85			
		Heat exchanger outlet (TH5)			6				8			
		Accumulator	Inlet		-1				-2			
			Outlet		-1				-2			
		Suction (Comp)			-1				-2			
		TH2			-2				-2			
		Shell bottom (Comp)			50				60			
	Indoor unit	Heat exchanger outlet			71				71			
		LEV inlet			33				33			

Items			Outdoor unit				PUHY-P200YMF-C				PUHY-P250YMF-C			
Condition	Ambient temp.	Indoor	DB/WB	20.0/-				20.0/-						
		Outdoor		7.0/6.0				7.0/6.0						
	Indoor unit	Quantity	Set	4				4						
		Quantity in operation		4				4						
		Model	-	63	63	50	25	125	40	63	25			
	Piping	Main pipe	m	5				5						
		Branch pipe		10	10	10	10	10	10	10	10			
		Total piping length		45				45						
	Indoor unit fan notch		-	Hi	Hi	Hi	Hi	Hi	Hi	Hi	Hi	Hi		
	Refrigerant volume		kg	11.7				13.2						
Outdoor unit	Total current		A	13.4		12.3		17.1		15.6				
	Volts/Frequency		V	380		415		380		415				
			V/Hz	270/75		270/75		340/95		340/95				
LEV opening	Indoor unit		Pulse	510	510	450	280	440	420	510	280			
	SC (LEV1)			0				0						
	Oil return (SLEV)			150				150						
Pressure	High pressure/Low pressure (after O/S) (before MA)		kg/cm ² G (MPa)	18.5/3.7 (1.81/0.36)				21.4/3.7 (2.10/0.36)						
Sectional temperature	Outdoor unit	Discharge (TH1)		°C	75				78					
		Heat exchanger inlet (TH5)			-1				-1					
		Accumulator	Inlet		-2				-2					
			Outlet		-2				-2					
		Suction (Comp)			-3				-3					
		CS circuit (TH2)			-3				-3					
		CS circuit (TH9)			0				0					
		Shell bottom (Comp)			60				70					
	Indoor unit	Heat exchanger outlet			80				80					
		LEV inlet			39				39					
αOC				0.28				0.28						

PURY-200-250YMF-C

Items			Outdoor unit	PURY-200YMF-C				PURY-250YMF-C				
Condition	Ambient temp.	Indoor	DB/WB	20.0/-				20.0/-				
		Outdoor		7.0/6.0				7.0/6.0				
	Indoor unit	Quantity	Q'ty	4				4				
		Quantity in operation		4				4				
		Model	-	63	63	50	25	125	40	63	25	
	Piping	Main pipe	m	5				5				
		Branch pipe		5	5	5	5	5	5	5	5	
		Total piping length		25				25				
	Indoor unit fan notch		-	Hi	Hi	Hi	Hi	Hi	Hi	Hi	Hi	
	Refrigerant volume		kg	13.9				14.4				
Compressor volts / Frequency		V	380		415		380		415			
		V/Hz	285/85		285/85		360/105		360/105			
Outdoor unit total current		A	13.4		12.3		17.1		15.6			
LEV opening	Indoor unit		Pulse	600	950	750	400	750	600	950	400	
	BC controller (1, 3)			60	700		60	800				
	Oil return			150				235				
Pressure	High pressure/Low pressure		kg/cm ² G (MPa)	18.5/3.6 (1.81/0.35)				18.0/3.7 (1.76/0.36)				
	BC controller liquid/Intermediate			17.5/14.0 (1.72/1.37)				17.0/14.0 (1.67/1.37)				
Sectional temperature	Outdoor unit	Discharge (TH1)		°C	100				95			
		Heat exchanger outlet (TH5)			-2				-1			
		Accumulator	Inlet		-1				-1			
			Outlet		-4				-2			
		Suction (Comp)			-1				-1			
		Shell bottom (Comp)			45				40			
	Indoor unit	LEV inlet			38				40			
		Heat exchanger outlet			80				85			

PURY-P200-250YMF-C

Items			Outdoor unit		PURY-P200YMF-C				PURY-P250YMF-C			
Condition	Ambient temp.	Indoor	DB/WB	20.0/-				20.0/-				
		Outdoor		7.0/6.0				7.0/6.0				
	Indoor unit	Quantity	Q'ty	4				4				
		Quantity in operation		4				4				
		Model	-	63	63	50	25	125	40	63	25	
	Piping	Main pipe	m	5				5				
		Branch pipe		5	5	5	5	5	5	5	5	
		Total piping length		25				25				
	Indoor unit fan notch		-	Hi	Hi	Hi	Hi	Hi	Hi	Hi	Hi	Hi
	Refrigerant volume		kg	14.4				14.9				
Compressor volts/Frequency		V	380		415		380		415			
		V/Hz	280/80		280/80		340/95		340/95			
Outdoor unit total current		A	13.4		12.3		17.1		15.6			
LEV opening	Indoor unit		Pulse	600	950	750	400	750	600	950	400	
	BC controller (1, 3)			60		700		60		800		
	Oil return			150				235				
Pressure	High pressure/Low pressure		kg/cm ² G (MPa)	18.5/3.6 (1.96/0.38)				18.0/3.7 (1.86/0.34)				
	BC controller liquid/Intermediate			17.5/14.0 (1.86/1.57)				17.0/14.0 (1.76/1.47)				
Sectional temperature	Outdoor unit	Discharge (TH1)		100				95				
		Heat exchanger outlet (TH5)		-2				-1				
		Accumulator	Inlet	-1				-1				
			Outlet	-4				-2				
		Suction (Comp)		-1				-1				
		CS circuit	(TH2)	7				5				
		Shell bottom (Comp)		45				40				
	Indoor unit	LEV inlet		38				40				
		Heat exchanger outlet		80				85				
αOC			0.28				0.28					

[5] Function of Dip SW and Rotary SW

(1) Outdoor unit

① PU(H)Y-200-250YMF-C

Switch	Function	Function according to switch operation		Switch set timing	
		When off	When on	When off	When on
SWU	1~2	Unit address setting	Set on 51~100 with the dial switch.		Before power is turned on.
SW1	1~8	For self diagnosis/ operation monitoring	LED monitoring display		During normal operation when power is on.
	9~10	—	—	—	Should be set on OFF.
SW2	1	Centralized control switch	Centralized control not connected.	Centralized control connected.	Before power is turned on.
	2	Deletion of connection information.	Storing of refrigeration system connection information.	Deletion of refrigeration system connection information.	Before power is turned on.
	3	Deletion of error history.	—	Deletion	During normal operation when power is on.
	4	—	—	—	—
	5	—	—	—	—
	6	Disregard ambient air sensor errors, liquid overflow errors.	Errors valid.	Disregard errors.	During normal operation when power is on.
	7	Forced defrosting	Ordinary control	Start forced defrosting.	During normal operation when power is on. 10 minutes or more after compressor starts.
	8	Defrost prohibited timer	43 min.	90 min.	During normal operation when power is on. (Except during defrosting)
	9	-	—	—	—
	10	-	—	—	—
SW3	1	SW3-2 Function valid/ invalid	SW3-2 Function invalid	SW3-2 Function valid	During normal operation when power is on.
	2	Indoor unit test operation	Stop all indoor units.	All indoor units test operation ON.	When SW3-1 is ON after power is turned on.
	3	Defrosting start temperature of TH5.	-2°C	0°C	During normal operation when power is on.
	4	Defrosting end temperature of TH5.	8°C	15°C	During normal operation when power is on. (Except during defrosting)
		Opening angle of IC except when heater thermostat is ON during defrosting.	(no operation)	2000	
	5	—	—	—	—
	6	Models	PUHY-YMF-C	PUY-YMF-C	When switching on the power.
	7	Target Pd (High pressure)	18kg/cm ² G (1.76MPa)	20kg/cm ² G (1.96MPa)	During normal operation when power is on.
	8	—	—	—	—
	9	—	—	—	—
10	Models	Model 200	Model 250	When switching on the power.	
SW4	1	—	—	—	—
	2	—	—	—	—
	3	—	—	—	—

Note:

- SWU1~2=00 when shipped from the factory. Other factory settings are indicated by shaded portions.
- If the address is set from 01 to 50, it automatically becomes 100.

② PUHY-P200-250YMF-C

Switch	Function	Function according to switch operation		Switch set timing	
		When off	When on	When off	When on
SWU	1~2	Unit address setting		Set on 51~100 with the dial switch.	
SW1	1~8	For self diagnosis/operation monitoring		LED Monitoring Display	
	9~10	-		-	
SW2	1	Centralized control switch	Centralized control not connected.	Centralized control connected.	Before power is turned on.
	2	Deletion of connection information.	Storing of refrigeration system connection information.	Deletion of refrigeration system connection information.	Before power is turned on.
	3	Deletion of error history.	-	Deletion	During normal operation when power is on.
	4	-	-	-	-
	5	-	-	-	-
	6	Disregard ambient air sensor errors, liquid overflow errors.	Errors valid.	Disregard errors.	During normal operation when power is on.
	7	Forced defrosting	Ordinary control	Start forced defrosting.	During normal operation when power is on. 10 minutes or more after compressor starts.
	8	Defrost prohibited timer	39 min.	90 min.	During normal operation when power is on. (Except during defrosting)
	9	-	-	-	-
	10	-	-	-	-
SW3	1	SW3-2 Function valid/invalid	SW3-2 Function invalid	SW3-2 Function valid	During normal operation when power is on.
	2	Indoor unit test operation	Stop all indoor units.	All indoor units test operation ON.	When SW3-1 is ON after power is turned on.
	3	Defrosting start temperature of TH5.	-4°C	-1°C	During normal operation when power is on.
	4	Defrosting end temperature of TH5.	8°C	15°C	During normal operation when power is on. (Except during defrosting)
		Opening angle of IC except when heater thermostat is ON during defrosting.	(no operation)	2000	
	5	-	-	-	-
	6	Models	PUHY-P-YMF-C	PUY-P-YMF-C	When switching on the power.
	7	Target Tc (High pressure) at Heating	49°C	53°C	During normal operation when power is on.
	8	-	-	-	-
	9	-	-	-	-
10	Models	Model P200	Model P250	When switching on the power.	
SW4	1	SW4-2 Function valid/invalid	Invalid	Valid	During normal operation when power is on.
	2	Configuration compensation value	Changes as shown below by on → off change 0% → 3% → 6% → 9% → 12% → -6% → -3% → 0%		when SW4-1 in ON.
	3	-	-	-	-

Note:

- SWU1~2=00 when shipped from the factory. Other factory settings are indicated by shaded portions.
- If the address is set from 01 to 50, it automatically becomes 100.

③ PURY-200-250YMF-C

Switch	Function	Function according to switch operation		Switch set timing	
		When off	When on	When off	When on
SWU	1~2	Unit address setting	Set on 51~100 with the dial switch.		Before power is turned on.
SW1	1~8	For self diagnosis/ operation monitoring	LED monitoring display		During normal operation when power is on.
	9~10	–	–	–	Should be set on OFF.
SW2	1	Centralized control switch	Centralized control not connected.	Centralized control connected.	Before power is turned on.
	2	Deletion of connection information.	Storing of refrigeration system connection information.	Deletion of refrigeration system connection information.	Before power is turned on.
	3	Deletion of error history.	–	Deletion	During normal operation when power is on.
	4	–	–	–	–
	5	–	–	–	–
	6	Disregard ambient air sensor errors, liquid overflow errors.	Errors valid.	Disregard errors.	During normal operation when power is on.
	7	Forced defrosting	Ordinary control	Start forced defrosting.	During normal operation when power is on. 10 minutes or more after compressor starts.
	8	Defrost prohibited timer	43 min.	90 min.	During normal operation when power is on. (Except during defrosting)
	9	–	–	–	–
	10	–	–	–	–
SW3	1	SW3-2 Function valid/ invalid	SW3-2 Function invalid	SW3-2 Function valid	During normal operation when power is on.
	2	Indoor unit test operation	Stop all indoor units.	All indoor units test operation ON.	When SW3-1 is ON after power is turned on.
	3	Defrosting start temperature of TH7.	–6°C	–3°C	During normal operation when power is on.
	4	Defrosting end temperature of TH5.	8°C	15°C	During normal operation when power is on. (Except during defrosting)
	5	–	–	–	–
	6	Pump down operation	Invalid	Valid	During compressor stop when power is on.
	7	Target Td (High pressure) at Heating	49°C	53°C	During normal operation when power is on.
	8	–	–	–	–
	9	–	–	–	–
	10	Models	Model 200	Model 250	When switching on the power.
SW4	1	–	–	–	–
	2	–	–	–	–
	3	–	–	–	–

Note:

- SWU1~2=00 when shipped from the factory. Other factory settings are indicated by shaded portions.
- If the address is set from 01 to 50, it automatically becomes 100.

④ PURY-P200-250YMF-C

Switch	Function	Function according to switch operation		Switch set timing	
		When off	When on	When off	When on
SWU	1~2	Unit address setting		Set on 51~100 with the dial switch.	
SW1	1~8	For self diagnosis/operation monitoring		LED monitoring display	
	9~10	-		-	
SW2	1	Centralized control switch	Centralized control not connected.	Centralized control connected.	Before power is turned on.
	2	Deletion of connection information.	Storing of refrigeration system connection information.	Deletion of refrigeration system connection information.	Before power is turned on.
	3	Deletion of error history.	-	Deletion	During normal operation when power is on.
	4	-	-	-	-
	5	-	-	-	-
	6	Disregard ambient air sensor errors, liquid overflow errors.	Errors valid.	Disregard errors.	During normal operation when power is on.
	7	Forced defrosting	Ordinary control	Start forced defrosting.	During normal operation when power is on. 10 minutes or more after compressor starts.
	8	Defrost prohibited timer	43 min.	90 min.	During normal operation when power is on. (Except during defrosting)
	9	-	-	-	-
	10	-	-	-	-
SW3	1	SW3-2 Function valid/invalid	SW3-2 Function invalid	SW3-2 Function valid	During normal operation when power is on.
	2	Indoor Unit Test operation	Stop all indoor units.	All indoor units test operation ON.	When SW3-1 is ON after power is turned on.
	3	Defrosting start temperature of TH7.	-8°C	-5°C	During normal operation when power is on.
	4	Defrosting end temperature of TH5.	8°C	15°C	During normal operation when power is on. (Except during defrosting)
	5	-	-	-	-
	6	Pump down operation	Invalid	Valid	During compressor stop when power is on.
	7	Target Tc (High pressure) at Heating	49°C	53°C	During normal operation when power is on.
	8	-	-	-	-
	9	-	-	-	-
	10	Models	Model P200	Model P250	When switching on the power.
SW4	1	SW4-2 function valid/Invalid	Invalid	Valid	During normal operation when power is on.
	2	Configuration compensation value	Changes as shown below by on → off change 0% → 3% → 6% → 9% → 12% → -6% → -3% → 0%		when SW4-1 in ON.
	3	-	-	-	-

Note:

- SWU1~2=00 when shipped from the factory. Other factory settings are indicated by shaded portions.
- If the address is set from 01 to 50, it automatically becomes 100.

(2) Indoor unit
DIP SW1, 3

Switch	SW name	Operation by SW		Switch set timing		Remarks
		OFF	ON	OFF	ON	
SW1	1	Room temp. sensor position	Indoor unit inlet	Built in remote controller		
	2	Clogged filter detect.	None	Provided		
	3	Filter duration	100h	2500h		
	4	OA intake	Ineffective	Effective		Always ineffective for PKFY-P.VAM
	5	Remote display select.	Fan output display	Thermo. ON signal display		
	6	Humidifier control	At stationary heating	Always at heat.		
	7	Heating thermo. OFF airflow	Very low speed	Low speed		
	8	Heating thermo. OFF airflow	SW1-7 setting	Set airflow		
	9	Power failure automatic return	Ineffective	Effective		
	10	Power source start/stop	Ineffective	Effective		
SW3	1	Model selection	Heat pump	Cool. only	At unit stopping (at remote controller OFF)	
	2	Louver <small>(Cooling capacity saving for PKFY-P. VAM, effective/ineffective)</small>	None	Provided		
	3	Vane	None	Provided		
	4	Vane swing function	None	Provided		Not provided for PKFY-P.VAM Provided for PLFY-P.VGM (ON) setting
	5	Vane horizontal angle	1st setting	2nd setting		
	6	Vane angle set for cooling	Down blow B, C	Horizontal		Always down blow B,C for PKFY-P.VAM Horizontal (ON) setting for PLFY-P.VLMD
	7	–	–	–		
	8	Heating 4deg up	Effective	Ineffective		Ineffective (ON) setting for floor standing
	9	–	–	–		
	10	–	–	–		

Note 1: The shaded part indicates the setting at factory shipment. (For the SW not being shaded, refer to the table below.)

Model Switch	PLFY-P			PEFY-P				PDFY-P	PFFY-P	PCFY-P	PKFY-P		
	VBM-A	VLMD-A	VKM-A	VML-A	VMH-A	20-80VMM-A	100-140VMM-A	VM-A	VLRM-A, VLEM-A	VGM-A	VAM-A	VGM-A	
SW1	3	OFF	ON	OFF	ON	OFF	ON	ON	OFF	ON	OFF	OFF	
	6	OFF	ON							OFF	OFF	OFF	OFF
	7	OFF			ON	OFF	ON	OFF					
SW3	3	ON			OFF				ON		ON	ON	
	4	ON	OFF	ON	OFF				ON	OFF	ON	ON	
	6	OFF	ON	OFF							ON	OFF	ON
	8	OFF							ON	ON	OFF	OFF	

Note 2: The DipSW setting is only effective during unit stopping (remote controller OFF) for SW1, 2, 3 and 4 commonly and the power source is not required to reset.)

3: When both SW1-7 and SW1-8 are being set to ON, the fan stops at the heating thermostat of OFF.

Setting of DIP SW2

Model	P20	P25	P32	P40	P50	P63
Capacity (model name) code	4	5	6	8	10	13
SW2 setting						





Model	P71	P80	P100	P125	P140	P200	P250
Capacity (model name) code	14	16	20	25	28	40	50
SW2 setting							

Setting of DIP SW4

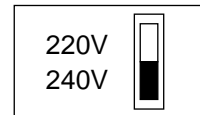
Model	Circuit board used	SW4			
		1	2	3	4
PMFY-P-VBM-A	Phase control	ON	OFF	ON	OFF
PLFY-P-VLMD-A		-	-	-	-
PDFY-P20 ~ 80VM-A		ON	OFF	ON	OFF
PLFY-P40 ~ 63VKM-A		OFF	OFF	OFF	ON
PLFY-P80 ~ 125VKM-A		ON	OFF	OFF	ON
PCFY-P-VGM-A		OFF	ON	OFF	ON
PKFY-P-VGM-A		OFF	OFF	ON	ON
PKFY-P-VAM-A		-	-	-	-
PEFY-P20 ~ 80VMM-A		ON	ON	OFF	OFF
PFFY-P-VLEM-A, P-VLRM-A	Relay selection	OFF	OFF	OFF	-
PEFY-P20 ~ 32VML-A		ON	ON	ON	-
PEFY-P40 ~ 140VMH-A		OFF	OFF	OFF	-
PEHY-P200-250VMH-A		ON	OFF	OFF	-
PDFY-P100-125VM-A		OFF	OFF	ON	-
PEFY-P100 ~ 140VMM-A		ON	ON	ON	OFF

Setting of DIP SW5



Switch	Function	Operation by switch	Switch set timing																
SWA	Ceiling height setting	<p>(PLFY-P-VKM-A) (PCFY-P-VGM-A)</p>  <p>* The ceiling height is changed by SWB setting.</p> <table border="1"> <thead> <tr> <th colspan="2">Ceiling height</th> </tr> </thead> <tbody> <tr> <td>3</td> <td>3.5 m</td> </tr> <tr> <td>2</td> <td>2.8 m</td> </tr> <tr> <td>1</td> <td>2.3 m</td> </tr> </tbody> </table>	Ceiling height		3	3.5 m	2	2.8 m	1	2.3 m	Always after powering								
Ceiling height																			
3	3.5 m																		
2	2.8 m																		
1	2.3 m																		
SWA	External static pressure setting	<p>(PDFY-P20 ~ 80VM-A, PEFY-P20 ~ 80VMM-A)</p>  <p>100Pa 50Pa 30Pa</p> <p>* For other models, change the setting of static pressure by replacing the connector.</p>	Always after powering																
SWA	For options	<p>(PLFY-P-VLMD-A)</p>  <p>* As this switch is used by interlocking with SWC, refer to the item of SWC for detail.</p>	Always after powering																
SWB	Setting of air outlet opening	<p>(PLFY-P-VKM-A)</p>  <table border="1"> <thead> <tr> <th>SWA \ SWB</th> <th>1</th> <th>2</th> <th>3</th> </tr> </thead> <tbody> <tr> <td>2-way</td> <td>3.5 m</td> <td>3.8 m</td> <td>3.8 m</td> </tr> <tr> <td>3-way</td> <td>3.0 m</td> <td>3.3 m</td> <td>3.5 m</td> </tr> <tr> <td>4-way</td> <td>2.7 m</td> <td>3.0 m</td> <td>3.5 m</td> </tr> </tbody> </table>	SWA \ SWB	1	2	3	2-way	3.5 m	3.8 m	3.8 m	3-way	3.0 m	3.3 m	3.5 m	4-way	2.7 m	3.0 m	3.5 m	Always after powering
SWA \ SWB	1	2	3																
2-way	3.5 m	3.8 m	3.8 m																
3-way	3.0 m	3.3 m	3.5 m																
4-way	2.7 m	3.0 m	3.5 m																
SWC	Airflow control	<p>(PLFY-P-VKM-A, PCFY-P-VGM-A, PKFY-P-VGM-A, PDFY-P-VM-A)</p>  <p>Option Standard</p> <p>* Set to the option to install the high efficiency filter</p>	Always after powering																

3 TEST RUN

[1] Before Test Run

(1) Check points before test run

1	Neither refrigerant leak nor loose power source/ transmission lines should be found.
2	Confirm that the resistance between the power source terminal block and the ground exceeds 2MΩ by measuring it with a DC500V megger. Do not run if it is lower than 2MΩ. Note) Never apply the megger to the MAIN board. If applied, the MAIN board will be broken.
3	Confirm that the Ball valve at both gas and liquid sides is being fully opened. Note) Certainly close the cap.
4	Be sure that the crankcase heater has been powered by turning the main power source on at least 12 hours before starting the test run. The shorter powering time causes compressor trouble.

(2) Caution at inverter check

Because the inverter power portion in outdoor unit electrical part box have a lot of high voltage portion, be sure to follow the instructions shown below.

1	During energizing power source, never touch inverter power portion because high voltage (approx. 580V) is applied to inverter power portion.	
2	When checking,	
	1	Shut off main power source, and check it with tester, etc.
	2	Allow 10 minutes after shutting off main power source.
	3	Open the MAIN board mounting panel, and check whether voltage of both ends of electrolytic capacitor is 20V or less.

(3) Check points for test run when mounting options

Built-in optional parts	Content of test run	Check point	Result
Mounting of drain water lifting-up mechanism	1 Release connector of pump circuit, check error detection by pouring water into drain pan water inlet.	Local remote controller displays code No. "2503", and the mechanism stops.	
		No overflow from drain pan.	
	2 After that, connect connector of circuit.	Drain water comes out by operations of drain pump.	
	3 Check pump operations and drainage status in cooling (test run) mode.	Sound of pump operations is heard, and drain water comes out.	
Mounting of permeable film humidifier	Check humidifier operations and water supply status in heating (test run) mode.	No water leak from connecting portions of each water piping.	
		Water is supplied to water supply tank, and float switch is operating.	

(4) Attention for mounting drain water lifting-up mechanism

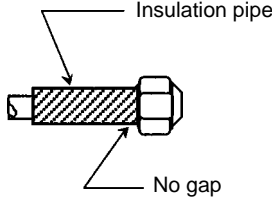
Work	Content of test run	Check point	Result
Disassembling and assembling of drain water lifting-up mechanism	1 Lead wire from control box not damaged.		
	2 Rubber cap properly inserted to drain water outlet of drain pan?		
	3 Insulation pipe of gas and liquid pipes dealt with as shown in the right figure?		
	4 Drain pan and piping cover mounted without gap?		
	5 Drain pan hooked on cut projection of the mechanism?		
Mounting of float switch	Float switch installed without contacting with drain pan?	1 Float switch moves smoothly.	
		2 Float switch is mounted on mounting board straightly without deformation.	
		3 Float switch does not contact with copper pipe.	
Electric wiring	1 No mistakes in wiring?	Wiring procedure is exactly followed.	
	2 Connectors connected surely and tightly?	Connector portion is tightly hooked.	
	3 No tension on lead wire when sliding control box?		

(5) Check points for system structure

ex. PURY-200YMF-C

Check points from installation work to test run.

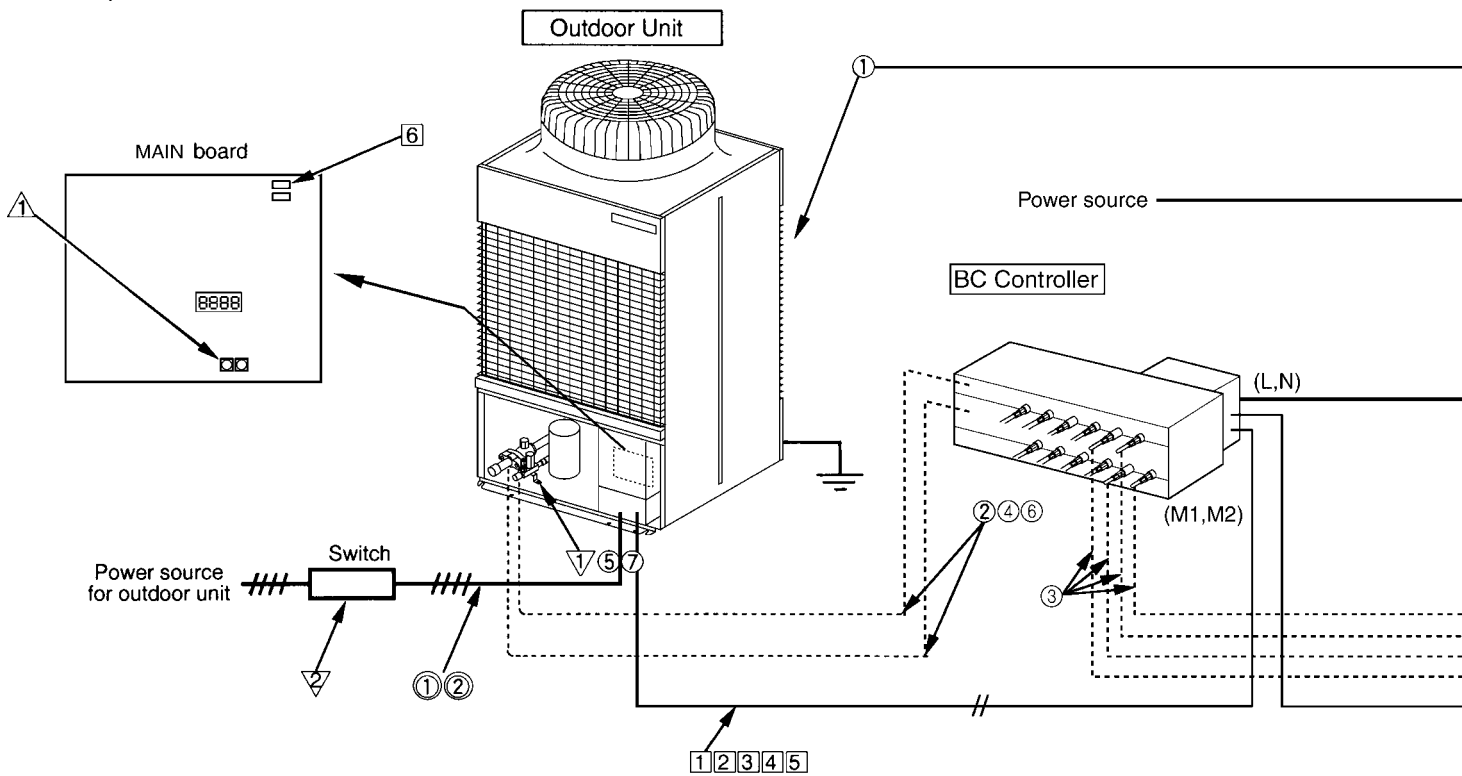



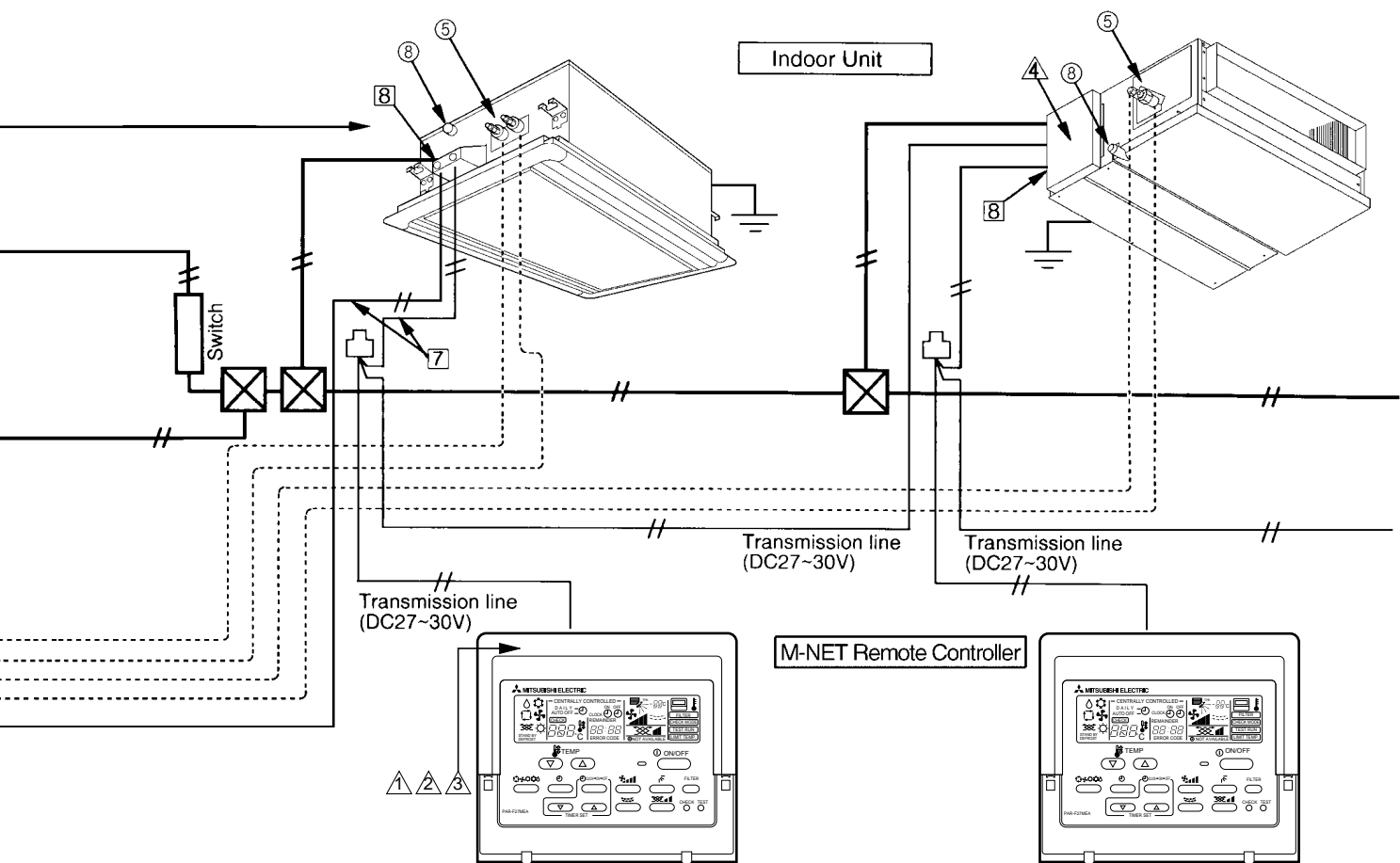





Classification	Portion	Check item	Trouble
Installation and piping	①	Instruction for selecting combination of outdoor unit, and indoor unit followed? (Maximum number of indoor units which can be connected, connecting model name, and total capacity.)	Not operate.
	②	Follow limitation of refrigerant piping length? For example, 70m or less (total length : 220m) at the farthest.	Not cool (at cooling).
	③	Connecting piping size of branch piping correct?	Not heat (at heating).
	④	Refrigerant piping diameter correct?	
	⑤	Refrigerant leak generated at connection?	Not cool, not heat, error stop.
	⑥	Insulation work for piping properly done?	Condensation drip in piping.
	⑦	Specified amount of refrigerant replenished?	Not cool, not heat, error stop.
	⑧	Pitch and insulation work for drain piping properly done?	Water leak, condensation drip in drain piping.
Power source wiring	①	Specified switch capacity and wiring diameter of main power source used?	Error stop, not operate.
	②	Proper grounding work done on outdoor unit?	Electric shock.
	③	The phases of the L line (L1, L2, L3) correct?	Error stop, not operate.
	④	L line and N line connected correct?	Some electric parts should be damaged.



Classification	Portion	Check item	Trouble
Transmission line	①	Limitation of transmission line length followed? For example, 200m or less (total length : 500m) at the farthest.	Erroneous operation, error stop.
	②	1.25mm ² or more transmission line used? (Remote controller 10m or less 0.75mm ²)	Erroneous operation, error stop.
	③	2-core cable used for transmission line?	Error stop in case multiple-core cable is used.
	④	Transmission line apart from power source line by 5cm or more?	Erroneous operation, error stop.
	⑤	One refrigerant system per transmission line?	Not operate.
	⑥	The short circuit connector is changed form CN41 to CN40 on the MAIN board when the system is centralized control? (Just one outdoor unit. Not all outdoor units.)	Not operate.
	⑦	• No connection trouble in transmission line?	Error stop or not operate.
	⑧	Connection of wrong remote controller line terminals? • MA Remote controller : TB15 • M-NET Remote controller : TB5	Never finish the initial mode.
System set	①	Address setting properly done? (M-NET Remote controller, indoor unit and outdoor unit.)	Error stop or not operate.
	②	Setting of address No. done when shutting off power source?	Can not be properly set with power source turned on.
	③	Address numbers not duplicated?	Not operate.
	④	Turned on SW3-8 on indoor unit circuit board when mounting room thermistor sensor?	Set temperature not obtained at heating operations (Thermostat stop is difficult)
Before starting	①	Refrigerant piping ball valve (Liquid pressure pipe, gas pressure pipe) opened?	Error stop.
	②	Turn on power source 12 hours before starting operations?	Error stop, compressor trouble.

[2] Test Run Method

Operation procedure	
①	Turn on universal power supply at least 12 hours before getting started → Displaying “HO” on display panel for about two minutes
②	Press TEST RUN button twice → Displaying “TEST RUN” on display panel
③	Press  selection button → Make sure that air is blowing out
④	Press  select button to change from cooling to heating operation, and vice versa → Make sure that warm or cold air is blowing out
⑤	Press  adjust button → Make sure that air blow is changed
⑥	Press  or  button to change wind → Make sure that horizontal or downward blow is adjustable.
⑦	Make sure that indoor unit fans operate normally
⑧	Make sure that interlocking devices such as ventilator operate normally if any
⑨	Press ON/OFF button to cancel test run → Stop operation
<p>Note 1: If check code is displayed on remote controller or remote controller does not operate normally.</p> <p>2: Test run automatically stops operating after two hours by activation of timer set to two hours.</p> <p>3: During test run, test run remaining time is displayed on time display section.</p> <p>4: During test run, temperature of liquid pipe in indoor unit is displayed on remote controller room temperature display section.</p> <p>5: When pressing  adjust button, depending on the model, “NOT AVAILABLE” may be displayed on remote controller. However, it is not a malfunction.</p> <p>6: When pressing  or  button, depending on the model, “NOT AVAILABLE” may be displayed on remote controller. However, it is not a malfunction.</p>	

4 GROUPING REGISTRATION OF INDOOR UNITS WITH M-NET REMOTE CONTROLLER

(1) Switch function

- The switch operation to register with the remote controller is shown below:

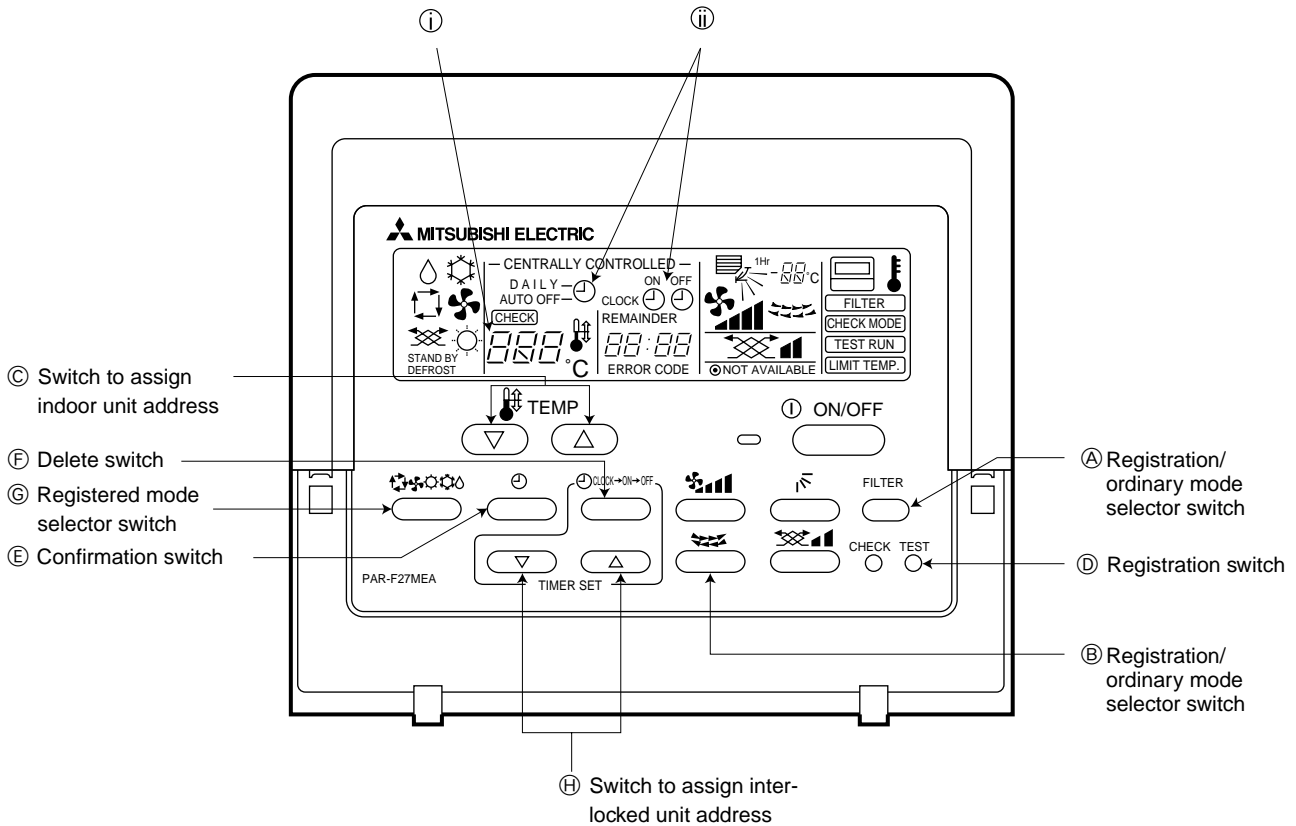

Name	Symbol of switch	Name of actual switch	Description
Registration/ordinary mode selection switch	Ⓐ + Ⓑ	(FILTER) +	This switch selects the ordinary mode or registered mode (ordinary mode represents that to operate indoor units). * To select the registered mode, press the (FILTER) + switch continuously for over 2 seconds under stopping state. [Note] The registered mode can not be obtained for a while after powering. Pressing the (FILTER) + switch displays "CENTRALLY CONTROLLED".
Switch to assign indoor unit address	Ⓒ		This switch assigns the unit address for "INDOOR UNIT ADDRESS NO."
Registration switch	Ⓓ	(TEST RUN)	This switch is used for group/interlocked registration.
Confirmation switch	Ⓔ		This switch is used to retrieve/identify the content of group and interlocked (connection information) registered.
Delete switch	Ⓕ	CLOCK → ON → OFF	This switch is used to retrieve/identify the content of group and interlocked (connection information) registered.
Registered mode selector switch	Ⓖ		This switch selects the case to register indoor units as group (group setting mode) or that as interlocked (interlocked setting mode). *The unit address is shown at one spot ① for the group setting mode while at two spots ② for the interlocked setting mode.
Switch to assign interlocked unit address	Ⓗ		This switch assigns the unit address of "OA UNIT ADDRESS NO."

(2) Attribute display of unit

- At the group registration and the confirmation/deletion of registration/connection information, the type (attribute) of the unit is displayed with two English characters.

Display	Type (Attribute) of unit/controller
IL	Indoor unit connectable to remote controller
OL	Outdoor unit
RL	Local remote controller
SL	System controller (MJ)

[Description of registration/deletion/retrieval]

- The items of operation to be performed by the remote controller are given below. Please see the relating paragraph for detail.

① Group registration of indoor unit

- The group of the indoor units and operating remote controller is registered.
- It is usually used for the group operation of indoor units with different refrigerant system.

② Retrieval/identification of group registration information of indoor units

- The address of the registered indoor units in group is retrieved (identified).

③ Retrieval/identification of registration information

- The connection information of any unit (indoor/outdoor units, remote controller or the like) is retrieved (identified).

④ Deletion of group registration information of indoor units

- The registration of the indoor units under group registration is released (deleted).

⑤ Deletion of the address not existing

- This operation is to be conducted when "6607" error (No ACK error) is displayed on the remote controller caused by the miss setting at test run, or due to the old memory remained at the alteration/modification of the group composition.

Caution:

When MELANS (MJ-103MTRA for example) is being connected, do not conduct the group/pair registration using the remote controller. The group/pair registration should be conducted by MELANS. (For detail, refer to the instruction exclusively prepared for MELANS.)

(3) Group registration of indoor unit

1) Registration method

- Group registration of indoor unit ①
The indoor unit to be controlled by a remote controller is registered on the remote controller.

[Registration procedure]

- ① With the remote controller under stopping or at the display of "HO", continuously press the **FILTER** + switch (A + B) at the same time for 2 seconds to change to the registration mode. (See the figure below.)
- ② Assign the indoor unit address to "INDOOR UNIT ADDRESS NO." by operating the (Room temperature adjustment) (C).
Then press the **TEST RUN** switch (D) to register. In the figure below, the "INDOOR UNIT ADDRESS NO." is being set to 001.
- ③ After completing the registration, press the **FILTER** + switch (A + B) at the same time for 2 seconds to change to the original ordinary mode (with the remote controller under stopping).

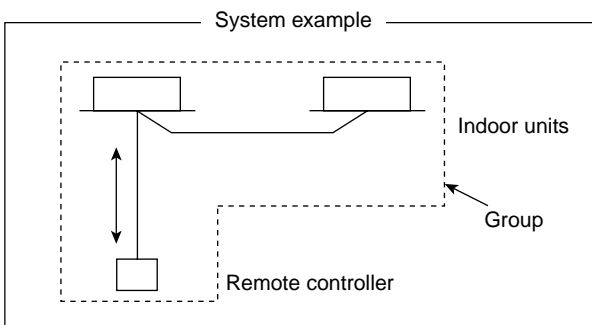
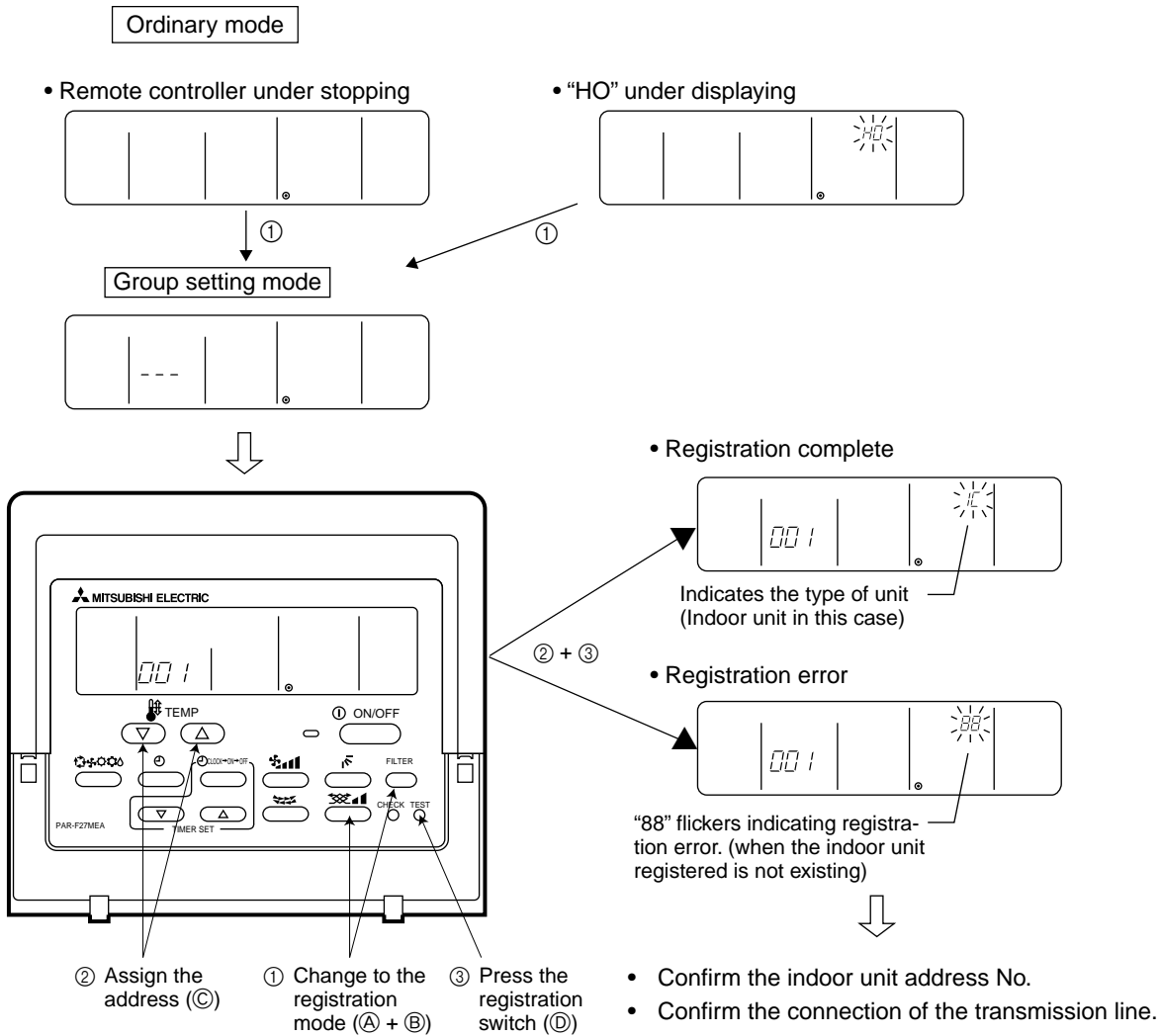

2) Method of retrieval/confirmation

- Retrieval/confirmation of group registration information on indoor unit..... [2]

The address of the indoor unit being registered on the remote controller is displayed.

[Operation procedure]

- ① With the remote controller under stopping or at the display of "HO", continuously press the (FILTER) + [switch (A) + (B)] at the same time for 2 seconds to change to the registration mode.
- ② In order to confirm the indoor unit address already registered, press [switch (E)]. (See figure below.) When the group of plural sets is registered, the addresses will be displayed in order at each pressing of [switch (E)].
- ③ After completing the registration, continuously press the (FILTER) + [switch (A) + (B)] at the same time for 2 seconds to change to the original ordinary mode (with the remote controller under stopping).

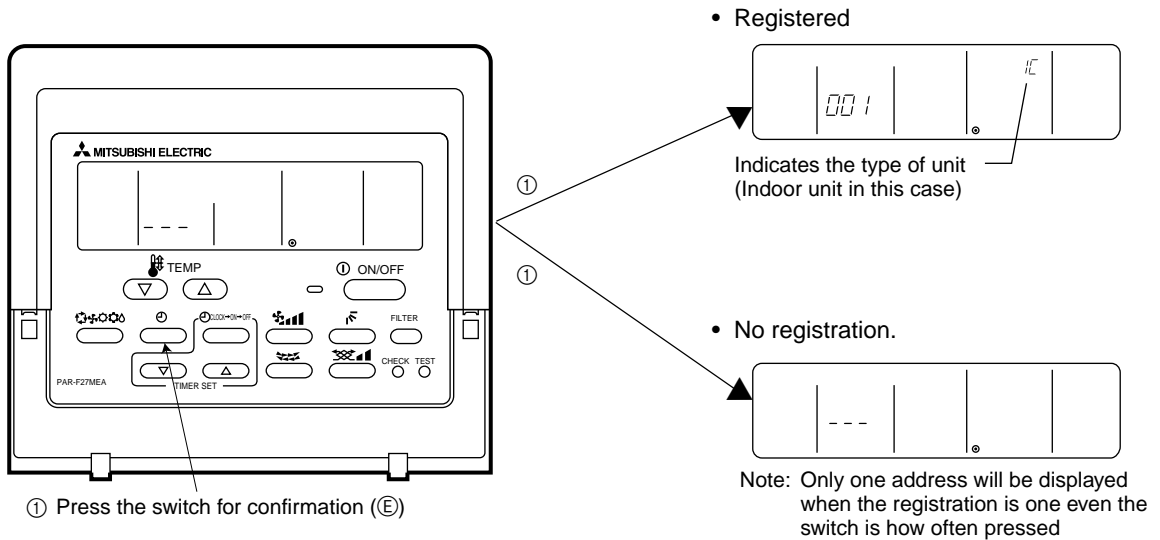

- Retrieval/confirmation of registration information [3]

The registered information on a certain unit (indoor unit, outdoor unit, remote controller or the like) is displayed.

[Operation procedure]

- ① With the remote controller under stopping or at the display of "HO", continuously press the (FILTER) + [switch (A) + (B)] at the same time for 2 seconds to change to the registration mode.
- ② Operate [switch (C)] for the interlocked setting mode. (See figure below.)
- ③ Assign the unit address of which registration information is desired to confirm with the [switch (H)] (TIMER SET) switch. Then press the [switch (E)] to display it on the remote controller. (See figure below.) Each pressing of [switch (E)] changes the display of registered content. (See figure below.)
- ④ After completing the retrieval/confirmation, continuously press the (FILTER) + [switch (A) + (B)] at the same time for 2 seconds to change to the original ordinary mode (with the remote controller under stopping).

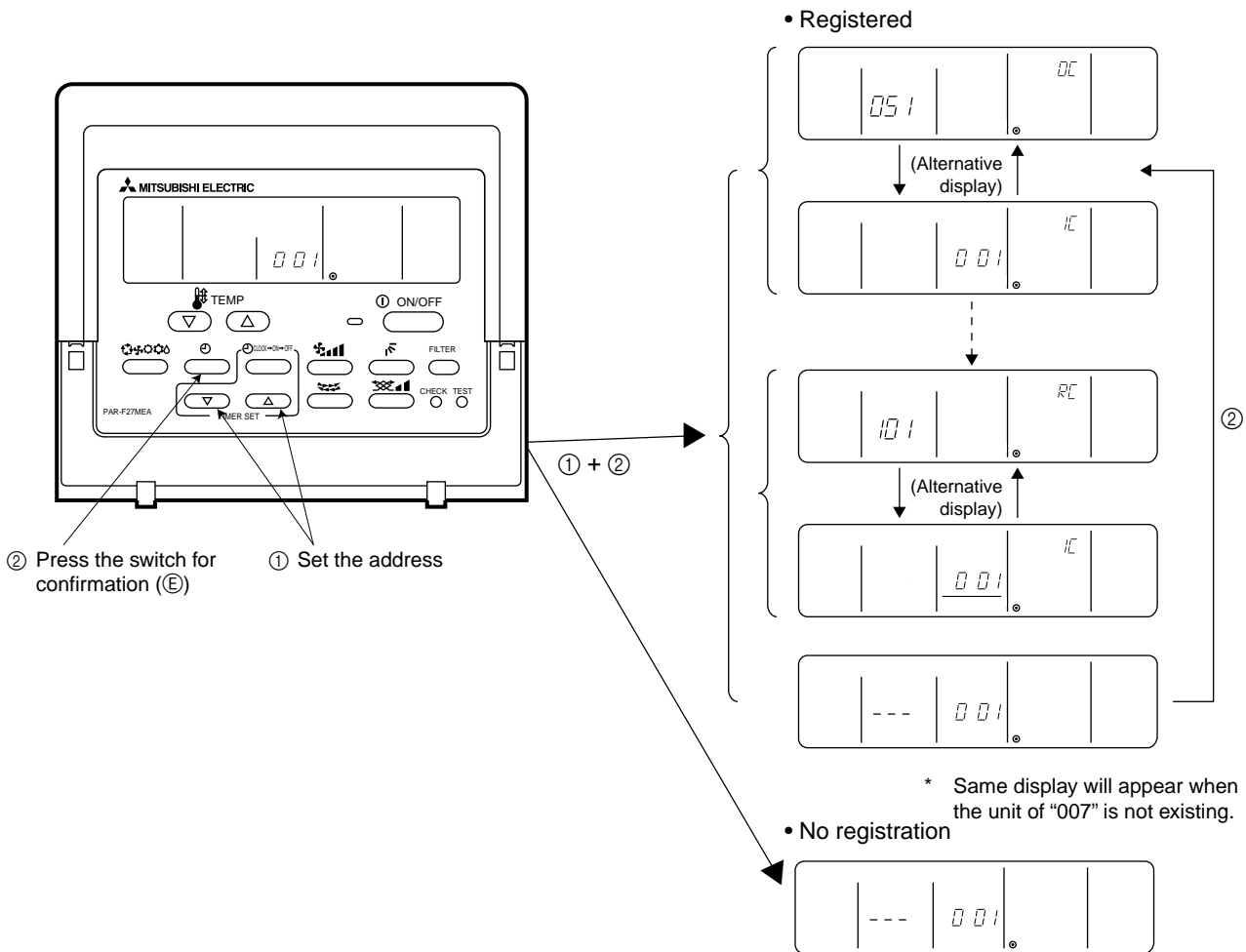

3) Method of deletion

- Deletion of group registration information of indoor unit ④

[Operation procedure]

- ① With the remote controller under stopping or at the display of "HO", continuously press the (FILTER) + switch (A) + (B) at the same time for 2 seconds to change to the registration mode.
- ② Press the (E) switch to display the indoor unit address registered. (As same as ②)
- ③ In order to delete the registered indoor unit being displayed on the remote controller, press the (CLOCK → ON → OFF) (E) switch two times continuously. At completion of the deletion, the attribute display section will be shown as "--". (See figure below.)
Note: Completing the deletion of all indoor units registered on the remote controller returns to "HO" display.
- ④ After completing the registration, continuously press the (FILTER) + switch (A) + (B) at the same time for 2 seconds to change to the original ordinary mode (with the remote controller under stopping).

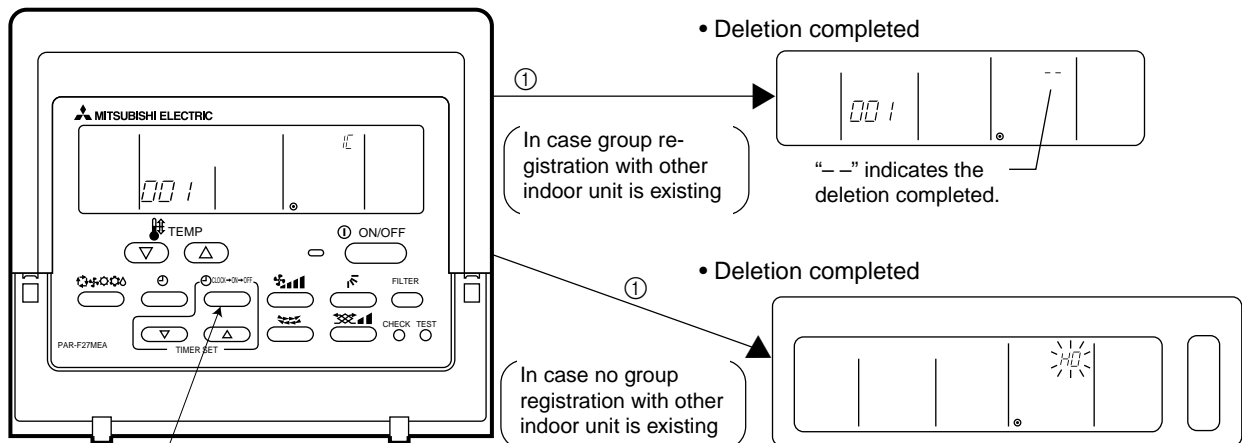

- ① Press the switch for confirmation (E) twice continuously.

5 CONTROL

[1] Control of Outdoor Unit

(1) Initial processing

- When turning on power source, initial processing of microcomputer is given top priority.
- During initial processing, control processing corresponding to operation signal is suspended. The control processing is resumed after initial processing is completed. (Initial processing : Data processing in microcomputer and initial setting of each LEV opening, requiring approx. 2 minutes at the maximum.)

(2) Control at starting

- In case unit is started within 2 hours after turning on power source at low ambient temperature (+5°C or less), the unit does not start operating for 30 minutes at the maximum.

(3) Bypass, capacity control

- Solenoid valve consists of bypass solenoid valve (SV1, SV2) bypassing between high pressure side and low pressure sider. The following operation will be provided.

1) Bypass solenoid valves SV1 and SV2 (both "open" when turned on)

- PU(H)Y-200-250YMF-C : Y
- PU(H)Y-P200-250YMF-C : Y-P
- PURY-200-250YMF-C : R2
- PURY-P200-250YMF-C : R2-P

Item	SV1		SV2		Object			
	ON (Open)	OFF (Close)	ON (Open)	OFF (Close)	Y	Y-P	R2	R2-P
When starting compressor	Turned on for 4 minutes		Turned on for 4 minutes		○	○	○	○
After thermost "ON is returned and after 3 minutes restart	Turned on for 4 minutes		Turned on for 4 minutes		○	○	○	○
When compressor stops in cooling or heating mode	Always turned on		-		○	○	○	○
After operation stops	Turned on for 3 minutes		-		○	○	○	○
During defrosting operations	Always turned on		Always turned on.		○	○	○	○
During oil recovery operations	Always turned on.		Always turned on.				○	○
	Always turned on.		-		○	○		
During 20Hz operations, at fall in low pressure or low pressure saturation temperature. (3minutes or more after starting)	-		When Ps is 1.5kg/cm ² G (0.15MPa) or less	When Ps is 2.5kg/cm ² G (0.25MPa) or more		○	○	○
			When low TH2 is -30°C or less	When TH2 is -15°C or more	○			
When high pressure rises (Pd)	When Pd reaches 27.5kg/cm ² G (2.70MPa) or more	When Pd is 24kg/cm ² G (2.35MPa) or less 30 seconds	When Pd reaches 26.5kg/cm ² G (2.60MPa) or more	When Pd is 23.5kg/cm ² G (2.30MPa) or less after 30 seconds			○	○
			When Pd reaches 25.5kg/cm ² G (2.50MPa) or more	When Pd is 23kg/cm ² G (2.25MPa) or less after 30 seconds	○	○		
When high pressure rises (Pd) during 20Hz operations (3 minutes after starting)	-		Turned on when high pressure (Pd) exceeds pressure limit	When high pressure (Pd) is 20kg/cm ² G (1.96MPa) or less	○	○	○	○
When discharge temperature rises (3 minutes after starting)			When temp. exceeds 130°C and Pb reaches 15kg/cm ² G (1.47MPa) or more	When discharge temp. is 115°C or less	○	○	○	○

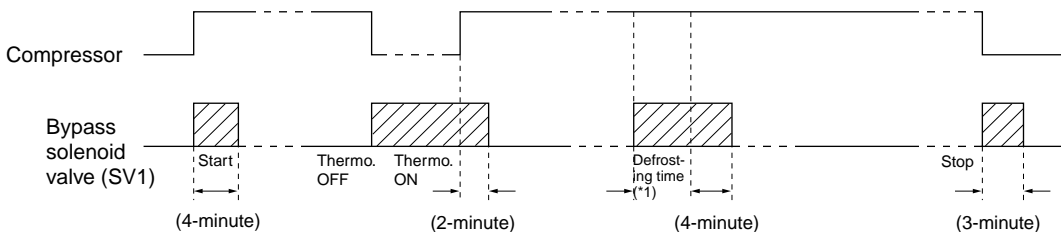

(4) Frequency control

- Depending on capacity required, capacity control change and frequency change are performed to keep constant evaporation temperature in cooling operations, and high pressure saturation temperature in heating operation.
- Frequency change is performed at the rate of 2Hz/second across 20 ~ 105Hz range.

1) Frequency control starting

- 60Hz is the upper limit for 3 minutes after starting.
- 75Hz is the upper limit within 30 minutes at the first starting compressor after turning on power source.

2) Pressure limit

The upper limit of high pressure (Pd) is set for each frequency.
 When the limit is exceeded, frequency is reduced every 10 seconds.
 (Frequency decrease rate (Hz) : 22% of the present value)

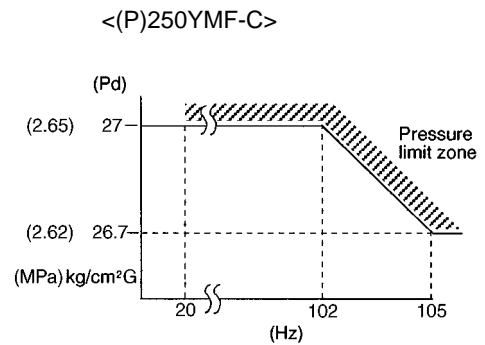
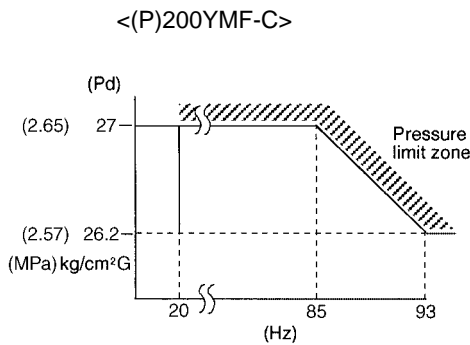

3) Discharge temperature limit

Discharge temperature (Td) of compressor is detected during operation. If the upper limit is exceeded, the frequency is reduced. (Change rate : 5% of the present value)

- 30 seconds after starting compressor, control is performed every minute.
- Operation temperature is 130°C.

4) Periodical frequency control

Frequency control is periodically performed except for the frequency controls at operation start, status change, and protection.

① Cycle of periodical frequency control

Periodical frequency control is performed every minute after the time specified below has passed.

- 20 sec after starting compressor or finishing defrosting operations
- 20 sec after frequency control by discharge temperature or pressure limit

② Amount of frequency change

The amount of frequency change is controlled corresponding to evaporation temperature and high pressure saturation temperature.

③-1 Back up of frequency control by bypass valve (PU(H)Y-200-250YMF-C)

During 20Hz operations, frequency is backed up by turning on (opening) bypass valve (SV2).

- Cooling
 During 20Hz operations 3 minutes after starting compressor, bypass valve is turned on when TH2 is -30°C or less, and turned off when TH2 is -15°C or more.
- Heating
 During 20Hz operations 3 minutes after starting compressor, SV2 turned on when high pressure (Pd) exceeds pressure limit and turned off when Pd falls to 20kg/cm²G (1.96MPa) or less.

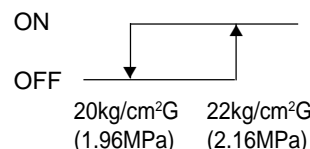
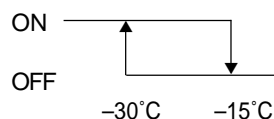

③-2 Back up of frequency control by bypass valve (PUHY-P200-250YMF-B, PURY-(P)200-250YMF-C)

During 20Hz operations, frequency is backed up by turning on (opening) bypass valve (SV2).

• Cooling

During 20Hz operations 3 minutes after starting compressor, bypass valve is turned on when, Ps is 1.5kg/cm²G (0.15MPa) or less and turned off when Ps is 2.5kg/cm²G (0.25MPa) or more.

• Heating

During 20Hz operations 3 minutes after starting compressor, SV2 turned on when high pressure (Pd) exceeds pressure limit and turned off when Pd falls to 20kg/cm²G (1.96MPa) or less.

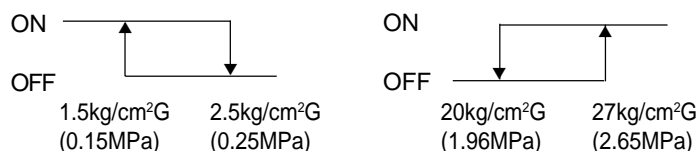

(5) Oil return control (Electronic expansion valve <SLEV>)

- Oil return LEV (SLEV) opening is dependent on compressor frequency and ambient temperature.
- SLEV is closed (0) when compressor stops, and SLEV is set (64) for 10 minutes after starting compressor.

(6) Subcool coil control (electronic expansion valve <LEV1>) : PU(H)Y-200-250YMF-B, PUHY-P200-250YMF-C

- The amount of super heat detected from the bypass outlet temperature of subcool coil (TH8) is controlled to be within a certain range for each 60 sec.
- The opening angle is corrected and controlled depending on the outlet/inlet temperature of subcool coil (TH5, TH7) and the discharge temperature.
- However, the valve will be closed (0) at heating and compressor stopping.
- It will fully open at defrosting.

(7) Defrost operation control

① PU(H)Y-(P)200-250YMF-C

1) Starting of defrost operations

- After integrated 39 min : P-YMF-C, 43 min : YMF-C of compressor operations, defrosting operations start when -4°C or less : P-YMF-C, -2°C or less : YMF-C of piping temperature (TH5) is detected for 3 consecutive minutes.
- Forcible defrosting operations start by turning on forcible defrost switch (SW2-7) if 3 minutes have already elapsed after compressor start or completion of defrosting operations.

2) Completion of defrosting operations

Defrosting operations stop when 10 min : P-YMF-C, 15 min : YMF-C have passed since start of defrosting operation, or piping temperature (TH5) reaches 8°C or more.
 (Defrosting operations do not stop for 2 minutes after starting, except when piping temperature exceeds 20°C .)

3) Defrosting prohibition

Defrosting operations do not start during oil recovery, and for 10 minutes after starting compressor.

4) Trouble during defrosting operations

When trouble is detected during defrosting operations, the defrosting operations stop, and defrosting prohibition time decided by integrated operation time of compressor is set to be 20 minutes.

5) Change in number of operating indoor units during defrosting operations

- In case number of operating indoor units changes during defrosting operations, the defrosting operations continue, and control of unit number change is performed after the defrosting operations are finished.
- Even in case all indoor units stop or thermostat is turned off during defrosting operations, the defrosting operations do not stop until expected defrosting activities are completed.

② PURY-(P)200-250YMF-C

1) Starting of defrost operations

- After integrated 43 minutes of compressor operations, defrosting operations start when -8°C : P-YMF-C, -6°C : YMF-C or less of piping temperature (TH7) is detected for 3 consecutive minutes.
- Forcible defrosting operations start by turning on forcible defrost switch (SW2-7) if 3 minutes have already elapsed after compressor start or completion of defrosting operations.

2) Completion of defrosting operations

Defrosting operations stop when 10 minutes have passed since start of defrosting operation, or piping temperature (TH5) reaches 8°C or more.
(Defrosting operations do not stop for 4 minutes after starting, except when piping temperature exceeds (TH5 and TH7) 20°C and $P_d > 10\text{kg/cm}^2\text{G}$ (0.98MPa).)

3) Defrosting prohibition

Defrosting operations do not start during oil recovery, and for 10 minutes after starting compressor.

4) Trouble during defrosting operations

When trouble is detected during defrosting operations, the defrosting operations stop, and defrosting prohibition time decided by integrated operation time of compressor is set to be 20 minutes.

5) Change in number of operating indoor units during defrosting operations

- In case number of operating indoor units changes during defrosting operations, the defrosting operations continue, and control of unit number change is performed after the defrosting operations are finished.
- Even in case all indoor units stop or thermostat is turned off during defrosting operations, the defrosting operations do not stop until expected defrosting activities are completed.

(8) Control of liquid level detecting heater

Detect refrigerant liquid level in accumulator, and heat refrigerant with liquid level heater for judging refrigerant amount. 6 steps of duty control is applied to liquid level heater depending on frequency and outdoor air temperature, 1minute after starting compressor.

(9) Judgement of refrigerant amount

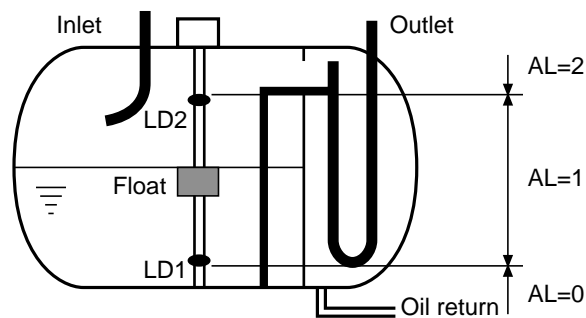

	LD2 OFF	LD2 ON
LD1 ON	AL=1	—
LD1 OFF	AL=0	AL=2

LD : Liquid level Detected Switch

(10) Refrigerant recovery control (PU(H)Y-(P)200-250YMF-C)

Refrigerant recovery is conducted to prevent refrigerant from accumulating in the stopped unit (fan unit), the unit under cooling mode and that with heating thermostat being turned off.

1) Start of refrigerant recovery

- ① Refrigerant recovery is started when the two items below are fully satisfied.
 - 15 minutes has passed after finishing refrigerant recovery.
 - The discharge temperature is high.

2) Refrigerant recovery operation

- Refrigerant is recovered by opening LEV of the objective indoor units (indoor units under stop. fan, and cooling modes, and that with heating thermostat being turned off) for 30 seconds.

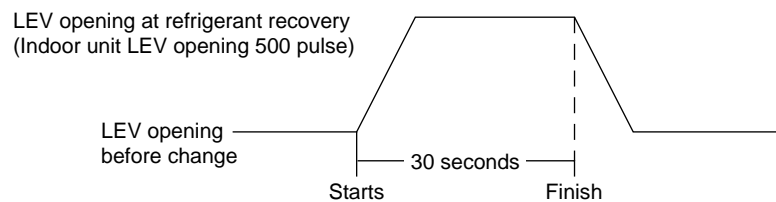

- The regular capacity control of the outdoor unit and the regular LEV control of the indoor unit are not applied during refrigerant recovery operation, but are fixed with the value before the recovery operation. These controls will be conducted one minute after finishing the recovery operation.
- Defrosting operation is prohibited during the recovery operation, and it will be conducted after finishing the recovery operation.

(11) Control of outdoor unit fan and outdoor unit heat exchanger capacity

① PU(H)Y-200-250YMF-C

1) Control system

Depending on capacity required, control outdoor fan flow rate with phase control, for maintaining evaporation temperature (0°C when $P_d \geq 15\text{kg/cm}^2\text{G}$ (1.47MPa), lower than 0°C when $P_d < 15\text{kg/cm}^2\text{G}$ (1.47MPa) in cooling operations, and high pressure $18\text{kg/cm}^2\text{G}$ (1.76MPa) in heating operations.

2) Control

- Outdoor unit fan stops when compressor stops.
- Fan is in full operation for 5 seconds after starting.
- Outdoor unit fan stops during defrosting operations.

② PUHY-P200-250YMF-B, PURY-(P)200-250YMF-C

1) Control system

Depending on capacity required, control outdoor fan flow rate with phase control, for maintaining evaporation temperature (0°C) in cooling operations, and high pressure saturated temperature (49°C) in heating operations.

2) Control

- Outdoor unit fan stops when compressor stops.
- Fan is in full operation for 5 seconds after starting.
- Outdoor unit fan stops during defrosting operations.

[2] Control of BC Controller

(1) Control of SVA, SVB and SVC

SVA, SVB and SVC are turned on and off depending on connection mode.

Connection \ Mode	Cooling	Heating	Stop	Defrost
SVA	ON	OFF	OFF	OFF
SVB	OFF	ON	OFF	OFF
SVC	ON	OFF	OFF	OFF

(2) Control of SVM

SVM is turned on and off corresponding to operation mode.

Operation mode	Cooling-only	Cooling-main	Heating-only	Heating-main	Stop
SVM	ON	OFF	OFF	OFF	OFF

* SVM is not built in depending on models.

(3) Control of LEV

LEV opening (sj) is controlled corresponding to operation mode as follows:

(Number of pulse)

Operation mode	Cooling-only	Heating-only	Cooling-main	Heating-main	Stop
LEV1	2000	60	<ul style="list-style-type: none"> • Liquid level control *3 • Differential pressure control *2 	60	2000
LEV3	Superheat control *1	Differential Pressure control *2		Differential Pressure control *2	60

*1	Superheat control	Control every minute so that superheat amount detected by bypass inlet and outlet temperatures (TH12, TH15) stay in the specified range.
*2	Differential pressure control	Control every minute so that detected differential pressure (PS1, PS3) stay in the specified range.
*3	–	60 or more pulses are sometimes detected because of rise in liquid side pressure (PS1).

* Please confirm that the above parts of BC controllers are being color-coded and shown with the name plate inside the BC controller unit.

[3] Operation Flow Chart

(1) Outdoor unit

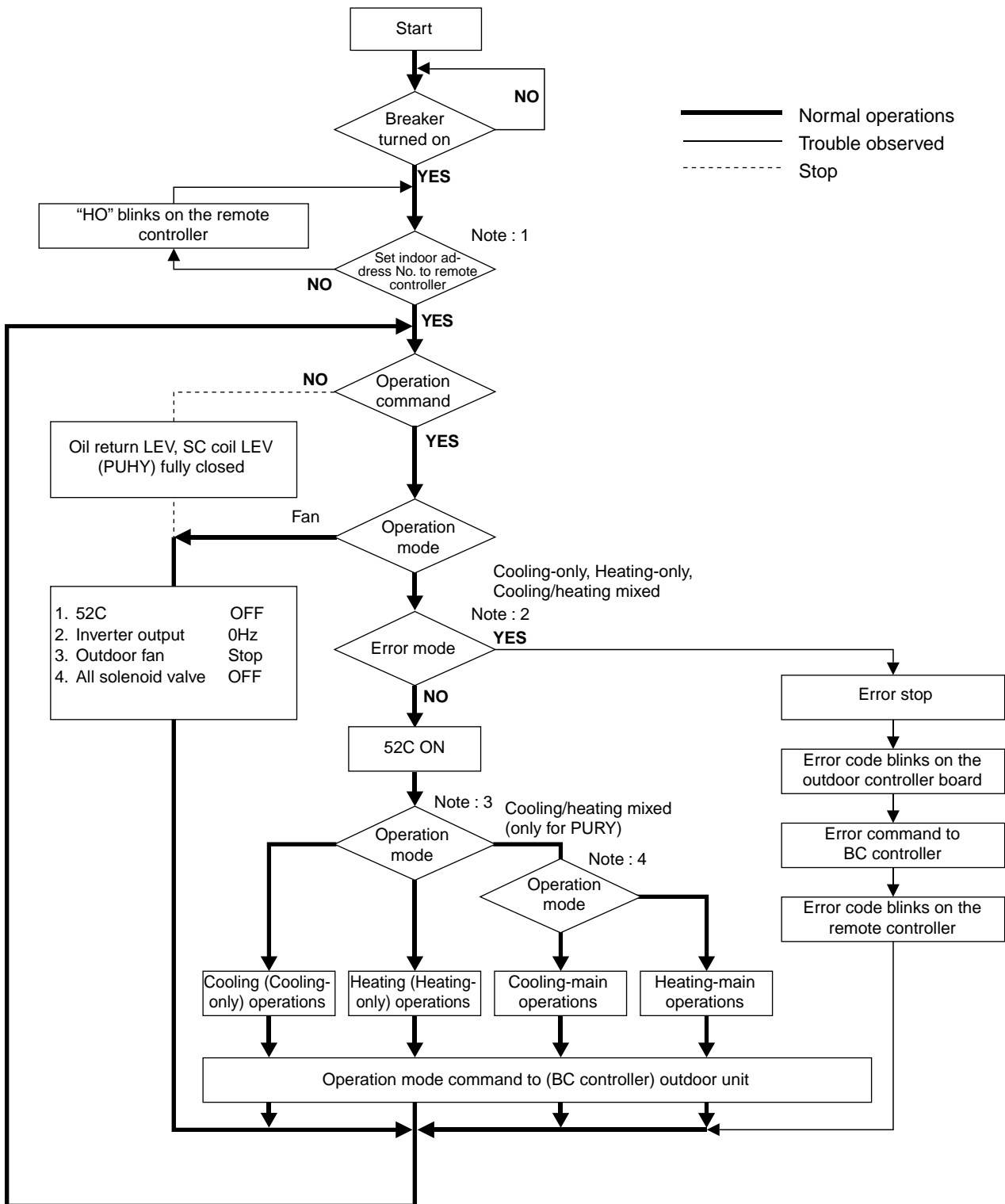

Note : 1	For about 3 minutes after turning on power source, address and group information of outdoor unit, BC, controller indoor unit, and remote controller are retrieved by remote controller, during which "HO" blinks on and off on remote controller. In case indoor unit is not grouped to remote controller, "HO" display on remote controller continues blinking even after 3 minutes after turning on power source.
Note : 2	Two trouble modes included indoor unit side trouble, (BC controller trouble) and outdoor unit side trouble. In the case of indoor unit side trouble, error stop is observed in outdoor unit only when all the indoor units are in trouble. However, if one or more indoor units are operating normally, outdoor unit shows only LED display without undergoing stop.
Note : 3	On PUHY system, operation mode conforms to mode command by indoor unit. However, when outdoor unit is being under cooling operation, the operation of indoor unit will be prohibited even by setting a part of indoor units under operation, or indoor unit under stopping or fan mode to heating mode. Reversely when outdoor unit is being heating operation, the same condition will be commenced. On PURY system, operation mode conforms to mode command by BC controller.
Note : 4	In case BC controller issues cooling/heating mixed operation mode, outdoor unit decides operation mode of cooling-main operation or heating-main operation.

(2) BC controller (for PURY)

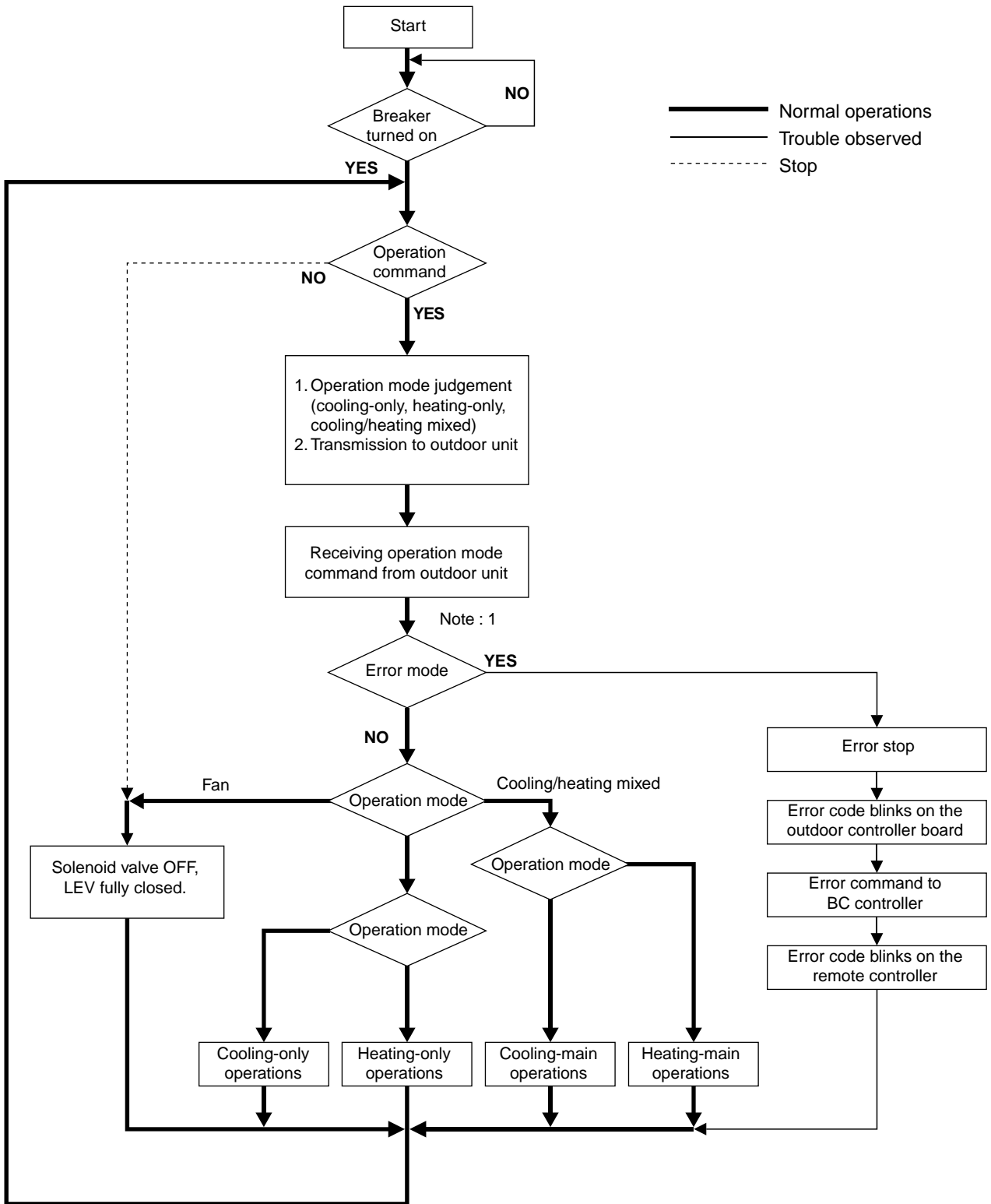

Note : 1 Two error modes include indoor unit side trouble, BC controller trouble, and outdoor unit side trouble. In the case of indoor unit side trouble, error stop is observed in the concerned indoor unit only, and in the cases of BC controller and outdoor unit side troubles, error stop is observed in all the indoor units, BC controller, and outdoor unit.

(3) Indoor unit

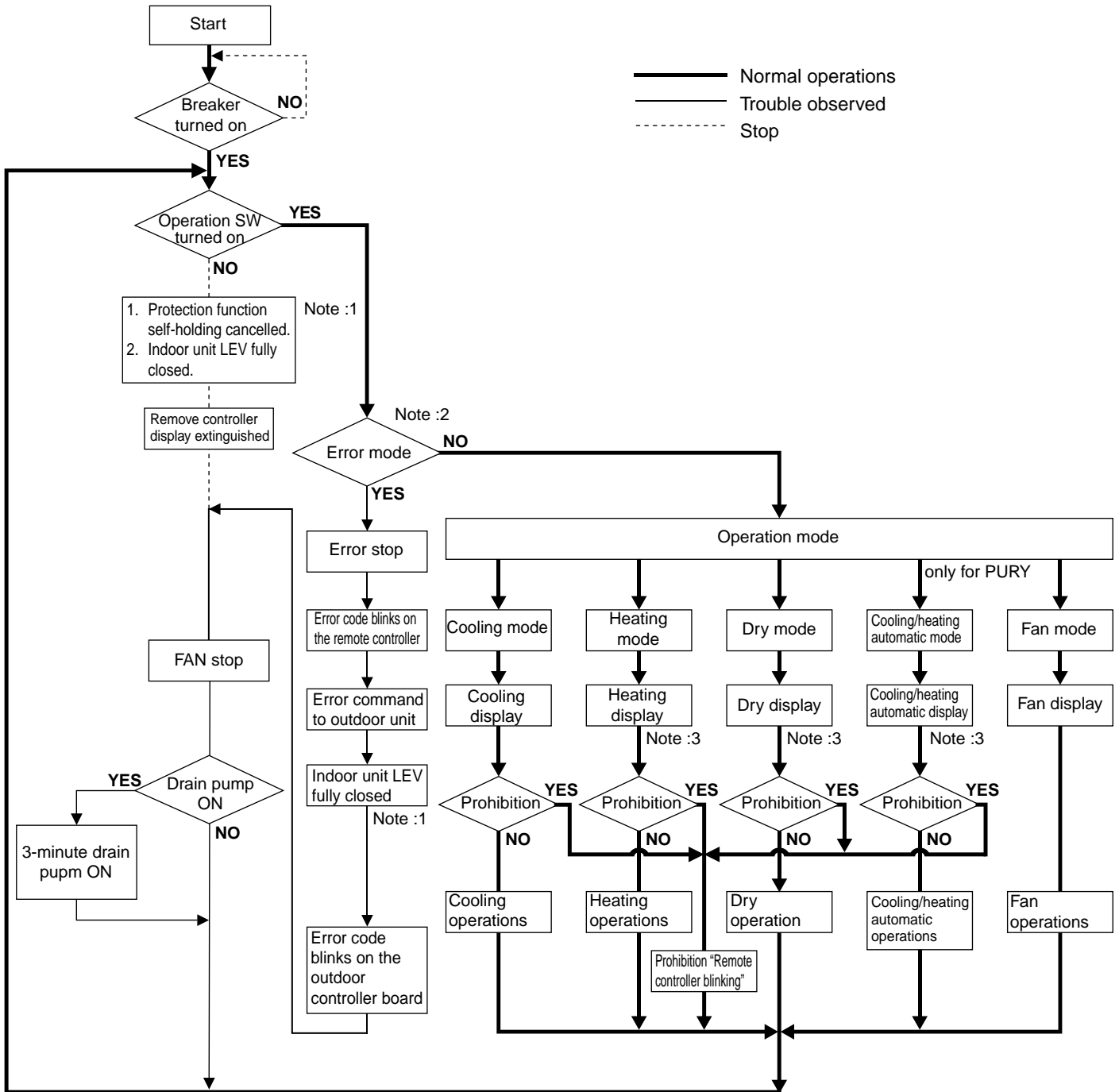

Note : 1	Indoor unit LEV fully closed : Opening 60
Note : 2	Two error modes include indoor unit trouble, (BC controller trouble) and outdoor unit side trouble. In the case of indoor unit trouble, error stop is observed in the concerned indoor unit only, and in the cases of (BC controller and) outdoor unit side troubles, error stop is observed in all the indoor units connected.
Note : 3	“Prohibition” status is observed (when several indoor units are connected to one connection, of BC controller and) when connection mode is different from indoor unit operation mode. (Operation mode display on the remote controller blinks on and off, fan stops, and indoor unit LEV is fully closed.)

(4) Cooling operation

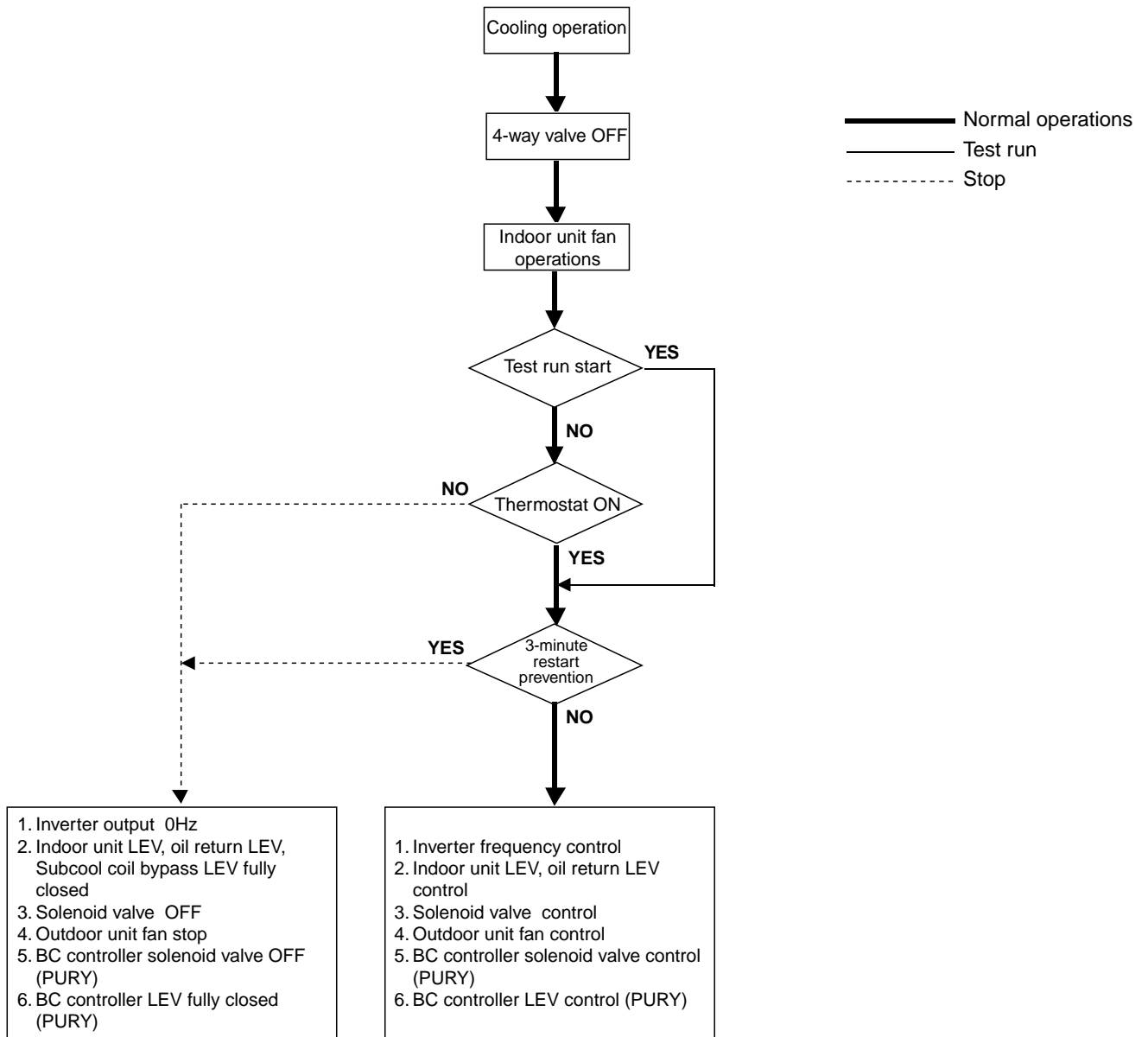

(5) Heating operation

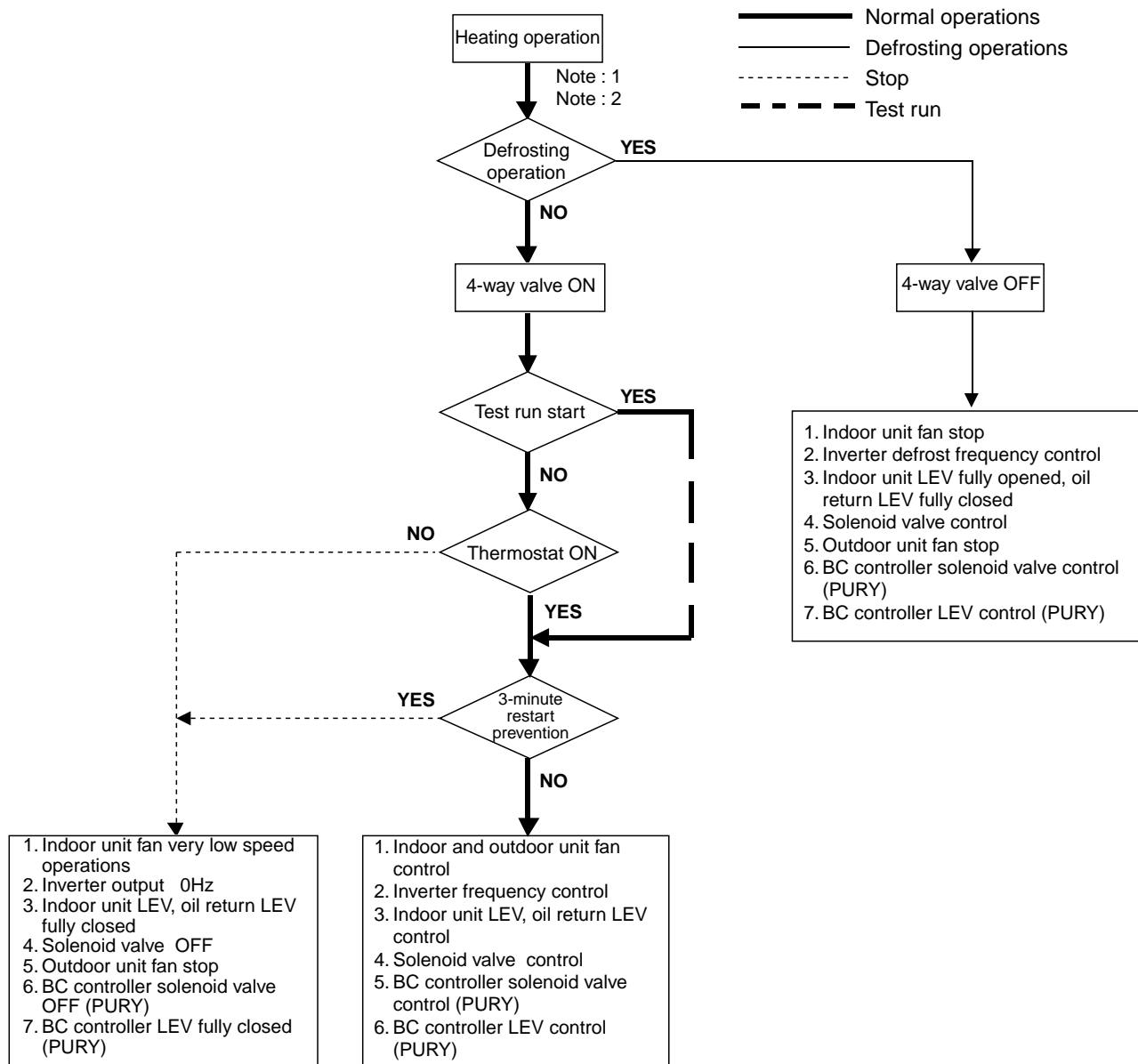

Note : 1	When outdoor unit starts defrosting, it transmits defrost operations command to (BC controller and) indoor unit, and the indoor unit starts defrosting operations. Similarly when defrosting operation stops, indoor unit returns to heating operation after receiving defrost end command of outdoor unit.
Note : 2	<p>① PUHY-(P)200-250YMF-C Defrosting start condition : After integrated 39 minutes : P-YMF-C, 43 minutes : YMF-C of compressor operations, and -4°C : P-YMF-C, -2°C : YMF-C or less outdoor unit coil temperature. Defrosting end condition : After 10 minutes : P-YMF-C, 15 minutes : YMF-C of defrosting operation or the outdoor unit coil temperature having risen to 8°C or more.</p> <p>② PURY-(P)200-250YMF-C Defrosting start condition : After integrated 43 minutes of compressor operations, and -8°C:P-YMF-C, -6°C:YMF-C or less outdoor unit coil temperature. (TH7) Defrosting end condition : After 15 minutes of defrosting operation or the outdoor unit coil temperature (TH5 and TH7) having risen to 8°C or more.</p>

(6) Dry operation

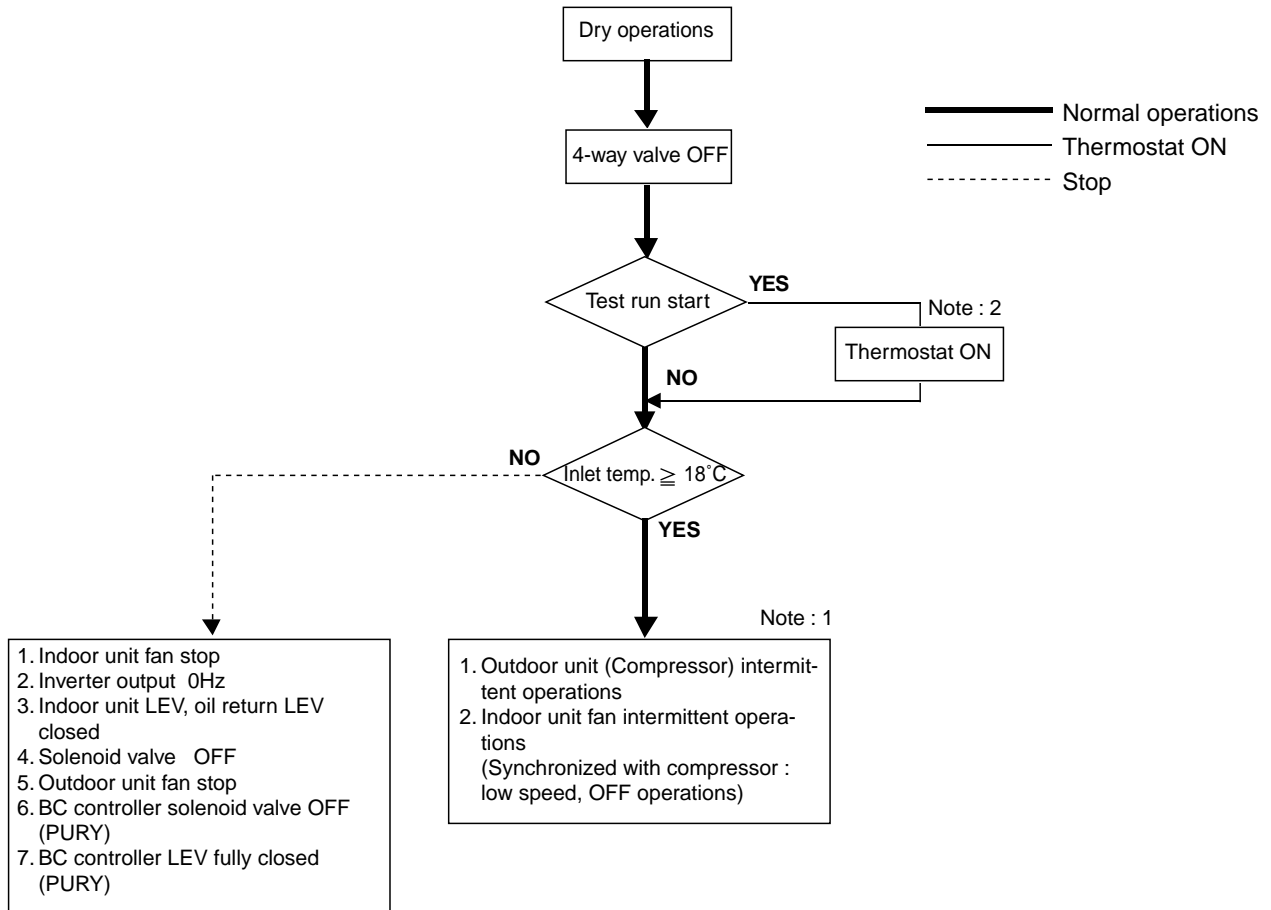

Note : 1	When indoor unit inlet temperature exceeds 18°C, outdoor unit (compressor) and indoor unit fan start intermittent operations synchronously. Operations of outdoor unit, BC controller (PURY), indoor unit LEV and solenoid valve accompanying compressor are the same as those in cooling operations.
Note : 2	Thermostat is always kept on in test run, and indoor and outdoor unit intermittent operation (ON) time is a little longer than normal operations.

[4] List of Major Component Functions

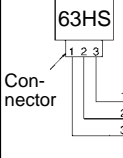
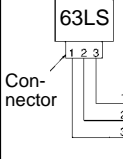
	Name	Symbol (function)	Application	Specification	Check method	Object
Outdoor unit	Compressor	MC	Adjust refrigerant circulation by controlling operating frequency and capacity control valve with operating pressure.	Low pressure shell scroll type with capacity control mechanism Winding resistance: Each phase 0.388Ω (20°C)		<ul style="list-style-type: none"> • PU(H)Y-(P)200-250YMF-C • PURY-(P)200-250YMF-C
	High pressure sensor	63HS	<ol style="list-style-type: none"> 1) High press. detection. 2) Frequency control and high pressure protection 	 <p>Pressure 0~30 kg/cm²G (0~2.94MPa) Vout 0.5~3.5 V Gnd (black) Vout (white) Vc (DC5V) (red)</p>		
	Low pressure sensor	63LS	<ol style="list-style-type: none"> 1) Detects low pressure 2) Calculates the refrigerant circulation configuration. 3) Protects the low pressure 	 <p>Pressure 0~10 kg/cm²G (0~0.98MPa) Vout 0.5~3.5 V Gnd (black) Vout (white) Vc (DC5V) (red)</p>		<ul style="list-style-type: none"> • PU(H)Y-P200-250YMF-C • PURY-(P)200-250YMF-C
	Pressure switch	63H	<ol style="list-style-type: none"> 1) High pressure detection 2) High pressure protection 	Setting 30kg/cm ² G (2.94MPa) OFF	Continuity check	<ul style="list-style-type: none"> • PU(H)Y-(P)200-250YMF-C • PURY-(P)200-250YMF-C
	Thermistor (discharge)	TH1	<ol style="list-style-type: none"> 1) Discharge temperature detection 2) High pressure protection 	$R_{120}=7.465k\Omega$ $B_{25/120}=4057$ $R_t = 7.465 \exp\left\{4057\left(\frac{1}{273+t} - \frac{1}{273+120}\right)\right\}$	Resistance value check	<ul style="list-style-type: none"> • PU(H)Y-(P)200-250YMF-C • PURY-(P)200-250YMF-C
	TH2 (low pressure saturation temperature)	<ol style="list-style-type: none"> 1) Detects the saturated vapor temperature. 2) Calculates the refrigerant circulation configuration. 3) Controls the compressor frequency. 4) Controls the outdoor unit's fan air volume. 	$R_0=33k\Omega$ $B_{0/100}=3965$ $R_t = 33 \exp\left\{3965\left(\frac{1}{273+t} - \frac{1}{273+0}\right)\right\}$	Resistance value check	<ul style="list-style-type: none"> • PU(H)Y-(P)200-250YMF-C • PURY-P200-250YMF-C 	
	TH5 (piping temperature)	<ol style="list-style-type: none"> 1) Frequency control 2) Defrost control and liquid level detection at heating 	$R_0=15k\Omega$ $B_{0/100}=3460$ $R_t = 15 \exp\left\{3460\left(\frac{1}{273+t} - \frac{1}{273+0}\right)\right\}$	Resistance value check	<ul style="list-style-type: none"> • PU(H)Y-(P)200-250YMF-C • PURY-(P)200-250YMF-C 	
	TH6 (outdoor air temperature)	<ol style="list-style-type: none"> 1) Outdoor air temperature detection 2) Fan control, liquid level heater, and opening setting for oil return 	$0^\circ\text{C} : 15k\Omega$ $10^\circ\text{C} : 9.7k\Omega$ $20^\circ\text{C} : 6.4k\Omega$ $25^\circ\text{C} : 5.3k\Omega$ $30^\circ\text{C} : 4.3k\Omega$ $40^\circ\text{C} : 3.1k\Omega$			
	TH7 (subcool coil outlet temperature)	Subcool coil bypass LEV (LEV1) control				
	TH8 (subcool coil bypass outlet temperature)	Subcool coil bypass LEV (LEV1) control				
TH9	<ol style="list-style-type: none"> 1) Detects the CS circuit fluid temperature. 2) Calculates the refrigerant circulation configuration. 					
						<ul style="list-style-type: none"> • PU(H)Y-(P)200-250YMF-C • PURY-P200-250YMF-C

	Name	Symbol (function)	Application	Specification	Check method	Object
Outdoor unit	Thermistor	TH10 (P-YMF-C only)	1) Detects the compressor shell temperature. 2) Provides compressor shell overheating protection.	$R_{120}=7.465k\Omega$ $B_{25/120}=4057$ $R_t = 7.465 \exp \left\{ 4057 \left(\frac{1}{273+t} - \frac{1}{273+120} \right) \right\}$ 20°C : 250kΩ 70°C : 34kΩ 30°C : 160kΩ 80°C : 24kΩ 40°C : 104kΩ 90°C : 17.5kΩ 50°C : 70kΩ 100°C : 13.0kΩ 60°C : 48kΩ 110°C : 9.8kΩ		<ul style="list-style-type: none"> • PU(H)Y-P200-250 YMF-C • PURY-P200-250 YMF-C
		THHS	1) Detects the inverter cooling fin temperature. 2) Provides inverter overheating protection. 3) Controls the control box cooling fan.	$R_{50}=17k\Omega$ $B_{25/50}=4170$ $R_t = 17 \exp \left\{ 4170 \left(\frac{1}{273+t} - \frac{1}{273+50} \right) \right\}$ -20°C : 605.0kΩ 50°C : 17.0kΩ -10°C : 323.3kΩ 60°C : 11.5kΩ 0°C : 180.9kΩ 70°C : 8.0kΩ 10°C : 105.4kΩ 80°C : 5.7kΩ 20°C : 63.8kΩ 90°C : 4.1kΩ 30°C : 39.9kΩ 100°C : 3.0kΩ 40°C : 25.7kΩ		<ul style="list-style-type: none"> • PU(H)Y-(P)200-250 YMF-C • PURY-(P)200-250 YMF-C
	Solenoid valve	SV1 (discharge - suction bypass)	1) High/low press. bypass at starting/stopping and capacity control at low load 2) Discharge press. rise suppression	AC 220~240V Open at energizing and close at deenergizing	<ul style="list-style-type: none"> • Continuity check by tester • Temperature of inlet and outlet. 	<ul style="list-style-type: none"> • PU(H)Y-P200-250 YMF-C • PURY-(P)200-250 YMF-C
		SV2 (discharge - suction bypass)	Capacity control and high press. rise suppression (backup for frequency control)			
		SV3 ~ 5	Control of heat exchanger capacity.			
		SV3 ~ 6	Control of heat exchanger capacity.			
	Linear expansion valve	SLEV	Adjustment of liquid refrigerant (oil) return foam accumulator	DC12V stepping motor drive Valve opening 0~480 pulse		<ul style="list-style-type: none"> • PU(H)Y-(P)200-250 YMF-C • PURY-(P)200-250 YMF-C
		LEV1 (SC coil)	Adjustment bypass flow rate from outdoor unit liquid line at cooling.			
	Liquid level detection switch	LD1 LD2	Detection of refrigerant liquid level in accumulator		Resistance value check	<ul style="list-style-type: none"> • PU(H)Y-(P)200-250 YMF-C • PURY-(P)200-250 YMF-C
	Indoor unit	Linear expansion valve	LEV	1) Adjust superheat of outdoor unit heat exchanger outlet at cooling. 2) Adjust subcool of indoor unit heat exchanger at heating.	DC12V Opening of stepping motor driving valve 60~2,000 pulses	Continuity check with tester for white-red-orange yellow-brown-blue
Thermistor		TH21 (inlet air temperature)	Indoor unit control (thermostat)	$R_0 = 15k\Omega$ $B_{0/100} = 3460$	Resistance value check	
		TH22 (piping temperature)	1) Indoor unit control (freeze prevention, hot adjust, etc.) 2) LEV control in heating operation (Subcool detection)	$R_t = 15 \exp \left\{ 3460 \left(\frac{1}{273+t} - \frac{1}{273+0} \right) \right\}$ 0°C : 15kΩ 10°C : 9.7kΩ 20°C : 6.4kΩ 25°C : 5.3kΩ 30°C : 4.3kΩ 40°C : 3.1kΩ		
		TH23 (gas side piping temperature)	LEV control in cooling operation (Superheat detector)			

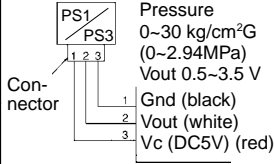
	Name	Symbol (function)	Application	Specification	Check method	Object
BC controller	Pressure sensor	PS1	1) Liquid pressure (high-pressure) detection 2) LEV control	 <p>Pressure 0~30 kg/cm²G (0~2.94MPa) Vout 0.5~3.5 V Gnd (black) Vout (white) Vc (DC5V) (red)</p>		
		PS3	1) Intermediate pressure detection 2) LEV control			
	Thermistor	TH11 (liquid inlet temperature)	LEV control (liquid refrigerant control)	$R_0=15k\Omega$ $B_{0/100}=3460$ $R_t = 15 \exp\left\{3460\left(\frac{1}{273+t} - \frac{1}{273+0}\right)\right\}$ 0°C : 15kΩ 10°C : 9.7kΩ 20°C : 6.4kΩ 25°C : 5.3kΩ 30°C : 4.3kΩ 40°C : 3.1kΩ		
		TH12 (bypass outlet pressure)	LEV control (superheat control)			
		TH15 (bypass outlet temperature)	LEV control (superheat control)			
		TH16 (bypass inlet temperature)	LEV control (subcool control)			
	Solenoid valve	SVM *1	Opens for cooling-only, defrosting.	AC 220~240V Open when energized Closed when de-energized	Continuity check by a tester	
		SVA	Supplies refrigerant to cooling indoor unit.			
		SVB	Supplies refrigerant to heating indoor unit.			
		SVC	Supplies refrigerant to cooling indoor unit.			
Electronic expansion valve	LEV1	Liquid level control pressure control	12V DC stepping motor drive 0 to 2000 valve opening pulse	Same as LEV of indoor unit.		
	LEV3	Liquid level control pressure control				

*1. SVM is not built in depending on models.

[5] Resistance of Temperature Sensor

Thermistor for low temperature

Thermistor $R_0 = 15k\Omega \pm 3\%$ (TH3 ~ 9)

$$R_t = 15 \exp \left\{ 3460 \left(\frac{1}{273+t} - \frac{1}{273+0} \right) \right\}$$

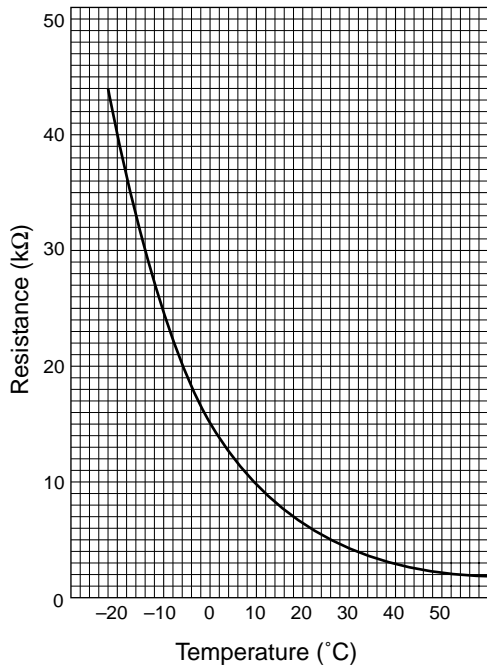

Thermistor $R_{120} = 7.465k\Omega \pm 2\%$ (TH1, 10)

$$R_t = 7.465 \exp \left\{ 4057 \left(\frac{1}{273+t} - \frac{1}{273+120} \right) \right\}$$

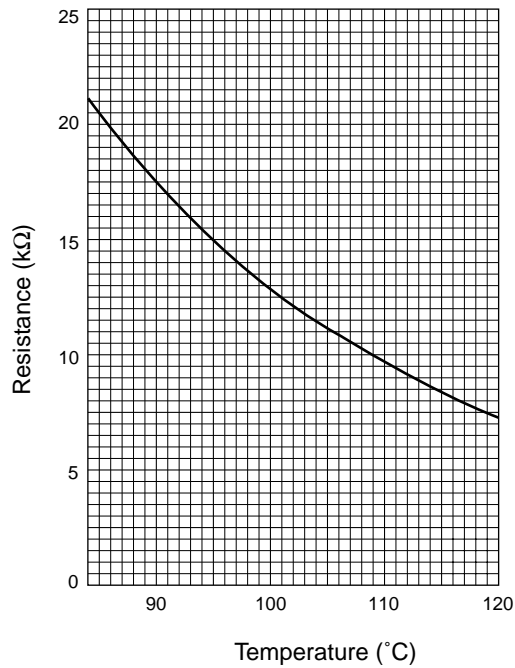

Thermistor $R_0 = 33k\Omega \pm 1\%$ (TH2)

$$R_t = 33 \exp \left\{ 3965 \left(\frac{1}{273+t} - \frac{1}{273+0} \right) \right\}$$

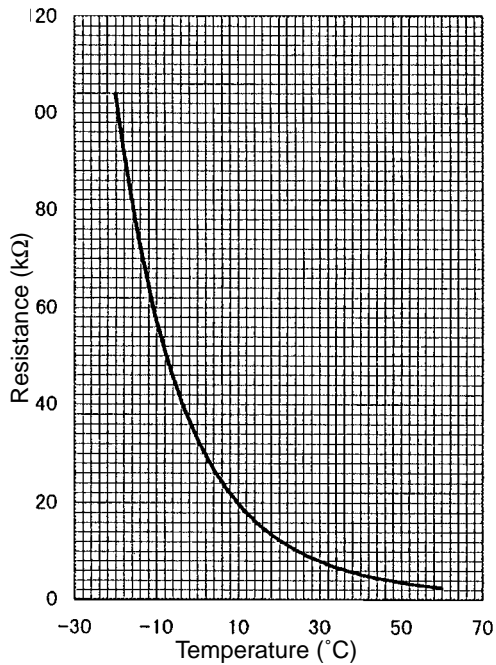

Thermistor $R_{50} = 17k\Omega \pm 2\%$ (THHS)

$$R_t = 17 \exp \left\{ 4170 \left(\frac{1}{273+t} - \frac{1}{273+50} \right) \right\}$$

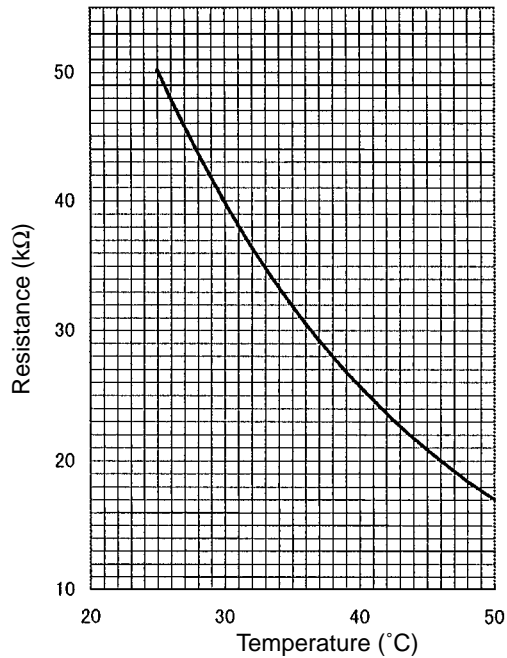

6 REFRIGERANT AMOUNT ADJUSTMENT

Clarify relationship between the refrigerant amount and operating characteristics of CITY MULTI, and perform service activities such as decision and adjustment of refrigerant amount on the market.

[1] Refrigerant Amount and Operating Characteristics

The followings are refrigerant amount and operating characteristics which draw special attention.

1	During cooling operations, required refrigerant amount tends to increase (refrigerant in accumulator decreases) in proportion to increase in the number of operating indoor units. However, the change of increase rate is small.		
2	During heating operations, liquid level of accumulator is the highest when all the indoor units are operating.		
3	Discharge temperature hardly changes when increasing or decreasing refrigerant amount with accumulator filled with refrigerant.		
4	Tendency of discharge temperature	During cooling operations, discharge temperature tends to rise at overload than low temperature.	Comparison including control system
		During heating operations, discharge temperature tends to rise at low temperature than overload.	
		The lower operating frequency is, the higher discharge temperature tends to become of deteriorated compressor efficiency.	
5	Compressor shell temperature is 20~70 degrees higher than low pressure saturation temperature (Te) when refrigerant amount is appropriate. → Judged as over replenishment when temperature difference from low pressure saturation temperature (Te) is 10 degrees or less.		

[2] Adjustment and Judgement of Refrigerant Amount

(1) Symptom

The symptoms shown in the table below are the signs of excess or lack of refrigerant amount. Be sure to adjust refrigerant amount in refrigerant amount adjustment mode, by checking operation status, judging refrigerant amount, and performing selfdiagnosis with LED, for overall judgement of excess or lack of refrigerant amount.

1	Emergency stop at 1500 remote controller display (excessive refrigerant replenishment)	Excessive refrigerant replenishment
2	Operating frequency does not fully increase, thus resulting in insufficient capacity	Insufficient refrigerant replenishment
3	Emergency stop at 1102 remote controller display (discharge temperature trouble)	
4	Emergency stop occurs when the remote control display is at 1501. (insufficient refrigerant)	Insufficient refrigerant

(2) Refrigerant Volume Adjustment Operation (PU(H)Y-(P)200-250YMF-C)

1) Operating Characteristics Refrigerant Volume

Characteristic items related to operating characteristics and the refrigerant volume are shown below.

1	If the number of indoor units in operation increases during cooling, the required volume of refrigerant tends to increase (the amount of refrigerant in the accumulator tends to decrease), but the change is minimal.		
2	The liquid level in the accumulator is at its highest when all the indoor units are operating during heating.		
3	If there is refrigerant in the accumulator, even if the volume of refrigerant is increased or decreased, there is practically no change in the outlet temperature.		
4	Tendency of discharge Temperature	During cooling, the discharge temperature rises more easily when there is an overload than when the temperature is low.	Comparison when control is included.
		During heating, the discharge temperature rises more easily when the temperature is low than when there is an overload.	
		The lower the operating frequency, the less efficient the compressor is, making it easier for the discharge temperature to rise.	
5	The compressor shell temperature becomes 20~70 deg. higher than the low pressure saturation temperature (TH2) if the refrigerant volume is appropriate. If the difference with the low pressure saturation temperature (TH2) is 10 deg. or less, it can be judged that the refrigerant is overcharged.		

2) Adjusting and Judging the Refrigerant Volume

① Symptoms

Overcharging with refrigerant can be considered as the cause of the following symptoms. When adjusting the refrigerant volume, be sure that the unit is in the operating condition, and carry out refrigerant volume judgment and self-diagnosis by the LED's, judging overall whether the volume of refrigerant is in excess or is insufficient. Perform adjustments by running the unit in the refrigerant volume adjustment mode.

1	Emergency stop occurs when the remote control display is at 1500 (refrigerant overcharge).	Refrigerant overcharge
2	The operating frequency doesn't rise high enough and capacity is not achieved.	Insufficient refrigerant
3	Emergency stop occurs when the remote control display is at 1102 (outlet temperature overheating).	
4	Emergency stop occurs when the remote control display is at 1501 (insufficient refrigerant).	Insufficient refrigerant

② Refrigerant Volume

a Checking the Operating Condition

Operate all the indoor units on cooling or on heating, checking the discharge temperature, sub-cooling, low pressure saturation temperature, inlet temperature, shell bottom temperature, liquid level, liquid step, etc. and rendering an overall judgment.

Condition		Judgement
1	Outlet temperature is high. (125°C or higher)	Refrigerant volume tends toward insufficient.
2	Low pressure saturation temperature is extremely low.	
3	Inlet superheating is high (if normal, SH = 20 deg or lower).	
4	Shell bottom temperature is high (the difference with the low pressure saturation temperature is 70 deg. or greater)	
5	Shell temperature is low (the difference with the low pressure saturation temperature is 10 deg. or lower).	Refrigerant volume tends toward overcharge.
6	Discharge superheating is low (if normal, SH = 20 deg or higher).	

b Check the refrigerant volume by self-diagnosis using the LED.

Set the self-diagnosis switch (SW1) as shown below and check the past information (history) concerning the refrigerant volume.

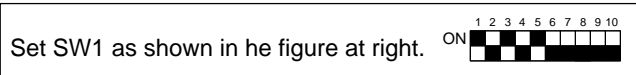

If LD8 lights up, it indicates the refrigerant charge abnormal delay state just before emergency stop due to refrigerant overcharge (1500).

③ Additional Refrigerant Charge Volume

At the time of shipping from the factory, the outdoor unit is charged with the amount of coolant shown in the following table, but since no extension piping is included, please carry out additional charging on-site.

Outdoor Unit Model Name	PU(H)Y-200YMF-C	PU(H)Y-P200YMF-C	PU(H)Y-250YMF-C	PU(H)Y-P250YMF-C
Refrigerant Charge Volume	6.5kg	7.0kg	8.0kg	8.5kg

Calculation Formula

Calculate the additional refrigerant volume by calculating the size of the extension liquid piping and its length (units: m).

$$\text{Additional Refrigerant Volume (kg)} = (0.12 \times L1) + (0.06 \times L2) + (0.024 \times L3) + \alpha$$

- L1: Length of ϕ 12.7 liquid pipe (m)
- L2: Length of ϕ 9.52 liquid pipe (m)
- L3: Length of ϕ 6.35 liquid pipe (m)
- α : refer to the calculation table.

In the calculation results, round up fractions smaller than 0.01 kg. (Example: 18.54 kg → 18.6 kg)

(α Calculation Table)

Total Capacity of Connected Indoor Units	α
~90	1.0 kg
91 ~180	1.5
181 ~370	2.0

⚠ Caution : (PUHY-P200-250YMF-C)

When charging with refrigerant, be sure to charge from the liquid side. If charging from the gas side, it will cause the refrigerant composition to change inside the unit and the composition of the refrigerant remaining in the canister will also change.

3) Refrigerant Volume Adjustment Mode Operation

① Procedure

Depending on the operating conditions, it may be necessary either to charge with supplementary refrigerant, or to drain out some, but if such a case arises, please follow the procedure given below flow chart.

Notes 1 As the refrigerant volume can not be adjusted in the heating mode, retrieve the refrigerant, evacuate air and then fill the specified volume of refrigerant if it is necessary to adjust the refrigerant volume in the winter season.

Notes 2 A refrigerant volume adjustment performed in the cooling mode must be done with a gauge reading of 13 kg/cm²G or higher.

If the pressure does not reach refrigerant cannot be collected halfway.

Therefore, collect used refrigerant and evacuate the unit completely, and then fill new refrigerant up to a specified quantity.

Notes 3 Judgment by the AL is at best only a rough guideline. Please do not add refrigerant based on the AL reading alone. (Be sure to obtain calculations of the correct amount before adding refrigerant.)

Notes 4 When supplementing the refrigerant volume, please be careful to charge with liquid refrigerant.

TH1 Self-diagnosis Switch



TH5 Self-diagnosis Switch



Pd (High pressure)



TH7 Self-diagnosis Switch



Tc Self-diagnosis Switch

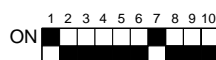

Using these, judge TH1, Tc - TH5 and Tc - TH7.

In case of PUHY-200, 250YMF-C

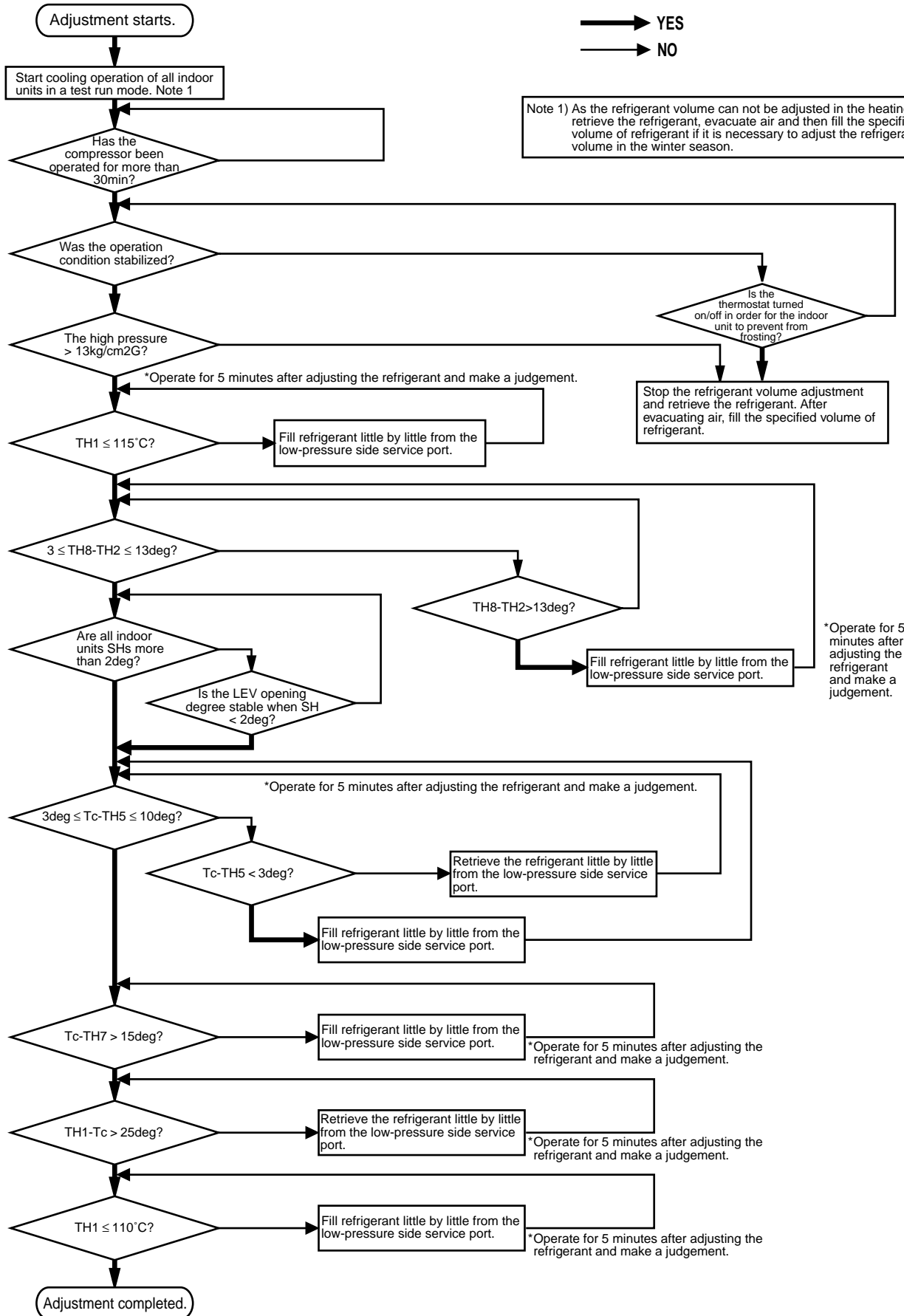

⚠ Caution :

- Do not let the drained out refrigerant escape to the outside atmosphere.
- Always be sure to charge with refrigerant from the liquid phase side. (PUHY-P200-250YMF-C)

In case of PUHY-P200, 250YMF-C

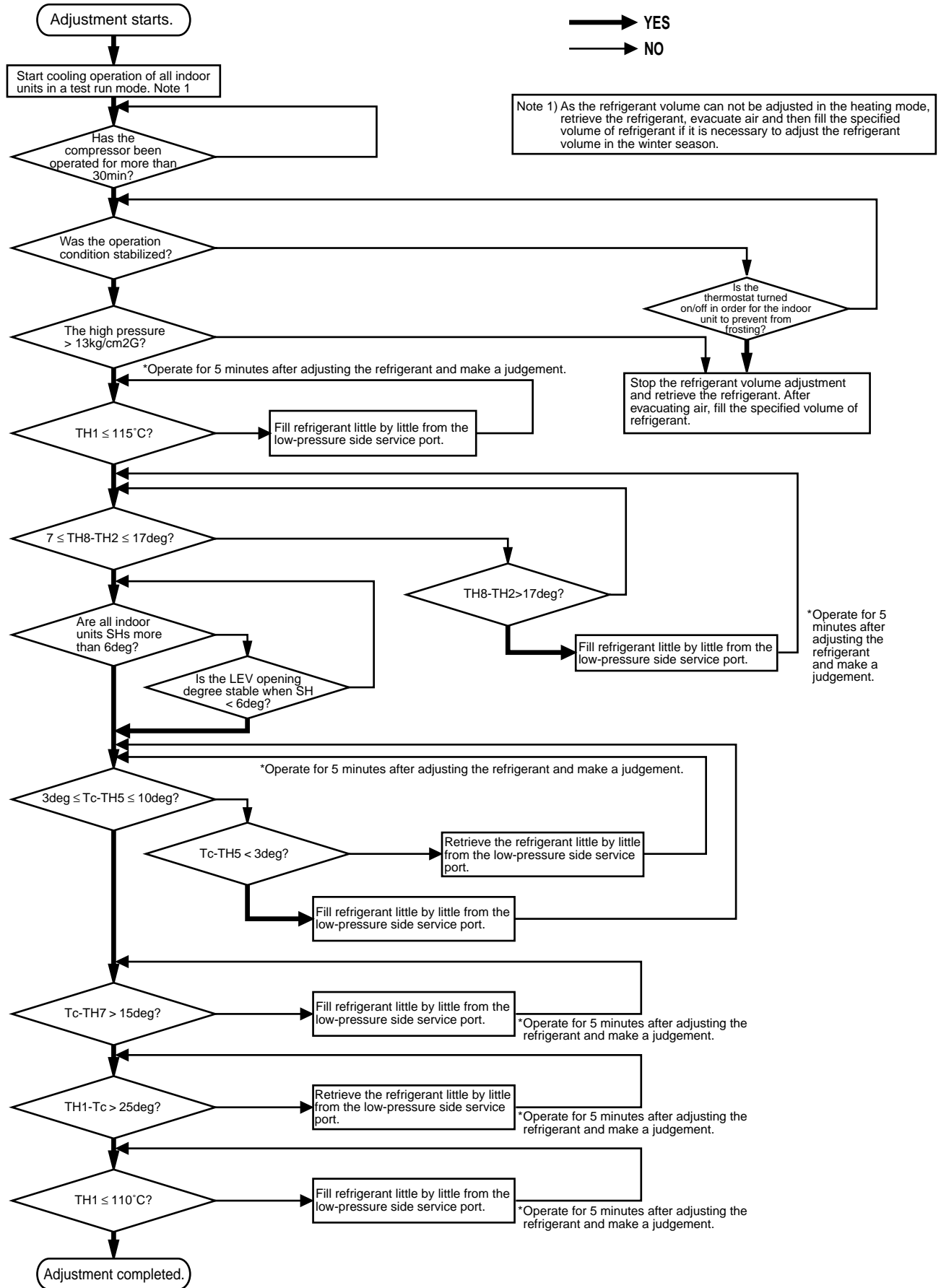

Caution: (PUHY-P200-250YMF-C)
 Always be sure to charge with refrigerant from the liquid phase side.

(3) Refrigerant Amount Adjustment Mode Operations (PURY-(P)200-250YMF-C)

① Procedure

Depending on the operating conditions, it may be necessary either to charge with supplementary refrigerant, or to drain out some, but if such a case arises, please follow the procedure given below flow chart.

Notes 1 As the refrigerant volume can not be adjusted in the heating mode, retrieve the refrigerant, evacuate air and then fill the specified volume of refrigerant if it is necessary to adjust the refrigerant volume in the winter season.

Notes 2 A refrigerant volume adjustment performed in the cooling mode must be done with a gauge reading of 13 kg/cm²G or higher.
If the pressure does not reach refrigerant cannot be collected halfway.
Therefore, collect used refrigerant and evacuate the unit completely, and then fill new refrigerant up to a specified quantity.

Notes 3 Judgment by the AL is at best only a rough guideline. Please do not add refrigerant based on the AL reading alone. (Be sure to obtain calculations of the correct amount before adding refrigerant.)

Notes 4 When supplementing the refrigerant volume, please be careful to charge with liquid refrigerant.

TH1



SC11

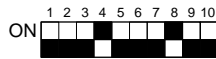

SC16



Pd (High pressure)



In case of PURY-200, 250YMF-C

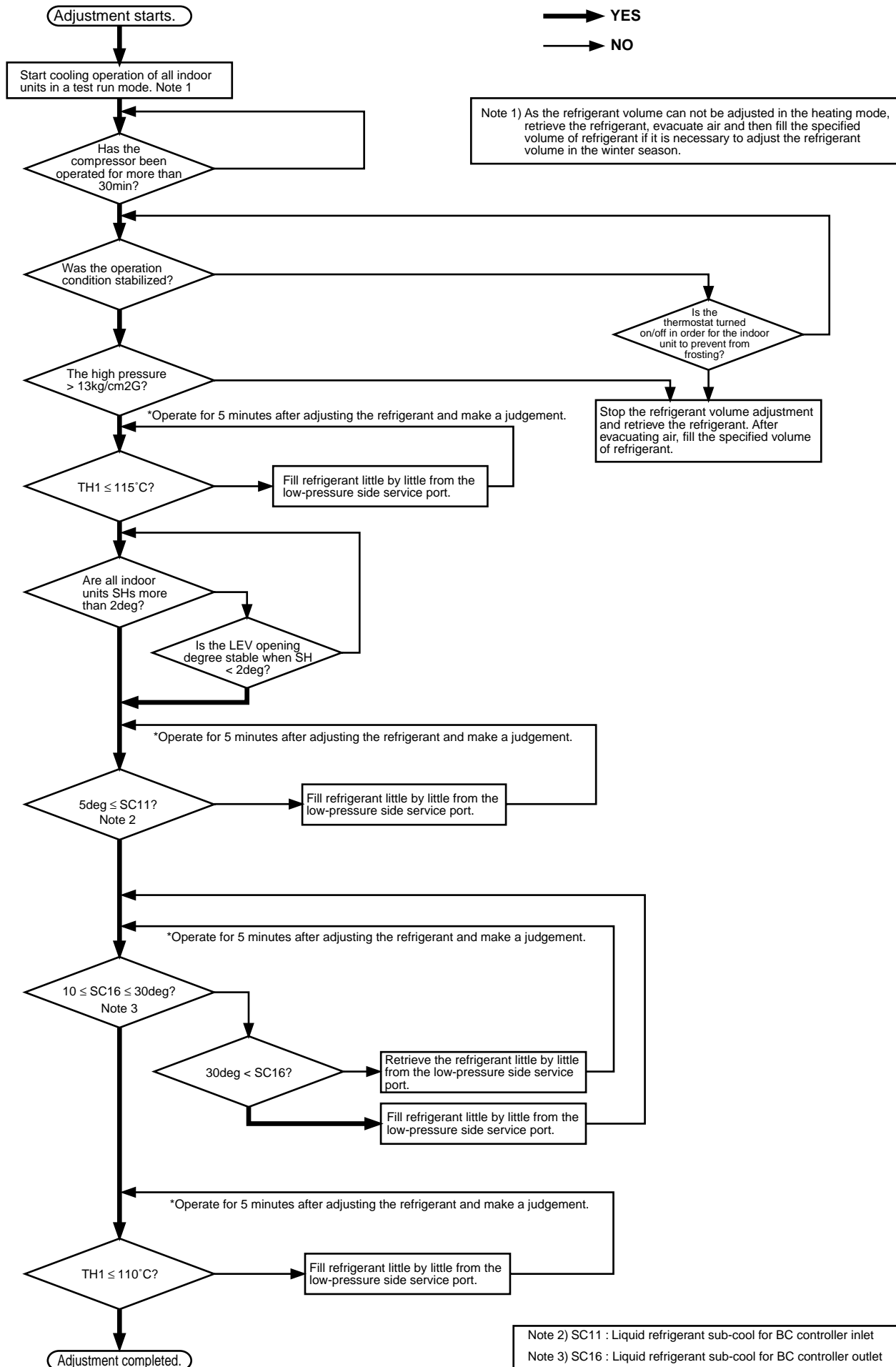

In case of PURY-P200, 250YMF-C

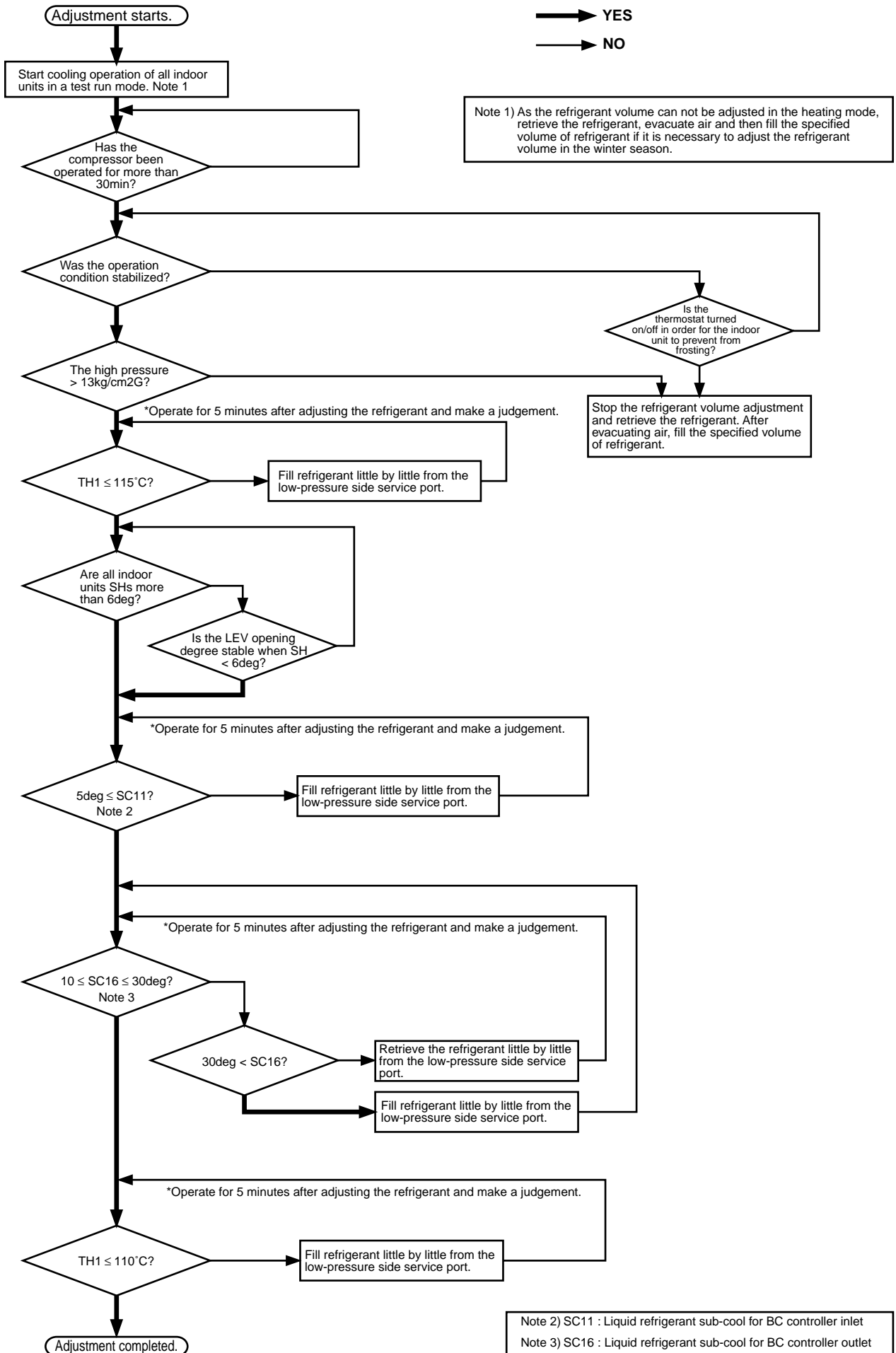

1 Time required for recovering refrigerant from low pressure service port (minute)

Refrigerant amount to be drawn out (kg)	Low pressure (kg/cm ² G) (MPa)		
	3.5~4.5 (0.34~0.44)	4.5~5.5 (0.44~0.54)	5.5 ~ 7.5 (0.54~0.74)
1	4.0	3.5	3.5
2	8.0	7.0	6.5
3	12.0	10.5	10.0
4	16.0	14.0	13.0
5	20.0	18.0	16.5
6	24.0	21.5	19.5
7	28.0	25.0	23.0
8	32.0	28.5	26.0
9	36.0	32.0	29.5
10	40.0	35.5	32.5
11	44.0	39.0	36.0

2 Additional evacuation, refrigerant replacement, and refrigerant replacement

R2 series has unique refrigerant circuit structure which makes possible 2-pipe cooling-heating simultaneous operations. Therefore, in the case of total replacement or replenishment of refrigerant in this system, the following evacuation and refrigerant replenishment procedures are required.

- ① Perform evacuation by connecting to system analyzer joint of service port of high pressure ball valve and high pressure charge plug, and joint of service port of low pressure ball valve and low pressure charge plug.
- ② Perform refrigerant charge from low pressure circuit only, after finishing evacuation, closing vacuum pump valve, shutting off high pressure circuit of system analyzer, and opening valve of refrigerant cylinder.
(In case service port of ball valve and charge plug can not be jointed as shown in the figure, use two vacuum pumps and evacuate high pressure side and low pressure side circuits separately.)

Note 1: Though refrigerant gas itself is harmless, airtight room should be opened before gas release for preventing oxygen shortage.

2: When releasing gas, use blotting paper, etc. so that oil spouted with the gas does not spread out.

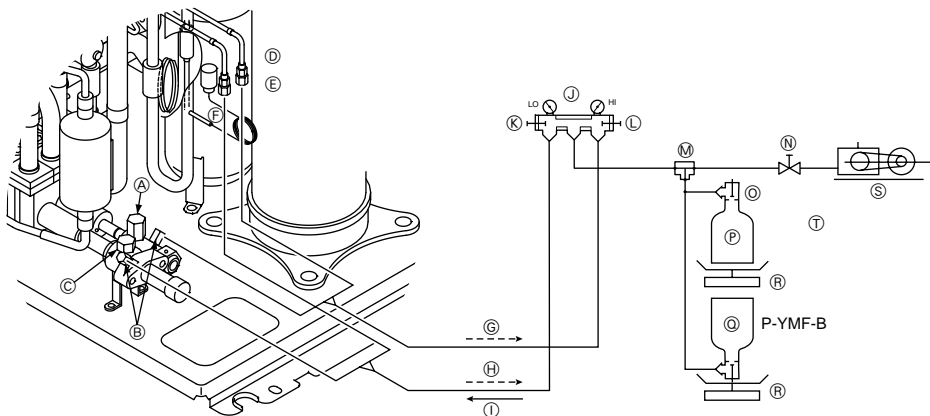

- (A) Ball valve of the high pressure side
- (B) Service port
- (C) Ball valve of the low pressure side
- (D) Charge plug
- (E) High pressure
- (F) Low pressure
- (G) Evacuation
- (H) Evacuation
- (I) Replenish of refrigerant
- (J) System analyzer
- (K) Lo knob
- (L) Hi knob
- (M) 3-way joint

- (N) Valve
 - (O) Valve
 - (P) Flon 22 cylinder
 - (Q) R407C cylinder
 - (R) Scale
 - (S) Vacuum pump
- P-YMF-B : Use a vacuum pump with a reverse flow check valve
- (T) A high-precision gravimeter measurable up to 0.1kg should be used. If you are unable to prepare such a high-precision gravimeter, you may use a charge cylinder.

7 TROUBLESHOOTING

[1] Principal Parts

Pressure Sensor

(1) Judging Failure

- 1) Check for failure by comparing the sensing pressure according to the high pressure/low pressure pressure sensor and the pressure gauge pressure.
Turn on switches 1, 3, 5, 6 (High) and 2, 4, 5, 6 (Low) of the digital display select switch (SW1) as shown below, and the sensor pressure of the high pressure/low pressure sensors is displayed digitally by the light emitting diode LD1.

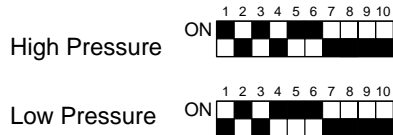

- 1 In the stopped condition, compare the pressure readings from the gauge and from the LD1 display.
 - (a) If the gauge pressure is 0~1 kg/cm²G (0.098MPa), the internal pressure is dropping due to gas leakage.
 - (b) If the pressure according to the LD1 display is 0~1 kg/cm²G (0.098MPa), there is faulty contact at the connector, or it is disconnected. Proceed to 4.
 - (c) If the pressure according to the LD1 display is 32 kg/cm²G (3.14MPa) or higher, proceed to 3.
 - (d) If other than (a), (b) or (c), compare the pressure readings during operation. Proceed to 2.
- 2 Compare the pressure readings from the gauge and from the LD1 display while in the running condition.
 - (a) If the difference between the two pressures is within 1 kg/cm²G (0.098MPa), both the affected pressure sensor and the main MAIN board are normal.
 - (b) If the difference between the two pressures exceeds 1 kg/cm²G (0.098MPa), the affected pressure sensor is faulty (deteriorating performance).
 - (c) If the pressure reading in the LD1 display does not change, the affected pressure sensor is faulty.
- 3 Disconnect the pressure sensor from the MAIN board and check the pressure according to the LD1 display.
 - (a) If the pressure is 0~1 kg/cm²G (0.098MPa) on the LD1 display, the affected pressure sensor is faulty.
 - (b) If the pressure is 32 kg/cm²G (3.14MPa) (in the case of the low pressure sensor, 10 kg/cm²G (0.98MPa)) or higher, the MAIN board is faulty.
- 4 Disconnect the pressure sensor from the MAIN board and short out the No. 2 and No. 3 pins of the connector (63HS, 63LS), then check the pressure by the LD1 display.
 - (a) If the pressure according to the LD1 display is 32 kg/cm²G (3.14MPa) (in the case of the low pressure sensor, 10 kg/cm²G (0.98MPa)) or higher, the affected pressure sensor is faulty.
 - (b) If other than (a), the MAIN board is faulty.

2) Pressure sensor configuration.

The pressure sensors are configured in the circuit shown in the figure at right. If DC 5 V is applied between the red and black wires, a voltage corresponding to the voltage between the white and black wires is output and this voltage is picked up by the microcomputer. Output voltages are as shown below.

High Pressure 0.1 V per 1 kg/cm²G (0.098MPa)
 Low Pressure 0.3 V per 1 kg/cm²G (0.098MPa)

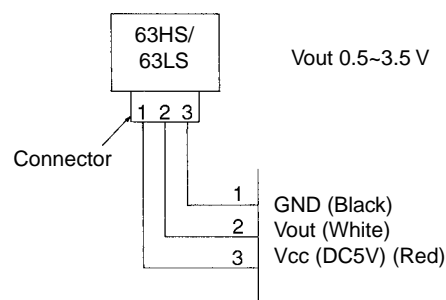

* Connector connection specifications on the pressure sensor body side.

The connector's pin numbers on the pressure sensor body side differ from the pin numbers on the main circuit board side.

	Sensor Body Side	MAIN Board Side
Vcc	Pin 1	Pin 3
Vout	Pin 2	Pin 2
GND	Pin 3	Pin 1

Solenoid Valve (SV1, SV2) (PU(H)Y-200, 250YMF-C)

Check if the control board's output signals and the operation of the solenoid valves match.

Setting the self-diagnosis switch (SW1) as shown in the figure below causes the ON signal of each relay to be output to the LED's.

Each LED shows whether the relays for the following parts are ON or OFF. When a LED lights up, it indicates that the relay is ON.

SW1	LED							
	1	2	3	4	5	6	7	8
				SV1	SV2			

1) In the case of SV1 (Bypass Valve)

- (a) When the compressor starts, SV1 is ON for 4 minutes, so check operation by whether the solenoid valve is emitting an operating noise.
- (b) Changes in the operating condition by solenoid valve operation can be confirmed by the temperature of the bypass circuit and the sound of the refrigerant.

2) In the case of SV2 (Bypass)

- (a) SV2 goes ON in accordance with the rise in the high pressure in the cooling mode and heating mode, so check its operation by the LED display and the operating noise emitted by the solenoid valve.
- (b) Changes in the operating condition by solenoid valve operation can be confirmed by the temperature of the bypass circuit and the sound of the refrigerant.

PU(H)Y-P200, 250YMF-C	LED							
	1	2	3	4	5	6	7	8
				SV1	SV2	SV3	SV4	

1) In the case of SV1 (Bypass Valve)

- (a) When the compressor starts, SV1 is ON for 4 minutes, so check operation by whether the solenoid valve is emitting an operating noise.
- (b) Changes in the operating condition by solenoid valve operation can be confirmed by the temperature of the bypass circuit and the sound of the refrigerant.

2) In the case of SV2 (Bypass)

- (a) SV2 goes ON in accordance with the rise in the high pressure in the cooling mode and heating mode, so check its operation by the LED display and the operating noise emitted by the solenoid valve.
- (b) Changes in the operating condition by solenoid valve operation can be confirmed by the temperature of the bypass circuit and the sound of the refrigerant.

3) SV3, 4 (Control of heat exchanger capacity)

- (a) Operations can be confirmed by LED display and operating sound of solenoid valve, because one or more of SV3, 4 are turned on depending on conditions during cooling-only operations.

Solenoid Valve (SV1~6) (PURY-(P)200-250YMF-C)

Check if the control board's output signals and the operation of the solenoid valves match.

Setting the self-diagnosis switch (SW1) as shown in the figure below causes the ON signal of each relay to be output to the LED's.

Each LED shows whether the relays for the following parts are ON or OFF. When a LED lights up, it indicates that the relay is ON.

SW1	LED							
	1	2	3	4	5	6	7	8
				SV1	SV2	SV3	SV4	
	SV5	SV6						

1) In the case of SV1 (Bypass Valve)

- (a) When the compressor starts, SV1 is ON for 4 minutes, so check operation by whether the solenoid valve is emitting an operating noise.
- (b) Changes in the operating condition by solenoid valve operation can be confirmed by the temperature of the bypass circuit and the sound of the refrigerant.

2) In the case of SV2 (Bypass)

- (a) SV2 goes ON in accordance with the rise in the high pressure in the cooling mode and heating mode, so check its operation by the LED display and the operating noise emitted by the solenoid valve.
(Conditions during operation: See **Control of Outdoor Unit.**)
- (b) Changes in the operating condition by solenoid valve operation can be confirmed by the temperature of the bypass circuit and the sound of the refrigerant.

3) SV3 ~ 6 (Control of heat exchanger capacity)

- (a) Operations can be confirmed by LED display and operating sound of solenoid valve, because one or more of SV3 ~5 are turned on depending on conditions during cooling-only operations.
- (b) Operation can be confirmed by LED display and operating sound of solenoid valve, because all of SV3 ~ 5 are turned on during heating-only operations.
- (c) Operations can be confirmed by LED display and operating sound of solenoid valve, because one or more of SV3 ~6 are turned on depending on conditions during cooling-principal and heating-principal operations.

- (d) The refrigerant flow is as following figure. Hot gas (high pressured) flows in cooling mode and cool gas/liquid (low pressured) flows in heating mode. Please refer to the Refrigerant Circuit Diagram.
- And, ON/OFF of Solenoid valve is depends on the amount of running indoor units, ambient temperature and so on. So please check by LED Monitor Display.
- The SV coil is taken off, then it is possible to open caps and check plungers. But the special tool which is on the Service Parts List is needed.

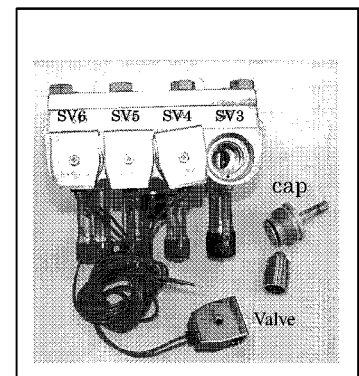
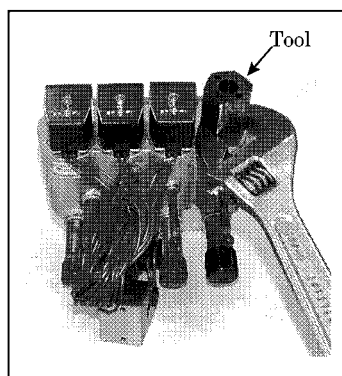
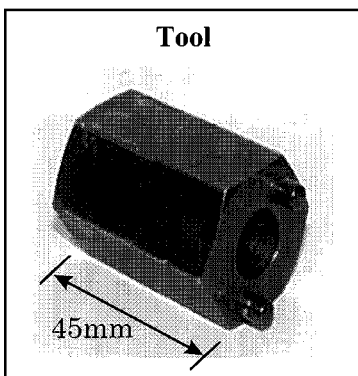
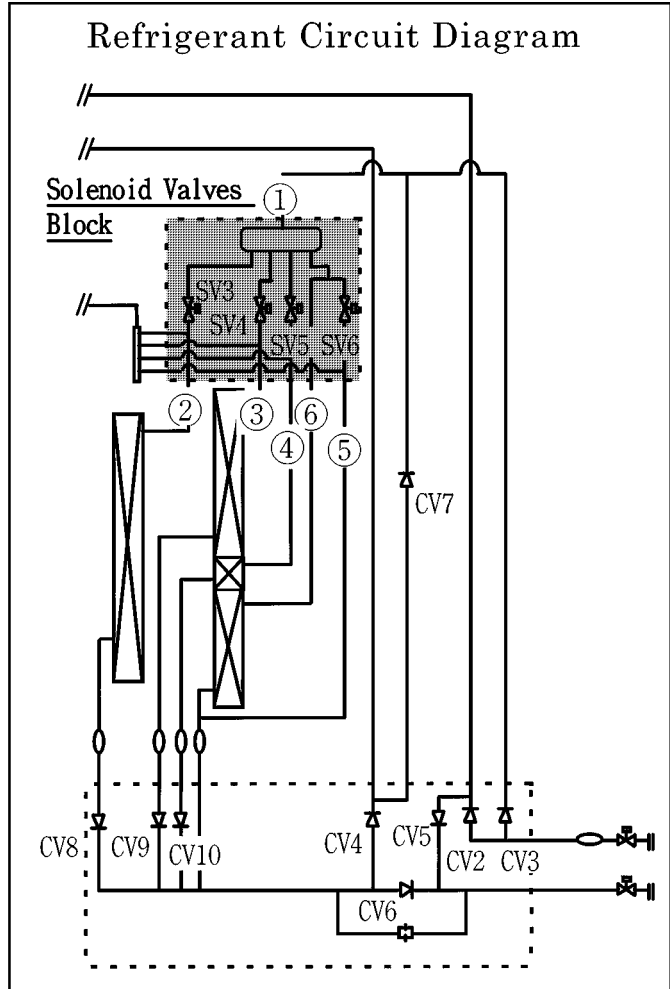
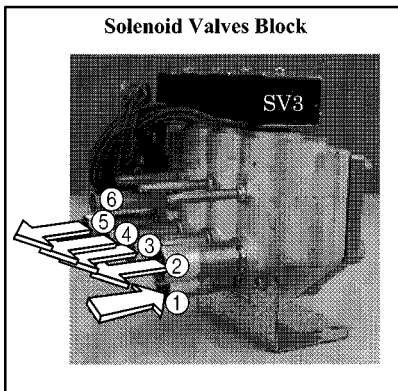
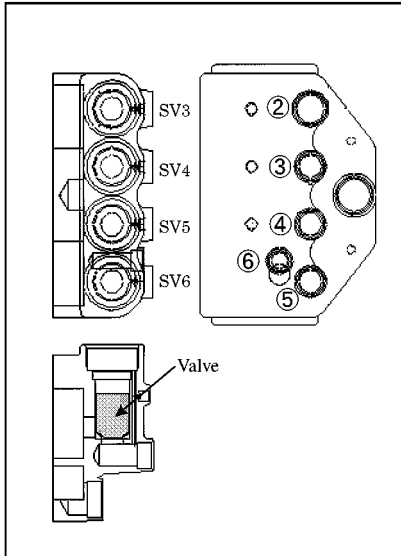

* Closed torque : 13kg·m (1.3N·m)

Outdoor LEV

The valve opening angle changes in proportion to the number of pulses.

(Connections between the outdoor unit's MAIN board and SLEV, LEV1 (PU(H)Y-(P)200-250YMF-C))

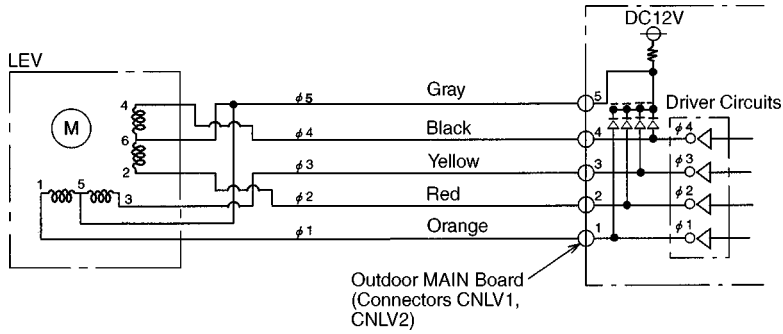

Pulse Signal Output and Valve Operation

Output (phase)	Output states							
	1	2	3	4	5	6	7	8
φ1	ON	OFF	OFF	OFF	OFF	OFF	ON	ON
φ2	ON	ON	ON	OFF	OFF	OFF	OFF	OFF
φ3	OFF	OFF	ON	ON	ON	OFF	OFF	OFF
φ4	OFF	OFF	OFF	OFF	ON	ON	ON	OFF

Output pulses change in the following orders when the Valve is Closed 1→2→3→4→5→6→7→8→1
 Valve is Open 8→7→6→5→4→3→2→1→8

- * 1. When the LEV opening angle does not change, all the output phases are off.
- 2. When the output is out of phase or remains ON continuously, the motor cannot run smoothly, but move jerkily and vibrates.

LEV Valve Closing and Valve Opening Operations

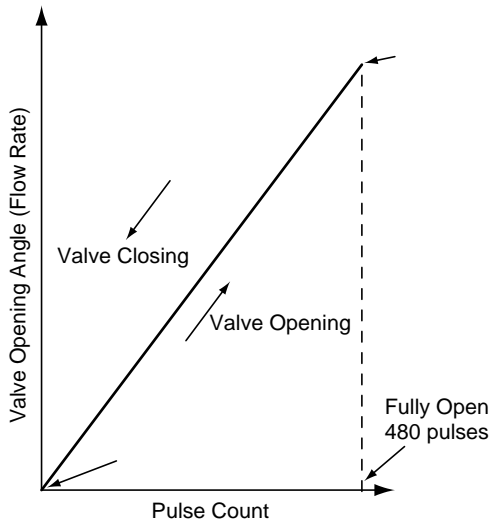

- * When the power is switched ON, a 520 pulse valve opening signal is output to make sure the valve's position, so that it is definitely at point A. (The pulse signal is output for approximately 17 seconds.)
- * When the valve operates smoothly, there is no sound from the LEV and no vibration occurs, but when the valve is locked, it emits a noise.
- * Whether a sound is being emitted or not can be determined by holding a screwdriver, etc. against it, then placing your ear against the handle.
- * If there is liquid refrigerant inside the LEV, the sound may become lower.

Judgment methods and likely failure mode

Caution:

The specifications of the outdoor unit (outdoor LEV) and indoor unit (indoor LEV) differ. For this reason, there are cases where the treatment contents differ, so follow the treatment specified for the appropriate LEV as indicated in the right column.

Failure Mode	Judgment Method	Treatment	Affected LEV
Microcomputer driver circuit failure	<p>① Disconnect the control board connector and connect the check LED as shown in the figure below.</p> <div style="display: flex; justify-content: space-around;"> <div style="text-align: center;"> <p>Indoor, BC controller</p> </div> <div style="text-align: center;"> <p>Outdoor</p> </div> </div> <p>When the base power supply is turned on, the indoor LEV outputs pulse signals for 10 seconds, the outdoor LEV outputs pulse signals for 17 seconds, and BC controller outputs pulse signals for 10-20 seconds. If the LED does not light up, or lights up and remains on, the driver circuit is abnormal.</p>	In the case of driver circuit failure, replace the control board.	Indoor BC controller Outdoor
LEV mechanism is locked.	<p>① If the LEV is locked up, the drive motor turns with no load and a small clicking sound is generated. Generation of this sound when the LEV is fully closed or fully open is abnormal.</p>	Replace the LEV.	Indoor BC controller Outdoor
The LEV motor coils have a disconnected wire or is shorted.	<p>Measure the resistance between the coils (red - white, red - orange, brown - yellow, brown - blue) using a tester. They are normal if the resistance is within $150\Omega \pm 10\%$.</p>	Replace the LEV coils.	Indoor BC controller
	<p>Measure the resistance between the coils (gray - orange, gray - red, gray - yellow, gray - black) using a tester. They are normal if the resistance is within $46\Omega \pm 3\%$.</p>	Replace the LEV coils.	Outdoor
Fully closed failure (valve leaks)	<p>① If you are checking the indoor unit's LEV, operate the indoor unit's blower and the other indoor units in the cooling mode, then check the piping temperatures (liquid pipe temperatures) of the indoor units by the operation monitor through the heat source unit's control board. When the fan is running, the linear expansion valve is fully closed, so if there is leakage, the temperature sensed by the thermistor (liquid pipe temperature sensor) will become low. If the temperature is considerably low compared to the remote control's intake temperature display, it can be judged that there is a fully closed failure. In the case of minimal leakage, it is not necessary to replace the LEV if there are no other effects.</p> <div style="display: flex; align-items: center;"> <div style="margin-left: 10px;"> <p>Thermistor liquid pipe (temperature sensor)</p> <p>Linear Expansion Valve</p> </div> </div>	If there is a large amount of leakage, replace the LEV.	Indoor BC controller
Faulty wire connections in the connector or faulty contact.	<p>① Check for pins not fully inserted on the connector and check the colors of the lead wires visually.</p> <p>② Disconnect the control board's connector and conduct a continuity check using a tester.</p>	Check the continuity at the places where trouble is found.	Indoor BC controller Outdoor

Outdoor LEV (SLEV) Coil Removal Procedure (configuration)

As shown in the figure, the outdoor LEV is made in such a way that the coils and the body can be separated.

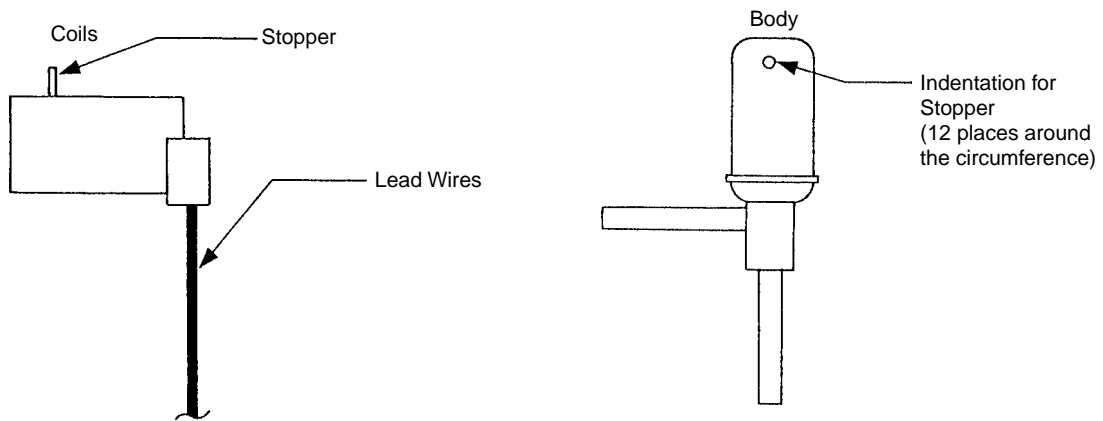

<Removing the Coils>

Fasten the body tightly at the bottom (Part A in the figure) so that the body will not move, then pull out the coils toward the top. If they catch on the stopper and are difficult to take out, turn the coils left and right until the stoppers are free from the stopper indentations, then pull the coils out.

If you take out the coils only without gripping the body, undue force will be applied to the piping and the pipe may be bent over, so be sure to fasten the body in such a way that it will not move.

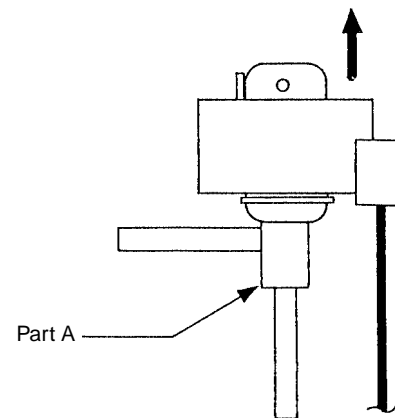

<Installing the Coils>

Fasten the body tightly at the bottom (Part A in the figure) so that the body will not move, then insert the coils from the top, inserting the coils' stopper securely in one of the indentations on the body. (There are four indentations for the stopper on the body around its circumference, and it doesn't matter which indentation is used. However, be careful not to apply undue force to the lead wires or twist them around inside the body.) If the coils are inserted without gripping the body, it may exert undue force on the piping, causing it to become bent, so be sure to hold the body firmly so that it won't move when installing the coils.

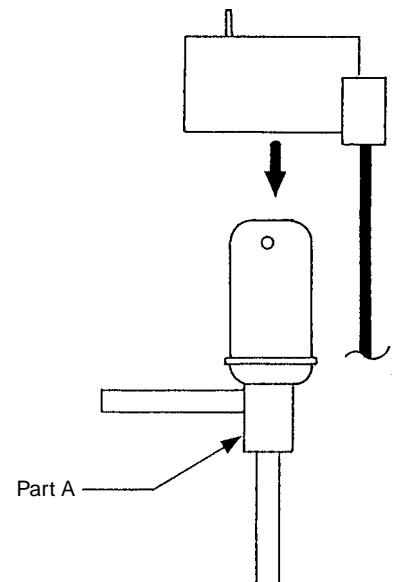

Check Valves Block (PURY-(P)200-250YMF-C)

The refrigerant flow in the pipe ⑥, ⑦, ⑧ and ⑨ are depend on ON/OFF of the SV3, 4, 5 and 6.

Please confirm by LED monitor display.

You can open the cap of valve A, B and C, but 3 types of hexagon socket screw keys. The size is as follows.

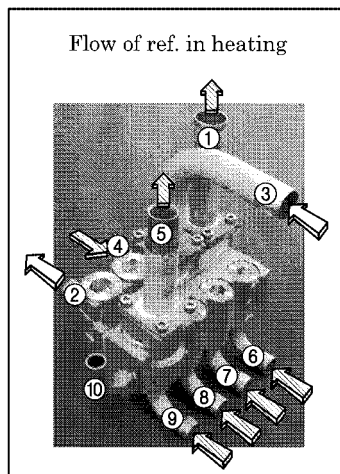
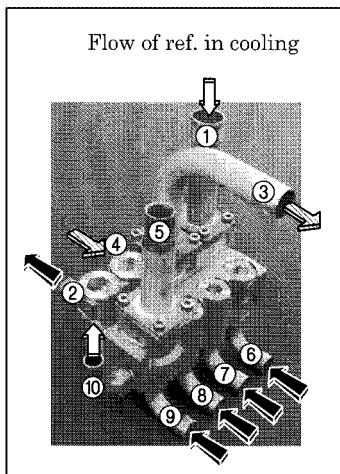
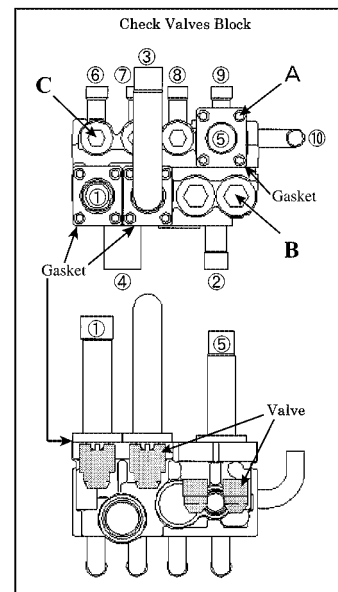
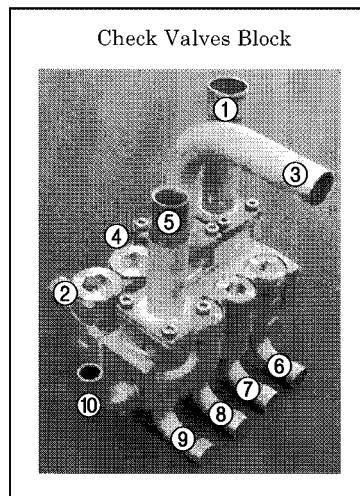
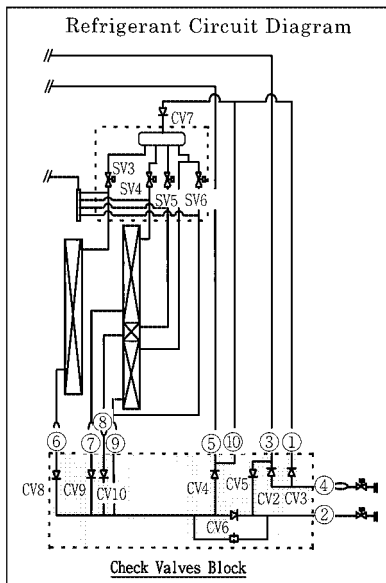

- * Closed torque : A : 1.7kg-m (0.17N-m)
- B : 20kg-m (2.0N-m)
- C : 13kg-m (1.3N-m)

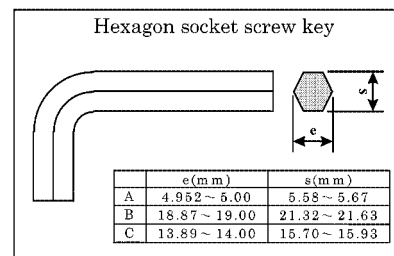

- ↔ High pressure gas
- ↔ High pressure liquid
- ↔ Low pressure gas/liquid

Intelligent Power Module (IPM)

Measure resistances between each terminal of IPM with tester, and use the results for troubleshooting. Specified resistance value is dependent on tester type to be used for resistance measurement, because diode inside IPM has non-linearity, thus difference of impedance and voltage in tester being influential. As the internal impedance of resistance range of analog tester equals to the center value of meter indication, the affect of internal impedance can be minimized if the tester having close center value of resistance range. Because internal voltage is normally 1.5V, the tester to be used for troubleshooting of IPM should satisfy the following conditions.

Internal voltage	1.5V (Power source : one dry cell battery)
Central value of resistance range	10 ~ 40Ω

The measured values for troubleshooting are shown in the table below.
(Use the minimum range for tester resistance range.)

• External view

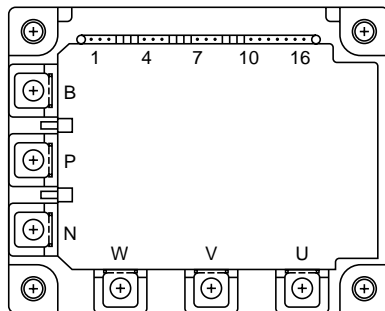

• Judged value

Tester +		P	U	V	W	N
Tester -						
P		∞	∞	∞	∞	∞
U		2~100Ω	∞	∞	∞	∞
V		2~100Ω	∞	∞	∞	∞
W		2~100Ω	∞	∞	∞	∞
N		2~100Ω	2~100Ω	2~100Ω	2~100Ω	∞

• Internal circuit diagram

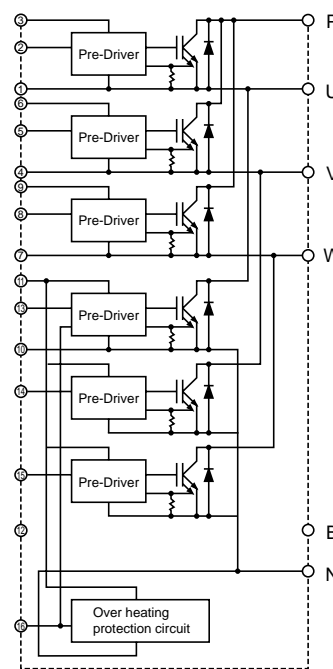

Diode stack

Perform continuity check with tester. Judged as normal if the following characteristics are observed.
(Use the minimum range for tester resistance range.)

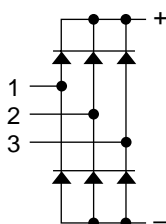
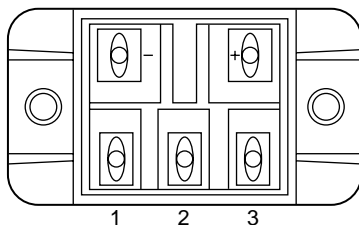

	Tester ⊕	+	-
Tester ⊖			
1		10~50Ω	∞
2		10~50Ω	∞
3		10~50Ω	∞
	Tester ⊖	+	-
Tester ⊕			
1		∞	10~50Ω
2		∞	10~50Ω
3		∞	10~50Ω

(2) Trouble and remedy of remote controller

Symptom	Cause	Checking method & countermeasure
<p>1) Despite pressing of remote controller switch, operation does not start with no electronic sound.</p> <p>(No powering signal  appears.)</p>	<p>1) M-NET transmission power source is not supplied from outdoor unit.</p> <p>① Main power source of outdoor unit is not connected.</p> <p>② Slipping off of connector on outdoor unit circuit board.</p> <p>Main board : CNS1, CNVCC3 INV board : CNAC2, CNVCC1, CNL2</p> <p>③ Faulty power source circuit of outdoor unit.</p> <ul style="list-style-type: none"> • Faulty INV board, • Blown fuse (F1 on INV board) • Broken diode stack • Broken resistor (R1) for rush current protection <p>2) Short circuit of transmission line.</p> <p>3) Erroneous wiring of M-NET transmission line at outdoor unit.</p> <p>① Transmission line disconnection or slipping off from terminal block.</p> <p>② Erroneous connection of indoor/outdoor transmission line to TB7.</p> <p>4) Slipping off of transmission wiring at remote controller.</p> <p>5) Faulty remote controller.</p>	<p>a) Check transmission terminal block of remote controller for voltage.</p> <p>i) In case of 17 ~ 30V → Faulty network remote controller</p> <p>ii) In case of less than 17V → See "Transmission Power Circuit (30V) Check Procedure".</p>
<p>2) At about 10 seconds after turning remote controller operation switch ON, the display distinguishes and the operation stops.</p>	<p>1) Power source is not fed to indoor unit from transformer.</p> <p>① Main power source of indoor unit is not turned on.</p> <p>② Slipping off of connector (CND, CNT, CN3T) on indoor controller board.</p> <p>③ Blown fuse on indoor controller board.</p> <p>④ Faulty or disconnected transformer of indoor unit.</p> <p>⑤ Faulty indoor controller board.</p> <p>2) Faulty outdoor control circuit board or being out of control.</p> <p>As normal transmission is failed between indoor and outdoor units, outdoor unit model can not be recognized.</p>	<p>The cause of 2) and 3) is displayed with self-diagnosis LED for 7102 error.</p>

Checking method & countermeasure

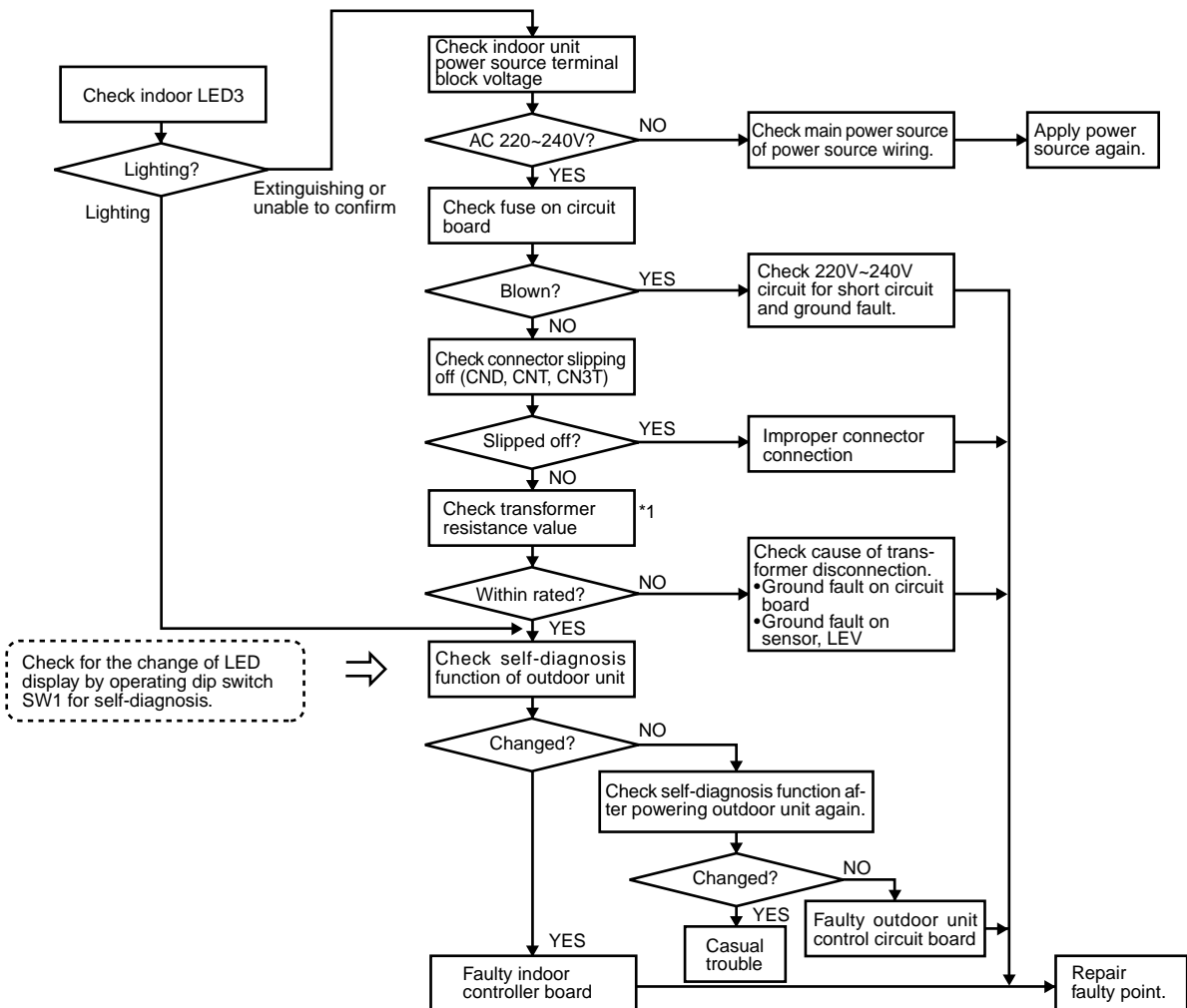

*1 Check the transformer in accordance with the "TROUBLE SHOOTING" in the indoor unit's service handbook.

Symptom	Cause
3 "HO" display on remote controller does not disappear and switch is ineffective.	<p>(Without using MELANS)</p> <ol style="list-style-type: none"> 1) Outdoor unit address is set to "000." 2) Erroneous address. <ol style="list-style-type: none"> ① Address setting miss of indoor unit to be coupled with remote controller. (Indoor unit = remote controller - 100.) ② Address setting miss of remote controller. (Remote controller = indoor unit + 100.) 3) Faulty wiring of transmission terminal block TB5 of indoor unit in the same group with remote controller. 4) Centralized control SW2-1 of outdoor unit is turned ON. 5) Setting to interlocking system from indoor unit (Switch 3-1 = OFF), while Fresh Master is intended to use by remote controller operation (indoor unit attribute). 6) Disconnection or faulty wiring of indoor unit transmission line. 7) Disconnection between indoor unit M-NET transmission line terminal block (TB5) and connector CN2M. 8) More than 2 sets of power supply connector (CN40) are inserted into centralized control transmission line of outdoor unit. 9) Faulty outdoor unit control circuit board. 10) Faulty indoor controller board. 11) Faulty remote controller. <hr/> <p>(Interlocking control with MELANS)</p> <ol style="list-style-type: none"> 12) No grouping registration from MELANS (Neglecting to set the relation between indoor unit and network remote controller). 13) Slipping off of centralized control transmission line (TB7) at outdoor unit. 14) At system connected with MELANS, power supply connector (CN40) is inserted to centralized control transmission line of outdoor unit.

Checking method & countermeasure

In case no MELANS used

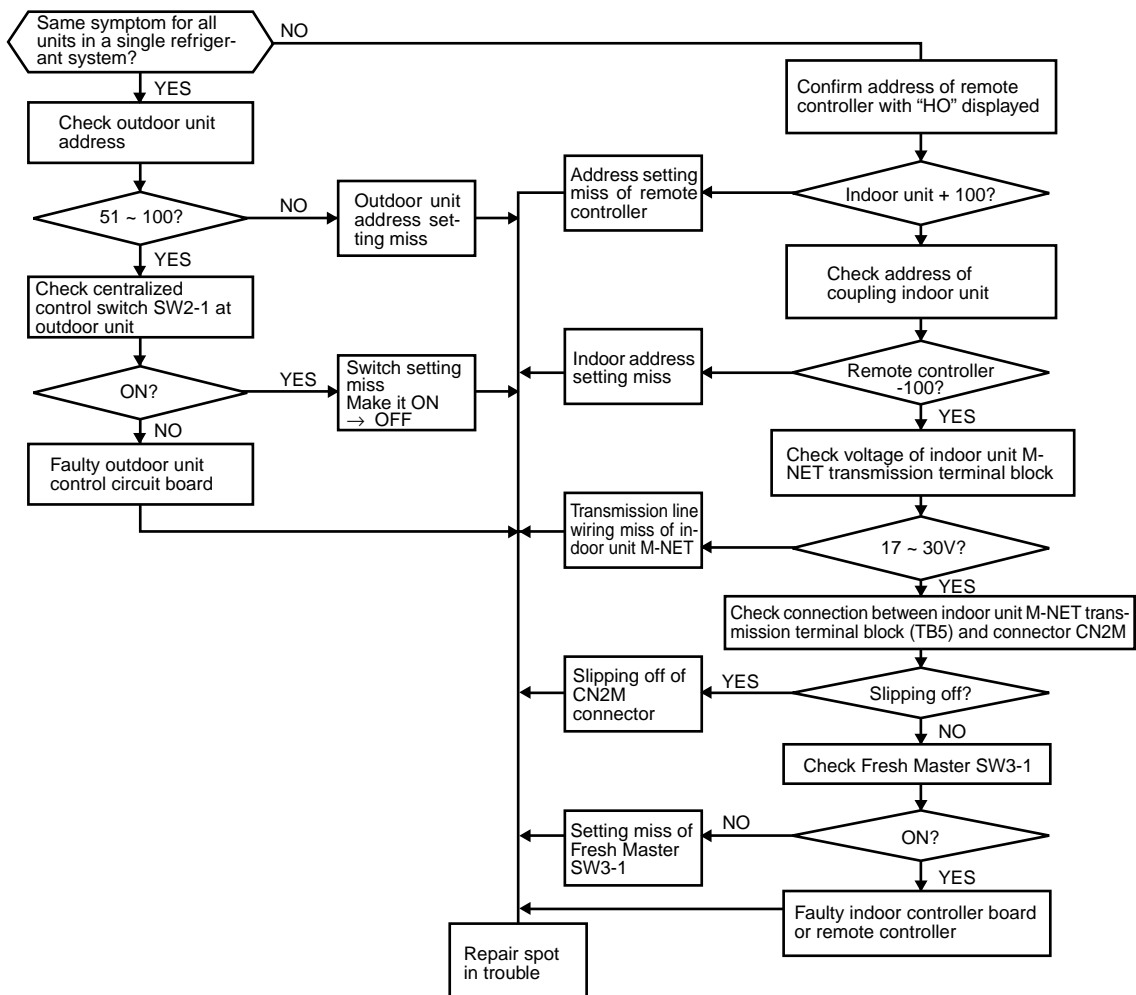

In case with MELANS used

When MELANS is used, "HO" display on the remote controller will disappear at the group registration of the indoor unit and local remote controller. If "HO" does not disappear after the registration, check the items 12) ~ 14) in the Cause column.

	Symptom	Cause	Checking method & countermeasure
4	"88" appears on remote controller at the registration and access remote controller	<p>[Generates at registration and confirmation]</p> <ol style="list-style-type: none"> 1) Erroneous address of unit to be coupled. 2) Slipping off of transmission line of unit to be coupled (No connection). 3) Faulty circuit board of unit to be coupled. 4) Installation miss of transmission line. <hr style="border-top: 1px dashed black;"/> <p>[Confirmation of different refrigerant system controller]</p> <ol style="list-style-type: none"> 5) Breaking of power source of outdoor unit to be confirmed. 6) Slipping off of centralized control transmission line (TB7) of outdoor unit. 7) Power supply connector (CN40) is not inserted into centralized control transmission line in grouping with different refrigerant system without using MELANS. 8) More than 2 sets of power supply connector are inserted into the centralized control transmission line of outdoor unit. 9) In the system connected with MELANS, power supply connector (CN40) is inserted into the centralized control transmission line of outdoor unit. 10) Short circuit of centralized control transmission line. 	<ol style="list-style-type: none"> a) Confirm the address of unit to be coupled. b) Check the connection of transmission line. c) Check the transmission terminal block voltage of unit to be coupled. <ol style="list-style-type: none"> i) Normal if voltage is DC17 ~ 30V ii) Check the item d) in case other than i). d) Confirm the power source of outdoor unit to be coupled with the unit to be confirmed. e) Confirm that the centralized control transmission line (TB7) of outdoor unit is not slipped off. f) Confirm the voltage of centralized control transmission line. <ol style="list-style-type: none"> i) Normal in case of 10V ~ 30V ii) Check the items 7) ~ 10) left in case that other than i).

Transmission Power Circuit (30 V) Check Procedure

If “⊙” is not displayed by the remote control, investigate the points of the trouble by the following procedure and correct it.

No.	Check Item	Judgment	Response
1	Disconnect the transmission line from TB3 and check the TB3 voltage.	DC24~30 V	Check the transmission line for the following, and correct any defects. Broken wire, short circuit, grounding, faulty contact.
		Except the above-mentioned	to No. 2
2	Check if the following connectors are disconnected in the outdoor unit's control box. MAIN Board: CNS1, CNVCC3, CNVCC4 INV Board: CNVCC2, CNVCC4, CNL2, CNR, CNAC2	Connector disconnected	Connect the connectors as shown on the electric wiring diagram plate.
		Except the above-mentioned	to No. 3
3	Disconnect the wires from CNVCC3 on the Main board and check the voltage between pins 1 and 3 on the wire side of the CNVCC3. Tester ⊕ 1 pin Tester ⊖ 3 pin	DC24~30 V	Check the wiring between CNS1 and TB3 for the following, and correct any defects. Broken wire, short circuit, grounding, faulty contact. If there is no trouble, replace the Main board.
		Except the above-mentioned	to No. 4
4	Disconnect the wiring from CNVCC2 on the INV board and check the voltage between pins 1 and 3 of CNVCC2. Tester ⊕ 1 pin Tester ⊖ 3 pin	DC24~30 V	Check the wiring between CNVCC2 and CNVCC3 for the following, and correct any defects. Broken wire, short circuit, grounding, faulty contact.
		Except the above-mentioned	to No. 5
5	Disconnect the wiring from CNL2 on the INV board, and check the resistance at both ends of choke coil L2.	0.5~2.5Ω	to No. 6
		Except the above-mentioned	Replace choke coil L2.
6	Disconnect the wiring from CNR on the INV board, and check the resistance at both ends of R7.	19~25Ω	to No. 7
		Except the above-mentioned	Replace R7.
7	Check the resistance at both ends of F01 on the INV board.	0Ω	to No. 8
		Except the above-mentioned	Replace F01
8	Check the voltage between pins 1 and 3 of CNAC2 on the INV board.	AC198~264 V	Replace the INV board.
		Except the above-mentioned	to No. 9
9	Check the voltage between L2 and N on power supply terminal block TB1.	AC198~264 V	Check the wiring to CNAC2 for the following and correct any defects. Broken wire, faulty contact.
		Except the above-mentioned	Check the power supply wiring and base power supply, and correct any defects.

(3) Investigation of transmission wave shape/noise

Control is performed by exchanging signals between outdoor unit, indoor unit and remote controller by M-NET transmission. If noise should enter into the transmission line, the normal transmission will be hindered causing erroneous operation.

1) Symptom caused by the noise entered into transmission line

Cause	Erroneous operation	Error code
Noise entered into transmission line	Signal changes and is misjudged as the signal of other address.	6600
	Transmission wave shape changes to other signal due to noise.	6602
	Transmission wave shape changes due to noise, and can not be received normally thus providing no reply (ACK).	6607
	Transmission can not be made continuously due to the entry of fine noise.	6603
	Transmission can be made normally, but reply (ACK) or answer can not be issued normally due to noise.	6607 6608

2) Method to confirm wave shape

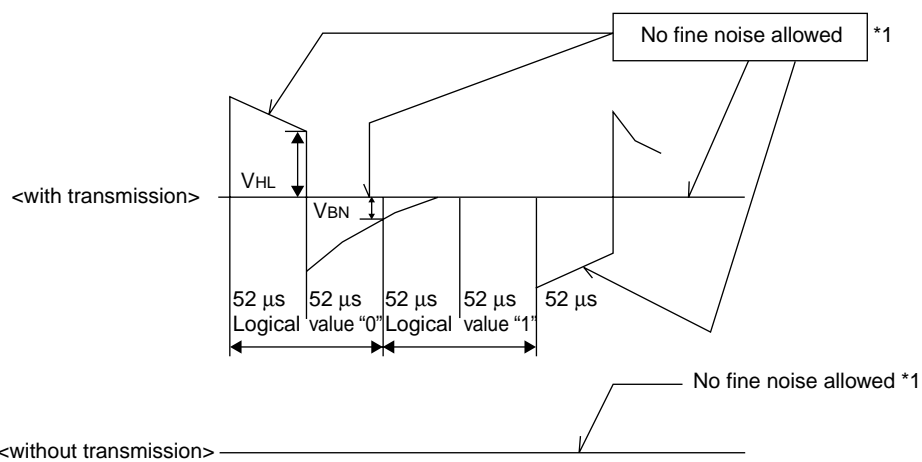

Check the wave shape of transmission line with an oscilloscope to confirm that the following conditions are being satisfied.

- ① The figure should be $104\mu\text{s/bit} \pm 1\%$.
- ② No finer wave shape (noise) than the transmission signal ($52\mu\text{s} \pm 1\%$) should be allowed. *1
- ③ The sectional voltage level of transmission signal should be as follows.

Logic value	Transmission line voltage level
0	$V_{HL} = 2.0\text{V}$ or more
1	$V_{BN} = 1.3\text{V}$ or less

*1 However, minute noise from the DC-DC converter or inverter operation may be picked up.

3) Checking and measures to be taken

(a) Measures against noise

Check the items below when noise can be confirmed on wave shape or the error code in the item 1) is generated.

Items to be checked		Measures to be taken
Checking for wiring method	① Wiring of transmission and power lines in crossing.	Isolate transmission line from power line (5cm or more). Never put them in a same conduit.
	② Wiring of transmission line with that of other system in bundle.	Wire transmission line isolating from other transmission line. Wiring in bundle may cause erroneous operation like crosstalk.
	③ Use of shield wire for transmission line (for both indoor unit control and centralized control).	Use specified transmission wire. Type : Shield line CVVS/CPEVS Wire diameter : 1.25mm ² or more
	④ Repeating of shield at the repeating of transmission line with indoor unit.	The transmission line is wired with 2-jumper system. Wire the shield with jumper system as same for transmission line. When the jumper wiring is not applied to the shield, the effect against noise will be reduced.
	⑤ Are the unit and transmission lines grounded as instructed in the INSTALLATION MANUAL?	Connect to ground as shown in the INSTALLATION MANUAL.
Check for earthing	⑥ Earthing of the shield of transmission line (for indoor unit control) to outdoor unit.	One point earthing should be made at outdoor unit. Without earthing, transmission signal may be changed as the noise on the transmission line has no way to escape.
	⑦ Arrangement for the shield of transmission line (for centralized control).	For the shield earth of the transmission line for centralized control, the effect of noise can be minimized if it is from one of the outdoor units in case of the group operation with different refrigerant systems, and from the upper rank controller in case the upper rank controller is used. However, the environment against noise such as the distance of transmission line, the number of connecting sets, the type of connecting controller, and the place of installation, is different for the wiring for centralized control. Therefore, the state of the work should be checked as follows. a) No earthing <ul style="list-style-type: none"> • Group operation with different refrigerant systems One point earthing at outdoor unit • Upper rank controller is used Earthing at the upper rank controller b) Error is generated even though one point earth is being connected. Earth shield at all outdoor units. Connect to ground as shown in the user's manual.

(b) When the wave height value of transmission wave shape is low, 6607 error is generated, or remote controller is under the state of "HO."

Items to be checked		Measures to be taken
	⑧ The farthest distance of transmission line is exceeding 200m.	Confirm that the farthest distance from outdoor unit to indoor unit/ remote controller is less than 200m.
	⑨ The types of transmission lines are different.	Use the transmission wire specified. Type of transmission line : Shield wire CVVS/CPEVS Wire dia. of transmission line : 1.25mm ² or more
	⑩ No transmission power (30V) is being supplied to the indoor unit or the remote control.	Refer to "Transmission Power Supply (30V) Circuit Check Procedure."
	⑪ Faulty indoor unit/remote controller.	Replace outdoor unit circuit board or remote controller.

4) Treatment of Inverter and Compressor Troubles

If the compressor does not work when error codes 4240, 4250, 4340 or 4350 are detected, determine the point of malfunction by following the steps in the **LED monitor display and countermeasures depending on the check code displayed**, then perform the procedures below.

No.	Check Item	Symptoms	Treatment
1	How many hours was the power kept on before operation?	① If it was kept on for 12 hours or longer as specified.	Go to [2].
		② It was kept on for less than the specified period.	Go to [2] after keeping the power on for the specified time.
2	When it is restarted, does the trouble reappear?	① The compressor stops and the same error code is displayed.	Perform the check of wiring shown in the explanation of each error code.
3	Run the outdoor unit with the wiring to the compressor disconnected. At this time, change SW1-1 on the INV board to ON. Note) The terminals of the 3 disconnected wires should be isolated from each other.	① The Inverter stops and the same error code is displayed.	Check the IPM is faulty. (Go to "Individual Parts Failure Judgment Methods.")
		② If the inverter's output voltage is output with good balance, *1.	Check the coil resistance and insulation resistance of the compressor, and if it is normal, run it again, and if the trouble occurs again, replace the compressor. * Insulation resistance : 2MΩ or more Coil resistance : 0.359 ~ 0.716Ω
		③ If the balance in the inverter's output voltage is not good or if the inverter's output voltages are all 0 V (a digital tester cannot be used) *1.	Check the IPM. Judge that the IPM is faulty. (Go to "Individual Parts Failure Judgment Methods.") If the IPM is normal, replace the G/A board, then perform this item again with SW1-1 ON. If the problem is not solved, replace the INV board. If the problem is solved and you connect the compressor again, turn SW1-1 OFF again. Check the compressor's coil resistance and insulation resistance.

*1 [Cautions when measuring the voltage and current of the inverter's power circuit.]

Since the voltage and current on the inverter's power supply side and its output side do not have a sine waveform, the measurement values will differ depending on the measuring instrument and the circuit measured.

In particular, as the inverter's output voltage has a pulse waveform, the output frequency also changes, so differences in measurement values will be great depending on the measuring instrument.

- ① When checking if the inverter's output voltage is unbalanced or not (relative comparison of the voltages between each of the lines), if you are testing with a portable tester, be sure to use an analog tester.
Use a tester of a type which can be used to judge if the IPM or diode module is faulty.
In particular, in cases where the inverter's output frequency is low, there are cases where the variations in measured voltage values between the different wires will be great when a portable digital tester is used, when in actuality they are virtually equal, and there is danger of judging that the inverter is faulty.
- ② It is recommended when checking the inverter's output voltage values (when measuring absolute values), that, if a measuring device for business frequencies is used, a rectified voltage meter (with a \blacktriangleright symbol) be used.
Correct measurement values cannot be obtained with an ordinary portable tester. (either analog or digital)

5) Treatment of Fan Motor Related Troubles

Condition	Possible Cause	Check Method and Treatment
<p>① It won't run for 20 minutes or longer when the AK value is $\geq 10\%$. (When the MAIN board's SW1 is set as shown below, the AK value is displayed by the service LED.)</p> <p>SW1 = 1110001000</p> <p>② The fan motor's vibration is great.</p>	<p>1) The power supply voltage is abnormal.</p>	<p>If there is an open phase condition before the breaker, after the breaker or at the power supply terminal blocks TB1A or TB1B, correct the connections.</p> <p>If the power supply voltage deviates from the specified range, connect the specified power supply.</p>
	<p>2) Wiring is faulty.</p>	<p>For the following wiring, 1 check the connections, 2 check the contact at the connectors, 3 check the tightening torque at parts where screws are tightened, 4 check the wiring polarity, 5 check for a broken wire and 6 check for grounding.</p> <p>TB1A~NF~TB1B~CNTR1~T01~CNTR TB1B~CNPOW, CNFAN~CN04~CNMF CNFC1~CNFC2</p> <p>* Check if the wiring polarity is as shown on the wiring diagram plate.</p>
	<p>3) The motor is faulty.</p>	<p>Measure the resistance of the motor's coils: 20~60Ω Measure the motor's insulation resistance with a megger: 10 MΩ (DC 500 V) or more</p>
	<p>4) A fuse (F1, F2, F3) is defective.</p>	<p>If a fuse is defective, replace it.</p>
	<p>5) The transformer (T01) is defective.</p>	<p>Judge that T01 is faulty. Go to "Individual Parts Failure Judgment Methods."</p>
	<p>6) The circuit board is faulty.</p>	<p>If none of the items in 1) to 5) is applicable, and the trouble reappears even after the power is switched on again, replace the circuit board using the following procedure. (When replacing the circuit board, be sure to connect the connectors and ground wire, etc. securely.)</p> <p>① Replace the FANCON board only. If it recovers, the FANCON board is defective. ② Replace the FANCON board and replace the MAIN board. If it recovers, the MAIN board is defective. ③ If the trouble continues even after 1 and 2 above, then both boards are defective.</p>

6) Troubleshooting at breaker tripping

Check items	Measures to be taken
① Check the breaker capacity.	The breaker's capacity should be proper.
② Check the a short circuit or grounding in the electrical system other than the inverter.	Correct any defects.
③ Check the resistance between terminals on the terminal block TB1A for power source. <div style="border: 1px solid black; padding: 5px; margin-top: 10px;"> ① 0 ~ several ohms or improper megohm value </div>	Check each part inside the inverter power circuit (resistance, megohm or the like). a) Diode stack Refer to "Troubleshooting of diode stack." b) IPM Refer to "Troubleshooting of IPM." c) Rush current protection resistor d) Electromagnetic contactor e) DC reactor * For c) ~ e), refer to "Individual Parts Failure Judgment Methods."
④ Checking by powering again.	
<div style="border: 1px solid black; padding: 5px; margin-top: 10px;"> ① Main power source circuit breaker tripping </div> <div style="border: 1px solid black; padding: 5px; margin-top: 10px;"> ② No display of remote controller </div>	
⑤ Operational check by operating air conditioner	
① Normal operation without breaker tripping.	a) As there is a possibility of instantaneous short circuit generated, find the mark of the short circuit for repair. b) When a) is not applicable, the compressor may be faulty.
② Breaker tripping	The ground fault of inverter output/compressor can be supposed. Disconnect the wiring to the compressor and check the insulation resistance of the following parts with a megger. a) Compressor terminals. b) Inverter output.

7) Individual Parts Failure Judgment Methods.

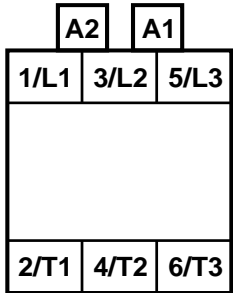
Part Name	Judgment Method						
Diode Stack (DS)	Refer to “Judging Diode Stack Failure.”						
Intelligent Power Module(IPM)	Refer to “Judging IPM Failure.”						
Electromagnetic Contactor (52C)	Measure the resistance value at each terminal. <div style="display: flex; justify-content: space-around; align-items: center; margin-top: 10px;">  <table border="1" style="margin-left: 20px;"> <thead> <tr> <th>Check Location</th> <th>Judgment Value</th> </tr> </thead> <tbody> <tr> <td>A1-A2</td> <td>0.1k~1.3kΩ</td> </tr> <tr> <td>1/L1-2/T1 3/L2-4/T2 5/L3-6/T3</td> <td>∞</td> </tr> </tbody> </table> </div>	Check Location	Judgment Value	A1-A2	0.1k~1.3kΩ	1/L1-2/T1 3/L2-4/T2 5/L3-6/T3	∞
Check Location	Judgment Value						
A1-A2	0.1k~1.3kΩ						
1/L1-2/T1 3/L2-4/T2 5/L3-6/T3	∞						
Rush Current Protection Resistor (R1, 5)	Measure the resistance between terminals: 4.5k~5.5kΩ						
DC Reactor (DCL)	Measure the resistance between terminals: 1 Ω or lower						
	Measure the resistance between the terminals and the chassis: ∞						
Cooling Fan (MF1)	Measure the resistance between terminals: 0.1k~1.5kΩ						
Transformer (T01)	Measure the resistance between terminals on the primary side (CNTR1): 1.0k~2.5kΩ Measure the resistance between terminals on the secondary side (CNTR): 20~60Ω						
AC Current sensor (ACCT)	Measure the resistance between terminal between 1pin and 2pin, 3pin and 4pin : 35 ~ 45 (Ω)						

[Caution at replacement of inverter parts]

- ① IPM and G/A board should be replaced together at the same time.
 When the IPM is damaged, the G/A board may possibly be broken, and the use of the broken G/A board damages the normal IPM. Therefore, replace the IPM and G/A board together at the same time. However, if the G/A board is damaged, judge that the IPM is faulty, then judge whether replacement is necessary or not.
- ② Fully check wiring for incorrect and loose connection.
 The incorrect or loose connection of the power circuit part wiring like IPM and diode module causes to damage the IPM. Therefore, check the wiring fully. As the insufficient tightening of screws is difficult to find, tighten them together additionally after finishing other works. For the wiring of the base for IPM, observe the wiring diagram below carefully as it has many terminals.
- ③ Coat the grease for radiation provided uniformly onto the radiation surface of IPM /diode modules.
 Coat the grease for radiation on the full surface in a thin layer, and fix the module securely with the screw for fastening. As the radiation grease attached on the wiring terminal causes poor contact, wipe it off if attached.

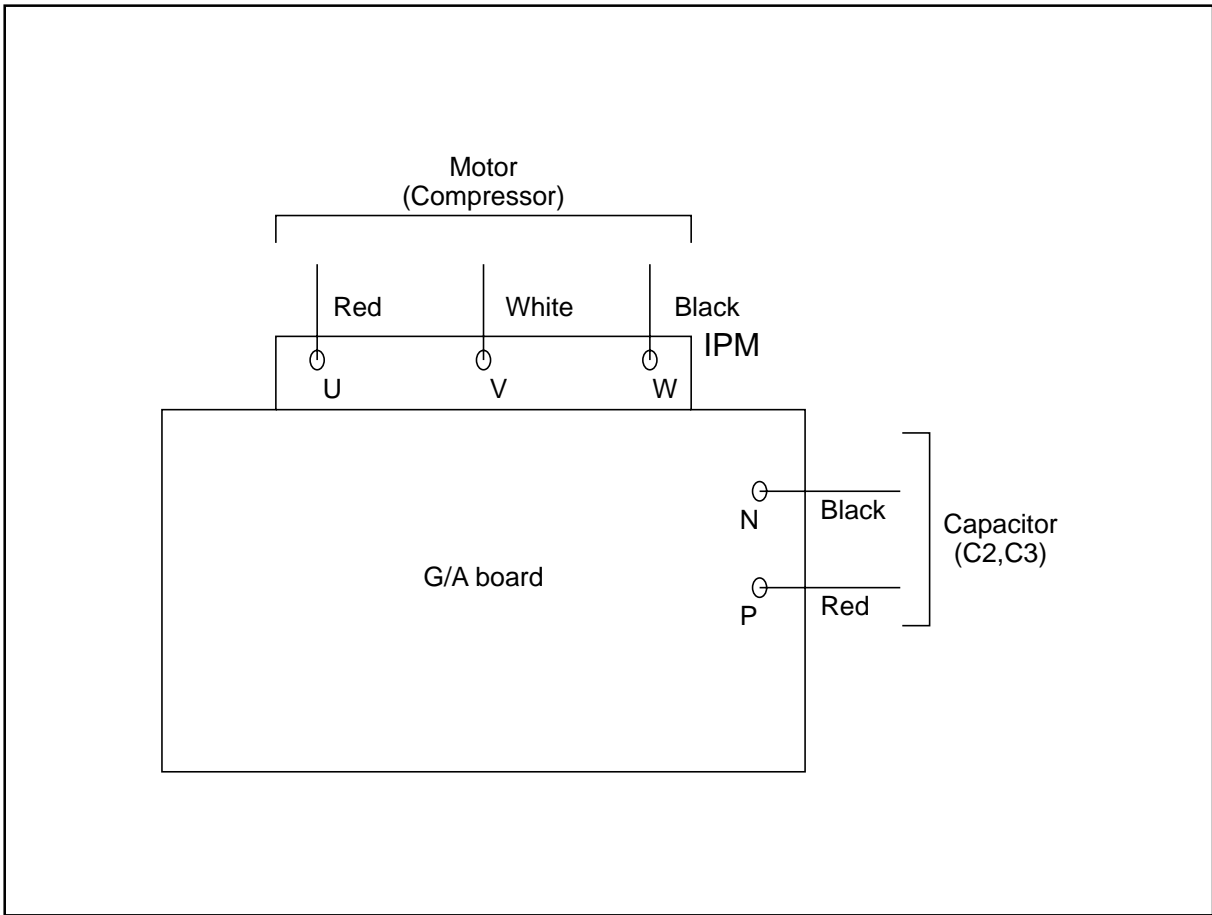

(4) Troubleshooting the major components of the BC controller

1) Pressure sensor

Pressure sensor troubleshooting flow

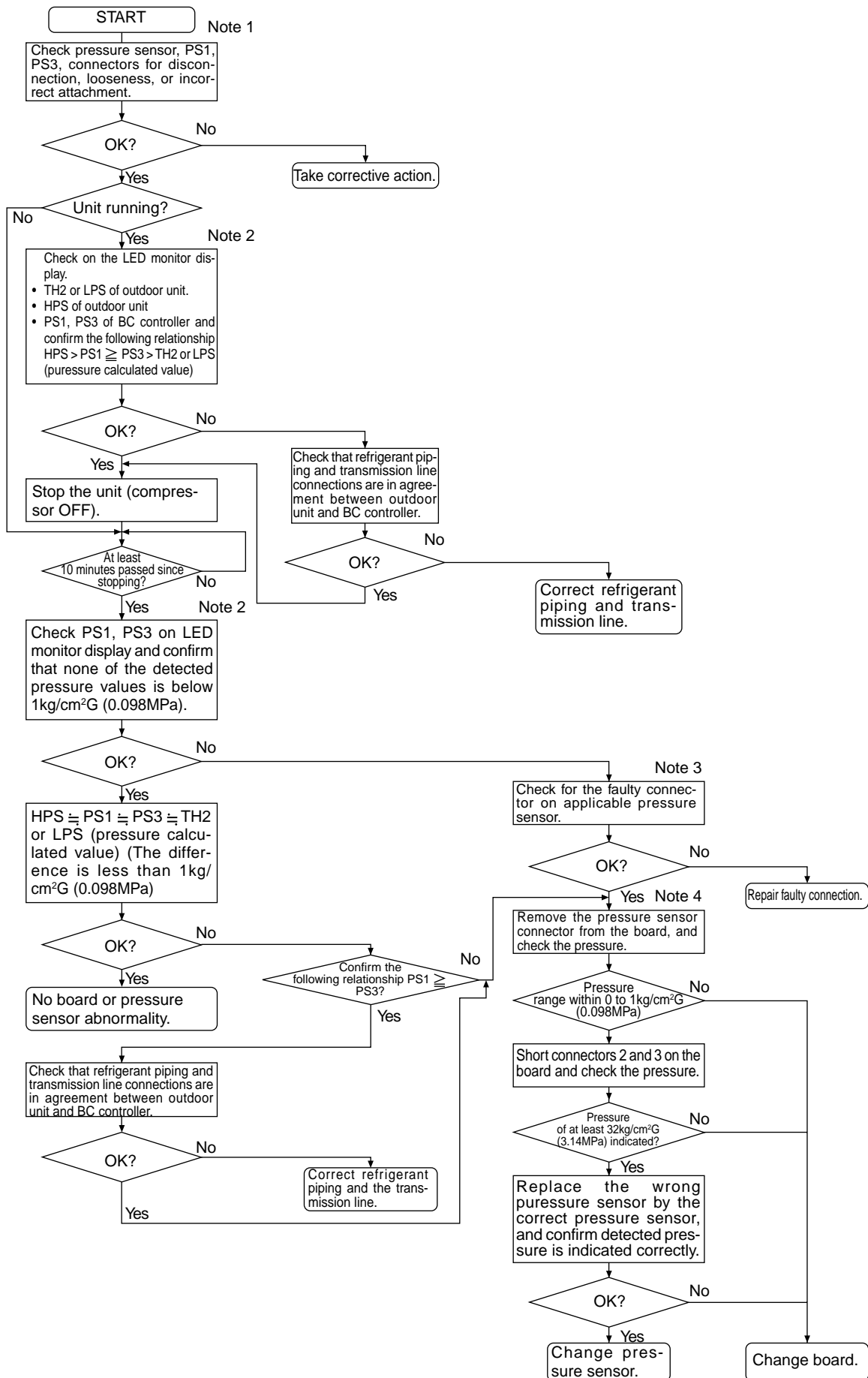





Note 1 :

- Symptoms of incorrect connection of BC controller pressure sensor to the board

Symptom						
Cooling-only	Cooling-principal		Heating-only		Heating-principal	
Normal	Insufficient cooling.	SC11 large SC16 small Δ PHM < 0	Warm indoor SC small. Warm indoor thermo ON especially noise.	SC11 small SC16 small Δ PHM < 0	Insufficient heating Warm indoor SC small Warm indoor thermo ON especially noise	SC11 large SC16 small Δ PHM < 0

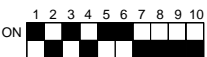
Note 2 :

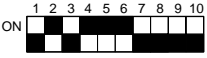
- Check using LED monitor display switch (outdoor MAIN board SW1)

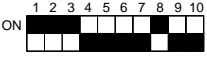
Measured Data	Signal	SW1 Setting	Remarks
High pressure of outdoor	HPS	ON 	See converter.
Low pressure saturation temperature	TH2	ON 	See converter.
Low pressure of outdoor	LPS	ON 	See converter.
BC controller pressure (liquid measurement) (intermediate)	PS1	ON 	Convert saturation temperature to desired pressure using converter.
	PS3	ON 	

Note 3 :

- Check CNP1 (liquid measurement) and CMP3 (intermediate) connectors on BC controller board for disconnection or looseness.

Note 4 :

- With the sensor of the applicable connector removed from the board, use the LED monitor display switch (Note 1) to check the pressure value.

Pressure Sensor Replacement Precaution

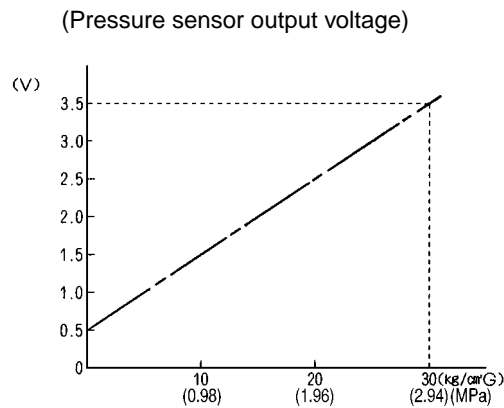

2) Temperature Sensor

Thermistor troubleshooting flow

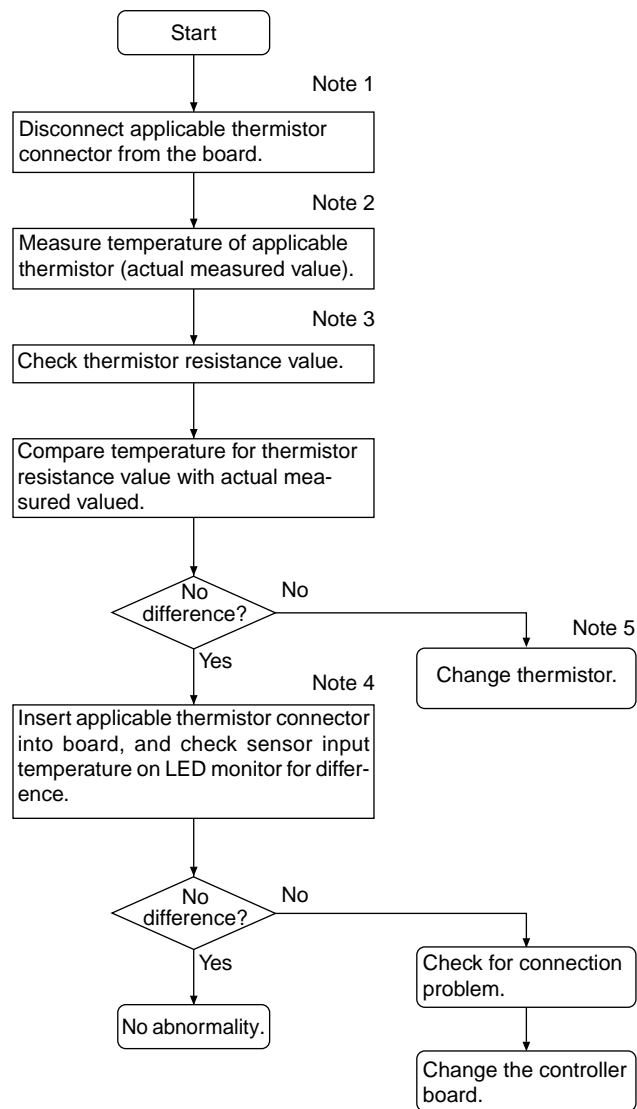

Note 1 :

- Board connector CN10 corresponds to TH11 through TH14, while connector CN11 corresponds to TH15 through TH16. Remove the applicable connector and check the sensor for each number.

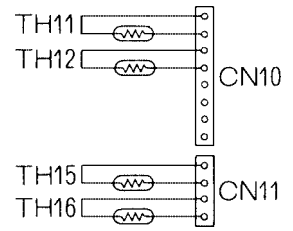

Note 2, 3 :

- Pull the sensor connector from the I/O board. Do not pull on the lead wire.
- Measure resistance using a tester or other instrument.
- Compare measured values with values on the graph below. A value within a range of ±10% is normal.

Resistance measurement point (connector)

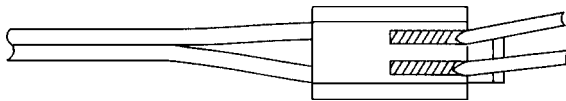

Touch the probes of the tester or other instrument to the shaded areas to measure.

Temperature sensor resistance (graph)

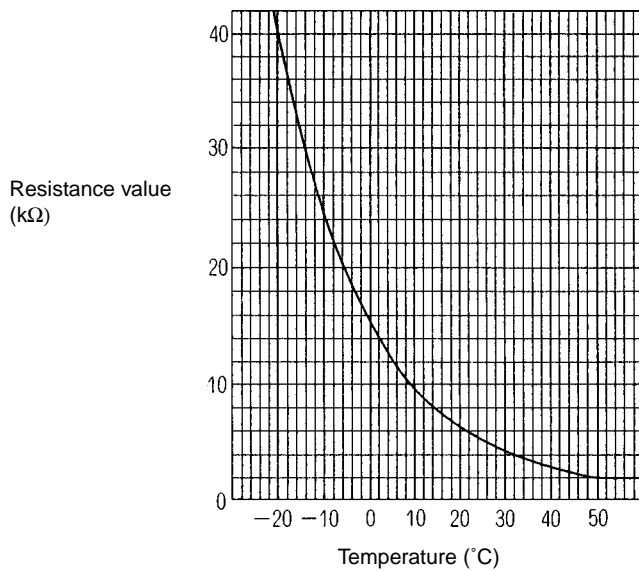

Thermistor $R_0=15\text{ k}\Omega$

$$R_t=15\text{exp } 3460 \left\{ \frac{1}{273+t} - \frac{1}{273} \right\}$$

Note 4 :

- Check using LED monitor display switch (outdoor MAIN board SW1)

Measured Data	Signal	SW1 Setting	Remarks
Liquid inlet temperature	TH11	ON	See converter.
Bypass outlet temperature	TH12	ON	See converter.
Bypass outlet temperature	TH15	ON	See converter.
Bypass inlet temperature	TH16	ON	See converter.

3) LEV, Solenoid Valve Troubleshooting Flow

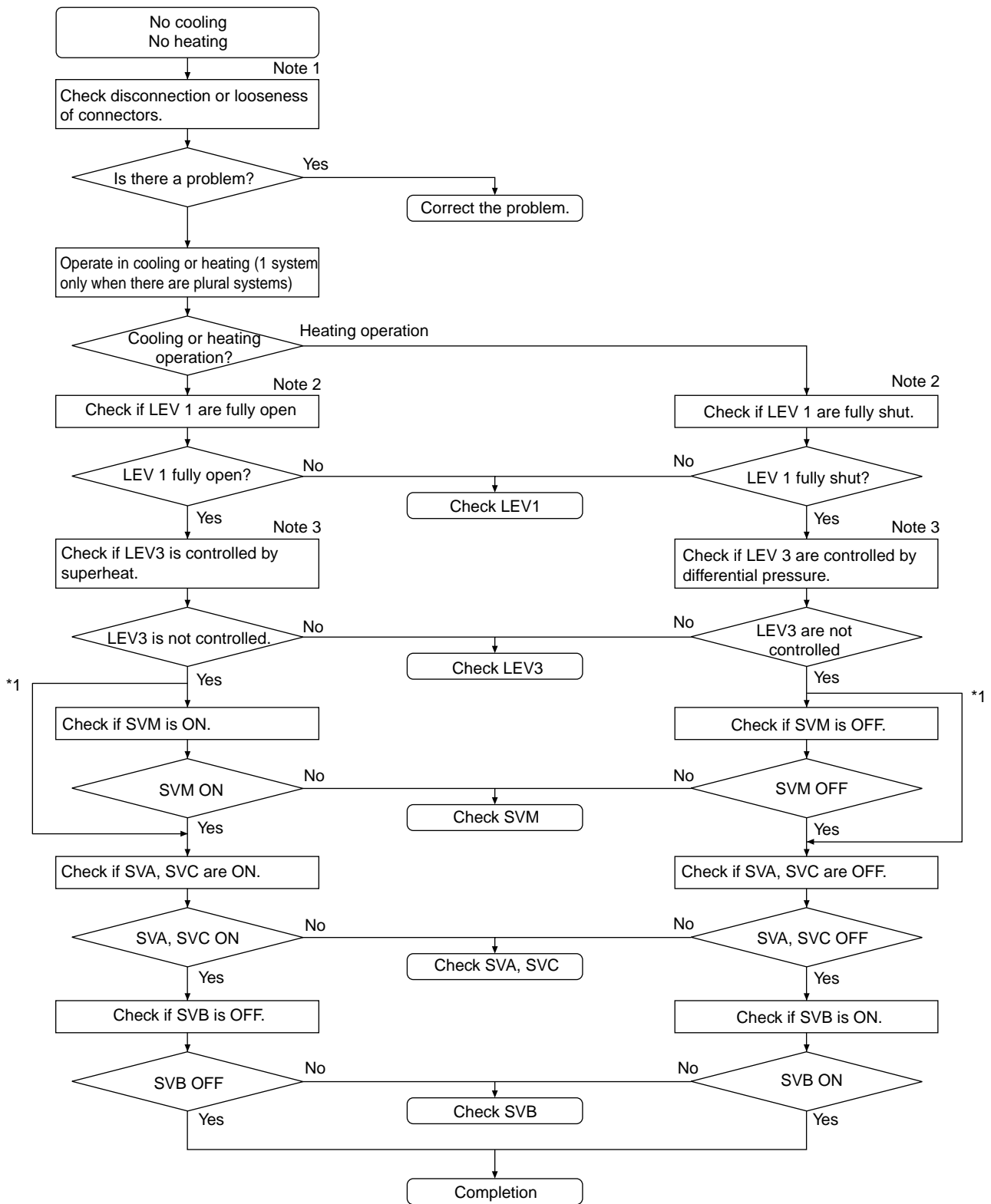

*1. SVM is not built in depending on models.

① LEV

Note 1 :

- Symptoms of incorrect connection to BC controller LEV board

LEV No.	1	3	Cooling-only	Cooling-main	Heating-only	Heating-main
1)	1	3	Normal	←	←	←
2)	3	1	Insufficient cooling SH12 small, SC11 small SC16 small Branch piping SC small	Insufficient cooling, insufficient heating SH12 small, SC11 small SC16 large, Branch piping SC small △ PHM large	Heating indoor SC small △ PHM large	Insufficient cooling Heating indoor SC small △ PHM large

Improper installation is the same for ① and ②, so it is omitted here.

Note 2 : Method for checking LEV full open, full closed condition

- ① Check LEV full opening (pulse) using the LED monitor display (outdoor controller board SW1).
Full opened: 2000 pulses
Full closed: 60 pulses (LEV 1 may be greater than 60 during full heating operation.)
- ② With LEV full opened, check for pressure differential by measuring temperature of piping on both sides.
- ③ With LEV full closed, check for refrigerant noise.

Note 3 : Use the following table to determine opening due to LEV differential pressure control and superheat control.

- BC controller LEV basic operation characteristics

Region	Failure mode	Operating mode	Description	Normal range
LEV1 pulse	Small	Heating-only	High pressure (PS1) - medium pressure (PS3) is large.	2.0 ~ 3.5 kg/cm ² G (0.20~0.34MPa)
	Large	Heating-main Cooling-main	High pressure (PS1) - medium pressure (PS3) is small.	
LEV3 pulse	Small	Cooling-only Cooling-main	SH12 is large.	SH12<25
		Heating-only Heating-main	High pressure (PS1) - mid pressure (PS3) is small.	2.0 ~ 3.5 kg/cm ² G (0.20~0.34MPa)
	Large	Cooling-only Cooling-main	SC16 and SH12 are small.	SC16>6 SH12>5
		Heating-only Heating-main	High pressure (PS1) - mid pressure (PS3) is large.	2.0 ~ 3.5 kg/cm ² G (0.20~0.34MPa)

(Self-diagnostic monitor)

Measured Data	Signal	OUTDOOR MAIN board SW1 Setting
LEV1 pulse	-	
LEV 3 pulse	-	
BC controller bypass output superheat	SH12	
BC controller intermediate subcool	SC16	
BC controller liquid subcool	SC11	

* There are not LEV2 and LEV4 on CMB-P-V-E.

(Solenoid Valve Troubleshooting Flow)

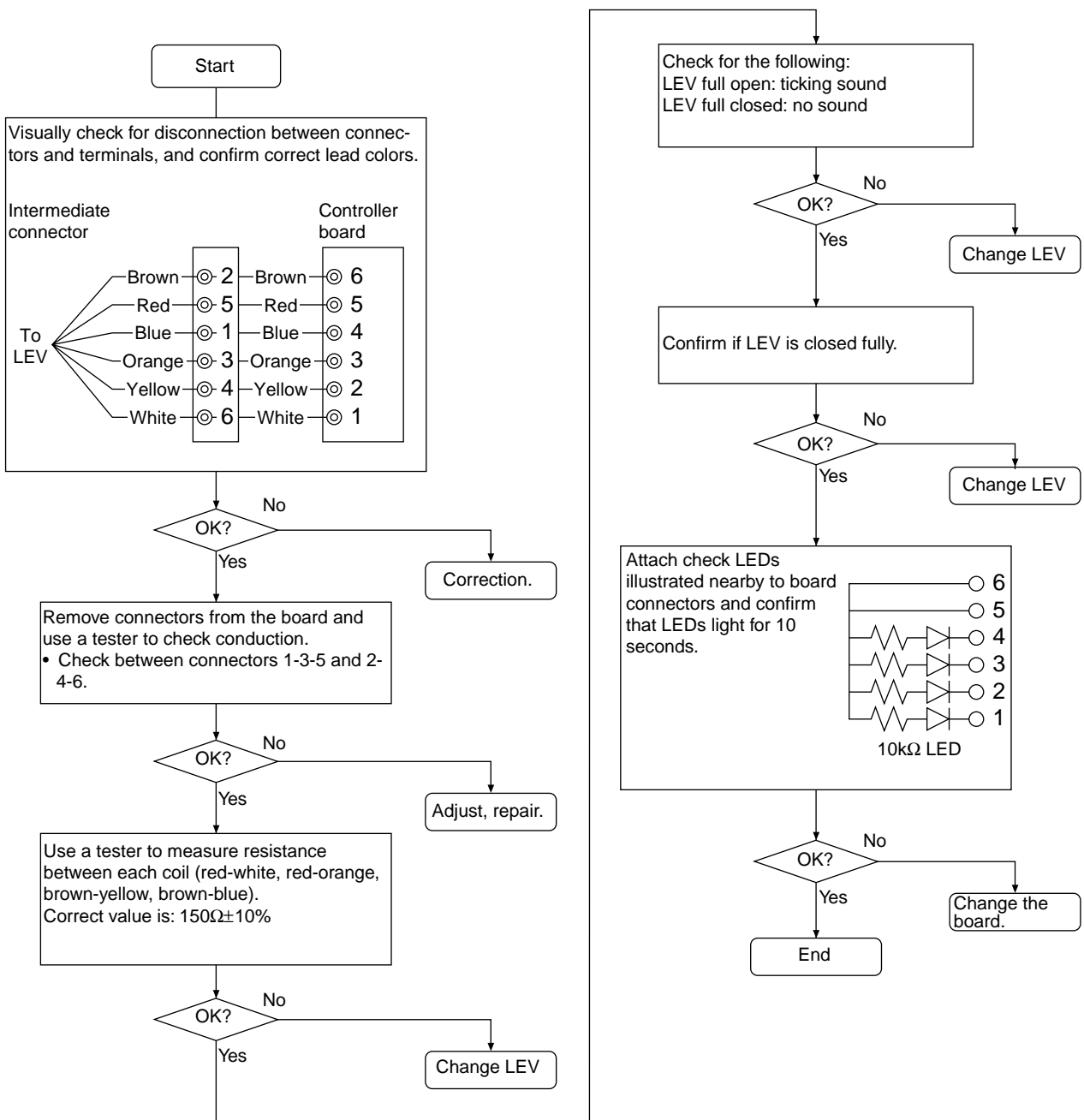

② Solenoid Valve

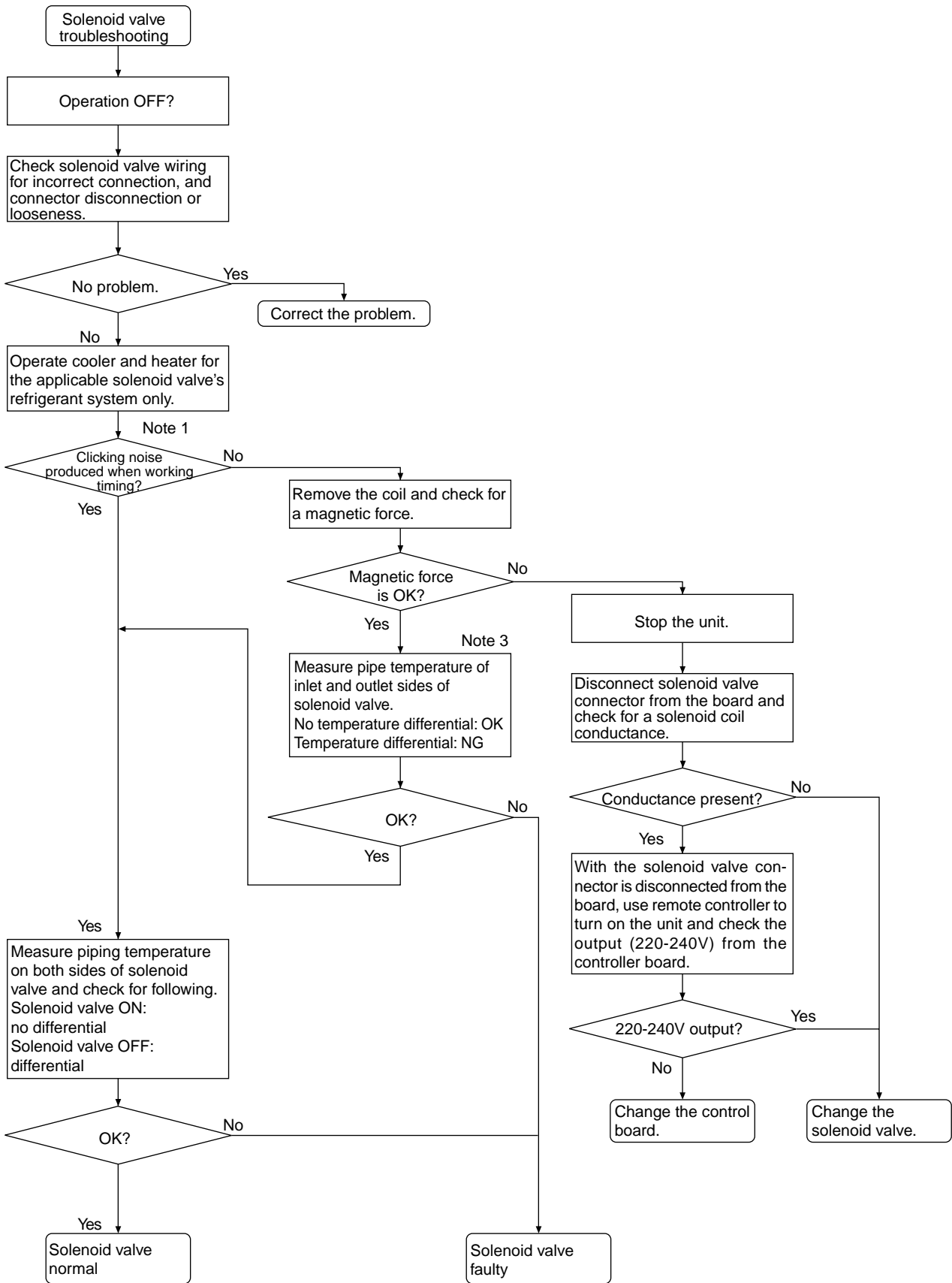

Solenoid valves (SVA, SVB, SVC, SVM)

Coordination signals output from the board and solenoid valve operations. *SVM is not built in depending on models.

Note 1 : (SVA, SVB, SVC)

SVA, SVB and SVC are turned on and off in accordance with operation mode.

Mode \ Branch port	Cooling	Heating	Stopped	Defrosting
SVA	ON	OFF	OFF	OFF
SVB	OFF	ON	OFF	OFF
SVC	ON	OFF	OFF	OFF

(SVM)

SVM is turned on and off in accordance with operation mode.

Operation Mode	Cooling-only	Cooling-principal	Heating-only	Heating-principal	Defrosting	Stopped
SVM	ON	OFF	OFF	OFF	ON	OFF

Note 2 : (SVA, SVB, SVC)

Measure temperature of piping on either side of SVA ①-Ⓐ

Measure temperature of piping on either side of SVB ①-Ⓑ

(SVM)

Measure temperature at points marked "X".

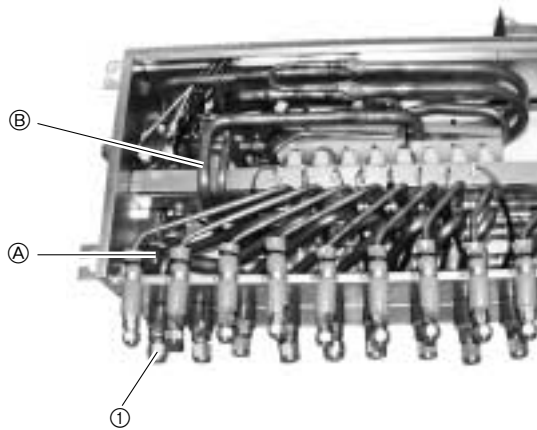

CMB-P-V-E

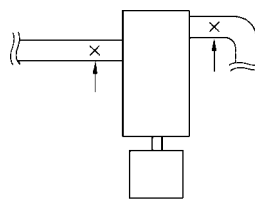

4) BC controller transformer

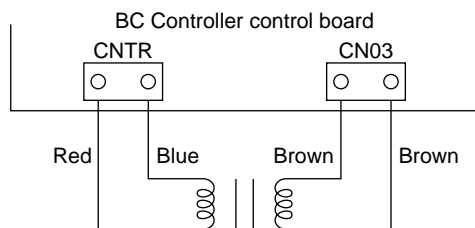

	Normal	Malfunction
CNTR(1)-(3)	Approximately 90Ω	Open or shorted
CN03(1)-(3)	Approximately 1.7Ω	

* Disconnect the connector before measurement.

[2] BC Controller Disassembly Procedure

(1) Service panel

Be careful on removing heavy parts.

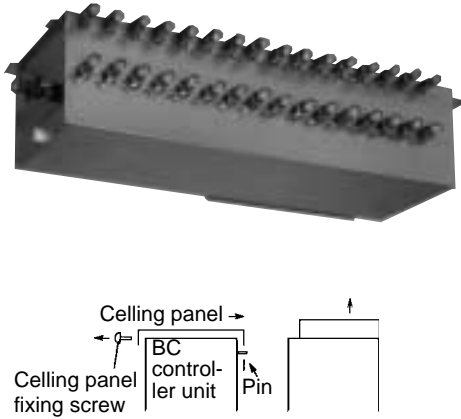
Procedure	Photos & Illustrations
<ol style="list-style-type: none">1. Remove the two screws securing the electric panel box, and then remove the box.2. Remove the four screws securing the front panel and then remove the panel. Two of the screws are not visible until you remove the electric panel box.3. Remove the two screws securing the ceiling panel. Next, lifting up on the panel slightly, slide it inwards and then remove it. The inside of the ceiling panel is hooked on a pin.4. Remove the single screw that secures the side panel, and then remove the panel.	

(2) Control Box

Be careful on removing heavy parts.

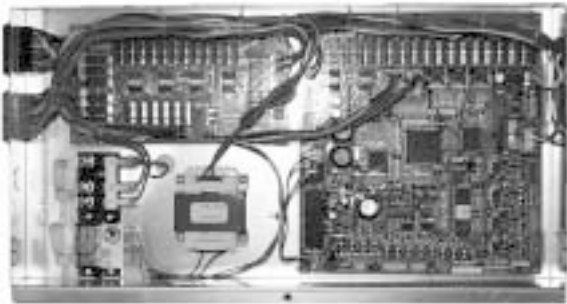
Procedure	Photos
<p data-bbox="145 300 448 329"><CMB-P104, 105, 106V-D></p> <ol style="list-style-type: none"><li data-bbox="145 331 730 613">1. Removing the single screw that secures the electric panel box cover provides access to the box contents for checking.<ol style="list-style-type: none"><li data-bbox="188 427 730 488">① Check electrical lead wires and transmission lead terminal connections.<li data-bbox="188 492 472 521">② Check the transformer.<li data-bbox="188 526 512 555">③ Check the address switch.<li data-bbox="188 560 730 613">④ Use the self-diagnostic switch to check the LED display.<li data-bbox="145 651 730 801">2. Disconnect the power supply lead, transmission lead, transformer lead connector, and address switch wiring connector. Removing the screw securing the inner cover provides access for checking the entire controller board.<li data-bbox="145 840 730 1122">3. Note the following precautions whenever replacing the controller board.<ol style="list-style-type: none"><li data-bbox="188 907 730 967">① Be sure you do not confuse a Type A controller board with a Type B controller board.<li data-bbox="188 972 730 1061">② Take care to avoid mistakes when connecting leads and connectors, and double-check for incomplete and loose connections.<li data-bbox="188 1066 730 1122">③ Check to make sure that DIP switch settings are the same before and after replacement. <p data-bbox="145 1160 264 1189">Important!</p> <p data-bbox="188 1193 715 1283">You do not need to remove the two electric panel screws if you are checking electric panel box contents only.</p> <p data-bbox="145 1321 544 1350"><CMB-P108, 1010, 1013, 1016V-E></p> <p data-bbox="188 1355 730 1505">Removing the single screw that secures the electric panel box cover provides access to the controller board and all of the relay board for checking. So it is not necessary to work according to above 2.</p>	

(3) Thermistor (Liquid and gas piping temperature detection)

Be careful when removing heavy parts.

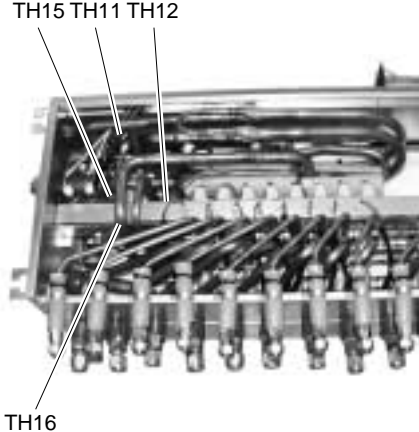
Procedure	Photos
<p>1. Remove the service panel</p> <p>① Use the procedure under (1)-1.2 to check TH11, TH12, and TH15.</p> <p>2. Disconnect the piping sensor lead from the controller panel.</p> <p>① TH11 - TH12 (CN10)</p> <p>② TH15, TH16 (CN11)</p> <p>3. Pull the temperature sensor from the temperature sensor housing and replace it with a new sensor.</p> <p>4. Connect the temperature sensor lead securely to the controller board.</p>	

(4) Pressure Sensor

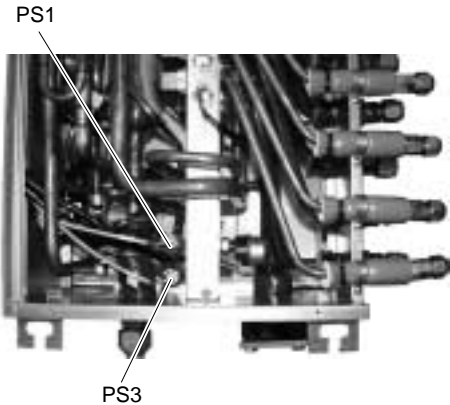
Procedure	Photos
<p>1. Remove the sensor panel.</p> <p>① Use the procedure under (1)-1.2 to check PS1 and PS3.</p> <p>2. Disconnect the connector of the applicable pressure sensor from the controller board and insulate the connector.</p> <p>① Liquid pressure sensor (CNP1)</p> <p>② Intermediate pressure sensor (CNP3)</p> <p>3. Install a new pressure sensor at the location shown in the photograph, and plug the connector into the controller board.</p> <p>Important</p> <p>① In the case of gas leakage from the pressure sensor, take actions to fix the leak before performing the above procedure.</p>	

(5) LEV

Be careful on removing heavy parts.

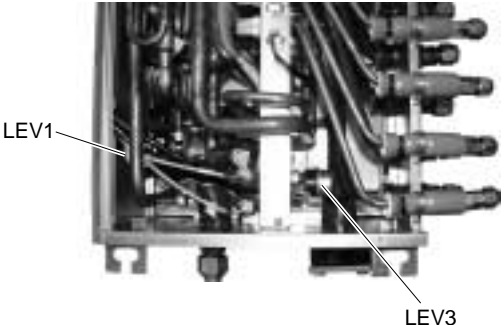
Procedure	Photos
<p>1. Remove the service panel. See (1)-1.2.3.4.</p> <p>2. Replace the applicable LEV.</p> <p>Important!</p> <p>① When performing the above procedure, be sure to allow for enough service space in the ceiling area for welding.</p> <p>② When conditions require, the unit can be lowered from the ceiling before starting work.</p>	

(6) Solenoid Valve Coil

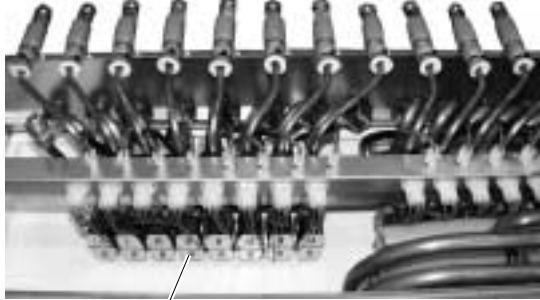
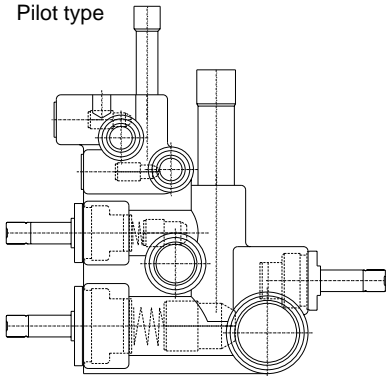
Procedure	Photos & Illustrations
<p>1. Remove the service panel. See (1)-1.2.3.4.</p> <p>2. Disconnect the connector of the applicable solenoid valve.</p> <p>3. Remove the solenoid valve coil.</p> <p>① SVA, SVB, and SVM solenoid valve coils can be serviced from the maintenance port. SVC can be serviced from the back if service space is available in the back. To remove the back panel, remove the two screws that secure it.</p> <p>4. When the solenoid valve is defective, remove the unit front panel, disassemble the solenoid valve block, and check the interior of the valve. When disassembly space or footing for disassembly of the solenoid valve block in the vicinity of the flow controller is not available, the unit can be lowered from the ceiling to perform the work.</p> <p>① To view the interior of a valve, use a torque wrench to open the screw cover of the movable component compartment and the plunger.</p> <p>② When replacing the screw cover and plunger, tighten them to the specified torque.</p> <p>SVA screw cover: 20 kg-m (2.0 N-m) SVB screw cover: 13 kg-m (1.3 N-m) SVA, B, C plungers: 6 kg-m (0.6 N-m)</p> <p>Important!</p> <p>① You cannot check the valve interiors of SVC and SVM.</p> <p>② Be sure to tighten screw covers and plungers to specified torque values. Under-tightening can cause gas leaks, over-tightening can cause abnormal operation.</p>	 <p>Solenoid valve</p>  <p>Pilot type</p> <p>Direct drive type</p>

Check Code List

Check Code	Check Content	
0403	Serial transmission abnormality	
0900	Trial operation	
1102	Discharge temperature abnormality	
1111	Low pressure saturation temperature sensor abnormality (TH2)	
1112	Low pressure saturation	Liquid level sensing temperature sensor abnormality (TH4)
1113	temperature abnormality	Liquid level sensing temperature sensor abnormality (TH3)
1301	Low pressure abnormality (OC)	
1302	High pressure abnormality (OC)	
1368	Liquid side pressure abnormality (BC)	
1370	Intermediate pressure abnormality (BC)	
1500	Overcharged refrigerant abnormality	
1501	Low refrigerant abnormality	
1505	Suction pressure abnormality	
2500	Leakage (water) abnormality	
2502	Drain pump abnormality	
2503	Drain sensor abnormality	
4103	Reverse phase abnormality	
4115	Power supply sync signal abnormality	
4116	Fan speed abnormality (motor abnormality)	
4200	VDC sensor/circuit abnormality	
4220	Bus voltage abnormality	
4230	Radiator panel overheat protection	
4240	Over load protection	
4250	IPM Alarm output / Bus voltage abnormality / Over Current Protection	
4260	Cooling fan abnormality	
5101	Thermal sensor abnormality	Air inlet (TH21:IC)
		Discharge (TH1:OC)
5102		Liquid pipe (TH22:IC)
		Low pressure saturation (TH2:OC)
5103		Gas pipe (TH23:IC)
		Accumulator liquid level (LD1)
5104		Accumulator liquid level (LD2)
5105		Liquid pipe (TH5)
5106		Ambient temperature (TH6)
5107		SC coil outlet (TH7)
5108		SC coil bypass outlet (TH8)
5109		CS circuit (TH9)
5110		Radiator panel (THHS)
5112		Compressor shell temperature (TH10)
5201	Pressure sensor abnormality (OC)	
	Liquid side pressure sensor abnormality (BC)	
5203	Intermediate side pressure sensor abnormality (BC)	
5301	IAC sensor/circuit abnormality	
6600	Multiple address abnormality	
6602	Transmission processor hardware abnormality	
6603	Transmission circuit bus-busy abnormality	

Check Code	Check Content
6606	Communications with transmission processor abnormality
6607	No ACK abnormality
6608	No response abnormality
7100	Total capacity abnormality
7101	Capacity code abnormality
7102	Connected unit count over
7105	Address setting abnormality
7106	Characteristics setting abnormality
7107	Connection number setting abnormality
7111	Remote control sensor abnormality
7130	Different indoor model connected abnormality

Intermittent fault check code

Trouble Delay Code	Trouble Delay Content
1202	Preliminary discharge temperature abnormality or preliminary discharge thermal sensor abnormality (TH1)
1205	Preliminary liquid pipe temperature sensor abnormality (TH5)
1211	Preliminary low pressure saturation abnormality or preliminary low pressure saturation sensor abnormality (TH2)
1214	Preliminary THHS sensor/circuit abnormality
1216	Preliminary sub-cool coil outlet thermal sensor abnormality (TH7)
1217	Preliminary sub-cool coil bypass outlet thermal sensor abnormality (TH8)
1219	Preliminary sub-cool coil bypass inlet thermal sensor abnormality (TH9)
1221	Preliminary ambient temperature thermal sensor abnormality (TH6)
1243	Preliminary compressor shell thermal sensor abnormality (TH10)
1402	Preliminary high pressure abnormality or preliminary pressure sensor abnormality
1600	Preliminary overcharged refrigerant abnormality
1601	Preliminary lacked refrigerant abnormality
1605	Preliminary suction pressure abnormality
1607	CS circuit block abnormality
4300	Preliminary IAC sensor/circuit abnormality
	Preliminary VDC sensor/circuit abnormality
	Preliminary serial transmission abnormality
4320	Preliminary bus voltage abnormality
4330	Preliminary heat sink overheating abnormality
4340	Preliminary overload protection
4350	Preliminary overcurrent protection
4360	Preliminary cooling fan abnormality

[3] Self-diagnosis and Countermeasures Depending on the Check Code Displayed

(1) Mechanical

Checking code		Meaning, detecting method	Cause	Checking method & Countermeasure
0403	Serial transmission abnormality	If serial transmission cannot be established between the MAIN and INV boards.	1) Wiring is defective.	Check 1, the connections, 2, contact at the connectors and 3, for broken wires in the following wiring. CNRS2 - CNRS3 CNAC2 - TB1B
			2) Switches are set wrong on the INV board.	SW1-4 on the INV board should be OFF.
			3) A fuse (F01) on the INV board is defective.	If the fuse is melted, (if the resistance between the both ends of fuse is ∞), replace the fuse.
			4) The circuit board is defective.	If none of the items in 1) to 3) is applicable, and if the trouble reappears even after the power is switched on again, replace the circuit board by the following procedure (when replacing the circuit board, be sure to connect all the connectors, ground wires, etc. securely). ① If serial transmission is restored after the INV board only is replaced, then the INV board is defective. ② If serial transmission is not restored, reinstall the INV board and replace the MAIN board. If serial transmission is restored, the MAIN board is defective. ③ If serial transmission is not restored by ① and ② above, replace both boards.

Checking code	Meaning, detecting method	Cause	Checking method & Countermeasure
1102	Discharge temperature abnormality (Outdoor unit)	1) Gas leak, gas shortage.	See Refrigerant amount check .
		2) Overload operations.	Check operating conditions and operation status of indoor/outdoor units.
		3) Poor operations of indoor LEV. 4) Poor operations of OC controller LEV: Cooling : LEV1 5) Poor operations of BC controller LEV: Cooling-only : LEV3 Cooling-main : LEV1, 3 Heating-only, Heating-main: LEV3 Defronst : LEV3	Check operation status by actually performing cooling or heating operations. Cooling : Indoor LEV (Cooling-only) LEV1 (PUHY) LEV1, 3 (BC) SVM (BC) SVA (BC) Heating : Indoor LEV (Heating-only) LEV3 (BC) SVB (BC) SV3 ~ 6 (PURY)
		6) Poor operations of BC controller SVM: Cooling-only, defrost 7) Poor operations of BC controller SVA : Cooling-only, Cooling-main 8) Poor operations of BC controller SVB : Heating-only, Heating-main 9) Poor operations of solenoid valves. SV (3 ~ 6) (PURY)→ Heating-only, Heating-main	See Trouble check of LEV and solenoid valve .
		10) Setting error of connection address (PURY).	Check address setting of indoor unit connection.
		11) Poor operations of ball valve.	Confirm that ball valve is fully opened.
		12) Outdoor unit fan block, motor trouble, poor operations of fan controller→Heating (Heating-only, Heating-main). [3) ~ 12) : Rise in discharge temp. by low pressure drawing.]	Check outdoor fan. See Trouble check of outdoor fan .
		13) Gas leak between low and high pressures. [4-way valve trouble, compressor trouble, solenoid valve SV1 trouble.]	Check operation status of cooling-only or heating-only.
		14) Poor operations of solenoid valve SV2. [Bypass valve SV2 can not control rise in discharge temp.]	See Trouble check of solenoid valve .
		15) Thermistor trouble.	Check resistance of thermistor.
		16) Thermistor input circuit trouble on control circuit board.	Check inlet temperature of sensor with LED monitor.

* There are not LEV2 and LEV4 on CMB-P-V-E.

Checking code		Meaning, detecting method	Cause	Checking method & Countermeasure
1111	Low pressure saturation temperature sensor abnormality (TH2)	<p>1. When saturation temperature sensor (TH2) or liquid level detecting temperature sensors (TH3, TH4) detects -40°C or less (the first time) during operations, outdoor unit stops once, mode is changed to restart mode after 3 minutes, then the outdoor unit restarts.</p> <p>2. When -40°C or less temp. is detected again (the second time) within 30 minutes after stop of outdoor unit, error stop is observed with code Nos. "1111," "1112," or "1113" displayed.</p> <p>3. When -40°C or less temperature is detected 30 or more minutes after stop of outdoor unit, the stop is regarded as the first time and the process shown in 1. is observed.</p>	1) Gas leak, Gas shortage.	See Refrigerant amount check.
			<p>2) Insufficient load operations.</p> <p>3) Poor operations of indoor LEV.</p> <p>4) Poor operations of OC controller LEV: Cooling : LEV1</p> <p>5) Poor operations of BC controller LEV: Cooling-only : LEV3 Cooling-main : LEV1, 3 Heating-only, Heating-main: LEV3</p> <p>6) Poor operations of BC controller SVM: Cooling-only, Defrost</p> <p>7) Poor operations of BC controller SVM: Cooling-only, Cooling-main</p> <p>8) Poor operations of BC controller SVB: Heating-only, Heating-main</p> <p>9) Solenoid valve trouble (SV3 ~ 6) (PURY). PUHY-P (SV3 ~ 4) Heating-only, Heating-main</p>	<p>Cooling-only : indoor LEV LEV1 (PUHY) LEV1, 3 (BC) SVM (BC) SVA (BC)</p> <p>Heating-only : indoor LEV LEV3 (PURY) (BC) SVB (BC) SV3~6 (PURY) SV3~4 (PUHY-P)</p>
1112	Liquid level detecting temperature sensor abnormality (TH4)	<p>4. 30 minutes after stop of outdoor unit is intermittent fault check period with LED displayed.</p> <p>Note: 1. Low press. saturation temperature trouble is not detected for 3 minutes after compressor start, and finish of defrosting operations, and during defrosting operations.</p> <p>2. In the case of short/open of TH2~TH4 sensors before starting of compressor or within 10 minutes after starting of compressor, "1111," "1112," or "1113" is displayed too.</p>	10) Setting error of connection address.	Check address setting of indoor unit connector.
			<p>11) Poor operations of ball valve.</p> <p>12) Short cycle of indoor unit.</p> <p>13) Clogging of indoor unit filter.</p> <p>14) Fall in air volume caused by dust on indoor unit fan.</p> <p>15) Dust on indoor unit heat exchanger.</p> <p>16) Indoor unit block, Motor trouble.</p>	<p>Check indoor unit, and take measures to trouble.</p> <p>Confirm that ball valve is fully opened.</p>
1113	Low pressure saturation temperature trouble	Liquid level detecting temperature sensor abnormality (TH3)	[10)~15) : Fall in low pressure caused by evaporating capacity in cooling-only cooling-principal operation.]	
			17) Short cycle of outdoor unit. 18) Dust on outdoor heat exchanger.	Check outdoor unit, and take measures to trouble.
			19) Indoor unit fan block, motor trouble, and poor operations of fan controller. [16)~18) : Fall in low press. caused by lowered evaporating capacity in heating-only heating-principal operation.]	Check outdoor unit fan. See Trouble check of outdoor unit fan.
			20) Poor operations of solenoid valve SV2. [Bypass valve (SV2) can not control low pressure drop.]	See Trouble check of solenoid valve.
			21) Thermistor trouble (TH2~TH10).	Check resistance of thermistor.
			22) Pressure sensor abnormality.	See Trouble check of pressure sensor.
			23) Control circuit board thermistor abnormality and pressure sensor input circuit abnormality.	Check inlet temp. and press. of sensor by LED monitor.
			24) Poor mounting of thermistor (TH2~TH10).	

Checking code	Meaning, detecting method	Cause	Checking method & Countermeasure	
1301	Low pressure abnormality	<p>When starting from the stop mode for the first time, (if at the start of bind power transmission, the end of bind power transmission, and in the mode when the thermostat goes OFF immediately after the remote control goes ON, the following compressor start time is included), if the low pressure sensor before starting is at 1.0 kg/cm²G (0.098MPa), operation stops immediately.</p>	<ol style="list-style-type: none"> 1) Internal pressure is dropping due to a gas leak. 2) The low pressure sensor is defective. 3) Insulation is torn. 4) A pin is missing in the connector, or there is faulty contact. 5) A wire is disconnected. 6) The control board's low pressure sensor input circuit is defective. 	Refer to the item on judging low pressure sensor failure.
1302	High pressure abnormality 1 (Outdoor unit)	<ol style="list-style-type: none"> 1. When press. sensor detects 28kg/cm²G (2.47MPa) or more during operations (the first time), outdoor unit stops once, mode is changed to restart mode after 3 minutes, then the outdoor unit restarts. 2. When 30kg/cm²G (2.94MPa) or more pressure is detected again (the second time) within 30 minutes after stop of outdoor unit, error stop is observed with code No. "1302" displayed. 3. When 28kg/cm²G (2.47MPa) or more pressure is detected 30 or more minutes after stop of outdoor unit, the detection is regarded as the first time and the process shown in 1 is observed. 4. 30 minutes after stop of outdoor unit is intermittent fault check period with LED displayed. 5. Error stop is observed immediately when press. switch (30⁺⁰_{-1.5} kg/cm²G (2.94⁺⁰_{-1.5} MPa)) operates in addition to pressure sensor. 	<ol style="list-style-type: none"> 1) Poor operations of indoor LEV. 2) Poor operations of outdoor LEV1 (PUHY). 3) Poor operations of BC controller LEV: Heating-only, heating-principal: LEV3 Defrost: LEV3 4) Poor operations of BC controller SVM: Cooling-only, defrost 5) Poor operations of BC controller SVA: Cooling-only, cooling-main 6) Poor operations of BC controller SVB: Heating-only, heating-main 7) Solenoid valve SV (3 ~ 6) trouble (PURY). SV3 ~ 4 (PUHY-P) Cooling-only, cooling-main 8) Setting error of connection address. 9) Poor operations of ball valve. 10) Short cycle of indoor unit. 11) Clogging of indoor unit filter. 12) Fall in air volume caused by dust on indoor unit fan. 13) Dust on indoor unit heat exchanger. 14) Indoor unit fan block, motor trouble. [9~14) : Rise in high pressure caused by lowered condensing capacity in heating-only and heating-principal operation.] 15) Short cycle of outdoor unit. 16) Dust on outdoor unit heat exchanger. 17) Outdoor unit fan block, motor trouble, poor operations of fan controller. [15)~17): Rise in high press. caused by lowered condensing capacity in cooling-only and cooling-principal operation.] 18) Poor operations of solenoid valves SV1, 2 (Bypass valves (SV1, 2) can not control rise in high pressure). 19) Thermistor trouble (TH2, TH5, TH6). 20) Pressure sensor trouble. 21) Control circuit board thermistor trouble, press. sensor input circuit trouble. 	<p>Check operations status by actually performing cooling or heating operations.</p> <p>Cooling : Indoor LEV LEV1 (PUHY) LEV1, 3 (BC) SVM SVA (BC) SV3~6 (PURY) SV3~4 (PUHY-P)</p> <p>Heating : Indoor LEV LEV3 (BC) SVB (BC)</p> <p>See Trouble check of LEV and solenoid valve.</p> <p>Check address setting of indoor unit connector.</p> <p>Confirm that ball valve is fully open-ed.</p> <p>Check indoor unit and take measures to trouble.</p> <p>Check outdoor unit and take measures to trouble.</p> <p>Check outdoor unit fan See Trouble check of outdoor unit fan.</p> <p>See Trouble check of solenoid valve.</p> <p>Check resistance of thermistor.</p> <p>Check Trouble check of pressure sensor.</p> <p>Check inlet temperature and press. of sensor with LED monitor.</p>

Checking code		Meaning, detecting method	Cause	Checking method & Countermeasure						
1302	High pressure abnormality 2 (Outdoor unit)	When press. sensor detects 1kg/cm ² G (0.098MPa) or less just before starting of operation, error stop is observed with code No. "1302" displayed.	<ol style="list-style-type: none"> 1) Fall in internal press. caused by gas leak. 2) Press. sensor trouble. 3) Film breakage. 4) Coming off of pin in connector portion, poor contact. 5) Broken wire. 6) Press. sensor input circuit trouble on control circuit board. 	See Trouble check of pressure sensor.						
1368	Liquid side High pressure abnormality (BC controller)	When liquid side press. sensor, gas side pressure sensor, or intermediate pressure sensor detects 30kg/cm ² G (2.94MPa) or more, error stop is observed with code No. "1368", or "1370" displayed.	<ol style="list-style-type: none"> 1) Poor operations of indoor LEV. 2) Poor operations of BC controller LEV: Heating-only, heating-principal: LEV3 Defrost: LEV3 3) Poor operations of BC controller SVM: Cooling-only, defrost 4) Poor operations of BC controller SVA: Cooling-only, cooling-principal 5) Poor operations of BC controller SVB: Heating-only, heating-principal 6) Solenoid valve SV (3 ~ 6) trouble. Cooling-only, cooling-principal 	<p>Check operations status by actually performing cooling or heating operations.</p> <table style="margin-left: 40px;"> <tr> <td>Cooling</td> <td>:</td> <td>Indoor LEV LEV1, 3 SVM SVA SV3~6</td> </tr> <tr> <td>Heating</td> <td>:</td> <td>Indoor LEV LEV3 SVB</td> </tr> </table> <p>See Trouble check of LEV and solenoid valve.</p>	Cooling	:	Indoor LEV LEV1, 3 SVM SVA SV3~6	Heating	:	Indoor LEV LEV3 SVB
			Cooling	:	Indoor LEV LEV1, 3 SVM SVA SV3~6					
			Heating	:	Indoor LEV LEV3 SVB					
			7) Setting error of connection address.	Check address setting of indoor unit connector.						
			8) Poor operations of ball valve.	Confirm that ball valve is fully opened.						
			<ol style="list-style-type: none"> 9) Short cycle of indoor unit. 10) Clogging of indoor unit filter. 11) Fall in air volume caused by dust on indoor unit fan. 12) Dust on indoor unit heat exchanger. 13) Indoor unit fan block, motor trouble. <div style="border: 1px solid black; padding: 2px; width: fit-content; margin: 5px auto;"> [9)~13) : Rise in high pressure caused by lowered condensing capacity in heating-only and heating-principal operation.] </div>	Check indoor unit and take measures to trouble.						
			<ol style="list-style-type: none"> 14) Short cycle of outdoor unit. 15) Dust on outdoor unit heat exchanger. 	Check outdoor unit and take measures to trouble.						
			<ol style="list-style-type: none"> 16) Outdoor unit fan block, motor trouble, poor operations of fan controller. <div style="border: 1px solid black; padding: 2px; width: fit-content; margin: 5px auto;"> [14)~16) : Rise in high press. caused by lowered condensing capacity in cooling-only and cooling-principal operation.] </div>	Check outdoor unit fan. See Trouble check of outdoor unit fan.						
			17) Poor operations of solenoid valves SV1, 2. (Bypass valves (SV1, 2) can not control rise in high pressure.)	See Trouble check of solenoid valve.						
			18) Thermistor trouble (TH2, TH5, TH6).	Check resistance of thermistor.						
19) Pressure sensor trouble.	Check Trouble check of pressure sensor.									
20) Control circuit board thermistor trouble, press. sensor input circuit trouble.	Check inlet temperature and press. of sensor with LED monitor.									
21) Poor mounting of thermistor. (TH2, TH5, H6)										
1370	Intermediate side									

Checking code		Meaning, detecting method	Cause	Checking method
1500	Overcharged refrigerant abnormality	<p>1. When discharge superheat ≤ 10 deg is keeping for 10 minutes or discharge superheat ≤ 20 deg for 15 minutes, outdoor unit stops once, and after 3 minutes, the unit restarts. For 60 minutes after unit stopped is intermittent fault check period.</p> <p>2. When discharge superheat ≤ 10 deg is keeping for 10 minutes or discharge superheat ≤ 20 deg for 15 minutes again (second time), the unit stops and error code 1500 is displayed.</p> <p>3. In case of SW2-6 ON, the detection for the second time is followed by the first time.</p>	<p>1) Excessive refrigerant charge.</p> <p>2) Thermistor trouble (TH1).</p> <p>3) Pressure sensor trouble (63HS).</p> <p>4) Control circuit board trouble.</p>	<p>Check refrigerant amount.</p> <p>Check resistance of thermistor.</p> <p>See trouble shooting of pressure sensor.</p> <p>Check temperature and pressure sensor with LED monitor.</p>
1501	Lacked refrigerant abnormality	<p>1. When the unit condition is as follows, the compressor is stopped (1st detection) and after 3 minutes, the compressor is restarted automatically.</p> <p>PUHY-P200-250YMF-C</p> <p>① F<60Hz and TH10>85°C continuously for 60 minutes.</p> <p>② F<60Hz and TH10>95°C continuously for 15 minutes.</p> <p>③ F\geq 60Hz and TH10>100°C continuously for 60 minutes.</p> <p>④ F\geq 60Hz and TH10>110°C continuously for 15 minutes.</p> <p>PURY-P200-250YMF-C</p> <p>① F<60Hz and TH10>85°C continuously for 60 minutes.</p> <p>② F<60Hz and TH10>95°C continuously for 15 minutes.</p> <p>③ F\geq 60Hz and TH10>100°C continuously for 60 minutes.</p> <p>④ F\geq 60Hz and TH10>110°C continuously for 15 minutes.</p> <p>2. If the temperature rises again as above within 2 hours after the outdoor unit is stopped (2nd detection), an error stop is performed, and the check code 1501 is displayed.</p> <p>3. If the temperature rises again as above within 2 hours after the outdoor unit is stopped, it becomes the first detection again, and operation is the same as in 1 above.</p> <p>4. The 2 hour period after the outdoor unit stops is the abnormal delay period, and LED display is carried out during the abnormal stop delay.</p>	<p>1) Gas leakage, insufficient gas.</p> <p>2) Overload operation.</p> <p>3) Indoor unit LEV operation is faulty.</p> <p>4) Outdoor unit LEV1 operation is faulty.</p> <p>5) Outdoor unit SLEV operation is faulty.</p> <p>6) Ball valve operation is faulty.</p> <p>7) The thermistor is faulty.</p> <p>8) The control board's thermistor input circuit is faulty.</p>	<p>Refer to the item on judging the refrigerant volume.</p> <p>Check the indoor and outdoor unit operating conditions.</p> <p>Actually run the equipment in cooling or heating mode and check the operating condition.</p> <p>Cooling : Indoor unit LEV LEV1 (PUHY) SLEV</p> <p>Heating : Indoor unit LEV SLEV</p> <p>Refer to the item concerning judging LEV failure.</p> <p>Check with the ball valve fully open.</p> <p>Check the thermistor's resistance.</p> <p>Check the sensor's temperature reading by the LED monitor.</p>
	Insufficient refrigerant abnormality			

Checking code	Meaning, detecting method	Cause	Checking method & Countermeasure
1505	<p>Suction pressure abnormality</p> <p><PUHY-200-250YMF-C> 1. Judging the state when the suction pressure reaches near 0kg/cm²G (0MPa) during compressor operation by the low pressure saturation temperature, error stop will be commenced displaying "1505". 2. The outdoor unit once stops entering into the 3-minutes restart mode if the state of 1 continues for 3 minutes, and restarts after 3 minutes. 3. After restarting, if the same state as 1 continues within 30 minutes from the stopping of 2, error stop will be commenced displaying "1505". 4. Ineffective if the compressor operating time (integrated) exceeds 60-minutes not detecting trouble.</p> <p><PUHY-P200-250YMF-C> <PURY-(P)200-250YMF-C> 1. Judging that the state when the suction pressure reaches 0kg/cm²G (0MPa) during compressor operation indicates high pressure by the discharge temperature and low pressure saturation temperature, the back-up control by gas bypassing will be conducted.</p>	<ul style="list-style-type: none"> • Operation while neglecting to open ball valve. Especially for the ball valve at low pressure side. At cooling : Gas side ball valve At heating : Liquid side ball valve • When plural systems are existing, the low pressure abruptly drop at indoor stopping by the erroneous wiring of transmission line (different connection of transmission line and refrigerant piping). • Temporary vacuum condition due to refrigerant distribution unbalance (insufficient refrigerant of low pressure line) immediately after charging refrigerant. 	<p>Once vacuum operation protection is commenced, do not attempt to restart until taking the measures below.</p> <p><Checking method></p> <ul style="list-style-type: none"> • Check ball valve for neglecting to open. • Check extended piping for clogging when ball valve is opened. • Check transmission line for erroneous wiring. (Confirm the correct wiring and piping connection between indoor and outdoor units by operating indoor unit one by one.) <p><Countermeasure></p> <ul style="list-style-type: none"> • After checking with the above method, make error reset by power source reset. • Then operate for 10~15-minutes under the operation mode reverse to that when the vacuum operation protection occurred (Heating if error occurred in cooling, while cooling if it occurred in heating), and then enter into the ordinary operation state.
2500	<p>Leakage (water) abnormality</p> <p>When drain sensor detects flooding during drain pump OFF.</p>	<p>1) Water leak due to humidifier or the like in trouble.</p>	<p>Check water leaking of humidifier and clogging of drain pan.</p>
2502	<p>Drain pump abnormality</p> <p>When indirect heater of drain sensor is turned on, rise in temperature is 20 deg. or less (in water) for 40 seconds, compared with the temperature detected before turning on the indirect heater.</p>	<p>1) Drain sensor sinks in water because drain water level rises due to drain water lifting-up mechanism trouble.</p>	<p>Check operations of drain pump.</p>
		<p>2) Broken wire of indirect heater of drain sensor.</p>	<p>Measure resistance of indirect heater of drain sensor. (Normal: Approx. 82Ω between 1-3 of CN50)</p>
		<p>3) Detecting circuit (circuit board) trouble.</p>	<p>Indoor board trouble if no other problems is detected.</p>
2503	<p>Drain sensor abnormality</p> <p>Short/open is detected during drain pump operations. (Not detected when drain pump is not operating.) Short : 90°C or more detected Open : -40°C or less detected</p>	<p>1) Thermistor trouble. 2) Poor contact of connector. (insufficient insertion) 3) Full-broken of half-broken thermistor wire.</p>	<p>Check resistance of thermistor. 0°C : 15kΩ 10°C : 9.7kΩ 20°C : 6.4kΩ 30°C : 4.3kΩ</p>
		<p>4) Indoor unit circuit board (detecting circuit) trouble.</p>	<p>Check contact of connector. Indoor port trouble if no other problem is detected.</p>
	<p>Operation of float switch</p> <p>When float switch operates (point of contact : OFF), error stop is observed with code No. "2503" displayed.</p>	<p>1) Drain up input trouble. 2) Poor contact of float switch circuit. 3) Float switch trouble.</p>	<p>Check drain pump operations. Check connect contact. Check float switch operations.</p>

Checking code		Meaning, detecting method	Cause	Checking method & Countermeasure
4103	Reverse phase abnormality	Reverse phase (or open phase) in the power system is being detected, so operation cannot be started.	1) The phases of the power supply (L1, L2, L3) have been reversed.	If there is reverse phase before the breaker, after the breaker or at the power supply terminal blocks TB1A, reconnect the wiring.
			2) Open phase has occurred in the power supply (L1, L2, L3, N).	Check before the breaker, after the breaker or at the power supply terminal blocks TB1A, and if there is an open phase, correct the connections. a) Check if a wire is disconnected. b) Check the voltage between each of the wires.
			3) The wiring is faulty.	Check 1 the connections, 2, the contact at the connector, 3, the tightening torque at screw tightening locations and 4 for wiring disconnections. TB1A~NF~TB1B~CNTR1~F3~T01~CNTR Refer to the circuit number and the wiring diagram plate.
			4) The fuse is faulty.	If F1 on the MAIN board, or F3 is melted, (Resistance between both ends of the fuse is ∞), replace the fuses.
			5) T01 is faulty.	To judge failure of the T01, go to "Individual Parts Failure Judgment Methods."
			6) The circuit board is faulty.	If none of the items in 1) to 5) is applicable, and if the trouble reappears even after the power is switched on again, replace the MAIN board (when replacing the circuit board, be sure to connect all the connectors, etc. securely).
4115	Power supply sync signal abnormality	The frequency cannot be determined when the power is switched on. (The power supply's frequency cannot be detected. The outdoor fan cannot be controlled by phase control.)	1) There is an open phase in the power supply (L1, L2, L3, N).	Check before the breaker, after the breaker or at the power supply terminal blocks TB1A, and if there is an open phase, correct the connections.
			2) The power supply voltage is distorted.	If the power supply voltage waveform is distorted from a sine wave, improve the power supply environment.
			3) A fuse is defective.	If F1 on the MAIN board, or F3 is melted, (Resistance between both ends of the fuse is ∞), replace the fuses.
			4) T01 is defective.	To judge failure of the T01, go to "Individual Parts Failure Judgment Methods."
			5) The circuit board is defective.	If none of the items in 1) to 4) is applicable, and if the trouble reappears even after the power is switched on again, replace the MAIN board (when replacing the circuit board, be sure to connect all the connectors, ground wires, etc. securely).

Checking code		Meaning, detecting method	Cause	Checking method & Countermeasure
4116	Fan speed abnormality (motor abnormality)	(Detects only for PKFY-VAM) 1. Detecting fan speed below 180rpm or over 2000rpm during fan operation at indoor unit (first detection) enters into the 3-minute restart prevention mode to stop fan for 30 seconds. 2. When detecting fan speed below 180rpm or over 2000rpm again at fan returning after 30 seconds from fan stopping, error stop (fan also stops) will be commenced displaying 4116.	1) Slipping off of fan speed detecting connector (CN33) of indoor controller board.	• Confirm slipping off of connector (CN33) on indoor controller board.
			2) Slipping off of fan output connector (FAN1) of indoor power board.	• Confirm slipping off of connector (FAN1) on indoor power board.
			3) Disconnection of fan speed detecting connector (CN33) of indoor controller board, or that of fan output connector (FAN1) of indoor power board.	• Check wiring for disconnection.
			4) Filter clogging.	• Check filter.
			5) Trouble of indoor fan motor.	• Check indoor fan motor.
			6) Faulty fan speed detecting circuit of indoor controller board, or faulty fan output circuit of indoor power board.	• When above have no trouble. 1) For trouble after operating fan. Replace indoor controller board. If not remedied, replace indoor power board. 2) For trouble without operating fan. Replace indoor power board.
4200	VDC sensor/circuit abnormality	1 If $VDC \leq 304 V$ is detected just before the inverter starts. 2 If $VDC \geq 750 V$ is detected just before starting of and during operation of the inverter.	1) Power supply voltage is abnormal.	• Check if an instantaneous power failure or power failure, etc. has occurred. • Check if the voltage is the rated voltage value.
			2) The wiring is defective.	Check 1, the connections, 2, contact at the connectors, 3 tightening torque at screw tightened portions, 4, wiring polarities, 5, for broken wires, and 6, for grounding in the following wiring. TB1A~NF~TB1B, TB1B~DS~[52C, R1, R5]~[C2, C3]~IPM Wiring CNDC1 (G / A) ~ CNVDC (INV) Wiring * Check if the wiring polarities are as shown on the wiring diagram plate.
			3) The rush current prevention resistors (R1, 5) are defective.	To judge failure of R1 and R5, go to "Individual Parts Failure Judgment Methods."
			4) The electromagnetic contactor (52C) is defective.	To judge failure of the 52C, go to "Individual Parts Failure Judgment Methods."
			5) The diode stack (DS) is defective.	To judge failure of the DS, go to "Individual Parts Failure Judgment Methods."
			6) The reactor (DCL) is defective.	To judge failure of the DCL, go to "Individual Parts Failure Judgment Methods."
			7) The INV board is defective.	If none of the items in 1) to 6) is applicable, and if the trouble reappears even after the power is switched on again, replace the INV board (when replacing the circuit board, be sure to connect all the connectors, ground wires, etc. securely).

Checking code	Meaning, detecting method	Cause	Checking method & Countermeasure	
4220	Bus voltage abnormality	① If $VDC \leq 400$ V is detected during inverter operation.	1) The power supply voltage is abnormal.	<ul style="list-style-type: none"> Check if an instantaneous stop or power failure, etc. has occurred. Check if the voltage is the rated voltage value.
			2) The wiring is defective.	Check 1, the connections, 2, contact at the connectors, 3 tightening torque at screw tightened portions, 4, wiring polarities, 5, for broken wires, and 6, for grounding in the following wiring. TB1A~NF~TB1B, TB1B~DS~[52C, R1, R5]~[C2, C3]~IPM Wiring CNDC1 (G / A) ~ CNVDC (INV) Wiring * Check if the wiring polarities are as shown on the wiring diagram plate.
			3) The rush current prevention resistors (R1, 5) are defective.	To judge failure of R1 and R5, go to "Individual Parts Failure Judgment Methods."
			4) The electromagnetic contactor (52C) is defective.	To judge failure of the 52 C, go to "Individual Parts Failure Judgment Methods."
			5) The diode stack (DS) is defective.	To judge failure of the DS, go to "Individual Parts Failure Judgment Methods."
			6) The reactor (DCL) is defective.	To judge failure of the DCL, go to "Individual Parts Failure Judgment Methods."
			7) The inverter output is grounded.	<ul style="list-style-type: none"> Check the wiring between the IPM and the compressor. Check the compressor's insulation resistance.
			8) The IPM is defective.	Check the IPM. Judge that the IPM is faulty, (Go to "Individual Parts Failure Judgment Methods.")
			9) The circuit board is defective.	If none of the items in 1) to 8) is applicable, and if the trouble reappears even after the power is switched on again, replace the circuit board by following procedure (when replacing the circuit board, be sure to connect all the connectors, ground wires, etc. security) ① If the problem is solved after the G/A board only is replaced, then the G/A board is defective. ② If the problem is not solved, reinstall the G/A board and replace the INV board. If the problem is solved, the INV board is defective. ③ If the problem is not solved by ① and ② above, replace both boards.
4230	Radiator panel overheat protection	If the cooling fan stays ON for 5 minutes or longer during inverter operation, and if $THHS \geq 100^{\circ}\text{C}$ is detected.	1) The wiring is defective.	Check 1 connections, 2 contact at the connectors and 3 for broken wires in the following wiring. MF1~CNFAN
			2) The INV board's fuse (F01) is defective.	If the fuse is defective, replace the fuse.
			3) The cooling fan (MF1) is defective.	To judge failure of the MF1, go to "Individual Parts Failure Judgment Methods."
			4) The THHS sensor is defective.	To judge failure of the THHS, go to error code "5110".
			5) The air passage is clogged.	If the air passage of the heat sink is clogged, clear the air passage.
			6) The IPM is defective.	Check the IPM. Judge that the IPM is faulty, (Go to "Individual Parts Failure Judgment Methods.")
			7) The circuit board is defective.	If none of the items in 1) to 6) is applicable, and if the trouble reappears even after the power is switched on again, replace the circuit board by following procedure (when replacing the circuit board, be sure to connect all the connectors, ground wires, etc. security) ① If the problem is solved after the G/A board only is replaced, then the G/A board is defective. ② If the problem is not solved, reinstall the G/A board and replace the INV board. If the problem is solved, the INV board is defective. ③ If the problem is not solved by ① and ② above, replace both boards.

Checking code		Meaning, detecting method	Cause	Checking method & Countermeasure
4240	Over load protection	If IAC \geq 32 Arms is detected continuously for 10 minutes during operation of the inverter after 5 or more seconds have passed since the inverter started.	1) Air passage short cycle.	Is the unit's exhaust short cycling?
			2) The heat exchanger is clogged.	Clean the heat exchanger.
			3) Power supply voltage.	If the power supply voltage is less than 342 V, it is outside specifications.
			4) External air temperature.	If the external air temperature is over 43°C it is outside the specifications.
			5) Capacity setting error.	<ul style="list-style-type: none"> Is the indoor unit capacity total correct? Are the outdoor/indoor unit capacity settings correct?
			6) The solenoid valves (SV1, 2) are defective, or the solenoid valve drive circuit is defective.	To judge failure of the solenoid valve, go to "Individual Parts Failure Judgment Methods" for the "Solenoid Valve."
			7) The wiring is defective.	Check 1 connections, 2 contact at the connectors and 3 for broken wires in the following wiring. TB1A~NF~TB1B TB1B~FANCON board~CN04 CNMF~MF TB1B~CNTR1 CNFC1~CNFC2
			8) Fan motor (MF) operation is defective.	Go to "Treating Fan Motor Related Trouble."
			9) The inverter/compressor is defective.	Go to "Treating Inverter/Compressor Related Trouble."
4250	IPM alarm output / Bus voltage abnormality	<p>① If over current, overheat or undervoltage of drive circuit is detected by IPM during inverter operation. [Inverter error detail : 1]</p> <p>② If VDC \leq 300 or VDC \geq 760V is detected during inverter operation. [Inverter error detail : 1]</p> <p>③ If IAC \geq 39Arms is detected during inverter operation. [Inverter error detail : 11]</p>	1) The power supply voltage is abnormal.	<ul style="list-style-type: none"> Check if an instantaneous stop or power failure, etc. has occurred. Check if the voltage is the rated voltage value.
			2) The wiring is defective.	Check 1, the connections, 2, contact at the connectors, 3 tightening torque at screw tightened portions, 4, wiring polarities, 5, for broken wires, and 6, for grounding in the following wiring. TB1A~NF~TB1B, TB1A~DS~[52C, R1, R5]~[C2, C3]~IPM Wiring CNDC1 (G / A) ~ CNVDC (INV) Wiring * Check if the wiring polarities are as shown on the wiring diagram plate.
			3) The inverter / compressor is defective.	Go to "Treatment of Inverter/Compressor Related Trouble."

Checking code		Meaning, detecting method	Cause	Checking method & Countermeasure
4260	Cooling fan abnormality	If the heat sink temperature (THHS) $\geq 100^{\circ}\text{C}$ for 20 minutes or longer just before the inverter starts.	1) Same as "4230."	Same as "4230."
5101	Thermal sensor abnormality (Outdoor Unit)	<p><Other than THHS></p> <p>① A short in the thermistor or an open circuit was sensed. The outdoor unit switches to the temporary stop mode with re-starting after 3 minutes, then if the temperature detected by the thermistor just before restarting is in the normal range, re-starting takes place.</p> <p>② If a short or open circuit in the thermistor is detected just before restarting, error code "5101", "5102", "5103", "5104", "5105", "5106", "5108", "5109" or "5112" is displayed.</p> <p>③ In the 3 minute restart mode, the abnormal stop delay LED is displayed.</p> <p>④ The above short or open circuit is not detected for 10 minutes after the compressor starts, or for 3 minutes during defrosting or after recovery following defrosting.</p> <p><THHS></p> <p>If a heat sink (THHS) temperature of $\leq -40^{\circ}\text{C}$ is detected just after the inverter starts or during inverter operation.</p>	1) Thermistor	Check the thermistor's resistance.
5102			2) Lead wires are being pinched.	Check if the lead wires are pinched.
5103			3) Insulation is torn.	Check for tearing of the insulation.
5104			4) A connector pin is missing, or there is faulty contact.	Check if a pin is missing on the connector.
5105			5) A wire is disconnected.	Check if a wire is disconnected.
5106			6) The thermistor input circuit on the MAIN circuit board is faulty. (In the case of the THHS, replace the INV board.)	Check the temperature picked up by the sensor using the LED monitor. If the deviation from the actual temperature is great, replace the MAIN circuit board. (In the case of the THHS, replace the INV board.)
5107			Short Circuit Detection	Open Circuit Detection
5108			TH1 240°C or higher (0.57 k Ω)	15°C or lower (321 k Ω)
5109			TH2 70°C or higher (1.71 k Ω)	-40°C or lower (130 k Ω)
5110			LD1 -	-40°C or lower (130 k Ω)
5111	LD2 -	-40°C or lower (130 k Ω)		
5112	TH5 110°C or higher (0.4 k Ω)	-40°C or lower (130 k Ω)		
	TH6 110°C or higher (0.4 k Ω)	-40°C or lower (130 k Ω)		
	TH7 110°C or higher (1.14 k Ω)	-40°C or lower (130 k Ω)		
	TH8 70°C or higher (1.14 k Ω)	-40°C or lower (130 k Ω)		
	TH9 70°C or higher (1.14 k Ω)	-40°C or lower (130 k Ω)		
	THHS -	-40°C or lower (2.5 M Ω)		
	TH10 240°C or higher (0.57 k Ω)	-15°C or lower (1656 k Ω)		
5111	Thermal sensor abnormality (BC controlled)	<p>1. When short (high temp. inlet) or open (low temperature inlet) of thermistor is detected during operation, error stop will be commenced displaying "5111" or "5112", "5113" or "5114", or "5115" or "5116."</p> <p>2. The above detection is not made during defrosting and 3-minute after changing operation mode.</p>	1) Thermistor trouble.	Check thermistor resistance.
			2) Biting of lead wire.	Check lead wire biting.
			3) Broken cover.	Check broken cover.
			4) Coming off of pin at connector portion, poor contact.	Check coming off of pin at connector.
			5) Broken wire.	Check broken wire.
	6) Faulty thermistor input circuit of control board.	Check sensor sensing temperature. If it deviates from the actual temperature seriously, replace control panel.		
		Short Detected	Open Detected	
		TH11 110°C or more (0.4 k Ω)	-40°C or less (130 k Ω)	
		TH12 110°C or more (0.4 k Ω)	-40°C or less (130 k Ω)	
		TH15 70°C or more (1.14 k Ω)	-40°C or less (130 k Ω)	
		TH16 70°C or more (0.4 k Ω)	-40°C or less (130 k Ω)	
		* TH2, TH9, TH10 : P-YMF-B only		

Checking code		Meaning, detecting method	Cause	Checking method & Countermeasure
5201	Pressure sensor abnormality (outdoor unit)	<p>① When pressure sensor detects 1kg/cm²G (0.098MPa) or less during operation, outdoor unit once stops with 3 minutes restarting mode, and restarts if the detected pressure of pressure sensor exceeds 1kg/cm²G (0.098MPa) immediately before restarting.</p> <p>② If the detected pressure of sensor is less than 1kg/cm²G (0.098MPa) immediately before restarting, error stop is commenced displaying 5201.</p> <p>③ Under 3 minutes restarting mode, LED displays intermittent fault check.</p> <p>④ During 3 minutes after compressor start, defrosting and 3 minutes after defrosting operations, trouble detection is ignored.</p>	<p>1) Pressure sensor trouble.</p> <p>2) Inner pressure drop due to a leakage.</p> <p>3) Broken cover.</p> <p>4) Coming off of pin at connector portion, poor contact.</p> <p>5) Broken wire.</p> <p>6) Faulty thermistor input circuit of MAIN board.</p>	See Troubleshooting of pressure sensor .
5201	Pressure sensor abnormality (BC controller)	High pressure side	<p>1) Pressure sensor trouble.</p> <p>2) Inner pressure drop due to gas leak.</p> <p>3) Broken cover.</p> <p>4) Coming off of pin at connector portion, poor contact.</p> <p>5) Broken wire.</p> <p>6) Faulty pressure sensor input circuit of control board.</p>	See troubleshooting of pressure sensor .
5203		Intermediate		
5301	IAC sensor/circuit abnormality	<p>① If $IAC \geq 3$ Arms is detected just before the inverter starts, or If $IAC \leq 3$ Arms is detected during inverter operation after 5 seconds has passed since the inverter started when the INV board's SW1-1 is OFF. [Inverter error detail : 6]</p> <p>② If the current sensor (ACCT) miss-wiring is detected during inverter operation. [Inverter error detail : 13]</p>	1) Contact is faulty.	Check the contacts of CNACCT on the INV board.
			2) The current sensor (ACCT) is connected with wrong polarity.	Check the ACCT_U, W polarity with below drawing.
			3) The wiring is defective	Check 1. connections. 2. contact at the connectors. 3. for broken wires in the following wiring. CNDR2-CNDR1 CN15V2-CN15V1 IPM-MC1
			4) The Ac current sensor (ACCT) is defective.	To judge failure of ACCT, go to "individual Parts Failure Judgment Methods."
			5) The IPM is defective.	Check the IPM. Judge that the IPM is faulty, (Go to "Individual Parts Failure Judgment Methods.")

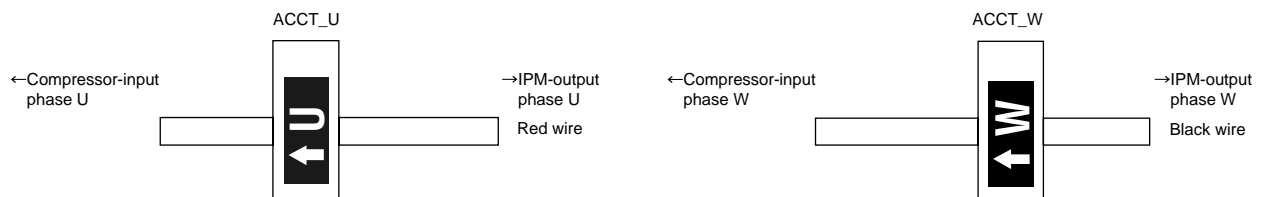

Checking code		Meaning, detecting method	Cause	Checking method & Countermeasure
5301	IAC sensor/ circuit abnormality	<p>① If IAC \geq 3 Arms is detected just before the inverter starts, or If IAC \leq 3 Arms is detected during inverter operation after 5 seconds has passed since the inverter started when the INV board's SW1-1 is OFF. [Inverter error detail : 6]</p> <p>② If the current sensor (ACCT) miss-wiring is detected during inverter operation. [Inverter error detail : 13]</p>	6) The circuit board is defective.	<p>If none of the items in 1) to 5) is applicable, and if the trouble reappears even after the power is switched on again, replace the circuit board by following procedure (when replacing the circuit board, be sure to connect all the connectors, ground wires, etc. securely)</p> <p>① If the problem is solved after the G/A board only is replaced, then the G/A board is defective.</p> <p>② If the problem is not solved, reinstall the INV board and replace the INV board. If the problem is solved, the INV board is defective.</p> <p>③ If the problem is not solved by ① and ② above, replace both boards.</p>
7130	Different indoor model connected abnormality	An exclusive R22 refrigerant indoor unit was connected to a R407C refrigerant outdoor unit.	<p>1) An error was made in the MAIN board of the outdoor unit (replaced with the wrong circuit board).</p> <p>2) An error was made in selecting the indoor unit (installation error).</p> <p>3) An error was made in the indoor unit's circuit board (replaced with the wrong circuit board).</p>	<p>If the model name plate on the outdoor unit says that it is an exclusive R22 model, and if error "7130" has occurred, the MAIN board for the outdoor unit is a R407C model circuit board, so replace it with the MAIN board for the R22 model.</p> <p>If the model name plate for the indoor unit is an exclusive R22 model, install a unit which can also operate with R407C.</p> <p>If the model name plate on the indoor unit indicates that it is also capable of operating with R407C, and error "7130" occurs, the indoor unit's circuit board is for an exclusive R22 model, so replace it with the circuit board for a unit which is also capable of using R407C.</p>

(2) Communication/system

Checking code	Meaning, detecting method	Cause	Checking method & Countermeasure
6600	<p>Multiple address error</p> <p>Transmission from units with the same address is detected.</p> <div data-bbox="293 416 563 573" style="border: 1px solid black; padding: 5px;"> <p>Note: The address/attribute shown on remote controller indicates the controller which has detected error.</p> </div>	<ol style="list-style-type: none"> 1) Two or more controllers of outdoor unit, indoor unit, remote controller, BC controller, etc. have the same address. 2) In the case that signal has changed due to noise entered into the transmission signal. 	<p>At the generation of 6600 error, release the error by remote controller (with stop key) and start again.</p> <p>a) If the error occurs again within 5 minutes. → Search for the unit which has the same address with that of the source of the trouble.</p> <div data-bbox="1015 443 1437 568" style="border: 1px solid black; padding: 5px;"> <p>When the same address is found, turn off the power source of outdoor unit, BC controller, and indoor unit for 5 minutes or more after modifying the address, and then turn on it again.</p> </div> <p>b) When no trouble is generated even continuing operation over 5 minutes. → The transmission wave shape/noise on the transmission line should be investigated in accordance with <Investigation method of transmission wave shape/noise>.</p>
6602	<p>Transmission processor hardware error</p> <p>Though transmission processor intends to transmit "0", "1" is displayed on transmission line.</p> <div data-bbox="293 920 563 1077" style="border: 1px solid black; padding: 5px;"> <p>Note: The address/attribute shown on remote controller indicates the controller which has detected error.</p> </div>	<ol style="list-style-type: none"> 1) At the collision of mutual transmission data generated during the wiring work or polarity change of the transmission line of indoor or outdoor unit while turning the power source on, the wave shape is changed and the error is detected. 2) 100V power source connection to indoor unit or BC controller. 3) Ground fault of transmission line. 4) Insertion of power supply connector (CN40) of plural outdoor units at the grouping of plural refrigerant systems. 5) Insertion of power supply connector (CN40) of plural outdoor units in the connection system with MELANS. 6) Faulty controller of unit in trouble. 7) Change of transmission data due to the noise in transmission. 8) Connection system with plural refrigerant systems or MELANS for which voltage is not applied on the transmission line for central control. 	

Checking code	Meaning, detecting method	Cause	Checking method & Countermeasure
6602	Transmission processor hardware error	<p>Checking method and processing</p>	
6603	<p>Transmission circuit bus-busy error</p> <ol style="list-style-type: none"> 1 Collision of data transmission: Transmission can not be performed for 4~10 consecutive minutes due to collision of data transmission. 2 Data can not be transmitted on transmission line due to noise for 4~10 consecutive minutes. <p>Note: The address/attribute shown on remote controller indicates the controller which has detected error.</p>	<ol style="list-style-type: none"> 1) As the voltage of short frequency like noise is mixed in transmission line continuously, transmission processor can not transmit. 2) Faulty controller of generating unit. 	<ol style="list-style-type: none"> a) Check transmission wave shape/noise on transmission line by following <Investigation method of transmission wave shape/noise>. <ul style="list-style-type: none"> → No noise indicates faulty controller of generating unit. → Noise if existed, check the noise.

Checking code	Meaning, detecting method	Cause	Checking method & Countermeasure
6606	<p>Communications with transmission processor error</p> <p>Communication trouble between apparatus processor and transmission processor.</p> <div data-bbox="290 405 563 548" style="border: 1px solid black; padding: 5px;"> <p>Note: The address/attribute shown on remote controller indicates the controller which has detected error.</p> </div>	<p>1) Data is not properly transmitted due to casual erroneous operation of the generating controller.</p> <p>2) Faulty generating controller.</p>	<p>Turn off power sources of indoor unit, BC controller and outdoor unit.</p> <p>(When power sources are turned off separately, microcomputer is not reset and normal operations can not be restored.)</p> <p>→ Controller trouble is the source of the trouble when the same trouble is observed again.</p>

Checking code	Meaning, detecting method				
6607	No ACK error		When no ACK signal is detected in 6 continuous times with 30 second interval by transmission side controller, the transmission side detects error. <div style="border: 1px solid black; padding: 5px; margin-top: 10px;"> Note: The address/attribute shown on remote controller indicates the controller not providing the answer (ACK). </div>		
System composition	Generating unit address	Display of trouble	Detecting method	Cause	Checking method & countermeasure
(1) Single refrigerant system	① Outdoor unit (OC)	Remote controller (RC)	No reply (ACK) at BC transmission to OC	1) Poor contact of transmission line of OC or BC. 2) Damping of transmission line voltage/signal by acceptable range of transmission wiring exceeded. <div style="border: 1px solid black; padding: 2px; margin: 5px 0;"> Farthest : Less than 200m Remote controller wiring : Less than 10m </div> 3) Erroneous sizing of transmission line (Not within the range below). Wire diameter : 1.25mm ² or more 4) Faulty control circuit board of OC.	Shut down OC unit power source, and make it again. It will return to normal state at an accidental case. When normal state can not be re-covered, check for the 1) ~ 4) of the cause.
	② BC controller (BC)	Remote controller (RC)	No reply (ACK) at IC transmission to BC	1) When Fresh Master address is changed or modified during operation. 2) Faulty or slipping off of transmission wiring of BC controller. 3) Slipping off of BC unit connector (CN02). 4) Faulty BC controller circuit board.	Shut down both OC and BC power sources simultaneously for 5 minutes or more, and make them again. It will return to normal state at an accidental case. When normal state can not be re-covered, check for the 1) ~ 4) of the cause.
	③ Indoor unit (IC)	Remote controller (RC)	No reply (ACK) at RC transmission to IC	1) When IC unit address is changed or modified during operation. 2) Faulty or slipping off of transmission wiring of IC. 3) Slipping off of IC unit connector (CN2M). 4) Faulty IC unit controller. 5) Faulty remote controller.	Shut down both OC and BC power sources simultaneously for 5 minutes or more, and make them again. It will return to normal state at an accidental case. When normal state can not be re-covered, check for the 1) ~ 4) of the cause.
	④ Remote controller (RC)	Remote controller (RC)	No reply (ACK) at IC transmission to RC	1) Faulty transmission wiring at IC unit side. 2) Faulty transmission wiring of RC. 3) When remote controller address is changed or modified during operation. 4) Faulty remote controller.	Shut down OC power sources for 5 minutes or more, and make it again. It will return to normal state at an accidental case. When normal state can not be re-covered, check for the 1) ~ 4) of the cause.

Checking code	Meaning, detecting method				
6607 (continued)	No ACK error		When no ACK signal is detected in 6 continuous times with 30 second interval by transmission side controller, the transmission side detects error.		
<div style="border: 1px solid black; padding: 5px; width: fit-content; margin: 0 auto;"> Note: The address/attribute shown on remote controller indicates the controller not providing the answer (ACK). </div>					
System composition	Generating unit address	Display of trouble	Detecting method	Cause	Checking method & countermeasure
(2) Group operation system using plural refrigerants	① Outdoor unit (OC)	Remote controller (RC)	No reply (ACK) at BC transmission to OC	As same that for single refrigerant system.	Same as measure for single refrigerant system.
	② BC controller (BC)	Remote controller (RC)	No replay (ACK) at IC transmission to BC	As same that for single refrigerant system.	Same as measure for single refrigerant system.
	③ Indoor unit (IC)	Remote controller (RC)	No reply (ACK) at RC transmission to IC	1) Cause of 1) ~ 5) of "Cause for single refrigerant system". 2) Slipping off or short circuit of transmission line of OC terminal block for centralized control (TB7). 3) Shut down of OC unit power source of one re-frigerant system. 4) Neglecting insertion of OC unit power supply connector (CN40). 5) Inserting more than 2 sets of power supply connector (CN40) for centralized control use. For generation after normal operation conducted once, the following causes can be considered. <ul style="list-style-type: none"> • Total capacity error (7100) • Capacity code setting error (7101) • Connecting set number error (7102) • Address setting error (7105) 	a) Shut down the power source of both IC and OC for over 5 minutes simultaneously, and make them again. Normal state will be returned incase of accidental trouble. b) Check for 1) ~ 5) of causes. If cause is found, remedy it. c) Check other remote controller or OC unit LED for troubleshooting for trouble. Trouble → Modify the trouble according to the content of check code. No trouble → Faulty indoor controller
	④ Remote controller (RC)	Remote controller (RC)	No reply (ACK) at IC transmission to RC	1) Cause of 1) ~ 3) of "Cause for single refrigerant system". 2) Slipping off or short circuit of transmission line of OC terminal block for centralized control (TB7). 3) Shut down of OC unit power source of one refrigerant system. 4) Neglecting insertion of OC unit power supply connector (CN40). 5) Inserting more than 2 sets of power supply connector (CN40) for centralized control use. At generation after normal operation conducted once, the following causes can be considered. <ul style="list-style-type: none"> • Total capacity error (7100) • Capacity code setting error (7101) • Connecting set number error (7102) • Address setting error (7105) 	a) Shut down the power source of OC for over 5 minute, and make it again. Normal state will be returned in case of accidental trouble. b) Check for 1) ~ 5) of causes. If cause is found, remedy it. When normal state can not be obtained, check 1) ~ 5) of causes.

Checking code	Meaning, detecting method				
6607 (continued)	No ACK error		When no ACK signal is detected in 6 continuous times with 30 second interval by transmission side controller, the transmission side detects error.		
<div style="border: 1px solid black; padding: 5px; width: fit-content; margin: auto;"> Note: The address/attribute shown on remote controller indicates the controller not providing the answer (ACK). </div>					
System composition	Generating unit address	Display of trouble	Detecting method	Cause	Checking method & countermeasure
(3) Connecting system with system controller (MELANS)	① Outdoor unit (OC)	Remote controller (RC)	No reply (ACK) at BC transmission to OC	As same that for single refrigerant system.	Same countermeasure as that for single refrigerant system.
	② BC controller (BC)	Remote controller (RC)	No reply (ACK) at RC transmission to IC	Same cause of that for grouping from plural refrigerants.	Same countermeasure as that for IC unit error in plural refrigerant system.
	③ Indoor unit (IC)	Remote controller (RC)	No reply (ACK) at transmission of SC to IC	Trouble of partial IC units: 1) Same cause as that for single refrigerant system.	→ Same countermeasure as that for single refrigerant system.
				Trouble of all IC in one refrigerant system: 1) Cause of total capacity error. (7100) 2) Cause of capacity code setting error. (7101) 3) Cause of connecting number error. (7102) 4) Cause of address setting error. (7105) 5) Slipping off or short circuit of transmission line of OC unit terminal block for central control (TB7). 6) Power source shut down of OC unit. 7) Trouble of OC unit electrical system.	Confirm OC trouble diagnosis LED. → At trouble generation, check for the content according to check code. Check the content of 5)~7) shown left.
				Trouble of all IC: 1) As same that for single refrigerant system. 2) Insertion of power supply connector (CN40) into OC unit transmission line for centralized control. 3) Slipping off or power source shut down of power supply unit for transmission line. 4) Faulty system controller (MELANS).	Confirm voltage of transmission line for centralized control. • More than 20V → Confirm 1) 2) left. • Less than 20V → Confirm 3) left.
	④ Remote controller (RC)	Remote controller (RC)	No reply (ACK) at transmission of IC to RC	Same cause as that for plural refrigerant system.	Same countermeasure as that for plural refrigerant system.
				Trouble of partial IC units: 1) Same cause of that for single refrigerant system.	→ Same countermeasure as that for single refrigerant system.
				Trouble of all IC in one refrigerant system: 1) Error detected by OC unit. Total capacity error. (7100) Capacity code setting error. (7101) Connecting number error. (7102) Address setting error. (7105) 2) Slipping off or short circuit of transmission line of OC unit terminal block for central control (TB7). 3) Power source shut down of OC unit. 4) Trouble of OC unit electrical system.	Confirm OC trouble diagnosis LED. → At trouble generation, check for the content according to check code. Check the content of 2)~4) shown left.
				Trouble of all IC: 1) As same that for single refrigerant system. 2) Insertion of power supply connector (CN40) into OC unit transmission line for centralized control. 3) Slipping off or power shutdown of power supply unit for transmission line. 4) Faulty MELANS.	Check the causes of 1) ~ 4) left.

Checking code	Meaning, detecting method				
6607 (continued)	No ACK error		When no ACK signal is detected in 6 continuous times with 30 second interval by transmission side controller, the transmission side detects error. <div style="border: 1px solid black; padding: 5px; margin-top: 10px;">Note: The address/attribute shown on remote controller indicates the controller not providing the answer (ACK).</div>		
System composition	Generating unit address	Display of trouble	Detecting method	Cause	Checking method & countermeasure
(3) Connecting system with system controller (MELANS)	⑤ System controller (SC)	Remote controller (RC)	No reply (ACK) at transmission of IC to SC	Trouble of partial remote controller: 1) Faulty wiring of RC transmission line. 2) Slipping off or poor contact of RC transmission connector. 3) Faulty RC.	Check 1) ~ 3) left.
				Trouble of all IC in one refrigerant system. 1) Error detected by OC unit. Total capacity error (7100) Capacity code setting error (7101) Connecting number error (7102) Address setting error (7105) 2) Slipping off or short circuit of transmission line of OC unit terminal block for central control (TB7). 3) Power source shut down of OC unit. 4) Trouble of OC unit electrical system.	Confirm OC trouble diagnosis LED. → At trouble generation, check for the content according to check code. Check the content of 2) ~ 4) shown left.
				Trouble of all RC: 1) As same that for single refrigerant system. 2) Inserting supply power connector (CN40) to OC transmission line for centralized control. 3) Slipping off or power shutdown of power supply unit for transmission line. 4) Faulty MELANS.	Check the causes 1)~4) left.
No relation with system	Address which should not be existed	-	-	1) IC unit is keeping the memory of the original group setting with RC although the RC address was changed later. The same symptom will appear for the registration with SC. 2) IC unit is keeping the memory of the original interlocking registration with Fresh Master with RC although the Fresh Master address was changed later.	As some IC units are keeping the memory of the address not existing, delete the information. Employ one of the deleting method among two below. 1) Deletion by remote controller. Delete unnecessary information by the manual setting function of remote controller. 2) Deletion by connecting information deleting switch of OC unit. <div style="border: 1px solid black; padding: 5px; margin-top: 10px;"> Be careful that the use of this method will delete all the group information set with RC and all the interlocking information of Fresh Master and IC unit. </div> ① Shut down OC unit power source, and wait for 5 minutes. ② Turn on the dip switch SW2-2 provided on OC unit control circuit board. ③ Make OC unit power source, and wait for 5 minutes. ④ Shut down OC unit power source, and wait for 5 minutes. ⑤ Turn off the dip switch SW2-2 provided on OC unit control circuit board. ⑥ Make OC unit power source.

Checking code	Meaning, detecting method	Cause	Checking method & Countermeasure
6608	<p>No response error</p> <p>Though acknowledgement of receipt (ACK) is received after transmission, no response command is returned. Detected as error by transmission side when the same symptom is re-peated 10 times with an interval of 3 seconds.</p> <div style="border: 1px solid black; padding: 5px; width: fit-content;"> <p>Note: The address/attribute shown on remote controller indicates the controller which has detected error.</p> </div>	<ol style="list-style-type: none"> 1) At the collision of mutual transmission data when transmission wiring is modified or the polarity is changed while turning the power source on, the wave shape changes detecting error. 2) Repeating of transmission error due to noise. 3) Damping of transmission line voltage/signal due to exceeding of the acceptable range for transmission wiring. <ul style="list-style-type: none"> • Farthest Less than 200m • RC wiring Less than 12m 4) Damping of transmission voltage/signal due to improper type of transmission line. <ul style="list-style-type: none"> • Wire size : More than 1.25mm² 	<ol style="list-style-type: none"> a) Generation at test run. Turn off the power sources of OC unit, IC unit and Fresh Master for more than 5 minutes simultaneously, and make them again. → Returning to normal state means the trouble detection due to transmission line work while powering. b) Check 3) and 4) of the causes left. c) Investigate the transmission wave shape/noise on transmission line according to <Investigation method of transmission wave shape/noise>. <div style="border: 1px solid black; border-radius: 10px; padding: 5px; width: fit-content; margin: 10px auto;"> <p>Much possibility if 6602 is generated.</p> </div>

(3) System error

Checking code	Meaning, detecting method	Cause	Checking method & Countermeasure															
7100	<p>Total capacity error</p> <p>Total capacity of indoor units in the same refrigerant system exceeds limitations.</p> <div style="border: 1px solid black; padding: 5px; width: fit-content;"> <p>Trouble source: Outdoor unit</p> </div>	<ol style="list-style-type: none"> 1) Total capacity of indoor units in the same refrigerant system exceeds the following: <table border="1" style="margin: 10px auto; border-collapse: collapse;"> <thead> <tr> <th>Model</th> <th>Total capacity</th> <th>Total capacity code</th> </tr> </thead> <tbody> <tr> <td>PURY-(P)200</td> <td>302</td> <td>62</td> </tr> <tr> <td>PURY-(P)250</td> <td>378</td> <td>78</td> </tr> <tr> <td>PU(H)Y-(P)200</td> <td>260</td> <td>52</td> </tr> <tr> <td>PU(H)Y-(P)250</td> <td>325</td> <td>65</td> </tr> </tbody> </table> 2) Erroneous setting of OC model selector switch (SW3-10). <div style="text-align: center; margin: 10px auto;"> <p>ON ...250 OFF ...200 SW3</p> </div> 	Model	Total capacity	Total capacity code	PURY-(P)200	302	62	PURY-(P)250	378	78	PU(H)Y-(P)200	260	52	PU(H)Y-(P)250	325	65	<ol style="list-style-type: none"> a) Check for the model total (capacity cord total) of indoor units connected. b) Check whether indoor unit capacity code (SW2) is wrongly set. <p>For erroneous switch setting, modify it, turn off power source of outdoor unit, and indoor unit simultaneously for 5 minutes or more to modify the switch for setting the model name (capacity code).</p> <p>Check for the model selector switch (Dip switches SW3-10 on outdoor unit control circuit) of OC.</p>
Model	Total capacity	Total capacity code																
PURY-(P)200	302	62																
PURY-(P)250	378	78																
PU(H)Y-(P)200	260	52																
PU(H)Y-(P)250	325	65																
7101	<p>Capacity code error</p> <p>Error display at erroneous connection of Indoor unit of which model name can not be connected.</p> <div style="border: 1px solid black; padding: 5px; width: fit-content;"> <p>Trouble source : Outdoor unit Indoor unit</p> </div>	<ol style="list-style-type: none"> 1) The Indoor unit model name (model code) connected is not connectable. Connectable range.....20~250 2) Erroneous setting of the switch (SW2) for setting of model name of Indoor unit connected. 	<ol style="list-style-type: none"> a) Check for the model name of the Indoor unit connected. b) Check for the switch (SW2 if indoor controller for setting of Indoor unit model name of generating address. When it is not agreed to the model name, modify the capacity code while shutting off the power source of Indoor unit. <p>* The capacity of Indoor unit can be confirmed by the self-diagnosis function (SW1 operation) of Indoor unit.</p>															
7102	<p>Connected unit count over</p> <p>Number of units connected in the same refrigerant system exceeds limitations.</p> <div style="border: 1px solid black; padding: 5px; width: fit-content;"> <p>Trouble source: Outdoor unit</p> </div>	<ol style="list-style-type: none"> 1) Number of unit connected to terminal block (TB3) for outdoor/indoor transmission line exceeds limitations given be-lows: <table border="1" style="margin: 10px auto; border-collapse: collapse;"> <thead> <tr> <th>Item</th> <th>Limitation</th> </tr> </thead> <tbody> <tr> <td>① Total of Indoor unit</td> <td>1~13 (PUHY-200) 1~16 (PUHY-250) 1~15 (PURY-200) 1~16 (PURY-250)</td> </tr> <tr> <td>② Total of Indoor unit & RC</td> <td>1~35</td> </tr> <tr> <td>③ Total of BC controller</td> <td>1</td> </tr> </tbody> </table> 	Item	Limitation	① Total of Indoor unit	1~13 (PUHY-200) 1~16 (PUHY-250) 1~15 (PURY-200) 1~16 (PURY-250)	② Total of Indoor unit & RC	1~35	③ Total of BC controller	1	<ol style="list-style-type: none"> a) Check whether the connection of units to the terminal block for indoor/outdoor transmission wiring (TB3) of outdoor unit is not exceeding the limitation. (See ① ~ ② left.) b) Check for 2), 3), and 4). c) Check for the connection of transmission wiring to the terminal block for centralized control is erroneously connected to the indoor/outdoor transmission wiring terminal block (TB3). 							
Item	Limitation																	
① Total of Indoor unit	1~13 (PUHY-200) 1~16 (PUHY-250) 1~15 (PURY-200) 1~16 (PURY-250)																	
② Total of Indoor unit & RC	1~35																	
③ Total of BC controller	1																	

Checking code	Meaning, detecting method	Cause	Checking method & Countermeasure
7102	Connected unit count over	2) The Outdoor unit address is being set to 51~100 under automatic address mode (Remote controller displays "HO"). 3) Slipping off of transmission wiring at Outdoor unit. 4) Short circuit of transmission line in case of 3) & 4), remote controller displays "HO".	a) Check for the model total (capacity code total) of indoor units connected.
7105	Address setting error <ul style="list-style-type: none"> • Erroneous setting of OC unit address • Erroneous setting of BC controller address <div style="border: 1px solid black; padding: 2px; width: fit-content;">Trouble source : Outdoor unit BC controller</div>	1) Setting error of Outdoor unit address. The address of Outdoor unit is not being set to 51~100. 2) The address of BC controller is not being set within 51~100.	Check that the address of OC unit is being set to 51~100. Reset the address if it stays out of the range, while shutting the power source off. When BC controller is out of the range, reset it while shutting the power source of both OC unit and BC controller off.
7107	Connection No. setting error Can not operate because connection No. of indoor unit wrongly set. <div style="border: 1px solid black; padding: 2px; width: fit-content;">Trouble source : BC controller</div>	1) Indoor unit capacity per connector joint is exceeded as follows: Single connection : 81 or more Two connection joint : 161 or more Three connection joint : 241 or more Four connection joint : 321 or more 2) Four or more indoor units are set for the same connection. 3) The smallest connection No. has not been set when used at joint.	a) Check indoor unit connection No. in refrigerant circuit. ① No four or more indoor units which are set for the same connection No. A? ② Check total capacity of indoor units which are set for the same connections No. Judged as trouble when it applies to Cause 1). ③ Check whether the smallest connection No. is set when used at joint. b) Check whether indoor unit capacity code (SW2) is wrongly set. (Keep factory shipment condition.) For erroneous switch setting, modify it, turn off the power source of outdoor unit, and indoor unit simultaneously for 5 minutes or more, and then turn on.
7111	Remote control sensor error Error not providing the temperature designed to remote controller sensor. <div style="border: 1px solid black; padding: 2px; width: fit-content;">Trouble source : Indoor unit</div>	1) In case when the old type remote controller for M-NET is used and the remote controller sensor is designed on indoor unit. (SW1-1 turned ON)	a) Replace the old remote controller by the new remote controller.
7130	Different Indoor model and BC controller connected error	A indoor unit not for the R407C (model: P•••) is connected.	Use the P••• indoor unit.

[4] LED Monitor Display

(1) How to read LED for service monitor

By setting of DIP SW1-1 ~ 1-8, the unit operating condition can be observed with the service LED on the control circuit board. (For the relation of each DIP SW to the content, see the table provided.)

As shown in the figure below, the LED consist of 7 segments is put in 4 sets side by side for numerical and graphic display.

OC	: Outdoor unit	SV	: Solenoid valve	THHS	: Inverter radiator panel
IC	: Indoor unit	LEV	: Electronic expansion valve		
		COMP	: Compressor		
SW1	: Outdoor unit control circuit board				
E	: Memory storage for service activities (sampling per minute)				

7 seg LED

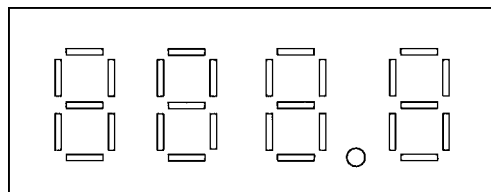

The numerical display includes that of pressure, temperature or the like, while the graphic display includes that of operating condition, solenoid valve ON/OFF state or the like.

- Numerical display

Example : display at 18.8kg/cm²G (1.84MPa) of pressure sensor data (Item No. 56)

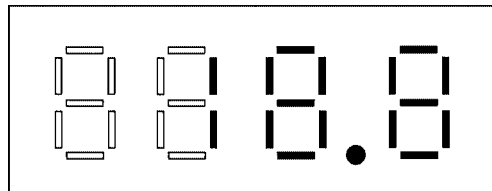

- Graphic display (Two LEDs aligned vertically express a flag.)

Example : At forcible powering in outdoor unit operation display

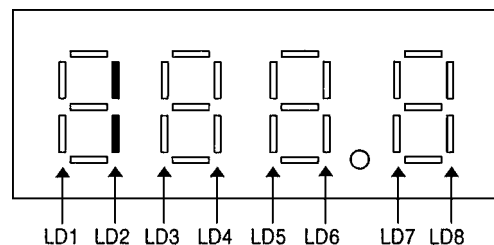

① PU(H)Y-(P)200-250YMF-C

E: E2 Contents stored in the E2PROM; M: Monitored by the IC through communications; E*: Stored in service memory.

No	SW1	Item	Display								Remarks
	12345678910		LD1	LD2	LD3	LD4	LD5	LD6	LD7	LD8	
0	0000000000	Relay Output Display 1 (Lights up to display)	COMP Operating	Crankcase Heater ON	21S4	SV1	SV2	SV3 *note	SV4*	Lights for Normal Operation	LD8 is a relay output indicator which lights up at all times when the microcomputer's power is ON. When sending of a monitoring request to IC/BC is terminated, if there is no error, "----" is displayed. E*
		Check Display 1 OC Error	0 ~ 9999 Address and error code reversed								
1	1000000000	Relay Output Display 2									E*
2	0100000000	Check Display 2 (Including the IC)	0 ~ 9999 Address and error code reversed								If there is no error, "----" is displayed. E*
3	1100000000										
4	0010000000										
5	1010000000										
6	0110000000	External Signal (Signal being input)	demand	Auto changeover mode (cooling)	Auto changeover mode (heating)	night mode.					E*
7	1110000000	Outdoor Unit Operation Display		Warm-up mode	3 minutes, restart protection mode	Compressor operating	Preliminary Error	Error			E*
8	0001000000	Indoor Unit Check	Unit No. 1	Unit No. 2	Unit No. 3	Unit No. 4	Unit No. 5	Unit No. 6	Unit No. 7	Unit No. 8	Lights up if an abnormal stop has occurred in the IC. The indicator for Unit No. 1 goes off when error reset is carried out from the smallest address. M
9	1001000000		Unit No. 9	Unit No. 10	Unit No. 11	Unit No. 12	Unit No. 13	Unit No. 14	Unit No. 15	Unit No. 16	
10	0101000000	Indoor Unit Operation Mode	Unit No. 1	Unit No. 2	Unit No. 3	Unit No. 4	Unit No. 5	Unit No. 6	Unit No. 7	Unit No. 8	Lights up during cooling. Blinks during heating. Goes off during stop and blower operation. M
11	1101000000		Unit No. 9	Unit No. 10	Unit No. 11	Unit No. 12	Unit No. 13	Unit No. 14	Unit No. 15	Unit No. 16	
12	0011000000	Indoor Unit Thermostat ON	Unit No. 1	Unit No. 2	Unit No. 3	Unit No. 4	Unit No. 5	Unit No. 6	Unit No. 7	Unit No. 8	Lights up when thermostat is ON. Goes off when thermostat is OFF. M
13	1011000000		Unit No. 9	Unit No. 10	Unit No. 11	Unit No. 12	Unit No. 13	Unit No. 14	Unit No. 15	Unit No. 16	
14	0111000000										
15	1111000000	Outdoor Unit Operation Mode	Permissible Stop	Standby	Defrost	Cooling		Heating			E*
16	0000100000	Outdoor Unit Control Mode	Cooling Refrigerant Recovery		Heating Refrigerant Recovery		Cooling High Oil Recovery	Cooling Low Oil Recovery	Heating High Oil Recovery	Heating Low Oil Recovery	
17	1000100000	Preliminary Error in Outdoor Unit	High Pressure Error 1, 2	Low Pressure Error 1, 2	Discharge Temperature Error	Overcurrent Protection	Heat Sink Thermostat Operating	Overcurrent Break	INV Error	Over-charged Refrigerant	The flag corresponding to the item where there is an error delay lights up. E*
18	0100100000		Suction pressure Error	Configuration Detection Error	Comp. temperature Error	Reverse Phase, Open Phase Error					
19	1100100000		TH1 Error	TH2 Error	LD1 Error	LD2 Error	TH5 Error	TH6 Error	HPS Error	THHS Error	
20	0010100000		TH7 Error	TH8 Error	TH9 Error*	TH10 Error*	LPS Error*				

*note : only PUHY-P

No	SW1	Item	Display								Remarks
	12345678910		LD1	LD2	LD3	LD4	LD5	LD6	LD7	LD8	
21	1010100000	Outdoor Unit Preliminary Error History	High Pressure Error 1, 2	Low Pressure Error	Outlet Temperature Error	Overcurrent Protection	Heat Sink Thermostat Operation	Overcurrent Break		Over-charged Refrigerant	Lights up if an error delay has occurred between the time the power was turned on and the present time. To turn the indicators off, switch the power OFF briefly. E*
22	0110100000		Suction pressure Error	Configuration Detection Error	Comp. temperature Error	Reverse Phase, Open Phase Error					
23	1110100000		TH1 Error	TH2 Error	LD1 Error	LD2 Error	TH5 Error	TH6 Error	HPS Error	THHS Error	
24	0001100000		TH7 Error	TH8 Error	TH9 Error*	TH10 Error*	LPS Error*				
25	1001100000	Error History 1	0 ~ 9999								The error and error delay code are displayed. If the address and error code are shown in reverse, or there is no error, " - - - " is displayed. E
26	0101100000	Inverter Error Detail	Inverter Error Detail (1 ~ 13)								If there is no error, " - - - " is displayed. E
27	1101100000	Error History 2	0 ~ 9999								E
28	0011100000	Inverter Error Detail	Inverter Error Detail (1 ~ 13)								
29	1011100000	Error History 3	0 ~ 9999								
30	0111100000	Inverter Error Detail	Inverter Error Detail (1 ~ 13)								
31	1111100000	Error History 4	0 ~ 9999								
32	0000100000	Inverter Error Detail	Inverter Error Detail (1 ~ 13)								
33	1000100000	Error History 5	0 ~ 9999								
34	0100100000	Inverter Error Detail	Inverter Error Detail (1 ~ 13)								
35	1100100000	Error History 6	0 ~ 9999								
36	0010010000	Inverter Error Detail	Inverter Error Detail (1 ~ 13)								
37	1010010000	Error History 7	0 ~ 9999								
38	0110010000	Inverter Error Detail	Inverter Error Detail (1 ~ 13)								
39	1110010000	Error History 8	0 ~ 9999								
40	0001010000	Inverter Error Detail	Inverter Error Detail (1 ~ 13)								
41	1001010000	Error History 9	0 ~ 9999								
42	0101010000	Inverter Error Detail	Inverter Error Detail (1 ~ 13)								
43	1101010000	Error History 10	0 ~ 9999								
44	0011010000	Inverter Error Detail	Inverter Error Detail (1 ~ 13)								
45	1011010000	Type of Inverter Preliminary Error (Details of the inverter error in No. 17)	0 ~ 9999								If there is no error, " - - - - " is always overwritten. E*
46	0111010000	TH1 Data	-99.9 ~ 999.9								E* [No. 52 THHS data are monitored by the inverter microcomputer.]
47	1111010000	TH2 Data	↑								
48	0000110000	LD1 Data	0 : OFF 1 : ON 2 : OPEN								
49	1000110000	LD2 Data	0 : OFF 1 : ON 2 : OPEN								
50	0100110000	TH5 Data	-99.9 ~ 999.9								
51	1100110000	TH6 Data	↑								

No	SW1	Item	Display								Remarks
	12345678910		LD1	LD2	LD3	LD4	LD5	LD6	LD7	LD8	
52	0010110000	THHS Data	-99.9 ~ 999.9								E*
53	1010110000	HPS Data	↑								
54	0110110000	TH7 Data	↑								
55	1110110000	TH8 Data	↑								
56	0001110000	TH9 Data*	↑								
57	1001110000	TH10 Data*	↑								
58	0101110000	LPS Data*	↑								
59	1101110000	α 0C	0 ~ 9.999								
60	0011110000	α 0C*	↑								
61	1011110000	Accumulator Level α 0C*	① and ② below are displayed alternately at every 5 seconds. ① Accumulator Level: 0~9 ("AL=" is also displayed), ② α 0C*: 0~9.999								
62	0111110000	HzAK Increase/ Decrease	Δ Hz -	Δ Hz 0	Δ Hz +	-	-	Δ AK -	Δ AK 0	Δ AK +	
63	1111110000	Difference from Target Tc (Tcm-Tc)	Low -3 deg. or lower	Low -3 ~ -2 deg.	Low -2 ~ -1 deg.	Stable Region		High 1~2 deg.	High 2~3 deg.	High 3 deg or higher	
64	0000001000	Difference from Target Te (Tem-Te)	Low -3 deg. or lower	Low -3 ~ -2 deg.	Low -2 ~ -1 deg.	Stable Region		High 1~2 deg.	High 2~3 deg.	High 3 deg or higher	
65	1000001000	Tc	-99.9 ~ 999.9								
66	0100001000	Te	↑								
67	1100001000	Tcm	↑								
68	0010001000	Tem	↑								
69	1010001000	Compressor Frequency	0 ~ 9999								Control Frequency E*
70	0110001000	INV Output Frequency	↑								Frequency actually out- put from the inverter. E*
71	1110001000	AK	↑								E*
72	0001001000	SLEV	↑								
73	1001001000	LEV1	↑								
74	0101001000	FANCON Output Value (Toff%)	↑								
75	1101001000	INV Output current (IAC)	-99.9 ~ 999.9								(M) Monitored by the inverter's microcomputer.
76	0011001000	0C Address	0 ~ 9999								
77	1011001000	IC1 Address/ Capacity Code	0 ~ 99				0 ~ 99				E On the left (LD1~LD4), the IC address, and on the right (LD5~LD8), the capacity code is displayed (displayed alternately every 1 minute).
78	0111001000	IC2 Address/ Capacity Code	↑				↑				
79	1111001000	IC3 Address/ Capacity Code	↑				↑				
80	0000101000	IC4 Address/ Capacity Code	↑				↑				
81	1000101000	IC5 Address/ Capacity Code	↑				↑				
82	0100101000	IC6 Address/ Capacity Code	↑				↑				

When there is an error stop with No95-121, the data on error stops or the data immediately before the error postponement stop, which is stored in service memory, are displayed.

No	SW1	Item	Display								Remarks
	12345678910		LD1	LD2	LD3	LD4	LD5	LD6	LD7	LD8	
83	1100101000	IC7 Address/ Capacity Code	0 ~ 99				0 ~ 99				E On the left (LD1~LD4), the IC address, and on the right (LD5~LD8), the capacity code is displayed (displayed alternately every 1 minute).
84	0010101000	IC8 Address/ Capacity Code	↑				↑				
85	1010101000	IC9 Address/ Capacity Code	↑				↑				
86	0110101000	IC10 Address/ Capacity Code	0 ~ 9999								
87	1110101000	IC11 Address/ Capacity Code									
88	0001101000	IC12 Address/ Capacity Code									
89	1001101000	IC13 Address/ Capacity Code									
90	0101101000	IC14 Address/ Capacity Code									
91	1101101000	IC15 Address/ Capacity Code									
92	0011101000	IC16 Address/ Capacity Code									
93	1011101000	COMP Operation Time, Higher order 4 digits	0 ~ 9999								E*
94	0111101000	Lower order 4 digits	↑								
95	1111101000	Outdoor Unit Operation\Mode	Permissible Stop	Standby	Defrost	Cooling		Heating			E
96	0000011000	Outdoor Unit Control Mode	Cooling Refrigerant Recovery		Heating Refrigerant Recovery		Cooling High Oil Recovery	Cooling Low Oil Recovery	Heating High Oil Recovery	Heating Low Oil Recovery	
97	1000011000	Relay Output Display 1 Lighting Display	COMP Operat- ing	Crankcase Heater ON	21S4	SV1	SV2				
98	0100011000	TH1 Data	-99.9 ~ 999.9								
99	1100011000	TH2 Data	↑								
100	0010011000	LD1 Data	0 : OFF 1 : ON 2 : OPEN								
101	1010011000	LD2 Data	0 : OFF 1 : ON 2 : OPEN								
102	0110011000	TH5 Data	-99.9 ~ 999.9								
103	1110011000	TH6 Data	↑								
104	0001011000	HPS Data	↑								
105	1001011000	THHS Data	↑								
106	010101100	TH7 Data	↑								
107	1101011000	TH8 Data	↑								
108	0011011000	TH9 Data*	↑								
109	1011011000	TH10 Data*	↑								
110	0111011000	LPS Data*	↑								
111	1111011000	α 0C*	0 ~ 9.999								

When there is an error stop with No95-121, the data on error stops or the data immediately before the error postponement stop, which is stored in service memory, are displayed.

No	SW1	Item	Display								Remarks
	12345678910		LD1	LD2	LD3	LD4	LD5	LD6	LD7	LD8	
112	0000111000	α 0C* \star	0 ~ 9.999								E
113	1000111000	Tc	-99.9 ~ 999.9								
114	0100111000	Te	↑								
115	1100111000	Configuration Correction Value	0 ~ 9999								
116	0010111000	INV Output Frequency	↑								
117	1010111000	AK	↑								
118	0110111000	SLEV	↑								
119	1110111000	LEV1	↑								
120	0001111000	DC Trunk Line Current	-99.9 ~ 999.9								
121	1001111000	Outdoor Unit Operation Indicator		Warm-up mode	3-minute Restart Protection mode	Compressor Operating	Preliminary Error	Error			
122	0101111000										
123	1101111000										
124	0011111000										
125	1011111000										
126	0111111000										
127	1111111000	Elapsed Time for CS Circuit Closed Detection	0 ~ 9999								
128	0000000100	IC1 room Temperature	-99.9 ~ 999.9								M
129	1000000100	IC2 room Temperature	↑								
130	0100000100	IC3 room Temperature	↑								
131	1100000100	IC4 room Temperature	↑								
132	0010000100	IC5 room Temperature	↑								
133	1010000100	IC6 room Temperature	↑								
134	0110000100	IC7 room Temperature	↑								
135	1110000100	IC8 room Temperature	↑								
136	0001000100	IC9 room Temperature	↑								
137	1001000100	IC10 room Temperature	↑								
138	0101000100	IC11 room Temperature	↑								
139	1101000100	IC12 room Temperature	↑								

No	SW1	Item	Display								Remarks
	12345678910		LD1	LD2	LD3	LD4	LD5	LD6	LD7	LD8	
140	0011000100	IC13 room Temperature	-99.9 ~ 999.9								M
141	1011000100	IC14 room Temperature	↑								
142	0111000100	IC15 room Temperature	↑								
143	1111000100	IC16 room Temperature	↑								
144	0000100100	IC1 Liquid Pipe Temperature	↑								M
145	1000100100	IC2 Liquid Pipe Temperature	↑								
146	0100100100	IC3 Liquid Pipe Temperature	↑								
147	1100100100	IC4 Liquid Pipe Temperature	↑								
148	0010100100	IC5 Liquid Pipe Temperature	↑								
149	1010100100	IC6 Liquid Pipe Temperature	↑								
150	0110100100	IC7 Liquid Pipe Temperature	↑								
151	1110100100	IC8 Liquid Pipe Temperature	↑								
152	0001100100	IC9 Liquid Pipe Temperature	↑								
153	1001100100	IC10 Liquid Pipe Temperature	↑								
154	0101100100	IC11 Liquid Pipe Temperature	↑								
155	1101100100	IC12 Liquid Pipe Temperature	↑								
156	0011100100	IC13 Liquid Pipe Temperature	↑								
157	1011100100	IC14 Liquid Pipe Temperature	↑								
158	0111100100	IC15 Liquid Pipe Temperature	↑								
159	1111100100	IC16 Liquid Pipe Temperature	↑								
160	0000010100	IC1 Gas Pipe Temperature	↑								
161	1000010100	IC2 Gas Pipe Temperature	↑								
162	0100010100	IC3 Gas Pipe Temperature	↑								
163	1100010100	IC4 Gas Pipe Temperature	↑								
164	0010010100	IC5 Gas Pipe Temperature	↑								
165	1010010100	IC6 Gas Pipe Temperature	↑								

No	SW1	Item	Display								Remarks	
	12345678910		LD1	LD2	LD3	LD4	LD5	LD6	LD7	LD8		
166	0110010100	IC7 Gas Pipe Temperature	-99.9 ~ 999.9								M	
167	1110010100	IC8 Gas Pipe Temperature	↑									
168	0001010100	IC9 Gas Pipe Temperature	↑									
169	1001010100	IC10 Gas Pipe Temperature	↑									
170	0101010100	IC11 Gas Pipe Temperature	↑									
171	1101010100	IC12 Gas Pipe Temperature	↑									
172	0011010100	IC13 Gas Pipe Temperature	↑									
173	1011010100	IC14 Gas Pipe Temperature	↑									
174	0111010100	IC15 Gas Pipe Temperature	↑									
175	1111010100	IC16 Gas Pipe Temperature	↑									
176	0000110100	IC1 SH	↑									M
177	1000110100	IC2 SH	↑									
178	0100110100	IC3 SH	↑									
179	1100110100	IC4 SH	↑									
180	0010110100	IC5 SH	↑									
181	1010110100	IC6 SH	↑									
182	0110110100	IC7 SH	↑									
183	1110110100	IC8 SH	↑									
184	0001110100	IC9 SH	↑									
185	1001110100	IC10 SH	↑									
186	0101110100	IC11 SH	↑									
187	1101110100	IC12 SH	↑									
188	0011110100	IC13 SH	↑									
189	1011110100	IC14 SH	↑									
190	0111110100	IC15 SH	↑									
191	1111110100	IC16 SH	↑									
192	0000001100	IC1 SC	↑								M	
193	1000001100	IC2 SC	↑									
194	0100001100	IC3 SC	↑									
195	1100001100	IC4 SC	↑									
196	0010001100	IC5 SC	↑									
197	1010001100	IC6 SC	↑									
198	0110001100	IC7 SC	↑									
199	1110001100	IC8 SC	↑									

No	SW1	Item	Display								Remarks
	12345678910		LD1	LD2	LD3	LD4	LD5	LD6	LD7	LD8	
200	0001001100	IC9 SC	-99.9 ~ 999.9								M
201	1001001100	IC10 SC	↑								
202	0101001100	IC11 SC	↑								
203	1101001100	IC12 SC	↑								
204	0011001100	IC13 SC	↑								
205	1011001100	IC14 SC	↑								
206	0111001100	IC15 SC	↑								
207	1111001100	IC16 SC	↑								
208	0000101100	IC1 LEV Opening pulse	0 ~ 9999								M
209	1000101100	IC2 LEV Opening pulse	↑								
210	0100101100	IC3 LEV Opening pulse	↑								
211	1100101100	IC4 LEV Opening pulse	↑								
212	0010101100	IC5 LEV Opening pulse	↑								
213	1010101100	IC6 LEV Opening pulse	↑								
214	0110101100	IC7 LEV Opening pulse	↑								
215	1110101100	IC8 LEV Opening pulse	↑								
216	0001101100	IC9 LEV Opening pulse	↑								
217	1001101100	IC10 LEV Opening pulse	↑								
218	0101101100	IC11 LEV Opening pulse	↑								
219	1101101100	IC12 LEV Opening pulse	↑								
220	0011101100	IC13 LEV Opening pulse	↑								
221	1011101100	IC14 LEV Opening pulse	↑								
222	0111101100	IC15 LEV Opening pulse	↑								
223	1111101100	IC16 LEV Opening pulse	↑								
224	0000011100	IC1 Operation Mode	0: Stop 1: Fan 2: Cooling 3: Heating 4: Dry								M
225	1000011100	IC2 Operation Mode									
226	0100011100	IC3 Operation Mode									
227	1100011100	IC4 Operation Mode									
228	0010011100	IC5 Operation Mode									

No	SW1	Item	Display								Remarks
	12345678910		LD1	LD2	LD3	LD4	LD5	LD6	LD7	LD8	
229	10100111000	IC6 Operation Mode	0: Stop 1: Fan 2: Cooling 3: Heating 4: Dry								M
230	0110011100	IC7 Operation Mode									
231	11100111000	IC8 Operation Mode									
232	0001011100	IC9 Operation Mode									
233	1001011100	IC10 Operation Mode									
234	0101011100	IC11 Operation Mode									
235	1101011100	IC12 Operation Mode									
236	0011011100	IC13 Operation Mode									
237	1011011100	IC14 Operation Mode									
238	0111011100	IC15 Operation Mode									
239	1111011100	IC16 Operation Mode									
240	0000111100	IC1 Filter									
241	1000111100	IC2 Filter	↑								
242	0100111100	IC3 Filter	↑								
243	1100111100	IC4 Filter	↑								
244	0010111100	IC5 Filter	↑								
245	1010111100	IC6 Filter	↑								
246	0110111100	IC7 Filter	↑								
247	1110111100	IC8 Filter	↑								
248	0001111100	IC9 Filter	↑								
249	1001111100	IC10 Filter	↑								
250	0101111100	IC11 Filter	↑								
251	1101111100	IC12 Filter	↑								
252	0011111100	IC13 Filter	↑								
253	1011111100	IC14 Filter	↑								
254	0111111100	IC15 Filter	↑								
255	1111111100	IC16 Filter	↑								

② PURY-(P)200-250YMF-C

E: E2 Contents stored in the E2PROM; M: Monitored by the IC through communications; E*: Stored in service memory.

No	SW1	Item	Display								Remarks
	12345678910		LD1	LD2	LD3	LD4	LD5	LD6	LD7	LD8	
0	0000000000	Relay Output Display 1 (Lights up to display)	COMP Operating	Crankcase Heater ON	21S4	SV1	SV2	SV3	SV4	Lights for Normal Operation	LD8 is a relay output indicator which lights up at all times when the microcomputer's power is ON. When sending of a monitoring request to IC/BC is terminated, if there is no error, "----" is displayed. E*
		Check Display 1 OC Error	0 ~ 9999 Address and error code reversed								
1	1000000000	Relay Output Display 2	SV5	SV6							E*
2	0100000000	Check Display 2 (Including the IC)	0 ~ 9999 Address and error code reversed								If there is no error, "----" is displayed. E*
3	1100000000										
4	0010000000										
5	1010000000	Communication Demand capacity	0 ~ 9999								If no demand control, "----" displayed. {%) E*
6	0110000000	External Signal (Signal being input)	Demand			night mode.					E*
7	1110000000	Outdoor Unit Operation Display	BC operating command	Warm-up mode	3 minutes restart protection mode	Compressor operating	Preliminary Error	Error			E*
8	0001000000	Indoor Unit Check	Unit No. 1	Unit No. 2	Unit No. 3	Unit No. 4	Unit No. 5	Unit No. 6	Unit No. 7	Unit No. 8	Lights up if an abnormal stop has occurred in the IC. The indicator for Unit No. 1 goes off when error reset is carried out from the smallest address. M
9	1001000000		Unit No. 9	Unit No. 10	Unit No. 11	Unit No. 12	Unit No. 13	Unit No. 14	Unit No. 15	Unit No. 16	
10	0101000000	Indoor Unit Operation Mode	Unit No. 1	Unit No. 2	Unit No. 3	Unit No. 4	Unit No. 5	Unit No. 6	Unit No. 7	Unit No. 8	Lights up during cooling. Blinks during heating. Goes off during stop and blower operation. M
11	1101000000		Unit No. 9	Unit No. 10	Unit No. 11	Unit No. 12	Unit No. 13	Unit No. 14	Unit No. 15	Unit No. 16	
12	0011000000	Indoor Unit Thermostat ON	Unit No. 1	Unit No. 2	Unit No. 3	Unit No. 4	Unit No. 5	Unit No. 6	Unit No. 7	Unit No. 8	Lights up when thermostat is ON. Goes off when thermostat is OFF. M
13	1011000000		Unit No. 9	Unit No. 10	Unit No. 11	Unit No. 12	Unit No. 13	Unit No. 14	Unit No. 15	Unit No. 16	
14	0111000000	BC All Indoor Unit Mode	Cooling-only ON	Cooling-only OFF	Heating-only ON	Heating-only OFF	Mixed ON	Mixed OFF	Fan	OFF	E*
15	1111000000	Outdoor Unit Operation Mode	Permissible Stop	Standby	Defrost	Cooling-only	Cooling-main	Heating-only	Heating-main		
16	0000100000	Outdoor Unit Control Mode	Cooling-only Refrigerant Recovery	Cooling-main Refrigerant Recovery	Heating-only Refrigerant Recovery	Heating-main Refrigerant Recovery	Cooling-only Oil Recovery	Cooling-main Oil Recovery	Heating-only Oil Recovery	Heating-main Oil Recovery	
17	1000100000	Preliminary Error in Outdoor Unit	High Pressure Error 1, 2	Low Pressure Error 1, 2	Discharge Temperature Error	Overcurrent Protection	Heat Sink Thermostat Operating	Overcurrent Break	INV Error	Over-charged Refrigerant	The flag corresponding to the item where there is an error delay lights up. E*
18	0100100000		Suction pressure Error	Configuration Detection Error	Comp. temperature Error						
19	1100100000		TH1 Error	TH2 Error*	LD1 Error	LD2 Error	TH5 Error	TH6 Error	HPS Error	THHS Error	
20	0010100000		TH7 Error		TH9 Error*	TH10 Error*	LPS Error				

*note : only PURY-P

No	SW1	Item	Display								Remarks
	12345678910		LD1	LD2	LD3	LD4	LD5	LD6	LD7	LD8	
21	1010100000	Outdoor Unit Preliminary Error History	High Pressure Error 1, 2	Low Pressure Error	Discharge Temperature Error	Overcurrent Protection	Heat Sink Thermostat Operation	Overcurrent Break		Overcharged Refrigerant	Lights up if an error delay has occurred between the time the power was turned on and the present time. To turn the indicators off, switch the power OFF briefly. E*
22	0110100000		Suction pressure Error	Configuration Detection Error	Comp. temperature Error						
23	1110100000		TH1 Error	TH2 Error*	LD1 Error	LD2 Error	TH5 Error	TH6 Error	HPS Error	THHS Error	
24	0001100000		TH7 Error		TH9 Error*	TH10 Error*					
25	1001100000	Error History 1	0 ~ 9999								The error and error delay code are displayed. If the address and error code are shown in reverse, or there is no error, " - - - " is displayed. E
26	0101100000	Inverter Error Detail	Inverter Error Detail (1 ~ 13)								If there is no error, " - - - " is displayed. E
27	1101100000	Error History 2	0 ~ 9999								E
28	0011100000	Inverter Error Detail	Inverter Error Detail (1 ~ 13)								
29	1011100000	Error History 3	0 ~ 9999								
30	0111100000	Inverter Error Detail	Inverter Error Detail (1 ~ 13)								
31	1111100000	Error History 4	0 ~ 9999								
32	0000100000	Inverter Error Detail	Inverter Error Detail (1 ~ 13)								
33	1000010000	Error History 5	0 ~ 9999								
34	0100010000	Inverter Error Detail	Inverter Error Detail (1 ~ 13)								
35	1100010000	Error History 6	0 ~ 9999								
36	0010010000	Inverter Error Detail	Inverter Error Detail (1 ~ 13)								
37	1010010000	Error History 7	0 ~ 9999								
38	0110010000	Inverter Error Detail	Inverter Error Detail (1 ~ 13)								
39	1110010000	Error History 8	0 ~ 9999								
40	0001010000	Inverter Error Detail	Inverter Error Detail (1 ~ 13)								
41	1001010000	Error History 9	0 ~ 9999								
42	0101010000	Inverter Error Detail	Inverter Error Detail (1 ~ 13)								
43	1101010000	Error History 10	0 ~ 9999								
44	0011010000	Inverter Error Detail	Inverter Error Detail (1 ~ 13)								
45	1011010000	Type of Inverter Error Preliminary (Details of the inverter error in No. 17)	0 ~ 9999								If there is no error, " - - - - " is always overwritten. E*
46	0111010000	TH1 Data	-99.9 ~ 999.9								E* [No. 52 THHS data are monitored by the inverter microcomputer.]
47	1111010000	TH2 Data*	↑								
48	0000110000	LD1 Data	0 : OFF 1 : ON 2 : OPEN								
49	1000110000	LD2 Data	0 : OFF 1 : ON 2 : OPEN								
50	0100110000	TH5 Data	-99.9 ~ 999.9								
51	1100110000	TH6 Data	↑								

No	SW1	Item	Display								Remarks
	12345678910		LD1	LD2	LD3	LD4	LD5	LD6	LD7	LD8	
52	0010110000	THHS Data	-99.9 ~ 999.9								E*
53	1010110000	HPS Data	↑								
54	0110110000	TH7 Data	↑								
55	1110110000										
56	0001110000	TH9 Data*	-99.9 ~ 999.9								
57	1001110000	TH10 Data*	↑								
58	0101110000	LPS Data	↑								
59	1101110000	α OC*	0 ~ 9.999								
60	0011110000	α OC*★	↑								
61	1011110000	Accumulator Level α OC*	① and ② below are displayed alternately at every 5 seconds. ① Accumulator Level: 0~9 ("AL=" is also displayed), ② α OC*: 0~9.999								
62	0111110000	HZAk Increase/ Decrease	Δ Hz -	Δ Hz 0	Δ Hz +	-	-	Δ AK -	Δ AK 0	Δ AK +	
63	1111110000	Difference from Target Tc (Tcm-Tc)	Low -3 deg. or lower	Low -3 ~ -2 deg.	Low -2 ~ -1 deg.	Stable Region		High 1~2 deg.	High 2~3 deg.	High 3 deg or higher	
64	0000001000	Difference from Target Te (Tem-Te)	Low -3 deg. or lower	Low -3 ~ -2 deg.	Low -2 ~ -1 deg.	Stable Region		High 1~2 deg.	High 2~3 deg.	High 3 deg or higher	
65	1000001000	Tc	-99.9 ~ 999.9								
66	0100001000	Te	↑								
67	1100001000	Tcm	↑								
68	0010001000	Tem	↑								
69	1010001000	Comp Frequency	0 ~ 9999								Control Frequency E*
70	0110001000	INV Output Frequency	↑								Frequency actually out- put from the inverter. E*
71	1110001000	AK	↑								E*
72	0001001000	SLEV	↑								
73	1001001000	BC Address	↑								
74	0101001000	FANCON Output Value (Toff%)	↑								
75	1101001000	INV Output Current (IAC)	-99.9 ~ 999.9								(M) Monitored by the inverter's microcomputer.
76	0011001000	OC Address	0 ~ 9999								
77	1011001000	IC1 Address/ Capacity Code	0 ~ 99				0 ~ 99				E On the left (LD1~LD4), the IC address, and on the right (LD5~LD8), the capacity code is displayed (displayed alternately every 1 minute).
78	0111001000	IC2 Address/ Capacity Code	↑				↑				
79	1111001000	IC3 Address/ Capacity Code	↑				↑				
80	0000101000	IC4 Address/ Capacity Code	↑				↑				
81	1000101000	IC5 Address/ Capacity Code	↑				↑				
82	0100101000	IC6 Address/ Capacity Code	↑				↑				

When there is an error stop with No95-121, the data on error stops or the data immediately before the error postponement stop, which is stored in service memory, are displayed.

No	SW1 12345678910	Item	Display								Remarks
			LD1	LD2	LD3	LD4	LD5	LD6	LD7	LD8	
83	1100101000	IC7 Address/ Capacity Code	0 ~ 99				0 ~ 99				E On the left (LD1~LD4), the IC address, and on the right (LD5~LD8), the capacity code is displayed (displayed alternately every 5 seconds).
84	0010101000	IC8 Address/ Capacity Code	↑				↑				
85	1010101000	IC9 Address/ Capacity Code	↑				↑				
86	0110101000	IC10 Address/ Capacity Code	0 ~ 9999								
87	1110101000	IC11 Address/ Capacity Code									
88	0001101000	IC12 Address/ Capacity Code									
89	1001101000	IC13 Address/ Capacity Code									
90	0101101000	IC14 Address/ Capacity Code									
91	1101101000	IC15 Address/ Capacity Code									
92	0011101000	IC16 Address/ Capacity Code									
93	1011101000	COMP Operation Time, Higher order 4 digits	0 ~ 9999								E*
94	0111101000	Lower order 4 digits	↑								
95	1111101000	Outdoor Unit Operation\Mode	Permissible Stop	Standby	Defrost	Cooling- only	Cooling- main	Heating- only	Heating- main		E
96	0000011000	Outdoor Unit Control Mode	Cooling-only Refrigerant Recovery	Cooling-main Refrigerant Recovery	Heating-only Refrigerant Recovery	Heating-main Refrigerant Recovery	Cooling- only Oil Recovery	Cooling- main Oil Recovery	Heating- only Oil Recovery	Heating- main Oil Recovery	
97	1000011000	Relay Output Display 1 Lighting Display	COMP Operat- ing	Crankcase Heater ON	21S4	SV1	SV2	SV3	SV4		
98	0100011000	TH1 Data	-99.9 ~ 999.9								
99	1100011000	TH2 Data*	↑								
100	0010011000	LD1 Data	0 : OFF 1 : ON 2 : OPEN								
101	1010011000	LD2 Data	0 : OFF 1 : ON 2 : OPEN								
102	0110011000	TH5 Data	-99.9 ~ 999.9								
103	1110011000	TH6 Data	↑								
104	0001011000	HPS Data	↑								
105	1001011000	THHS Data	↑								
106	0101011000	TH7 Data	↑								
107	1101011000										
108	0011011000	TH9 Data*	-99.9 ~ 999.9								
109	1011011000	TH10 Data*	↑								
110	0111011000	LPS Data	↑								
111	1111011000	α OC*	0 ~ 9.999								

When there is an error stop with No95-121, the data on error stops or the data immediately before the error postpone-ment stop, which is stored in service memory, are displayed.

No	SW1	Item	Display								Remarks
	12345678910		LD1	LD2	LD3	LD4	LD5	LD6	LD7	LD8	
112	0000111000	α OC*★	0 ~ 9.999								E
113	1000111000	Tc	-99.9 ~ 999.9								
114	0100111000	Te	↑								
115	1100111000	Configuration Correction Value	0 ~ 9999								
116	0010111000	INV Output Frequency	↑								
117	1010111000	AK	↑								
118	0110111000	SLEV	↑								
119	1110111000	Relay out put Display 2 lighting Display	SV5	SV6				SSR			
120	0001111000	DC Trunk Line Current	-99.9 ~ 999.9								
121	1001111000	Outdoor Unit Operation Display	BC operating command	Warm-up mode	3-minute Re-start protection mode	Compressor Operating	Preliminary Error	Error			
122	0101111000	BC All Indoor Unit Mode	Cooling-only ON	Cooling-only OFF	Heating-only ON	Heating-only OFF	Mixed ON	Mixed OFF	Fan	Stop	
123	1101111000										
124	0011111000										
125	1011111000										
126	0111111000										
127	1111111000	Elapsed Time for CS Circuit Closed Detection	0 ~ 9999								
128	0000000100	BC TH 11 Data	-99.9 ~ 999.9								M
129	1000000100	IBC TH 12 Data	↑								
130	0100000100	BC TH 13 Data	↑								
131	1100000100	BC TH 14 Data	↑								
132	0010000100	BC TH 15 Data	↑								
133	1010000100	BC TH 16 Data	↑								
134	0110000100	BC P1 Data	↑								
135	1110000100	BC P3 Data	↑								
136	0001000100	BC SC 11 Data	↑								
137	1001000100	BC SH 12 Data	↑								
138	0101000100	BC SH 13 Data	↑								
139	1101000100	BC SC 16 Data	↑								

No	SW1	Item	Display								Remarks
	12345678910		LD1	LD2	LD3	LD4	LD5	LD6	LD7	LD8	
140	0011000100	BC LEV 12 Data	-99.9 ~ 999.9								M
141	1011000100	BC LEV 3 Data	↑								
142	0111000100	BC LEV 4 Data	↑								
143	1111000100		↑								
144	0000100100	IC1 liquid Pipe Temperature	↑								M
145	1000100100	IC2 liquid Pipe Temperature	↑								
146	0100100100	IC3 liquid Pipe Temperature	↑								
147	1100100100	IC4 liquid Pipe Temperature	↑								
148	0010100100	IC5 liquid Pipe Temperature	↑								
149	1010100100	IC6 liquid Pipe Temperature	↑								
150	0110100100	IC7 liquid Pipe Temperature	↑								
151	1110100100	IC8 liquid Pipe Temperature	↑								
152	0001100100	IC9 liquid Pipe Temperature	↑								
153	1001100100	IC10 liquid Pipe Temperature	↑								
154	0101100100	IC11 liquid Pipe Temperature	↑								
155	1101100100	IC12 liquid Pipe Temperature	↑								
156	0011100100	IC13 liquid Pipe Temperature	↑								
157	1011100100	IC14 liquid Pipe Temperature	↑								
158	0111100100	IC15 liquid Pipe Temperature	↑								
159	1111100100	IC16 liquid Pipe Temperature	↑								
160	0000010100	IC1 Gas Pipe Temperature	↑								
161	1000010100	IC2 Gas Pipe Temperature	↑								
162	0100010100	IC3 Gas Pipe Temperature	↑								
163	1100010100	IC4 Gas Pipe Temperature	↑								
164	0010010100	IC5 Gas Pipe Temperature	↑								
165	1010010100	IC6 Gas Pipe Temperature	↑								

No	SW1	Item	Display								Remarks
	12345678910		LD1	LD2	LD3	LD4	LD5	LD6	LD7	LD8	
166	0110010100	IC7 Gas Pipe Temperature	-99.9 ~ 999.9								M
167	1110010100	IC8 Gas Pipe Temperature	↑								
168	0001010100	IC9 Gas Pipe Temperature	↑								
169	1001010100	IC10 Gas Pipe Temperature	↑								
170	0101010100	IC11 Gas Pipe Temperature	↑								
171	1101010100	IC12 Gas Pipe Temperature	↑								
172	0011010100	IC13 Gas Pipe Temperature	↑								
173	1011010100	IC14 Gas Pipe Temperature	↑								
174	0111010100	IC15 Gas Pipe Temperature	↑								
175	1111010100	IC16 Gas Pipe Temperature	↑								
176	0000110100	IC1 SH	↑								M
177	1000110100	IC2 SH	↑								
178	0100110100	IC3 SH	↑								
179	1100110100	IC4 SH	↑								
180	0010110100	IC5 SH	↑								
181	1010110100	IC6 SH	↑								
182	0110110100	IC7 SH	↑								
183	1110110100	IC8 SH	↑								
184	0001110100	IC9 SH	↑								
185	1001110100	IC10 SH	↑								
186	0101110100	IC11 SH	↑								
187	1101110100	IC12 SH	↑								
188	0011110100	IC13 SH	↑								
189	1011110100	IC14 SH	↑								
190	0111110100	IC15 SH	↑								
191	1111110100	IC16 SH	↑								
192	0000001100	IC1 SC	↑								M
193	1000001100	IC2 SC	↑								
194	0100001100	IC3 SC	↑								
195	1100001100	IC4 SC	↑								
196	0010001100	IC5 SC	↑								
197	1010001100	IC6 SC	↑								
198	0110001100	IC7 SC	↑								
199	1110001100	IC8 SC	↑								

No	SW1	Item	Display								Remarks
	12345678910		LD1	LD2	LD3	LD4	LD5	LD6	LD7	LD8	
200	0001001100	IC9 SC	-99.9 ~ 999.9								M
201	1001001100	IC10 SC	↑								
202	0101001100	IC11 SC	↑								
203	1101001100	IC12 SC	↑								
204	0011001100	IC13 SC	↑								
205	1011001100	IC14 SC	↑								
206	0111001100	IC15 SC	↑								
207	1111001100	IC16 SC	↑								
208	0000101100	IC1 LEV Opening pulse	0 ~ 9999								M
209	1000101100	IC2 LEV Opening pulse	↑								
210	0100101100	IC3 LEV Opening pulse	↑								
211	1100101100	IC4 LEV Opening pulse	↑								
212	0010101100	IC5 LEV Opening pulse	↑								
213	1010101100	IC6 LEV Opening pulse	↑								
214	0110101100	IC7 LEV Opening pulse	↑								
215	1110101100	IC8 LEV Opening pulse	↑								
216	0001101100	IC9 LEV Opening pulse	↑								
217	1001101100	IC10 LEV Opening pulse	↑								
218	0101101100	IC11 LEV Opening pulse	↑								
219	1101101100	IC12 LEV Opening pulse	↑								
220	0011101100	IC13 LEV Opening pulse	↑								
221	1011101100	IC14 LEV Opening pulse	↑								
222	0111101100	IC15 LEV Opening pulse	↑								
223	1111101100	IC16 LEV Opening pulse	↑								
224	0000011100	IC1 Operation Mode/ Branch Number	0: Stop 1: Fan 2: Cooling 3: Heating 4: Dry				0 ~ 99				M On the left (LD1~LD4), the IC address, and on the right (LD5~LD8), the capacity code is displayed (displayed alternately every 5 seconds).
225	1000011100	IC2 Operation Mode/ Branch Number									
226	0100011100	IC3 Operation Mode/ Branch Number									
227	1100011100	IC4 Operation Mode/ Branch Number									
228	0010011100	IC5 Operation Mode/ Branch Number									

No	SW1	Item	Display								Remarks
	12345678910		LD1	LD2	LD3	LD4	LD5	LD6	LD7	LD8	
229	10100111000	IC6 Operation Mode/ Branch Number	0: Stop 1: Fan 2: Cooling 3: Heating 4: Dry								M On the left (LD1~LD4), the IC address, and on the right (LD5~LD8), the capacity code is displayed (displayed alternately every 5 seconds).
230	01100111100	IC7 Operation Mode/ Branch Number									
231	11100111000	IC8 Operation Mode/ Branch Number									
232	00010111100	IC9 Operation Mode/ Branch Number									
233	10010111100	IC10 Operation Mode/ Branch Number									
234	01010111100	IC11 Operation Mode/ Branch Number									
235	11010111100	IC12 Operation Mode/ Branch Number									
236	00110111100	IC13 Operation Mode/ Branch Number									
237	10110111100	IC14 Operation Mode/ Branch Number									
238	01110111100	IC15 Operation Mode/ Branch Number									
239	11110111100	IC16 Operation Mode/ Branch Number									
240	0000111100	IC1 Filter	0 ~ 9999								M
241	1000111100	IC2 Filter	↑								
242	0100111100	IC3 Filter	↑								
243	1100111100	IC4 Filter	↑								
244	0010111100	IC5 Filter	↑								
245	1010111100	IC6 Filter	↑								
246	0110111100	IC7 Filter	↑								
247	1110111100	IC8 Filter	↑								
248	0001111100	IC9 Filter	↑								
249	1001111100	IC10 Filter	↑								
250	0101111100	IC11 Filter	↑								
251	1101111100	IC12 Filter	↑								
252	0011111100	IC13 Filter	↑								
253	1011111100	IC14 Filter	↑								
254	0111111100	IC15 Filter	↑								
255	1111111100	IC16 Filter	↑								

8 PREPARATION, REPAIRS AND REFRIGERANT REFILLING WHEN REPAIRING LEAKS

[1] Location of leaks: Extension piping or indoor units (when cooling)

<PU(H)Y-(P)200-250YMF-C>

- ① Connect a pressure gauge to the low-pressure servicing check joint CJ2.
- ② Test run all indoor units in cooling mode.
 1. With SW3-1 on the MAIN board of the outdoor unit set to ON and SW3-2 OFF → ON to test run all indoor units.
 2. Change the remote controller settings so that all indoor units run in cooling mode.
 3. Check that all indoor units are running in cooling mode.
- ③ Perform a pump down operation.
 1. Close the liquid ball valve (BV2) on the outdoor unit to begin the pump down.
- ④ When the pressure gauge on the low-pressure servicing check joint CJ2 reads 2 kg/cm²G (0.20MPa), stop all indoor units and the compressor.
 1. With SW3-1 on the MAIN board of the outdoor unit set to ON and SW3-2 ON → OFF to stop all indoor units and the compressor.
 2. Check that all indoor units have been stopped.
- ⑤ Close the gas ball valve (BV1) on the outdoor unit.
- ⑥ Remove any refrigerant remaining in the extension piping or the indoor units.
Reclaim the refrigerant; do not discharge it into the air.
- ⑦ Repair the leak point.
- ⑧ After the leak point is repaired, extract all air from the extension piping and the indoor units to create a vacuum.
- ⑨ Open both ball valves (BV1 and BV2) on the outdoor unit, then adjust the refrigerant amount and verify that the refrigerant is circulating properly.

<PUY-(P)200-250YMF-C> (Pump down operation)

- ① Attach a pressure gage to the low-pressure servicing check joint (CJ2).
- ② Stop all of the indoor units. When the compressor has stopped, shut off the liquid ball valve (BV2) for the outdoor unit.
- ③ Stop all of the indoor units. When the compressor has stopped, turn the SW3-6 switch on the main board for the outdoor unit to ON. (This will start the pump down operation causing all of the indoor units to enter the cooling mode.)
- ④ While in the pump down operation (SW3-6 ON), the low pressure (LPS) will reach below at least 2 kg/cm²G (0.20 MPa) or the indoor unit and the compressor will automatically shut down within 15 minutes of starting the pump down operation. Shut down all of the indoor units and the compressor if the pressure gage for the low-pressure servicing joint (CJ2) reads 1.5 kg/cm²G (0.15 MPa) or after running the pump down operation for 20 minutes.
- ⑤ Shut off the gas ball valve (BV1) for the outdoor unit.
- ⑥ Remove any refrigerant remaining in the extension piping and the indoor units.
Be sure to recover the refrigerant without releasing it into the air.
- ⑦ Repair the location of the leak.
- ⑧ After repairing the leak, create a vacuum to remove any air from inside of the extension piping or the indoor units.
- ⑨ Open the ball valves for the outdoor unit (BV1 and BV2), turn the SW3-6 switch to OFF, adjust refrigerant levels and confirm proper circulation.

[2] Location of leaks: Outdoor unit (Cooling mode)

- ① Test run all indoor units in cooling mode.
 1. With SW3-1 on the MAIN board of the outdoor unit set to ON and SW3-2 OFF → ON to test run all indoor units.
 2. Change the remote controller settings so that all indoor units run in cooling mode.
 3. Check that all indoor units are running in cooling mode.

- ②-1 Check the Tc and TH7 data (PUHY-P200-250YMF-C).
 (The self-diagnosis switch (SW1) on the MAIN board of the outdoor unit can be used to display this data on the LED.)
1. If Tc – TH7 is 10 degrees or more Continue to step ③.
 2. If Tc – TH7 is less than 10 degrees After stopping the compressor, remove any refrigerant, repair the leak point, then extract the air to create a vacuum and refill with new refrigerant (same procedure as 4. Location of leaks: Outdoor unit (when heating)).

[Tc self-diagnosis switch]

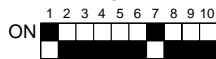

[TH7 self-diagnosis switch]

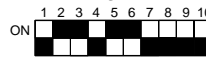

- ②-2 Check the Tc and SC16 data. (PURY-P200-250YMF-C)
 (The LED monitor switch (SW1) on the MAIN board of the outdoor unit can be used to display this data on the LED.)
1. If SC16 is 10 degrees or more Continue to step ③.
 2. If SC16 is less than 10 degrees After stopping the compressor, remove any refrigerant, repair the leak point, then extract the air to create a vacuum and refill with new refrigerant (same procedure as 4. Location of leaks: Outdoor unit (when heating)).

[Tc LED monitor switch]

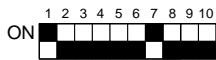

[SC16 LED monitor switch]

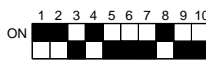

- ③ Stop all indoor units and the compressor.
1. With SW3-1 on the MAIN board of the outdoor unit set to ON and SW3-2 ON → OFF to stop all indoor units and the compressor.
 2. Check that all indoor units have been stopped.
- ④ Close both ball valves (BV1 and BV2).
- ⑤ Remove a small amount of refrigerant from the liquid ball valve (BV2) check joint. If this operation is not performed, remaining refrigerant may cause the unit to malfunction.
- ⑥ Remove any refrigerant remaining in the outdoor unit.
 Reclaim the refrigerant; do not discharge it into the air.
- ⑦ Repair the leak point.
- ⑧ After the leak point is repaired, change the dryer and extract all of the air from the outdoor unit to create a vacuum.
- ⑨ Open both ball valves (BV1 and BV2) on the outdoor unit, then adjust the refrigerant amount and verify that the refrigerant is circulating properly.

[3] Location of leaks: Extension piping or indoor units (Heating mode)

- ① Test run all indoor units in heating mode.
1. With SW3-1 on the MAIN board of the outdoor unit set to ON and SW3-2 OFF → ON to test run all indoor units.
 2. Change the remote controller settings so that all indoor units run in heating mode.
 3. Check that all indoor units are running in heating mode.
- ② Stop all indoor units and the compressor.
1. With SW3-1 on the MAIN board of the outdoor unit set to ON and SW3-2 ON → OFF to stop all indoor units and the compressor.
 2. Check that all indoor units have been stopped.
- ③ Close both ball valves (BV1 and BV2).
- ④ Remove any refrigerant remaining in the extension piping or the indoor units.
 Reclaim the refrigerant; do not discharge it into the air.
- ⑤ Repair the leaks.
- ⑥ After the leaks are repaired, extract all air from the extension piping and the indoor units to create a vacuum.
 Then, open both ball valves (BV1 and BV2), then adjust the refrigerant amount and verify that the refrigerant is circulating properly.

[4] Location of leaks: Outdoor unit (when heating)

- ① Remove any refrigerant from the entire system (outdoor unit, extension piping and indoor units). Reclaim the refrigerant; do not discharge it into the air.
- ② Repair the leaks.
- ③ After the leaks are repaired, replace the dryer with a new one and extract all of the air from the entire system to create a vacuum. Then, refill with refrigerant until it reaches the calculated specification (outdoor unit + extension piping + indoor units). Refer to “Chapter 6” for more details.

9 CHECK THE COMPOSITION OF THE REFRIGERANT (PURY-P200-250YMF-C only)

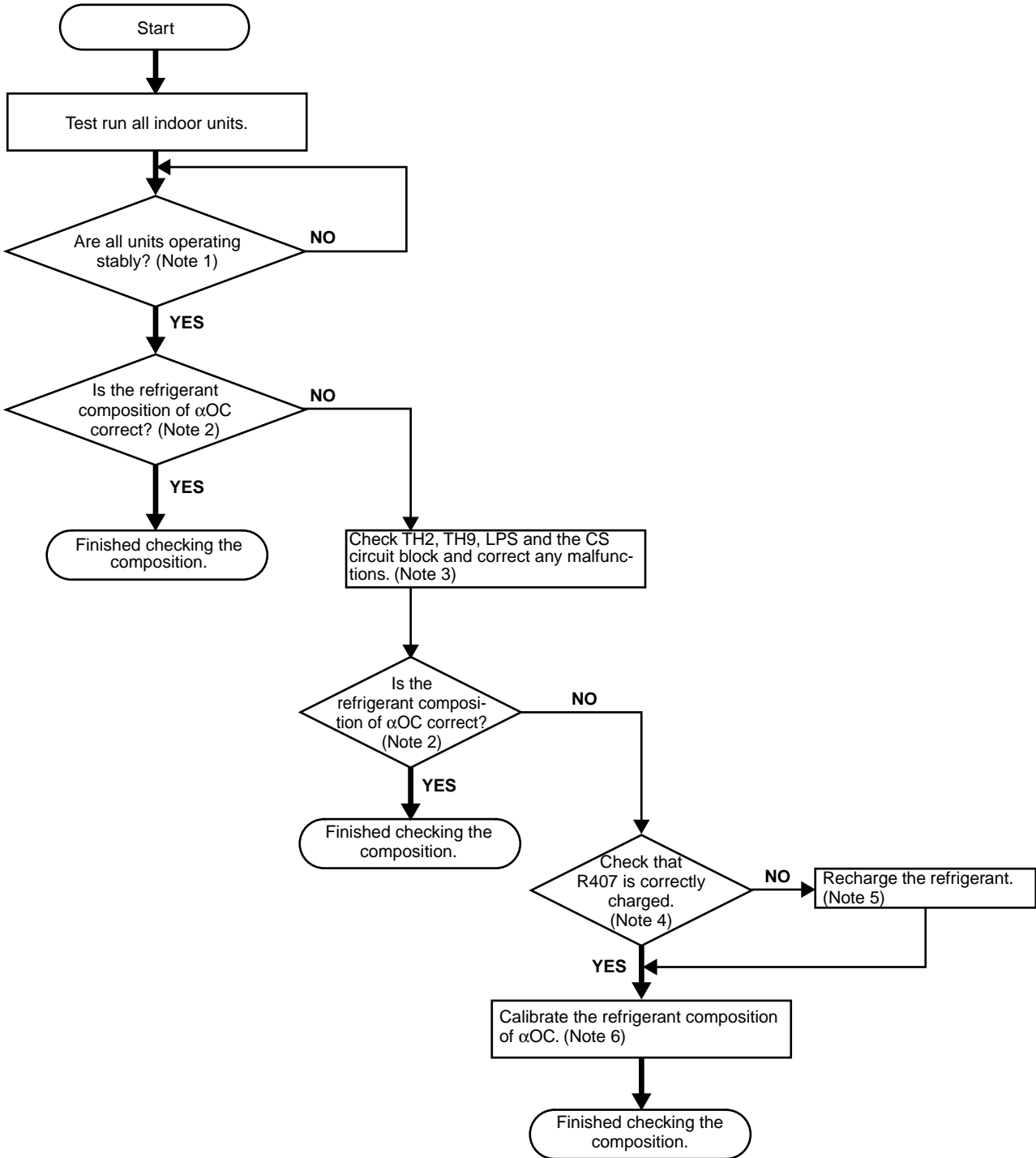
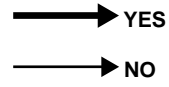

Note 1 Wait until the units stabilize as described in the refrigerant amount adjustment procedure in “Chapter 6”.

Note 2 After the units are operating stably, check that the refrigerant composition of α OC is within the following ranges, indicating that the composition check is finished.

If the accumulator liquid level AL = 0 when cooling: α OC = 0.20 ~ 0.26

If the accumulator liquid level AL = 1 when cooling: α OC = 0.23 ~ 0.34

When heating: α OC = 0.25 ~ 0.34

(The self-diagnosis switch (SW1) on the main board of the outdoor unit can be used to display this data on the LED.)

[α OC self-diagnosis switch]



Note 3 TH2 and TH9: Check and make any corrections using the same method as that for a faulty temperature sensor, (refer to TROUBLESHOOTING).

LPS: Check and make any corrections using the same method as that for a faulty low pressure sensor, (refer to TROUBLESHOOTING).

CS circuit block: Set the self-diagnosis switch on the outdoor MAIN board as shown below.



- Check and make any corrections so that “0” is displayed.
- If any number other than 0 is displayed and TH2, TH9 or LPS are malfunctioning, correct them, then set SW2-9 on the MAIN board of the outdoor unit from OFF to ON.
- If any number other than 0 is displayed and TH2, TH9 or LPS are not malfunctioning, replace the CS circuit if refrigerant is not flowing through it (while operating) and set SW2-9 on the MAIN board of the outdoor unit from OFF to ON.

Note 4 If it can be verified that R407C was correctly charged in the liquid phase, continue to Yes. If there is a possibility that it was not charged correctly, such as with a gas charger, continue to No.

Note 5 After reclaiming the system’s refrigerant, extract the air to create a vacuum, then refill with new refrigerant. Be sure to charge in the liquid phase. In addition, be sure to change the dryer.

Note 6 After the units are operating stably, check that the refrigerant composition of α OC is within the following ranges, indicating that the circulation check is finished.

If the accumulator liquid level AL = 0 when cooling: α OC = 0.21 ~ 0.25

If the accumulator liquid level AL = 1 when cooling: α OC = 0.24 ~ 0.28

When heating: α OC = 0.27 ~ 0.31

If the refrigerant composition of α OC is not within the ranges specified above, a large error has been detected. Refer to section 1-3 in Chapter 6, then after setting SW4-1 on the MAIN board of the outdoor unit to ON, calibrate the refrigerant circulation constant α OC with SW4-2 until it is within the ranges specified above.

After calibrating, keep the SW4-1 ON and finish the circulation check.

<Example calibration of the refrigerant circulation constant α OC>

Conditions: If the accumulator liquid level AL = 0 and α OC = 0.29 when cooling, α OC must be adjusted so that it is between 0.21 and 0.25.

By switching SW4-2 between ON and OFF, adjustments can be made in the following order:

0 → 3% → 6% → 9% → 12% → -6% → -3% → 0

For this example, by making an adjustment of -0.06 (-6%), α OC can be adjusted to 0.23.

1. If SW4-2 is already set to OFF, change the switch 5 times.
OFF (0.29) → ON (0.32) → OFF (0.35) → ON (0.38) → OFF (0.41) → ON (0.23)
2. If SW4-2 is already set to ON, change the switch 5 times.
ON (0.29) → OFF (0.32) → ON (0.35) → OFF (0.38) → ON (0.41) → OFF (0.23)