

Air-Conditioners For Building Application INDOOR UNIT

PKFY-P-VBM-E / PKFY-P-VHM-E

PCFY-P-VKM-E / PFFY-P-VKM-E(2) / PMFY-P-VBM-E

OPERATION MANUAL

FOR USER

For safe and correct use, please read this operation manual thoroughly before operating the air-conditioner unit.

BEDIENUNGSHANDBUCH

FÜR BENUTZER

Zum sicheren und einwandfreien Gebrauch der Klimaanlage dieses Bedienungshandbuch vor Inbetriebnahme gründlich durchlesen.

MANUEL D'UTILISATION

POUR L'UTILISATEUR

Pour une utilisation correcte sans risques, veuillez lire le manuel d'utilisation en entier avant de vous servir du climatiseur.

BEDIENINGSHANDLEIDING

VOOR DE GEBRUIKER

Voor een veilig en juist gebruik moet u deze bedieningshandleiding grondig doorlezen voordat u de airconditioner gebruikt.

MANUAL DE INSTRUCCIONES

PARA EL USUARIO

Lea este manual de instrucciones hasta el final antes de poner en marcha la unidad de aire acondicionado para garantizar un uso seguro y correcto.

ISTRUZIONI DI FUNZIONAMENTO

PER L'UTENTE

Leggere attentamente questi istruzioni di funzionamento prima di avviare l'unità, per un uso corretto e sicuro della stessa.

ΕΓΧΕΙΡΙΔΙΟ ΟΔΗΓΙΩΝ ΧΡΗΣΕΩΣ

ΓΙΑ ΤΟΝ ΧΡΗΣΤΗ

Για ασφάλεια και σωστή χρήση, παρακαλείστε διαβάστε προσεχτικά αυτό το εγχειρίδιο χρήσεως πριν θέσετε σε λειτουργία τη μονάδα κλιματισμού.

MANUAL DE OPERAÇÃO

PARA O UTILIZADOR

Para segurança e utilização correctas, leia atentamente o manual de operação antes de pôr a funcionar a unidade de ar condicionado.

İşletme Elkitabı

KULLANICI İÇİN

Emniyetli ve doğru biçimde nasıl kullanılacağını öğrenmek için lütfen klima cihazını işletmeden önce bu elkitabını dikkatle okuyunuz.

РУКОВОДСТВО ПО ЭКСПЛУАТАЦИИ

ДЛЯ ПОЛЬЗОВАТЕЛЯ

Для обеспечения правильного и безопасного использования следует ознакомиться с инструкциями, указанными в данном руководстве по эксплуатации, тщательным образом до того, как приступить к использованию кондиционера.

English (GB)

Deutsch (D)

Français (F)

Nederlands (NL)

Español (E)

Italiano (I)

Ελληνικά (GR)

Português (P)

Türkçe (TR)

Русский (RU)

Contents

| | | | |
|---|---|---|----|
| 1. Safety Precautions | 2 | 7. Other Functions | 11 |
| 2. Parts Names | 3 | 8. Function Selection | 12 |
| 3. Screen Configuration | 6 | 9. Emergency operation for wireless remote-controller | 16 |
| 4. Setting the Day of the Week and Time | 6 | 10. Care and Cleaning | 16 |
| 5. Operation | 6 | 11. Trouble Shooting | 18 |
| 6. Timer | 8 | 12. Specifications | 20 |



Note

Fig.1

This symbol mark is for EU countries only.

This symbol mark is according to the directive 2002/96/EC Article 10 Information for users and Annex IV, and/or to the directive 2006/66/EC Article 20 Information for end-users and Annex II.

Your MITSUBISHI ELECTRIC product is designed and manufactured with high quality materials and components which can be recycled and/or reused. This symbol means that electrical and electronic equipment, batteries and accumulators, at their end-of-life, should be disposed of separately from your household waste. If a chemical symbol is printed beneath the symbol (Fig. 1), this chemical symbol means that the battery or accumulator contains a heavy metal at a certain concentration.

This will be indicated as follows: Hg: mercury (0,0005%), Cd: cadmium (0,002%), Pb: lead (0,004%)

In the European Union there are separate collection systems for used electrical and electronic products, batteries and accumulators. Please, dispose of this equipment, batteries and accumulators correctly at your local community waste collection/recycling centre.

Please, help us to conserve the environment we live in!

Note:

The phrase "Wired remote controller" in this operation manual refers to the PAR-21MAA.

If you need any information for the other remote controller, please refer to the instruction book included in this box.

1. Safety Precautions

- ▶ Before installing the unit, make sure you read all the "Safety Precautions".
- ▶ The "Safety Precautions" provide very important points regarding safety. Make sure you follow them.
- ▶ Please report to or take consent by the supply authority before connection to the system.

Symbols used in the text

⚠ Warning:

Describes precautions that should be observed to prevent danger of injury or death to the user.

⚠ Caution:

Describes precautions that should be observed to prevent damage to the unit.

Symbols used in the illustrations

⚡: Indicates a part which must be grounded.

⚠ Warning:

- These appliances are not accessible to the general public.
- The unit must not be installed by the user. Ask the dealer or an authorized company to install the unit. If the unit is installed improperly, water leakage, electric shock or fire may result.
- Do not stand on, or place any items on the unit.
- Do not splash water over the unit and do not touch the unit with wet hands. An electric shock may result.
- Do not spray combustible gas close to the unit. Fire may result.
- Do not place a gas heater or any other open-flame appliance where it will be exposed to the air discharged from the unit. Incomplete combustion may result.
- Do not remove the front panel or the fan guard from the outdoor unit when it is running.
- Never repair the unit or transfer it to another site by yourself.
- When you notice exceptionally abnormal noise or vibration, stop operation, turn off the power switch, and contact your dealer.
- Never insert fingers, sticks etc. into the intakes or outlets.
- If you detect odd smells, stop using the unit, turn off the power switch and consult your dealer. Otherwise, a breakdown, electric shock or fire may result.
- This air conditioner is NOT intended for use by children or infirm persons without supervision.

⚠ Caution:

- Do not use any sharp object to push the buttons, as this may damage the remote controller.
- Never block or cover the indoor or outdoor unit's intakes or outlets.
- Never wipe the remote controller with benzene, thinner chemical rags, etc.
- Do not operate the unit for a long time in high humidity, e.g. leaving a door or window open. In the cooling mode, if the unit is operated in a room with high humidity (80% RH or more) for a long time, water condensed in the air conditioner may drop and wet or damage furniture, etc.

- Young children must be supervised to ensure that they do not play with the air conditioner.
- If the refrigeration gas blows out or leaks, stop the operation of the air conditioner, thoroughly ventilate the room, and contact your dealer.
- This appliance is not intended for use by persons (including children) with reduced physical, sensory or mental capabilities, or lack of experience and knowledge, unless they have been given supervision or instruction concerning use of the appliance by a person responsible for their safety.
- When installing or relocating, or servicing the air conditioner, use only the specified refrigerant (R410A) to charge the refrigerant lines. Do not mix it with any other refrigerant and do not allow air to remain in the lines.
If air is mixed with the refrigerant, then it can be the cause of abnormal high pressure in the refrigerant line, and may result in an explosion and other hazards. The use of any refrigerant other than that specified for the system will cause mechanical failure or system malfunction or unit breakdown. In the worst case, this could lead to a serious impediment to securing product safety.

- Do not touch the upper air outlet vane or the lower air outlet damper during operation. Otherwise, condensation may form and the unit may stop operating.

Disposing of the unit

When you need to dispose of the unit, consult your dealer.

2. Parts Names

Indoor Unit

| | PKFY-P-VBM-E | PKFY-P-VHM-E | PCFY-P-VKM-E | PMFY-P-VBM-E | PFFY-P-VKM-E(2) |
|----------------------------|--------------|----------------|----------------|--------------|-----------------|
| Fan speed | 4 speed | 3 speed+ Auto* | 4 speed+ Auto* | 4 speed | 4 speed |
| Vane | Steps | 4 steps | 5 steps | 4 steps | 4 steps |
| | Auto swing | × | ○ | ○ | ○ |
| Louver | Manual | Manual | Manual | Manual | Manual |
| Filter | Normal | Normal | Long-life | Normal | Normal |
| Filter cleaning indication | 100 hr | 100 hr | 2,500 hr | 100 hr | 100 hr |

* This operation is available only using the remote controller that is able to set its Fan speed setting "Auto".

PMFY-P-VBM-E 1-way Ceiling Cassette

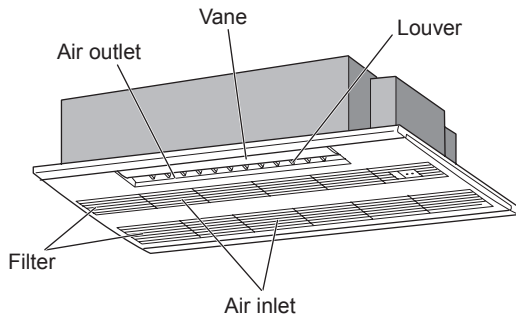

PKFY-P-VBM-E Wall Mounted

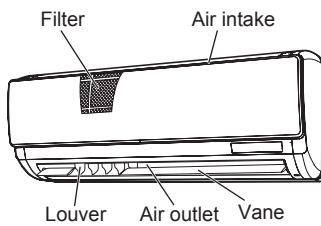

PKFY-P-VHM-E Wall Mounted

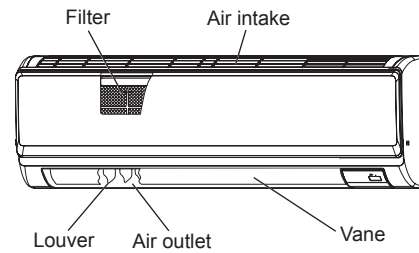

PCFY-P-VKM-E Ceiling Suspended

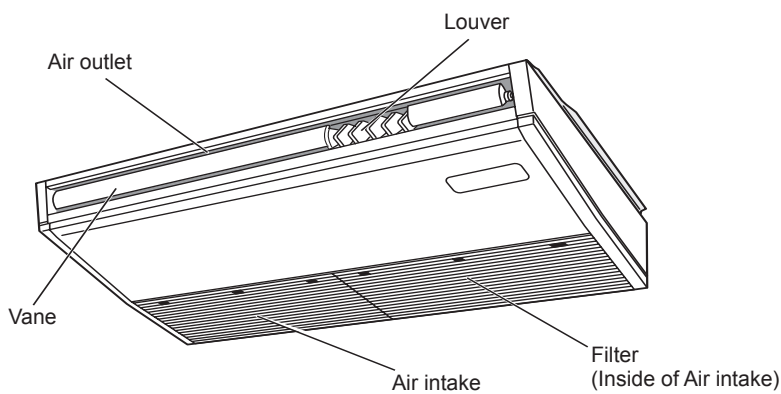

PFFY-P-VKM-E(2) Floor Standing

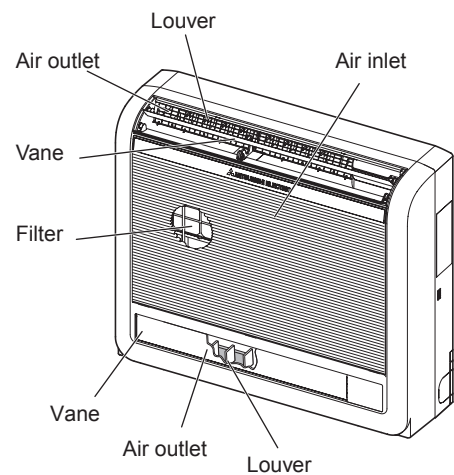

2. Parts Names

■ Wired Remote-Controller

Display Section

For purposes of this explanation, all parts of the display are shown. During actual operation, only the relevant items will be displayed.

Identifies the current operation
Shows the operating mode, etc.
* Multi-language display is supported.

"Centrally Controlled" indicator
Indicates that operation of the remote controller has been prohibited by a master controller.

"Timer is Off" indicator
Indicates that the timer is off.

Temperature Setting
Shows the target temperature.

Day-of-Week
Shows the current day of the week.

Time/Timer Display
Shows the current time, unless the simple or Auto Off timer is set.
If the simple or Auto Off timer is set, shows the time remaining.

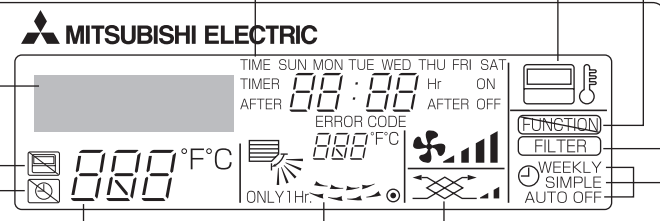

Up/Down Air Direction indicator
The indicator shows the direction of the airflow.

"One Hour Only" indicator
Displays if the airflow is set to Low and downward during COOL or DRY mode. (Operation varies according to model.)
The indicator goes off after one hour when the airflow direction also changes.

Room Temperature display
Shows the room temperature. The room temperature display range is 8 - 39°C.
The display blinks if the temperature is less than 8°C or 39°C or more.

Louver display
Indicates the action of the swing louver. Does not appear if the louver is stationary.

(Power On indicator)
Indicates that the power is on.

"Sensor" indication
Displays when the remote controller sensor is used.

"Locked" indicator
Indicates that remote controller buttons have been locked.

"Clean The Filter" indicator
Comes on when it is time to clean the filter.

Timer indicators
The indicator comes on if the corresponding timer is set.

Fan Speed indicator
Shows the selected fan speed.

Ventilation indicator
Appears when the unit is running in Ventilation mode.

Operation Section

Set Temperature buttons



Timer Menu button (Monitor/Set button)

Mode button (Return button)

Set Time buttons

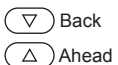

Timer On/Off button (Set Day button)

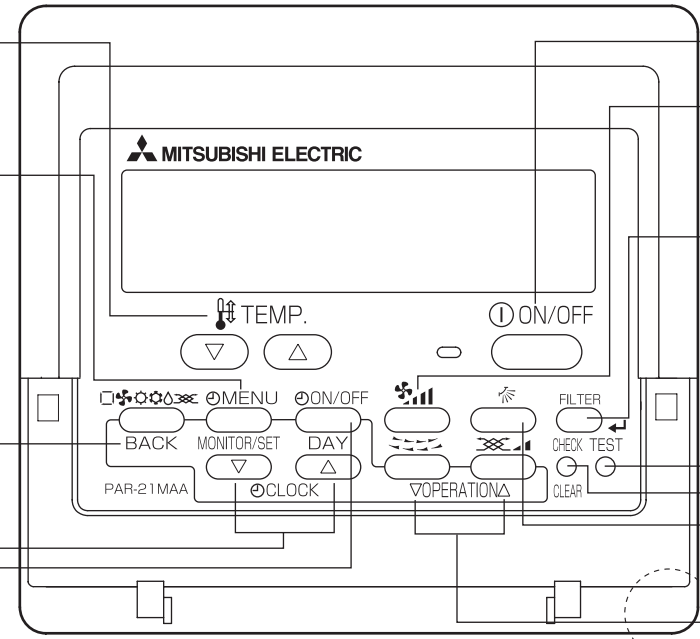
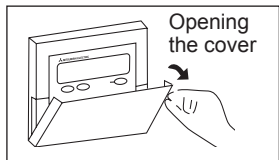

ON/OFF button

Fan Speed button

Filter button (<Enter> button)

Test Run button

Check button (Clear button)

Airflow Up/Down button

Louver button (Operation button)

To return operation number

Ventilation button (Operation button)

To go to next operation number

Built-in temperature sensor

Note:

- "PLEASE WAIT" message
This message is displayed for approximately 3 minutes when power is supplied to the indoor unit or when the unit is recovering from a power failure.
- Operation mode blinking display
When multiple indoor units are connected to a single outdoor unit and an operation mode is selected for one indoor unit that is different from the current operation mode of another indoor unit, the operation mode display blinks. Select the same operation mode of the other indoor unit.
- "NOT AVAILABLE" message
This message is displayed if a button is pressed to operate a function that the indoor unit does not have.
When the same remote controller is used to operate multiple indoor units, this message is displayed if the main indoor unit is not equipped with the selected function.
- Room temperature display
The indoor unit temperature sensors or the remote controller temperature sensor can be selected to measure the room temperature. The indoor unit temperature sensors are the initial setting. When the indoor unit temperature sensors are selected to measure the room temperature, the room temperature measured at the main indoor unit is displayed on the remote controller that operates multiple indoor units.

2. Parts Names

■ Wireless Remote-Controller

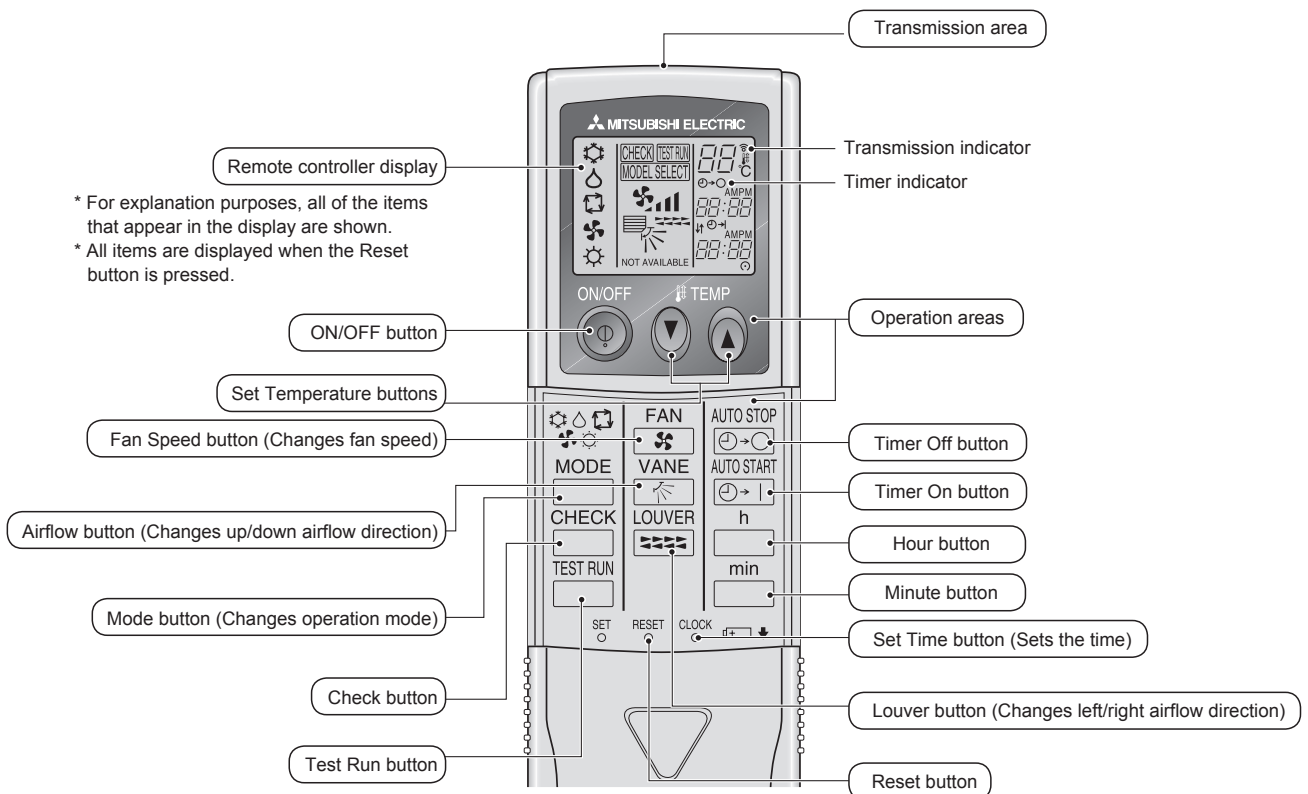

- When using the wireless remote controller, point it towards the receiver on the indoor unit.
- If the remote controller is operated within approximately two minutes after power is supplied to the indoor unit, the indoor unit may beep twice as the unit is performing the initial automatic check.
- The indoor unit beeps to confirm that the signal transmitted from the remote controller has been received. Signals can be received up to approximately 7 meters in a direct line from the indoor unit in an area 45° to the left and right of the unit. However, illumination such as fluorescent lights and strong light can affect the ability of the indoor unit to receive signals.
- If the operation lamp near the receiver on the indoor unit is blinking, the unit needs to be inspected. Consult your dealer for service.
- Handle the remote controller carefully! Do not drop the remote controller or subject it to strong shocks. In addition, do not get the remote controller wet or leave it in a location with high humidity.
- To avoid misplacing the remote controller, install the holder included with the remote controller on a wall and be sure to always place the remote controller in the holder after use.

Battery installation/replacement

1. Remove the top cover, insert two AAA batteries, and then install the top cover.

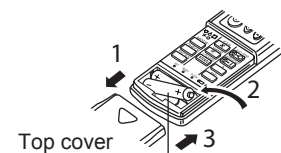

Two AAA batteries
Insert the negative (-)
end of each battery first.
Install the batteries in
the correct directions
(+, -)!

2. Press the Reset button.

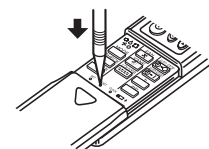

Press the Reset button
with an object that has
a narrow end.

3. Screen Configuration

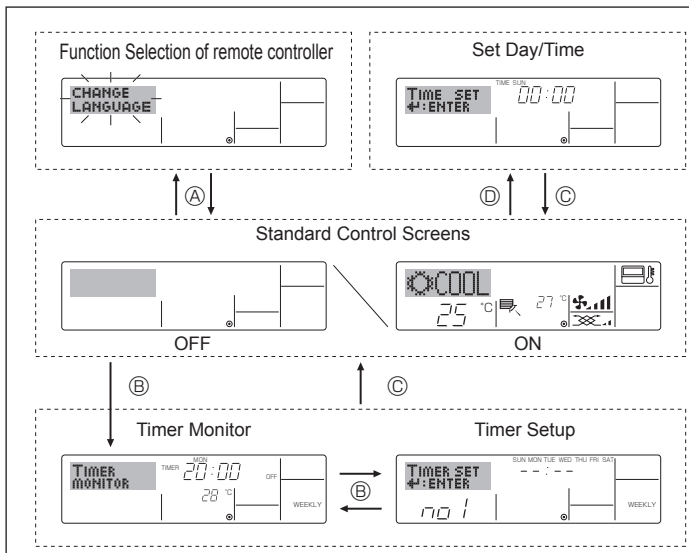

<Screen Types>

For details on setting the language for the remote controller display, refer to section 8. Function Selection.

The initial language setting is English.

- **Function Selection of remote controller:**
Set the functions and ranges available to the remote controller (timer functions, operating restrictions, etc.)
- **Set Day/Time:**
Set the current day of the week or time.
- **Standard Control Screens:**
View and set the air conditioning system's operating status.
- **Timer Monitor:**
View the currently set timer (weekly timer, simple timer or Auto Off timer).
- **Timer Setup:**
Set the operation of any of the timers (weekly timer, simple timer or Auto Off timer).

<How to change the screen>

- Ⓐ : Hold down both the Mode button and the Timer On/Off button for 2 seconds.
- Ⓑ : Press the Timer Menu button.
- Ⓒ : Press the Mode (Return) button.
- Ⓓ : Press either of the Set Time buttons (▽ or △).

4. Setting the Day of the Week and Time

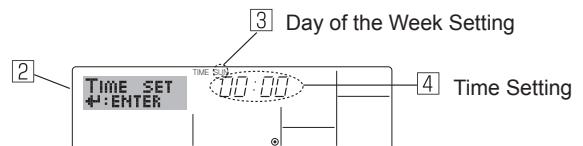
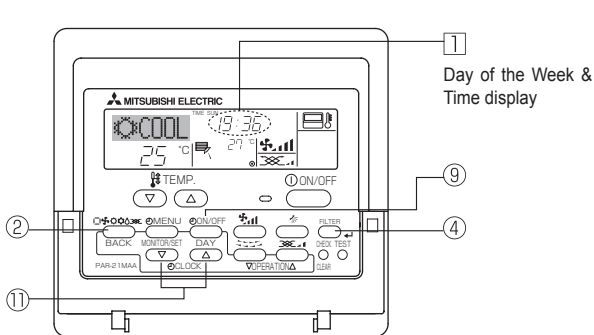

1. Press the ▽ or △ Set Time button ② to show display ②.
2. Press the Timer On/Off (Set Day) button ⑨ to set the day.
* Each press advances the day shown at ③:
Sun → Mon → ... → Fri → Sat.
3. Press the appropriate Set Time button ② as necessary to set the time.
* As you hold the button down, the time (at ④) will increment first in one-minute intervals, then in ten-minute intervals, and then in one-hour intervals.
4. After making the appropriate settings at Steps 2 and 3, press the Filter button ④ to lock in the values.

Note:
The day and time will not appear if clock use has been disabled at Function Selection of remote controller.

5. Operation

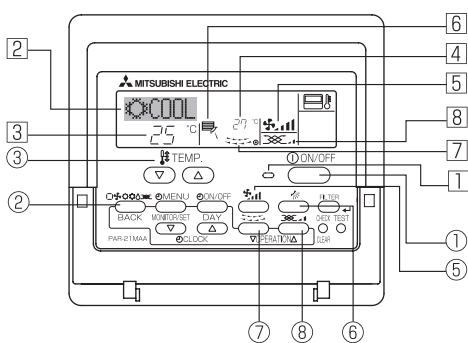

5.1. Turning ON/OFF

<To Start Operation>

- Press the ON/OFF button ①.
- The ON lamp ① and the display area come on.

Note:

- When the unit is restarted, initial settings are as follows.

| Remote Controller settings | |
|----------------------------|------------------------------|
| Mode | Last operation mode |
| Temperature setting | Last set temperature |
| Fan speed | Last set fan speed |
| Airflow up/down | Mode |
| | COOL or DRY Horiz. outlet *1 |
| | HEAT Last setting *2 |
| | FAN Horiz. outlet *1 |

*1 Last setting might be applied depending on the type of the indoor unit.
*2 In case of the last setting is swing, airflow might be Downward 4 depending on the type of the indoor unit.

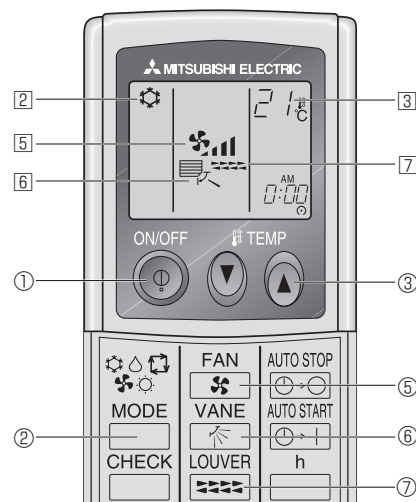

<To Stop Operation>

- Press the ON/OFF button ① again.
- The ON lamp ① and the display area go dark.

Note:

Even if you press the ON/OFF button immediately after shutting down the operation in progress, the air conditioner will not start for about three minutes. This is to prevent the internal components from being damaged.

5. Operation

5.2. Mode select

■ Press the operation mode () button ② and select the operation mode ②.

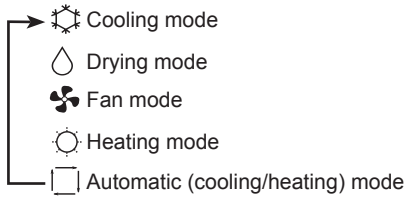

Automatic operation

■ According to a set temperature, cooling operation starts if the room temperature is too hot and heating operation starts if the room temperature is too cold.

■ During automatic operation, if the room temperature changes and remains 1.5 °C or more above the set temperature for 3 minutes, the air conditioner switches to cooling mode. In the same way, if the room temperature remains 1.5°C or more below the set temperature for 3 minutes, the air conditioner switches to heating mode.

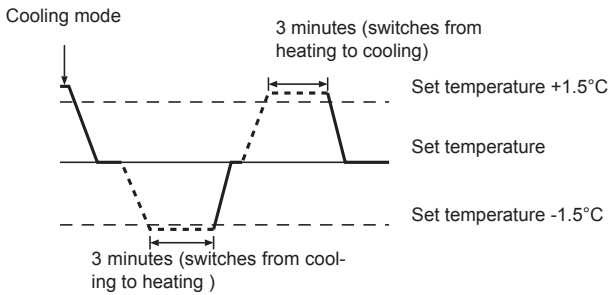

■ Because the room temperature is automatically adjusted in order to maintain a fixed effective temperature, cooling operation is performed a few degrees warmer and heating operation is performed a few degrees cooler than the set room temperature once the temperature is reached (automatic energy-saving operation).

5.3. Temperature setting

► To decrease the room temperature:

Press  button ③ to set the desired temperature. The selected temperature is displayed at ③.

► To increase the room temperature:

Press  button ③ to set the desired temperature. The selected temperature is displayed at ③.

- Available temperature ranges are as follows:
Cooling/Drying: 19 - 30 °C
Heating: 17 - 28 °C
Automatic: 19 - 28 °C
- The display blinks either 8°C - 39°C to inform you if the room temperature is lower or higher than the displayed temperature.

5.4. Fan speed setting

■ Press the Fan Speed button  as many times as necessary while the system is running.

- Each press changes the force. The currently selected speed is shown at ⑤.
- The change sequence, and the available settings are as follows.

| FAN SPEED | Display |
|------------------|--|
| 4-speed + Auto * | Speed 1 → Speed 2 → Speed 3 → Speed 4 → Auto |
| 3-speed + Auto * | Speed 1 → Speed 2 → Speed 3 → Auto |
| 4-speed model | Speed 1 → Speed 2 → Speed 3 → Speed 4 |

* For MA remote controller only.

Automatic fan speed setting is necessary for wireless remote controller.







Note:

- The number of available fan speeds depends on the type of unit connected. Note also that some units do not provide an “Auto” setting.
- In the following cases, the actual fan speed generated by the unit will differ from the speed shown the remote controller display.
 1. While the display is showing “STAND BY” or “DEFROST”.
 2. When the temperature of the heat exchanger is low in the heating mode. (e.g. immediately after heating operation starts)
 3. In HEAT mode, when room temperature is higher than the temperature setting.
 4. When the unit is in DRY mode.

■ Automatic fan speed setting (For wireless remote controller)

It is necessary to set for wireless remote controller only when automatic fan speed is not set at default setting.

It is not necessary to set for wired remote controller with automatic fan speed at default setting.

- ① Press the SET button with something sharp at the end. Operate when display of remote controller is off.  blinks and Model No. is lighted ①.
- ② Press the AUTO STOP  button.  blinks and setting No. is lighted ②. (Setting No.01: without automatic fan speed)
- ③ Press the temp.   buttons to set the setting No.02. (Setting No.02:with automatic fan speed)
If you mistook the operation, press the ON/OFF  button and operate again from procedure ②.
- ④ Press the SET button with something sharp at the end.  and Model No. are lighted for 3 seconds, then turned off.

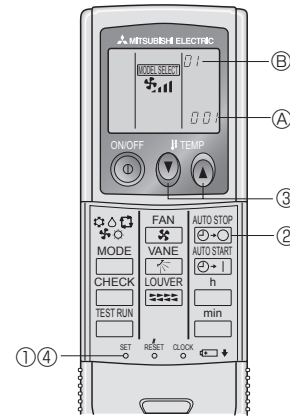

5.5. Airflow direction setting

<To Change the Airflow's Up/Down Direction>

- With the unit running, press the Airflow Up/Down button  as necessary.
 - Each press changes the direction. The current direction is shown at ⑥.
 - The change sequence, and the available settings, are as follows.

| Airflow | Display |
|-------------------------|------------------------|
| 5 steps model*1 | Swing Auto 1 2 3 4 5 |
| 4 steps model (PMFY) | Swing 1 2 3 4 (Horiz.) |
| 4 steps model (PKFY-BM) | 1 2 3 4 (Horiz.) |

* Note that during swing operation, the directional indication on the screen does not change in sync with the directional vanes on the unit.

* Some models do not support directional settings.

*1. For MA remote controller only, other remote controllers display the same as 4steps model.

*2. Airflow direction setting <Auto>

COOL/FAN/DRY : Setting 1 (Horizontal), HEAT : Setting 5 (Downward 5)

5. Operation

Note:

- Available directions depend on the type of unit connected. Note also that some units do not provide an "Auto" setting.
- In the following cases, the actual air direction will differ from the direction indicated on the remote controller display.
 1. While the display is showing "STAND BY" or "DEFROST".
 2. Immediately after starting heater mode (while the system is waiting for the mode change to take effect).
 3. In heat mode, when room temperature is higher than the temperature setting.

(For PFFY-P-VKM series)

- For the PFFY-P-VKM series, the airflow direction displayed on the remote controller is different from the actual airflow direction. Refer to the following table.

| | | | | | |
|---------|----------|---|---|---|------------|
| Display | Swing | 1 | 2 | 3 | 4 |
| | (Horiz.) | | | | |
| Actual | Swing | 1 | 2 | 3 | 4 (Horiz.) |

- The airflow direction for the lower air outlet damper cannot be set. The airflow direction is automatically controlled by a computer.

<[Manual] To Change the Airflow's Left/Right Direction>

- * The louver button ⑦ cannot be used.
 - Stop the unit operation, hold the lever of the louver, and adjust to the desired direction.
 - * Do not set to the inside direction when the unit is in the cooling or drying mode because there is a risk of condensation and water dripping.

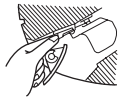

⚠ Caution:

When you operate the process above, be sure to take measures to avoid falls.

5.6. Ventilation

▶ For LOSSNAY combination

5.6.1. For Wired Remote-controller

- To run the ventilator together with the indoor unit:
 - Press the ON/OFF button ①.
 - The Vent indication appears on the screen (at ⑧). The ventilator will now automatically operate whenever the indoor unit is running.
- To run the ventilator only when the indoor unit is off:
 - Press the Ventilation button ⑨ while the indoor unit is off.
 - The On lamp (at ⑩) and the Vent indication (at ⑧) come on.
- To change the ventilator force:
 - Press the Ventilation button ⑨ as necessary.
 - Each press toggles the setting as shown below.



Note:

- With some model configurations, the fan on the indoor unit may come on even when you set the ventilator to run independently.

6. Timer

6.1. For Wired Remote-controller

You can use Function Selection of remote controller to select which of three types of timer to use: ① Weekly timer, ② Simple timer or ③ Auto Off timer.

6.1.1. Weekly Timer

- The weekly timer can be used to set up to eight operations for each day of the week.
 - Each operation may consist of any of the following: ON/OFF time together with a temperature setting, or ON/OFF time only, or temperature setting only.
 - When the current time reaches a time set at this timer, the air conditioner carries out the action set by the timer.
- Time setting resolution for this timer is 1 minute.

Note:

1. Weekly Timer/Simple Timer/Auto Off Timer cannot be used at the same time.
2. The weekly timer will not operate when any of the following conditions is in effect.
 - The timer feature is off; the system is in a malfunction state; a test run is in progress; the remote controller is undergoing self-check or remote controller check; the user is in the process of setting a function; the user is in the process of setting the timer; the user is in the process of setting the current day of the week or time; the system is under central control. (Specifically, the system will not carry out operations (unit on, unit off, or temperature setting) that are prohibited during these conditions.)

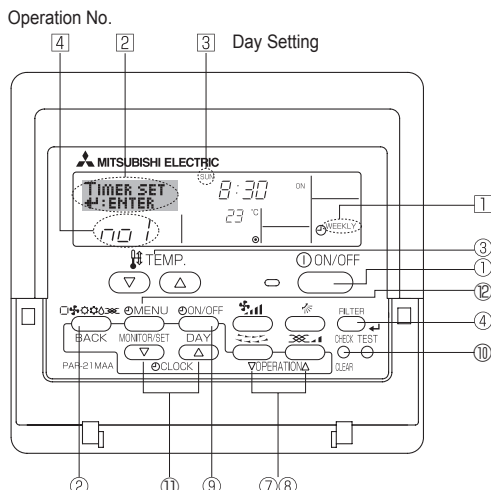

<How to Set the Weekly Timer>

1. Be sure that you are at a standard control screen, and that the weekly timer indicator ① is shown in the display.
2. Press the Timer Menu button ②, so that the "Set Up" appears on the screen (at ②). (Note that each press of the button toggles the display between "Set Up" and "Monitor".)
3. Press the Timer On/Off (Set Day) button ③ to set the day. Each press advances the display at ③ to the next setting, in the following sequence: "Sun Mon Tues Wed Thurs Fri Sat" → "Sun" → ... → "Fri" → "Sat" → "Sun Mon Tues Wed Thurs Fri Sat"...
4. Press the ∇ or ∆ Operation button (⑦ or ⑧) as necessary to select the appropriate operation number (1 to 8) ④.
 - * Your inputs at Steps 3 and 4 will select one of the cells from the matrix illustrated below.
 - (The remote-controller display at left shows how the display would appear when setting Operation 1 for Sunday to the values indicated below.)

Setup Matrix

| Op No. | Sunday | Monday | ... | Saturday |
|--------|--------------------------|------------------|------------------|------------------|
| No. 1 | • 8:30 • ON • 23°C | | | |
| No. 2 | • 10:00 • OFF | • 10:00 • OFF | • 10:00 • OFF | • 10:00 • OFF |
| ... | | | | |
| No. 8 | | | | |

<Operation 1 settings for Sunday>
Start the air conditioner at 8:30, with the temperature set to 23°C

<Operation 2 settings for every day>
Turn off the air conditioner at 10:00.

Note:

By setting the day to "Sun Mon Tues Wed Thurs Fri Sat", you can set the same operation to be carried out at the same time every day. (Example: Operation 2 above, which is the same for all days of the week.)

Shows the time setting ⑤ ⑥ Shows the selected operation (ON or OFF)
* Does not appear if operation is not set.

Shows the temperature setting ⑦
* Does not appear if temperature is not set.

6. Timer

<Setting the Weekly Timer>

- Press the appropriate Set Time button ① as necessary to set the desired time (at ⑤).
 - * As you hold the button down, the time first increments in minute intervals, then in ten-minute intervals, and then in one-hour intervals.
- Press the ON/OFF button ① to select the desired operation (ON or OFF) at ⑥.
 - * Each press changes the next setting, in the following sequence: No display (no setting) → "ON" → "OFF"
- Press the appropriate Set Temperature button ③ to set the desired temperature (at ⑦).
 - * Each press changes the setting, in the following sequence: No display (no setting) ⇔ 24 ⇔ 25 ⇔ ... ⇔ 29 ⇔ 30 ⇔ 12 ⇔ ... ⇔ 23 ⇔ No display.
(Available range: The range for the setting is 12°C to 30°C. The actual range over which the temperature can be controlled, however, will vary according to the type of the connected unit.)
- After making the appropriate settings at Steps 5, 6 and 7, press the Filter ← button ④ to lock in the values.
 - To clear the currently set values for the selected operation, press and quickly release the Check (Clear) button ⑩ once.
 - * The displayed time setting will change to "—:—", and the On/Off and temperature settings will all disappear.
(To clear all weekly timer settings at once, hold down the Check (Clear) button ⑩ for two seconds or more. The display will begin blinking, indicating that all settings have been cleared.)

Note:

Your new entries will be cancelled if you press the Mode (Return) button ② before pressing the Filter ← button ④. If you have set two or more different operations for exactly the same time, only the operation with the highest Operation No. will be carried out.

- Repeat Steps 3 to 8 as necessary to fill as many of the available cells as you wish.
- Press the mode (Return) button ② to return to the standard control screen and complete the setting procedure.
- To activate the timer, press the Timer On/Off button ⑨, so that the "Timer Off" indication disappears from the screen. **Be sure that the "Timer Off" indication is no longer displayed.**
 - * If there are no timer settings, the "Timer Off" indication will blink on the screen.

<How to View the Weekly Timer Settings>

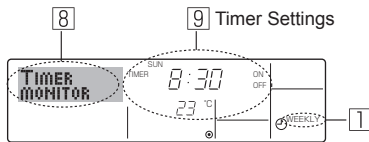

- Be sure that the weekly timer indicator is visible on the screen (at ⑧).
- Press the Timer Menu button ② so that "Monitor" is indicated on the screen (at ⑧).
- Press the Timer On/Off (Set Day) button ⑨ as necessary to select the day you wish to view.
- Press the ∇ or ∆ Operation button (⑦ or ⑧) as necessary to change the timer operation shown on the display (at ⑨).
 - * Each press will advance to the next timer operation, in order of time setting.
- To close the monitor and return to the standard control screen, press the Mode (Return) button ②.

<To Turn Off the Weekly Timer>

Press the Timer On/Off button ⑨ so that "Timer Off" appears at ⑩.

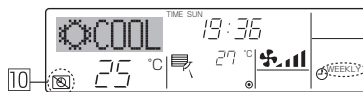

<To Turn On the Weekly Timer>

Press the Timer On/Off button ⑨ so that the "Timer Off" indication (at ⑩) goes dark.

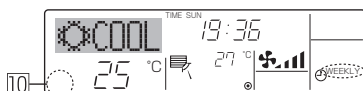

6.1.2. Simple Timer

You can set the simple timer in any of three ways.

- Start time only:
The air conditioner starts when the set time has elapsed.
 - Stop time only:
The air conditioner stops when the set time has elapsed.
 - Start & stop times:
The air conditioner starts and stops at the respective elapsed times.
- The simple timer (start and stop) can be set only once within a 72-hour period.
The time setting is made in hour increments.

Note:

*1. Weekly Timer/Simple Timer/Auto Off Timer cannot be used at the same time.

*2. The simple timer will not operate when any of the following conditions is in effect.

The timer is off; the system is in malfunction state; a test run is in progress; the remote controller is undergoing self-check or remote controller check; the user is in the process of selecting a function; the user is in the process of setting the timer; the system is under central control. (Under these conditions, On/Off operation is prohibited.)

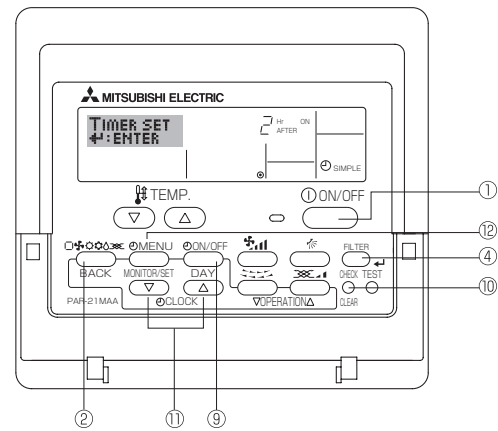

<How to Set the Simple Timer>

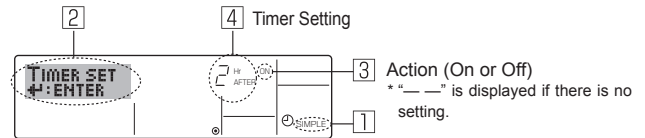

- Be sure that you are at a standard control screen, and that the simple timer indicator is visible in the display (at ①).
When something other than the Simple Timer is displayed, set it to SIMPLE TIMER using the function selection of remote controller (see 8.[4]-3 (3) timer function setting).
- Press the Timer Menu button ②, so that the "Set Up" appears on the screen (at ②). (Note that each press of the button toggles the display between "Set Up" and "Monitor".)
- Press the ON/OFF button ① to display the current ON or OFF simple timer setting. Press the button once to display the time remaining to ON, and then again to display the time remaining to OFF. (The ON/OFF indication appears at ③).
 - "ON" timer:
The air conditioner will start operation when the specified number of hours has elapsed.
 - "OFF" timer:
The air conditioner will stop operation when the specified number of hours has elapsed.
- With "ON" or "OFF" showing at ③: Press the appropriate Set Time button ① as necessary to set the hours to ON (if "ON" is displayed) or the hours to OFF (if "OFF" is displayed) at ④.
 - Available Range: 1 to 72 hours
- To set both the ON and OFF times, repeat Steps 3 and 4.
 - * Note that ON and OFF times cannot be set to the same value.
- To clear the current ON or OFF setting: Display the ON or OFF setting (see step 3) and then press the Check (Clear) button ⑩ so that the time setting clears to "—" at ④. (If you want to use only an ON setting or only an OFF setting, be sure that the setting you do not wish to use is shown as "—".)

6. Timer

7. After completing steps 3 to 6 above, press the Filter \leftarrow button ④ to lock in the value.

Note:

Your new settings will be cancelled if you press the Mode (Return) button ② before pressing the Filter \leftarrow button ④.

8. Press the Mode (Return) button ② to return to the standard control screen.

9. Press the Timer On/Off button ⑨ to start the timer countdown. When the timer is running, the timer value is visible on the display. **Be sure that the timer value is visible and appropriate.**

<Viewing the Current Simple Timer Settings>

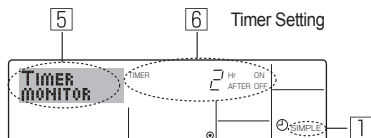

1. Be sure that the simple timer indicator is visible on the screen (at ①).
2. Press the Timer Menu button ②, so that the "Monitor" appears on the screen (at ⑤).
 - If the ON or OFF simple timer is running, the current timer value will appear at ⑥.
 - If ON and OFF values have both been set, the two values appear alternately.
3. Press the Mode (Return) button ② to close the monitor display and return to the standard control screen.

<To Turn Off the Simple Timer>

Press the Timer On/Off button ⑨ so that the timer setting no longer appears on the screen (at ⑦).

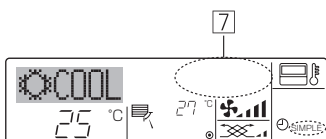

<To Turn On the Simple Timer>

Press the Timer On/Off button ⑨ so that the timer setting becomes visible at ⑦.

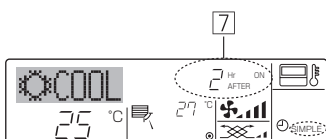

Examples

If ON and OFF times have both been set at the simple timer, operation and display are as indicated below.

Example 1:

Start the timer with ON time set earlier than OFF time

ON Setting : 3 hours

OFF Setting : 7 hours

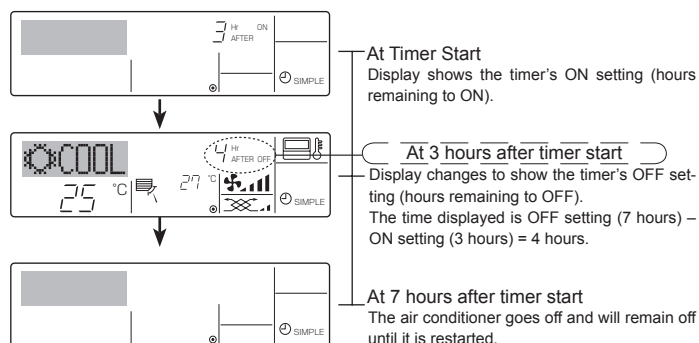

Example 2:

Start the timer with OFF time set earlier than ON time

ON Setting : 5 hours

OFF Setting: 2 hours

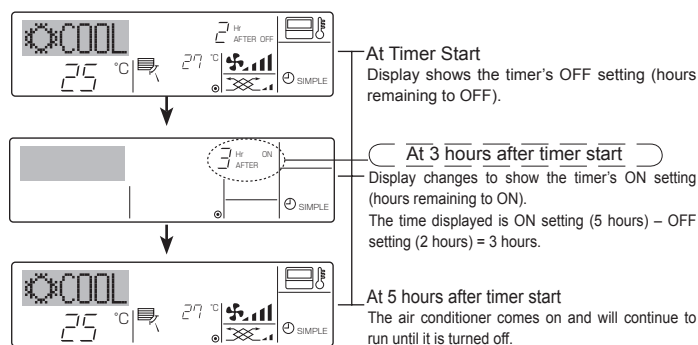

6.1.3. Auto Off Timer

■ This timer begins countdown when the air conditioner starts and shuts the air conditioner off when the set time has elapsed.

■ Available settings run from 30 minutes to 4 hours in 30-minute intervals.

Note:

*1. Weekly Timer/Simple Timer/Auto Off Timer cannot be used at the same time.

*2. The Auto Off timer will not operate when any of the following conditions is in effect.

The timer is off; the system is in malfunction state; a test run is in progress; the remote controller is undergoing self-check or remote controller check; the user is in the process of selecting a function; the user is in the process of setting the timer; the system is under central control. (Under these conditions, On/Off operation is prohibited.)

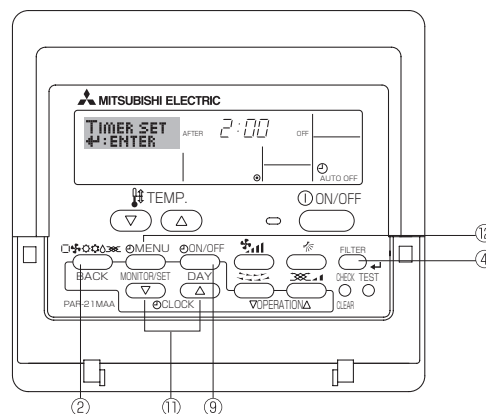

<How to Set the Auto Off Timer>

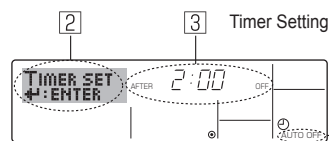

1. Be sure that you are at a standard control screen, and that the Auto Off timer indicator is visible in the display (at ①). When something other than the Auto Off Timer is displayed, set it to AUTO OFF TIMER using the function selection of remote controller (see 8.[4]-3 (3)) timer function setting.
2. Hold down the Timer Menu button ② for 3 seconds so that the "Set Up" appears on the screen (at ②). (Note that each press of the button toggles the display between "Set Up" and "Monitor".)
3. Press the appropriate Set Time button ⑪ as necessary to set the OFF time (at ③).
4. Press the Filter \leftarrow button ④ to lock in the setting.

Note:

Your entry will be cancelled if you press the Mode (Return) button ② before pressing the Filter \leftarrow button ④.

5. Press the Mode (Return) button ② to complete the setting procedure and return to the standard control screen.

6. If the air conditioner is already running, the timer starts countdown immediately. **Be sure to check that the timer setting appears correctly on the display.**

6. Timer

<Checking the Current Auto Off Timer Setting>

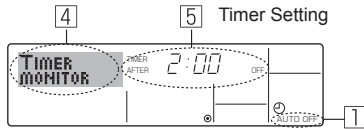

1. Be sure that the "Auto Off" is visible on the screen (at ①).
2. Hold down the Timer Menu button ② for **3 seconds** so that "Monitor" is indicated on the screen (at ④).
 - The timer remaining to shutdown appears at ⑤.
3. To close the monitor and return to the standard control screen, press the Mode (Return) button ②.

<To Turn Off the Auto Off Timer>

- Hold down the Timer On/Off button ③ for **3 seconds** so that "Timer Off" appears (at ⑥) and the timer value (at ⑦) disappears.

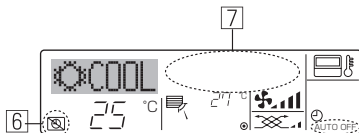

- Alternatively, turn off the air conditioner itself. The timer value (at ⑦) will disappear from the screen.

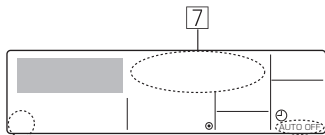

<To Turn On the Auto Off Timer>

- Hold down the Timer On/Off button ③ for **3 seconds**. The "Timer Off" indication disappears (at ⑥), and the timer setting comes on the display (at ⑦).
- Alternatively, turn on the air conditioner. The timer value will appear at ⑦.

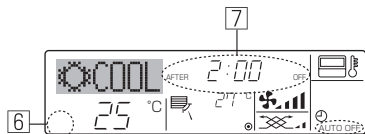

7. Other Functions

7.1. Locking the Remote Controller Buttons (Operation function limit controller)

- If you wish, you can lock the remote controller buttons. You can use the Function Selection of remote controller to select which type of lock to use. (For information about selecting the lock type, see section 8, item [4]-2 (1)).

Specifically, you can use either of the following two lock types.

- ① Lock All Buttons:
Locks all of the buttons on the remote controller.
- ② Lock All Except ON/OFF:
Locks all buttons other than the ON/OFF button.

Note:

The "Locked" indicator appears on the screen to indicate that buttons are currently locked.

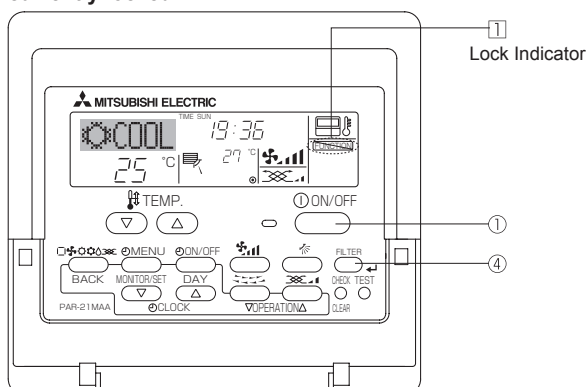

6.2. For Wireless Remote-controller

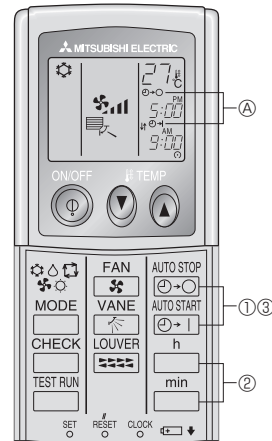

- ① Press the or button (TIMER SET).

- Time can be set while the following symbol is blinking.
OFF timer : is blinking.
ON timer : is blinking.

- ② Use the and buttons to set the desired time.

- ③ Canceling the timer.

To cancel the OFF timer, press the button.

To cancel the ON timer, press the button.

- It is possible to combine both OFF and ON timers.
- Pressing the ① ON/OFF button of the remote controller during timer mode to stop the unit will cancel the timers.
- If the current time has not been set, the timer operation cannot be used.

<How to Lock the Buttons>

1. While holding down the Filter button ④, press and hold down the ON/OFF button ① for 2 seconds. The "Locked" indication appears on the screen (at ①), indicating that the lock is now engaged.

- * If locking has been disabled in Function Selection of remote controller, the screen will display the "Not Available" message when you press the buttons as described above.

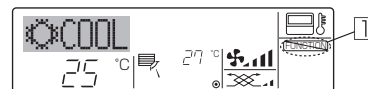

- If you press a locked button, the "Locked" indication (at ①) will blink on the display.

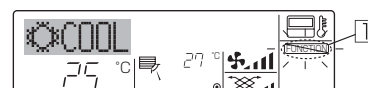

<How to Unlock the Buttons>

1. While holding down the Filter button ④, press and hold down the ON/OFF button ① for 2 seconds—so that the "Locked" indication disappears from the screen (at ①).



7. Other Functions

7.2. Error Codes indication

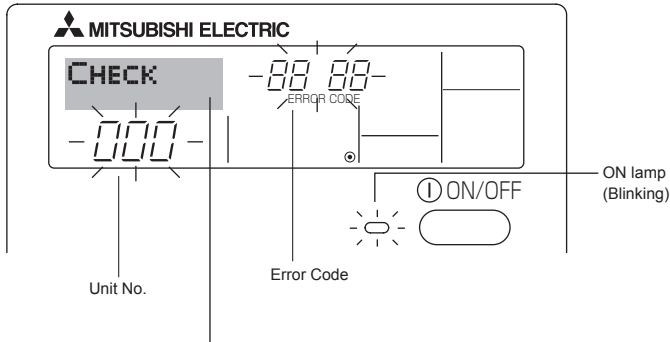

If you have entered contact number to be called in the event of a problem, the screen displays this number.
(You can set this up under Function Selection of remote controller. For information, refer to section 8.)

- If the ON lamp and error code are both blinking: This means that the air conditioner is out of order and operation has been stopped (and cannot resume). Take note of the indicated unit number and error code, then switch off the power to the air conditioner and call your dealer or servicer.

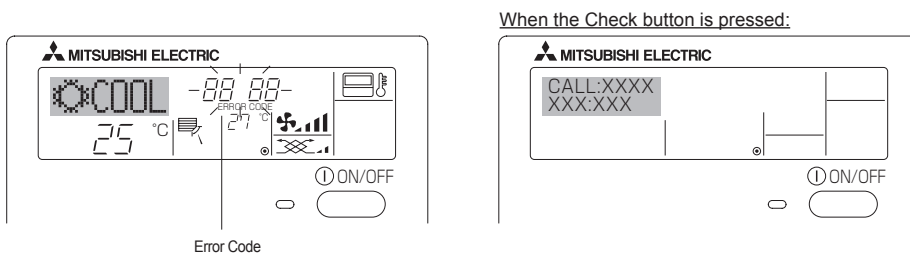

- If only the error code is blinking (while the ON lamp remains lit): Operation is continuing, but there may be a problem with the system. In this case, you should note down the error code and then call your dealer or servicer for advice.

* If you have entered contact number to be called in the event of a problem, push the Check button to display it on the screen. (You can set this up under Function Selection of remote controller. For information, refer to section 8.)

8. Function Selection

Function selection of remote controller

The setting of the following remote controller functions can be changed using the remote controller function selection mode. Change the setting when needed.

| Item 1 | Item 2 | Item 3 (Setting content) |
|--|--|---|
| 1. Change Language ("CHANGE LANGUAGE") | Language setting to display | <ul style="list-style-type: none"> • Display in multiple languages is possible |
| 2. Function limit ("FUNCTION SELECTION") | (1) Operation function limit setting (operation lock) ("LOCKING FUNCTION") | <ul style="list-style-type: none"> • Setting the range of operation limit (operation lock) |
| | (2) Use of automatic mode setting ("SELECT AUTO MODE") | <ul style="list-style-type: none"> • Setting the use or non-use of "automatic" operation mode |
| | (3) Temperature range limit setting ("LIMIT TEMP FUNCTION") | <ul style="list-style-type: none"> • Setting the temperature adjustable range (maximum, minimum) |
| 3. Mode selection ("MODE SELECTION") | (1) Remote controller main/sub setting ("CONTROLLER MAIN/SUB") | <ul style="list-style-type: none"> • Selecting main or sub remote controller * When two remote controllers are connected to one group, one controller must be set to sub. |
| | (2) Use of clock setting ("CLOCK") | <ul style="list-style-type: none"> • Setting the use or non-use of clock function |
| | (3) Timer function setting ("WEEKLY TIMER") | <ul style="list-style-type: none"> • Setting the timer type |
| | (4) Contact number setting for error situation ("CALL.") | <ul style="list-style-type: none"> • Contact number display in case of error • Setting the telephone number |
| 4. Display change ("DISP MODE SETTING") | (1) Temperature display °C/°F setting ("TEMP MODE °C/°F") | <ul style="list-style-type: none"> • Setting the temperature unit (°C or °F) to display |
| | (2) Suction air temperature display setting ("ROOM TEMP DISP SELECT") | <ul style="list-style-type: none"> • Setting the use or non-use of the display of indoor (suction) air temperature |
| | (3) Automatic cooling/heating display setting ("AUTO MODE DISP C/H") | <ul style="list-style-type: none"> • Setting the use or non-use of the display of "Cooling" or "Heating" display during operation with automatic mode |

8. Function Selection

[Function selection flowchart]
Setting language (English)

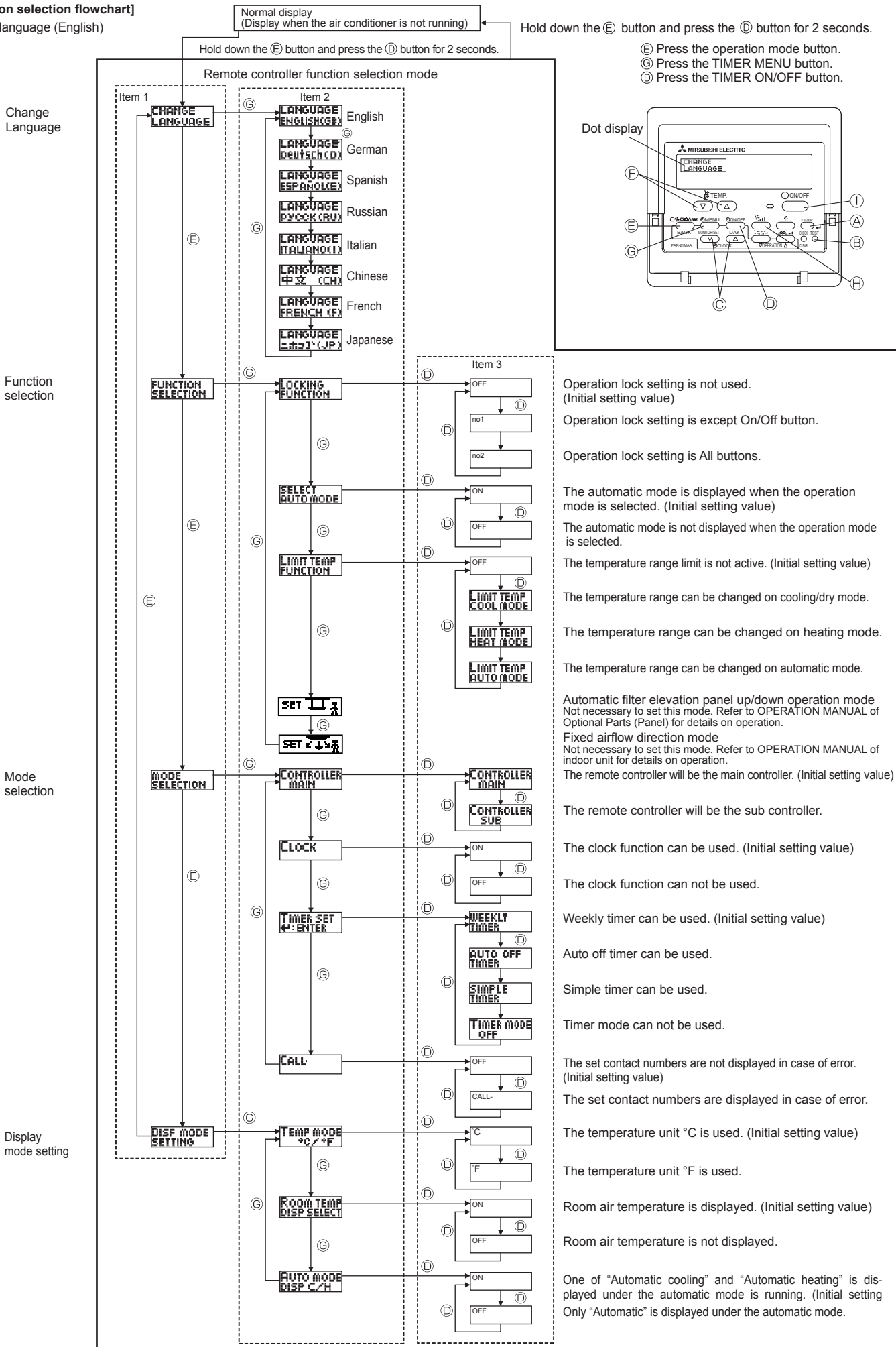

8. Function Selection

[Detailed setting]

[4]-1. CHANGE LANGUAGE setting

The language that appears on the dot display can be selected.

- Press the [MENU] button ③ to change the language.
 - ① English (GB), ② German (D), ③ Spanish (E), ④ Russian (RU),
 - ⑤ Italian (I), ⑥ Chinese (CH), ⑦ French (F), ⑧ Japanese (JP)

Refer to the dot display table.

[4]-2. Function limit

(1) Operation function limit setting (operation lock)

- To switch the setting, press the [ON/OFF] button ①.
 - ① no1 :Operation lock setting is made on all buttons other than the [ON/OFF] button.
 - ② no2 :Operation lock setting is made on all buttons.
 - ③ OFF (Initial setting value): Operation lock setting is not made.
- * To make the operation lock setting valid on the normal screen, it is necessary to press buttons (Press and hold down the [FILTER] and [ON/OFF] buttons at the same time for two seconds.) on the normal screen after the above setting is made.

(2) Use of automatic mode setting

When the remote controller is connected to the unit that has automatic operation mode, the following settings can be made.

- To switch the setting, press the [ON/OFF] button ①.
 - ① ON (Initial setting value):
The automatic mode is displayed when the operation mode is selected.
 - ② OFF:
The automatic mode is not displayed when the operation mode is selected.

(3) Temperature range limit setting

After this setting is made, the temperature can be changed within the set range.

- To switch the setting, press the [ON/OFF] button ①.
 - ① LIMIT TEMP COOL MODE:
The temperature range can be changed on cooling/dry mode.
 - ② LIMIT TEMP HEAT MODE:
The temperature range can be changed on heating mode.
 - ③ LIMIT TEMP AUTO MODE:
The temperature range can be changed on automatic mode.
 - ④ OFF (initial setting): The temperature range limit is not active.
- * When the setting, other than OFF, is made, the temperature range limit setting on cooling, heating and automatic mode is made at the same time. However, the range cannot be limited when the set temperature range has not changed.

- To increase or decrease the temperature, press the [TEMP. (▽) or (△)] button ②.
- To switch the upper limit setting and the lower limit setting, press the [TEMP.] button ③. The selected setting will blink and the temperature can be set.

- Settable range

Cooling/Dry mode:

Lower limit:19°C - 30°C Upper limit:30°C - 19°C

Heating mode:

Lower limit:17°C - 28°C Upper limit:28°C - 17°C

Automatic mode:

Lower limit:19°C - 28°C Upper limit:28°C - 19°C

[4]-3. Mode selection setting

(1) Remote controller main/sub setting

- To switch the setting, press the [ON/OFF] button ①.
 - ① Main: The controller will be the main controller.
 - ② Sub: The controller will be the sub controller.

(2) Use of clock setting

- To switch the setting, press the [ON/OFF] button ①.
 - ① ON: The clock function can be used.
 - ② OFF: The clock function cannot be used.

(3) Timer function setting

- To switch the setting, press the [ON/OFF] button ①.(Choose one of the following.).
 - ① WEEKLY TIMER (initial setting value):
The weekly timer can be used.
 - ② AUTO OFF TIMER:
The auto off timer can be used.
 - ③ SIMPLE TIMER:
The simple timer can be used.
 - ④ TIMER MODE OFF:
The timer mode cannot be used.
- * When the use of clock setting is OFF, the "WEEKLY TIMER" cannot be used.

(4) Contact number setting for error situation

- To switch the setting, press the [ON/OFF] button ①.
 - ① CALL OFF:
The set contact numbers are not displayed in case of error.
 - ② CALL **** *
The set contact numbers are displayed in case of error.
CALL :
The contact number can be set when the display is as shown above.
- Setting the contact numbers
To set the contact numbers, follow the following procedures.
Move the blinking cursor to set numbers. Press the [TEMP. (▽) and (△)] button ② to move the cursor to the right (left). Press the [CLOCK (▽) and (△)] button ③ to set the numbers.

[4]-4. Display change setting

(1) Temperature display °C/°F setting

- To switch the setting, press the [ON/OFF] button ①.
 - ① °C: The temperature unit °C is used.
 - ② °F: The temperature unit °F is used.

(2) Room air temperature display setting

- To switch the setting, press the [ON/OFF] button ①.
 - ① ON : The room air temperature is displayed.
 - ② OFF: The room air temperature is not displayed.

(3) Automatic cooling/heating display setting

- To switch the setting, press the [ON/OFF] button ①.
 - ① ON:
One of "Automatic cooling" and "Automatic heating" is displayed under the automatic mode is running.
 - ② OFF:
Only "Automatic" is displayed under the automatic mode.

8. Function Selection

[Dot display table]

| Selecting language | English | German | Spanish | Russian | Italian | Chinese | French | Japanese | |
|-------------------------|------------------------|-----------------------|----------------------|----------------------|---------------------------|--------------|------------------------|---------------|-----|
| Waiting for start-up | PLEASE WAIT | ← | ← | ← | ← | ← | ← | ← | |
| Operation mode | Cool | COOL | Kühlen | FRÍO | Холод | COOL | 制冷 | FROID | 冷房 |
| | Dry | DRY | Trocknen | DESHUMIDIFICACIÓN | Сушка | DRY | 除湿 | DESHU | ドライ |
| | Heat | HEAT | Heizen | CALOR | Тепло | HEAT | 制热 | CHAUD | 暖房 |
| | Auto | AUTO | AUTO | AUTOMÁTICO | Авто | AUTO | 自动 | AUTO | 自動 |
| | Auto(Cool) | COOL | Kühlen | FRÍO | Холод | COOL | 制冷 | FROID | 冷房 |
| | Auto(Heat) | HEAT | Heizen | CALOR | Тепло | HEAT | 制热 | CHAUD | 暖房 |
| | Fan | FAN | Lüfter | VENTILACIÓN | Вент | VENTILAZIONE | 送风 | VENTILATION | 送風 |
| | Ventilation | VENTILATION | Gebälsebetrieb | VENTILACIÓN | Вентиляция | ARIA ESTERNA | 换气 | VENTILATION | 換気 |
| | Stand by (Hot adjust) | STAND BY | STAND BY | CALENTANDO | ОБОГРЕВ: ПАУЗА | STAND BY | 准备中 | PRE CHAUFFAGE | 準備中 |
| Defrost | DEFROST | Abtauen | DESCONGE-LACIÓN | ОТТАВЛИВАНИЕ | SERINAMENTO | 除霜中 | DEGIVRAGE | 霜取中 | |
| Set temperature | SET TEMP | TEMP einstellen | TEMP. CONSIGNA | ЦЕЛЕВАЯ ТЕМПЕРАТУРА | IMPOSTAZIONE TEMPERATURA | 设定温度 | REGLAGE TEMPERATURE | 設定温度 | |
| Fan speed | FAN SPEED | Lüftergeschwindigkeit | VELOCIDAD VENTILADOR | СКОРОСТЬ ВЕНТИЛЯТОРА | VELOCITA' VENTILATORE | 风速 | VITESSE DE VENTILATION | 風速 | |
| Not use button | NOT AVAILABLE | Nicht verfügbar | NO DISPONIBLE | НЕ ДОСТУПНО | NON DISPONIBILE | 无效按钮 | NON DISPONIBLE | 無効ボタン | |
| Check (Error) | CHECK | Prüfen | COMPROBAR | ПРОВЕРКА | CHECK | 検査 | CONTROLE | 点検 | |
| Test run | TEST RUN | Testbetrieb | TEST FUNCIONAMIENTO | ТЕСТОВЫЙ ЗАПУСК | TEST RUN | 试运行 | TEST | 試運転 | |
| Self check | SELF CHECK | Selbst-diagnose | AUTO REVISIÓN | САМОДИАГНОСТИКА | SELF CHECK | 自我诊断 | AUTO CONTROLE | 自己診断 | |
| Unit function selection | FUNCTION SELECTION | Funktion auswählen | SELECCIÓN DE FUNCIÓN | ВЫБОР ФУНКЦИИ | SELEZIONE FUNZIONI | 功能选择 | SELECTION FONCTIONS | メニュー選択 | |
| Setting of ventilation | SETTING OF VENTILATION | Lüftestufen wählen | CONFIG. VENTILACIÓN | НАСТРОЙКА ВЕНТУСТАНА | IMPOSTAZIONE ARIA ESTERNA | 换气设定 | SELECTION VENTILATION | 換気設定 | |

| Selecting language | English | German | Spanish | Russian | Italian | Chinese | French | Japanese |
|---|-----------------------|------------------------------|----------------------------|--------------------------|---------------------------|---------------|--------------------------|-------------------|
| CHANGE LANGUAGE | CHANGE LANGUAGE | ← | ← | ← | ← | ← | ← | ← |
| Function selection | FUNCTION SELECTION | Funktion auswählen | SELECCIÓN DE FUNCIONES | ВЫБОР ФУНКЦИИ | SELEZIONE FUNZIONI | 功能限制 | SELECTION FONCTIONS | メニュー制限 |
| Operation function limit setting | LOCKING FUNCTION | Sperre - Funktion | FUNCION BLOQUEADA | ФУНКЦИЯ БЛОКИРОВКИ | BLOCCO FUNZIONI | 操作限制 | BLOCAGE FONCTIONS | 操作ロック |
| Use of automatic mode setting | SELECT AUTO MODE | Auswahl Autobetrieb | SELECCIÓN MODO AUTO | ВЫБОР РЕЖИМА АВТО | SELEZIONE MODO AUTO | 自动模式 | SELECTION DU MODO AUTO | 自動モード |
| Temperature range limit setting | LIMIT TEMP FUNCTION | Limit Temp Funktion | LIMIT TEMP CONSIGNA | ОГРАНИЧЕНИЕ УСТ.ТЕМПЕРАТ | LIMITAZIONE TEMPERATURA | 温度限制 | LIMITATION TEMPERATURE | 温度制限 |
| Limit temperature cooling/day mode | LIMIT TEMP COOL MODE | Limit Kühl Temp | LIMIT TEMP MODO FRIG | ОГРАНИЧЕНО ОХЛАЖДЕНИЕ | LIMITAZIONE MODO COOL | 制冷范围 | LIMITE TEMP MODO FROID | 制冷房 |
| Limit temperature heating mode | LIMIT TEMP HEAT MODE | Limit Heiz Temp | LIMIT TEMP MODO CALOR | ОГРАНИЧЕН ОБОГРЕВ | LIMITAZIONE MODO HEAT | 制热范围 | LIMITE TEMP MODO CHAUD | 制热房 |
| Limit temperature auto mode | LIMIT TEMP AUTO MODE | Limit Auto Temp | LIMIT TEMP MODO AUTO | ОГРАНИЧЕН РЕЖИМ АВТО | LIMITAZIONE MODO AUTO | 自动范围 | LIMITE TEMP MODO AUTO | 制自动 |
| Mode selection | MODE SELECTION | Betriebsart wählen | SELECCIÓN DE MODO | ВЫБОР РЕЖИМА | SELEZIONE MODO | 基本模式 | SELECTION DU MODE | 基本メニュー |
| Remote controller setting MAIN | CONTROLLER MAIN | Haupt Controller | CONTROL PRINCIPAL | Основной пульт | CONTROLLO MAIN | 遥控主 | TELCOMMANDE Maitre | リモコン 主側 |
| Remote controller setting SUB | CONTROLLER SUB | Neben Controller | CONTROL SECUNDARIO | Дополнительный пульт | CONTROLLO SUB | 遥控辅 | TELCOMMANDE ESCLAVE | リモコン 主側 |
| Use of clock setting | CLOCK | Uhr | RELOJ | Часы | OROLOGIO | 时钟 | AFFICHAGE HORLOGE | 時計 ショウ |
| Setting the day of the week and time | TIME SET +/-:ENTER | Uhr stellen +/-:einstellen | CONFIG RELOJ +/-:CONFIG | ЧАСЫ:УСТ. +/-:ВВОД | OROLOGIO +/-:ENTER | 时间 +/-:ENTER | HORLOGE +/-:ENTRER | トイセツテイ +/-:カブテイ |
| Timer set | TIMER SET +/-:ENTER | Zeitschaltuhr +/-:einstellen | TEMPORIZA - DOR +/-:CONFIG | ТАЙМЕР:УСТ. +/-:ВВОД | TIMER +/-:ENTER | 定时器 +/-:ENTER | PROG HORAIRES +/-:ENTRER | タイマーセツテイ +/-:カブテイ |
| Timer monitor | TIMER MONITOR | Uhrzeit Anzeige | VISUALIZAR TEMPORIZAD. | ПРОСМОТР ТАЙМЕРА | VISUALIZ TIMER | 定时器状态 | AFFICHAGE PROG HORAIRES | タイマーモニター |
| Weekly timer | WEEKLY TIMER | Wochenzeit schalt Uhr | TEMPORIZA - DOR SEMANAL | НЕДЕЛЬНЫЙ ТАЙМЕР | TIMER SETTIMANALE | 每周定时器 | PROG HEBDO MADAIRE | タイマー 週間 |
| Timer mode off | TIMER MODE OFF | Zeitschaltuhr AUS | TEMPORIZA - DOR APAGADO | ТАЙМЕР ВЫКЛ. | TIMER OFF | 定时器无效 | PROG HORAIRES INACTIF | タイマー 無効 |
| Auto off timer | AUTO OFF TIMER | Auto Zeit funktion AUS | APAGADO AUTOMÁTICO | АВТООТКЛЮЧ. ПО ТАЙМЕРУ | AUTO OFF TIMER | 解除定时 | PROG HORAIRES ARRET AUTO | タイマー-クワッスル ホウウ |
| Simple timer | SIMPLE TIMER | Einfache Zeitfunktion | TEMPORIZA - DOR SIMPLE | ПРОСТОЙ ТАЙМЕР | TIMER SEMPLIFICATO | 简易定时器 | PROG HORAIRES SIMPLIFIE | タイマー-カンイ |
| Contact number setting of error situation | CALL | ← | ← | ← | ← | ← | ← | ← |
| Display change | DISP MODE SETTING | Anzeige Betriebsart | MOSTRAR MODO | НАСТРОЙКА ИЛИ РЕЖИМА | IMPOSTAZIONE MODO DISPLAY | 转换表示 | AFFICHAGE SOUS MENU | 表示切替 |
| Temperature display °C/°F setting | TEMP MODE °C/°F | Wechsel °C/°F | TEMP GRADOS °C/°F | КАНН.ТЕМП. °C/°F | TEMPERATURA °C/°F | 温度 °C/°F | TEMPERATURE °C/°F | 温度 °C/°F |
| Room air temperature display setting | ROOM TEMP DISP SELECT | Raum Temp gewährit | MOSTRAR TEMP. | ПОКАЗЫВАТЬ ТЕМП.В КОМ. | TEMPERATURA AMBIENTE | 吸入温度 | TEMPERATURE AMBIANTE | スィコモット 温度 |
| Automatic cooling/heating display setting | AUTO MODE DISP C/H | Auto Betrieb C/H | MOSTRAR F/C EN AUTO | ИЛИ Т/Х В РЕЖИМЕ АВТО | AUTO C/H | 自动表示 | AFFICHAGE AUTO F/C | 自動表示 |

9. Emergency Operation for Wireless Remote-controller

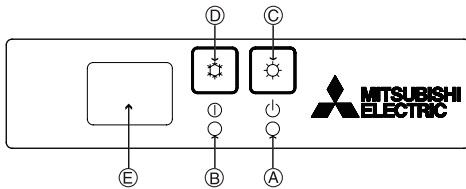

(For PKFY-P-VHM-E)

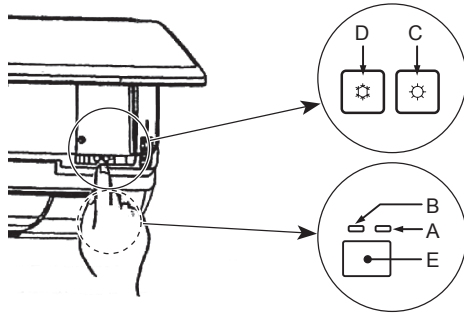

When the remote-controller cannot be used

When the batteries of the remote controller run out or the remote controller malfunctions, the emergency operation can be done using the emergency buttons.

- Ⓐ DEFROST/STAND BY lamp
- Ⓑ Operation lamp
- Ⓒ Emergency operation switch (heating)
- Ⓓ Emergency operation switch (cooling)
- Ⓔ Receiver

Starting operation

- To operate the cooling mode, press the Ⓓ button for more than 2 seconds.
- To operate the heating mode, press the Ⓒ button for more than 2 seconds.

Note:

- Details of emergency mode are as shown below.
- Details of EMERGENCY MODE are as shown below.

| Operation mode | COOL | HEAT |
|-------------------|------------|----------------|
| Set temperature | 24°C | 24°C |
| Fan speed | High | High |
| Airflow direction | Horizontal | Downward 4 (5) |

Stopping operation

- To stop operation, press the Ⓓ button or the Ⓒ button for more than 2 seconds.

10. Care and Cleaning

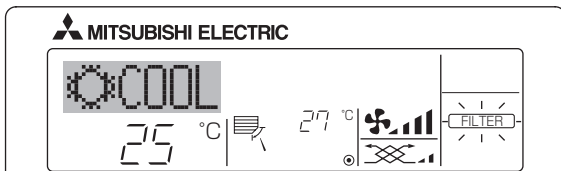

- Indicates that the filter needs cleaning.
Clean the filter.

- When resetting "FILTER" display
When the [FILTER] button is pressed two times successively after cleaning the filter, the display goes off and is reset.

Note:

- When 2 or more different types of indoor unit are controlled, the cleaning period differs with the type of filter. When the master unit cleaning period arrives, "FILTER" is displayed. When the filter display goes off, the cumulative time is reset.
- "FILTER" indicates the cleaning period when the air conditioner was used under general indoor air conditions by criteria time. Since the degree of dirtiness depends on the environmental conditions, clean the filter accordingly.
- The filter cleaning period cumulative time differs with the model.
- This indication is not available for wireless remote controller.

▶ Cleaning the filters

- Clean the filters using a vacuum cleaner. If you do not have a vacuum cleaner, tap the filters against a solid object to knock off dirt and dust.
- If the filters are especially dirty, wash them in lukewarm water. Take care to rinse off any detergent thoroughly and allow the filters to dry completely before putting them back into the unit.

⚠ Caution:

- Do not dry the filters in direct sunlight or by using a heat source, such as an electric heater: this may warp them.
- Do not wash the filters in hot water (above 50°C), as this may warp them.
- Make sure that the air filters are always installed. Operating the unit without air filters can cause malfunction.

⚠ Caution:

- Before you start cleaning, stop operation and turn OFF the power supply.
- Indoor units are equipped with filters to remove the dust of sucked-in air. Clean the filters using the methods shown in the following sketches.

▶ Filter removal

⚠ Caution:

- In removing the filter, precautions must be taken to protect your eyes from dust. Also, if you have to climb up on a stool to do the job, be careful not to fall.
- When the filter is removed, do not touch the metallic parts inside the indoor unit, otherwise injury may result.

- PKFY-P-VBM-E
PKFY-P-VHM-E

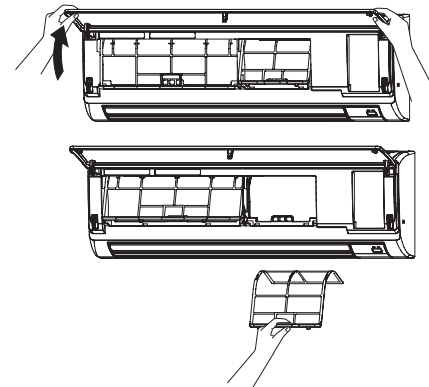

- ① Pull both the bottom corners of the intake grille to open the grille, then lift the filter.

10. Care and Cleaning

■ PCFY-P-VKM-E

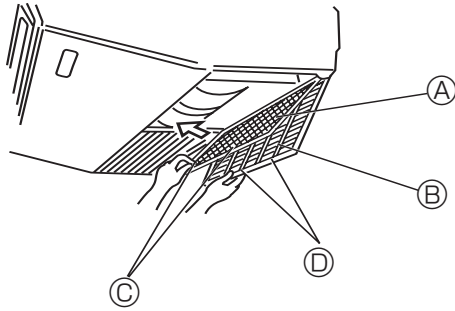

- ① Open the intake grille.
- ② Hold the knob on the filter then pull the filter up in the direction of an arrow. To replace the filter after cleaning, be sure to insert the filter far enough until it fits into the stopper.

Ⓐ Filter Ⓑ Intake Grille Ⓒ Knob Ⓓ Stopper

■ PMFY-P-VBM-E

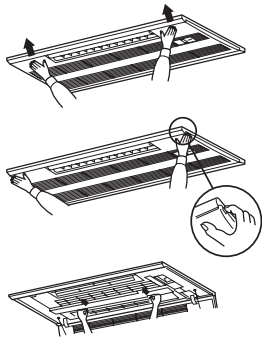

- ① Pressing the PUSH button on the outer side of the intake grille causes the intake grille to open.
- ② A filter with an intake grille on it can be removed by pulling the filter forward.

■ PFFY-P-VKM-E(2)

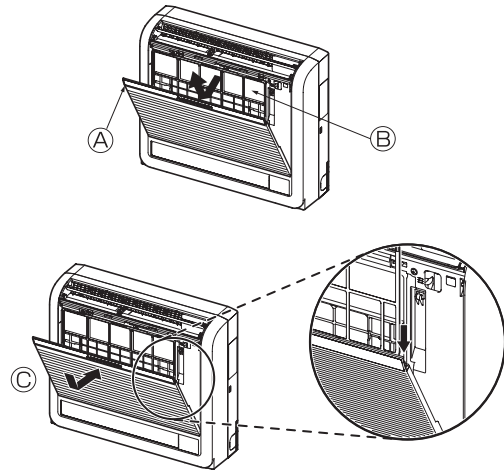





- ① Remove the catechin air filter.
 - Ⓐ Open the front grille
 - Ⓑ Catechin air filter

⚠ Caution:

When the catechin air filter is to be removed, do not touch the metal parts of the indoor unit. This may cause an injury.

- ② Install the catechin air filter. Be sure to install its both ends into the tabs as shown.
- Ⓒ Install
- ③ Securely close the front grille.

11. Trouble Shooting

| Having trouble? | Here is the solution. (Unit is operating normally.) |
|---|---|
| Air conditioner does not heat or cool well. | <ul style="list-style-type: none"> ■ Clean the filter. (Airflow is reduced when the filter is dirty or clogged.) ■ Check the temperature adjustment and adjust the set temperature. ■ Make sure that there is plenty of space around the outdoor unit. Is the indoor unit air intake or outlet blocked? ■ Has a door or window been left open? |
| When heating operation starts, warm air does not blow from the indoor unit soon. | <ul style="list-style-type: none"> ■ Warm air does not blow until the indoor unit has sufficiently warmed up. |
| During heating mode, the air conditioner stops before the set room temperature is reached. | <ul style="list-style-type: none"> ■ When the outdoor temperature is low and the humidity is high, frost may form on the outdoor unit. If this occurs, the outdoor unit performs a defrosting operation. Normal operation should begin after approximately 10 minutes. |
| Airflow direction changes during operation or airflow direction cannot be set. | <ul style="list-style-type: none"> ■ During cooling mode, the vanes automatically move to the horizontal (down) position after 1 hour when the down (horizontal) airflow direction is selected. This is to prevent water from forming and dripping from the vanes. ■ During heating mode, the vanes automatically move to the horizontal airflow direction when the airflow temperature is low or during defrosting mode. |
| When the airflow direction is changed, the vanes always move up and down past the set position before finally stopping at the position. | <ul style="list-style-type: none"> ■ When the airflow direction is changed, the vanes move to the set position after detecting the base position. |
| A flowing water sound or occasional hissing sound is heard. | <ul style="list-style-type: none"> ■ These sounds can be heard when refrigerant is flowing in the air conditioner or when the refrigerant flow is changing. |
| A cracking or creaking sound is heard. | <ul style="list-style-type: none"> ■ These sounds can be heard when parts rub against each due to expansion and contraction from temperature changes. |
| The room has an unpleasant odor. | <ul style="list-style-type: none"> ■ The indoor unit draws in air that contains gases produced from the walls, carpeting, and furniture as well as odors trapped in clothing, and then blows this air back into the room. |
| A white mist or vapor is emitted from the indoor unit. | <ul style="list-style-type: none"> ■ If the indoor temperature and the humidity are high, this condition may occur when operation starts. ■ During defrosting mode, cool airflow may blow down and appear like a mist. |
| Water or vapor is emitted from the outdoor unit. | <ul style="list-style-type: none"> ■ During cooling mode, water may form and drip from the cool pipes and joints. ■ During heating mode, water may form and drip from the heat exchanger. ■ During defrosting mode, water on the heat exchanger evaporates and water vapor may be emitted. |
| The operation indicator does not appear in the remote controller display. | <ul style="list-style-type: none"> ■ Turn on the power switch. "●" will appear in the remote controller display. |
| The air conditioner does not operate even though the ON/OFF button is pressed. The operation mode display on the remote controller disappears. | <ul style="list-style-type: none"> ■ Is the power switch of the indoor unit turned off? Turn on the power switch. |
| "  " appears in the remote controller display. | <ul style="list-style-type: none"> ■ During central control, " " appears in the remote controller display and air conditioner operation cannot be started or stopped using the remote controller. |
| When restarting the air conditioner soon after stopping it, it does not operate even though the ON/OFF button is pressed. | <ul style="list-style-type: none"> ■ Wait approximately three minutes. (Operation has stopped to protect the air conditioner.) |
| Air conditioner operates without the ON/OFF button being pressed. | <ul style="list-style-type: none"> ■ Is the on timer set? Press the ON/OFF button to stop operation. ■ Is the air conditioner connected to a central remote controller? Consult the concerned people who control the air conditioner. ■ Does " " appear in the remote controller display? Consult the concerned people who control the air conditioner. ■ Has the auto recovery feature from power failures been set? Press the ON/OFF button to stop operation. |
| Air conditioner stops without the ON/OFF button being pressed. | <ul style="list-style-type: none"> ■ Is the off timer set? Press the ON/OFF button to restart operation. ■ Is the air conditioner connected to a central remote controller? Consult the concerned people who control the air conditioner. ■ Does " " appear in the remote controller display? Consult the concerned people who control the air conditioner. |
| Remote controller timer operation cannot be set. | <ul style="list-style-type: none"> ■ Are timer settings invalid? If the timer can be set, (WEEKLY) , (SIMPLE) or (AUTO OFF) appears in the remote controller display. |
| "PLEASE WAIT" appears in the remote controller display. | <ul style="list-style-type: none"> ■ The initial settings are being performed. Wait approximately 3 minutes. |
| An error code appears in the remote controller display. | <ul style="list-style-type: none"> ■ The protection devices have operated to protect the air conditioner. ■ Do not attempt to repair this equipment by yourself. Turn off the power switch immediately and consult your dealer. Be sure to provide the dealer with the model name and information that appeared in the remote controller display. |
| Draining water or motor rotation sound is heard. | <ul style="list-style-type: none"> ■ When cooling operation stops, the drain pump operates and then stops. Wait approximately 3 minutes. |



11. Trouble Shooting

| Having trouble? | Here is the solution. (Unit is operating normally.) | | | | | | | | | | | | |
|--|---|-----------------------------------|----------------------------|--------------|---------------------------|-------------------|---------------------------------------|-----------------------------------|--------------------|--------------|-----------|------------|------------|
| Noise is louder than specifications. | <p>■ The indoor operation sound level is affected by the acoustics of the particular room as shown in the following table and will be higher than the noise specification, which was measured in an echo-free room.</p> <table border="1"> <thead> <tr> <th></th> <th>High sound-absorbing rooms</th> <th>Normal rooms</th> <th>Low sound-absorbing rooms</th> </tr> </thead> <tbody> <tr> <td>Location examples</td> <td>Broadcasting studio, music room, etc.</td> <td>Reception room, hotel lobby, etc.</td> <td>Office, hotel room</td> </tr> <tr> <td>Noise levels</td> <td>3 to 7 dB</td> <td>6 to 10 dB</td> <td>9 to 13 dB</td> </tr> </tbody> </table> | | High sound-absorbing rooms | Normal rooms | Low sound-absorbing rooms | Location examples | Broadcasting studio, music room, etc. | Reception room, hotel lobby, etc. | Office, hotel room | Noise levels | 3 to 7 dB | 6 to 10 dB | 9 to 13 dB |
| | High sound-absorbing rooms | Normal rooms | Low sound-absorbing rooms | | | | | | | | | | |
| Location examples | Broadcasting studio, music room, etc. | Reception room, hotel lobby, etc. | Office, hotel room | | | | | | | | | | |
| Noise levels | 3 to 7 dB | 6 to 10 dB | 9 to 13 dB | | | | | | | | | | |
| Nothing appears in the wireless remote controller display, the display is faint, or signals are not received by the indoor unit unless the remote controller is close. | <p>■ The batteries are low. Replace the batteries and press the Reset button.</p> <p>■ If nothing appears even after the batteries are replaced, make sure that the batteries are installed in the correct directions (+, -).</p> | | | | | | | | | | | | |
| The operation lamp near the receiver for the wireless remote controller on the indoor unit is blinking. | <p>■ The self diagnosis function has operated to protect the air conditioner.</p> <p>■ Do not attempt to repair this equipment by yourself. Turn off the power switch immediately and consult your dealer. Be sure to provide the dealer with the model name.</p> | | | | | | | | | | | | |
| Warm air blows from the indoor unit intermittently when heating mode is off or during fan mode. | <p>■ When another indoor unit is operating in heating mode, the control valve opens and closes occasionally to maintain stability in the air conditioning system. This operation will stop after a while.</p> <p>* If this will cause an undesirable rise in the room temperature in small rooms, etc., stop the operation of the indoor unit temporarily.</p> | | | | | | | | | | | | |
| The damper opens and closes automatically. (For PFFY-P-VKM-E series) | <p>■ The damper is automatically controlled by a microcomputer according to the air flow temperature and operation time of the air conditioner.</p> | | | | | | | | | | | | |

► Air outlet control (PFFY-P-VKM-E series)

This unit is automatically controlled that air comes out simultaneously from the upper and lower air outlets so that the room can be cooled or heated effectively.

Description of operation

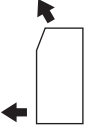
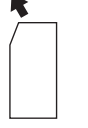
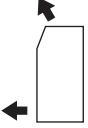
| Operation | COOL | | DRY | HEAT | | FAN |
|------------|---|---|---|--|---|---|
| Air flow |  |  |  |  |  |  |
| | Upper and lower air flow | Upper air flow | Upper air flow only | Upper and lower air flow | Upper air flow | Upper and lower air flow |
| Conditions | Room temperature and set temperature are different. | Room temperature is close to set temperature or thermo-off. | — | (Normal condition (in heating)) | During defrosting operation, start of operation, thermo-off | — |

- Be sure to keep the area around the damper of the lower air outlet free of any objects.
This unit can be set to blow out air from the upper air outlet only by changing the switch setting on the address board (ask the dealer).

Range of application

The range of working temperatures for both the indoor and outdoor units of the series Y, R2, Multi-S is as below.

⚠ Warning:

If the air conditioner operates but does not cool or heat (depending on model) the room, consult your dealer since there may be a refrigerant leak. Be sure to ask the service representative whether there is refrigerant leakage or not when repairs are carried out. The refrigerant charged in the air conditioner is safe. Refrigerant normally does not leak. However, if refrigerant gas leaks indoors, and comes into contact with the fire of a fan heater, space heater, stove, etc., harmful substances will be generated.

12. Specifications

■ PCFY-P-VKM-E Series

| Model | P40 | P63 | P100 | P125 |
|---|-----------------------------------|-------------|-------------|-------------|
| Power source (Voltage<V>/Frequency) | <Hz> ~/N 220-230-240/50, 220/60 | | | |
| Capacity (Cooling/Heating) | <kW> 4.5/5.0 | 7.1/8.0 | 11.2/12.5 | 14.0/16.0 |
| Dimension (Height) | <mm> 230 | | | |
| Dimension (Width) | <mm> 960 | 1280 | 1600 | |
| Dimension (Depth) | <mm> 680 | | | |
| Net weight | <kg> 24 | 32 | 36 | 38 |
| Fan Airflow rate (Low-Middle2-Middle1-High) | <m ³ /min> 10-11-12-13 | 14-15-16-18 | 21-24-26-28 | 21-24-27-31 |
| Noise level (Low-Middle2-Middle1-High) | <dB> 29-32-34-36 | 31-33-35-37 | 36-39-41-43 | 36-39-42-44 |

Note

- * Operation temperature of indoor unit.
Cooling mode: 15°CWB - 24°CWB
Heating mode: 15°CDB - 27°CDB

- *1 Cooling/Heating capacity indicates the maximum value at operation under the following condition.
Cooling: Indoor 27 °C DB/19°C WB, Outdoor 35 °C DB
Heating: Indoor 20 °C DB, Outdoor 7 °C DB/6 °C WB

■ PKFY-P-VBM-E Series

■ PKFY-P-VHM-E Series

| Model | P15 | P20 | P25 | P32 | P40 | P50 |
|---|---------------------------------------|-----------------|---------|----------|-------------|-----------|
| Power source (Voltage<V>/Frequency) | <Hz> ~/N 220-230-240/50, 220/60 | | | | | |
| Capacity (Cooling/Heating) | <kW> 1.7/1.9 | 2.2/2.5 | 2.8/3.2 | 3.6/4.0 | 4.5/5.0 | 5.6/6.3 |
| Dimension (Height) | <mm> 295 | | | <mm> 295 | | |
| Dimension (Width) | <mm> 815 | | | <mm> 898 | | |
| Dimension (Depth) | <mm> 225 | | | <mm> 249 | | |
| Net weight | <kg> 10 | | | <kg> 13 | | |
| Fan Airflow rate (Low-Middle2-Middle1-High) | <m ³ /min> 4.9-5.0-5.2-5.3 | 4.9-5.2-5.6-5.9 | | 9-10-11 | 9-10.5-11.5 | 9-10.5-12 |
| Noise level (Low-Middle2-Middle1-High) | <dB> 29-31-32-33 | 29-31-34-36 | | 34-37-41 | 34-38-41 | 34-39-43 |

Note

- * Operation temperature of indoor unit.
Cooling mode: 15°CWB - 24°CWB
Heating mode: 15°CDB - 27°CDB

- *1 Cooling/Heating capacity indicates the maximum value at operation under the following condition.
Cooling: Indoor 27 °C DB/19°C WB, Outdoor 35 °C DB
Heating: Indoor 20 °C DB, Outdoor 7 °C DB/6 °C WB

■ PMFY-P-VBM-E Series

| Model | P20 | P25 | P32 | P40 |
|---|---------------------------------------|-----------------|---------|------------------|
| Power source (Voltage<V>/Frequency) | <Hz> ~/N 220-230-240/50, 220/60 | | | |
| Capacity (Cooling/Heating) | <kW> 2.2/2.5 | 2.8/3.2 | 3.6/4.0 | 4.5/5.0 |
| Dimension (Height) | <mm> 230 (30) | | | |
| Dimension (Width) | <mm> 854 (1000) | | | |
| Dimension (Depth) | <mm> 395 (470) | | | |
| Net weight | <kg> 14 (3.0) | | | |
| Fan Airflow rate (Low-Middle2-Middle1-High) | <m ³ /min> 6.5-7.2-8.0-8.6 | 7.3-8.0-8.6-9.3 | | 7.7-8.7-9.7-10.7 |
| Noise level (Low-Middle2-Middle1-High) | <dB> 27-30-33-36 | 32-34-36-37 | | 33-35-37-39 |

Note

- * Operation temperature of indoor unit.
Cooling mode: 15°CWB - 24°CWB
Heating mode: 15°CDB - 27°CDB

- *1 Cooling/Heating capacity indicates the maximum value at operation under the following condition.
Cooling: Indoor 27 °C DB/19 °C WB, Outdoor 35 °C DB
Heating: Indoor 20 °C DB, Outdoor 7 °C DB/6 °C WB

- *2 This figure () indicates panel's.

■ PFFY-P-VKM-E Series

| Model | P20 | P25 | P32 | P40 |
|---|---------------------------------------|-----------------|---------|------------------|
| Power source (Voltage<V>/Frequency) | <Hz> ~/N 220-230-240/50 | | | |
| Capacity (Cooling/Heating) | <kW> 2.2/2.5 | 2.8/3.2 | 3.6/4.0 | 4.5/5.0 |
| Dimension (Height) | <mm> 600 | | | |
| Dimension (Width) | <mm> 700 | | | |
| Dimension (Depth) | <mm> 200 | | | |
| Net weight | <kg> 14 | | | |
| Fan Airflow rate (Low-Middle2-Middle1-High) | <m ³ /min> 5.9-6.8-7.6-8.7 | 6.1-7.0-8.0-9.1 | | 8.0-9.0-9.5-10.7 |
| Noise level (Low-Middle2-Middle1-High) | <dB> 27-31-34-37 | 28-32-35-38 | | 35-38-42-44 |

Note

- * Operation temperature of indoor unit.
Cooling mode: 15°CWB - 24°CWB
Heating mode: 15°CDB - 27°CDB

- *1 Cooling/Heating capacity indicates the maximum value at operation under the following condition.
Cooling: Indoor 27 °C DB/19 °C WB, Outdoor 35 °C DB
Heating: Indoor 20 °C DB, Outdoor 7 °C DB/6 °C WB

Please be sure to put the contact address/telephone number on
this manual before handing it to the customer.

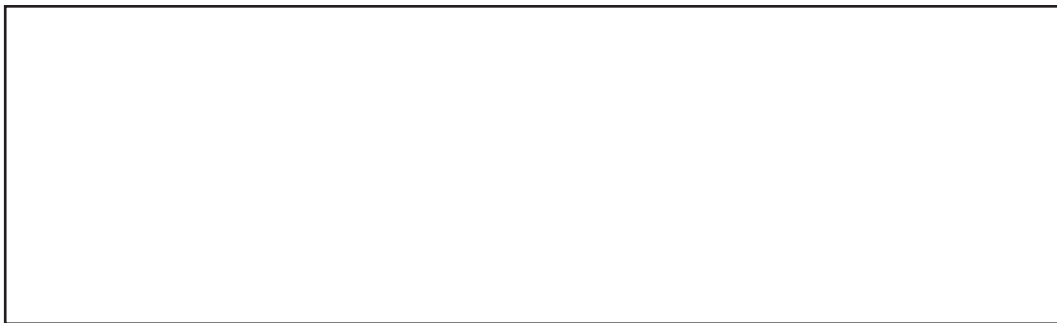

mitsubishi electric corporation

HEAD OFFICE: TOKYO BLDG., 2-7-3, MARUNOUCHI, CHIYODA-KU, TOKYO 100-8310, JAPAN