

R410A

Models PUHY-P200, P250, P300, P350YHM-A
PUHY-P400, P450YHM-A
PUHY-P500, P550, P600, P650YSHM-A
PUHY-P700, P750, P800, P850, P900YSHM-A
PUHY-P950, P1000, P1050, P1100, P1150, P1200, P1250YSHM-A
PUHY-EP200, EP250, EP300YHM-A
PUHY-EP400, EP450YSHM-A(1)
PUHY-EP500, EP550, EP600, EP650YSHM-A(1)
PUHY-EP700, EP750, EP800, EP850, EP900YSHM-A(1)

4th edition

CITY MULTI

Service Handbook

Safety Precautions

- Before installing the unit, thoroughly read the following safety precautions.
- Observe these safety precautions for your safety.

WARNING

This symbol is intended to alert the user to the presence of important instructions that must be followed to avoid the risk of serious injury or death.

CAUTION

This symbol is intended to alert the user to the presence of important instructions that must be followed to avoid the risk of serious injury or damage to the unit.

- After reading this manual, give it to the user to retain for future reference.
- Keep this manual for easy reference. When the unit is moved or repaired, give this manual to those who provide these services.
When the user changes, make sure that the new user receives this manual.

WARNING

Ask your dealer or a qualified technician to install the unit.

Improper installation by the user may result in water leakage, electric shock, smoke, and/or fire.

Properly install the unit on a surface that can withstand the weight of the unit.

Unit installed on an unstable surface may fall and cause injury.

Only use specified cables. Securely connect each cable so that the terminals do not carry the weight of the cable.

Improperly connected or fixed cables may produce heat and start a fire.

Take appropriate safety measures against strong winds and earthquakes to prevent the unit from falling.

If the unit is not installed properly, the unit may fall and cause serious injury to the person or damage to the unit.

Do not make any modifications or alterations to the unit. Consult your dealer for repair.

Improper repair may result in water leakage, electric shock, smoke, and/or fire.

Do not touch the heat exchanger fins.

The fins are sharp and dangerous.

In the event of a refrigerant leak, thoroughly ventilate the room.

If refrigerant gas leaks and comes in contact with an open flame, poisonous gases will be produced.

When installing the All-Fresh type units, take it into consideration that the outside air may be discharged directly into the room when the thermo is turned off.

Direct exposure to outdoor air may have an adverse effect on health. It may also result in food spoilage.

Properly install the unit according to the instructions in the installation manual.

Improper installation may result in water leakage, electric shock, smoke, and/or fire.

Have all electrical work performed by an authorized electrician according to the local regulations and instructions in this manual, and a dedicated circuit must be used.

Insufficient capacity of the power supply circuit or improper installation may result in malfunctions of the unit, electric shock, smoke, and/or fire.

 **WARNING**

Securely attach the terminal block cover (panel) to the unit.

If the terminal block cover (panel) is not installed properly, dust and/or water may infiltrate and pose a risk of electric shock, smoke, and/or fire.

Only use the type of refrigerant that is indicated on the unit when installing or reinstalling the unit.

Infiltration of any other type of refrigerant or air into the unit may adversely affect the refrigerant cycle and may cause the pipes to burst or explode.

When installing the unit in a small room, exercise caution and take measures against leaked refrigerant reaching the limiting concentration.

Consult your dealer with any questions regarding limiting concentrations and for precautionary measures before installing the unit. Leaked refrigerant gas exceeding the limiting concentration causes oxygen deficiency.

Consult your dealer or a specialist when moving or reinstalling the unit.

Improper installation may result in water leakage, electric shock, and/or fire.

After completing the service work, check for a gas leak.

If leaked refrigerant is exposed to a heat source, such as a fan heater, stove, or electric grill, poisonous gases may be produced.

Do not try to defeat the safety features of the unit.

Forced operation of the pressure switch or the temperature switch by defeating the safety features of these devices, or the use of accessories other than the ones that are recommended by MITSUBISHI may result in smoke, fire, and/or explosion.

Only use accessories recommended by MITSUBISHI.

Ask a qualified technician to install the unit. Improper installation by the user may result in water leakage, electric shock, smoke, and/or fire.

Control box houses high-voltage parts.

When opening or closing the front panel of the control box, do not let it come into contact with any of the internal components. Before inspecting the inside of the control box, turn off the power, keep the unit off for at least 10 minutes, and confirm that the voltage between FT-P and FT-N on INV Board has dropped to DC20V or less. (It takes about 10 minutes to discharge electricity after the power supply is turned off.)

Precautions for handling units for use with R410A

CAUTION

Do not use the existing refrigerant piping.

- ♦A large amount of chlorine that may be contained in the residual refrigerant and refrigerating machine oil in the existing piping may cause the refrigerating machine oil in the new unit to deteriorate.
- ♦R410A is a high-pressure refrigerant and can cause the existing pipes to burst.

Use refrigerant pipes made of phosphorus deoxidized copper. Keep the inner and outer surfaces of the pipes clean and free of such contaminants as sulfur, oxides, dust, dirt, shaving particles, oil, and water.

These types of contaminants inside the refrigerant pipes may cause the refrigerant oil to deteriorate.

Store the pipes to be installed indoors, and keep both ends of the pipes sealed until immediately before brazing. (Keep elbows and other joints wrapped in plastic.)

Infiltration of dust, dirt, or water into the refrigerant system may cause the refrigerating machine oil to deteriorate or cause the unit to malfunction.

Use a small amount of ester oil, ether oil, or alkylbenzene to coat flares and flanges.

Infiltration of a large amount of mineral oil may cause the refrigerating machine oil to deteriorate.

Charge liquid refrigerant (as opposed to gaseous refrigerant) into the system.

If gaseous refrigerant is charged into the system, the composition of the refrigerant in the cylinder will change and may result in performance loss.

Use a vacuum pump with a reverse-flow check valve.

If a vacuum pump that is not equipped with a reverse-flow check valve is used, the vacuum pump oil may flow into the refrigerant cycle and cause the refrigerating machine oil to deteriorate.

Prepare tools for exclusive use with R410A. Do not use the following tools if they have been used with the conventional refrigerant (gauge manifold, charging hose, gas leak detector, reverse-flow check valve, refrigerant charge base, vacuum gauge, and refrigerant recovery equipment.).

- ♦If the refrigerant or the refrigerating machine oil left on these tools are mixed in with R410A, it may cause the refrigerating machine oil to deteriorate.
- ♦Infiltration of water may cause the refrigerating machine oil to deteriorate.
- ♦Gas leak detectors for conventional refrigerants will not detect an R410A leak because R410A is free of chlorine.

Do not use a charging cylinder.

If a charging cylinder is used, the composition of the refrigerant will change, and the unit may experience power loss.

Exercise special care when handling the tools for use with R410A.

Infiltration of dust, dirt, or water into the refrigerant system may cause the refrigerating machine oil to deteriorate.

Only use refrigerant R410A.

The use of other types of refrigerant that contain chlorine (i.e. R22) may cause the refrigerating machine oil to deteriorate.

Before installing the unit

WARNING

Do not install the unit where a gas leak may occur.

If gaseous refrigerant leaks and piles up around the unit, it may be ignited.

Do not use the unit to keep food items, animals, plants, artifacts, or for other special purposes.

The unit is not designed to preserve food products.

Do not use the unit in an unusual environment.

- ♦ Do not install the unit where a large amount of oil or steam is present or where acidic or alkaline solutions or chemical sprays are used frequently. Doing so may lead to a remarkable drop in performance, electric shock, malfunctions, smoke, and/or fire.
- ♦ The presence of organic solvents or corrosive gas (i.e. ammonia, sulfur compounds, and acid) may cause gas leakage or water leakage.

When installing the unit in a hospital, take appropriate measures to reduce noise interference.

High-frequency medical equipment may interfere with the normal operation of the air conditioner or vice versa.

Do not install the unit on or over things that cannot get wet.

When the humidity level exceeds 80% or if the drainage system is clogged, the indoor unit may drip water. Drain water is also discharged from the outdoor unit. Install a centralized drainage system if necessary.

Before installing the unit (moving and reinstalling the unit) and performing electrical work

CAUTION

Properly ground the unit.

Do not connect the grounding wire to a gas pipe, water pipe, lightning rod, or grounding wire from a telephone pole. Improper grounding may result in electric shock, smoke, fire, and/or malfunction due to noise interference.

Do not put tension on the power supply wires.

If tension is put on the wires, they may break and result in excessive heat, smoke, and/or fire.

Install an earth leakage breaker to avoid the risk of electric shock.

Failure to install an earth leakage breaker may result in electric shock, smoke, and/or fire.

Use the kind of power supply wires that are specified in the installation manual.

The use of wrong kind of power supply wires may result in current leak, electric shock, and/or fire.

Use breakers and fuses (current breaker, remote switch <switch + Type-B fuse>, moulded case circuit breaker) with the proper current capacity.

The use of wrong capacity fuses, steel wires, or copper wires may result in malfunctions, smoke, and/or fire.

Do not spray water on the air conditioner or immerse the air conditioner in water.

Otherwise, electric shock and/or fire may result.

When handling units, always wear protective gloves to protect your hands from metal parts and high-temperature parts.

Periodically check the installation base for damage.

If the unit is left on a damaged platform, it may fall and cause injury.

Properly install the drain pipes according to the instructions in the installation manual. Keep them insulated to avoid dew condensation.

Improper plumbing work may result in water leakage and damage to the furnishings.

Exercise caution when transporting products.

- ♦ Products weighing more than 20 kg should not be carried alone.
- ♦ Do not carry the product by the PP bands that are used on some products.
- ♦ Do not touch the heat exchanger fins. They are sharp and dangerous.
- ♦ When lifting the unit with a crane, secure all four corners to prevent the unit from falling.

Properly dispose of the packing materials.

- ♦ Nails and wood pieces in the package may pose a risk of injury.
- ♦ Plastic bags may pose a risk of choking hazard to children. Tear plastic bags into pieces before disposing of them.

Before the test run

 **CAUTION**

Turn on the unit at least 12 hours before the test run.

Keep the unit turned on throughout the season. If the unit is turned off in the middle of a season, it may result in malfunctions.

To avoid the risk of electric shock or malfunction of the unit, do not operate switches with wet hands.

Do not touch the refrigerant pipes with bare hands during and immediately after operation.

During or immediately after operation, certain parts of the unit such as pipes and compressor may be either very cold or hot, depending on the state of the refrigerant in the unit at the time. To reduce the risk of frost bites and burns, do not touch these parts with bare hands.

Do not operate the unit without panels and safety guards.

Rotating, high-temperature, or high-voltage parts on the unit pose a risk of burns and/or electric shock.

Do not turn off the power immediately after stopping the operation.

Keep the unit on for at least five minutes before turning off the power to prevent water leakage or malfunction.

Do not operate the unit without the air filter.

Dust particles may build up in the system and cause malfunctions.

CONTENTS

I Read Before Servicing

[1] Read Before Servicing	3
[2] Necessary Tools and Materials	4
[3] Piping Materials	5
[4] Storage of Piping	7
[5] Pipe Processing	7
[6] Brazing	8
[7] Air Tightness Test	9
[8] Vacuum Drying (Evacuation)	10
[9] Refrigerant Charging	11
[10] Remedies to be taken in case of a Refrigerant Leak	11
[11] Characteristics of the Conventional and the New Refrigerants	12
[12] Notes on Refrigerating Machine Oil	13

II Restrictions

[1] System configuration	17
[2] Types and Maximum allowable Length of Cables	19
[3] Switch Settings and Address Settings	20
[4] Sample System Connection	27
[5] An Example of a System to which an MA Remote Controller is connected	28
[6] An Example of a System to which an ME Remote Controller is connected	38
[7] An Example of a System to which both MA Remote Controller and ME Remote Controller are connected	40
[8] Restrictions on Pipe Length	42

III Outdoor Unit Components

[1] Outdoor Unit Components and Refrigerant Circuit	49
[2] Control Box of the Outdoor Unit	51
[3] Outdoor Unit Circuit Board	52

IV Remote Controller

[1] Functions and Specifications of MA and ME Remote Controllers	59
[2] Group Settings and Interlock Settings via the ME Remote Controller	60
[3] Interlock Settings via the MA Remote Controller	64
[4] Using the built-in Temperature Sensor on the Remote Controller	65

V Electrical Wiring Diagram

[1] Electrical Wiring Diagram of the Outdoor Unit	69
[2] Electrical Wiring Diagram of Transmission Booster	70

VI Refrigerant Circuit

[1] Refrigerant Circuit Diagram	73
[2] Principal Parts and Functions	74

VII Control

[1] Functions and Factory Settings of the Dipswitches	81
[2] Controlling the Outdoor Unit	87
[3] Operation Flow Chart	100

VIII Test Run Mode

[1] Items to be checked before a Test Run	107
[2] Test Run Method	108
[3] Operating Characteristic and Refrigerant Amount	109
[4] Adjusting the Refrigerant Amount	109
[5] Refrigerant Amount Adjust Mode	112
[6] The following symptoms are normal	114
[7] Standard Operation Data (Reference Data)	115

IX Troubleshooting

[1] Error Code Lists	181
[2] Responding to Error Display on the Remote Controller	184
[3] Investigation of Transmission Wave Shape/Noise	245
[4] Troubleshooting Principal Parts	248
[5] Refrigerant Leak	268
[6] Compressor Replacement Instructions	270
[7] Troubleshooting Using the Outdoor Unit LED Error Display	272

X LED Monitor Display on the Outdoor Unit Board

[1] How to Read the LED on the Service Monitor	275
------------------------------------------------------	-----

I Read Before Servicing

[1] Read Before Servicing	3
[2] Necessary Tools and Materials.....	4
[3] Piping Materials	5
[4] Storage of Piping	7
[5] Pipe Processing	7
[6] Brazing.....	8
[7] Air Tightness Test.....	9
[8] Vacuum Drying (Evacuation)	10
[9] Refrigerant Charging.....	11
[10] Remedies to be taken in case of a Refrigerant Leak.....	11
[11] Characteristics of the Conventional and the New Refrigerants	12
[12] Notes on Refrigerating Machine Oil.....	13



[1] Read Before Servicing

1. Check the type of refrigerant used in the system to be serviced.

Refrigerant Type

Multi air conditioner for building application CITY MULTI YHM-A series R410A

2. Check the symptoms exhibited by the unit to be serviced.

Refer to this service handbook for symptoms relating to the refrigerant cycle.

3. Thoroughly read the safety precautions at the beginning of this manual.

4. Preparing necessary tools: Prepare a set of tools to be used exclusively with each type of refrigerant.

Refer to "Necessary Tools and Materials" for information on the use of tools.(page 4)

5. Verification of the connecting pipes: Verify the type of refrigerant used for the unit to be moved or replaced.

- Use refrigerant pipes made of phosphorus deoxidized copper. Keep the inner and outer surfaces of the pipes clean and free of such contaminants as sulfur, oxides, dust, dirt, shaving particles, oil, and water.
- These types of contaminants inside the refrigerant pipes may cause the refrigerant oil to deteriorate.

6. If there is a leak of gaseous refrigerant and the remaining refrigerant is exposed to an open flame, a poisonous gas hydrofluoric acid may form. Keep workplace well ventilated.



CAUTION

- Install new pipes immediately after removing old ones to keep moisture out of the refrigerant circuit.
- The use of refrigerant that contains chloride, such as R22, will cause the refrigerating machine oil to deteriorate.

[2] Necessary Tools and Materials

Prepare the following tools and materials necessary for installing and servicing the unit.

Tools for use with R410A (Adaptability of tools that are for use with R22 or R407C)

1. To be used exclusively with R410A (not to be used if used with R22 or R407C)

Tools/Materials	Use	Notes
Gauge Manifold	Evacuation and refrigerant charging	Higher than 5.09MPa[738psi] on the high-pressure side
Charging Hose	Evacuation and refrigerant charging	The hose diameter is larger than the conventional model.
Refrigerant Recovery Cylinder	Refrigerant recovery	
Refrigerant Cylinder	Refrigerant charging	The refrigerant type is indicated. The cylinder is pink.
Charging Port on the Refrigerant Cylinder	Refrigerant charging	The charge port diameter is larger than that of the current port.
Flare Nut	Connection of the unit with the pipes	Use Type-2 Flare nuts.

2. Tools and materials that may be used with R410A with some restrictions

Tools/Materials	Use	Notes
Gas Leak Detector	Gas leak detection	The ones for use with HFC refrigerant may be used.
Vacuum Pump	Vacuum drying	May be used if a check valve adapter is attached.
Flare Tool	Flare processing	Flare processing dimensions for the piping in the system using the new refrigerant differ from those of R22. Refer to next page.
Refrigerant Recovery Equipment	Refrigerant recovery	May be used if compatible with R410A.

3. Tools and materials that are used with R22 or R407C that may also be used with R410A

Tools/Materials	Use	Notes
Vacuum Pump with a Check Valve	Vacuum drying	
Bender	Bending pipes	
Torque Wrench	Tightening flare nuts	Only the flare processing dimensions for pipes that have a diameter of $\phi 12.70$ (1/2") and $\phi 15.88$ (5/8") have been changed.
Pipe Cutter	Cutting pipes	
Welder and Nitrogen Cylinder	Welding pipes	
Refrigerant Charging Meter	Refrigerant charging	
Vacuum Gauge	Vacuum level check	

4. Tools and materials that must not be used with R410A

Tools/Materials	Use	Notes
Charging Cylinder	Refrigerant charging	Prohibited to use

Tools for R410A must be handled with special care to keep moisture and dust from infiltrating the cycle.

[3] Piping Materials

Do not use the existing piping!

1. Copper pipe materials

O-material (Annealed)	Soft copper pipes (annealed copper pipes). They can easily be bent with hands.
1/2H-material (Drawn)	Hard copper pipes (straight pipes). They are stronger than the O-material (Annealed) at the same radial thickness.

- The distinction between O-materials (Annealed) and 1/2H-materials (Drawn) is made based on the strength of the pipes themselves.
- O-materials (Annealed) can easily be bent with hands.
- 1/2H-materials (Drawn) are considerably stronger than O-material (Annealed) at the same thickness.

2. Types of copper pipes

Maximum working pressure	Refrigerant type
3.45 MPa [500psi]	R22, R407C etc.
4.30 MPa [624psi]	R410A etc.

3. Piping materials/Radial thickness

Use refrigerant pipes made of phosphorus deoxidized copper.
 The operation pressure of the units that use R410A is higher than that of the units that use R22.
 Use pipes that have at least the radial thickness specified in the chart below.
 (Pipes with a radial thickness of 0.7 mm or less may not be used.)

Pipe size (mm[in])	Radial thickness (mm)	Type
ø6.35 [1/4"]	0.8t	O-material (Annealed)
ø9.52 [3/8"]	0.8t	
ø12.7 [1/2"]	0.8t	
ø15.88 [5/8"]	1.0t	
ø19.05 [3/4"]	1.0t	1/2H-material, H-material (Drawn)
ø22.2 [7/8"]	1.0t	
ø25.4 [1"]	1.0t	
ø28.58 [1-1/8"]	1.0t	
ø31.75 [1-1/4"]	1.1t	
ø34.93 [1-3/8"]	1.1t	
ø41.28 [1-5/8"]	1.2t	

- The pipes in the system that uses the refrigerant currently on the market are made with O-material (Annealed), even if the pipe diameter is less than ø19.05 (3/4"). For a system that uses R410A, use pipes that are made with 1/2H-material (Drawn) unless the pipe diameter is at least ø19.05 (3/4") and the radial thickness is at least 1.2t.
- The figures in the radial thickness column are based on the Japanese standards and provided only as a reference. Use pipes that meet the local standards.

4. Thickness and refrigerant type indicated on the piping materials

Ask the pipe manufacturer for the symbols indicated on the piping material for new refrigerant.

5. Flare processing (O-material (Annealed) and OL-material only)

The flare processing dimensions for the pipes that are used in the R410A system are larger than those in the R22 system.

Flare processing dimensions (mm[in])

Pipe size (mm[in])	A dimension (mm)	
	R410A	R22, R407C
ø6.35 [1/4"]	9.1	9.0
ø9.52 [3/8"]	13.2	13.0
ø12.7 [1/2"]	16.6	16.2
ø15.88 [5/8"]	19.7	19.4
ø19.05 [3/4"]	24.0	23.3

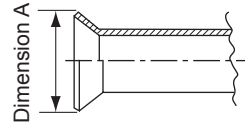

If a clutch-type flare tool is used to flare the pipes in the system using R410A, the length of the pipes must be between 1.0 and 1.5 mm. For margin adjustment, a copper pipe gauge is necessary.

6. Flare nut

The flare nut type has been changed to increase the strength. The size of some of the flare nuts have also been changed.

Flare nut dimensions (mm[in])

Pipe size (mm[in])	B dimension (mm)	
	R410A	R22, R407C
ø6.35 [1/4"]	17.0	17.0
ø9.52 [3/8"]	22.0	22.0
ø12.7 [1/2"]	26.0	24.0
ø15.88 [5/8"]	29.0	27.0
ø19.05 [3/4"]	36.0	36.0

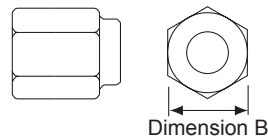

The figures in the radial thickness column are based on the Japanese standards and provided only as a reference. Use pipes that meet the local standards.

[4] Storage of Piping

1. Storage location



Store the pipes to be used indoors. (Warehouse at site or owner's warehouse)
If they are left outdoors, dust, dirt, or moisture may infiltrate and contaminate the pipe.

2. Sealing the pipe ends

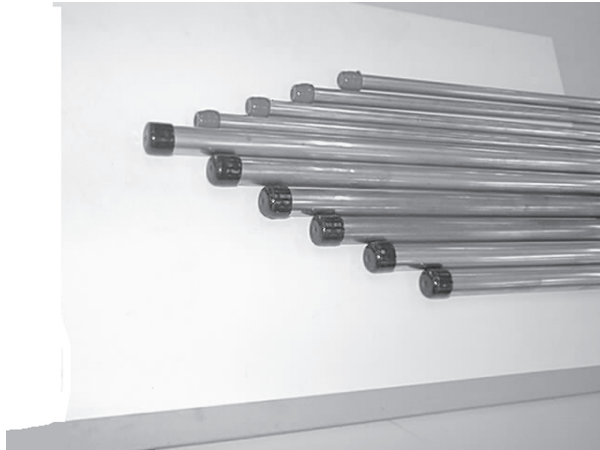

Both ends of the pipes should be sealed until just before brazing.
Keep elbow pipes and T-joints in plastic bags.

The new refrigerator oil is 10 times as hygroscopic as the conventional refrigerating machine oil (such as Suniso) and, if not handled with care, could easily introduce moisture into the system. Keep moisture out of the pipes, for it will cause the oil to deteriorate and cause a compressor failure.

[5] Pipe Processing

Use a small amount of ester oil, ether oil, or alkylbenzene to coat flares and flanges.

Note

- Use a minimum amount of oil.
- Use only ester oil, ether oil, and alkylbenzene.

[6] Brazing

No changes have been made in the brazing procedures. Perform brazing with special care to keep foreign objects (such as oxide scale, water, and dust) out of the refrigerant system.

Example: Inside the brazed connection

Use of oxidized solder for brazing

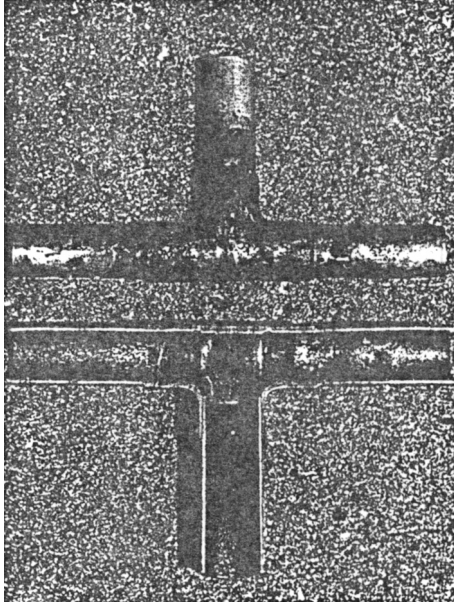

Use of non-oxidized solder for brazing

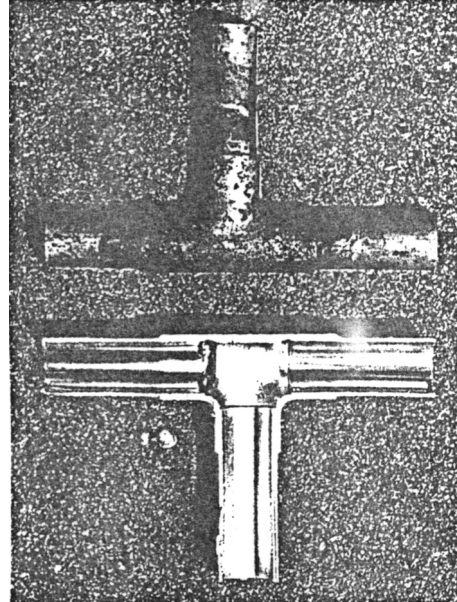

1. Items to be strictly observed

- Do not conduct refrigerant piping work outdoors if raining.
- Use non-oxidized solder.
- Use a brazing material (BCuP-3) that requires no flux when brazing between copper pipes or between a copper pipe and copper coupling.
- If installed refrigerant pipes are not immediately connected to the equipment, then braze and seal both ends.

2. Reasons

- The new refrigerating machine oil is 10 times as hygroscopic as the conventional oil and is more likely to cause unit failure if water infiltrates into the system.
- Flux generally contains chloride. Residual flux in the refrigerant circuit will cause sludge to form.

3. Notes

Do not use commercially available antioxidants because they may cause the pipes to corrode or refrigerating machine oil to deteriorate.

[7] Air Tightness Test

No changes have been made in the detection method. Note that a refrigerant leak detector for R22 will not detect an R410A leak.

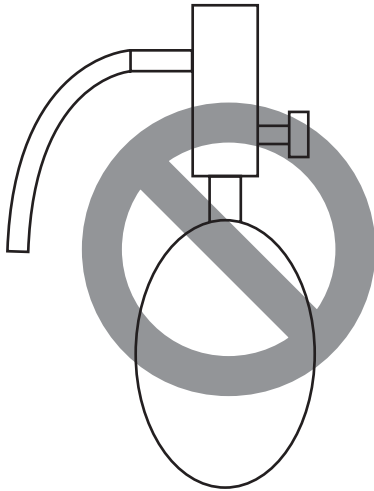

Halide torch

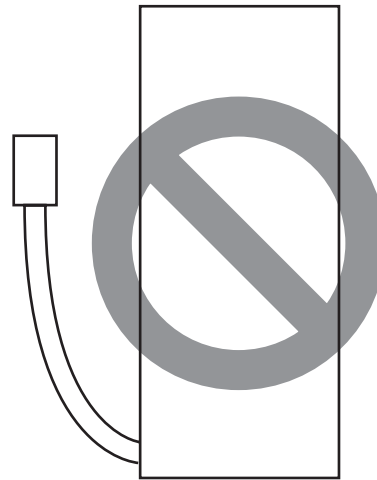

R22 leakage detector

1. Items to be strictly observed

- Pressurize the equipment with nitrogen up to the design pressure (4.15MPa[601psi]), and then judge the equipment's air tightness, taking temperature variations into account.
- Refrigerant R410A must be charged in its liquid state (vs. gaseous state).

2. Reasons

- Oxygen, if used for an air tightness test, poses a risk of explosion. (Only use nitrogen to check air tightness.)
- Refrigerant R410A must be charged in its liquid state. If gaseous refrigerant in the cylinder is drawn out first, the composition of the remaining refrigerant in the cylinder will change and become unsuitable for use.

3. Notes

Procure a leak detector that is specifically designed to detect an HFC leak. A leak detector for R22 will not detect an HFC(R410A) leak.

[8] Vacuum Drying (Evacuation)



(Photo1) 15010H



(Photo2) 14010

Recommended vacuum gauge:
ROBINAIR 14010 Thermistor Vacuum Gauge

1. Vacuum pump with a reverse-flow check valve (Photo1)

To prevent the vacuum pump oil from flowing into the refrigerant circuit during power OFF or power failure, use a vacuum pump with a reverse-flow check valve.
A reverse-flow check valve may also be added to the vacuum pump currently in use.

2. Standard of vacuum degree (Photo 2)

Use a vacuum pump that attains 0.5Torr(65Pa) or lower degree of vacuum after 5 minutes of operation, and connect it directly to the vacuum gauge. Use a pump well-maintained with an appropriate lubricant. A poorly maintained vacuum pump may not be able to attain the desired degree of vacuum.

3. Required precision of vacuum gauge

Use a vacuum gauge that registers a vacuum degree of 5Torr(650Pa) and measures at intervals of 1Torr(130Pa). (A recommended vacuum gauge is shown in Photo2.)
Do not use a commonly used gauge manifold because it cannot register a vacuum degree of 5Torr(650Pa).

4. Evacuation time

- After the degree of vacuum has reached 5Torr(650Pa), evacuate for an additional 1 hour. (A thorough vacuum drying removes moisture in the pipes.)
- Verify that the vacuum degree has not risen by more than 1Torr(130Pa) 1hour after evacuation. A rise by less than 1Torr(130Pa) is acceptable.
- If the vacuum is lost by more than 1Torr(130Pa), conduct evacuation, following the instructions in section 6. Special vacuum drying.

5. Procedures for stopping vacuum pump

To prevent the reverse flow of vacuum pump oil, open the relief valve on the vacuum pump side, or draw in air by loosening the charge hose, and then stop the operation.
The same procedures should be followed when stopping a vacuum pump with a reverse-flow check valve.

6. Special vacuum drying

- When 5Torr(650Pa) or lower degree of vacuum cannot be attained after 3 hours of evacuation, it is likely that water has penetrated the system or that there is a leak.
- If water infiltrates the system, break the vacuum with nitrogen. Pressurize the system with nitrogen gas to 0.5kgf/cm²G(0.05MPa) and evacuate again. Repeat this cycle of pressurizing and evacuation either until the degree of vacuum below 5Torr(650Pa) is attained or until the pressure stops rising.
- Only use nitrogen gas for vacuum breaking. (The use of oxygen may result in an explosion.)

[9] Refrigerant Charging

Cylinder with a siphon

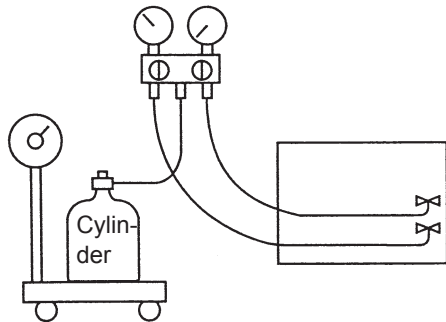

Cylinder color R410A is pink.

Cylinder without a siphon

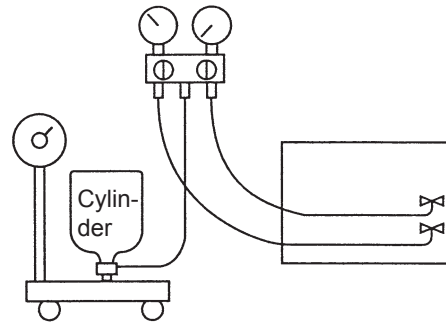

Refrigerant charging in the liquid state

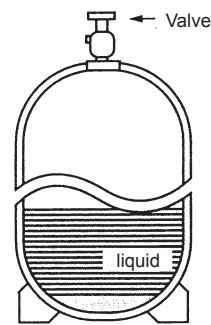
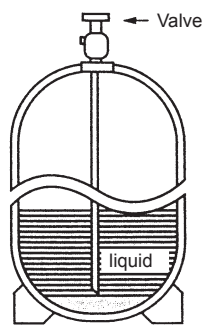

1. Reasons

R410A is a pseudo-azeotropic HFC blend (boiling point R32=-52°C[-62°F], R125=-49°C[-52°F]) and can almost be handled the same way as a single refrigerant, such as R22. To be safe, however, draw out the refrigerant from the cylinder in the liquid phase. If the refrigerant in the gaseous phase is drawn out, the composition of the remaining refrigerant will change and become unsuitable for use.

2. Notes

When using a cylinder with a siphon, refrigerant is charged in the liquid state without the need for turning it upside down. Check the type of the cylinder on the label before use.

[10] Remedies to be taken in case of a Refrigerant Leak

If the refrigerant leaks out, it may be replenished. The entire refrigerant does not need to be replaced. (Charge refrigerant in the liquid state.)

Refer to "IX [5] Refrigerant Leak".(page 268)

[11] Characteristics of the Conventional and the New Refrigerants

1. Chemical property

As with R22, the new refrigerant (R410A) is low in toxicity and chemically stable nonflammable refrigerant. However, because the specific gravity of vapor refrigerant is greater than that of air, leaked refrigerant in a closed room will accumulate at the bottom of the room and may cause hypoxia. If exposed to an open flame, refrigerant will generate poisonous gases. Do not perform installation or service work in a confined area.

	New Refrigerant (HFC type)		Conventional Refrigerant (HCFC type)
	R410A	R407C	R22
	R32/R125	R32/R125/R134a	R22
Composition (wt%)	(50/50)	(23/25/52)	(100)
Type of Refrigerant	Pseudo-azeotropic Refrigerant	Non-azeotropic Refrigerant	Single Refrigerant
Chloride	Not included	Not included	Included
Safety Class	A1/A1	A1/A1	A1
Molecular Weight	72.6	86.2	86.5
Boiling Point (°C/°F)	-51.4/-60.5	-43.6/-46.4	-40.8/-41.4
Steam Pressure (25°C,MPa/77°F,psi) (gauge)	1.557/226	0.9177/133	0.94/136
Saturated Steam Density (25°C,kg/m ³ /77°F,psi)	64.0	42.5	44.4
Flammability	Nonflammable	Nonflammable	Nonflammable
Ozone Depletion Coefficient (ODP)^{*1}	0	0	0.055
Global Warming Coefficient (GWP) ^{*2}	1730	1530	1700
Refrigerant Charging Method	Refrigerant charging in the liquid state	Refrigerant charging in the liquid state	Refrigerant charging in the gaseous state
Replenishment of Refrigerant after a Refrigerant Leak	Available	Available	Available

*1 When CFC11 is used as a reference

*2 When CO₂ is used as a reference

2. Refrigerant composition

R410A is a pseudo-azeotropic HFC blend and can almost be handled the same way as a single refrigerant, such as R22. To be safe, however, draw out the refrigerant from the cylinder in the liquid phase. If the refrigerant in the gaseous phase is drawn out, the composition of the remaining refrigerant will change and become unsuitable for use. If the refrigerant leaks out, it may be replenished. The entire refrigerant does not need to be replaced.

3. Pressure characteristics

The pressure in the system using R410A is 1.6 times as great as that in the system using R22.

Temperature (°C/°F)	Pressure (gauge)		
	R410A	R407C	R22
	MPa/psi	MPa/psi	MPa/psi
-20/-4	0.30/44	0.18/26	0.14/20
0/32	0.70/102	0.47/68	0.40/58
20/68	1.34/194	0.94/136	0.81/117
40/104	2.31/335	1.44/209	1.44/209
60/140	3.73/541	2.44/354	2.33/338
65/149	4.17/605	2.75/399	2.60/377

[12] Notes on Refrigerating Machine Oil

1. Refrigerating machine oil in the HFC refrigerant system

HFC type refrigerants use a refrigerating machine oil different from that used in the R22 system. Note that the ester oil used in the system has properties that are different from commercially available ester oil.

Refrigerant	Refrigerating machine oil
R22	Mineral oil
R407C	Ester oil
R410A	Ester oil

2. Effects of contaminants*1

Refrigerating machine oil used in the HFC system must be handled with special care to keep contaminants out. The table below shows the effect of contaminants in the refrigerating machine oil on the refrigeration cycle.

3. The effects of contaminants in the refrigerating machine oil on the refrigeration cycle.

Cause		Symptoms	Effects on the refrigerant cycle
Water infiltration		Frozen expansion valve and capillary tubes	Clogged expansion valve and capillary tubes Poor cooling performance Compressor overheat Motor insulation failure Burnt motor Coppering of the orbiting scroll Lock Burn-in on the orbiting scroll
		Hydrolysis	
Air infiltration		Oxidization	
Infiltration of contaminants	Dust, dirt	Adhesion to expansion valve and capillary tubes	Clogged expansion valve, capillary tubes, and drier Poor cooling performance Compressor overheat
		Infiltration of contaminants into the compressor	Burn-in on the orbiting scroll
	Mineral oil etc.	Sludge formation and adhesion	Clogged expansion valve and capillary tubes Poor cooling performance Compressor overheat
		Oil degradation	Burn-in on the orbiting scroll

*1. Contaminants is defined as moisture, air, processing oil, dust/dirt, wrong types of refrigerant, and refrigerating machine oil.

II Restrictions

[1] System configuration	17
[2] Types and Maximum allowable Length of Cables	19
[3] Switch Settings and Address Settings	20
[4] Sample System Connection.....	27
[5] An Example of a System to which an MA Remote Controller is connected.....	28
[6] An Example of a System to which an ME Remote Controller is connected.....	38
[7] An Example of a System to which both MA Remote Controller and ME Remote Controller are connected.....	40
[8] Restrictions on Pipe Length	42



[1] System configuration

1. Table of compatible indoor units

The table below summarizes the types of indoor units that are compatible with different types of outdoor units.

(1) Standard combinations

Outdoor units	Composing units			Maximum total capacity of connectable indoor units	Maximum number of connectable indoor units	Types of connectable indoor units
P200	-	-	-	100 - 260	17	P15 - P200 models R410A series indoor units
P250	-	-	-	125 - 325	21	
P300	-	-	-	150 - 390	26	
P350	-	-	-	175 - 455	30	P15 - P400 models R410A series indoor units
P400	-	-	-	200 - 520	34	P15 - P500 models R410A series indoor units
P450	-	-	-	225 - 585	39	
P500	P250	P250	-	250 - 650	43	
P550	P300	P250	-	275 - 715	47	
P600	P350	P250	-	300 - 780	50	
P650	P350	P300	-	325 - 845		
P700	P350	P350	-	350 - 910		
P750	P400	P350	-	375 - 975		
P800	P450	P350	-	400 - 1040		
P850	P450	P400	-	425 - 1105		
P900	P450	P450	-	450 - 1170		
P950	P400	P300	P250	475 - 1235		
P1000	P400	P300	P300	500 - 1300		
P1050	P400	P350	P300	525 - 1365		
P1100	P400	P350	P350	550 - 1430		
P1150	P450	P350	P350	575 - 1495		
P1200	P450	P400	P350	600 - 1560		
P1250	P450	P450	P350	625 - 1625		

Note

- 1) "Maximum total capacity of connectable indoor units" refers to the sum of the numeric values in the indoor unit model names.
- 2) If the total capacity of the indoor units that are connected to a given outdoor unit exceeds the capacity of the outdoor unit, the indoor units will not be able to perform at the rated capacity when they are operated simultaneously. Select a combination of units so that the total capacity of the connected indoor units is at or below the capacity of the outdoor unit whenever possible.

(2) High COP combinations

Outdoor units	Composing units			Maximum total capacity of connectable indoor units	Maximum number of connectable indoor units	Types of connectable indoor units
EP200	-	-	-	100 - 260	17	P15 - P200 models R410A series indoor units
EP250	-	-	-	125 - 325	21	
EP300	-	-	-	150 - 390	26	
EP400	EP200	EP200	-	200 - 520	34	P15 - P500 models R410A series indoor units
EP450	(E)P250	EP200	-	225 - 585	39	
EP500	EP300	EP200	-	250 - 650	43	
EP550	EP300	(E)P250	-	275 - 715	47	
EP600	EP300	EP300	-	300 - 780	50	
EP650	EP350	EP300	-	325 - 845		
EP700	EP300	EP200	EP200	350 - 910		
EP750	EP300	EP250	EP200	375 - 975		
EP800	EP300	EP300	EP200	400 - 1040		
EP850	EP300	EP300	(E)P250	425 - 1105		
EP900	EP300	EP300	EP300	450 - 1170		

Note

- 1) "Maximum total capacity of connectable indoor units" refers to the sum of the numeric values in the indoor unit model names.
- 2) If the total capacity of the indoor units that are connected to a given outdoor unit exceeds the capacity of the outdoor unit, the indoor units will not be able to perform at the rated capacity when they are operated simultaneously. Select a combination of units so that the total capacity of the connected indoor units is at or below the capacity of the outdoor unit whenever possible.

[2] Types and Maximum allowable Length of Cables

1. Wiring work

(1) Notes

- 1) Have all electrical work performed by an authorized electrician according to the local regulations and instructions in this manual.
- 2) Install external transmission cables at least 5cm [1-31/32"] away from the power supply cable to avoid noise interference. (Do not put the control cable and power supply cable in the same conduit tube.)
- 3) Provide grounding for the outdoor unit as required.
- 4) Run the cable from the electric box of the indoor or outdoor unit in such way that the box is accessible for servicing.
- 5) Do not connect power supply wiring to the terminal block for transmission line. Doing so will damage the electronic components on the terminal block.
- 6) Use 2-core shielded cables as transmission cables.

Use a separate 2-core control cable for each refrigerant system. Do not use a single multiple-core cable to connect indoor units that belong to different refrigerant systems. The use of a multiple-core cable may result in signal transmission errors and malfunctions.

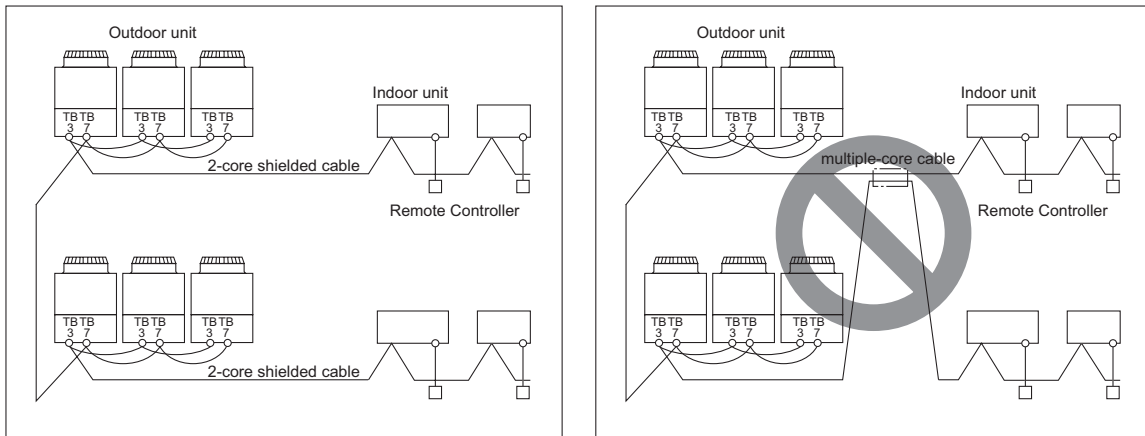

TB3: Terminal block for indoor-outdoor transmission line TB7: Terminal block for centralized control

(2) Control wiring

Different types of control wiring are used for different systems.

Refer to section "[5] An Example of a System to which an MA Remote Controller is connected - [7] An Example of a System to which both MA Remote Controller and ME Remote Controller are connected" before performing wiring work.

Types and maximum allowable length of cables

Control lines are categorized into 2 types: transmission line and remote controller line.

Use the appropriate type of cables and observe the maximum allowable length specified for a given system. If a given system has a long transmission line or if a noise source is located near the unit, place the unit away from the noise source to reduce noise interference.

1) M-NET transmission line

Cable type	Facility type	All facility types
	Type	Shielded cable CVVS, CPEVS, MVVS
	Number of cores	2-core cable
	Cable size	Larger than 1.25mm ² [AWG16]
Maximum transmission line distance between the outdoor unit and the farthest indoor unit		200 m [656ft] max.
Maximum transmission line distance for centralized control and Indoor/outdoor transmission line (Maximum line distance via outdoor unit)		500 m [1640ft] max. *The maximum overall line length from the power supply unit on the transmission lines for centralized control to each outdoor unit or to the system controller is 200m [656ft] max.

2) Remote controller wiring

		MA remote controller ^{*1}	ME remote controller ^{*2}
Cable type	Type	CVV	CVV
	Number of cores	2-core cable	2-core cable
	Cable size	0.3 to 1.25mm ² ^{*3} [AWG22 to 16] (0.75 to 1.25mm ²) ^{*4} [AWG18 to 16]	0.3 to 1.25mm ² ^{*3} [AWG22 to 16] (0.75 to 1.25mm ²) ^{*4} [AWG18 to 16]
Maximum overall line length		200 m [656ft] max.	The section of the cable that exceeds 10m [32ft] must be included in the maximum indoor-outdoor transmission line distance.

*1 MA remote controller refers to MA remote controller (PAR-20MAA, PAR-21MAA), MA simple remote controller, and wireless remote controller.

*2 ME remote controller refers to ME remote controller and ME simple remote controller.

*3 The use of cables that are smaller than 0.75mm² (AWG18) is recommended for easy handling.

*4 When connected to the terminal block on the Simple remote controller, use cables that meet the cable size specifications shown in the parenthesis.

[3] Switch Settings and Address Settings

1. Switch setting

Refer to section "[5] An Example of a System to which an MA Remote Controller is connected - [7] An Example of a System to which both MA Remote Controller and ME Remote Controller are connected" before performing wiring work.

Set the switches while the power is turned off.

If the switch settings are changed while the unit is being powered, those changes will not take effect, and the unit will not function properly.

Units on which to set the switches		Symbol	Units to which the power must be shut off
CITY MULTI indoor unit	Main/sub unit	IC	Outdoor units ^{*3} and Indoor units
LOSSNAY, OA processing unit ^{*1}		LC	Outdoor units ^{*3} and LOSSNAY
Air handling kit		IC	Outdoor units ^{*3} or field supplied air handling unit
ME remote controller	Main/sub remote controller	RC	Outdoor units ^{*3}
MA remote controller	Main/sub remote controller	MA	Indoor units
CITY MULTI outdoor unit ^{*2}		OC,OS1,OS2	Outdoor units ^{*3}

*1. Applicable when LOSSNAY units are connected to the indoor-outdoor transmission line.

*2. The outdoor units in the same refrigerant circuit are automatically designated as OC, OS1, and OS2 in the order of capacity from large to small (if two or more units have the same capacity, in the order of address from small to large).

*3. Turn off the power to all the outdoor units in the same refrigerant circuit.

2. M-NET Address settings

(1) Address settings table

The need for address settings and the range of address setting depend on the configuration of the system.

Unit or controller		Address setting range	Setting method	Factory setting
CITY MULTI indoor unit	Main/sub unit	00, 01 to 50 ^{*1}	Assign the smallest address to the main indoor unit in the group, and assign sequential address numbers to the rest of the indoor units in the same group. ^{*4}	00
M-NET adapter				
M-NET control interface				
Free Plan adapter				
LOSSNAY, OA processing unit Air handling kit		00, 01 to 50 ^{*1}	Assign an arbitrary but unique address to each of these units after assigning an address to all indoor units.	00
ME remote controller	Main remote controller	101 to 150	Add 100 to the smallest address of all the indoor units in the same group.	101
	Sub remote controller	151 to 200 ^{*2}	Add 150 to the smallest address of all the indoor units in the same group.	
MA remote controller		No address settings required. (The main/sub setting must be made if 2 remote controllers are connected to the system.)		Main
CITY MULTI outdoor unit		00, 51 to 100 ^{*1,*3}	Assign sequential addresses to the outdoor units in the same refrigerant circuit. The outdoor units in the same refrigerant circuit are automatically designated as OC and OS. ^{*5}	00
System controller	Group remote controller	201 to 250	Assign an address that equals the sum of the smallest group number of the group to be controlled and 200.	201
	System remote controller		Assign an arbitrary but unique address within the range listed on the left to each unit.	
	ON/OFF remote controller		Assign an address that equals the sum of the smallest group number of the group to be controlled and 200.	
	Schedule timer (compatible with M-NET)		Assign an arbitrary but unique address within the range listed on the left to each unit.	
	Central controller G(B)-50A	000, 201 to 250	Assign an arbitrary but unique address within the range listed on the left to each unit. The address must be set to "000" to control the K-control unit.	000
	LM adapter	201 to 250	Assign an arbitrary but unique address within the range listed on the left to each unit.	247

*1. Address setting is not required for a City Multi system that consists of a single refrigerant circuit (with some exceptions).

*2. To set the ME remote controller address to "200", set the rotary switches to "00".

*3. To set the outdoor unit address to "100," set the rotary switches to "50."

*4. Some indoor units have 2 or 3 controller boards that require address settings.

No. 2 controller board address must be equal to the sum of the No. 1 controller board address and 1, and the No.3 controller board address must equal to the No. 1 controller address and 2.

*5. The outdoor units in the same refrigerant circuit are automatically designated as OC, OS1, and OS2 in the order of capacity from large to small (if two or more units have the same capacity, in the order of address from small to large).

**(2) Power supply switch connector connection on the outdoor unit
(Factory setting: The male power supply switch connector is connected to CN41.)**

System configuration	Connection to the system controller	Power supply unit for transmission lines	Group operation of units in a system with multiple outdoor units	Power supply switch connector connection
System with one outdoor unit	–	–	–	Leave CN41 as it is (Factory setting)
System with multiple outdoor units	Not connected	–	Not grouped	Disconnect the male connector from the female power supply switch connector (CN41) and connect it to the female power supply switch connector (CN40) on only one of the outdoor units.* ² *Connect the S (shielded) terminal on the terminal block (TB7) on the outdoor unit whose CN41 was replaced with CN40 to the ground terminal (⌈) on the electric box.
			Grouped	
	With connection to the indoor unit system	Not required	Grouped/not grouped	
			Grouped/not grouped	
With connection to the centralized control system	Not required* ¹ (Powered from the outdoor unit)	Grouped/not grouped	Leave CN41 as it is (Factory setting)	
		Required* ¹	Grouped/not grouped	

*1 The need for a power supply unit for transmission lines depends on the system configuration.

*2 The replacement of the power jumper connector from CN41 to CN40 must be performed on only one outdoor unit in the system.

(3) Settings for the centralized control switch for the outdoor unit (Factory setting: SW2-1 are set to OFF.)

System configuration	Centralized control switch settings* ¹
Connection to the system controller Not connected	Leave it to OFF. (Factory setting)
Connection to the system controller Connected* ²	ON

*1 Set SW2-1 on all outdoor units in the same refrigerant circuit to the same setting.

*2 When only the LM adapter is connected, leave SW2-1 to OFF (as it is).

(4) Selecting the position of temperature detection for the indoor unit (Factory setting: SW1-1 set to "OFF".)

To stop the fan during heating Thermo-OFF (SW1-7 and 1-8 on the indoor units to be set to ON), use the built-in thermistor on the remote controller or an optional thermistor.

1) To use the built-in sensor on the remote controller, set the SW1-1 to ON.

•Some models of remote controllers are not equipped with a built-in temperature sensor.

Use the built-in temperature sensor on the indoor unit instead.

•When using the built-in sensor on the remote controller, install the remote controller where room temperature can be detected. (Note) Factory setting for SW1-1 on the indoor unit of the All-Fresh Models is ON.

2) When an optional temperature sensor is used, set SW1-1 to OFF, and set SW3-8 to ON.

•When using an optional temperature sensor, install it where room temperature can be detected.

(5) Various start-stop controls (Indoor unit settings)

Each indoor unit (or group of indoor units) can be controlled individually by setting SW 1-9 and 1-10.

Function	Operation of the indoor unit when the operation is resumed after the unit was stopped	Setting (SW1)* ⁴ * ⁵	
		9	10
Power ON/OFF by the plug* ^{1,2,3}	Indoor unit will go into operation regardless of its operation status before power off (power failure). (In approx. 5 minutes)	OFF	ON
Automatic restoration after power failure	Indoor unit will go into operation if it was in operation when the power was turned off (or cut off due to power failure). (In approx. 5 minutes)	ON	OFF
	Indoor unit will remain stopped regardless of its operation status before power off (power failure).	OFF	ON

*1. Do not cut off power to the outdoor unit. Cutting off the power supply to the outdoor unit will cut off the power supply to the crankcase heater and may cause the compressor to malfunction when the unit is put back into operation.

*2. Not applicable to units with a built-in drain pump or humidifier.

*3. Models with a built-in drain pump cannot be turned on/off by the plug individually. All the units in the same refrigerant circuits will be turned on or off by the plug.

*4. Requires that the dipswitch settings for all the units in the group be made.

*5. To control the external input to and output from the air conditioners with the PLC software for general equipment via the G(B)-50A, set SW1-9 and SW1-10 to ON. With these settings made, the power start-stop function becomes disabled. To use the auto recovery function after power failure while these settings are made, set SW1-5 to ON.

(6) Miscellaneous settings

Cooling-only setting for the indoor unit: Cooling only model (Factory setting: SW3-1 "OFF.")
 When using indoor unit as a cooling-only unit, set SW3-1 to ON.

(7) Various types of control using input-output signal connector on the outdoor unit (various connection options)

Type	Usage	Function	Terminal to be used ^{*1}	Option
Input	Prohibiting cooling/heating operation (thermo OFF) by an external input to the outdoor unit. *It can be used as the DEMAND control device for each system.	DEMAND (level)	CN3D ^{*2}	Adapter for external input (PAC-SC36NA-E)
	Performs a low level noise operation of the outdoor unit by an external input to the outdoor unit. * It can be used as the silent operation device for each refrigerant system.	Low-noise mode (level) ^{*3*4}		
	Forces the outdoor unit to perform a fan operation by receiving signals from the snow sensor. ^{*5}	Snow sensor signal input (level)	CN3S	
	Cooling/heating operation can be changed by an external input to the outdoor unit.	Auto-changeover	CN3N	
Out-put	How to extract signals from the outdoor unit *It can be used as an operation status display device. *It can be used for an interlock operation with external devices.	Operation status of the compressor	CN51	Adapter for external output (PAC-SC37SA-E)
		Error status		

- *1. For detailed drawing, refer to "Example of wiring connection".
- *2. For details, refer to (1) through (4) shown below.
- *3. Low-noise mode is valid when Dip SW4-4 on the outdoor unit is set to OFF. When DIP SW4-4 is set to ON, 4 levels of on-DEMAND are possible, using different configurations of low-noise mode input and DEMAND input settings. When 2 or more outdoor units exist in one refrigerant circuit system, 8 levels of on-DEMAND are possible. When 3 outdoor units exist in one refrigerant circuit system, 12 levels of on-DEMAND are possible.
- *4. By setting Dip SW5-5, the Low-noise mode can be switched between the Capacity priority mode and the Low-noise priority mode.
 When SW5-5 is set to ON: The Low-noise mode always remains effective.
 When SW5-5 is set to OFF: The Low-noise mode is cancelled when certain outside temperature or pressure criteria are met, and the unit goes into normal operation (capacity priority mode).

Low-noise mode is effective		Capacity priority mode becomes effective	
Cooling	Heating	Cooling	Heating
TH7 < 30°C [86°F] and 63HS1 < 32kg/cm ²	TH7 > 3°C [37°F] and 63LS > 4.6kg/cm ²	TH7 > 35°C [95°F] or 63HS1 > 35kg/cm ²	TH7 < 0°C [32°F] or 63LS < 3.9kg/cm ²

- *5. When multiple outdoor units exist in one refrigerant circuit system, settings on every outdoor unit (signal input) are required.

⚠ CAUTION

- 1) Wiring should be covered by insulation tube with supplementary insulation.
- 2) Use relays or switches with IEC or equivalent standard.
- 3) The electric strength between accessible parts and control circuit should have 2750V or more.

Example of wiring connection

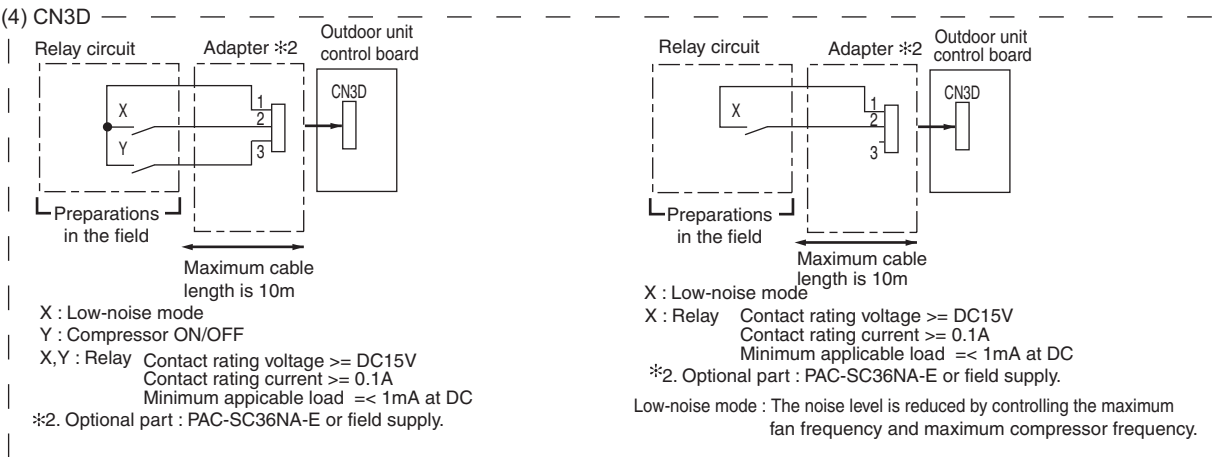
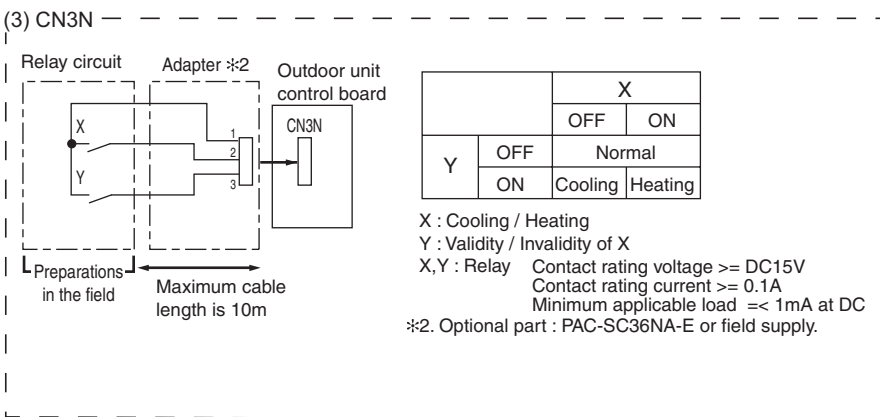
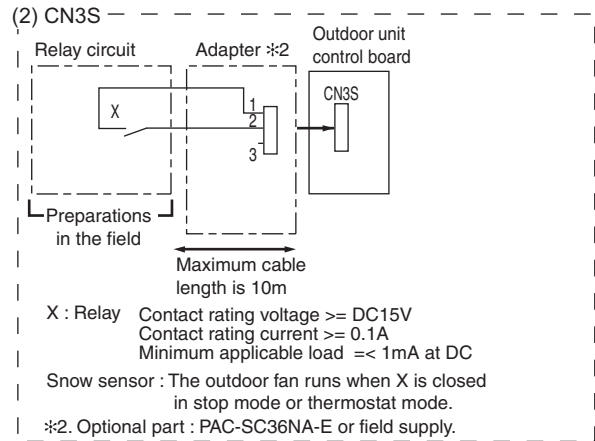
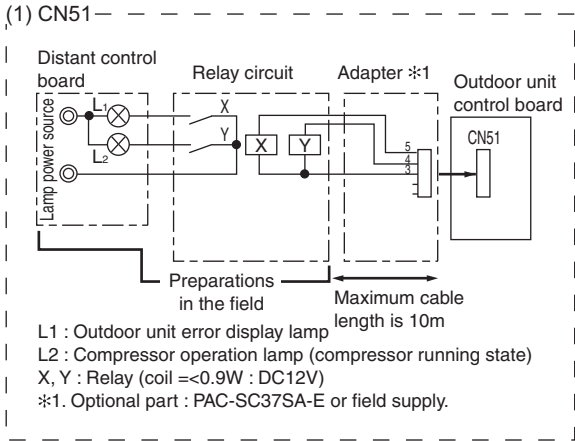

1. Demand control

(1) General outline of control

Demand control is performed by using the external signal input to the 1-2 and 1-3 pins of CN3D on the outdoor units (OC, OS1, and OS2).

Between 2 and 12 steps of demand control is possible by setting DIP SW4-4 on the outdoor units (OC, OS1, and OS2).

Table.1

No	Demand control switch	DipSW4-4			Input to CN3D *2
		OC	OS1	OS2	
(a)	2 steps(0-100%)	OFF	OFF	OFF	OC
(b)	4 steps(0-50-75-100%)	ON	OFF	OFF	OC
(c)		OFF	ON	OFF	OS1
(d)		OFF	OFF	ON	OS2
(e)	8 steps(0-25-38-50-63-75-88-100%)	ON	ON	OFF	OC and OS1
(f)		ON	OFF	ON	OC and OS2
(g)		OFF	ON	ON	OS1 and OS2
(h)	12 steps(0-17-25-34-42-50-59-67-75-84-92-100%)	ON	ON	ON	OC, OS1, and OS2

*1. Available demand functions

P200-P450YHM, EP200-EP300YHM models (single-outdoor-unit system): 2 and 4 steps shown in the rows (a) and (b) in the table above only.

P500-P900YSHM, EP400-EP650YSHM models (two-outdoor-unit system OC+OS1): 2-8 steps shown in the rows (a), (b), (c), and (e) in the table above only.

P950-P1250YSHM, EP700-EP900YSHM models (three-outdoor-unit system OC+OS1+OS2): 2-12 steps shown in the rows (a)-(h) in the table above.

*2. External signal is input to CN3D on the outdoor unit whose SW4-4 is set to ON. When SW4-4 is set to OFF on all outdoor units, the signal is input to the CN3D on the OC.

Outdoor units whose SW4-4 is set to ON are selectable in a single refrigerant system.

*3. If wrong sequence of steps are taken, the units may go into the Thermo-OFF (compressor stop) mode.

Ex) When switching from 100% to 50%

(Incorrect) 100% to 0% to 50% : The units may go into the Thermo-OFF mode.

(Correct) 100% to 75% to 50%

*4. The percentage of the demand listed in the table above is an approximate value based on the compressor volume and does not necessarily correspond with the actual capacity.

*5. Notes on using demand control in combination with the low-noise mode

To enable the low-noise mode, it is necessary to short-circuit 1-2 pin of CN3D on the outdoor unit whose SW4-4 is set to OFF.

When SW4-4 is set to ON on all outdoor units, the following operations cannot be performed.

- ♦Performing 4-step demand in combination with the low-noise operation in a single-outdoor-unit system.
- ♦Performing 8-step demand in combination with the low-noise operation in a two-outdoor-unit system.
- ♦Performing 12-step demand in combination with the low-noise operation in a three-outdoor-unit system.

(2) Contact input and control content

1) 2-step demand control

- ♦The same control as the Thermo-OFF is performed by closing 1-3 pin of CN3D.

CN3D	
1-3P	
Open	x = 100%
Close	x = 0%

2) 4-step demand control (When SW4-4 is set to ON on an outdoor unit)

Demand capacity is shown below.

CN3D	1-2P	
	Open	Close
1-3P		
Open	x = 100%	x = 75%
Close	x = 0%	x = 50%

3) 8-step demand control (When SW4-4 is set to ON on two outdoor units)

Demand capacity is shown below.

8-step demand		No.2 CN3D				
		1-2P	Open		Short-circuit	
No.1 CN3D	1-2P	1-3P	Open	Short-circuit	Open	Short-circuit
	Open	Open	100%	50%	88%	75%
		Short-circuit	50%	0%	38%	25%
	Short-circuit	Open	88%	38%	75%	63%
Short-circuit		75%	25%	63%	50%	

*1. The outdoor units whose SW4-4 is set to ON are designated as No. 1 and No. 2 in the order of address from small to large.

Ex) When outdoor units whose SW4-4 is set to ON are designated as OS1 and OS2, OS1=No. 1 and OS2=No. 2.

4) 12-step demand control (When SW4-4 is set to ON on three outdoor units)

Demand capacity is shown below.

12-step demand	No.2 CN3D	1-2P	Open							
		1-3P	Open				Short-circuit			
	No.3 CN3D	1-2P	Open		Short-circuit		Open		Short-circuit	
No.1 CN3D	1-2P	1-3P	Open	Short-circuit	Open	Short-circuit	Open	Short-circuit	Open	Short-circuit
	Open	Open	100%	67%	92%	84%	67%	34%	59%	50%
		Short-circuit	67%	34%	59%	50%	34%	0%	25%	17%
	Short-circuit	Open	92%	59%	84%	75%	59%	25%	50%	42%
Short-circuit		84%	50%	75%	67%	50%	17%	42%	34%	

12-step demand	No.2 CN3D	1-2P	Short-circuit							
		1-3P	Open				Short-circuit			
	No.3 CN3D	1-2P	Open		Short-circuit		Open		Short-circuit	
No.1 CN3D	1-2P	1-3P	Open	Short-circuit	Open	Short-circuit	Open	Short-circuit	Open	Short-circuit
	Open	Open	92%	59%	84%	75%	84%	50%	75%	67%
		Short-circuit	59%	25%	50%	42%	50%	17%	42%	34%
	Short-circuit	Open	84%	50%	75%	67%	75%	42%	67%	59%
Short-circuit		75%	42%	67%	59%	67%	34%	59%	50%	

*1. The outdoor units whose SW4-4 is set to ON are designated as No. 1, No. 2, and No. 3 in the order of address from small to large.

Ex) When outdoor units whose SW4-4 is set to ON are designated as OC, OS1, and OS2, OC=No. 1, OS1=No. 2, and OS2=No. 3.

[4] Sample System Connection

Examples of typical system connection are shown on pages [5] to [7].
Refer to the Installation Manual that came with each device or controller for details.

(1) An example of a system to which an MA remote controller is connected

	System configuration	Connection to the system controller	Address start up for indoor and outdoor units	Notes
1.	System with one outdoor unit	NO	Automatic address setup	
2.	System with one outdoor unit	NO	Manual address setup	Connection of multiple LOSS-NAY units
3.	Grouping of units in a system with multiple outdoor units	NO	Manual address setup	
4.	System with one outdoor unit	With connection to transmission line for centralized control	Manual address setup	
5.	System with one outdoor unit	With connection to indoor-outdoor transmission line	Manual address setup	

(2) An example of a system to which an ME remote controller is connected

	System configuration	Connection to the system controller	Address start up for indoor and outdoor units	Notes
1.	System with one outdoor unit	With connection to transmission line for centralized control	Manual address setup	

(3) An example of a system to which both MA remote controller and ME remote controller are connected

	System configuration	Connection to the system controller	Address start up for indoor and outdoor units	Notes
1.	System with one outdoor unit	With connection to transmission line for centralized control	Manual address setup	

[5] An Example of a System to which an MA Remote Controller is connected

1. System with one outdoor unit (automatic address setup for both indoor and outdoor units)

(1) Sample control wiring

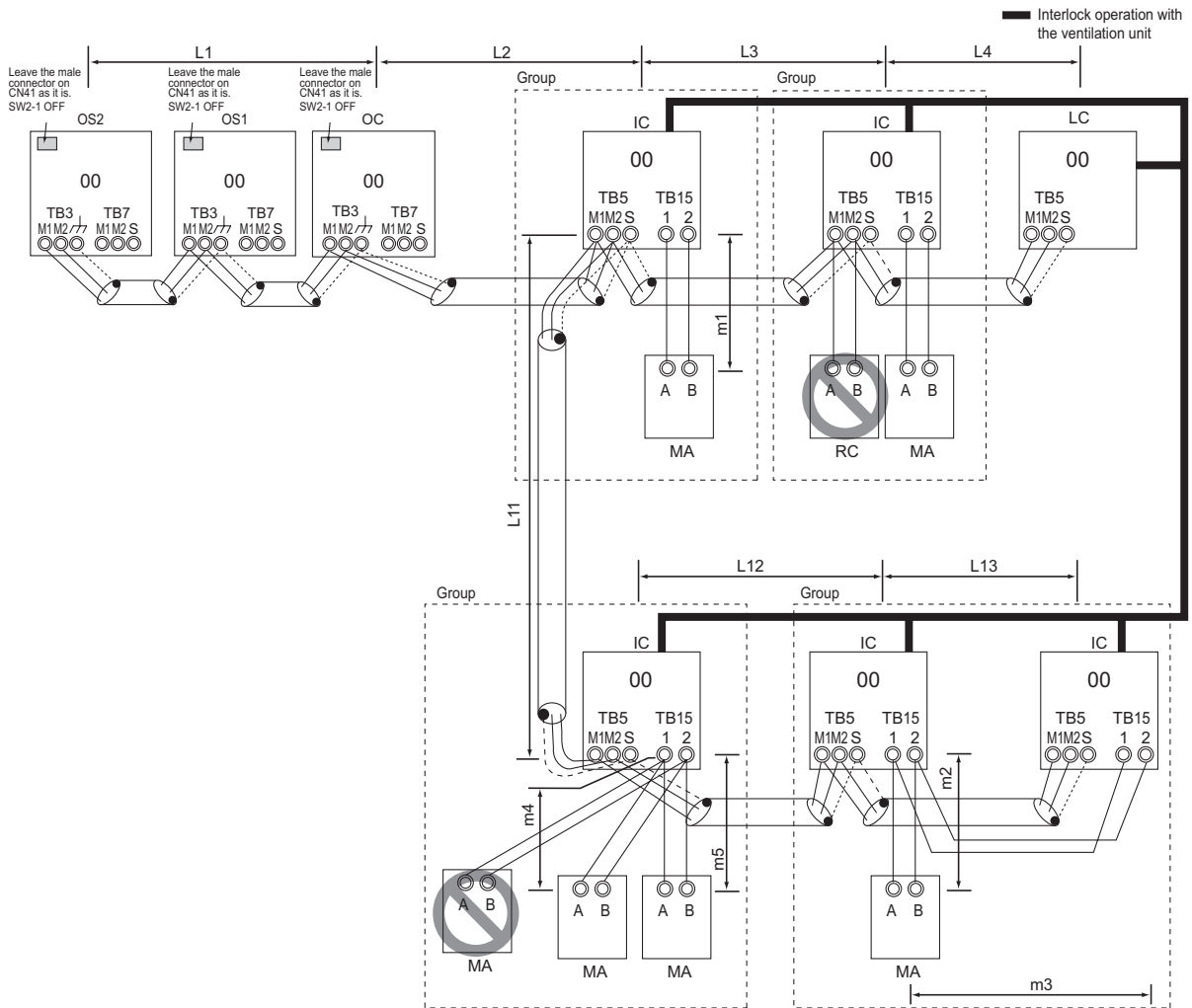

(2) Cautions

- 1) ME remote controller and MA remote controller cannot both be connected to the same group of indoor units.
- 2) No more than 2 MA remote controllers can be connected to a group of indoor units.
- 3) A transmission booster is required in a system to which more than 32 indoor units (26 units if one or more indoor units of the 200 model or above is connected) are connected.
- 4) Automatic address setup is not available if start-stop input (CN32, CN51, CN41) is used for a group operation of indoor units. Refer to "[5] 2. Manual address setup for both indoor and outdoor units".(page 30)
- 5) To connect more than 2 LOSSNAY units to indoor units in the same system, refer to the next section "[5] 2. An example of a system with one outdoor unit to which 2 or more LOSSNAY units are connected".(page 30)

(3) Maximum allowable length

- 1) Indoor/outdoor transmission line
 Maximum distance (1.25mm² [AWG16] or larger)
 $L1 + L2 + L3 + L4 \leq 200m [656ft]$
 $L1 + L2 + L11 + L12 + L13 \leq 200m [656ft]$
- 2) Transmission line for centralized control
 No connection is required.
- 3) MA remote controller wiring
 Maximum overall line length (0.3 to 1.25mm² [AWG22 to 16])
 $m1 \leq 200m [656ft]$
 $m2 + m3 \leq 200m [656ft]$
 $m4 + m5 \leq 200m [656ft]$

(4) Wiring method

1) Indoor/outdoor transmission line

Daisy-chain terminals M1 and M2 on the terminal block for indoor-outdoor transmission line (TB3) on the outdoor units (OC, OS1, OS2) (Note 1), and terminals M1 and M2 on the terminal block for indoor-outdoor transmission line (TB5) on each indoor unit (IC). (Non-polarized two-wire)

•Only use shielded cables.

Note

The outdoor units in the same refrigerant circuit are automatically designated as OC, OS1, and OS2 in the order of capacity from large to small (if two or more units have the same capacity, in the order of address from small to large).

Shielded cable connection

Daisy-chain the ground terminal ($\overline{\text{H}}$) on the outdoor units (OC, OS1, OS2), and the S terminal on the terminal block (TB5) on the indoor unit (IC) with the shield wire of the shielded cable.

2) Transmission line for centralized control

No connection is required.

3) MA remote controller wiring

Connect terminals 1 and 2 on the terminal block for MA remote controller line (TB15) on the indoor unit (IC) to the terminal block on the MA remote controller (MA). (Non-polarized two-wire)

When 2 remote controllers are connected to the system

When 2 remote controllers are connected to the system, connect terminals 1 and 2 of the terminal block (TB15) on the indoor unit (IC) to the terminal block on the two MA remote controllers.

•Set one of the MA remote controllers to sub. (Refer to

(5) Address setting method

MA remote controller function selection or the installation manual for the MA remote controller for the setting method.)

Group operation of indoor units

To perform a group operation of indoor units (IC), daisy-chain terminals 1 and 2 on the terminal block (TB15) on all indoor units (IC) in the same group, and then connect terminals 1 and 2 on the terminal block (TB15) on the indoor unit on one end to the terminal block on the MA remote controller. (Non-polarized two-wire)

•When performing a group operation of indoor units that have different functions, "Automatic indoor/outdoor address setup" is not available.

4) LOSSNAY connection

Connect terminals M1 and M2 on the terminal block (TB5) on the indoor unit (IC) to the appropriate terminals on the terminal block (TB5) on LOSSNAY (LC). (Non-polarized two-wire)

•Interlock operation setting with all the indoor units in the same system will automatically be made. (It is required that the Lossnay unit be turned on before the outdoor unit.)

•Refer to "[5] 2. Manual address setup for both indoor and outdoor units" in the following cases: performing an interlock operation of part of the indoor units in the system with a LOSSNAY unit, using LOSSNAY alone without interlocking it with any units, performing an interlock operation of more than 16 indoor units with a LOSSNAY unit, or connecting two or more LOSSNAY units to indoor units in the same system.

5) Switch setting

No address settings required.

Procedures	Unit or controller			Address setting range	Setting method	Notes	Factory setting
1	Indoor unit	Main unit	IC	No settings required.	-	To perform a group operation of indoor units that have different functions, refer to [5] 2.(page 30)	00
		Sub unit	IC				
2	LOSSNAY		LC	No settings required.	-		00
3	MA remote controller	Main remote controller	MA	No settings required.	-		Main
		Sub remote controller	MA	Sub remote controller			
4	Outdoor unit (Note)		OC OS1 OS2	No settings required.	-		00

Note

The outdoor units in the same refrigerant circuit are automatically designated as OC, OS1, and OS2.

2. An example of a system with one outdoor unit to which 2 or more LOSSNAY units are connected (manual address setup for both indoor and outdoor units)

(1) Sample control wiring

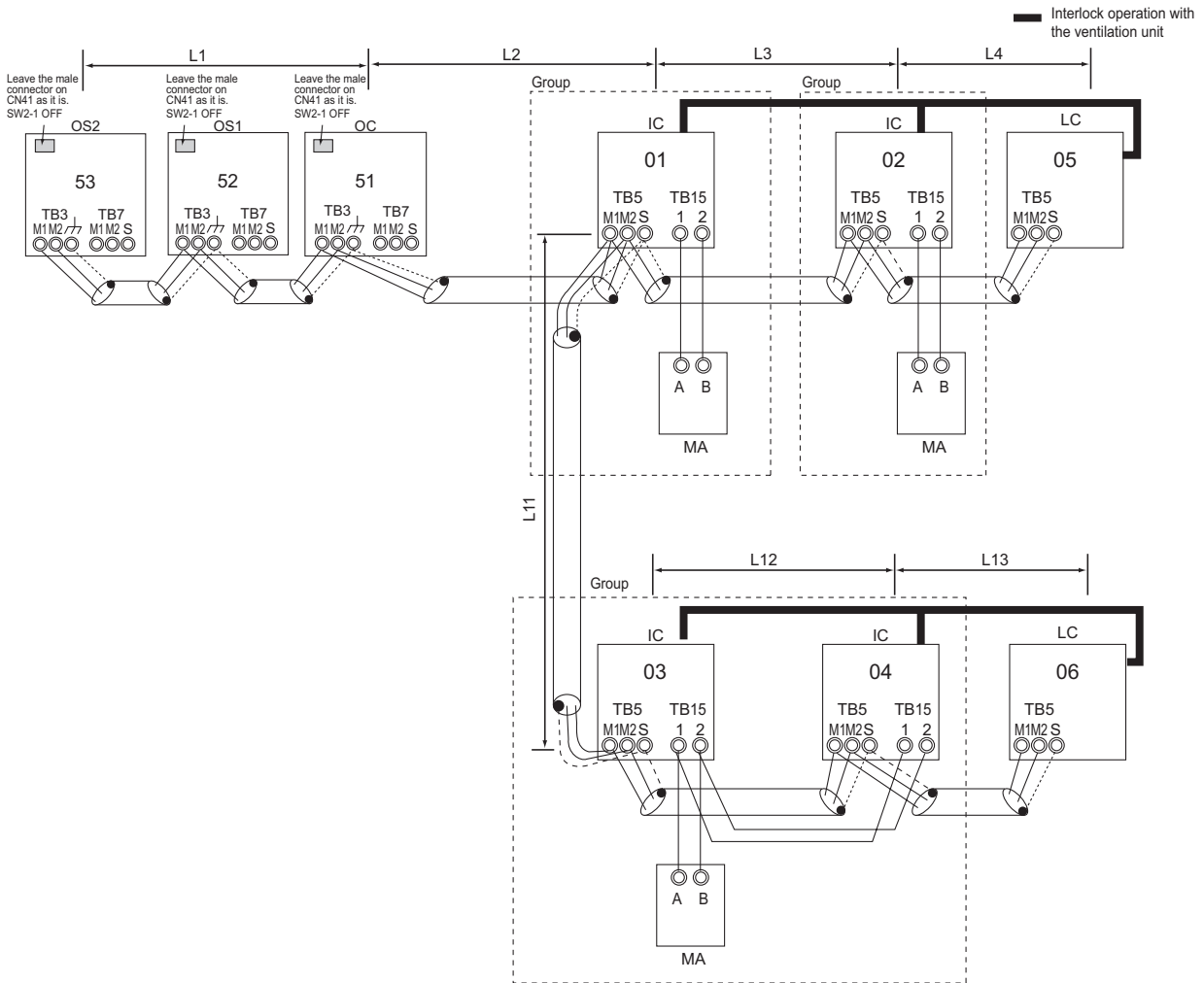

(2) Cautions

- 1) ME remote controller and MA remote controller cannot both be connected to the same group of indoor units.
- 2) No more than 2 MA remote controllers can be connected to a group of indoor units.
- 3) A transmission booster is required in a system to which more than 32 indoor units (26 units if one or more indoor units of the 200 model or above is connected) are connected.

(3) Maximum allowable length

- 1) Indoor/outdoor transmission line
Same as [5] 1.
- 2) Transmission line for centralized control
No connection is required.
- 3) MA remote controller wiring
Same as [5] 1.

(4) Wiring method

1) Indoor/outdoor transmission line

Same as [5] 1.

Shielded cable connection

Same as [5] 1.

2) Transmission line for centralized control

No connection is required.

3) MA remote controller wiring

Same as [5] 1.

When 2 remote controllers are connected to the system

Same as [5] 1.

Group operation of indoor units

Same as [5] 1.

(5) Address setting method

4) LOSSNAY connection

Connect terminals M1 and M2 on the terminal block (TB5) on the indoor unit (IC) to the appropriate terminals on the terminal block (TB5) on LOSSNAY (LC). (Non-polarized two-wire)

♦Interlock setting between the indoor units and LOSSNAY units must be entered on the remote controller. (Refer to "IV [3] Interlock Settings via the MA Remote Controller" or the installation manual for the MA remote controller for the setting method.)

5) Switch setting

Address setting is required as follows.

Procedures	Unit or controller			Address setting range	Setting method	Notes	Factory setting
1	Indoor unit	Main unit	IC	01 to 50	Assign the smallest address to the main unit in the group.	To perform a group operation of indoor units that have different functions, designate the indoor unit in the group with the greatest number of functions as the main unit.	00
		Sub unit			Assign sequential numbers starting with the address of the main unit in the same group +1. (Main unit address +1, main unit address +2, main unit address +3, etc.)		
2	LOSSNAY		LC	01 to 50	Assign an arbitrary but unique address to each of these units after assigning an address to all indoor units.	None of these addresses may overlap any of the indoor unit addresses.	00
3	MA remote controller	Main remote controller	MA	No settings required.	-		Main
		Sub remote controller	MA	Sub remote controller	Settings to be made according to the remote controller function selection		
4	Outdoor unit		OC OS1 OS2	51 to 100	Assign sequential address to the outdoor units in the same refrigerant circuit. The outdoor units are automatically designated as OC, OS1, and OS2.(Note)	To set the address to 100, set the rotary switches to 50.	00

Note

The outdoor units in the same refrigerant circuit are automatically designated as OC, OS1, and OS2.

3. Group operation of units in a system with multiple outdoor units

(1) Sample control wiring

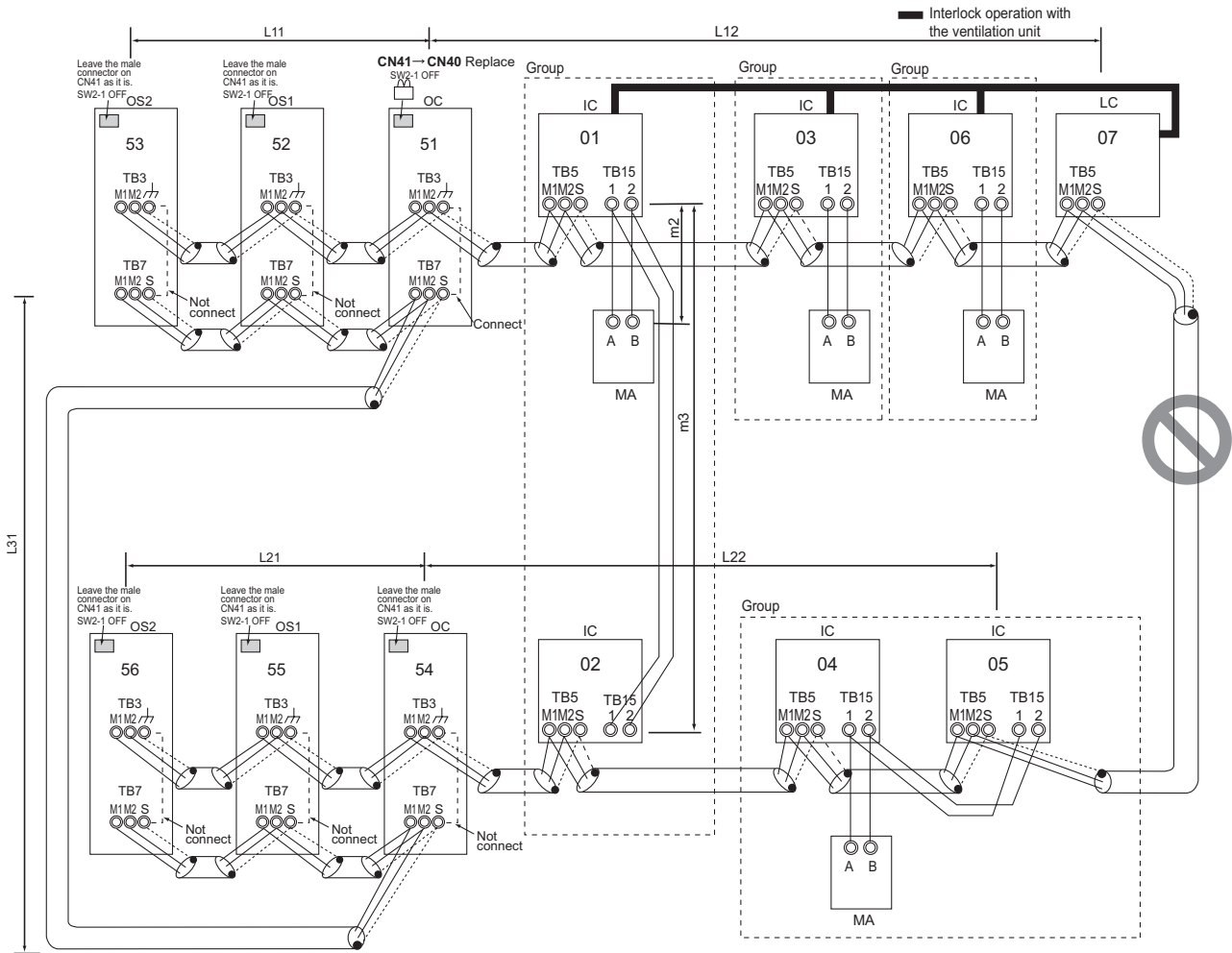

(2) Cautions

- 1) ME remote controller and MA remote controller cannot both be connected to the same group of indoor units.
- 2) No more than 2 MA remote controllers can be connected to a group of indoor units.
- 3) Do not connect the terminal blocks (TB5) on the indoor units that are connected to different outdoor units with each other.
- 4) Replacement of male power jumper connector (CN41) must be performed only on one of the outdoor units.
- 5) Provide grounding to S terminal on the terminal block for transmission line for centralized control (TB7) on only one of the outdoor units.
- 6) A transmission booster is required in a system to which more than 32 indoor units (26 units if one or more indoor units of the 200 model or above is connected) are connected.

(3) Maximum allowable length

- 1) Indoor/outdoor transmission line
 Maximum distance (1.25mm² [AWG16] or larger)
 $L11+L12 \leq 200\text{m}$ [656ft]
 $L21+L22 \leq 200\text{m}$ [656ft]
- 2) Transmission line for centralized control
 $L31+L21 \leq 200\text{m}$ [656ft]
- 3) MA remote controller wiring
 Same as [5] 1.
- 4) Maximum line distance via outdoor unit
 (1.25mm² [AWG16] or larger)
 $L12+L31+L22 \leq 500\text{m}$ [1640ft]
 $L11+L31+L21 \leq 500\text{m}$ [1640ft]

(4) Wiring method

- 1) Indoor/outdoor transmission line

Same as [5] 1.

•Only use shielded cables.

Shielded cable connection

Same as [5] 1.

- 2) Transmission line for centralized control

Daisy-chain terminals M1 and M2 on the terminal block for transmission line for centralized control (TB7) on the outdoor units (OC) in different refrigerant circuits and on the OC, OS1, and OS2 in the same refrigerant circuit
If a power supply unit is not connected to the transmission line for centralized control, replace the power jumper connector on the control board from CN41 to CN40 on only one of the outdoor units.

Note

The outdoor units in the same refrigerant circuit are automatically designated as OC, OS1, and OS2 in the order of capacity from large to small (if two or more units have the same capacity, in the order of address from small to large).

•Only use shielded cables.

Shielded cable connection

Daisy-chain the S terminal on the terminal block (TB7) on the outdoor units (OC, OS1, OS2) with the shield wire of the shielded cable. Short-circuit the earth terminal (⏏) and the S terminal on the terminal block (TB7) on the outdoor unit whose power jumper connector is mated with CN40.

- 3) MA remote controller wiring

Same as [5] 1.

When 2 remote controllers are connected to the system

Same as [5] 1.

Group operation of indoor units

Same as [5] 2.

- 4) LOSSNAY connection

Same as [5] 2.

- 5) Switch setting

Address setting is required as follows.

(5) Address setting method

Procedures	Unit or controller			Address setting range	Setting method	Notes	Factory setting
1	Indoor unit	Main unit	IC	01 to 50	Assign the smallest address to the main unit in the group.	To perform a group operation of indoor units that have different functions, designate the indoor unit in the group with the greatest number of functions as the main unit.	00
		Sub unit			Assign sequential numbers starting with the address of the main unit in the same group +1. (Main unit address +1, main unit address +2, main unit address +3, etc.)		
2	LOSSNAY		LC	01 to 50	Assign an arbitrary but unique address to each of these units after assigning an address to all indoor units.	None of these addresses may overlap any of the indoor unit addresses.	00
3	MA remote controller	Main remote controller	MA	No settings required.	-		Main
		Sub remote controller	MA	Sub remote controller	Settings to be made according to the remote controller function selection		
4	Outdoor unit		OC OS1 OS2	51 to 100	Assign sequential address to the outdoor units in the same refrigerant circuit. The outdoor units are automatically designated as OC, OS1, and OS2. (Note)	To set the address to 100, set the rotary switches to 50.	00

Note

The outdoor units in the same refrigerant circuit are automatically designated as OC, OS1, and OS2.

4. A system in which a system controller is connected to the transmission line for centralized control and which is powered from an outdoor unit

(1) Sample control wiring

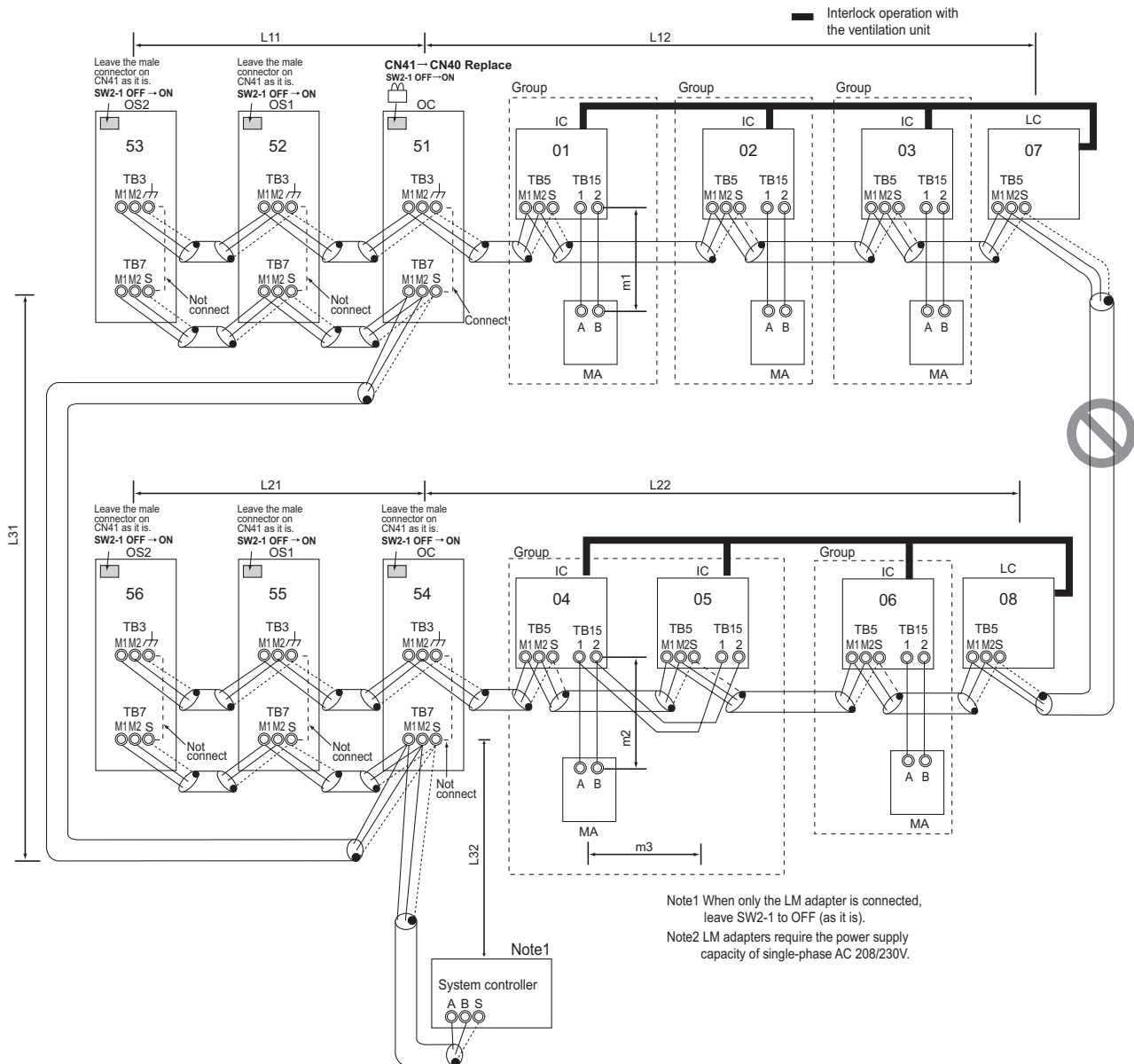

(2) Cautions

- 1) ME remote controller and MA remote controller cannot both be connected to the same group of indoor units.
- 2) No more than 2 MA remote controllers can be connected to a group of indoor units.
- 3) Do not connect the terminal blocks (TB5) on the indoor units that are connected to different outdoor units with each other.
- 4) Replacement of male power jumper connector (CN41) must be performed only on one of the outdoor units.
- 5) Short-circuit the shield terminal (S terminal) and the earth terminal (⏏) on the terminal block for transmission line for centralized control (TB7) on the outdoor unit whose power jumper connector is mated with CN40.
- 6) A transmission booster is required in a system to which more than 32 indoor units (26 units if one or more indoor units of the 200 model or above is connected) are connected.
- 7) When a power supply unit is connected to the transmission line for centralized control, leave the power jumper connector on CN41 as it is (factory setting).

(3) Maximum allowable length

- 1) Indoor/outdoor transmission line
Same as [5] 3.
- 2) Transmission line for centralized control
 $L_{31} + L_{32}(L_{21}) \leq 200\text{m}$ [656ft]
- 3) MA remote controller wiring
Same as [5] 1.
- 4) Maximum line distance via outdoor unit
(1.25mm² [AWG16] or larger)
 $L_{32} + L_{31} + L_{12}(L_{11}) \leq 500\text{m}$ [1640ft]
 $L_{32} + L_{22}(L_{21}) \leq 500\text{m}$ [1640ft]
 $L_{12}(L_{11}) + L_{31} + L_{22}(L_{21}) \leq 500\text{m}$ [1640ft]

(4) Wiring method

- 1) Indoor/outdoor transmission line
Same as [5] 1.
Only use shielded cables.

Shielded cable connection

Same as [5] 1.

- 2) Transmission line for centralized control

Daisy-chain terminals A and B on the system controller, terminals M1 and M2 on the terminal block for transmission line for centralized control (TB7) on the outdoor units (OC) in different refrigerant circuits and on the outdoor units (OC, OS1, and OS2) in the same refrigerant circuit.

If a power supply unit is not connected to the transmission line for centralized control, replace the power jumper connector on the control board from CN41 to CN40 on only one of the outdoor units.

If a system controller is connected, set the central control switch (SW2-1) on the control board of all outdoor units to "ON."

Note

The outdoor units in the same refrigerant circuit are automatically designated as OC, OS1, and OS2 in the order of capacity from large to small (if two or more units have the same capacity, in the order of address from small to large).

•Only use shielded cables.

(5) Address setting method

Shielded cable connection

Daisy-chain the S terminal on the terminal block (TB7) on the outdoor units (OC, OS1, OS2) with the shield wire of the shielded cable. Short-circuit the earth terminal (E) and the S terminal on the terminal block (TB7) on the outdoor unit whose power jumper connector is mated with CN40.

- 3) MA remote controller wiring

Same as [5] 1.

When 2 remote controllers are connected to the system

Same as [5] 1.

Group operation of indoor units

Same as [5] 1.

- 4) LOSSNAY connection

Connect terminals M1 and M2 on the terminal block (TB5) on the indoor unit (IC) to the appropriate terminals on the terminal block for indoor-outdoor transmission line (TB5) on LOSSNAY (LC). (Non-polarized 2-core cable)

•Indoor units must be interlocked with the LOSSNAY unit using the system controller. (Refer to the operation manual for the system controller for the setting method.) Interlock setting from the remote controller is required if the ON/OFF remote controller alone or the LM adapter alone is connected.

- 5) Switch setting

Address setting is required as follows.

Procedures	Unit or controller			Address setting range	Setting method	Notes	Factory setting
1	Indoor unit	Main unit	IC	01 to 50	Assign the smallest address to the main unit in the group.	To perform a group operation of indoor units that have different functions, designate the indoor unit in the group with the greatest number of functions as the main unit.	00
		Sub unit			Assign sequential numbers starting with the address of the main unit in the same group +1. (Main unit address +1, main unit address +2, main unit address +3, etc.)		
2	LOSSNAY		LC	01 to 50	Assign an arbitrary but unique address to each of these units after assigning an address to all indoor units.	None of these addresses may overlap any of the indoor unit addresses.	00
3	MA remote controller	Main remote controller	MA	No settings required.	-	Enter the same indoor unit group settings on the system controller as the ones that were entered on the MA remote controller.	Main
		Sub remote controller	MA	Sub remote controller	Settings to be made according to the remote controller function selection		
4	Outdoor unit		OC OS1 OS2	51 to 100	Assign sequential address to the outdoor units in the same refrigerant circuit. The outdoor units are automatically designated as OC, OS1, and OS2.(Note)	To set the address to 100, set the rotary switches to 50.	00

Note

The outdoor units in the same refrigerant circuit are automatically designated as OC, OS1, and OS2.

5. An example of a system in which a system controller is connected to the indoor-outdoor transmission line (except LM adapter)

(1) Sample control wiring

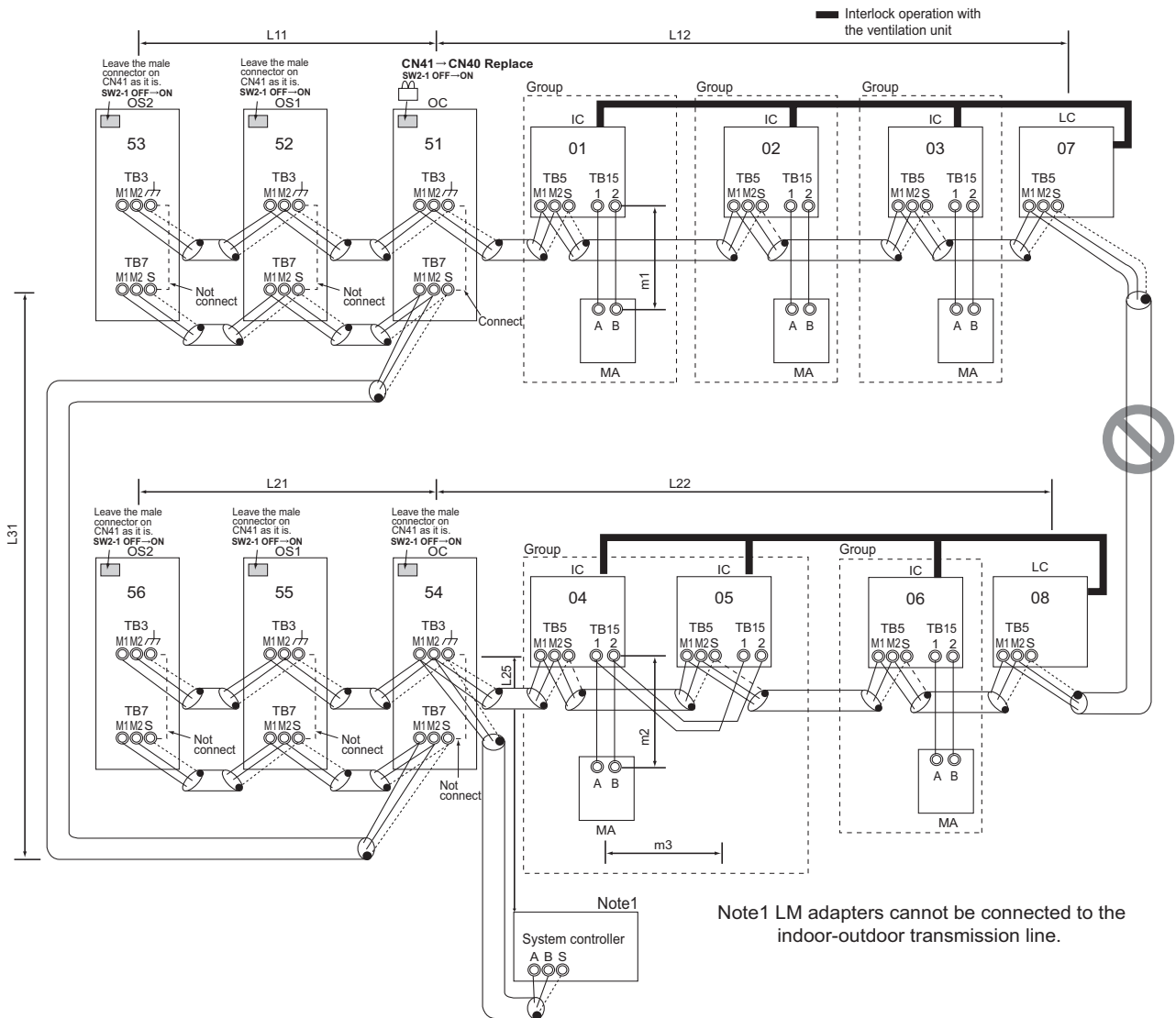

(2) Cautions

- 1) ME remote controller and MA remote controller cannot both be connected to the same group of indoor units.
- 2) No more than 2 MA remote controllers can be connected to a group of indoor units.
- 3) Do not connect the terminal blocks (TB5) on the indoor units that are connected to different outdoor units with each other.
- 4) Replacement of male power jumper connector (CN41) must be performed only on one of the outdoor units.
- 5) Provide grounding to S terminal on the terminal block for transmission line for centralized control (TB7) on only one of the outdoor units.
- 6) A maximum of 3 system controllers can be connected to the indoor-outdoor transmission line, with the exception that only one G(B)-50A may be connected.
- 7) When the total number of indoor units exceeds 26, it may not be possible to connect a system controller on the indoor-outdoor transmission line.
- 8) In a system to which more than 18 indoor units including one or more indoor units of 200 model or above are connected, there may be cases in which the system controller cannot be connected to the indoor-outdoor transmission line.

(3) Maximum allowable length

- 1) Indoor/outdoor transmission line
 Maximum distance (1.25mm² [AWG16] or larger)
 $L11+L12 \leq 200\text{m}$ [656ft]
 $L21+L22 \leq 200\text{m}$ [656ft]
 $L25 \leq 200\text{m}$ [656ft]
- 2) Transmission line for centralized control
 $L31+L21 \leq 200\text{m}$ [656ft]
- 3) MA remote controller wiring
 Same as [5] 1.
- 4) Maximum line distance via outdoor unit (1.25mm² [AWG16] or larger)
 $L25+L31+L12(L11) \leq 500\text{m}$ [1640ft]
 $L12(L11)+L31+L22(L21) \leq 500\text{m}$ [1640ft]
 $L25+L22(L21) \leq 500\text{m}$ [1640ft]

(4) Wiring method

1) Indoor/outdoor transmission line

Daisy-chain terminals M1 and M2 on the terminal block for indoor-outdoor transmission line (TB3) on the outdoor units (OC, OS1, OS2) (Note 1), terminals M1 and M2 on the terminal block for indoor-outdoor transmission line (TB5) on each indoor unit (IC), and the S terminal on the system controller. (Non-polarized two-wire)

- Only use shielded cables.

Note

The outdoor units in the same refrigerant circuit are automatically designated as OC, OS1, and OS2 in the order of capacity from large to small (if two or more units have the same capacity, in the order of address from small to large).

Shielded cable connection

Daisy-chain the ground terminal (⏏) on the outdoor units (OC, OS1, OS2), the S terminal on the terminal block (TB5) on the indoor unit (IC), and the S terminal on the system controller with the shield wire of the shielded cable.

2) Transmission line for centralized control

Daisy-chain terminals M1 and M2 on the terminal block for transmission line for centralized control (TB7) on the outdoor units (OC) in different refrigerant circuits and on the OC, OS1, and OS2 in the same refrigerant circuit. If a power supply unit is not connected to the transmission line for centralized control, replace the power jumper connector on the control board from CN41 to CN40 on only one of the outdoor units.

(5) Address setting method

Set the central control switch (SW2-1) on the control board of all outdoor units to "ON."

- Only use shielded cables.

Shielded cable connection

Daisy-chain the S terminal on the terminal block (TB7) on the outdoor units (OC, OS1, OS2) with the shield wire of the shielded cable. Short-circuit the earth terminal (⏏) and the S terminal on the terminal block (TB7) on the outdoor unit whose power jumper connector is mated with CN40.

3) MA remote controller wiring

Same as [5] 1.

When 2 remote controllers are connected to the system

Same as [5] 1.

Group operation of indoor units

Same as [5] 1.

4) LOSSNAY connection

Connect terminals M1 and M2 on the terminal block (TB5) on the indoor units (IC) to the appropriate terminals on the terminal block for indoor-outdoor transmission line (TB5) on LOSSNAY (LC). (Non-polarized two-wire)

- Indoor units must be interlocked with the LOSSNAY unit using the system controller. (Refer to the operation manual for the system controller for the setting method.) Interlock setting from the remote controller is required if the ON/OFF remote controller alone is connected.

5) Switch setting

Address setting is required as follows.

Procedures	Unit or controller		Address setting range	Setting method	Notes	Factory setting	
1	Indoor unit	Main unit	IC	01 to 50	Assign the smallest address to the main unit in the group. Assign sequential numbers starting with the address of the main unit in the same group +1. (Main unit address +1, main unit address +2, main unit address +3, etc.)	To perform a group operation of indoor units that have different functions, designate the indoor unit in the group with the greatest number of functions as the main unit.	
		Sub unit					
2	LOSSNAY		LC	01 to 50	Assign an arbitrary but unique address to each of these units after assigning an address to all indoor units.	None of these addresses may overlap any of the indoor unit addresses.	00
3	MA remote controller	Main remote controller	MA	No settings required.	-	Enter the same indoor unit group settings on the system controller as the ones that were entered on the MA remote controller.	Main
		Sub remote controller	MA	Sub remote controller			
4	Outdoor unit		OC OS1 OS2	51 to 100	Assign sequential address to the outdoor units in the same refrigerant circuit. The outdoor units are automatically designated as OC, OS1, and OS2. (Note)	To set the address to 100, set the rotary switches to 50.	00

Note

The outdoor units in the same refrigerant circuit are automatically designated as OC, OS1, and OS2.

[6] An Example of a System to which an ME Remote Controller is connected

(1) Sample control wiring

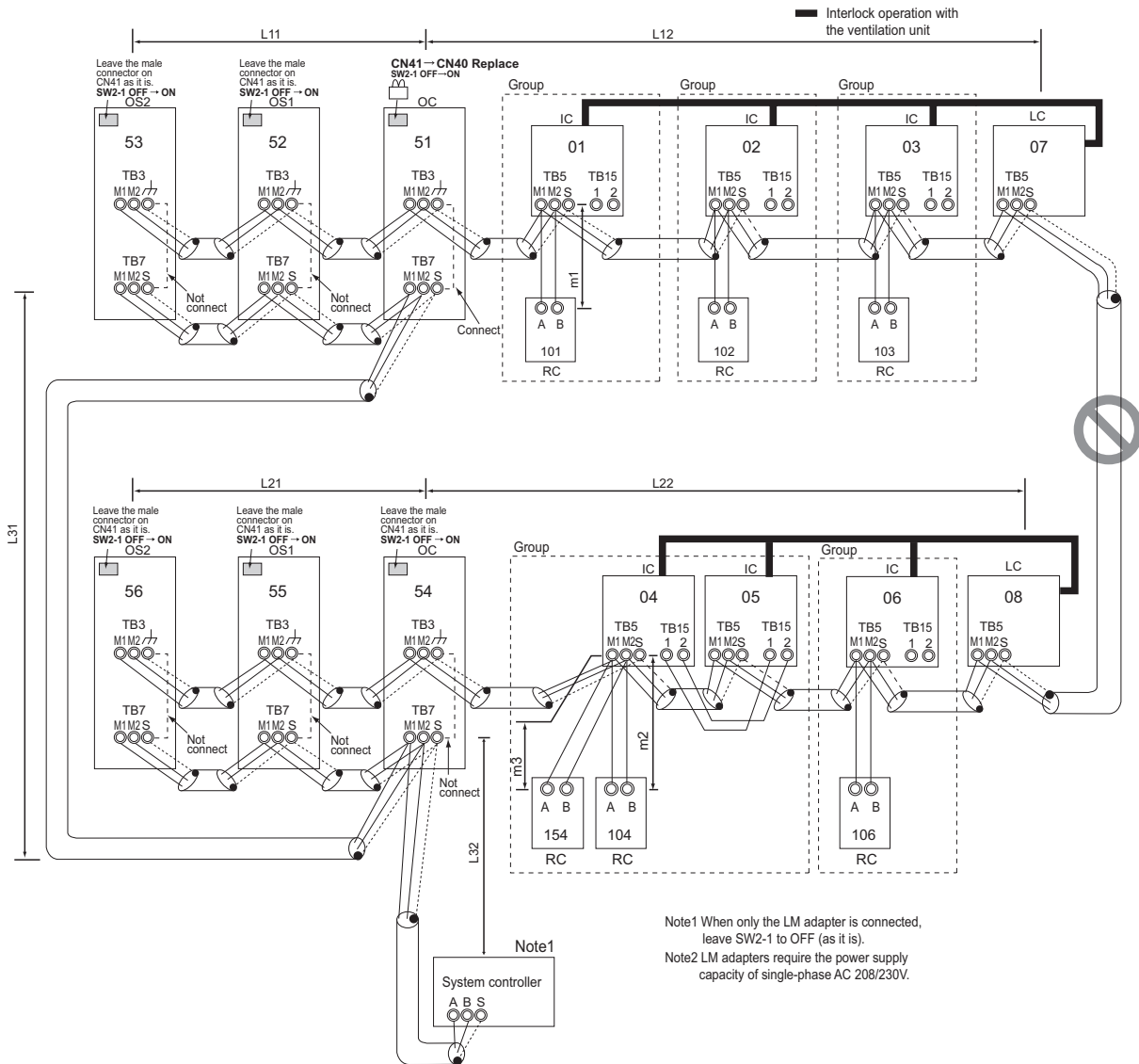

(2) Cautions

- 1) ME remote controller and MA remote controller cannot both be connected to the same group of indoor units.
- 2) No more than 3 ME remote controllers can be connected to a group of indoor units.
- 3) Do not connect the terminal blocks (TB5) on the indoor units that are connected to different outdoor units with each other.
- 4) Replace the power jumper connector of the control board from CN41 to CN40 on only one of the outdoor units.
- 5) Provide an electrical path to ground for the S terminal on the terminal block for centralized control on only one of the outdoor units.
- 6) A transmission booster must be connected to a system in which the total number of connected indoor units exceeds 20.
- 7) A transmission booster is required in a system to which more than 16 indoor including one or more indoor units of the 200 model or above are connected.
- 8) When a power supply unit is connected to the transmission line for centralized control, leave the power jumper connector on CN41 as it is (factory setting).

(3) Maximum allowable length

- 1) Indoor/outdoor transmission line
Same as [5] 3.
- 2) Transmission line for centralized control
Same as [5] 4.
- 3) ME remote controller wiring
Maximum overall line length
(0.3 to 1.25mm² [AWG22 to 16])
m1 ≤ 10m [32ft]
m2+m3 ≤ 10m [32ft]
If the standard-supplied cable must be extended, use a cable with a diameter of 1.25mm² [AWG16]. The section of the cable that exceeds 10m [32ft] must be included in the maximum indoor-outdoor transmission line distance described in (1).
When connected to the terminal block on the Simple remote controller, use cables that meet the following cable size specifications: 0.75 - 1.25 mm² [AWG18-14].
- 4) Maximum line distance via outdoor unit
(1.25mm² or larger)
Same as [5] 4.

(4) Wiring method

- 1) Indoor/outdoor transmission line
Same as [5] 1.
Shielded cable connection
Same as [5] 1.
- 2) Transmission line for centralized control
Same as [5] 4.
Shielded cable connection
Same as [5] 4.
- 3) ME remote controller wiring
ME remote controller is connectable anywhere on the indoor-outdoor transmission line.

When 2 remote controllers are connected to the system

- Refer to the section on Switch Setting.
- Performing a group operation (including the group operation of units in different refrigerant circuits).**
Refer to the section on Switch Setting.
- 4) LOSSNAY connection
Same as [5] 4.
 - 5) Switch setting
Address setting is required as follows.

(5) Address setting method

Procedures	Unit or controller			Address setting range	Setting method	Notes	Factory setting
1	Indoor unit	Main unit	IC	01 to 50	Assign the smallest address to the main unit in the group.	To perform a group operation of indoor units that have different functions, designate the indoor unit in the group with the greatest number of functions as the main unit.	00
		Sub unit			Assign sequential numbers starting with the address of the main unit in the same group +1. (Main unit address +1, main unit address +2, main unit address +3, etc.)		
2	LOSSNAY		LC	01 to 50	Assign an arbitrary but unique address to each of these units after assigning an address to all indoor units.	None of these addresses may overlap any of the indoor unit addresses.	00
3	ME remote controller	Main remote controller	RC	101 to 150	Add 100 to the main unit address in the group	<ul style="list-style-type: none"> ♦It is not necessary to set the 100s digit. ♦To set the address to 200, set the rotary switches to 00. 	101
		Sub remote controller	RC	151 to 200	Add 150 to the main unit address in the group		
4	Outdoor unit		OC OS1 OS2	51 to 100	Assign sequential address to the outdoor units in the same refrigerant circuit. The outdoor units are automatically designated as OC, OS1, and OS2. (Note)	To set the address to 100, set the rotary switches to 50.	00

Note

The outdoor units in the same refrigerant circuit are automatically designated as OC, OS1, and OS2.

[7] An Example of a System to which both MA Remote Controller and ME Remote Controller are connected

(1) Sample control wiring

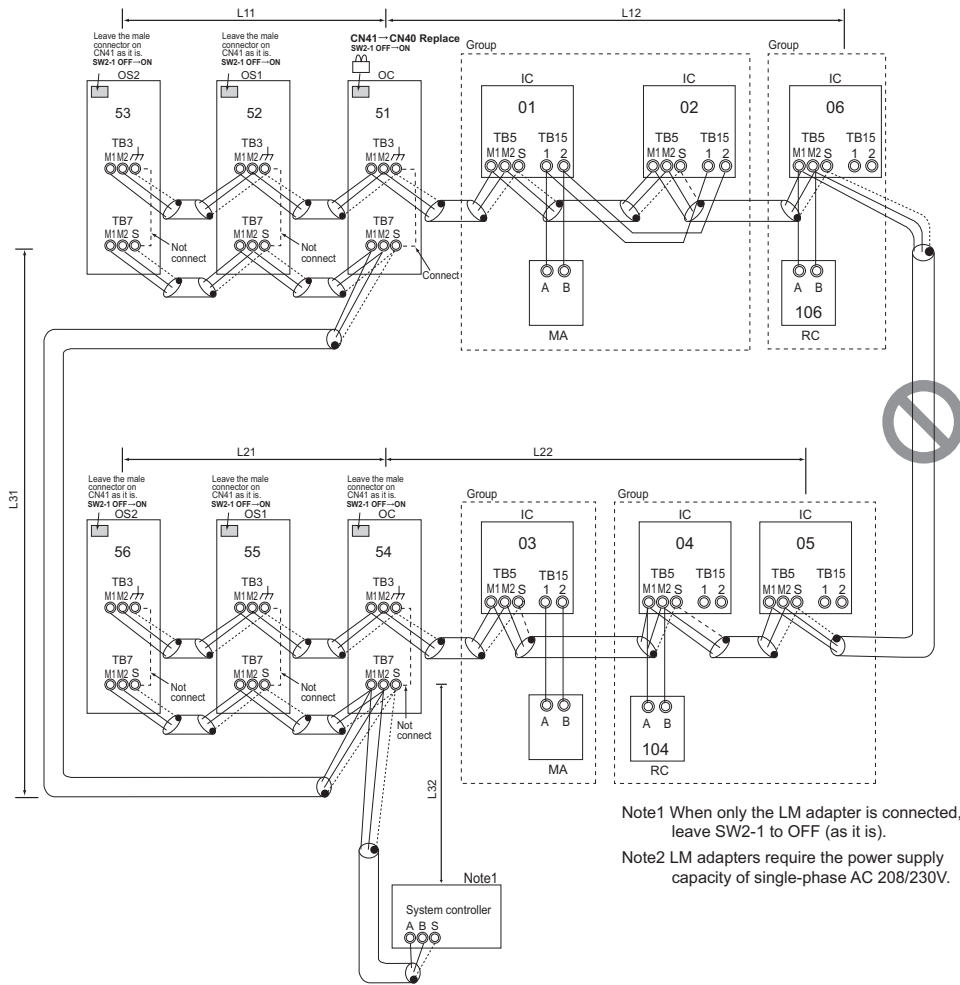

(2) Cautions

- 1) Be sure to connect a system controller.
- 2) ME remote controller and MA remote controller cannot both be connected to the same group of indoor units.
- 3) Assign to the indoor units connected to the MA remote controller addresses that are smaller than those of the indoor units that are connected to the ME remote controller.
- 4) No more than 2 ME remote controllers can be connected to a group of indoor units.
- 5) No more than 2 MA remote controllers can be connected to a group of indoor units.
- 6) Do not connect the terminal blocks (TB5) on the indoor units that are connected to different outdoor units with each other.
- 7) Replace the power jumper connector of the control board from CN41 to CN40 on only one of the outdoor units.
- 8) Provide an electrical path to ground for the S terminal on the terminal block for centralized control on only one of the outdoor units.
- 9) A transmission booster must be connected to a system in which the total number of connected indoor units exceeds 20.
- 10) A transmission booster is required in a system to which more than 16 indoor including one or more indoor units of the 200 model or above are connected.
- 11) When a power supply unit is connected to the transmission line for centralized control, leave the power jumper connector on CN41 as it is (factory setting).

(3) Maximum allowable length

- 1) Indoor/outdoor transmission line
Same as [5] 3.
- 2) Transmission line for centralized control
Same as [5] 4.
- 3) MA remote controller wiring
Same as [5] 1.
- 4) ME remote controller wiring
Same as [5] 1.
- 5) Maximum line distance via outdoor unit (1.25mm² or larger)
Same as [5] 4.

(4) Wiring method

- 1) Indoor/outdoor transmission line
Same as [5] 1.
Shielded cable connection
Same as [5] 1.
- 2) Transmission line for centralized control
Same as [5] 4.
Shielded cable connection
Same as [5] 4.
- 3) MA remote controller wiring
Same as [5] 1.
When 2 remote controllers are connected to the system

- Same as [5] 1.
Group operation of indoor units
Same as [5] 1.
- 4) ME remote controller wiring
Same as [6]
When 2 remote controllers are connected to the system
Same as [6]
Group operation of indoor units
Same as [6]
 - 5) LOSSNAY connection
Same as [5] 4.
 - 6) Switch setting
Address setting is required as follows.

(5) Address setting method

Procedures	Unit or controller				Address setting range	Setting method	Notes	Factory setting
1	Operation with the MA remote controller	Indoor unit	Main unit	IC	01 to 50	Assign the smallest address to the main unit in the group.	<ul style="list-style-type: none"> •Assign an address smaller than that of the indoor unit that is connected to the ME remote controller. •Enter the same indoor unit group settings on the system controller as the ones that were entered on the MA remote controller. •To perform a group operation of indoor units that have different functions, designate the indoor unit in the group with the greatest number of functions as the main unit. 	00
			Sub unit			Assign sequential numbers starting with the address of the main unit in the same group +1. (Main unit address +1, main unit address +2, main unit address +3, etc.)		
	MA remote controller	Main remote controller	MA	No settings required.	-	Main		
	Sub remote controller	MA	Sub remote controller	Settings to be made according to the remote controller function selection				
2	Operation with the ME remote controller	Indoor unit	Main unit	IC	01 to 50	Assign the smallest address to the main unit in the group.	<ul style="list-style-type: none"> •Enter the indoor unit group settings on the system controller (MELANS). •Assign an address larger than those of the indoor units that are connected to the MA remote controller. •To perform a group operation of indoor units that have different functions, designate the indoor unit in the group with the greatest number of functions as the main unit. 	00
			Sub unit			Assign sequential numbers starting with the address of the main unit in the same group +1. (Main unit address +1, main unit address +2, main unit address +3, etc.)		
	ME remote controller	Main remote controller	RC	101 to 150	Add 100 to the main unit address in the group.	<ul style="list-style-type: none"> •It is not necessary to set the 100s digit. •To set the address to 200, set the rotary switches to 00. 		
		Sub remote controller	RC	151 to 200	Add 150 to the main unit address in the group.			
3	LOSSNAY			LC	01 to 50	Assign an arbitrary but unique address to each of these units after assigning an address to all indoor units.	None of these addresses may overlap any of the indoor unit addresses.	00
4	Outdoor unit			OC OS1 OS2	51 to 100	Assign sequential address to the outdoor units in the same refrigerant circuit. The outdoor units are automatically designated as OC, OS1, and OS2. (Note)	To set the address to 100, set the rotary switches to 50.	00

Note

The outdoor units in the same refrigerant circuit are automatically designated as OC, OS1, and OS2.

[8] Restrictions on Pipe Length

(1) End branching

P200 - P450 models

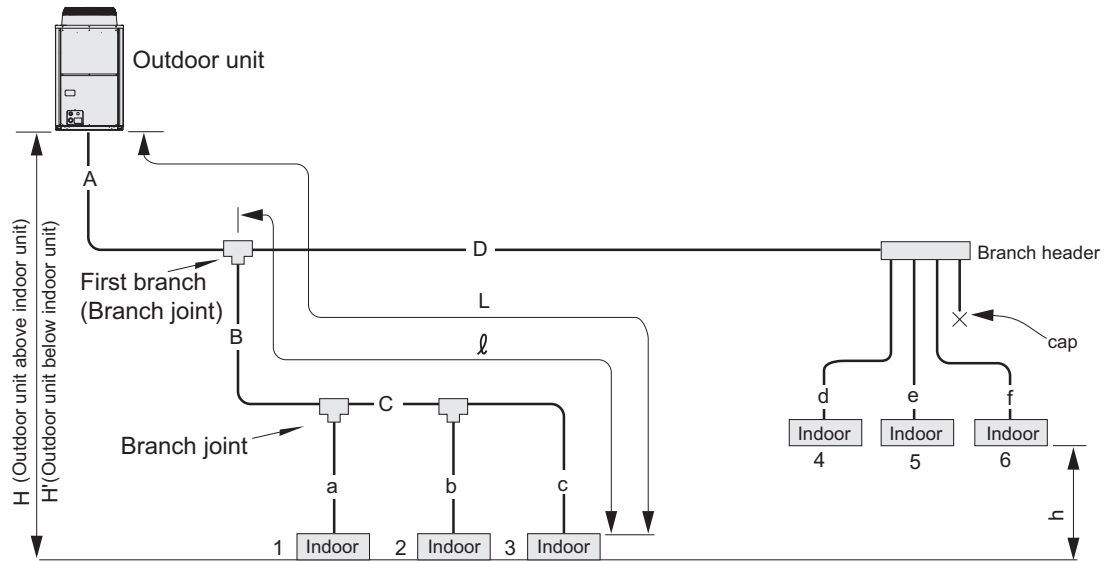

Unit: m [ft]

Operation		Pipe sections	Allowable length of pipes
Length	Total pipe length	$A+B+C+D+a+b+c+d+e+f$	1000 [3280] or less
	Total pipe length (L) from the outdoor unit to the farthest indoor unit	$A+B+C+c$ or $A+D+f$	165 [541] or less (Equivalent length 190 [623] or less)
	Total pipe length from the first branch to the farthest indoor unit (l)	$B+C+c$ or $D+f$	40 [131] or less
Height difference	Between indoor and outdoor units	Outdoor unit above indoor unit	50 [164] or less
		Outdoor unit below indoor unit	40 [131] or less
	Between indoor units	h	15 [49] or less

P500 - P1250 models

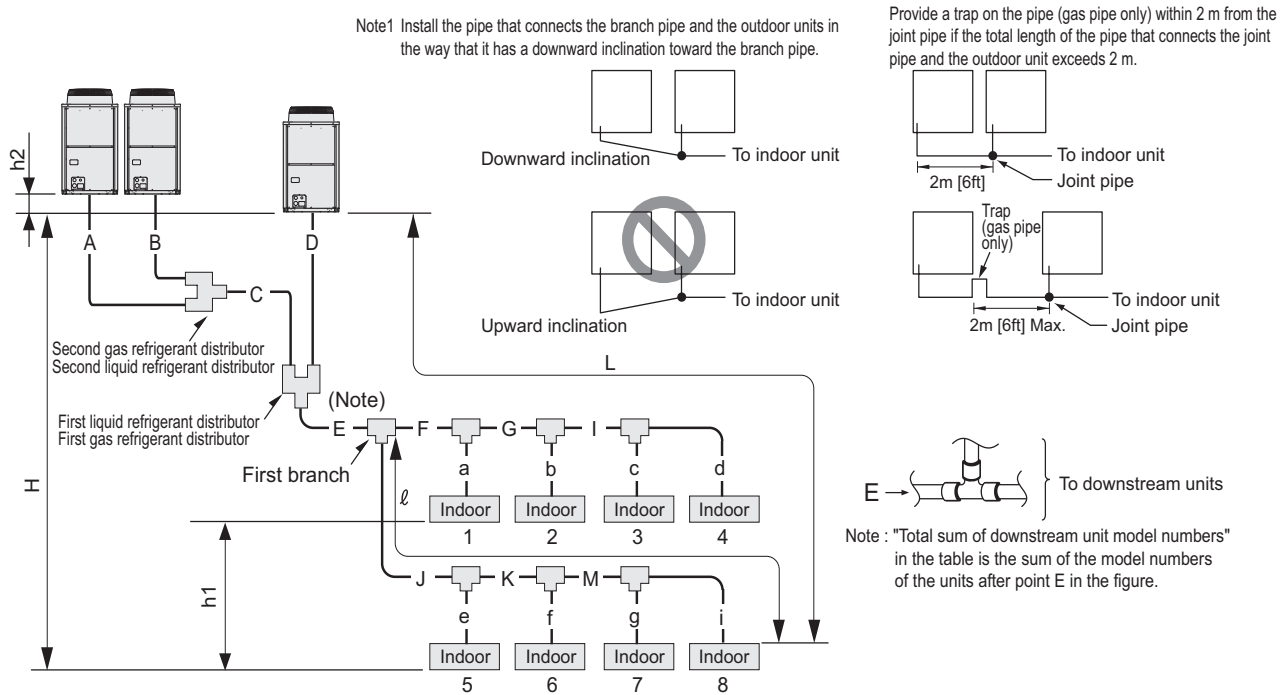

Unit: m [ft]

Operation		Pipe sections	Allowable length of pipes
Length	Between outdoor units	A+B+C+D	10 [32] or less
	Total pipe length	A+B+C+D+E+F+G+I+J+K+M+a+b+c+d+e+f+g+i	1000 [3280] or less
	Total pipe length (L) from the outdoor unit to the farthest indoor unit	A(B)+C+E+J+K+M+i	165 [541] or less (Equivalent length 190 [623] or less)
	Total pipe length from the first branch to the farthest indoor unit (ℓ)	G+I+J+i	40 [131] or less
Height difference	Between indoor and outdoor units	H	50 [164] or less (40 [131] or below if outdoor unit is below indoor unit)
	Between indoor units	h1	15 [49] or less
	Between outdoor units	h2	0.1[0.3] or less

1. Refrigerant pipe size**(1) Diameter of the refrigerant pipe between the outdoor unit and the first branch (outdoor unit pipe size)**

Outdoor unit set name (total capacity)	Liquid pipe size (mm) [inch]	Gas pipe size (mm) [inch]
200 model	ø9.52 [3/8"]	ø19.05 [3/4"]
250 model	ø9.52 [3/8"] ^{*1}	ø22.2 [7/8"]
300 model	ø9.52 [3/8"] ^{*2}	ø22.2 [7/8"]
350 model	ø12.7 [1/2"]	ø28.58 [1-1/8"]
400 model	ø12.7 [1/2"]	ø28.58 [1-1/8"]
450 model	ø15.88 [5/8"]	ø28.58 [1-1/8"]
500 model	ø15.88 [5/8"]	ø28.58 [1-1/8"]
550 model	ø15.88 [5/8"]	ø28.58 [1-1/8"]
600 model	ø15.88 [5/8"]	ø28.58 [1-1/8"]
650 model	ø15.88 [5/8"]	ø28.58 [1-1/8"]
700 - 800 model	ø19.05 [3/4"]	ø34.93 [1-3/8"]
850 - 1250 model	ø19.05 [3/4"]	ø41.28 [1-5/8"]

*1. Use ø12.7 [1/2"] pipes if the piping length exceeds 90 m [295 ft].

*2. Use ø12.7 [1/2"] pipes if the piping length exceeds 40 m [131 ft].

(2) Size of the refrigerant pipe between the first branch and the indoor unit (indoor unit pipe size)

model	Pipe diameter (mm) [inch]	
20 - 50 models	Liquid pipe	ø6.35 [1/4"]
	Gas pipe	ø12.7 [1/2"]
63 - 140 models	Liquid pipe	ø9.52 [3/8"]
	Gas pipe	ø15.88 [5/8"]
200 model	Liquid pipe	ø9.52 [3/8"]
	Gas pipe	ø19.05 [3/4"]
250 model	Liquid pipe	ø9.52 [3/8"]
	Gas pipe	ø22.2 [7/8"]
400 model	Liquid pipe	ø12.7 [1/2"]
	Gas pipe	ø28.58 [1-1/8"]
500 model	Liquid pipe	ø15.88 [5/8"]
	Gas pipe	ø28.58 [1-1/8"]

(3) Size of the refrigerant pipe between the branches for connection to indoor units

Total capacity of the downstream units	Liquid pipe size (mm) [inch]	Gas pipe size (mm) [inch]
- 140	ø9.52 [3/8"]	ø15.88 [5/8"]
P141 - P200	ø9.52 [3/8"]	ø19.05 [3/4"]
P201 - P300	ø9.52 [3/8"]	ø22.2 [7/8"]
P301 - P400	ø12.7 [1/2"]	ø28.58 [1-1/8"]
P401 - P650	ø15.88 [5/8"]	ø28.58 [1-1/8"]
P651 - P800	ø19.05 [3/4"]	ø34.93 [1-3/8"]
P801 -	ø19.05 [3/4"]	ø41.28 [1-5/8"]

(4) Size of the refrigerant pipe between the first distributor and the second distributor

Liquid pipe size (mm) [inch]	Gas pipe size (mm) [inch]
ø19.05 [3/4"]	ø34.93 [1-3/8"]

(5) Size of the refrigerant pipe between the first distributor or the second distributor and outdoor units

	Liquid pipe size (mm) [inch]	Gas pipe size (mm) [inch]
250 model	ø9.52 [3/8"]	ø22.2 [7/8"]
300 model	ø12.7 [1/2"]	
350 model		
400 model	ø15.88 [5/8"]	
450 model		

* Only applicable to the 500 model and below

III Outdoor Unit Components

[1] Outdoor Unit Components and Refrigerant Circuit	49
[2] Control Box of the Outdoor Unit.....	51
[3] Outdoor Unit Circuit Board.....	52



[1] Outdoor Unit Components and Refrigerant Circuit

1. Front view of an outdoor unit

(1) PUHY-P200, P250, P300, P350, P400, P450YHM-A, PUHY-EP200, EP250, EP300YHM-A

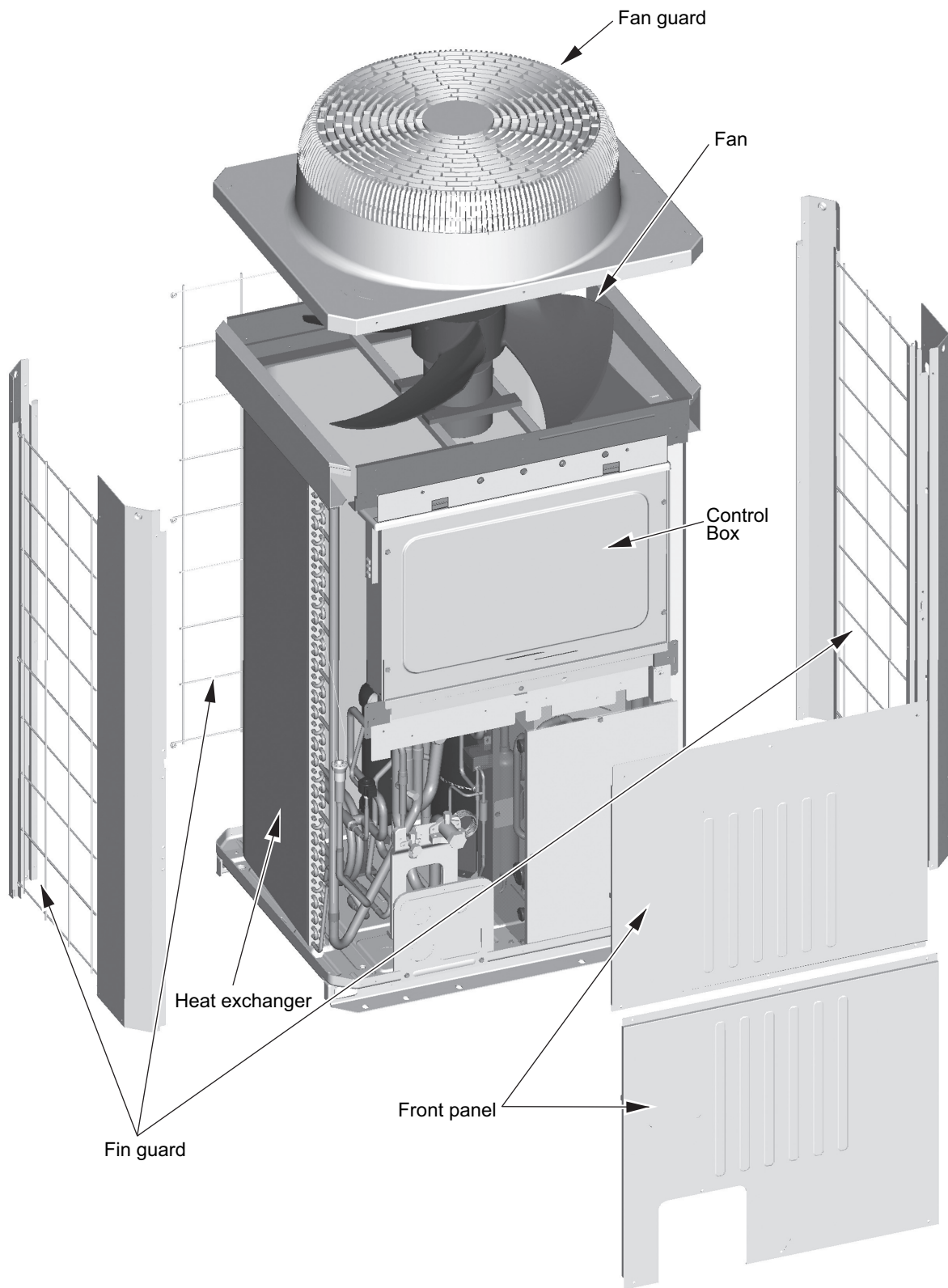

2. Refrigerant circuit

(1) PUHY-P200, P250, P300YHM-A, PUHY-EP200YHM-A

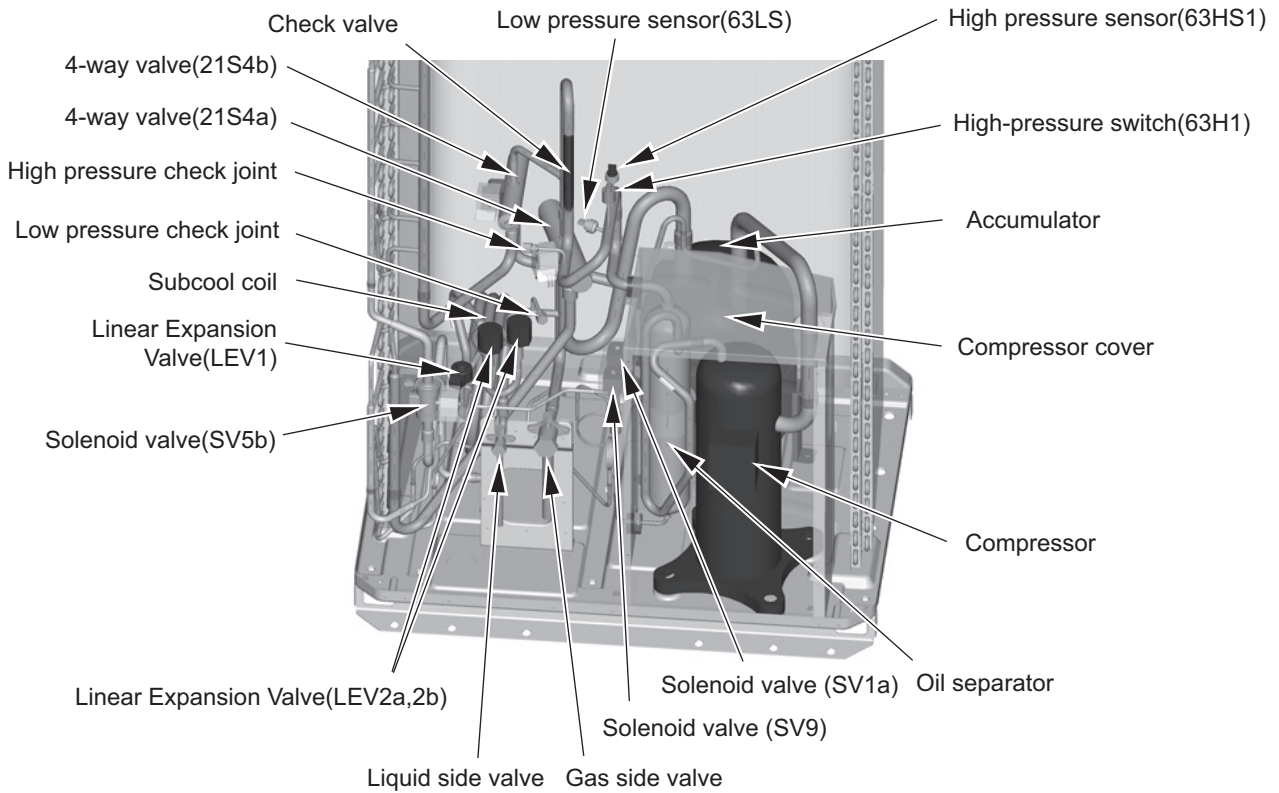

(2) PUHY-P350, P400, P450YHM-A, PUHY-EP250, EP300YHM-A

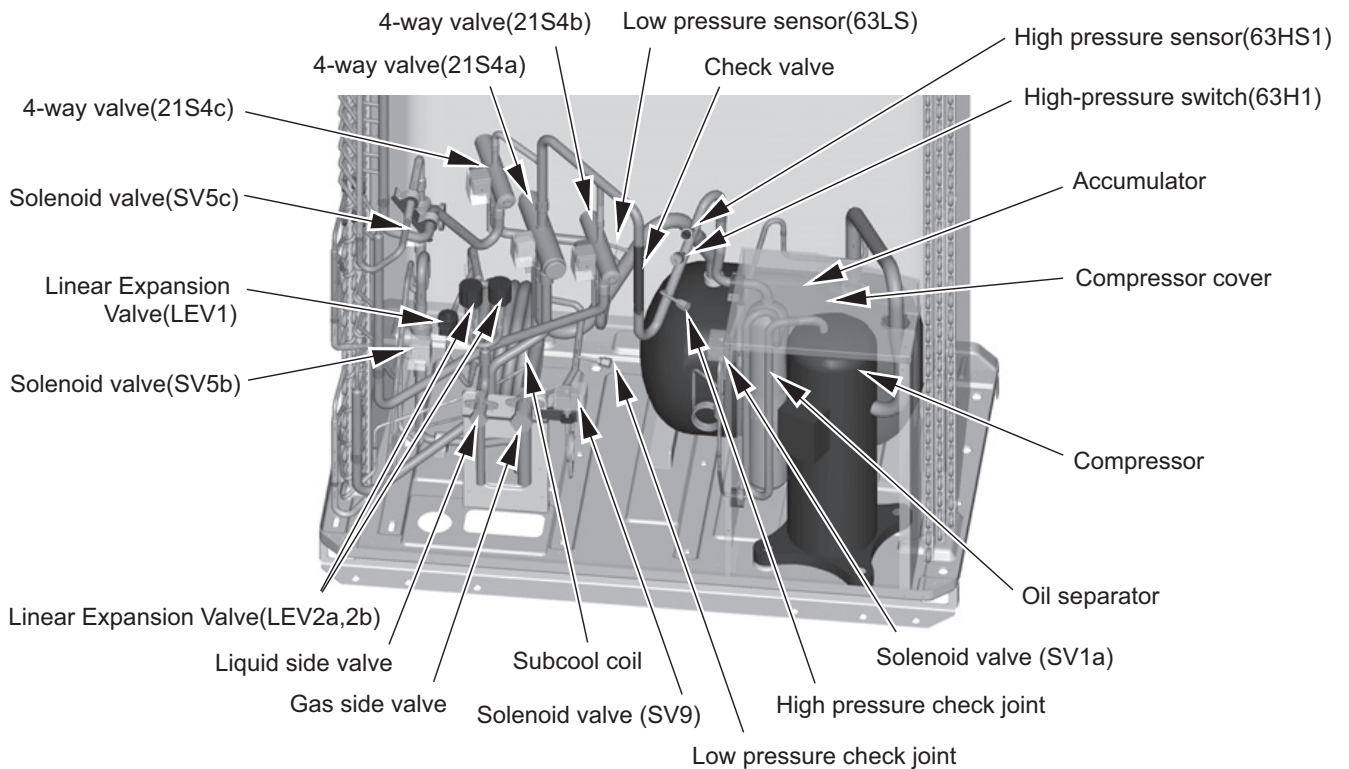

[2] Control Box of the Outdoor Unit

<HIGH VOLTAGE WARNING>

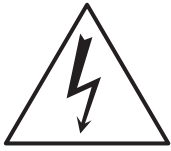

- Control box houses high-voltage parts.
- When opening or closing the front panel of the control box, do not let it come into contact with any of the internal components.
- Before inspecting the inside of the control box, turn off the power, keep the unit off for at least 10 minutes, and confirm that the voltage between FT-P and FT-N on INV Board has dropped to DC20V or less. (It takes about 10 minutes to discharge electricity after the power supply is turned off.)

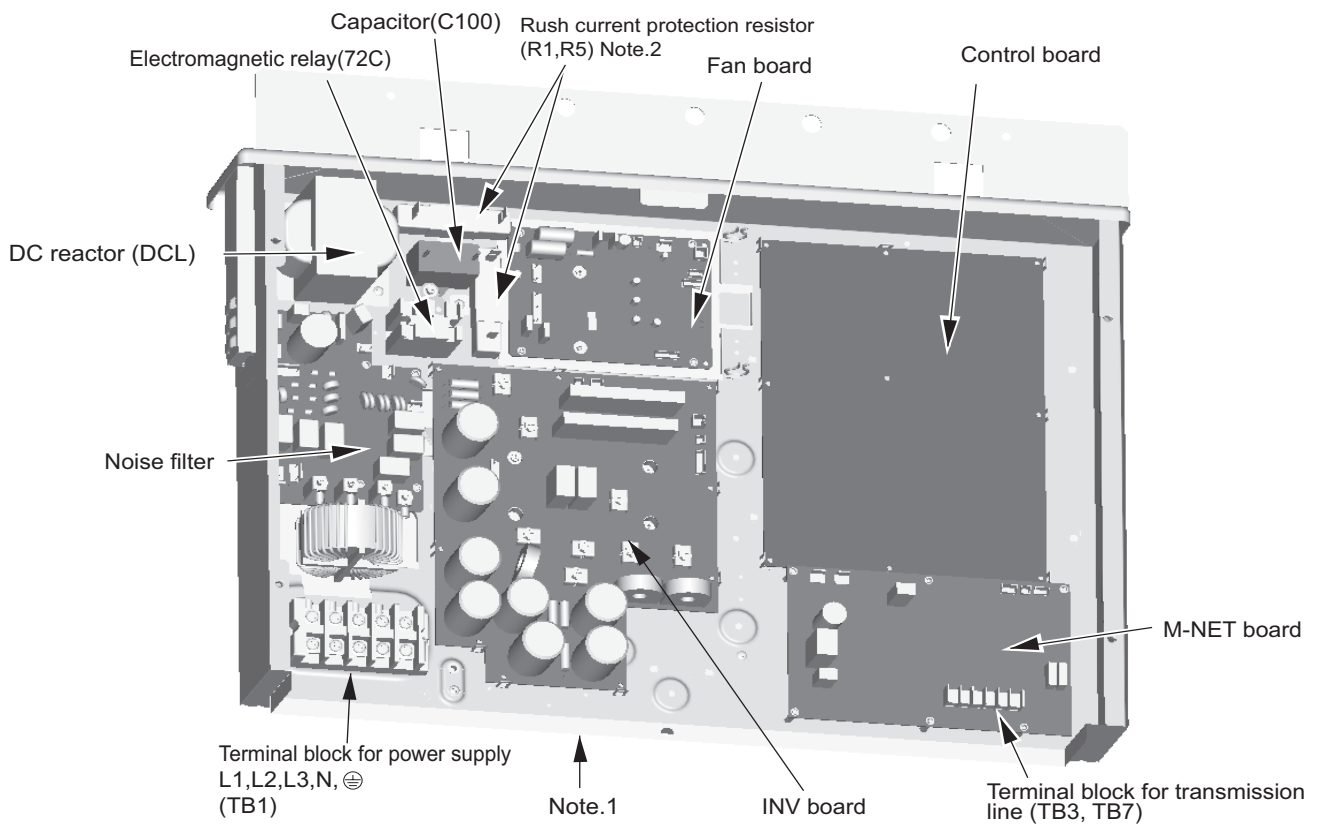

Note

- 1) Exercise caution not to damage the bottom and the front panel of the control box. Damage to these parts affect the water-proof and dust proof properties of the control box and may result in damage to its internal components.
- 2) Faston terminals have a locking function. Make sure the cable heads are securely locked in place. Press the tab on the terminals to remove them.

[3] Outdoor Unit Circuit Board

1. Outdoor unit control board

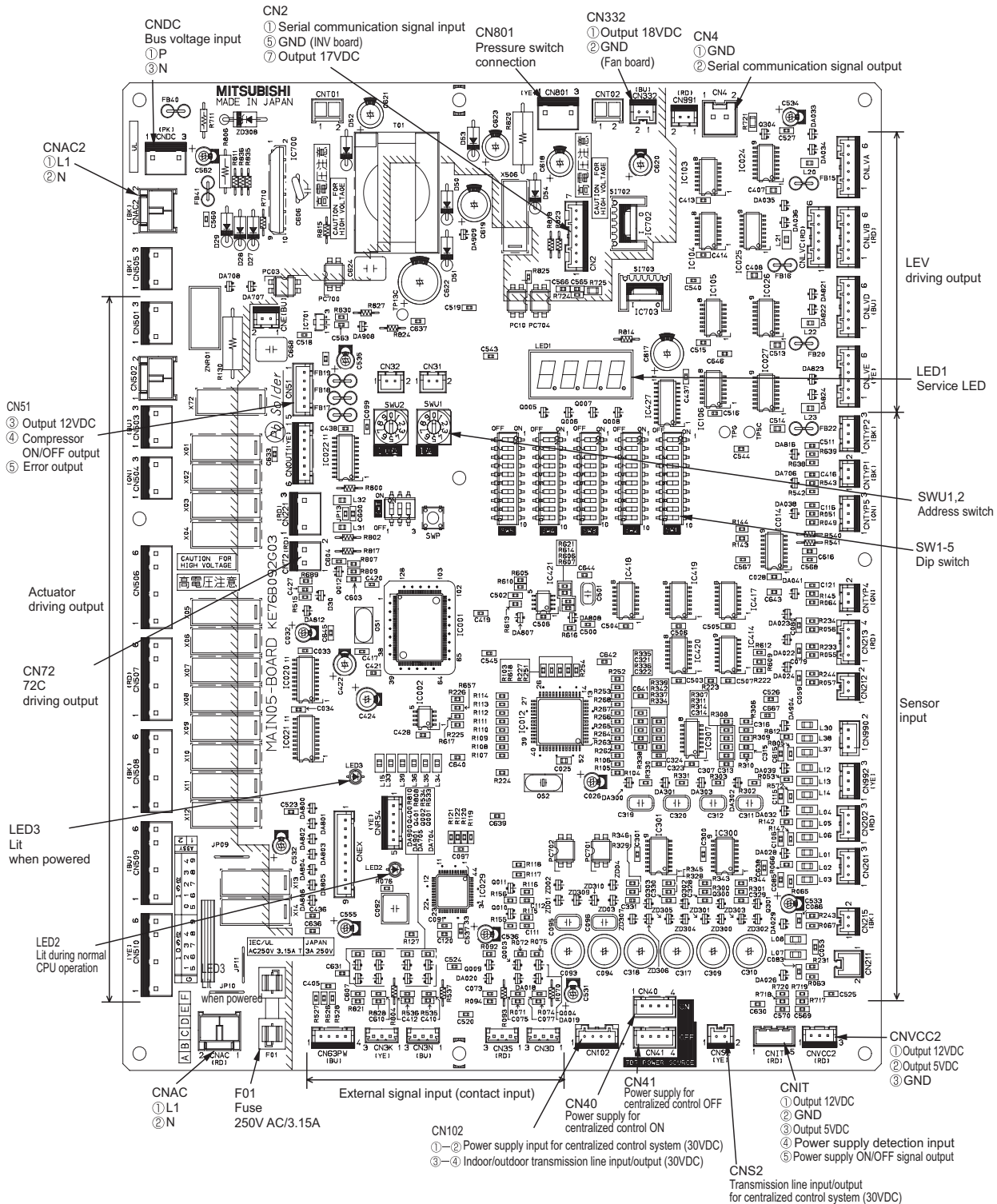

2. M-NET board

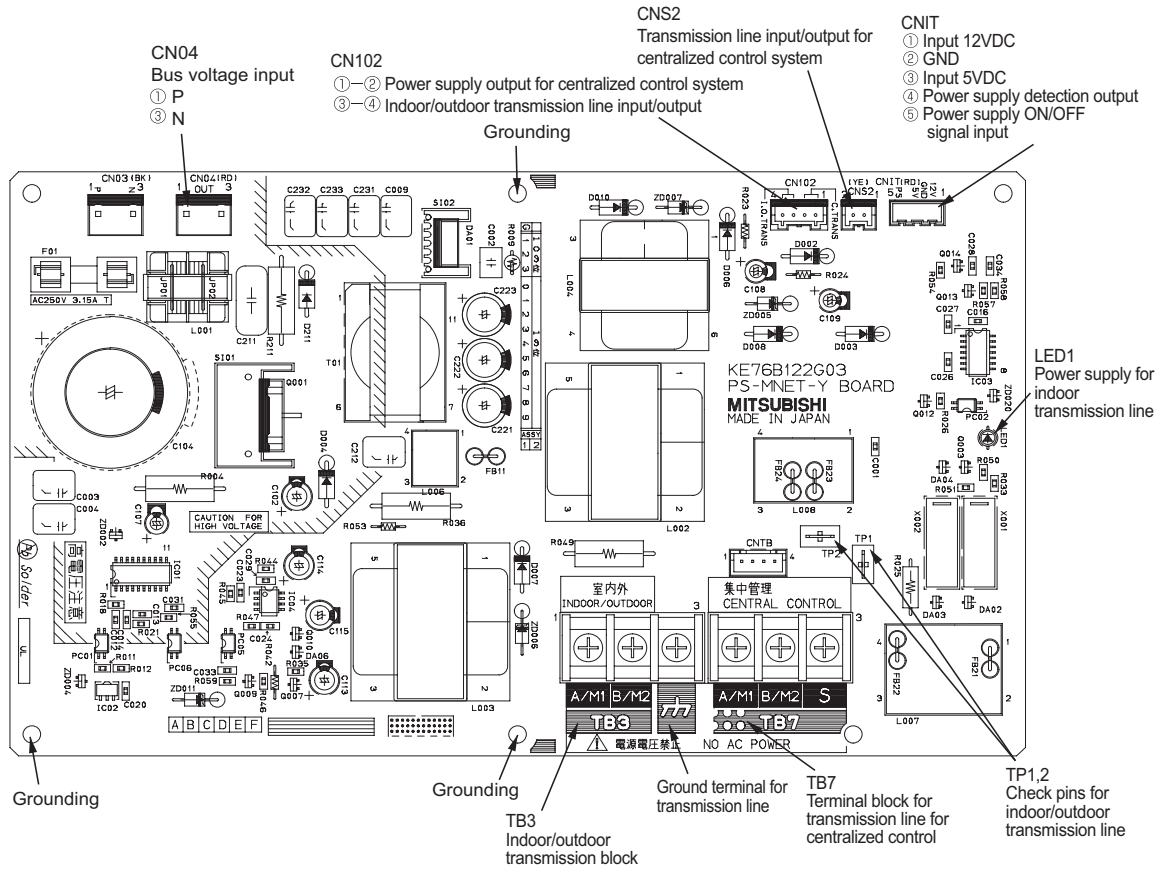

3. INV board

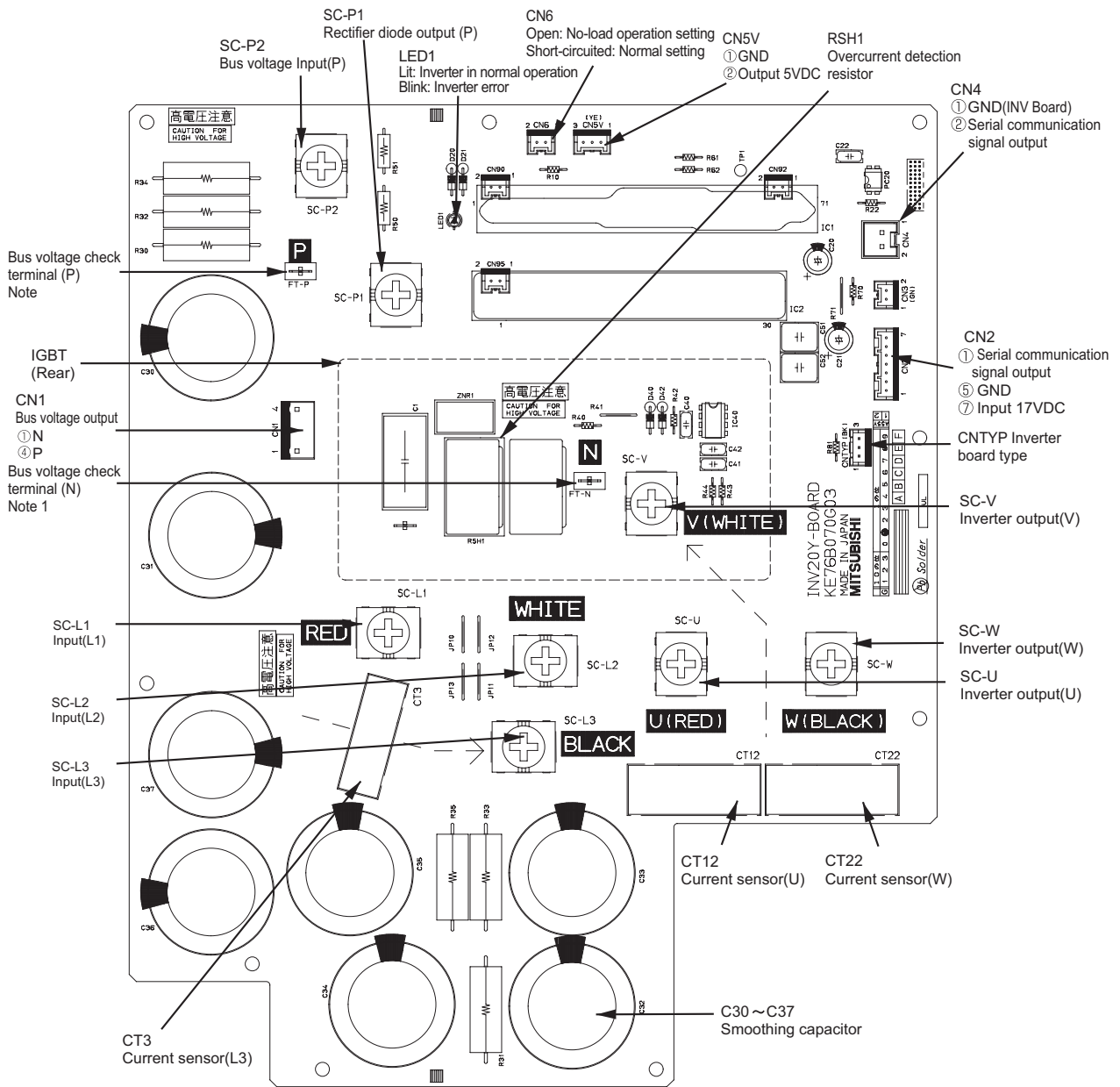

Note

- 1) Before inspecting the inside of the control box, turn off the power, keep the unit off for at least 10 minutes, and confirm that the voltage between FT-P and FT-N on INV Board has dropped to DC20V or less. It takes about 10 minutes to discharge electricity after the power supply is turned off.

5. Noise Filter

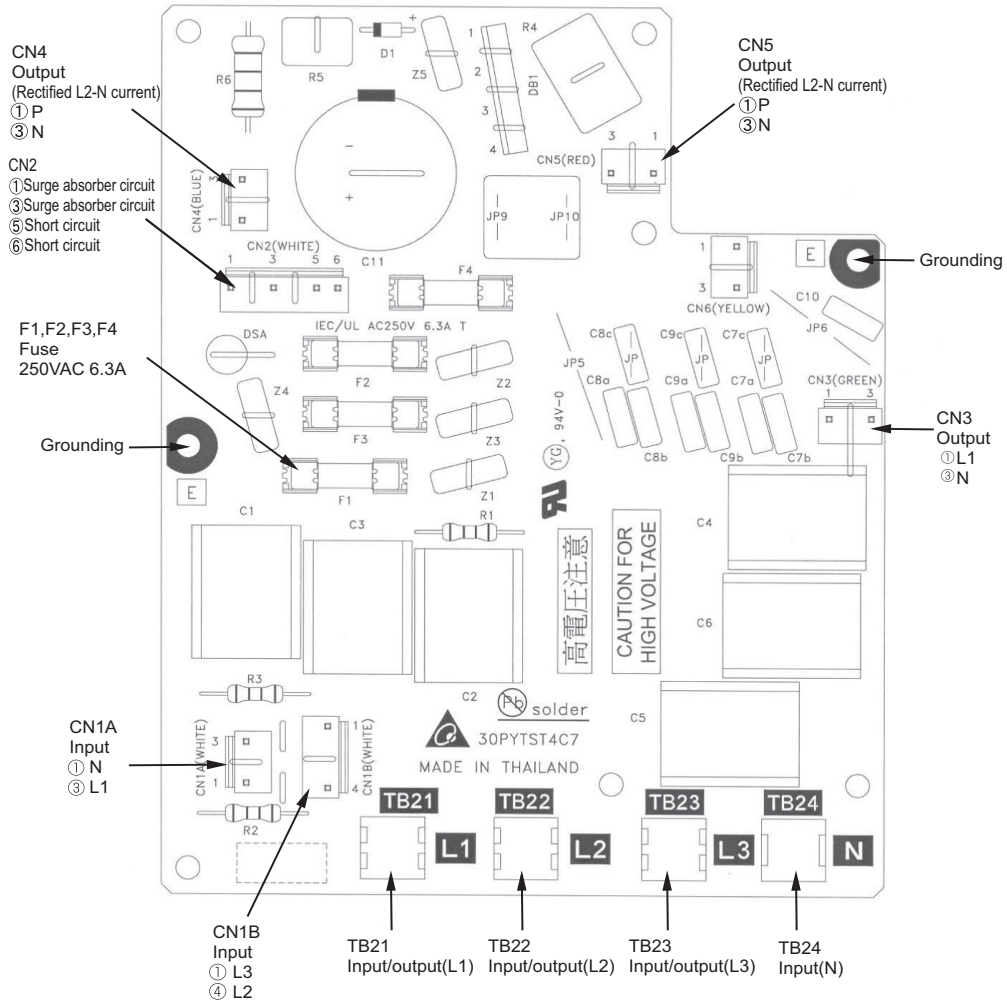

IV Remote Controller

[1] Functions and Specifications of MA and ME Remote Controllers	59
[2] Group Settings and Interlock Settings via the ME Remote Controller	60
[3] Interlock Settings via the MA Remote Controller	64
[4] Using the built-in Temperature Sensor on the Remote Controller	65



[1] Functions and Specifications of MA and ME Remote Controllers

There are two types of remote controllers: ME remote controller, which is connected on the indoor-outdoor transmission line, and MA remote controller, which is connected to each indoor unit.

1. Comparison of functions and specifications between MA and ME remote controllers

Functions/specifications	MA remote controller ^{*1*2}	ME remote controller ^{*2*3}
Remote controller address settings	Not required	Required
Indoor/outdoor unit address settings	Not required (required only by a system with one outdoor unit) ^{*4}	Required
Wiring method	Non-polarized 2-core cable *To perform a group operation, daisy-chain the indoor units using non-polarized 2-core cables.	Non-polarized 2-core cable
Remote controller connection	Connectable to any indoor unit in the group	Connectable anywhere on the indoor-outdoor transmission line
Interlock with the ventilation unit	Each indoor unit can individually be interlocked with a ventilation unit. (Set up via remote controller in the group.)	Each indoor unit can individually be interlocked with a ventilation unit. (Set up via remote controller.)
Changes to be made upon grouping change	MA remote controller wiring between indoor units requires rewiring.	Either the indoor unit address and remote controller address must both be changed, or the registration information must be changed via MELANS.

- *1. MA remote controller refers to MA remote controller (PAR-20MAA, PAR-21MAA), MA simple remote controller, and wireless remote controller.
- *2. Either the MA remote controller or the ME remote controller can be connected when a group operation of units in a system with multiple outdoor units is conducted or when a system controller is connected.
- *3. ME remote controller refers to ME remote controller and ME simple remote controller.
- *4. Depending on the system configuration, some systems with one outdoor unit may require address settings.

2. Remote controller selection criteria

MA remote controller and ME remote controller have different functions and characteristics. Choose the one that better suits the requirements of a given system. Use the following criteria as a reference.

MA remote controller ^{*1*2}	ME remote controller ^{*1*2}
<ul style="list-style-type: none"> ♦There is little likelihood of system expansion and grouping changes. ♦Grouping (floor plan) has been set at the time of installation. 	<ul style="list-style-type: none"> ♦There is a likelihood of centralized installation of remote controllers, system expansion, and grouping changes. ♦Grouping (floor plan) has not been set at the time of installation. ♦To connect the remote controller directly to the OA processing unit.

- *1. ME remote controller and MA remote controller cannot both be connected to the same group of indoor units.
- *2. A system controller must be connected to a system to which both MA remote controller and ME remote controller are connected.

<System with MA remote controller>

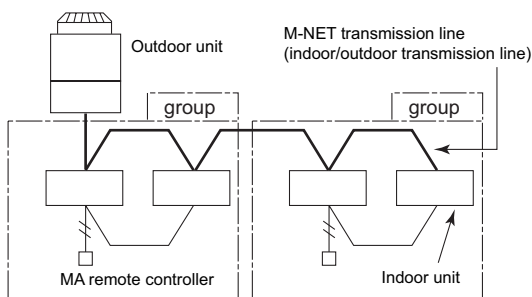

<System with ME remote controllers>

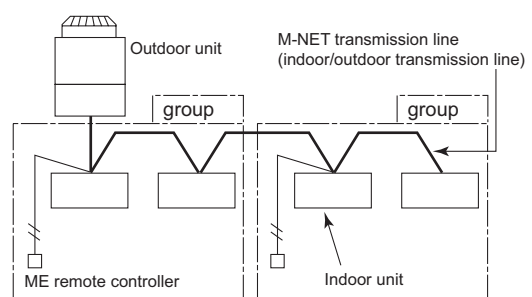

[2] Group Settings and Interlock Settings via the ME Remote Controller

1. Group settings/interlock settings

Make the following settings to perform a group operation of units that are connected to different outdoor units or to manually set up the indoor/outdoor unit address.

- (A) Group settings.....Registration of the indoor units to be controlled with the remote controller, and search and deletion of registered information.
- (B) Interlock settings.....Registration of LOSSNAY units to be interlocked with the indoor units, and search and deletion of registered information

[Operation Procedures]

(1) Address settings

Register the indoor unit to be controlled with the remote controller.

- ① **Bring up either the blinking display of “HO” by turning on the unit or the normal display by pressing the ON/OFF button.**

The display window must look like one of the two figures below to proceed to the next step.

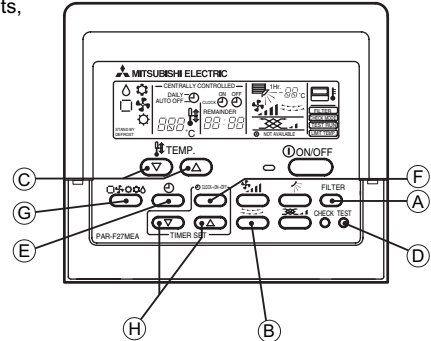

(A) Group Settings

- ② **Bring up the “Group Setting” window.**

- Press and hold buttons (A) [FILTER] and (B) [TIMER SET] simultaneously for 2 seconds to bring up the display as shown below.

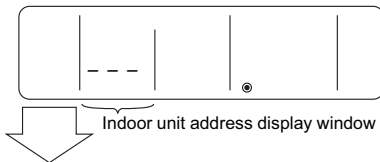

- ③ **Select the unit address.**

- Select the address of the indoor unit to be registered by pressing button (C) [TEMP. (▽) or (△)] to advance or go back through the addresses.

- ④ **Register the indoor unit whose address appears on the display.**

- Press button (D) [TEST] to register the indoor unit address whose address appears on the display.
 - If registration is successfully completed, unit type will appear on the display as shown in the figure below.
 - If the selected address does not have a corresponding indoor unit, an error message will appear on the display. Check the address, and try again.

<Successful completion of registration>

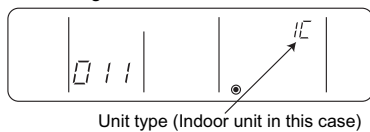

<Deletion error>

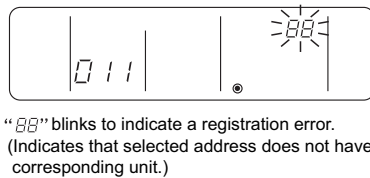

- ⑤ **To register the addresses for multiple indoor units, repeat steps ③ and ④ above.**

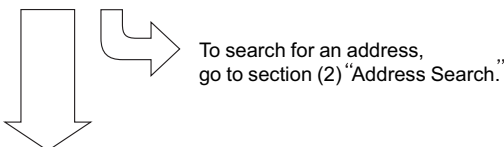

To next page.

(B) Interlock Settings

- ⑥ **Bring up the “Interlock Setting” window.**

- Press button (G) [TIMER SET] to bring up the following display. Press again to go back to the “Group Setting” window as shown under step ②.

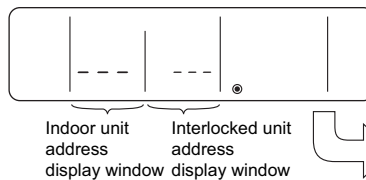

Both the “indoor unit address” and “interlocked unit address” will be displayed together.

To search for an address, go to section (2) “Address Search.”

- ⑦ **Bring up the address of the indoor unit and the address of the LOSSNAY to be interlocked on the display.**

- Select the address of the indoor unit to be registered by pressing button (C) [TEMP. (▽) or (△)] to advance or go back through the addresses.
 - Select the address of the LOSSNAY unit to be interlocked by pressing button (H) [TIMER SET (▽) or (△)] to advance or go back through the “interlocked unit addresses.”



- ⑧ **Make the settings to interlock LOSSNAY units with indoor units.**

- Press button (D) [TEST] while both the indoor unit address and the address of the LOSSNAY units to be interlocked are displayed to enter the interlock setting.
 - Interlock setting can also be made by bringing up the LOSSNAY address in the indoor unit address display window and the indoor unit address in the interlocked unit address display window.

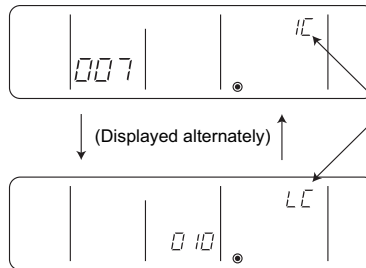

If registration is successfully completed, the two displays as shown on the left will appear alternately.
 If the registration fails, “BB” will blink on the display. (Indicates that the selected address does not have a corresponding unit.)

NOTE : Interlock all the indoor units in the group with the LOSSNAY units; otherwise, the LOSSNAY units will not operate.



(C) To return to the normal display

When all the group settings and interlock settings are made, take the following step to go back to the normal display.

- ⑩ Press and hold buttons **A [FILTER]** and **B [---]** simultaneously for 2 seconds to go back to the window as shown in step ①.



⑨ Repeat steps ⑦ and ⑧ in the previous page to interlock all the indoor units in a group with the LOSSNAY unit.



To go back to the normal display, follow step ⑩.



To search for an address, go to section (2) "Address Search."

(2) Address search

To search for the address of indoor units that have been entered into the remote controller, follow steps ① and ②.



(A) To search group settings



⑪ Bring up the "Group Setting" window.

- Each pressing of button **E [⊕]** will bring up the address of a registered indoor unit and its unit type on the display.

<Entry found>

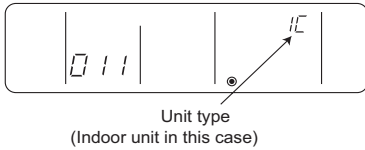

<No entries found>



- When only one unit address is registered, the same address will remain on the display regardless of how many times the button is pressed.
- When the address of multiple units are registered (i.e. "011", "012", "013"), they will be displayed one at a time in an ascending order with each pressing of button **E [⊕]**.

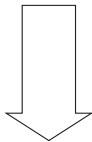

To delete an address, go to section (3) "Address Deletion."



To go back to the normal display, follow step ⑩.

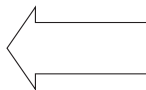

(3) Address deletion

The addresses of the indoor units that have been entered into the remote controller can be deleted by deleting the group settings. The interlock settings between units can be deleted by deleting the interlock settings. Follow the steps in section (2) "Address Search" to find the address to be deleted and perform deletion with the address being displayed in the display window. To delete an address, the address must first be brought up on the display.

⑮ Delete the registered indoor unit address or the interlock setting between units.

- Press button **F [CLOCK → ON → OFF]** twice while either the indoor unit address or the address of the interlocked unit is displayed on the display to delete the interlock setting.

(B) Interlock setting search

After performing step ⑥, proceed as follows:

⑫ Bring up the address of the indoor unit to be searched on the display.

- Select the address of the indoor unit to be searched by pressing button **H [TIMER SET (▽) or (△)]** to advance or go back through the interlocked addresses.



LOSSNAY can be searched in the same manner by bringing up the LOSSNAY address in the Interlocked unit address display window.

⑬ Bring up on the display the address of the LOSSNAY unit that was interlocked with the indoor unit in step ⑫.

- With each pressing of button **E [⊕]**, the address of the LOSSNAY and indoor unit that is interlocked with it will be displayed alternately.

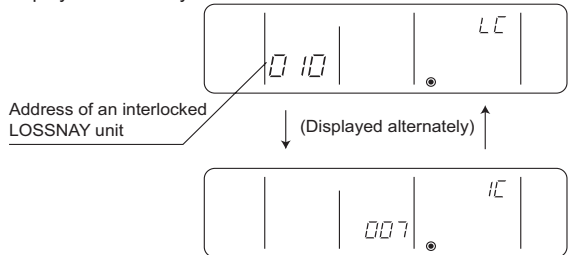

⑭ Bring up the address of another registered unit on the display.

- After completing step ⑬, a subsequent pressing of button **E [⊕]** will bring up the address of another registered unit. (The display method is the same as the one in step ⑬.)

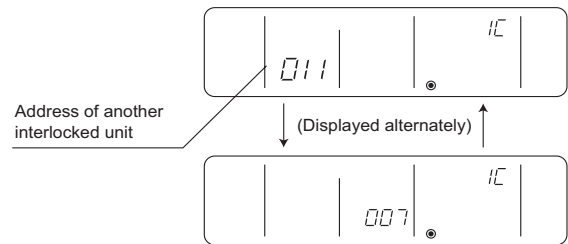

To delete an address, go to section (3) "Address Deletion."



(A) To delete group settings

<Successful completion of deletion>

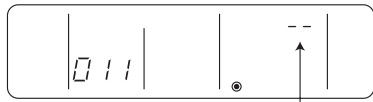

"--" will be displayed in the room temperature display window.

- If a transmission error occurs, the selected setting will not be deleted, and the display will appear as shown below. In this case, repeat the steps above.

<Deletion error>

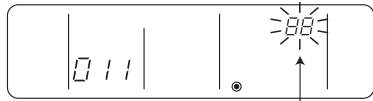

"BB" will be displayed in the room temperature display window.

To go back to the normal display, follow step ⑩.

(B) To delete interlock settings



(Displayed alternately)



If deletion is successfully completed, "--" will appear in the unit type display window. If the deletion fails, "BB" will appear in the unit type display window. In this case, repeat the steps above.

(4) Making (A) Group settings and (B) Interlock settings of a group from any arbitrary remote controller

(A) Group settings and (B) Interlock settings of a group can be made from any arbitrary remote controller. Refer to "(B) Interlock Settings" under section 1 "Group Settings/Interlock Settings" for operation procedures. Set the address as shown below.

(A) To make group settings

Interlocked unit address display window...Remote controller address
Indoor unit address display window.....The address of the indoor unit to be controlled with the remote controller

(B) To make interlock settings

Interlocked unit address display window...LOSSNAY address
Indoor unit address display window.....The address of the indoor unit to be interlocked with the LOSSNAY

2. Remote controller function selection via the ME remote controller

In the remote controller function selection mode, the settings for four types of functions can be made or changed as necessary.

- 1) Skip-Auto-Mode setting
The automatic operation mode that is supported by some simultaneous cooling/heating type units can be made unselectable via the ME remote controller.
- 2) Operation mode display selection mode (Display or non-display of COOL/HEAT during automatic operation mode)
When the automatic operation mode is selected, the indoor unit will automatically perform a cooling or heating operation based on the room temperature. In this case, " " or " " will appear on the remote controller display. This setting can be changed so that only " " will appear on the display.
- 3) Room temperature display selection mode (Display or non-display of room temperature)
Although the suction temperature is normally displayed on the remote controller, the setting can be changed so that it will not appear on the remote controller.
- 4) Narrowed preset temperature range mode
The default temperature ranges are 19°C to 30°C in the cooling/dry mode and 17°C to 28°C in the heating mode and 19°C to 28°C in the auto mode. By changing these ranges (raising the lower limit for the cooling/dry mode and lowering the upper limit for the heating mode), energy can be saved.

NOTE

When making the temperature range setting on the simultaneous cooling/heating type units that supports the automatic operation mode to save on energy consumption, enable the Skip-Auto-Mode setting to make the automatic operation mode unselectable. If the automatic operation mode is selected, the energy-saving function may not work properly.

When connected to the air conditioning units that do not support the automatic operation mode, the setting for the Skip-Auto-Mode, restricted preset temperature range mode (AUTO), and operation mode display selection mode are invalid. If an attempt is made to change the preset temperature range, "LIMIT TEMP." appears on the display.

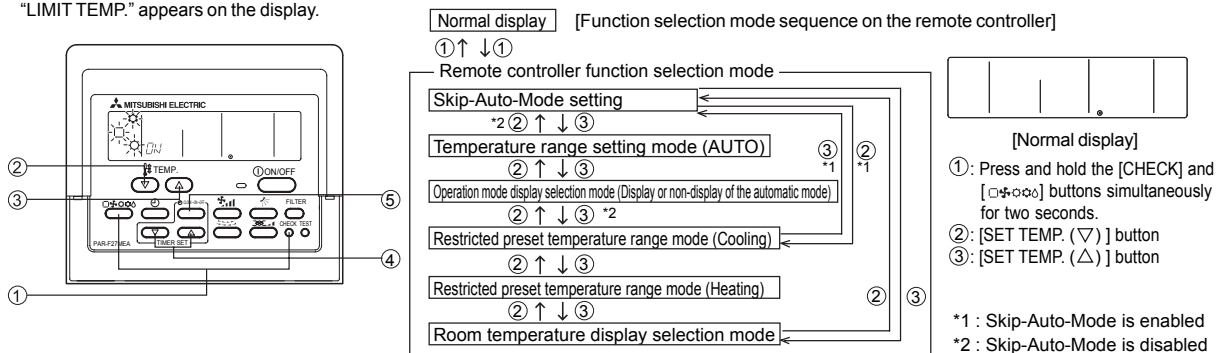

[Operation Procedures]

1. Press the [ON/OFF] button on the remote controller to bring the unit to a stop. The display will appear as shown in the previous page (Normal display).
2. Press buttons ① [CHECK] and [] simultaneously for 2 seconds to go into the "Skip-Auto-Mode setting." under the remote controller function selection mode. Press button ② [SET TEMP. (∇)] or ③ [SET TEMP. (Δ)] to go into the other four modes under the remote controller function selection mode.

Skip-Auto-Mode setting (Making the automatic operation mode unselectable)

This setting is valid only when the controller is connected to the simultaneous cooling/heating type air conditioning units that support the automatic operation mode.

- " " blinks and either "ON" or "OFF" lights up on the controller. Pressing the ④ [TIMER SET (Δ) or (∇)] button switches between "ON" and "OFF."

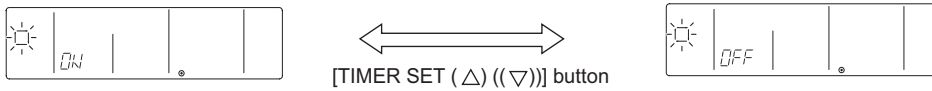

- When set to "ON," the automatic operation mode is available for selection in the function selection mode.
- When set to "OFF," the automatic operation mode is not available for selection in the function selection mode, and an automatic operation cannot be performed.
(The automatic operation mode is skipped in the function selection mode sequence.)

Operation mode display selection mode (Changing the type of display that appears during the automatic mode operation)

- When connected to the air conditioning units that do not support the automatic operation mode, the setting for this mode is invalid.
- " " " " will blink, and either "ON" or "OFF" will light up. Press button ④ [TIMER SET (Δ) or (∇)] in this state to switch between "ON" and "OFF."

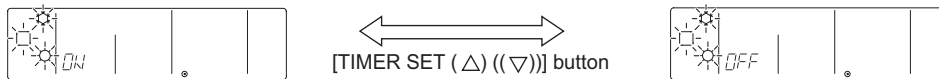

- When it is set to "ON," " " " " will appear on the display during automatic operation mode.
- When it is set to "OFF," only " " will appear on the display during automatic operation mode.

Restricted preset temperature range mode (The range of preset temperature can be changed.)

1) Temperature range setting for the cooling/dry mode

" / " will light up in the display window, and the temperature range for the cooling/dry mode will appear on the display.

[Lower limit temperature]: Appears in the preset temperature display window [Upper limit temperature: Appears in the time display window
Switch between the Lower and Upper limit temperature setting by pressing the ⑤ [CLOCK-ON-OFF] button. The selected temperature setting blinks.

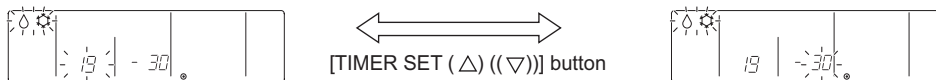

[The left figure shows the display that appears when the current temperature range setting is between 19°C and 30°C in the Cool/Dry mode, and the lower limit temperature is selected to be set.]

Press button ④ [TIMER SET (Δ) or (∇)] to set the lower limit temperature to the desired temperature.

[Settable range for the lower limit temperature] : 19°C ↔ 30°C (Settable up to the upper limit temperature that is shown on the display)

[Settable range for the upper limit temperature] : 30°C ↔ 19°C (Settable up to the lower limit temperature that is shown on the display)

2) Temperature range setting for heating

" " and the settable temperature range for heating appear on the display.

As with the Cool/Dry mode, use the ⑤ [CLOCK-ON-OFF] button and the ④ [TIMER SET (Δ) or (∇)] to set the temperature range.

[Settable range for the lower limit temperature] : 17°C ↔ 28°C (Settable up to the upper limit temperature that is shown on the display)

[Settable range for the upper limit temperature] : 28°C ↔ 17°C (Settable up to the lower limit temperature that is shown on the display)

3) Temperature range setting for the automatic mode

When connected to the air conditioning units that do not support the automatic operation mode, the setting for this mode is invalid.

" " and the temperature range for the automatic operation mode appear on the display.

As with the Cool/Dry mode, use the ⑤ [CLOCK-ON-OFF] button and the ④ [TIMER SET (Δ) or (∇)] to set the temperature range.

[Settable range for the lower limit temperature] : 19°C ↔ 28°C (Settable up to the upper limit temperature that is shown on the display)

[Settable range for the upper limit temperature] : 28°C ↔ 19°C (Settable up to the lower limit temperature that is shown on the display)

Room temperature display selection mode (Switching between the display or non-display of room temperature on the controller)

- " 88°C " blinks and either "ON" or "OFF" lights up on the controller. Pressing the ④ [TIMER SET (Δ) or (∇)] button switches between "ON" and "OFF."

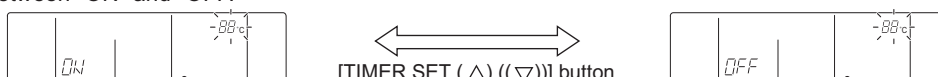

- When set to "ON," room temperature always appears on the display during operation.
When set to "OFF," room temperature does not appear on the display during operation.

[3] Interlock Settings via the MA Remote Controller

1. LOSSNAY interlock setting (Make this setting only when necessary.)

Make this setting only when necessary.

Perform this operation to enter the interlock setting between the LOSSNAY and the indoor units to which the remote controller is connected, or to search and delete registered information.
 In the following example, the address of the indoor unit is 05 and the address of the LOSSNAY unit is 30.

[Operation Procedures]

- ① Press the [ON/OFF] button on the remote controller to bring the unit to a stop.
 The display window on the remote controller must look like the figure below to proceed to step ②.

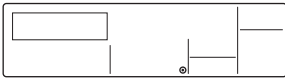

- ② Press and hold the [FILTER] and [] buttons simultaneously for two seconds to perform a search for the LOSSNAY that is interlocked with the indoor unit to which the remote controller is connected.



- ③ Search result
 - The indoor unit address and the interlocked LOSSNAY address will appear alternately.

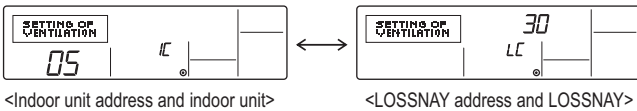

- Without interlocked LOSSNAY settings

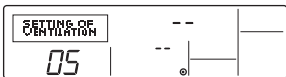

- ④ If no settings are necessary, exit the window by pressing and holding the [FILTER] and [] buttons simultaneously for 2 seconds.
 Go to step 1. **Registration Procedures** to make the interlock settings with LOSSNAY units, or go to step 2. **Search Procedures** to search for a particular LOSSNAY unit.
 Go to step 3. **Deletion Procedures** to delete any LOSSNAY settings.

< 1. Registration Procedures >

- ⑤ To interlock an indoor unit with a LOSSNAY unit, press the [TEMP. (▽) or (△)] button on the remote controller that is connected to the indoor unit, and select its address (01 to 50).
- ⑥ Press the [CLOCK (▽) or (△)] button to select the address of the LOSSNAY to be interlocked (01 to 50).

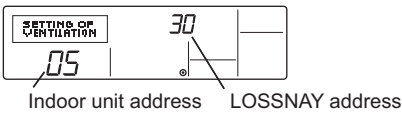

Indoor unit address LOSSNAY address

- ⑦ Press the [TEST] button to register the address of the selected indoor unit and the interlocked LOSSNAY unit.
 - Registration completed
 The registered indoor unit address and "LC," and the interlocked LOSSNAY address and "LC" will appear alternately.

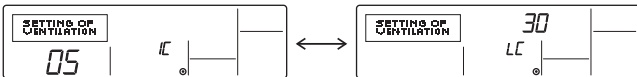

- Registration error
 If the registration fails, the indoor unit address and the LOSSNAY address will be displayed alternately.



Registration cannot be completed: The selected unit address does not have a corresponding indoor unit or a LOSSNAY unit.
 Registration cannot be completed: Another LOSSNAY has already been interlocked with the selected indoor unit.

< 2. Search Procedures >

⑧ To search for the LOSSNAY unit that is interlocked with a particular indoor unit, enter the address of the indoor unit into the remote controller that is connected to it.



<Indoor unit address>

⑨ Press the [⊖ MENU] button to search for the address of the LOSSNAY unit that is interlocked with the selected indoor unit.

- Search completed (With a LOSSNAY connection)

The indoor unit address and "IC," and the interlocked LOSSNAY address and "LC" will appear alternately.

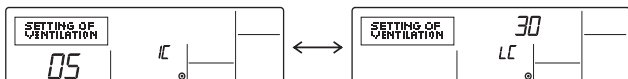

- Search completed (No interlocked settings with a LOSSNAY exist.)



- The selected address does not have a corresponding indoor unit.

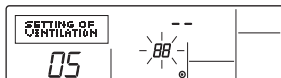

< 3. Deletion Procedures >

Take the following steps to delete the interlock setting between a LOSSNAY unit and the interlocked indoor unit from the remote controller that is connected to the indoor unit.

⑩ Find the address of the LOSSNAY to be deleted (See section 2. Search Procedures.), and bring up the result of the search for both the indoor unit and LOSSNAY on the display.

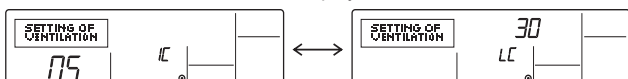

⑪ Press the [⊕ ON/OFF] button twice to delete the address of the LOSSNAY unit that is interlocked with the selected indoor unit.

- Registration completed

The indoor unit address and "--," and the interlocked LOSSNAY address and "--" will appear alternately.

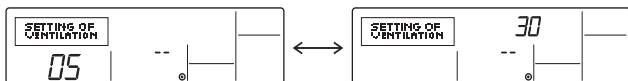

-Deletion error

If the deletion fails

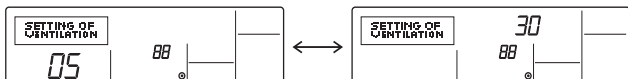

[4] Using the built-in Temperature Sensor on the Remote Controller

1. Selecting the position of temperature detection (Factory setting: SW1-1 on the controller board on the indoor unit is set to OFF.)

To use the built-in sensor on the remote controller, set the SW1-1 on the controller board on the indoor unit to ON.

• Some models of remote controllers are not equipped with a built-in temperature sensor. Use the built-in temperature sensor on the indoor unit instead.

• When using the built-in sensor on the remote controller, install the remote controller where room temperature can be detected.

V Electrical Wiring Diagram

[1] Electrical Wiring Diagram of the Outdoor Unit	69
[2] Electrical Wiring Diagram of Transmission Booster	70



[1] Electrical Wiring Diagram of the Outdoor Unit

1. Electrical wiring diagram of the outdoor unit (1) PUHY-(E)P200, (E)P250, (E)P300, P350, P400, P450 models

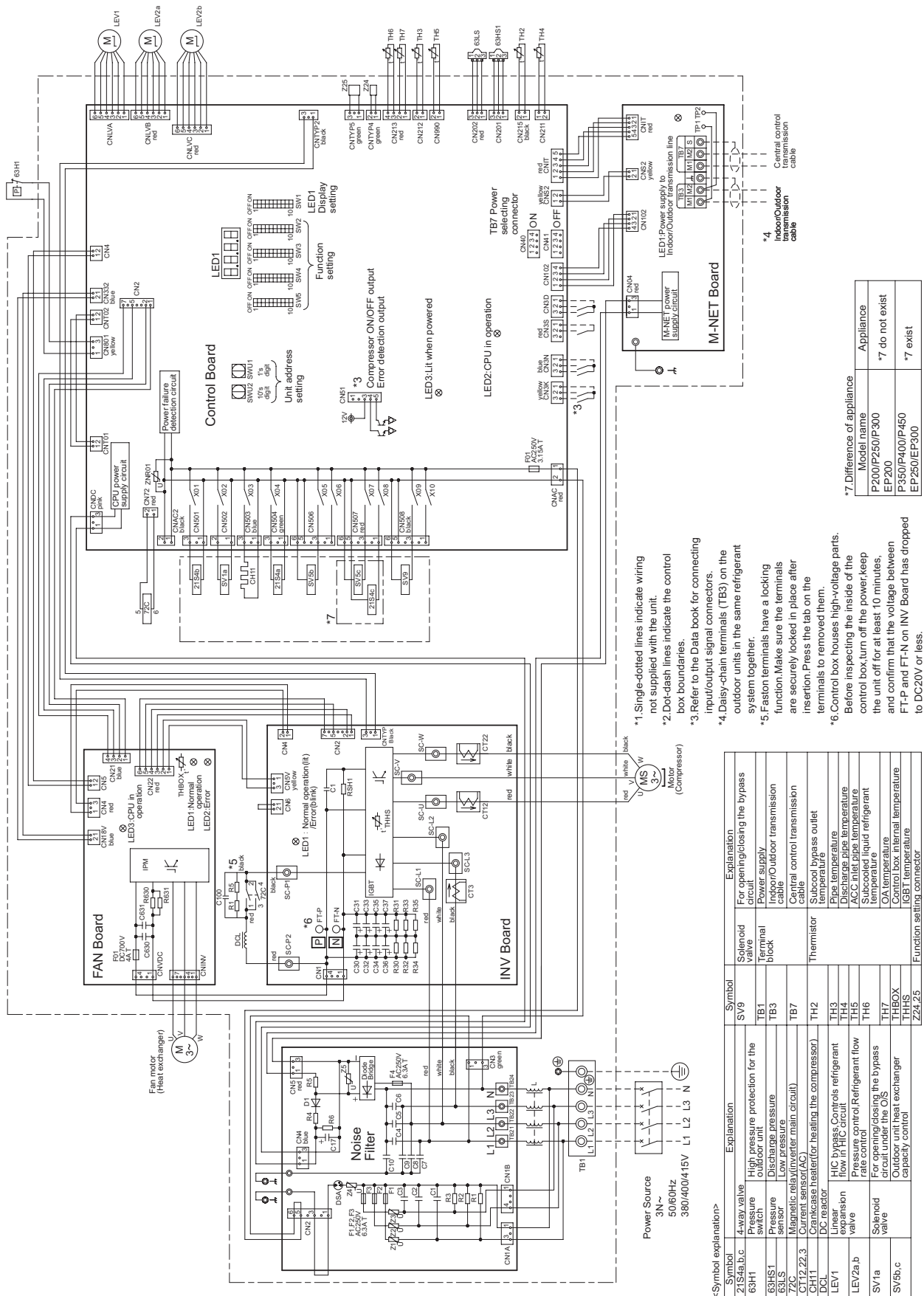

- *1. Single-dotted lines indicate wiring not supplied with the unit.
- *2. Dot-dash lines indicate the control box boundaries.
- *3. Refer to the Data book for connecting input/output signal connectors.
- *4. Daisy-chain terminals (TB3) on the outdoor units in the same refrigerant system together.
- *5. Faston terminals have a locking function. Make sure the terminals are securely locked in place after insertion. Press the tab on the terminals to removed them.
- *6. Control box houses high-voltage parts. Before inspecting the inside of the control box, turn off the power, keep the unit off for at least 10 minutes, and confirm that the voltage between FT-P and FT-N on INV Board has dropped to DC20V or less.

Symbol	Explanation	Symbol	Explanation
Z1S4,abc	4-way valve	SV1	Solenoid valve
63H1	High pressure protection for the outdoor unit	TB1	Terminal block
63LS	Discharge pressure sensor	TB3	Terminal block
Z2C	Magnetic relay (inverter main circuit)	TB7	Central control transmission cable
C1T2,22.3	Current sensor(AC)	TH2	Thermistor
CR	Compressor	TH3	Subcool bypass outlet
LEV1	Pressure sensor	TH4	Pipe temperature
LEV2a,b	HIC bypass Controls refrigerant flow in HIC circuit	TH5	Discharge pipe temperature
SV1a	Pressure control Refrigerant flow rate control	TH6	ACC inlet pipe temperature
SV3b,c	For opening/closing the bypass circuit under the OS	TH7	Subcooled liquid refrigerant temperature
	Outdoor unit heat exchanger capacity control	TH8	OA temperature
		TH9	Control box internal temperature
		Z4T,25	IGBT temperature
			Function setting connector

*7. Difference of appliance	Appliance
Model name	
P200/P250/P300	
EP200	*7 do not exist
P350/P400/P450	
EP250/EP300	*7 exist

[2] Electrical Wiring Diagram of Transmission Booster

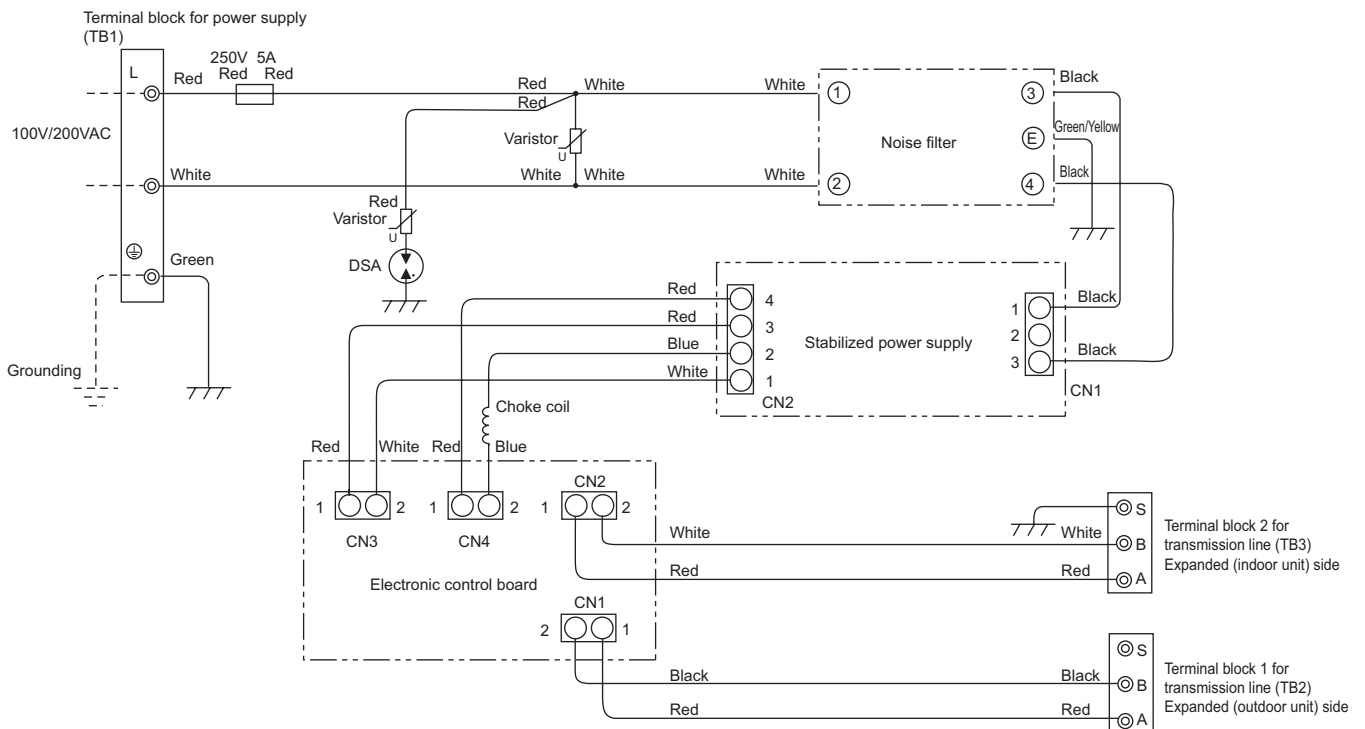

VI Refrigerant Circuit

[1] Refrigerant Circuit Diagram	73
[2] Principal Parts and Functions	74



[1] Refrigerant Circuit Diagram

1. Outdoor unit

(1) PUHY-P200, P250, P300 models, EP200 models

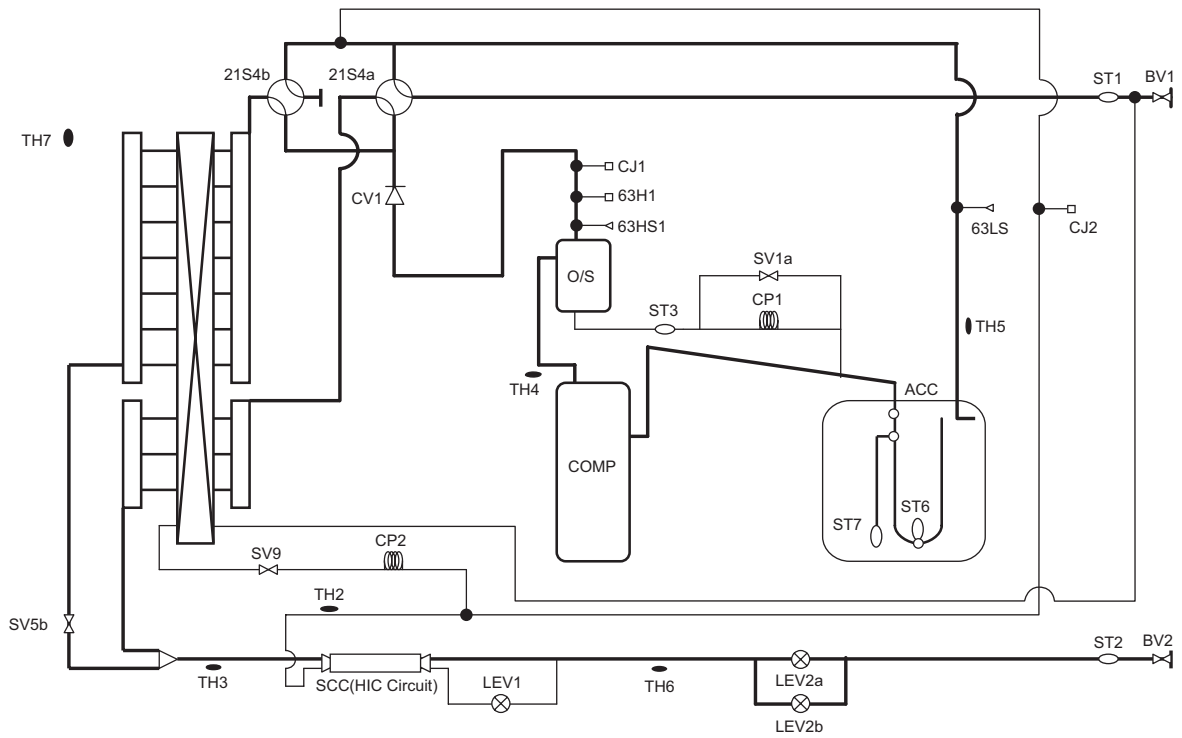

(2) PUHY-P350, P400, P450 models, EP250, EP300 models

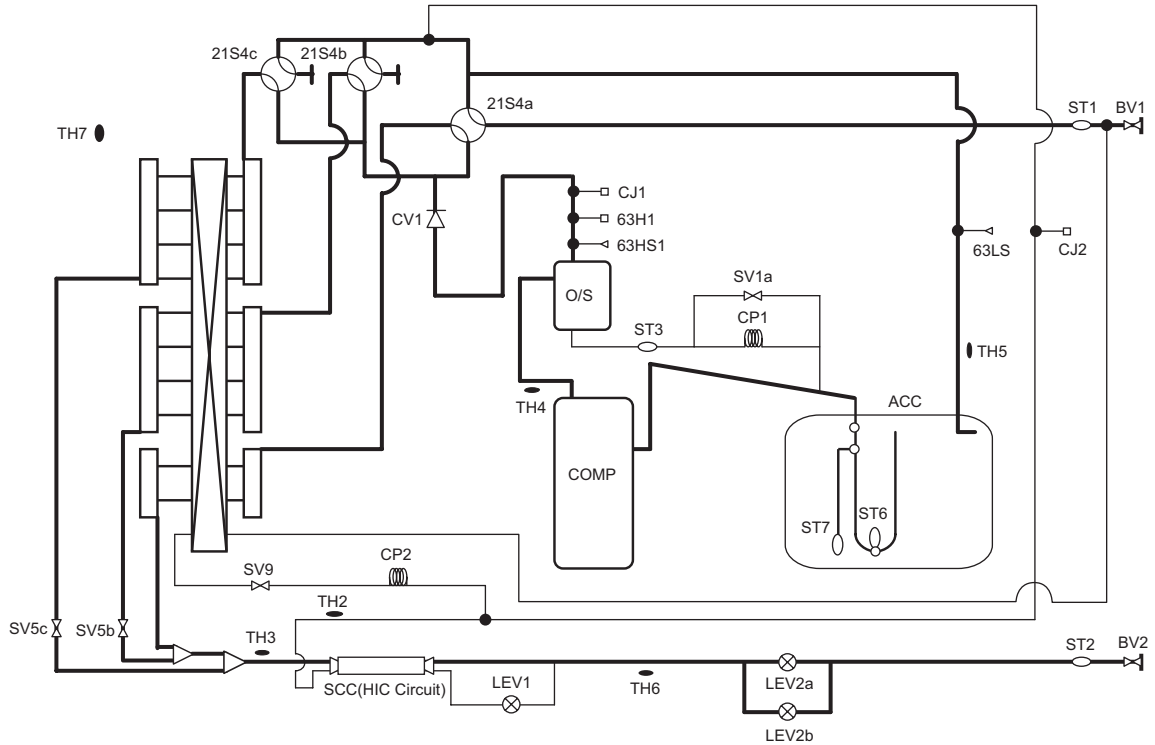

[2] Principal Parts and Functions

1. Outdoor unit

Part name	Symbols (functions)	Notes	Usage	Specifications	Check method
Com-pressor	MC1 (Comp1)		Adjusts the amount of circulating refrigerant by adjusting the operating frequency based on the operating pressure data	P200 - 250 and EP200 models Low-pressure shell scroll compressor Wirewound resistance 20°C[68°F] : 0.981ohm P300 - 450 models EP250 · 350 models Low-pressure shell scroll compressor Wirewound resistance 20°C[68°F] : 0.583ohm	
High pressure sensor	63HS1		1) Detects high pressure 2) Regulates frequency and provides high-pressure protection	<p>63HS1 Pressure 0~4.15 MPa [601psi] Vout 0.5~3.5V 0.071V/0.098 MPa [14psi] Pressure [MPa] =1.38 x Vout [V]-0.69 Pressure [psi] =(1.38 x Vout [V] - 0.69) x 145 1 GND (Black) 2 Vout (White) 3 Vcc (DC5V) (Red)</p>	
Low pressure sensor	63LS		1) Detects low pressure 2) Provides low-pressure protection	<p>63LS Pressure 0~1.7 MPa [247psi] Vout 0.5~3.5V 0.173V/0.098 MPa [14psi] Pressure [MPa] =0.566 x Vout [V] - 0.283 Pressure [psi] =(0.566 x Vout [V] - 0.283) x 145 1 GND (Black) 2 Vout (White) 3 Vcc (DC5V) (Red)</p>	
Pressure switch	63H1		1) Detects high pressure 2) Provides high-pressure protection	4.15MPa[601psi] OFF setting	

Part name	Symbols (functions)	Notes	Usage	Specifications	Check method
Thermistor	TH4 (Discharge)		1) Detects discharge air temperature 2) Provides high-pressure protection	Degrees Celsius $R_{120} = 7.465k\Omega$ $R_{25/120} = 4057$ $R_t = 7.465 \exp\{4057(\frac{1}{273+t} - \frac{1}{393})\}$	Resistance check
			0°C[32°F] :698kohm 10°C[50°F] :413kohm 20°C[68°F] :250kohm 30°C[86°F] :160kohm 40°C[104°F] :104kohm 50°C[122°F] : 70kohm 60°C[140°F] : 48kohm 70°C[158°F] : 34kohm 80°C[176°F] : 24kohm 90°C[194°F] :17.5kohm 100°C[212°F] :13.0kohm 110°C[230°F] : 9.8kohm		
	TH2		LEV 1 is controlled based on the TH2, TH3, and TH6 values.	Degrees Celsius $R_0 = 15k\Omega$ $R_{0/80} = 3460$ $R_t = 15 \exp\{3460 (\frac{1}{273+t} - \frac{1}{273})\}$ 0°C[32°F] :15kohm 10°C[50°F] :9.7kohm 20°C[68°F] :6.4kohm 25°C[77°F] :5.3kohm 30°C[86°F] :4.3kohm 40°C[104°F] :3.1kohm	
	TH3 (Pipe temperature)		1) Controls frequency 2) Controls defrosting during heating operation 3) Detects subcool at the heat exchanger outlet and controls LEV1 based on HPS data and TH3 data		
	TH7 (Outdoor temperature)		1) Detects outdoor air temperature 2) Controls fan operation		
	TH5		LEV2a and LEV2b are controlled based on the 63LS and TH5 values.		
	TH6		Controls LEV1 based on TH2, TH3, and TH6 data.		
	THHS Inverter heat sink temperature		Controls inverter cooling fan based on THHS temperature		
THBOX Control box internal temperature detection			Degrees Celsius $R_{50} = 17k\Omega$ $R_{25/120} = 4016$ $R_t = 17 \exp\{4016 (\frac{1}{273+t} - \frac{1}{323})\}$ 0°C[32°F] :161kohm 10°C[50°F] :97kohm 20°C[68°F] :60kohm 25°C[77°F] :48kohm 30°C[86°F] :39kohm 40°C[104°F] :25kohm		

[VI Refrigerant Circuit]

Part name	Symbols (functions)	Notes	Usage	Specifications	Check method
Solenoid valve	SV1a Discharge-suction bypass		1) High/low pressure bypass at start-up and stopping, and capacity control during low-load operation 2) High-pressure-rise prevention	AC208-230V Open while being powered/ closed while not being powered	Continuity check with a tester
	SV5b Heat exchanger capacity control		Controls outdoor unit heat exchanger capacity		
	SV5c	P350 - P450 EP250-EP300 models only			
	SV9		High-pressure-rise prevention	Open while being powered/ closed while not being powered	
Linear expansion valve	LEV1 (SC control)		Adjusts the amount of bypass flow from the liquid pipe on the outdoor unit during cooling	DC12V Opening of a valve driven by a stepping motor 0-480 pulses (direct driven type)	Same as indoor LEV The resistance value differs from that of the indoor LEV. (Refer to the section "LEV Troubleshooting.") (page 254)
	LEV2a LEV2b (Refrigerant flow adjustment)		Adjusts refrigerant flow during heating	DC12V Opening of a valve driven by a stepping motor 1400 pulses	Same as indoor LEV
Heater	CH11		Heats the refrigerant in the compressor	Cord heater AC230V P200 - P250 models 1511 ohm 35W P300 - P450 models 1176 ohm 45W	Resistance check
4-way valve	21S4a		Changeover between heating and cooling	AC208-230V Dead: cooling cycle Live: heating cycle	Continuity check with a tester
	21S4b		1) Changeover between heating and cooling 2) Controls outdoor unit heat exchanger capacity	AC208-230V Dead: cooling cycle Outdoor unit heat exchanger capacity at 100% Live: heating cycle Outdoor unit heat exchanger capacity at 50% or heating cycle	
	21S4c	P350 - P450 EP250-EP300 models only			

2. Indoor Unit

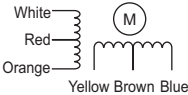
Part Name	Symbol (functions)	Notes	Usage	Specification	Check method
Linear expansion valve	LEV		1) Adjusts superheat at the indoor heat exchanger outlet during cooling 2) Adjusts subcool at the heat exchanger outlet of the indoor unit during cooling	DC12V Opening of stepping motor driving valve 0-(1400) pulses	Refer to the section "Continuity Test with a Tester". Continuity between white, red, and orange. Continuity between yellow, brown, and blue. 
Thermistor	TH1 (Suction air temperature)		Indoor unit control (Thermo)	$R_0=15k\Omega$ $R_{0/80}=3460$ $R_t = 15 \exp\left\{3460\left(\frac{1}{273+t} - \frac{1}{273}\right)\right\}$ 0°C [32°F]:15kohm 10°C [50°F]:9.7kohm 20°C [68°F]:6.4kohm 25°C [77°F]:5.3kohm 30°C [86°F]:4.3kohm 40°C [104°F]:3.1kohm	Resistance check
	TH2 (Pipe temperature)		1) Indoor unit control (Frost prevention, Hot adjust) 2) LEV control during heating operation (subcool detection).		
	TH3 (Gas pipe temperature)		LEV control during cooling operation (superheat detection)		
	TH4 Outdoor air temperature)		Indoor unit control (Thermo)		
	Temperature sensor (Indoor air temperature)		Indoor unit control (Thermo)		

VII Control

[1] Functions and Factory Settings of the Dipswitches	81
[2] Controlling the Outdoor Unit	87
[3] Operation Flow Chart.....	100



[1] Functions and Factory Settings of the Dipswitches

1. Outdoor unit

(1) Control board

Switch		Function	Function according to switch setting		Switch setting timing		Units that require switch setting Note.2	
			OFF	ON	OFF	ON	OC	OS
SWU	1-2	Unit address setting	Set to 00 or 51-100 with the dial switch		Before power on		C	C
SW1	1-10	For self-diagnosis/operation monitoring	Refer to the LED monitor display on the outdoor unit board.		Anytime after power on		C	C
SW2	1	Centralized control switch	Without connection to the centralized controller	With connection to the centralized controller	Before power on		B	B
	2	Deletion of connection information	Normal control	Deletion	Before power on		A	-
	3	Deletion of error history SW	(OC) Storage of IC/OC error history	(OC) Deletion of IC/OC error history	Anytime after power on (When switched from OFF to ON)		C	C
			(OS) Storage of OS error history	(OS) Deletion of OS error history				
	4	Pump down mode	Normal control	Pump down mode	After being energized and while the compressor is stopped		A	-
	5	-	-	-	-		-	-
	6	-	-	-	-		-	-
	7	Forced defrost (Note 3)	Normal control	Forced defrost starts	10 minutes after compressor startup	Anytime after power on (When switched from OFF to ON)	A	A
	8	Defrost timer setting (Note 3)	50 minutes	90 minutes	Anytime after power on (When switched from OFF to ON)		B	B
	9	-	-	-	-		-	-
10	-	-	-	-		-	-	

Note

- 1) Unless otherwise specified, leave the switch to OFF where indicated by "-", which may be set to OFF for a reason.
- 2) A: Only the switch on either the OC or OS needs to be set for the setting to be effective on both units.
 B: The switches on both the OC and OS need to be set to the same setting for the setting to be effective.
 C: The setting is effective for the unit on which the setting is made.
- 3) Refer to "VII [2] Controlling the Outdoor Unit" for details.(page 87)

Switch	Function	Function according to switch setting		Switch setting timing		Units that require switch setting Note.2		
		OFF	ON	OFF	ON	OC	OS	
SW3	1	Test run mode: enabled/disabled	SW3-2 disabled	SW3-2 enabled	Anytime after power on		A	-
	2	Test run mode: ON/OFF	Stops all ICs	Sends a test-run signal to all IC	After power on and when SW3-1 is on.		A	-
	3	Defrost start temperature	P200 - P300 EP200 -10°C [14°F]	-5°C [23°F]	Anytime after power on	B	B	
			P350 - P450 EP250 · EP300 -8°C [18°F]					
	4	Defrost end temperature	P200 - P300 EP200 10°C [50°F]	5°C [41°F]	Anytime after power on (except during defrost operation)	B	B	
			P350 - P450 EP250 · EP300 7°C [45°F]					
	5	-	-	-	-	-	-	
	6	Temperature unit setting	°C	°F (Note 4)	Anytime after power on		C	C
	7	-	-	-	-	-	-	
	8	-	-	-	-	-	-	
9	Model setting	Outdoor standard static pressure	Outdoor high static pressure	Before being energized		C	C	
10	Model setting	High static pressure 60Pa	High static pressure 30Pa	Before being energized		C	C	
SW4	1	-	-	-	-	-	-	
	2	-	-	-	-	-	-	
	3	Refrigerant amount adjustment	Normal operation mode	Refrigerant amount adjust mode	Anytime after being energized (except during initial startup mode. Automatically cancelled 60 minutes after compressor startup)		A	-
	4	Low-noise mode/step demand switching	Low-noise mode (Note 3)	Step demand mode	Before being energized		C	C
	5	-	-	-	-	-	-	
	6	Cumulative compressor operation time data deletion	Cumulative compressor operation time data is retained.	Cumulative compressor operation time data is deleted.	Anytime after power on (when the unit is turned on)		C	C
	7	-	-	-	-	-	-	
	8	-	-	-	-	-	-	
	9	-	-	-	-	-	-	
	10	-	-	-	-	-	-	

Note

- 1) Unless otherwise specified, leave the switch to OFF where indicated by "-", which may be set to OFF for a reason.
- 2) A: Only the switch on either the OC or OS needs to be set for the setting to be effective on both units.
B: The switches on both the OC and OS need to be set to the same setting for the setting to be effective.
C: The setting is effective for the unit on which the setting is made.
- 3) The noise level is reduced by controlling the compressor frequency and outdoor fan rotation speed.
Setting of CN3D is required.(page 25)
- 4) Set SW3-6 to OFF (°C setting) after servicing.

Switch	Function	Function according to switch setting		Switch setting timing		Units that require switch setting Note.2		
		OFF	ON	OFF	ON	OC	OS	
SW5	1	Model selection	See the table below (Note 4)		Before being energized		C	C
	2							
	3							
	4							
	5	Low-noise mode selection	Capacity priority mode (Note 3)	Low-noise mode	Before being energized		A	-
	6	-	-	-	-		-	-
	7	Model selection	See the table below (Note 4)		Before being energized		B	B
	8	-	-	-	-		-	-
	9	-	-	-	-		-	-
	10	-	-	-	-		-	-

Note

- 1) Unless otherwise specified, leave the switch to OFF where indicated by "-", which may be set to OFF for a reason.
- 2) A: Only the switch on either the OC or OS needs to be set for the setting to be effective on both units.
 B: The switches on both the OC and OS need to be set to the same setting for the setting to be effective.
 C: The setting is effective for the unit on which the setting is made.
- 3) When set to the capacity priority mode and if the following conditions are met, the Low-noise mode will terminate, and the unit will go back into the normal operation mode.
 Cooling: Outside temperature is high or high pressure is high.
 Heating: Outside temperature is low or low pressure is low.(page 23)
- 4) The table below summarizes the factory settings for dipswitches SW5-1 through SW5-4, and SW5-7. The factory setting for all other dipswitches is OFF.

SW 5					model
1	2	3	4	7	
OFF	ON	OFF	OFF	ON	(E)P200YHM model
ON	ON	OFF	OFF	ON	(E)P250YHM model
OFF	OFF	ON	OFF	ON	(E)P300YHM model
OFF	ON	ON	OFF	ON	P350YHM model
ON	ON	ON	OFF	ON	P400YHM model
OFF	OFF	OFF	ON	ON	P450YHM model

(2) INV board

Functions are switched with the following connector.

Connector	Function	Function according to connector		Setting timing	
		Enabled	Disabled	Enabled	Disabled
CN6 short-circuit connector	Enabling/disabling the following error detection functions; ACCT sensor failure (5301 Detail No. 115) ACCT sensor circuit failure (5301 Detail No.117) IPM open/ACCT erroneous wiring (5301 Detail No. 119) Detection of ACCT erroneous wiring (5301 Detail No.120)	Error detection enabled	Error detection disable (No load operation is possible.)	Anytime after power on	

Note

- CN6 short-circuit connector is mated with the mating connector.
- Leave the short-circuit connector on the mating connector during normal operation to enable error detection and protect the equipment from damage.

2. Function of the switch (Indoor unit)

(1) Dipswitches

1) SW1,3

Switch	Function	Function according to switch setting		Switch setting timing		Notes	
		OFF	ON	OFF	ON		
SW1	1	Room temperature detection position		Built-in sensor on the remote controller			Set to ON (built-in sensor on the remote controller) on All Fresh (PEFY-VMH-F) model units Always set to OFF on PKFY-VBM model units While the unit is stopped (Remote controller OFF) Applicable to All Fresh model units (PEFY-VMH-F) only Applicable to All Fresh model units (PEFY-VMH-F) only
	2	Clogged filter detection	Not available				
	3	Filter check reminder time setting	100h	2500h			
	4	Outside air intake		Enabled			
	5	Remote display option		Thermo-ON signal			
	6	Humidifier control	During heating operation	Always on while in the heating mode			
	7	Fan speed setting for Heating Thermo-OFF	Very Low	Low			
		Forced heating operation at OA temp of 5°C or below	Not available				
	8	Fan speed setting for Heating Thermo-OFF		Preset speed			
		-		-			
9	Self-recovery after power failure		Enabled				
10	Power source start-stop		Enabled				
SW3	1	Unit model selection		Cooling only			
	2	Louver	Not available	Available			
	3	Vane	Not available	Available			
	4	Vane swing function	Not available	Available		Always set to OFF on PKFY-VBM model units	
	5	-		-			
	6	Vane angle limit setting for cooling operation		Horizontal		Always set to Downblow B or C on PKFY-VBM model units	
		Initial vane position	Enabled			PLFY-VLMD model only	
	7	Automatic LEV value conversion function		Available			
	8	Heating 4°C [7.2°F] up		Disabled		Set to OFF on floor-standing (PFFY) type units	
	9	SHm setting	2°C [3.6°F]	5°C [9°F]		The setting depends on the model and type.	
10	SCm setting	10°C [18°F]	15°C [27°F]		The setting depends on the model and type.		

Note 1. Settings in the shaded areas are factory settings. (Refer to the table below for the factory setting of the switches whose factory settings are not indicated by the shaded cells.)
 Note 2. If both SW1-7 and SW1-8 are set to ON, the fan remains stopped during heating Thermo-OFF.

To prevent incorrect temperature detection due to a build-up of warm air around the indoor unit, use the built-in temperature sensor on the remote controller (SW1-1) instead of the one on the indoor unit inlet thermistor.

Note 3. By setting SW3-1, SW1-7, and SW1-8 to a certain configuration, the fan can be set to remain stopped during cooling Thermo-OFF. See the table below for details.

Switch setting	SW1-7		SW1-8		Fan speed during Thermo-OFF		Cooling-only/heat pump	
	SW1-7	SW1-8	Heating	Cooling	Heating	Cooling		
OFF	OFF	OFF	Very Low	Preset speed	Preset speed	Preset speed	Heat pump	
	ON	OFF	Low					
	OFF	ON	Preset speed					
	ON	ON	Stop					
ON	OFF	OFF	-	Preset speed	Preset speed	Preset speed	Cooling-only	
	ON	OFF	-					
	OFF	ON	-					Stop
	ON	ON	Stop					Stop

2) SW2

Model	P20	P25	P32	P40	P50	P63	P71	P80	P100	P125	P140	P200	P250
Capacity (model) code	4	5	6	8	10	13	14	16	20	25	28	40	50
SW2 setting	ON OFF 123456	ON OFF 123456	ON OFF 123456	ON OFF 123456	ON OFF 123456	ON OFF 123456	ON OFF 123456	ON OFF 123456	ON OFF 123456	ON OFF 123456	ON OFF 123456	ON OFF 123456	ON OFF 123456

Note. The setting timing for SW2 is before power is turned on.

(2) Address switch

Actual indoor unit address setting varies in different systems. Refer to the installation manual for the outdoor unit for details on how to make the address setting.

Each address is set with a combination of the settings for the 10's digit and 1's digit.

(Example)

When setting the address to "3", set the 1's digit to 3, and the 10's digit to 0.

When setting the address to "25", set the 1's digit to 5, and the 10's digit to 2.

3. Function of the switch <Remote controller>

(1) MA remote controller (PAR-20MAA)

The SW is located at the bottom of the remote controller under the cover. Operate the switches to perform the remote controller main/sub setting or other function settings. Normally, do not change the settings of switches other than the SW1 (main/sub switching switch). (All the switches are set to "ON" at factory setting.)

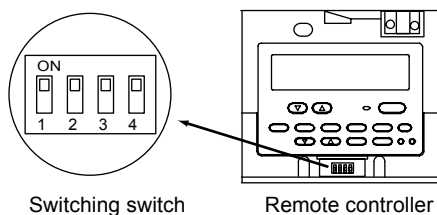

Switch	Function	ON	OFF	Operation by switch settings	Switch setting timing
1	Remote controller main/sub setting	Main	Sub	When two remote controllers are connected to one group, set either of the remote controllers to "Sub".	Before power on
2	At power on of the remote controller	Normal startup	Timer mode startup	When the program timer (only few stock products are available) is connected, set to "Timer mode startup" to resume the operation with timer mode after power is restored.	Before power on
3	Cooling/heating display set by automatic setting	Displayed	Not displayed	When the automatic mode is set and the "Cooling"/"Heating" display is not necessary, set to "Not displayed".	Before power on
4	Suction temperature display (discharge temperature display)	Displayed	Not displayed	When the suction temperature (discharge temperature) display is not necessary, set to "Not displayed".	Before power on

Note

The MA remote controller (PAR-21MAA) does not have the switches listed above. Refer to the installation manual for the function setting.

(2) ME remote controller (PAR-F27MEA)

Set the address of the remote controller with the rotary switch.

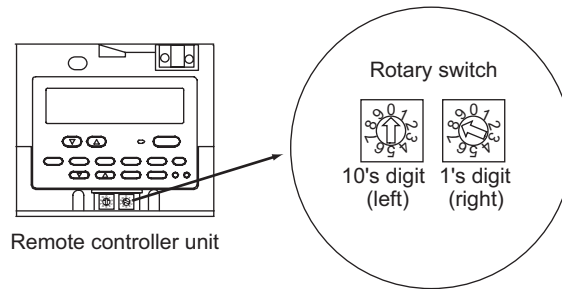

Example: In case of address 108

	Address setting range	Setting method
Main remote controller	101-150	Add 100 to the smallest address of all the indoor units in the same group.
Sub remote controller	151-200	Add 150 to the smallest address of all the indoor units in the same group.
Setting of rotary switch	Address No.	
01-99 ^{*1}	101-199 with the 100's digit automatically being set to 1 ^{*2}	
00	200	

*1. At factory shipment, the rotary switch is set to 01.

*2. The address range that can be set with the ME remote controller is between 101 and 200. When the dials are set to a number between 01 and 99, the 100's digit is automatically set to [1]. When the dials are set to 00, the 100's digit is automatically set to [2].

Note

To set addresses, use a precision slotted screw driver [2.0 mm [0.08 in] (w)], and do not apply than 19.6N. The use of any other tool or applying too much load may damage the switch.

[2] Controlling the Outdoor Unit

-1- Outline of Control Method

- The outdoor units are designated as OC, OS1 and OS2 in the order of capacity from large to small (if two or more units have the same capacity, in the order of address from small to large).
- The setting of outdoor unit can be verified by using the self-diagnosis switch (SW1).

SW1		Display																														
ON	<table border="1"> <tr> <td>1</td><td>2</td><td>3</td><td>4</td><td>5</td><td>6</td><td>7</td><td>8</td><td>9</td><td>10</td> </tr> <tr> <td>■</td><td>■</td><td>■</td><td>■</td><td>□</td><td>□</td><td>□</td><td>□</td><td>□</td><td>□</td> </tr> <tr> <td>□</td><td>□</td><td>□</td><td>□</td><td>■</td><td>■</td><td>■</td><td>■</td><td>■</td><td>■</td> </tr> </table>	1	2	3	4	5	6	7	8	9	10	■	■	■	■	□	□	□	□	□	□	□	□	□	□	■	■	■	■	■	■	<ul style="list-style-type: none"> ■ The unit is designated as the OC: "oc" appears on the display. ■ The unit is designated as OS1: "oS-1" appears on the display ■ The unit is designated as OS2: "oS-2" appears on the display.
1	2	3	4	5	6	7	8	9	10																							
■	■	■	■	□	□	□	□	□	□																							
□	□	□	□	■	■	■	■	■	■																							

- The OC determines the operation mode and the control mode, and it also communicates with the indoor units.
- The OS exercises autonomous distributed control (over defrost, error detection, and actuator control etc.) according to the operation/control mode signals that are sent from the OC.

-2- Startup sequence rotation

- At the initial startup, outdoor units start up in the order of "OC, OS1 and OS2." After two or more hours of operation, the startup sequence changes to "OS1, OS2 and OC" or "OS2, OC and OS1".
- Startup sequence rotation is performed while all the indoor units are stopped. (Even after two hours of operation, startup sequence rotation is not performed while the compressor is in operation.)
- Refer to [-12- Control at Initial Start-up] for the initial startup.
- Performing startup sequence rotation does not change the basic operation of OC and OS. Only startup sequence is changed.
- Startup sequence of the outdoor units can be checked with the self-diagnosis switch (SW1) on the OC.

SW1		Display																														
ON	<table border="1"> <tr> <td>1</td><td>2</td><td>3</td><td>4</td><td>5</td><td>6</td><td>7</td><td>8</td><td>9</td><td>10</td> </tr> <tr> <td>■</td><td>■</td><td>■</td><td>■</td><td>□</td><td>■</td><td>■</td><td>■</td><td>■</td><td>■</td> </tr> <tr> <td>■</td><td>■</td><td>■</td><td>■</td><td>■</td><td>■</td><td>■</td><td>■</td><td>■</td><td>■</td> </tr> </table>	1	2	3	4	5	6	7	8	9	10	■	■	■	■	□	■	■	■	■	■	■	■	■	■	■	■	■	■	■	■	<ul style="list-style-type: none"> ■ OC→OS1→OS2: "oc" and the OC address appear alternately on the display. ■ OS1→OS2→OC: "oS-1" and the OS1 address appear alternately on the display. ■ OS2→OC→OS1: "oS-2" and the OS2 address appear alternately on the display.
1	2	3	4	5	6	7	8	9	10																							
■	■	■	■	□	■	■	■	■	■																							
■	■	■	■	■	■	■	■	■	■																							

-3- Initial Control

- When the power is turned on, the initial processing of the microcomputer is given top priority.
- During the initial processing, control processing of the operation signal is suspended. (The control processing is resumed after the initial processing is completed. Initial processing involves data processing in the microcomputer and initial setting of each of the LEV opening. This process will take up to 5 minutes.)
- During the initial processing, the LED monitor on the outdoor unit's control board displays S/W version -> refrigerant type -> heat pump -> cooling only and capacity -> and communication address in turn every second.

-4- Control at Start-up

- The upper limit of frequency during the first 3 minutes of the operation is 50 Hz.
- When the power is turned on, normal operation will start after the initial start-up mode (to be described later) has been completed (with a restriction on the frequency).

-5- Bypass Control

Bypass solenoid valves (SV1a), which bypass the high- and low- pressure sides, perform the following functions.

(1) Bypass solenoid valve (SV1a) (ON = Open), (SV9) (ON = Open)

Operation	SV1a	
	ON	OFF
When starting-up the compressor of each outdoor unit	ON for 4 minutes.	
After the restoration of thermo or 3 minutes after restart	ON for 4 minutes.	
During cooling or heating operation with the compressor stopped	Always ON. Exception: OFF when 63HS1-63LS is 0.2 MPa [29 psi] or less	
After the operation has stopped	ON for 3 minutes. Exception: OFF when 63HS1-63LS is 0.2 MPa [29 psi] or less	
During defrost operation	ON	
While the compressor is operating at the minimum frequency and when the low pressure (63LS) drops (3 or more minutes after compressor startup)	When low pressure (63LS) drops below 0.23 MPa [33 psi].	When low pressure (63LS) exceeds 0.38 MPa [55 psi].
When high pressure (63HS1) rises	When 63HS1 exceeds 3.62 MPa [525 psi]	When 63HS1 is or below 3.43 MPa [497 psi] and 30 seconds have passed

Operation	SV9	
	ON	OFF
When high pressure (63HS1) rises during the heating operation	When 63HS1 exceeds 3.50MPa [507psi]	When 63HS1 is or below 2.70Mpa [391psi]
When startup or resuming operation after a defrost cycle	ON for 5 minutes and goes OFF	
Others	Always OFF	

-6- Compressor Frequency Control

- Depending on the capacity required, the frequency of the compressor is controlled to keep constant evaporation temperature (0°C [32°F] = 0.71 MPa [103 psi]) during cooling operation, and condensing temperature (49°C [120°F] = 2.88 MPa [418 psi]) during heating operation.
- The table below summarizes the operating frequency ranges of the inverter compressor during normal operation.
- The OS in the multiple-outdoor-unit system operates at the actual compressor frequency value that is calculated by the OS based on the preliminary compressor frequency value that the OC determines.

Model	Frequency/cooling (Hz)		Frequency/heating (Hz)	
	Max	Min	Max	Min
200 model	52	13	53	13
250 model	65	13	71	13
300 model	74	16	81	16
350 model	95	16	101	16
400 model	97	18	102	18
450 model	111	18	117	18

Note

The maximum frequency during heating operation is affected by the outdoor air temperature to a certain extent.

(1) Pressure limit

The upper limit of high pressure (63HS1) is preset, and when it exceeds the upper limit, the frequency is decreased every 15 seconds.

- The actuation pressure is when the high-pressure reading on 63HS1 is 3.58MPa[519psi].

(2) Discharge temperature limit

Discharge temperature (TH4) of the compressor in operation is monitored, and when it exceeds the upper limit, the frequency is decreased every minute.

- Operating temperature is 115°C [239°F].

(3) Periodic frequency control

Frequency control other than the ones performed at start-up, upon status change, and for protection is called periodic frequency control (convergent control) and is performed in the following manner.

Periodic control cycle

Periodic control is performed after the following time has passed

- 30 seconds after either compressor start-up or the completion of defrost operation
- 30 seconds after frequency control based on discharge temperature or pressure limit

The amount of frequency change

The amount of frequency change is controlled to approximate the target value based on the evaporation temperature (Te) and condensing temperature (Tc).

-7- Defrost Operation Control

(1) Starting the defrost operation

- The defrost cycle starts when the pipe temperature (TH3), in the following table, or below has continuously been detected for 3 minutes after the integrated compressor operation time of 50 minutes have passed (90 minutes when the defrost prohibit timer is set to 90 minutes).
- If 10 minutes have passed since compressor start-up or since the completion of defrost operation, forced defrost operation will start by turning on the forced defrost switch (DIP SW2-7).
- Even if the defrost prohibit timer is set to 90 minutes, the actual defrost prohibit time for the next operation will be 50 minutes if defrosting took 12 minutes.
- In the multiple-outdoor-unit system, all of the outdoor units that are in operation go into the defrost mode simultaneously. The unit(s) that is stopped at the time defrost operation starts remains stopped.

Model	TH3	
	SW3 - 3 OFF	SW3 - 3 ON
200 model	- 10°C [14°F]	- 5°C [23°F]
250 model	- 10°C [14°F]	- 5°C [23°F]
300 model	- 10°C [14°F]	- 5°C [23°F]
350 model	- 8°C [18°F]	- 5°C [23°F]
400 model	- 8°C [18°F]	- 5°C [23°F]
450 model	- 8°C [18°F]	- 5°C [23°F]

(2) Defrost operation

Compressor frequency	Model	Compressor frequency
	200 model	60 Hz
	250 model	65 Hz
	300 model	65 Hz
	350 model	103 Hz
	400 model	103 Hz
	450 model	103 Hz
Outdoor unit fan	Stopped	
SV1a	ON	
SV5b, SV5c	ON	
21S4a	OFF	
21S4b, 21S4c	OFF	
SV9	OFF	
LEV1	0 pulse ^{*1}	
LEV2a	1400 pulses	
LEV2b	1400 pulses	

*1. 300 pulses if either of the following formulas are satisfied: $63LS < 2\text{kgf/cm}^2$ or $TH4 \geq 100^\circ\text{C}$ [212°F].

(3) Stopping the defrost operation

1) When SW3-4 is set to OFF

- The defrost cycle ends when 12 minutes have passed since the beginning of the cycle, or when the pipe temperature (TH3), in the following table, or above has been continuously detected for 4 minutes.
- Defrost operation will not stop its operation for 2 minutes once started unless the piping temperature exceeds 25°C [77°F] within 2 minutes, in which case the operation will stop.
- In the multiple-outdoor-unit system, defrosting is stopped on all units at the same time.

2) When SW3-4 is set to ON

- The defrost cycle ends when 12 minutes have passed since the beginning of the cycle, or when the pipe temperature (TH3) has been continuously detected for 2 minutes (when SW3-4 is set to OFF) that exceeds the values in the table below.
- The defrost cycle will not end for two minutes once started unless the pipe temperature α goes outside the ranges below. ($25^{\circ}\text{C}[77^{\circ}\text{F}] \geq \alpha \geq 5^{\circ}\text{C}[41^{\circ}\text{F}]$, $\alpha = 25^{\circ}\text{C}[77^{\circ}\text{F}] + \text{TH7}$)

Model	TH3	
	SW3 - 4 OFF	SW3 - 4 ON
200 model	10°C [50°F]	5°C [41°F]
250 model	10°C [50°F]	5°C [41°F]
300 model	10°C [50°F]	5°C [41°F]
350 model	7°C [45°F]	5°C [41°F]
400 model	7°C [45°F]	5°C [41°F]
450 mode;	7°C [45°F]	5°C [41°F]

(4) Problems during defrost operation

- If a problem is detected during defrost operation, the operation will be stopped, and the defrost prohibition time based on the integrated compressor operation time will be set to 20 minutes.

(5) Change in the number of operating indoor units during defrost operation

- Even when there is a change in the number of operating indoor units during defrost operation, the operation will continue, and an adjustment will be made after the completion of the defrost operation.
- Defrost operation will be continued, even if the indoor units stop or under the Thermo-OFF conditions until it has run its course.

-8- Refrigerant Recovery Control

Recovery of refrigerant is performed during heating operation to prevent the refrigerant from accumulating inside the unit while it is stopped (unit in fan mode), or inside the indoor unit that is in cooling mode or in heating mode with thermo off. It is also performed during cooling operation to prevent an excessive amount of refrigerant from accumulating in the outdoor heat exchanger.

It is also performed during cooling operation to prevent an excessive amount of refrigerant from accumulating in the outdoor heat exchanger.

(1) During heating operation

Starting refrigerant recovery mode

The refrigerant recovery mode in heating starts when all of the following three conditions are met:

- 15 minutes have passed since the completion of previous refrigerant recovery.
- TH4 > 115°C [239°F]
- Frequencies below 50 Hz

Refrigerant recovery

- 1) Refrigerant is recovered with the LEV on the applicable indoor unit (unit under stopping mode, fan mode, cooling, heating with thermo off) being opened for 30 seconds.

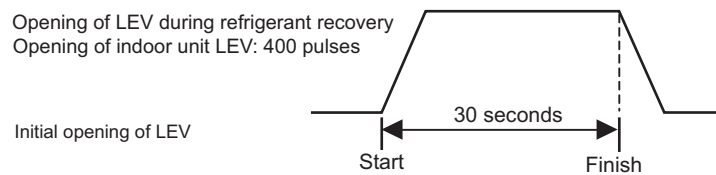

- 2) Periodic capacity control of the outdoor units and periodic LEV control of the indoor units will be suspended during refrigerant recovery operation; they will be performed after the recovery has been completed.

(2) During cooling operation

Starting refrigerant recovery mode

The refrigerant recovery mode starts when all the following conditions are met:

- 30 minutes have passed since the completion of previous refrigerant recovery.
- When the unit keeps running for 3 minutes in a row or more with high discharge temperature
- TH4 > 105°C [221°F] or 63HS1 > 3.43 MPa [497 psi] (35 kg/cm²G) and SC0 > 10°C [18°F]

Refrigerant recovery

The opening of LEV1 is increased and periodic control begins again.

-9- Capacity Control of Outdoor Fan

(1) Control method

- Depending on the capacity required, the rotation speed of the outdoor unit fan is controlled by the inverter, targeting a constant evaporation temperature of (0°C [32°F]= 0.71 MPa [103 psi]) during cooling operation and constant condensing temperature of (49°C [120°F]= 2.88 MPa [418 psi]) during heating operation.
- The OS in the multiple-outdoor-unit system operates at the actual outdoor unit fan control value that is calculated by the OS based on the preliminary outdoor unit fan control value that the OC determines.

(2) Control

- Outdoor unit fan stops while the compressor is stopped (except in the presence of input from snow sensor).
- The fan operates at full speed for 5 seconds after start-up. (Only when TH7 < 0°C [32°F])
- The outdoor unit fan stops during defrost operation.

-10- Subcool Coil Control (Linear Expansion Valve <LEV1>)

- The OC, OS1, and OS2 controls the subcool coil individually.
- The LEV is controlled every 30 seconds to maintain constant the subcool at the outdoor unit heat exchanger outlet that is calculated from the values of high pressure (63HS1) and liquid piping temperature (TH3), or the superheat that is calculated from the values of low pressure (63LS) and the bypass outlet temperature (TH2) of the subcool coil.
- LEV opening is controlled based on the values of the inlet (TH6) and the outlet (TH3) temperatures of the subcool coil, high pressure (63HS1), and discharge temperature (TH4). In a single-outdoor-unit system, the LEV is closed (0) in the heating mode, while the compressor is stopped, and during cooling Thermo-OFF. In a multiple-outdoor-unit system, the LEV closes (0) during heating operation, while the compressor is stopped, or during cooling Thermo-OFF. The LEV opens to a specified position when 15 minutes have passed after Thermo-OFF. (65 pulses)
- LEV1 outputs 0 pulse during the defrost cycle, and 300 pulses if either of the following formulas are satisfied: $63LS < 2\text{kgf/cm}^2$ or $TH4 \geq 100^\circ\text{C}$ [212°F].

-11- Refrigerant flow control (Linear expansion valve <LEV2a, LEV2b>)

- Refrigerant flow is controlled by each unit in the combined models during heating. Refrigerant flow control is performed by the OC, OS1, and OS2 individually. The valve opens to a specified angle during cooling (Opening: 1400 pulses)
- Valve opening is controlled based on the values of high pressure (63HS1), discharge temperature (TH4), low pressure (63LS), and piping temperature (TH5).
- The valve moves to the predetermined position while the unit is stopped.
- The valve remains open at the preset position. (1400 pulses)

-12- Control at Initial Start-up

- When started up for the first time before 12 hours have elapsed after power on, the unit goes into the initial startup mode.
- At the completion of the initial operation mode on the OC, OS1, and OS2, they will go into the normal control mode.

1. Flowchart of initial operation

(1) (E)P200, (E)P250, (E)P300, P350, P400, P450 models

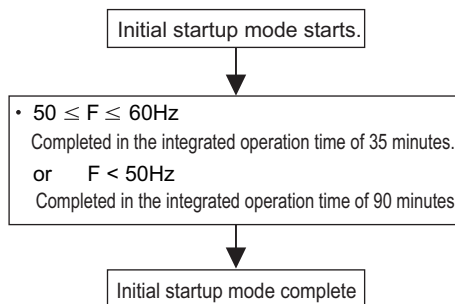

(2) P500, P550, P600, P650, P700, P750, P800, P850, P900 EP400, EP450, EP500, EP550, EP600, EP650 models

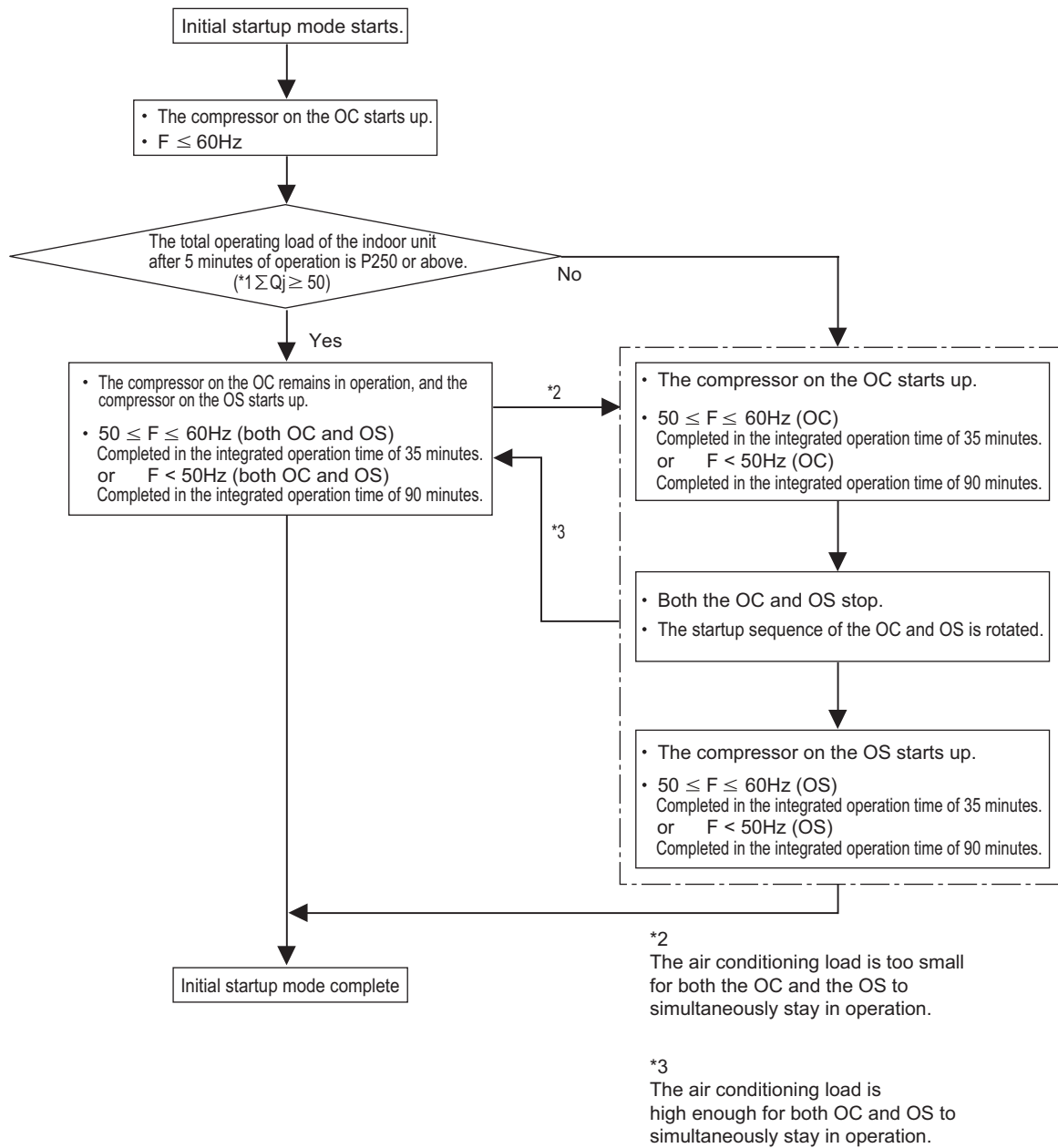

*1 $\sum Q_j$: Total capacity (model name) code
Refer to VII [1] 2.(1) Dipswitches for the capacity codes (page 84).

(3) P950, P1000, P1050, P1100, P1150, P1200, P1250, EP700, EP750, EP800, EP850, EP900 models

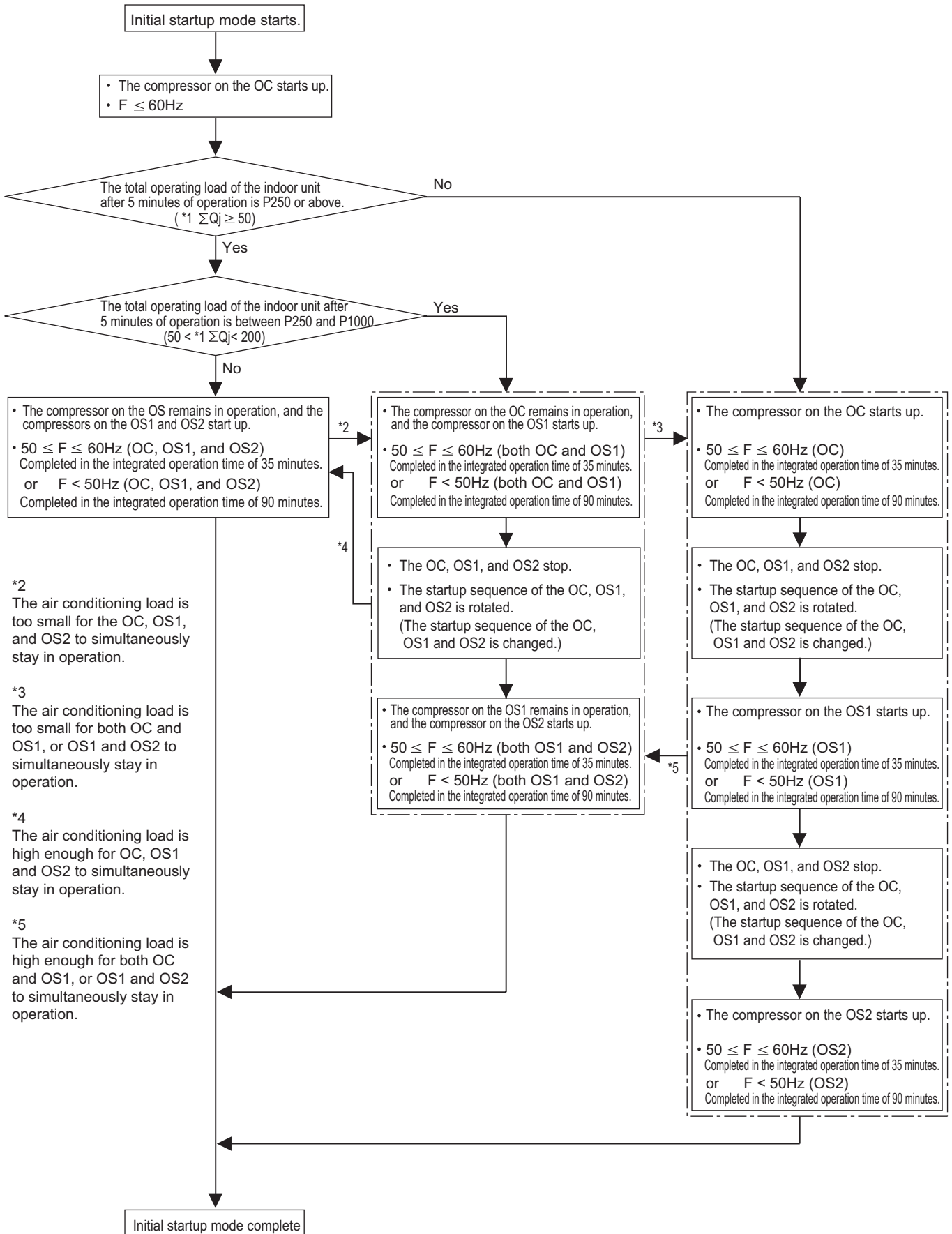

*1 ΣQj: Total capacity (model name) code
Refer to VII [1] 2.(1) Dipswitches for the capacity codes (page 84).

-13- Emergency Operation Mode

1. Problems with the outdoor unit

- Emergency operation mode is a temporary operation mode in which the outdoor unit that is not in trouble operates when one of the outdoor units in the P500 through P900/EP400 through EP650 models is in trouble or when one or two of the outdoor units in the P950 through P1250/EP700 through EP900 models are in trouble.
- This mode can be started by performing an error reset via the remote controller.

(1) Starting the emergency operation

- 1) When an error occurs, the error source and the error code will be displayed on the display on the remote controller.
- 2) The error is reset using the remote controller.
- 3) If an error code appears that permits an emergency operation in step 1) above, (See the table below.), the retry operation starts.
- 4) If the same error is detected during the retry operation (step 3 above), an emergency operation can be started by resetting the error via the remote controller.

Error codes that permit an emergency operation (Applicable to both OC and OS)

Trouble source		Error codes that permit an emergency operation	Error code description
Compressor Fan motor Inverter		0403	Serial communication error
		4220, 4225	Bus voltage drop
		4230	Heatsink overheat protection
		4240	Overload protection
		4250, 4255	Overcurrent relay trip
		5110	Heatsink temperature sensor failure (THHS)
		5301	Current sensor/circuit failure
Thermistor	TH2	5102	Subcool heat exchanger bypass outlet temperature sensor failure
	TH3	5103	Pipe temperature sensor failure
	TH4	5104	Discharge temperature sensor failure
	TH5	5105	Accumulator inlet temperature sensor failure
	TH6	5106	Subcool heat exchanger liquid outlet sensor failure
	TH7	5107	Outside air temperature sensor failure
Power		4102	Open phase
		4115	Power supply sync signal abnormality

Emergency operation pattern (2 outdoor units)

		OC failure pattern	OS failure pattern
OC		Trouble	Normal
OS		Normal	Trouble
Emergency operation	Cooling	Permitted	Permitted
	Heating	Permitted	Permitted
Maximum total capacity of indoor units (Note 1)		60%	

Emergency operation pattern (3 outdoor units)

		OC failure pattern	OS1 failure pattern	OS2 failure pattern	OC, OS1 failure pattern	OC, OS2 failure pattern	OS1, OS2 failure pattern
OC		Trouble	Normal	Normal	Trouble	Trouble	Normal
OS1		Normal	Trouble	Normal	Trouble	Normal	Trouble
OS2		Normal	Normal	Trouble	Normal	Trouble	Trouble
Emergency operation	Cooling	Permitted	Permitted	Permitted	Permitted	Permitted	Permitted
	Heating	Permitted	Permitted	Permitted	Permitted	Permitted	Permitted
Maximum total capacity of indoor units (Note 1)		60%			40%		

(Note 1) If an attempt is made to put into operation a group of indoor units whose total capacity exceeds the maximum allowable capacity, some of the indoor units will go into the same condition as Thermo-OFF.

(2) Ending the emergency operation

1) End conditions

- When one of the following conditions is met, emergency operation stops, and the unit makes an error stop.
- When the integrated operation time of compressor in cooling mode has reached four hours.
- When the integrated operation time of compressor in heating mode has reached two hours.
- When an error is detected that does not permit the unit to perform an emergency operation.

2) Control at or after the completion of emergency operation

- At or after the completion of emergency operation, the compressor stops, and the error code reappears on the remote controller.
- If another error reset is performed at the completion of an emergency mode, the unit repeats the procedures in section (1) above.
- To stop the emergency mode and perform a current-carrying operation after correcting the error, perform a power reset.

2. Communication circuit failure or when some of the outdoor units are turned off

This is a temporary operation mode in which the outdoor unit that is not in trouble operates when communication circuit failure occurs or when some of the outdoor units are turned off.

(1) Starting the emergency operation (When the OC is in trouble)

- 1) When an error occurs, the error source and the error code appear on the display on the remote controller.
- 2) Reset the error via the remote controller to start an emergency operation.

Precautions before servicing the unit

- When the OC is in trouble, the OS temporarily takes over the OC's function and performs an emergency operation. When this happens, the indoor unit connection information are changed.
- In a system that has a billing function, a message indicating that the billing system information has an error may appear on the TG-2000A. Even if this message appears, do not change (or set) the refrigerant system information on the TG-2000A. After the completion of an emergency operation, the correct connection information will be restored.

(2) Starting the emergency operation (When the OS is in trouble)

- 1) A communication error occurs. -> An emergency operation starts in approximately six minutes.

Error codes that permit an emergency operation (Applicable to both OC and OS)

Trouble source	Error codes that permit an emergency operation	Error code description
Circuit board failure or the power to the outdoor units is off	6607	No acknowledgement error
	6608	No response error

Emergency operation pattern (2 outdoor units)

		OC failure pattern	OS failure pattern
OC		Trouble	Normal
OS		Normal	Trouble
Emergency operation	Cooling	Permitted	Permitted
	Heating	Permitted	Permitted
Maximum total capacity of indoor units (Note 1)		Capacity that matches the total capacity of the operable outdoor units	

Emergency operation pattern (3 outdoor units)

		OC failure pattern	OS1 failure pattern	OS2 failure pattern	OC, OS1 failure pattern	OC, OS2 failure pattern	OS1, OS2 failure pattern
OC		Trouble	Normal	Normal	Trouble	Trouble	Normal
OS1		Normal	Trouble	Normal	Trouble	Normal	Trouble
OS2		Normal	Normal	Trouble	Normal	Trouble	Trouble
Emergency operation	Cooling	Permitted	Permitted	Permitted	Permitted	Permitted	Permitted
	Heating	Permitted	Permitted	Permitted	Permitted	Permitted	Permitted
Maximum total capacity of indoor units (Note 1)		Capacity that matches the total capacity of the operable outdoor units					

(Note 1) If an attempt is made to put into operation a group of indoor units whose total capacity exceeds the maximum allowable capacity, some of the indoor units will go into the same condition as Thermo-OFF.

(3) Ending the emergency operation

When communication is restored, the emergency mode is cancelled, and the units go into the normal operation mode.

-14- Operation Mode

(1) Indoor unit operation mode

The operation mode can be selected from the following 5 modes using the remote controller.

1	Cooling mode
2	Heating mode
3	Dry mode
4	Fan mode
5	Stopping mode

(2) Outdoor unit operation mode

1	Cooling mode	All indoor units in operation are in cooling mode.
2	Heating mode	All indoor units in operation are in heating mode.
3	Stopping mode	All indoor units are in fan mode or stopping mode.

Note

When the outdoor unit is performing a cooling operation, the operation mode of the connected indoor units that are not in the cooling mode (Stopped, Fan, Thermo-OFF) cannot be changed to heating from the remote controller. If this attempt is made, "Heating" will flash on the remote controller. The opposite is true when the outdoor unit is performing a heating operation. (The first selection has the priority.)

-15- DEMAND Control

Cooling/heating operation can be prohibited (Thermo-OFF) by an external input to the indoor units.

Note

When DIP SW4-4 is set to ON, the 4-step DEMAND control is enabled.

Eight-step demand control is possible in the system with two outdoor units.

Twelve-step demand control is possible in the system with three outdoor units.

Refer to Chapter II -[3]- 2. -(7) "Various types of control using input-output signal connector on the outdoor unit (various connection options)" for details.(page 23)

[3] Operation Flow Chart

1. Mode determination flowchart

(1) Indoor unit (cooling, heating, dry, fan mode)

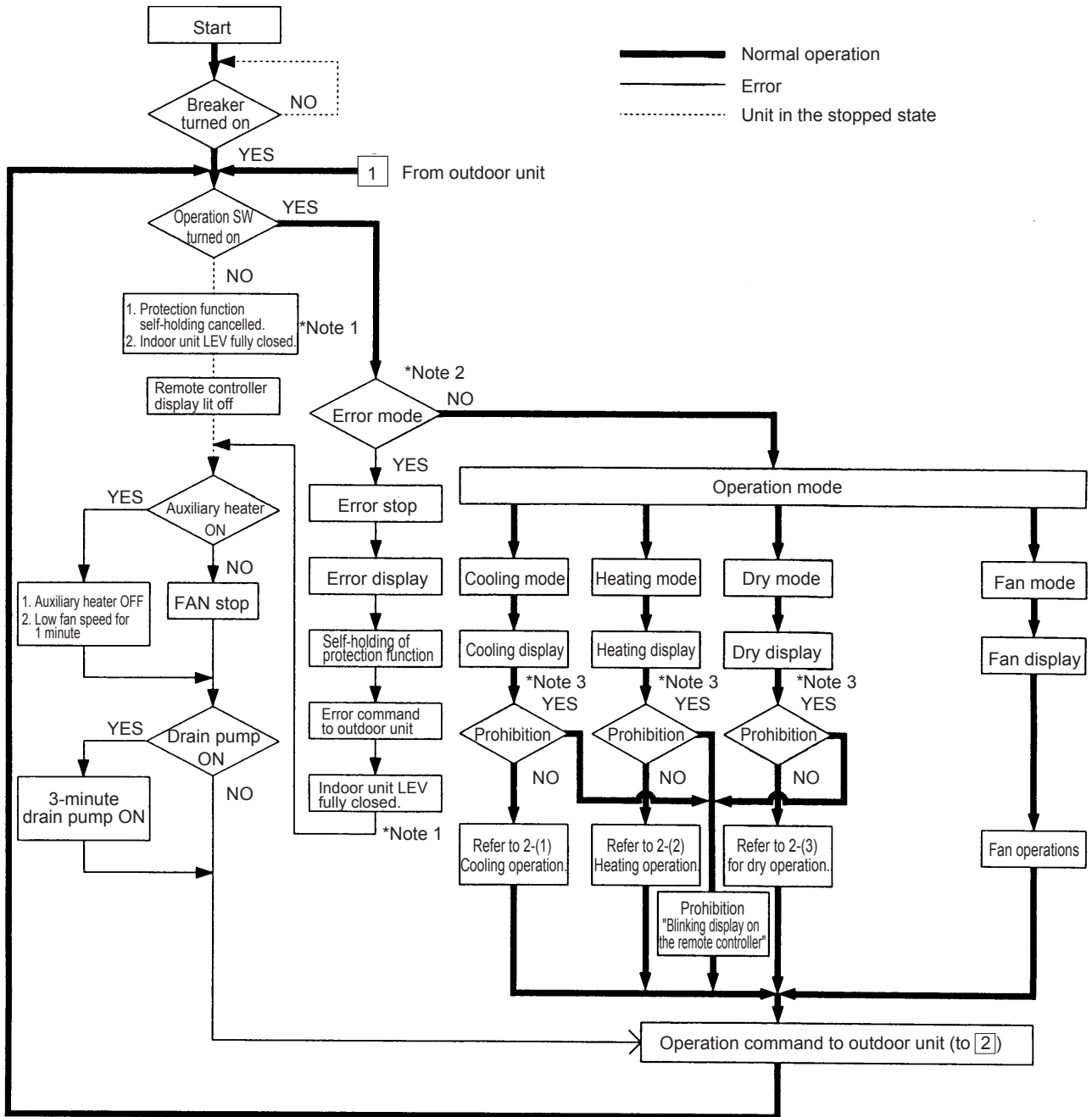

*Note 1. Indoor unit LEV fully closed : Opening 41.

*Note 2. The system may go into the error mode on either the indoor unit or the outdoor unit side. If some of the indoor units are experiencing a problem (except water leakage), only those indoor units that are experiencing the problems will stop. If the outdoor unit is experiencing a problem, all connected indoor units will stop.

*Note 3. The operation will be prohibited when the set cooling/heating mode is different from that of the outdoor unit.

(2) Outdoor unit (cooling and heating modes)

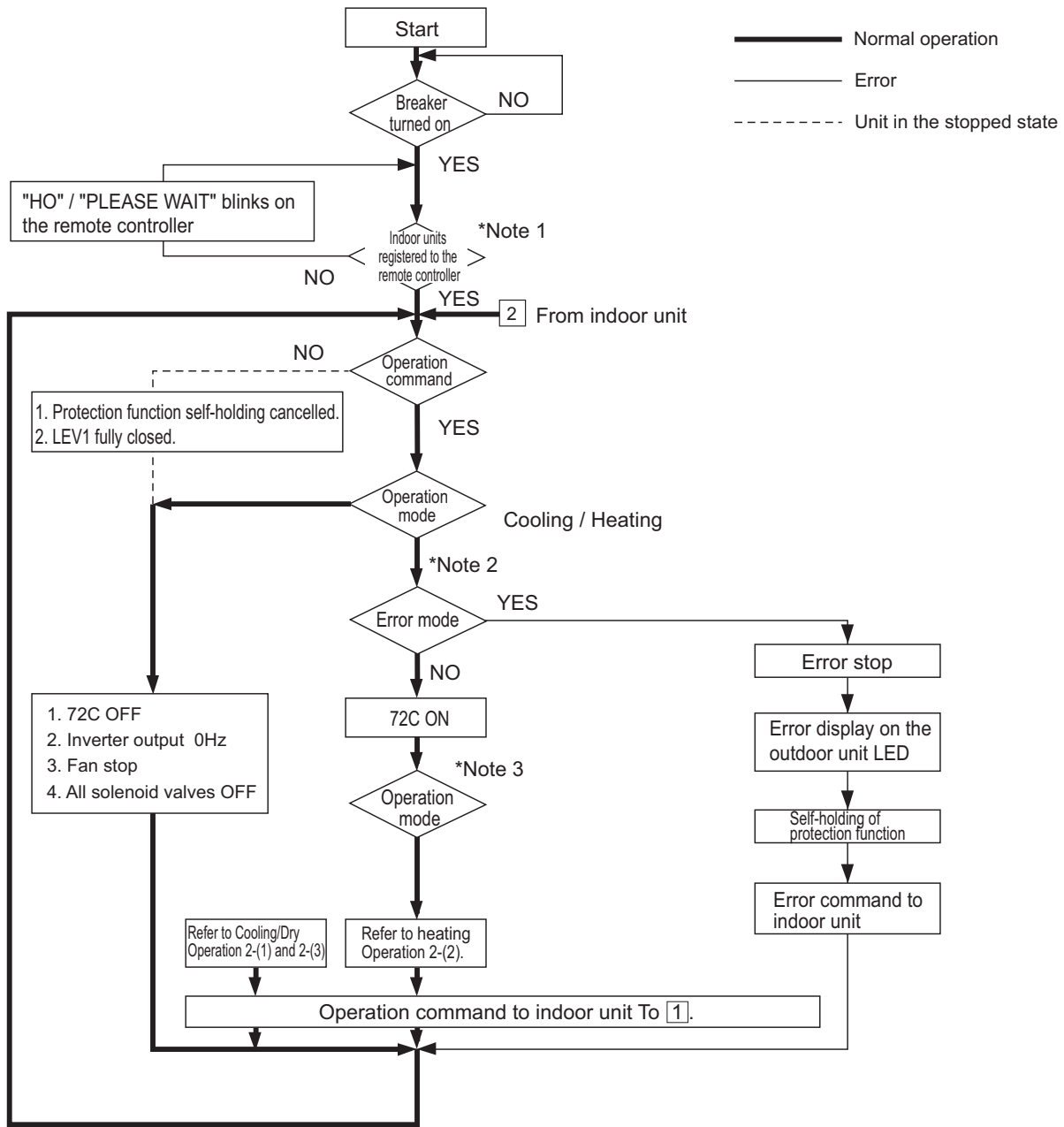

*Note 1. For about 3 minutes after power on, search for the indoor unit address, for the remote controller address, and for the group information will start. During this, "HO" / "PLEASE WAIT" blinks on the display of the remote controller. When the indoor unit to be controlled by the remote controller is missing, "HO" / "PLEASE WAIT" keeps blinking on the display of the remote controller even after 3 or more minutes after power on.

*Note 2. The system may go into the error mode on either the indoor unit or the outdoor unit side. The outdoor stops only when all of the connected indoor units are experiencing problems. The operation of even a single indoor unit will keep the outdoor unit running. The error will be indicated on the LED display.

*Note 3. The outdoor unit operates according to the operation mode commanded by the indoor unit. However, when the outdoor unit is running a cooling operation, come of the operating indoor units will stop, or the operation of these indoor units will be prohibited even when the indoor unit mode is switched from fan mode to heating mode. This also applies when the outdoor unit is running a heating operation.

2. Operations in each mode
(1) Cooling operation

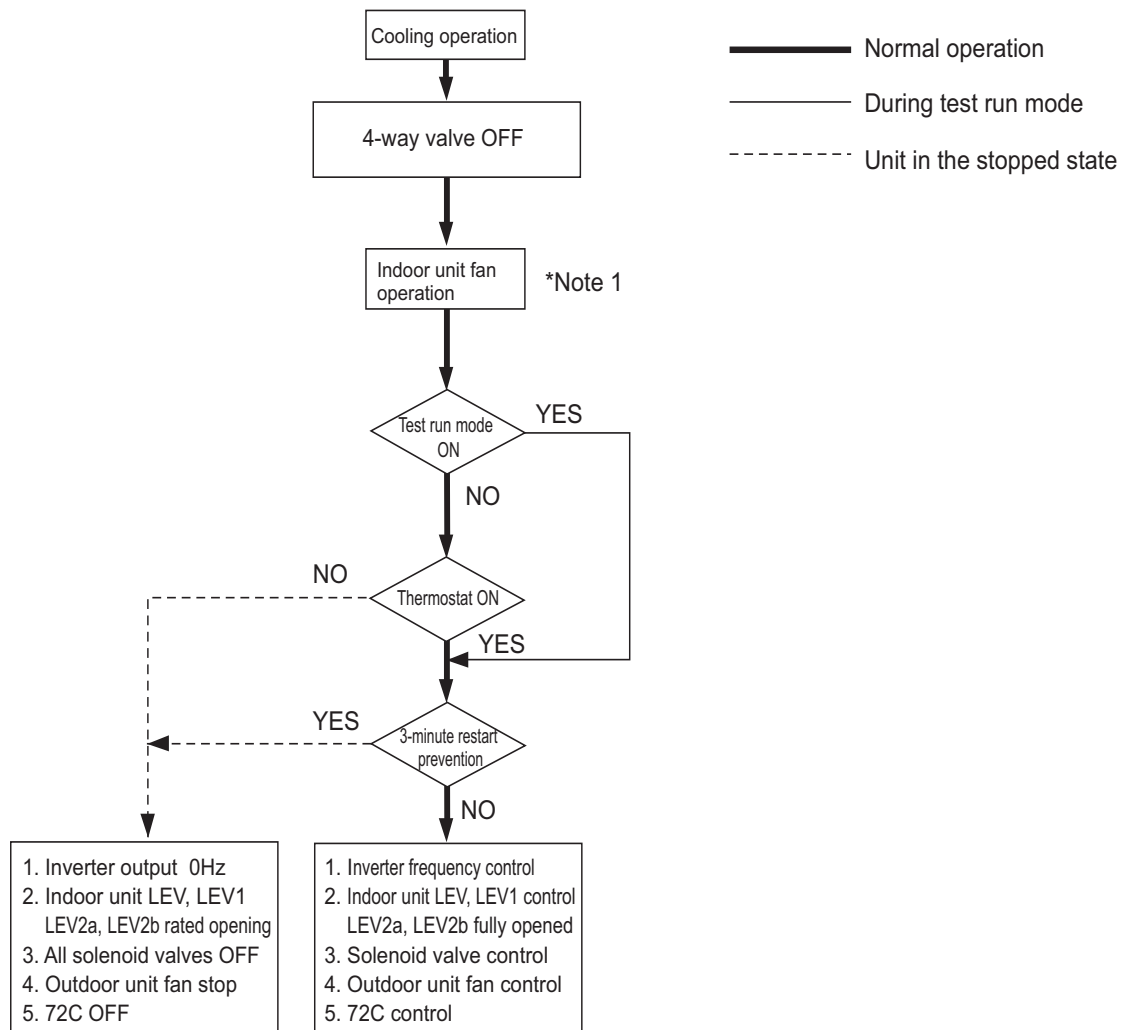

*Note 1. The indoor fan operates at the set notch under cooling mode regardless of the ON/OFF state of the thermostat.

(2) Heating operation

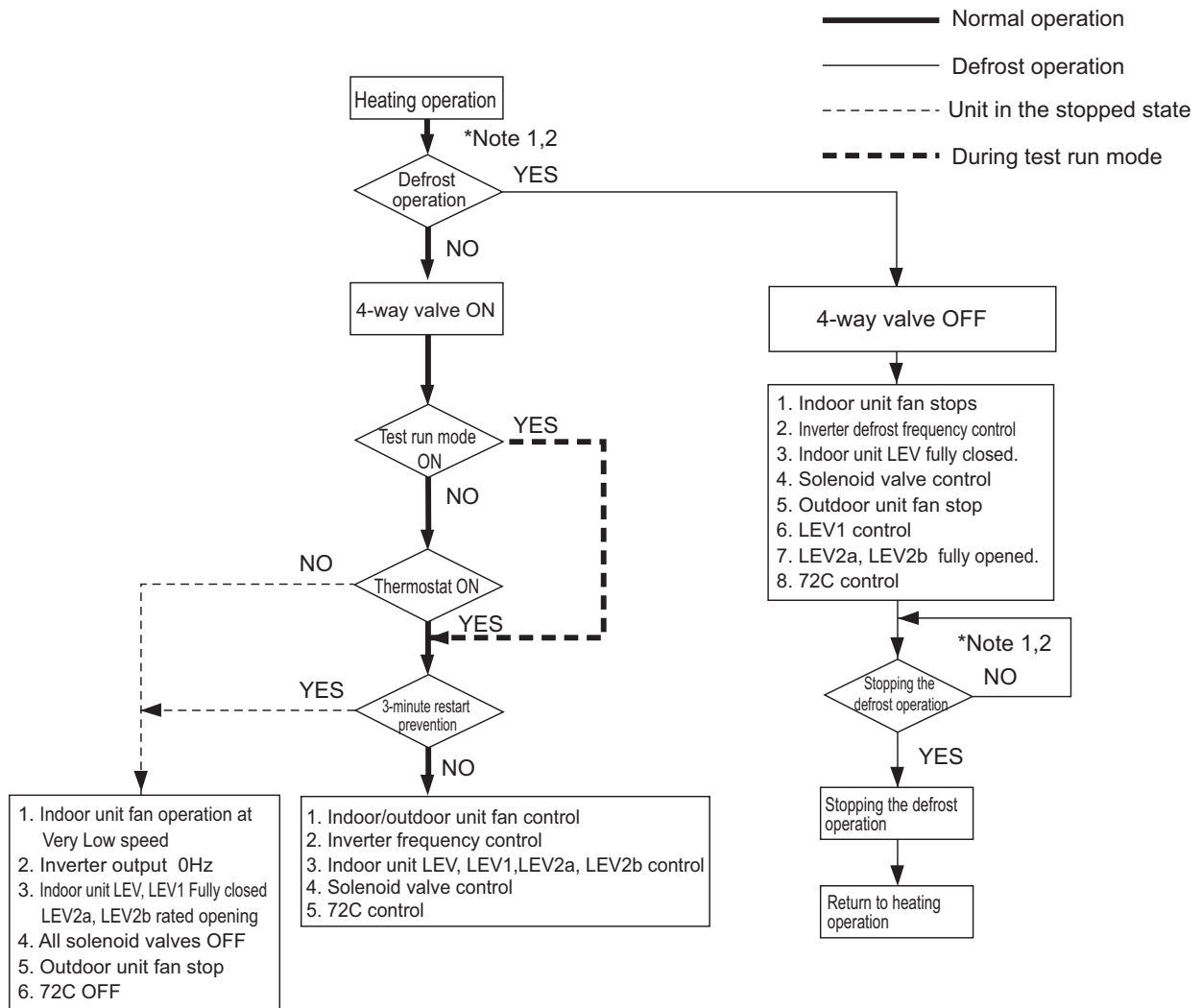

Note

- 1) When outdoor unit starts defrosting, it transmits defrost operations command to indoor unit, and the indoor unit start defrosting operations. Similarly when defrosting operation stops, indoor unit returns to heating operation after receiving defrost end command of outdoor unit.
- 2) Defrost end condition: 12 or more minutes must pass after defrost operation or outdoor unit piping temperature. Refer to "-7- Defrost operation control" of [2] Controlling the Outdoor Unit (page 90) for the temperature.

(3) Dry operation

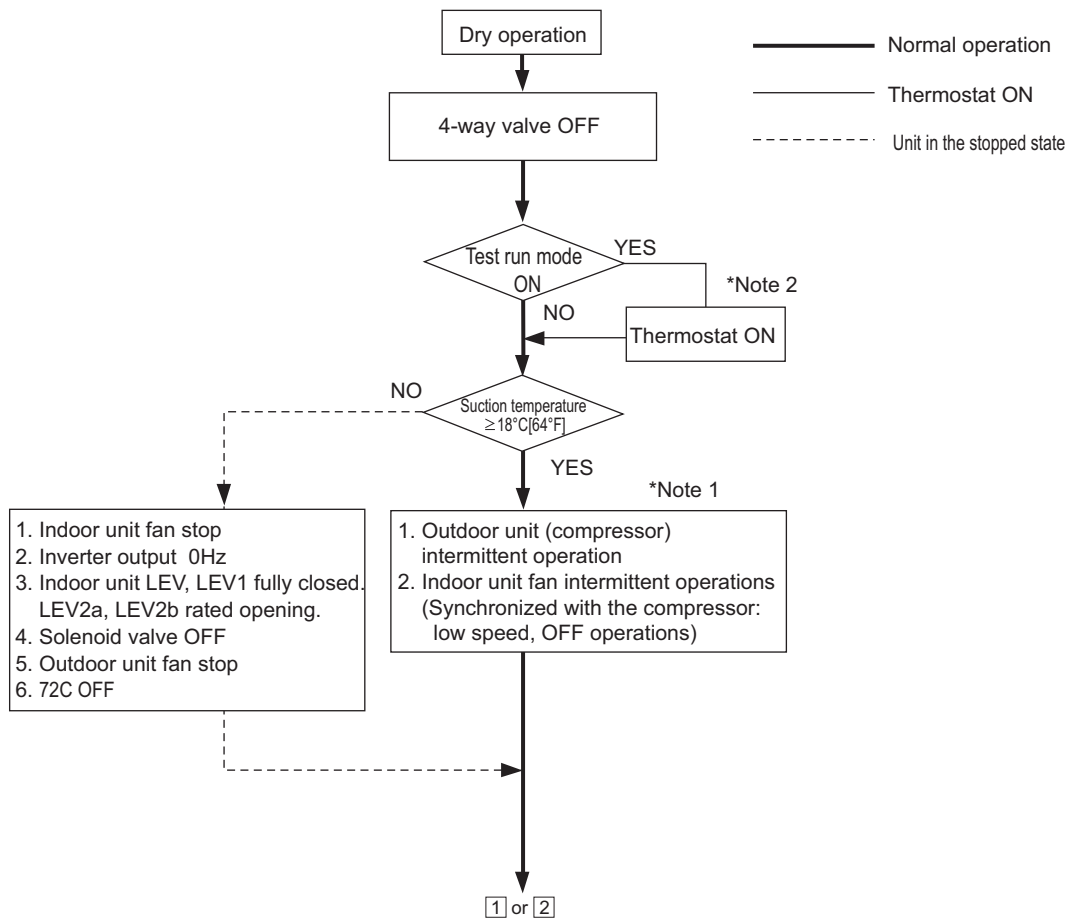

*Note 1. When the indoor unit inlet temperature exceeds 18°C [64°F], the outdoor unit (compressor) and the indoor unit fan start the intermittent operation simultaneously. When the indoor unit inlet temperature becomes 18°C [64°F], or less, the fan always runs (at low speed). The outdoor unit, the indoor unit, and the solenoid valve operate in the same way as they do in the cooling operation when the compressor is turned on.

*Note 2. Thermostat is always kept on during test run mode, and indoor and outdoor unit intermittent operation (ON) time is a little longer than that of normal operation.

VIII Test Run Mode

[1] Items to be checked before a Test Run	107
[2] Test Run Method	108
[3] Operating Characteristic and Refrigerant Amount	109
[4] Adjusting the Refrigerant Amount	109
[5] Refrigerant Amount Adjust Mode	112
[6] The following symptoms are normal.	114
[7] Standard Operation Data (Reference Data)	115



[1] Items to be checked before a Test Run

(1) Check for refrigerant leak and loose cables and connectors.

(2) Measure the insulation resistance between the power supply terminal block and the ground with a 500V megger and make sure it reads at least 1.0Mohm.

Note

- Do not operate the unit if the insulation resistance is below 1.0Mohm.
- Do not apply megger voltage to the terminal block for transmission line. Doing so will damage the controller board.
- The insulation resistance between the power supply terminal block and the ground could go down to close to 1Mohm immediately after installation or when the power is kept off for an extended period of time because of the accumulation of refrigerant in the compressor.
- If insulation resistance reads at least 1Mohm, by turning on the main power and powering the crankcase heater for at least 12 hours, the refrigerant in the compressor will evaporate and the insulation resistance will go up.
- Do not measure the insulation resistance of the terminal block for transmission line for the unit remote controller.

(3) Check that the valve on the gas pipe and liquid pipe are fully open.

Note

Securely tighten the cap.

(4) Check the phase sequence and the voltage of the power supply.

(5) [When a transmission booster is connected]

Turn on the transmission booster before turning on the outdoor units.

Note

- If the outdoor units are turned on first, the connection information for the refrigerant circuit may not be properly recognized.
- In case the outdoor units are turned on before the transmission booster is turned on, perform a power reset on the outdoor units after turning on the power booster.

(6) Turn on the main power to the unit at least 12 hours before test run to power the crankcase heater.

Note

Insufficient powering time may result in compressor damage.

(7) When a power supply unit is connected to the transmission line for centralized control, perform a test run with the power supply unit being energized. Leave the power jumper connector on CN41 as it is (factory setting).

[2] Test Run Method

The figure shows an MA remote controller (PAR-21MAA).

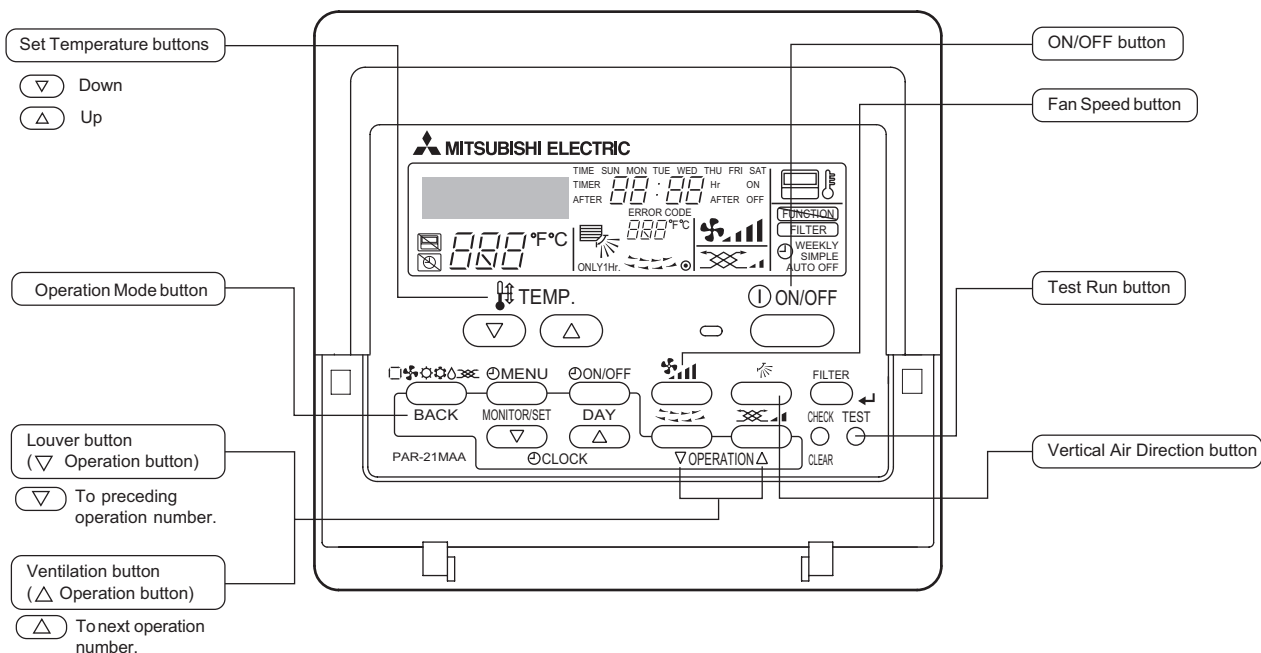

Operation procedures	
Turn on the main power.	→ "PLEASE WAIT" appears on the LCD for up to five minutes. Leave the power on for 12 hours. (Energize the crankcase heater.)
Press the Test button twice.	→ Operation mode display "TEST RUN" and OPERATION MODE are displayed alternately.
Press the Operation Mode button.	→ Make sure that the air is blowing out.
Switch to cooling (or heating) operation by pressing the Operation Mode button.	→ Make sure that cold (or warm) air blows out.
Press the Fan Speed button.	→ Make sure that the fan speed changes with each pressing of the button.
Change the air flow direction by pressing the Vertical Air Direction button or the Louver button.	→ Make sure that the air flow direction changes with each pressing of the button.
→ Confirm the operation of outdoor unit fan.	
Confirm the operation of all interlocked equipment, such as ventilation equipment.	
Cancel the test run by pressing the ON/OFF button.	→ Stop
<p>Note 1: Refer to the following pages if an error code appears on the remote controller or when the unit malfunctions.</p> <p>2: The OFF timer will automatically stop the test run after 2 hours.</p> <p>3: The remaining time for the test run will be displayed in the time display during test run.</p> <p>4: The temperature of the liquid pipe on the indoor unit will be displayed in the room temperature display window on the remote controller during test run.</p> <p>5: On some models, "NOT AVAILABLE" may appear on the display when the Vane Control button is pressed. This is normal.</p> <p>6: If an external input is connected, perform a test run using the external input signal.</p> <p>7: Perform simultaneous all-system operation for 15 minutes or longer because system error detection may take 15 minutes maximum.</p>	

[3] Operating Characteristic and Refrigerant Amount

It is important to have a clear understanding of the characteristics of refrigerant and the operating characteristics of air conditioners before attempting to adjust the refrigerant amount in a given system.

1. Operating characteristic and refrigerant amount

The following table shows items of particular importance.

- 1) During cooling operation, the amount of refrigerant in the accumulator is the smallest when all indoor units are in operation.
- 2) During heating operation, the amount of refrigerant in the accumulator is the largest when all indoor units are in operation.
- 3) General tendency of discharge temperature
 - Discharge temperature tends to rise when the system is short on refrigerant.
 - Changing the amount of refrigerant in the system while there is refrigerant in the accumulator has little effect on the discharge temperature.
 - The higher the pressure, the more likely it is for the discharge temperature to rise.
 - The lower the pressure, the more likely it is for the discharge temperature to rise.
- 4) When the amount of refrigerant in the system is adequate, the compressor shell temperature is 10 to 60°C [18 to 108°F] higher than the low pressure saturation temperature (Te).
 - > If the temperature difference between the compressor shell temperature and low pressure saturation temperature (Te) is smaller than 5°C [9°F], an overcharging of refrigerant is suspected.

[4] Adjusting the Refrigerant Amount

1. Symptoms

Overcharging or undercharging of refrigerant can cause the following symptoms:
 Before attempting to adjust the amount of refrigerant in the system, thoroughly check the operating conditions of the system. Then, adjust the refrigerant amount by running the unit in the refrigerant amount adjust mode.

The system comes to an abnormal stop, displaying 1500 (overcharged refrigerant) on the controller.	Overcharged refrigerant
The operating frequency does not reach the set frequency, and there is a problem with performance.	Insufficient refrigerant amount
The system comes to an abnormal stop, displaying 1102 (abnormal discharge temperature) on the controller.	

2. Amount of refrigerant

(1) To be checked during operation

Operate all indoor units in either cooling-only or heating-only mode, and check such items as discharge temperature, subcooling, low pressure, suction temperature, and shell bottom temperature to estimate the amount of refrigerant in the system.

Symptoms	Conclusion
Discharge temperature is high. (Normal discharge temperature is below 95°C [203°F].)	Slightly undercharged refrigerant
Low pressure is unusually low.	
Suction superheat is large. (Normal suction superheat is less than 20°C [36°F].)	
Compressor shell bottom temperature is high. (The difference between the compressor shell bottom temperature and low pressure saturation temperature (Te) is greater than 60°C [108°F].)	Slightly overcharged refrigerant
Discharge superheat is small. (Normal discharge superheat is greater than 10°C [18°F].)	
Compressor shell bottom temperature is low. (The difference between the compressor shell bottom temperature and low pressure saturation temperature (Te) is less than 5°C [9°F].)	

3. Amount of refrigerant to be added

The amount of refrigerant that is shown in the table below is factory-charged to the outdoor units. The amount necessary for extended pipe (field piping) is not included and must be added on site.

Outdoor unit model	P200	P250	P300	P350	P400	P450
Amount of pre-charged refrigerant in the outdoor unit (kg)	6.5	9.0	9.0	11.5	11.5	11.5
Amount of pre-charged refrigerant in the outdoor unit [lbs-oz]	14-5	19-13	19-13	25-6	25-6	25-6

Outdoor unit model	EP200	EP250	EP300
Amount of pre-charged refrigerant in the outdoor unit (kg)	9.0	11.5	11.5
Amount of pre-charged refrigerant in the outdoor unit [lbs-oz]	19-13	25-6	25-6

(1) Calculation formula

The amount of refrigerant to be added depends on the size and the length of field piping. (unit in m[ft])

$\text{Amount of added refrigerant (kg)} = (0.29 \times L_1) + (0.2 \times L_2) + (0.12 \times L_3) + (0.06 \times L_4) + (0.024 \times L_5) + \alpha$ $\text{Amount of added refrigerant (oz)} = (3.12 \times L_1') + (2.15 \times L_2') + (1.29 \times L_3') + (0.65 \times L_4') + (0.26 \times L_5') + \alpha'$

- L_1 : Length of $\varnothing 19.05$ [3/4"] liquid pipe (m)
 - L_2 : Length of $\varnothing 15.88$ [5/8"] liquid pipe (m)
 - L_3 : Length of $\varnothing 12.7$ [1/2"] liquid pipe (m)
 - L_4 : Length of $\varnothing 9.52$ [3/8"] liquid pipe (m)
 - L_5 : Length of $\varnothing 6.35$ [1/4"] liquid pipe (m)
 - α, α' : Refer to the table below.
- L_1' : Length of $\varnothing 19.05$ [3/4"] liquid pipe [ft]
 - L_2' : Length of $\varnothing 15.88$ [5/8"] liquid pipe [ft]
 - L_3' : Length of $\varnothing 12.7$ [1/2"] liquid pipe [ft]
 - L_4' : Length of $\varnothing 9.52$ [3/8"] liquid pipe [ft]
 - L_5' : Length of $\varnothing 6.35$ [1/4"] liquid pipe [ft]

Total capacity of connected indoor units	α (kg)	α' (oz)
- 80	2.0	71
81 - 160	2.5	89
161 - 330	3.0	106
331 - 390	3.5	124
391 - 480	4.5	159
481 - 630	5.0	177
631 - 710	6.0	212
711 - 800	8.0	283
801 - 890	9.0	318
891 - 1070	10.0	353
1071 - 1250	12.0	424
1251 -	14.0	494

Round up the calculation result to the nearest 0.1kg. (Example: 18.04kg to 18.1kg)
 Round up the calculation result in increments of 4oz (0.1kg) or round it up to the nearest 1oz.
 (Example: 178.21oz to 179oz)

(2) Example: PUHY-P500YSHM-A

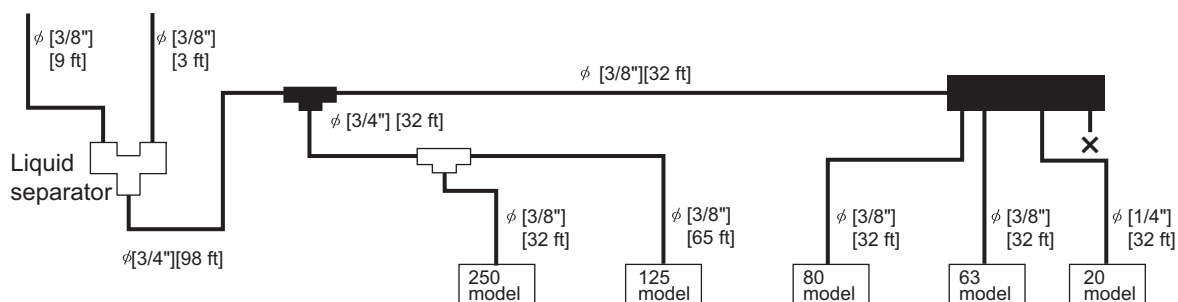
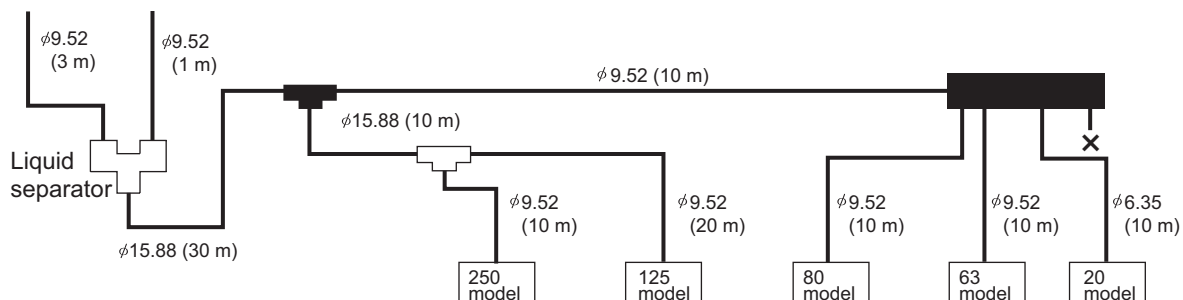

(3) Sample calculation

All the pipes in the figure are liquid pipes.

$$\phi 15.88 : 30 \text{ m} + 10 \text{ m} = 40 \text{ m}$$

$$\phi 9.52 : 3 \text{ m} + 1 \text{ m} + 10 \text{ m} + 10 \text{ m} + 20 \text{ m} + 10 \text{ m} + 10 \text{ m} = 64 \text{ m}$$

$$\phi 6.35 : 10 \text{ m}$$

According to the above formula

$$\text{Amount of refrigerant to be charged (kg)} = (0.2 \times 40) + (0.06 \times 64) + (0.024 \times 10) + 5.0 = 17.08 \text{ kg}$$

The calculation result would be 17.08, and it is rounded up to the nearest 0.1.

The final result will be as follows:

$$\text{Amount of refrigerant to be charged} = 17.1 \text{ kg}$$



All the pipes in the figure are liquid pipes.

$$\phi [3/4"] : [98 \text{ ft}] + [32 \text{ ft}] = [130 \text{ ft}]$$

$$\phi [3/8"] : [9 \text{ ft}] + [3 \text{ ft}] + [32 \text{ ft}] + [32 \text{ ft}] + [65 \text{ ft}] + [32 \text{ ft}] + [32 \text{ ft}] = [205 \text{ ft}]$$

$$\phi [1/4"] : [32 \text{ ft}]$$

According to the above formula

$$\text{Amount of refrigerant to be charged (oz)} = (2.15 \times 130) + (0.65 \times 205) + (0.26 \times 32) + 177 = 598.07 \text{ oz}$$

The calculation result would be 598.07 oz, and it is rounded up to the nearest 1 oz.

The final result will be as follows:

$$\text{Amount of refrigerant to be charged} = 599 \text{ oz}$$



CAUTION

Charge liquid refrigerant (as opposed to gaseous refrigerant) into the system.

- If gaseous refrigerant is charged into the system, the composition of the refrigerant in the cylinder will change and may result in performance loss.

[5] Refrigerant Amount Adjust Mode

1. Procedures

Follow the procedures below to add or extract refrigerant as necessary depending on the operation mode.

When the function switch (SW4-3) on the main board on the outdoor unit (OC only) is turned to ON, the unit goes into the refrigerant amount adjust mode, and the following sequence is followed.

Note

SW4-3 on the OS is invalid, and the unit will not go into the refrigerant amount adjust mode.

Operation

When the unit is in the refrigerant amount adjust mode, the LEV on the indoor unit does not open as fully as it normally does during cooling operation to secure subcooling.

Note

- Adjust the refrigerant amount based on the values of TH4, TH3, TH6, and Tc, following the flowchart below. Check the TH4, TH3, TH6, and Tc values on the OC, OS1, and OS2 by following the flowchart. The TH4, TH3, TH6, and Tc values can be displayed by setting the self-diagnosis switch (SW1) on the main board on the OC, OS1, and OS2.
- There may be cases when the refrigerant amount may seem adequate for a short while after starting the unit in the refrigerant amount adjust mode but turn out to be inadequate later on (when the refrigerant system stabilizes).

When the amount of refrigerant is truly adequate.

TH3-TH6 on the indoor unit is 5°C [9°F] or above and SH on the indoor unit is between 5 and 15°C [9 and 27°F].

The refrigerant amount may seem adequate at the moment, but may turn out to be inadequate later on.

TH3-TH6 on the indoor unit is 5°C [9°F] or less and SH on the indoor unit is 5°C [9°F] or less.

Wait until the TH3-TH6 reaches 5°C [9°F] or above and the SH of the indoor unit is between 5 and 15°C [9 and 27°F] to determine that the refrigerant amount is adequate.

- High pressure must be at least 2.0MPa[290psi] to enable a proper adjustment of refrigerant amount to be made.
- Refrigerant amount adjust mode automatically ends 90 minutes after beginning. When this happens, by turning off the SW4-3 and turning them back on, the unit will go back into the refrigerant amount adjust mode.

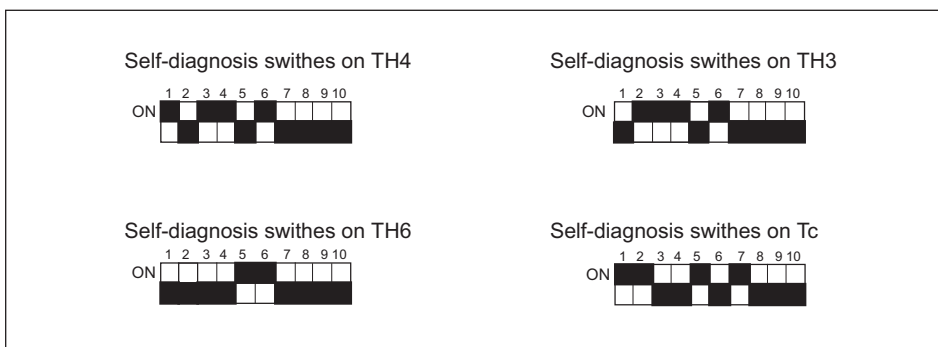

[6] The following symptoms are normal.

Symptoms	Remote controller display	Cause
The indoor unit does not start after starting cooling (heating) operation.	"Cooling (heating)" icon blinks on the display.	The unit cannot perform a heating (cooling) operation when other indoor units are performing a cooling (heating) operation.
The auto vane adjusts its position by itself.	Normal display	After an hour of cooling operation with the auto vane in the vertical position, the vane may automatically move into the horizontal position. Louver blades will automatically move into the horizontal position while the unit is in the defrost mode, pre-heating stand-by mode, or when the thermostat triggers unit off.
The fan stops during heating operation.	Defrost	The fan remains stopped during defrost operation.
The fan keeps running after the unit has stopped.	Unlit	When the auxiliary heater is turned on, the fan operates for one minute after stopping to dissipate heat.
The fan speed does not reach the set speed when operation switch is turned on.	STAND BY	The fan operates at extra low speed for 5 minutes after it is turned on or until the pipe temperature reaches 35°C[95°F], then it operates at low speed for 2 minutes, and finally it operates at the set speed. (Pre-heating stand-by)
When the main power is turned on, the display shown on the right appears on the indoor unit remote controller for 5 minutes.	"HO" or "PLEASE WAIT" icons blink on the display.	The system is starting up. Wait until the blinking display of "HO" or "PLEASE WAIT" go off.
The drain pump keeps running after the unit has stopped.	Unlit	The drain pump stays in operation for three minutes after the unit in the cooling mode is stopped.
The drain pump is running while the unit is stopped.		When drain water is detected, the drain pump goes into operation even while the unit is stopped.
Indoor unit and BC controller make noise during cooling/heating changeover.	Normal display	This noise is made when the refrigerant circuit is reversed and is normal.
Sound of the refrigerant flow is heard from the indoor unit immediately after starting operation.	Normal display	This is caused by the transient instability of the refrigerant flow and is normal.
Warm air sometimes comes out of the indoor units that are not in the heating mode.	Normal display	This is due to the fact that the LEVs on some of the indoor units are kept slightly open to prevent the refrigerant in the indoor units that are not operating in the heating mode from liquefying and accumulating in the compressor. It is part of a normal operation.

[7] Standard Operation Data (Reference Data)

1. Single unit

(1) Cooling operation

Operation				Outdoor unit model	
				PUHY-P200YHM-A	PUHY-P250YHM-A
Operating conditions	Ambient temperature	Indoor	DB/WB	27°C/19°C [81°F/66°F]	
		Outdoor		35°C/ - [95°F/ -]	
	Indoor unit	No. of connected units	Unit	2	
		No. of units in operation		2	
		Model		100/100 125/125	
	Piping	Main pipe	m [ft]	5 [16-3/8]	
		Branch pipe		10 [32-3/4]	
		Total pipe length		25 [82]	
	Fan speed		-	Hi	
	Amount of refrigerant		kg [lbs-oz]	11 [24] 13.5 [30]	
Outdoor unit	Electric current		A	9.1 12.3	
	Voltage		V	400 400	
	Compressor frequency		Hz	52 65	
LEV opening	Indoor unit		Pulse	325/325 387/387	
	SC (LEV1)			80 100	
	LEV2			- -	
Pressure	High pressure (after O/S)/low pressure (before accumulator)		MPa [psi]	2.77/0.74 [402/107] 3.11/0.86 [451/125]	
Temp. of each section	Outdoor unit	Discharge (TH4)	°C [°F]	89 [192] 85 [185]	
		Heat exchanger outlet (TH3)		44 [111] 44 [111]	
		Accumulator inlet		7 [45] 7 [45]	
		Accumulator outlet		7 [45] 7 [45]	
		SCC outlet (TH6)		22 [72] 24 [75]	
		Compressor inlet		19 [66] 19 [66]	
		Compressor shell bottom		47 [117] 38 [100]	
	Indoor unit	LEV inlet		19 [66] 19 [66]	
		Heat exchanger outlet		6 [43] 6 [43]	

Operation				Outdoor unit model	
				PUHY-P300YHM-A	PUHY-P350YHM-A
Operating conditions	Ambient temperature	Indoor	DB/WB	27°C/19°C [81°F/66°F]	27°C/19°C [81°F/66°F]
		Outdoor		35°C/ - [95°F/ -]	35°C/ - [95°F/ -]
	Indoor unit	No. of connected units	Unit	3	3
		No. of units in operation		3	3
		Model		-	100/100/100
	Piping	Main pipe	m [ft]	5 [16-3/8]	5 [16-3/8]
		Branch pipe		10 [32-3/4]	10 [32-3/4]
		Total pipe length		35 [114-13/16]	35 [114-13/16]
	Fan speed		-	Hi	Hi
	Amount of refrigerant		kg [lbs-oz]	15 [33]	17.5 [39]
Outdoor unit	Electric current		A	14.5	17.9
	Voltage		V	400	400
	Compressor frequency		Hz	74	95
LEV opening	Indoor unit		Pulse	325/325/325	325/387/387
	SC (LEV1)			100	100
	LEV2			-	-
Pressure	High pressure (after O/S)/low pressure (before accumulator)		MPa [psi]	2.95/0.84 [428/122]	2.86/0.76 [415/110]
Temp. of each section	Outdoor unit	Discharge (TH4)	°C [°F]	84 [183]	90 [194]
		Heat exchanger outlet (TH3)		44 [111]	43 [109]
		Accumulator inlet		7 [45]	7 [45]
		Accumulator outlet		7 [45]	7 [45]
		SCC outlet (TH6)		22 [72]	22 [72]
		Compressor inlet		19 [66]	19 [66]
		Compressor shell bottom		42 [108]	42 [108]
	Indoor unit	LEV inlet		19 [66]	19 [66]
		Heat exchanger outlet		6 [43]	6 [43]

Operation				Outdoor unit model	
				PUHY-P400YHM-A	PUHY-P450YHM-A
Operating conditions	Ambient temperature	Indoor	DB/WB	27°C/19°C [81°F/66°F]	27°C/19°C [81°F/66°F]
		Outdoor		35°C/ - [95°F/ -]	35°C/ - [95°F/ -]
	Indoor unit	No. of connected units	Unit	4	4
		No. of units in operation		4	4
		Model		-	100/100/100/100
	Piping	Main pipe	m [ft]	5 [16-3/8]	5 [16-3/8]
		Branch pipe		10 [32-3/4]	10 [32-3/4]
		Total pipe length		45 [147-5/8]	45 [147-5/8]
	Fan speed		-	Hi	Hi
	Amount of refrigerant		kg [lbs-oz]	19 [42]	19 [42]
Outdoor unit	Electric current		A	21.2	26.1
	Voltage		V	400	400
	Compressor frequency		Hz	97	111
LEV opening	Indoor unit		Pulse	325/325/325/325	325/325/387/387
	SC (LEV1)			190	190
	LEV2			-	-
Pressure	High pressure (after O/S)/low pressure (before accumulator)		MPa [psi]	3.05/0.84 [442/122]	3.07/0.79 [445/115]
Temp. of each section	Outdoor unit	Discharge (TH4)	°C [°F]	82 [180]	85 [185]
		Heat exchanger outlet (TH3)		45 [113]	48 [118]
		Accumulator inlet		7 [45]	7 [45]
		Accumulator outlet		7 [45]	7 [45]
		SCC outlet (TH6)		25 [77]	28 [82]
		Compressor inlet		19 [66]	19 [66]
		Compressor shell bottom		38 [100]	40 [104]
	Indoor unit	LEV inlet		17 [63]	17 [63]
		Heat exchanger outlet		4 [39]	4 [39]

(2) Heating operation

Operation				Outdoor unit model	
				PUHY-P200YHM-A	PUHY-P250YHM-A
Operating conditions	Ambient temperature	Indoor	DB/WB	20°C/ - [68°F/ -]	20°C/ - [68°F/ -]
		Outdoor		7°C/6°C [45°F/43°F]	7°C/6°C [45°F/43°F]
	Indoor unit	No. of connected units	Unit	2	2
		No. of units in operation		2	2
		Model		-	100/100
	Piping	Main pipe	m [ft]	5 [16-3/8]	5 [16-3/8]
		Branch pipe		10 [32-3/4]	10 [32-3/4]
		Total pipe length		25 [82]	25 [82]
	Fan speed		-	Hi	Hi
	Amount of refrigerant		kg [lbs-oz]	11 [24]	13.5 [30]
Outdoor unit	Electric current		A	9.6	12.5
	Voltage		V	400	400
	Compressor frequency		Hz	53	71
LEV opening	Indoor unit		Pulse	332/332	406/406
	SC (LEV1)			0	0
	LEV2			-	-
Pressure	High pressure (after O/S)/low pressure (before accumulator)		MPa [psi]	2.81/0.66 [408/96]	2.85/0.61 [413/88]
Temp. of each section	Outdoor unit	Discharge (TH4)	°C [°F]	82 [180]	82 [180]
		Heat exchanger outlet (TH3)		-2 [28]	-2 [28]
		Accumulator inlet		-2 [28]	-2 [28]
		Accumulator outlet		-2 [28]	-2 [28]
		Compressor inlet		-2 [28]	-2 [28]
		Compressor shell bottom		40 [104]	40 [104]
	Indoor unit	LEV inlet		37 [99]	38 [100]
		Heat exchanger outlet		80 [176]	80 [176]

Operation				Outdoor unit model	
				PUHY-P300YHM-A	PUHY-P350YHM-A
Operating conditions	Ambient temperature	Indoor	DB/WB	20°C/ - [68°F/ -]	20°C/ - [68°F/ -]
		Outdoor		7°C/6°C [45°F/43°F]	7°C/6°C [45°F/43°F]
	Indoor unit	No. of connected units	Unit	3	3
		No. of units in operation		3	3
		Model		-	100/100/100
	Piping	Main pipe	m [ft]	5 [16-3/8]	5 [16-3/8]
		Branch pipe		10 [32-3/4]	10 [32-3/4]
		Total pipe length		35 [114-13/16]	35 [114-13/16]
	Fan speed		-	Hi	Hi
	Amount of refrigerant		kg [lbs-oz]	15 [33]	17.5 [39]
Outdoor unit	Electric current		A	15.0	19.3
	Voltage		V	400	400
	Compressor frequency		Hz	81	101
LEV opening	Indoor unit		Pulse	332/332/332	332/406/406
	SC (LEV1)			0	0
	LEV2			-	-
Pressure	High pressure (after O/S)/low pressure (before accumulator)		MPa [psi]	2.78/0.61 [403/88]	2.81/0.57 [408/83]
Temp. of each section	Outdoor unit	Discharge (TH4)	°C [°F]	82 [180]	82 [180]
		Heat exchanger outlet (TH3)		-3 [27]	-3 [27]
		Accumulator inlet		-3 [27]	-3 [27]
		Accumulator outlet		-3 [27]	-3 [27]
		Compressor inlet		-3 [27]	-3 [27]
		Compressor shell bottom		40 [104]	40 [104]
	Indoor unit	LEV inlet		39 [102]	39 [102]
		Heat exchanger outlet		80 [176]	80 [176]

Operation				Outdoor unit model	
				PUHY-P400YHM-A	PUHY-P450YHM-A
Operating conditions	Ambient temperature	Indoor	DB/WB	20°C/ - [68°F/ -]	20°C/ - [68°F/ -]
		Outdoor		7°C/6°C [45°F/43°F]	7°C/6°C [45°F/43°F]
	Indoor unit	No. of connected units	Unit	4	4
		No. of units in operation		4	4
		Model		-	100/100/100/100
	Piping	Main pipe	m [ft]	5 [16-3/8]	5 [16-3/8]
		Branch pipe		10 [32-3/4]	10 [32-3/4]
		Total pipe length		45 [147-5/8]	45 [147-5/8]
	Fan speed		-	Hi	Hi
	Amount of refrigerant		kg [lbs-oz]	19 [42]	19 [42]
Outdoor unit	Electric current		A	21.6	24.6
	Voltage		V	400	400
	Compressor frequency		Hz	102	117
LEV opening	Indoor unit		Pulse	332/332/332/332	332/332/406/406
	SC (LEV1)			0	0
	LEV2			-	-
Pressure	High pressure (after O/S)/low pressure (before accumulator)		MPa [psi]	2.74/0.61 [397/88]	2.81/0.61 [408/88]
Temp. of each section	Outdoor unit	Discharge (TH4)	°C [°F]	89 [192]	89 [192]
		Heat exchanger outlet (TH3)		-3 [27]	-3 [27]
		Accumulator inlet		-3 [27]	-3 [27]
		Accumulator outlet		-3 [27]	-3 [27]
		Compressor inlet		-3 [27]	-3 [27]
		Compressor shell bottom		40 [104]	40 [104]
	Indoor unit	LEV inlet		37 [99]	37 [99]
		Heat exchanger outlet		80 [176]	80 [176]

2. 2-unit combination
(1) Cooling operation

Operation				Outdoor unit model	
				PUHY-P500YSHM-A	
				PUHY-P250YHM-A	PUHY-P250YHM-A
Operating conditions	Ambient temperature	Indoor	DB/WB	27°C/19°C [81°F/66°F]	
		Outdoor		35°C/ - [95°F/ -]	
	Indoor unit	No. of connected units	Unit	4	
		No. of units in operation		4	
		Model		125/125/125/125	
	Piping	Main pipe	m [ft]	5 [16-3/8]	
		Branch pipe		10 [32-3/4]	
		Total pipe length		45 [147-5/8]	
	Fan speed		-	Hi	
	Amount of refrigerant		kg [lbs-oz]	27 [60]	
Outdoor unit	Electric current		A		26.4
	Voltage		V		400
	Compressor frequency		Hz		65 65
LEV opening	Indoor unit		Pulse		387/387/387/387
	SC (LEV1)				100 100
	LEV2				1400 1400
Pressure	High pressure (after O/S)/low pressure (before accumulator)		MPa [psi]		3.11/0.86 [451/125] 3.11/0.86 [451/125]
Temp. of each section	Outdoor unit	Discharge (TH4)	°C [°F]	85 [185] 85 [185]	
		Heat exchanger outlet (TH3)		47 [117] 47 [117]	
		Accumulator inlet		7 [45] 7 [45]	
		Accumulator outlet		7 [45] 7 [45]	
		SCC outlet (TH6)		27 [81] 27 [81]	
		Compressor inlet		19 [66] 19 [66]	
		Compressor shell bottom		38 [100] 38 [100]	
	Indoor unit	LEV inlet		19 [66]	
		Heat exchanger outlet		6 [43]	

Operation				Outdoor unit model	
				PUHY-P550YSHM-A	
				PUHY-P250YHM-A	PUHY-P300YHM-A
Operating conditions	Ambient temperature	Indoor	DB/WB	27°C/19°C [81°F/66°F]	
		Outdoor		35°C/ - [95°F/ -]	
	Indoor unit	No. of connected units	Unit	6	
		No. of units in operation		6	
		Model		20/100/100/100/125/125	
	Piping	Main pipe	m [ft]	5 [16-3/8]	
		Branch pipe		10 [32-3/4]	
		Total pipe length		65 [213-1/4]	
	Fan speed		-	Hi	
	Amount of refrigerant		kg [lbs-oz]	27.5 [61]	
Outdoor unit	Electric current		A	29.4	
	Voltage		V	400	
	Compressor frequency		Hz	65	71
LEV opening	Indoor unit		Pulse	222/325/325/325/387/387	
	SC (LEV1)			159	237
	LEV2			1400	1400
Pressure	High pressure (after O/S)/low pressure (before accumulator)		MPa [psi]	3.10/0.78 [450/113]	3.10/0.74 [450/107]
Temp. of each section	Outdoor unit	Discharge (TH4)	°C [°F]	91 [196]	89 [192]
		Heat exchanger outlet (TH3)		47 [117]	47 [117]
		Accumulator inlet		7 [45]	7 [45]
		Accumulator outlet		7 [45]	7 [45]
		SCC outlet (TH6)		27 [81]	27 [81]
		Compressor inlet		19 [66]	19 [66]
		Compressor shell bottom		42 [108]	42 [108]
	Indoor unit	LEV inlet		19 [66]	
		Heat exchanger outlet		6 [43]	

Operation				Outdoor unit model	
				PUHY-P600YSHM-A	
				PUHY-P250YHM-A	PUHY-P350YHM-A
Operating conditions	Ambient temperature	Indoor	DB/WB	27°C/19°C [81°F/66°F]	
		Outdoor		35°C/ - [95°F/ -]	
	Indoor unit	No. of connected units	Unit	6	
		No. of units in operation		6	
		Model		50/100/100/100/125/125	
	Piping	Main pipe	m [ft]	5 [16-3/8]	
		Branch pipe		10 [32-3/4]	
		Total pipe length		65 [213-1/4]	
	Fan speed		-	Hi	
	Amount of refrigerant		kg [lbs-oz]	30 [66]	
Outdoor unit	Electric current		A		30.0
	Voltage		V		400
	Compressor frequency		Hz		65 92
LEV opening	Indoor unit		Pulse		362/325/325/325/387/387
	SC (LEV1)				159 237
	LEV2				1400 1400
Pressure	High pressure (after O/S)/low pressure (before accumulator)		MPa [psi]		3.10/0.74 [450/107] 3.10/0.78 [450/113]
Temp. of each section	Outdoor unit	Discharge (TH4)	°C [°F]	91 [196] 91 [196]	
		Heat exchanger outlet (TH3)		47 [117] 47 [117]	
		Accumulator inlet		7 [45] 7 [45]	
		Accumulator outlet		7 [45] 7 [45]	
		SCC outlet (TH6)		27 [81] 27 [81]	
		Compressor inlet		19 [66] 19 [66]	
		Compressor shell bottom		42 [108] 42 [108]	
	Indoor unit	LEV inlet		19 [66]	
		Heat exchanger outlet		6 [43]	

Operation				Outdoor unit model	
				PUHY-P650YSHM-A	
				PUHY-P300YHM-A	PUHY-P350YHM-A
Operating conditions	Ambient temperature	Indoor	DB/WB	27°C/19°C [81°F/66°F]	
		Outdoor		35°C/ - [95°F/ -]	
	Indoor unit	No. of connected units	Unit	6	
		No. of units in operation		6	
		Model		100/100/100/100/125/125	
	Piping	Main pipe	m [ft]	5 [16-3/8]	
		Branch pipe		10 [32-3/4]	
		Total pipe length		65 [213-1/4]	
	Fan speed		-	Hi	
	Amount of refrigerant		kg [lbs-oz]	31.5 [69]	
Outdoor unit	Electric current		A	33.3	
	Voltage		V	400	
	Compressor frequency		Hz	84	85
LEV opening	Indoor unit		Pulse	325/325/325/325/387/387	
	SC (LEV1)			105	105
	LEV2			1400	1400
Pressure	High pressure (after O/S)/low pressure (before accumulator)		MPa [psi]	2.86/0.69 [415/100]	2.86/0.69 [415/100]
Temp. of each section	Outdoor unit	Discharge (TH4)	°C [°F]	90 [194]	90 [194]
		Heat exchanger outlet (TH3)		43 [109]	43 [109]
		Accumulator inlet		7 [45]	7 [45]
		Accumulator outlet		7 [45]	7 [45]
		SCC outlet (TH6)		24 [75]	24 [75]
		Compressor inlet		19 [66]	19 [66]
		Compressor shell bottom		48 [118]	48 [118]
	Indoor unit	LEV inlet		19 [66]	
		Heat exchanger outlet		6 [43]	

Operation				Outdoor unit model	
				PUHY-P700YSHM-A	
				PUHY-P350YHM-A	PUHY-P350YHM-A
Operating conditions	Ambient temperature	Indoor	DB/WB	27°C/19°C [81°F/66°F]	
		Outdoor		35°C/ - [95°F/ -]	
	Indoor unit	No. of connected units	Unit	6	
		No. of units in operation		6	
		Model		100/100/125/125/125/125	
	Piping	Main pipe	m [ft]	5 [16-3/8]	
		Branch pipe		10 [32-3/4]	
		Total pipe length		65 [213-1/4]	
	Fan speed		-	Hi	
	Amount of refrigerant		kg [lbs-oz]	36 [79]	
Outdoor unit	Electric current		A	36.0	
	Voltage		V	400	
	Compressor frequency		Hz	95	95
LEV opening	Indoor unit		Pulse	325/325/387/387/387/387	
	SC (LEV1)			105	105
	LEV2			1400	1400
Pressure	High pressure (after O/S)/low pressure (before accumulator)		MPa [psi]	2.86/0.69 [415/100]	2.86/0.69 [415/100]
Temp. of each section	Outdoor unit	Discharge (TH4)	°C [°F]	90 [194]	90 [194]
		Heat exchanger outlet (TH3)		43 [109]	43 [109]
		Accumulator inlet		7 [45]	7 [45]
		Accumulator outlet		7 [45]	7 [45]
		SCC outlet (TH6)		24 [75]	24 [75]
		Compressor inlet		19 [66]	19 [66]
		Compressor shell bottom		48 [118]	48 [118]
	Indoor unit	LEV inlet		19 [66]	
		Heat exchanger outlet		6 [43]	

Operation				Outdoor unit model	
				PUHY-P750YSHM-A	
				PUHY-P350YHM-A	PUHY-P400YHM-A
Operating conditions	Ambient temperature	Indoor	DB/WB	27°C/19°C [81°F/66°F]	
		Outdoor		35°C/ - [95°F/ -]	
	Indoor unit	No. of connected units	Unit	6	
		No. of units in operation		6	
		Model		125/125/125/125/125/125	
	Piping	Main pipe	m [ft]	5 [16-3/8]	
		Branch pipe		10 [32-3/4]	
		Total pipe length		65 [213-1/4]	
	Fan speed		-	Hi	
	Amount of refrigerant		kg [lbs-oz]	36.5 [80]	
Outdoor unit	Electric current		A	40.2	
	Voltage		V	400	
	Compressor frequency		Hz	96	96
LEV opening	Indoor unit		Pulse	387/387/387/387/387/387	
	SC (LEV1)			141	185
	LEV2			1400	1400
Pressure	High pressure (after O/S)/low pressure (before accumulator)		MPa [psi]	2.95/0.81 [428/117]	2.86/0.76 [415/110]
Temp. of each section	Outdoor unit	Discharge (TH4)	°C [°F]	96 [204]	95 [202]
		Heat exchanger outlet (TH3)		47 [117]	46 [114]
		Accumulator inlet		7 [45]	7 [45]
		Accumulator outlet		7 [45]	7 [45]
		SCC outlet (TH6)		25 [77]	24 [75]
		Compressor inlet		19 [66]	19 [66]
		Compressor shell bottom		56 [132]	47 [117]
	Indoor unit	LEV inlet		17 [63]	
		Heat exchanger outlet		4 [39]	

Operation				Outdoor unit model	
				PUHY-P800YSHM-A	
				PUHY-P350YHM-A	PUHY-P450YHM-A
Operating conditions	Ambient temperature	Indoor	DB/WB	27°C/19°C [81°F/66°F]	
		Outdoor		35°C/ - [95°F/ -]	
	Indoor unit	No. of connected units	Unit	6	
		No. of units in operation		6	
		Model		125/125/125/140/140/140	
	Piping	Main pipe	m [ft]	5 [16-3/8]	
		Branch pipe		10 [32-3/4]	
		Total pipe length		65 [213-1/4]	
	Fan speed		-	Hi	
	Amount of refrigerant		kg [lbs-oz]	36.5 [80]	
Outdoor unit	Electric current		A	44.4	
	Voltage		V	400	
	Compressor frequency		Hz	103	103
LEV opening	Indoor unit		Pulse	387/387/387/310/310/310	
	SC (LEV1)			141	185
	LEV2			1400	1400
Pressure	High pressure (after O/S)/low pressure (before accumulator)		MPa [psi]	2.95/0.81 [428/117]	2.86/0.76 [415/110]
Temp. of each section	Outdoor unit	Discharge (TH4)	°C [°F]	96 [204]	95 [202]
		Heat exchanger outlet (TH3)		47 [117]	46 [114]
		Accumulator inlet		7 [45]	7 [45]
		Accumulator outlet		7 [45]	7 [45]
		SCC outlet (TH6)		25 [77]	24 [75]
		Compressor inlet		19 [66]	19 [66]
		Compressor shell bottom		56 [132]	47 [117]
	Indoor unit	LEV inlet		17 [63]	
		Heat exchanger outlet		4 [39]	

Operation				Outdoor unit model	
				PUHY-P850YSHM-A	
				PUHY-P400YHM-A	PUHY-P450YHM-A
Operating conditions	Ambient temperature	Indoor	DB/WB	27°C/19°C [81°F/66°F]	
		Outdoor		35°C/ - [95°F/ -]	
	Indoor unit	No. of connected units	Unit	6	
		No. of units in operation		6	
		Model		140/140/140/140/140/140	
	Piping	Main pipe	m [ft]	5 [16-3/8]	
		Branch pipe		10 [32-3/4]	
		Total pipe length		65 [213-1/4]	
	Fan speed		-	Hi	
	Amount of refrigerant		kg [lbs-oz]	37 [82]	
Outdoor unit	Electric current		A	48.4	
	Voltage		V	400	
	Compressor frequency		Hz	104	104
LEV opening	Indoor unit		Pulse	395/395/395/395/395/395	
	SC (LEV1)			171	171
	LEV2			1400	1400
Pressure	High pressure (after O/S)/low pressure (before accumulator)		MPa [psi]	3.12/0.83 [453/120]	3.12/0.83 [453/120]
Temp. of each section	Outdoor unit	Discharge (TH4)	°C [°F]	98 [208]	98 [208]
		Heat exchanger outlet (TH3)		47 [117]	47 [117]
		Accumulator inlet		7 [45]	7 [45]
		Accumulator outlet		7 [45]	7 [45]
		SCC outlet (TH6)		26 [79]	26 [79]
		Compressor inlet		20 [68]	20 [68]
		Compressor shell bottom		47 [117]	47 [117]
	Indoor unit	LEV inlet		17 [63]	
		Heat exchanger outlet		4 [39]	

Operation				Outdoor unit model	
				PUHY-P900YSHM-A	
				PUHY-P450YHM-A	PUHY-P450YHM-A
Operating conditions	Ambient temperature	Indoor	DB/WB	27°C/19°C [81°F/66°F]	
		Outdoor		35°C/ - [95°F/ -]	
	Indoor unit	No. of connected units	Unit	7	
		No. of units in operation		7	
		Model		100/100/100/125/125/125/125	
	Piping	Main pipe	m [ft]	5 [16-3/8]	
		Branch pipe		10 [32-3/4]	
		Total pipe length		75 [246-1/16]	
	Fan speed		-	Hi	
	Amount of refrigerant		kg [lbs-oz]	39 [86]	
Outdoor unit	Electric current		A	53.4	
	Voltage		V	400	
	Compressor frequency		Hz	111	111
LEV opening	Indoor unit		Pulse	325/325/325/387/387/387/387	
	SC (LEV1)			171	171
	LEV2			1400	1400
Pressure	High pressure (after O/S)/low pressure (before accumulator)		MPa [psi]	3.12/0.83 [453/120]	3.12/0.83 [453/120]
Temp. of each section	Outdoor unit	Discharge (TH4)	°C [°F]	98 [208]	98 [208]
		Heat exchanger outlet (TH3)		47 [117]	47 [117]
		Accumulator inlet		7 [45]	7 [45]
		Accumulator outlet		7 [45]	7 [45]
		SCC outlet (TH6)		26 [79]	26 [79]
		Compressor inlet		20 [68]	20 [68]
		Compressor shell bottom		47 [117]	47 [117]
	Indoor unit	LEV inlet		17 [63]	
		Heat exchanger outlet		4 [39]	

(2) Heating operation

Operation				Outdoor unit model	
				PUHY-P500YSHM-A	
				PUHY-P250YHM-A	PUHY-P250YHM-A
Operating conditions	Ambient temperature	Indoor	DB/WB	20°C/ - [68°F/ -]	
		Outdoor		7°C/ 6°C [45°F/43°F]	
	Indoor unit	No. of connected units	Unit	4	
		No. of units in operation		4	
		Model		125/125/125/125	
	Piping	Main pipe	m [ft]	5 [16-3/8]	
		Branch pipe		10 [32-3/4]	
		Total pipe length		45 [147-5/8]	
	Fan speed		-	Hi	
	Amount of refrigerant		kg [lbs-oz]	27 [60]	
Outdoor unit	Electric current		A	26.3	
	Voltage		V	400	
	Compressor frequency		Hz	71	71
LEV opening	Indoor unit		Pulse	406/406/406/406	
	SC (LEV1)			0	
	LEV2			1400	1400
Pressure	High pressure (after O/S)/low pressure (before accumulator)		MPa [psi]	2.81/0.66 [408/99]	2.81/0.66 [408/99]
Temp. of each section	Outdoor unit	Discharge (TH4)	°C [°F]	82 [180]	82 [180]
		Heat exchanger outlet (TH3)		-2 [28]	-2 [28]
		Accumulator inlet		-2 [28]	-2 [28]
		Accumulator outlet		-2 [28]	-2 [28]
		Compressor inlet		-2 [28]	-2 [28]
		Compressor shell bottom		40 [104]	40 [104]
	Indoor unit	LEV inlet		37 [99]	
		Heat exchanger outlet		80 [176]	

Operation				Outdoor unit model	
				PUHY-P550YSHM-A	
				PUHY-P250YHM-A	PUHY-P300YHM-A
Operating conditions	Ambient temperature	Indoor	DB/WB	20°C/ - [68°F/ -]	
		Outdoor		7°C/ 6°C [45°F/43°F]	
	Indoor unit	No. of connected units	Unit	6	
		No. of units in operation		6	
		Model		20/100/100/100/125/125	
	Piping	Main pipe	m [ft]	5 [16-3/8]	
		Branch pipe		10 [32-3/4]	
		Total pipe length		65 [213-1/4]	
	Fan speed		-	Hi	
	Amount of refrigerant		kg [lbs-oz]	27.5 [61]	
Outdoor unit	Electric current		A	28.9	
	Voltage		V	400	
	Compressor frequency		Hz	71	79
LEV opening	Indoor unit		Pulse	229/332/332/332/406/406	
	SC (LEV1)			0	
	LEV2			1400	1400
Pressure	High pressure (after O/S)/low pressure (before accumulator)		MPa [psi]	2.61/0.61 [379/88]	2.68/0.57 [389/83]
Temp. of each section	Outdoor unit	Discharge (TH4)	°C [°F]	82 [180]	83 [181]
		Heat exchanger outlet (TH3)		-2 [28]	-2 [28]
		Accumulator inlet		-2 [28]	-2 [28]
		Accumulator outlet		-2 [28]	-2 [28]
		Compressor inlet		-2 [28]	-2 [28]
		Compressor shell bottom		30 [86]	34 [93]
	Indoor unit	LEV inlet		35 [95]	
		Heat exchanger outlet		80 [176]	

Operation				Outdoor unit model	
				PUHY-P600YSHM-A	
				PUHY-P250YHM-A	PUHY-P350YHM-A
Operating conditions	Ambient temperature	Indoor	DB/WB	20°C/ - [68°F/ -]	
		Outdoor		7°C/6°C [45°F/43°F]	
	Indoor unit	No. of connected units	Unit	6	
		No. of units in operation		6	
		Model		50/100/100/100/125/125	
	Piping	Main pipe	m [ft]	5 [16-3/8]	
		Branch pipe		10 [32-3/4]	
		Total pipe length		65 [213-1/4]	
	Fan speed		-	Hi	
	Amount of refrigerant		kg [lbs-oz]	30 [66]	
Outdoor unit	Electric current		A	31.9	
	Voltage		V	400	
	Compressor frequency		Hz	71	99
LEV opening	Indoor unit		Pulse	373/332/332/332/406/406	
	SC (LEV1)			0	
	LEV2			1400	1400
Pressure	High pressure (after O/S)/low pressure (before accumulator)		MPa [psi]	2.61/0.61 [379/88]	2.76/0.57 [400/83]
Temp. of each section	Outdoor unit	Discharge (TH4)	°C [°F]	82 [180]	86 [187]
		Heat exchanger outlet (TH3)		-2 [28]	-2 [28]
		Accumulator inlet		-2 [28]	-2 [28]
		Accumulator outlet		-2 [28]	-2 [28]
		Compressor inlet		-2 [28]	-2 [28]
		Compressor shell bottom		30 [86]	34 [93]
	Indoor unit	LEV inlet		35 [95]	
		Heat exchanger outlet		80 [176]	

Operation				Outdoor unit model	
				PUHY-P650YSHM-A	
				PUHY-P300YHM-A	PUHY-P350YHM-A
Operating conditions	Ambient temperature	Indoor	DB/WB	20°C/ - [68°F/ -]	
		Outdoor		7°C/6°C [45°F/43°F]	
	Indoor unit	No. of connected units	Unit	6	
		No. of units in operation		6	
		Model		100/100/100/100/125/125	
	Piping	Main pipe	m [ft]	5 [16-3/8]	
		Branch pipe		10 [32-3/4]	
		Total pipe length		65 [213-1/4]	
	Fan speed		-	Hi	
	Amount of refrigerant		kg [lbs-oz]	31.5 [69]	
Outdoor unit	Electric current		A	35.1	
	Voltage		V	400	
	Compressor frequency		Hz	91	91
LEV opening	Indoor unit		Pulse	350/350/340/340/330/330	
	SC (LEV1)			0	
	LEV2			1400	1400
Pressure	High pressure (after O/S)/low pressure (before accumulator)		MPa [psi]	2.59/0.57 [376/83]	2.59/0.57 [376/83]
Temp. of each section	Outdoor unit	Discharge (TH4)	°C [°F]	82 [180]	82 [180]
		Heat exchanger outlet (TH3)		-2 [28]	-2 [28]
		Accumulator inlet		-2 [28]	-2 [28]
		Accumulator outlet		-2 [28]	-2 [28]
		Compressor inlet		-2 [28]	-2 [28]
		Compressor shell bottom		22 [72]	22 [72]
	Indoor unit	LEV inlet		35 [95]	
		Heat exchanger outlet		80 [176]	

Operation				Outdoor unit model	
				PUHY-P700YSHM-A	
				PUHY-P350YHM-A	PUHY-P350YHM-A
Operating conditions	Ambient temperature	Indoor	DB/WB	20°C/ - [68°F/ -]	
		Outdoor		7°C/6°C [45°F/43°F]	
	Indoor unit	No. of connected units	Unit	6	
		No. of units in operation		6	
		Model		100/100/125/125/125/125	
	Piping	Main pipe	m [ft]	5 [16-3/8]	
		Branch pipe		10 [32-3/4]	
		Total pipe length		65 [213-1/4]	
	Fan speed		-	Hi	
	Amount of refrigerant		kg [lbs-oz]	36 [79]	
Outdoor unit	Electric current		A	38.0	
	Voltage		V	400	
	Compressor frequency		Hz	101	101
LEV opening	Indoor unit		Pulse	332/332/406/406/406/406	
	SC (LEV1)			0	
	LEV2			1400	1400
Pressure	High pressure (after O/S)/low pressure (before accumulator)		MPa [psi]	2.59/0.57 [376/83]	2.59/0.57 [376/83]
Temp. of each section	Outdoor unit	Discharge (TH4)	°C [°F]	82 [180]	82 [180]
		Heat exchanger outlet (TH3)		-2 [28]	-2 [28]
		Accumulator inlet		-2 [28]	-2 [28]
		Accumulator outlet		-2 [28]	-2 [28]
		Compressor inlet		-2 [28]	-2 [28]
		Compressor shell bottom		22 [72]	22 [72]
	Indoor unit	LEV inlet		35 [95]	
		Heat exchanger outlet		80 [176]	

Operation				Outdoor unit model	
				PUHY-P750YSHM-A	
				PUHY-P350YHM-A	PUHY-P400YHM-A
Operating conditions	Ambient temperature	Indoor	DB/WB	20°C/ - [68°F/ -]	
		Outdoor		7°C/6°C [45°F/43°F]	
	Indoor unit	No. of connected units	Unit	6	
		No. of units in operation		6	
		Model		125/125/125/125/125/125	
	Piping	Main pipe	m [ft]	5 [16-3/8]	
		Branch pipe		10 [32-3/4]	
		Total pipe length		65 [213-1/4]	
	Fan speed		-	Hi	
	Amount of refrigerant		kg [lbs-oz]	36.5 [80]	
Outdoor unit	Electric current		A		40.8
	Voltage		V		400
	Compressor frequency		Hz		101 102
LEV opening	Indoor unit		Pulse	332/332/406/406/406/406	
	SC (LEV1)			0	
	LEV2			1160 1280	
Pressure	High pressure (after O/S)/low pressure (before accumulator)		MPa [psi]	2.90/0.62 [421/90] 2.91/0.60 [422/87]	
Temp. of each section	Outdoor unit	Discharge (TH4)	°C [°F]	82 [180] 89 [192]	
		Heat exchanger outlet (TH3)		-3 [26] -4 [25]	
		Accumulator inlet		-3 [26] -4 [25]	
		Accumulator outlet		-3 [26] -4 [25]	
		Compressor inlet		-3 [26] -4 [25]	
		Compressor shell bottom		30 [85] 40 [104]	
	Indoor unit	LEV inlet		39 [102]	
		Heat exchanger outlet		80 [176]	

Operation				Outdoor unit model	
				PUHY-P800YSHM-A	
				PUHY-P350YHM-A	PUHY-P450YHM-A
Operating conditions	Ambient temperature	Indoor	DB/WB	20°C/ - [68°F/ -]	
		Outdoor		7°C/6°C [45°F/43°F]	
	Indoor unit	No. of connected units	Unit	6	
		No. of units in operation		6	
		Model		125/125/125/140/140/140	
	Piping	Main pipe	m [ft]	5 [16-3/8]	
		Branch pipe		10 [32-3/4]	
		Total pipe length		65 [213-1/4]	
	Fan speed		-	Hi	
	Amount of refrigerant		kg [lbs-oz]	36.5 [80]	
Outdoor unit	Electric current		A		41.2
	Voltage		V		400
	Compressor frequency		Hz		109 109
LEV opening	Indoor unit		Pulse	406/406/406/414/414/414	
	SC (LEV1)			0	
	LEV2			1160 1280	
Pressure	High pressure (after O/S)/low pressure (before accumulator)		MPa [psi]	2.90/0.62 [421/90]	2.91/0.60 [422/87]
Temp. of each section	Outdoor unit	Discharge (TH4)	°C [°F]	82 [180] 89 [192]	
		Heat exchanger outlet (TH3)		-3 [26] -4 [25]	
		Accumulator inlet		-3 [26] -4 [25]	
		Accumulator outlet		-3 [26] -4 [25]	
		Compressor inlet		-3 [26] -4 [25]	
		Compressor shell bottom		30 [85] 40 [104]	
	Indoor unit	LEV inlet		39 [102]	
		Heat exchanger outlet		80 [176]	

Operation				Outdoor unit model	
				PUHY-P850YSHM-A	
				PUHY-P400YHM-A	PUHY-P450YHM-A
Operating conditions	Ambient temperature	Indoor	DB/WB	20°C/ - [68°F/ -]	
		Outdoor		7°C/6°C [45°F/43°F]	
	Indoor unit	No. of connected units	Unit	6	
		No. of units in operation		6	
		Model		140/140/140/140/140/140	
	Piping	Main pipe	m [ft]	5 [16-3/8]	
		Branch pipe		10 [32-3/4]	
		Total pipe length		65 [213-1/4]	
	Fan speed		-	Hi	
	Amount of refrigerant		kg [lbs-oz]	37 [82]	
Outdoor unit	Electric current		A	45.5	
	Voltage		V	400	
	Compressor frequency		Hz	109	110
LEV opening	Indoor unit		Pulse	414/414/414/414/414/414	
	SC (LEV1)			0	
	LEV2			1280	1280
Pressure	High pressure (after O/S)/low pressure (before accumulator)		MPa [psi]	2.91/0.60 [422/87]	2.91/0.60 [422/87]
Temp. of each section	Outdoor unit	Discharge (TH4)	°C [°F]	89 [192]	89 [192]
		Heat exchanger outlet (TH3)		-4 [25]	-4 [25]
		Accumulator inlet		-4 [25]	-4 [25]
		Accumulator outlet		-4 [25]	-4 [25]
		Compressor inlet		-4 [25]	-4 [25]
		Compressor shell bottom		40 [104]	40 [104]
	Indoor unit	LEV inlet		39 [102]	
		Heat exchanger outlet		80 [176]	

Operation				Outdoor unit model	
				PUHY-P900YSHM-A	
				PUHY-P450YHM-A	PUHY-P450YHM-A
Operating conditions	Ambient temperature	Indoor	DB/WB	20°C/ - [68°F/ -]	
		Outdoor		7°C/6°C [45°F/43°F]	
	Indoor unit	No. of connected units	Unit	7	
		No. of units in operation		7	
		Model		100/100/100/125/125/125/125	
	Piping	Main pipe	m [ft]	5 [16-3/8]	
		Branch pipe		10 [32-3/4]	
		Total pipe length		75 [246-1/16]	
	Fan speed		-	Hi	
	Amount of refrigerant		kg [lbs-oz]	39 [86]	
Outdoor unit	Electric current		A	48.5	
	Voltage		V	400	
	Compressor frequency		Hz	117	117
LEV opening	Indoor unit		Pulse	332/332/332/406/406/406/406	
	SC (LEV1)			0	
	LEV2			1280	1280
Pressure	High pressure (after O/S)/low pressure (before accumulator)		MPa [psi]	2.91/0.60 [422/87]	2.91/0.60 [422/87]
Temp. of each section	Outdoor unit	Discharge (TH4)	°C [°F]	89 [192]	89 [192]
		Heat exchanger outlet (TH3)		-4 [25]	-4 [25]
		Accumulator inlet		-4 [25]	-4 [25]
		Accumulator outlet		-4 [25]	-4 [25]
		Compressor inlet		-4 [25]	-4 [25]
		Compressor shell bottom		40 [104]	40 [104]
	Indoor unit	LEV inlet		39 [102]	
		Heat exchanger outlet		80 [176]	

3. 3-unit combination
(1) Cooling operation

Operation				Outdoor unit model		
				PUHY-P950YSHM-A		
				PUHY-P250YHM-A	PUHY-P300YHM-A	PUHY-P400YHM-A
Operating conditions	Ambient temperature	Indoor	DB/WB	27°C/19°C [81°F/66°F]		
		Outdoor		35°C/ - [95°F/ -]		
	Indoor unit	No. of connected units	Unit	8		
		No. of units in operation		8		
		Model		-	250/200/200/125/100/32/32/25	
	Piping	Main pipe	m [ft]	5 [16-3/8]		
		Branch pipe		10 [32-3/4]		
		Total pipe length		85 [278-13/16]		
	Fan speed		-	Hi		
	Amount of refrigerant		kg [lbs-oz]	44.5 [98]		
Outdoor unit	Electric current		A	49.2		
	Voltage		V	400		
	Compressor frequency		Hz	65	84	84
LEV opening	Indoor unit		Pulse	388/324/324/387/325/261/261/222		
	SC (LEV1)			130	141	116
	LEV2			1400	1400	1400
Pressure	High pressure (after O/S)/low pressure (before accumulator)		MPa [psi]	3.06/0.79 [444/115]	2.95/0.81 [428/117]	2.86/0.76 [415/110]
Temp. of each section	Outdoor unit	Discharge (TH4)	°C [°F]	89 [193]	96 [204]	95 [202]
		Heat exchanger outlet (TH3)		49 [119]	47 [117]	46 [114]
		Accumulator inlet		7 [45]	7 [45]	7 [45]
		Accumulator outlet		7 [45]	7 [45]	7 [45]
		SCC outlet (TH6)		27 [80]	25 [77]	24 [75]
		Compressor inlet		19 [66]	19 [66]	19 [66]
		Compressor shell bottom		47 [117]	56 [132]	47 [117]
	Indoor unit	LEV inlet		19 [66]		
		Heat exchanger outlet		6 [43]		

Operation				Outdoor unit model			
				PUHY-P1000YSHM-A			
				PUHY-P300YHM-A	PUHY-P300YHM-A	PUHY-P400YHM-A	
Operating conditions	Ambient temperature	Indoor	DB/WB	27°C/19°C [81°F/66°F]			
		Outdoor		35°C/ - [95°F/ -]			
	Indoor unit	No. of connected units	Unit	8			
		No. of units in operation		8			
		Model		-	250/250/200/125/63/63/32/25		
	Piping	Main pipe	m [ft]	5 [16-3/8]			
		Branch pipe		10 [32-3/4]			
		Total pipe length		85 [278-13/16]			
	Fan speed		-	Hi			
	Amount of refrigerant		kg [lbs-oz]	45 [99]			
Outdoor unit	Electric current		A	52.0			
	Voltage		V	400			
	Compressor frequency		Hz	81	82	82	
LEV opening	Indoor unit		Pulse	388/388/324/387/441/441/261/222			
	SC (LEV1)			130	141	138	
	LEV2			1400	1400	1400	
Pressure	High pressure (after O/S)/low pressure (before accumulator)		MPa [psi]	2.95/0.81 [428/117]	2.95/0.81 [428/117]	2.86/0.76 [415/110]	
Temp. of each section	Outdoor unit	Discharge (TH4)	°C [°F]	96 [204]	96 [204]	95 [202]	
		Heat exchanger outlet (TH3)		47 [117]	47 [117]	46 [114]	
		Accumulator inlet		7 [45]	7 [45]	7 [45]	
		Accumulator outlet		7 [45]	7 [45]	7 [45]	
		SCC outlet (TH6)		25 [77]	25 [77]	24 [75]	
		Compressor inlet		19 [66]	19 [66]	19 [66]	
		Compressor shell bottom		56 [132]	56 [132]	47 [117]	
	Indoor unit	LEV inlet		19 [66]			
		Heat exchanger outlet		6 [43]			

Operation				Outdoor unit model			
				PUHY-P1050YSHM-A			
				PUHY-P300YHM-A	PUHY-P350YHM-A	PUHY-P400YHM-A	
Operating conditions	Ambient temperature	Indoor	DB/WB	27°C/19°C [81°F/66°F]			
		Outdoor		35°C/ - [95°F/ -]			
	Indoor unit	No. of connected units	Unit	8			
		No. of units in operation		8			
		Model		250/250/200/125/100/71/32/25			
	Piping	Main pipe	m [ft]	5 [16-3/8]			
		Branch pipe		10 [32-3/4]			
		Total pipe length		85 [278-13/16]			
	Fan speed		-	Hi			
	Amount of refrigerant		kg [lbs-oz]	47.5 [105]			
Outdoor unit	Electric current		A	54.3			
	Voltage		V	400			
	Compressor frequency		Hz	88	89	89	
LEV opening	Indoor unit		Pulse	388/388/324/387/325/253/261/222			
	SC (LEV1)			141	141	185	
	LEV2			1400	1400	1400	
Pressure	High pressure (after O/S)/low pressure (before accumulator)		MPa [psi]	2.95/0.81 [428/117]	2.95/0.81 [428/117]	2.86/0.76 [415/110]	
Temp. of each section	Outdoor unit	Discharge (TH4)	°C [°F]	96 [204]	96 [204]	95 [202]	
		Heat exchanger outlet (TH3)		47 [117]	47 [117]	46 [114]	
		Accumulator inlet		7 [45]	7 [45]	7 [45]	
		Accumulator outlet		7 [45]	7 [45]	7 [45]	
		SCC outlet (TH6)		25 [77]	25 [77]	24 [75]	
		Compressor inlet		19 [66]	19 [66]	19 [66]	
		Compressor shell bottom		56 [132]	56 [132]	47 [117]	
	Indoor unit	LEV inlet		19 [66]			
		Heat exchanger outlet		6 [43]			

Operation				Outdoor unit model		
				PUHY-P1100YSHM-A		
				PUHY-P350YHM-A	PUHY-P350YHM-A	PUHY-P400YHM-A
Operating conditions	Ambient temperature	Indoor	DB/WB	27°C/19°C [81°F/66°F]		
		Outdoor		35°C/ - [95°F/ -]		
	Indoor unit	No. of connected units	Unit	8		
		No. of units in operation		8		
		Model		-	250/250/200/200/100/50/32/25	
	Piping	Main pipe	m [ft]	5 [16-3/8]		
		Branch pipe		10 [32-3/4]		
		Total pipe length		85 [278-13/16]		
	Fan speed		-	Hi		
	Amount of refrigerant		kg [lbs-oz]	52 [115]		
Outdoor unit	Electric current		A	57.4		
	Voltage		V	400		
	Compressor frequency		Hz	95	96	96
LEV opening	Indoor unit		Pulse	388/388/324/324/325/362/261/222		
	SC (LEV1)			141	141	185
	LEV2			1400	1400	1400
Pressure	High pressure (after O/S)/low pressure (before accumulator)		MPa [psi]	2.95/0.81 [428/117]	2.95/0.81 [428/117]	2.86/0.76 [415/110]
Temp. of each section	Outdoor unit	Discharge (TH4)	°C [°F]	96 [204]	96 [204]	95 [202]
		Heat exchanger outlet (TH3)		47 [117]	47 [117]	46 [114]
		Accumulator inlet		7 [45]	7 [45]	7 [45]
		Accumulator outlet		7 [45]	7 [45]	7 [45]
		SCC outlet (TH6)		25 [77]	25 [77]	24 [75]
		Compressor inlet		19 [66]	19 [66]	19 [66]
		Compressor shell bottom		56 [132]	56 [132]	47 [117]
	Indoor unit	LEV inlet		19 [66]		
		Heat exchanger outlet		6 [43]		

Operation				Outdoor unit model			
				PUHY-P1150YSHM-A			
				PUHY-P350YHM-A	PUHY-P350YHM-A	PUHY-P450YHM-A	
Operating conditions	Ambient temperature	Indoor	DB/WB	27°C/19°C [81°F/66°F]			
		Outdoor		35°C/ - [95°F/ -]			
	Indoor unit	No. of connected units	Unit	8			
		No. of units in operation		8			
		Model		-	250/250/200/200/100/50/32/25		
	Piping	Main pipe	m [ft]	5 [16-3/8]			
		Branch pipe		10 [32-3/4]			
		Total pipe length		85 [278-13/16]			
	Fan speed		-	Hi			
	Amount of refrigerant		kg [lbs-oz]	52 [115]			
Outdoor unit	Electric current		A	63.1			
	Voltage		V	400			
	Compressor frequency		Hz	100	100	101	
LEV opening	Indoor unit		Pulse	388/388/324/324/325/362/261/222			
	SC (LEV1)			141	141	185	
	LEV2			1400	1400	1400	
Pressure	High pressure (after O/S)/low pressure (before accumulator)		MPa [psi]	2.95/0.81 [428/117]	2.95/0.81 [428/117]	2.86/0.76 [415/110]	
Temp. of each section	Outdoor unit	Discharge (TH4)	°C [°F]	96 [204]	96 [204]	95 [202]	
		Heat exchanger outlet (TH3)		47 [117]	47 [117]	46 [114]	
		Accumulator inlet		7 [45]	7 [45]	7 [45]	
		Accumulator outlet		7 [45]	7 [45]	7 [45]	
		SCC outlet (TH6)		25 [77]	25 [77]	24 [75]	
		Compressor inlet		19 [66]	19 [66]	19 [66]	
		Compressor shell bottom		56 [132]	56 [132]	47 [117]	
	Indoor unit	LEV inlet		19 [66]			
		Heat exchanger outlet		6 [43]			

Operation				Outdoor unit model		
				PUHY-P1200YSHM-A		
				PUHY-P350YHM-A	PUHY-P400YHM-A	PUHY-P450YHM-A
Operating conditions	Ambient temperature	Indoor	DB/WB	27°C/19°C [81°F/66°F]		
		Outdoor		35°C/ - [95°F/ -]		
	Indoor unit	No. of connected units	Unit	8		
		No. of units in operation		8		
		Model		250/250/250/250/100/50/32/32		
	Piping	Main pipe	m [ft]	5 [16-3/8]		
		Branch pipe		10 [32-3/4]		
		Total pipe length		85 [278-13/16]		
	Fan speed		-	Hi		
	Amount of refrigerant		kg [lbs-oz]	51.5 [114]		
Outdoor unit	Electric current		A	66.8		
	Voltage		V	400		
	Compressor frequency		Hz	101	101	101
LEV opening	Indoor unit		Pulse	388/388/388/388/325/362/261/261		
	SC (LEV1)			141	185	185
	LEV2			1400	1400	1400
Pressure	High pressure (after O/S)/low pressure (before accumulator)		MPa [psi]	2.95/0.81 [428/117]	2.86/0.76 [415/110]	2.86/0.76 [415/110]
Temp. of each section	Outdoor unit	Discharge (TH4)	°C [°F]	96 [204]	95 [202]	95 [202]
		Heat exchanger outlet (TH3)		47 [117]	46 [114]	46 [114]
		Accumulator inlet		7 [45]	7 [45]	7 [45]
		Accumulator outlet		7 [45]	7 [45]	7 [45]
		SCC outlet (TH6)		25 [77]	24 [75]	24 [75]
		Compressor inlet		19 [66]	19 [66]	19 [66]
		Compressor shell bottom		56 [132]	47 [117]	47 [117]
	Indoor unit	LEV inlet		17 [63]		
		Heat exchanger outlet		4 [40]		

Operation				Outdoor unit model			
				PUHY-P1250YSHM-A			
				PUHY-P350YHM-A	PUHY-P450YHM-A	PUHY-P450YHM-A	
Operating conditions	Ambient temperature	Indoor	DB/WB	27°C/19°C [81°F/66°F]			
		Outdoor		35°C/ - [95°F/ -]			
	Indoor unit	No. of connected units	Unit	8			
		No. of units in operation		8			
		Model		250/250/250/250/100/100/25/25			
	Piping	Main pipe	m [ft]	5 [16-3/8]			
		Branch pipe		10 [32-3/4]			
		Total pipe length		85 [278-13/16]			
	Fan speed		-	Hi			
	Amount of refrigerant		kg [lbs-oz]	52.5 [116]			
Outdoor unit	Electric current		A	72.1			
	Voltage		V	400			
	Compressor frequency		Hz	105	106	106	
LEV opening	Indoor unit		Pulse	388/388/388/388/325/325/222/222			
	SC (LEV1)			141	185	185	
	LEV2			1400	1400	1400	
Pressure	High pressure (after O/S)/low pressure (before accumulator)		MPa [psi]	2.95/0.81 [428/117]	2.86/0.76 [415/110]	2.86/0.76 [415/110]	
Temp. of each section	Outdoor unit	Discharge (TH4)	°C [°F]	96 [204]	95 [202]	95 [202]	
		Heat exchanger outlet (TH3)		47 [117]	46 [114]	46 [114]	
		Accumulator inlet		7 [45]	7 [45]	7 [45]	
		Accumulator outlet		7 [45]	7 [45]	7 [45]	
		SCC outlet (TH6)		25 [77]	24 [75]	24 [75]	
		Compressor inlet		19 [66]	19 [66]	19 [66]	
		Compressor shell bottom		56 [132]	47 [117]	47 [117]	
	Indoor unit	LEV inlet		17 [63]			
		Heat exchanger outlet		4 [40]			

(2) Heating operation

Operation				Outdoor unit model		
				PUHY-P950YSHM-A		
				PUHY-P250YHM-A	PUHY-P300YHM-A	PUHY-P400YHM-A
Operating conditions	Ambient temperature	Indoor	DB/WB	20°C/ - [68°F/ -]		
		Outdoor		7°C/6°C [45°F/43°F]		
	Indoor unit	No. of connected units	Unit	8		
		No. of units in operation		8		
		Model		-	250/200/200/125/100/32/32/25	
	Piping	Main pipe	m [ft]	5 [16-3/8]		
		Branch pipe		10 [32-3/4]		
		Total pipe length		85 [278-13/16]		
	Fan speed		-	Hi		
	Amount of refrigerant		kg [lbs-oz]	44.5 [98]		
Outdoor unit	Electric current		A	48.1		
	Voltage		V	400		
	Compressor frequency		Hz	72	90	90
LEV opening	Indoor unit		Pulse	400/332/332/406/332/254/254/229		
	SC (LEV1)			0		
	LEV2			1400	1400	1400
Pressure	High pressure (after O/S)/low pressure (before accumulator)		MPa [psi]	2.95/0.62 [428/90]	2.90/0.62 [421/90]	2.91/0.60 [422/87]
Temp. of each section	Outdoor unit	Discharge (TH4)	°C [°F]	81 [178]	82 [180]	89 [192]
		Heat exchanger outlet (TH3)		-3 [26]	-3 [26]	-4 [25]
		Accumulator inlet		-3 [26]	-3 [26]	-4 [25]
		Accumulator outlet		-3 [26]	-3 [26]	-4 [25]
		Compressor inlet		-3 [26]	-3 [26]	-4 [25]
		Compressor shell bottom		30 [86]	30 [85]	40 [104]
	Indoor unit	LEV inlet		39 [102]		
		Heat exchanger outlet		80 [176]		

Operation				Outdoor unit model		
				PUHY-P1000YSHM-A		
				PUHY-P300YHM-A	PUHY-P300YHM-A	PUHY-P400YHM-A
Operating conditions	Ambient temperature	Indoor	DB/WB	20°C/ - [68°F/ -]		
		Outdoor		7°C/6°C [45°F/43°F]		
	Indoor unit	No. of connected units	Unit	8		
		No. of units in operation		8		
		Model		250/250/200/125/63/63/32/25		
	Piping	Main pipe	m [ft]	5 [16-3/8]		
		Branch pipe		10 [32-3/4]		
		Total pipe length		85 [278-13/16]		
	Fan speed		-	Hi		
	Amount of refrigerant		kg [lbs-oz]	45 [99]		
Outdoor unit	Electric current		A	53.1		
	Voltage		V	400		
	Compressor frequency		Hz	88	88	88
LEV opening	Indoor unit		Pulse	400/400/332/406/455/455/254/229		
	SC (LEV1)			0		
	LEV2			1400	1400	1400
Pressure	High pressure (after O/S)/low pressure (before accumulator)		MPa [psi]	2.90/0.62 [421/90]	2.90/0.62 [421/90]	2.91/0.60 [422/87]
Temp. of each section	Outdoor unit	Discharge (TH4)	°C [°F]	82 [180]	82 [180]	89 [192]
		Heat exchanger outlet (TH3)		-3 [26]	-3 [26]	-4 [25]
		Accumulator inlet		-3 [26]	-3 [26]	-4 [25]
		Accumulator outlet		-3 [26]	-3 [26]	-4 [25]
		Compressor inlet		-3 [26]	-3 [26]	-4 [25]
		Compressor shell bottom		30 [85]	30 [85]	40 [104]
	Indoor unit	LEV inlet		39 [102]		
		Heat exchanger outlet		80 [176]		

Operation				Outdoor unit model		
				PUHY-P1050YSHM-A		
				PUHY-P300YHM-A	PUHY-P350YHM-A	PUHY-P400YHM-A
Operating conditions	Ambient temperature	Indoor	DB/WB	20°C/ - [68°F/ -]		
		Outdoor		7°C/6°C [45°F/43°F]		
	Indoor unit	No. of connected units	Unit	8		
		No. of units in operation		8		
		Model		250/250/200/125/100/71/32/25		
	Piping	Main pipe	m [ft]	5 [16-3/8]		
		Branch pipe		10 [32-3/4]		
		Total pipe length		85 [278-13/16]		
	Fan speed		-	Hi		
	Amount of refrigerant		kg [lbs-oz]	47.5 [105]		
Outdoor unit	Electric current		A	56.1		
	Voltage		V	400		
	Compressor frequency		Hz	94	95	95
LEV opening	Indoor unit		Pulse	400/400/332/406/332/259/254/229		
	SC (LEV1)			0		
	LEV2			800	960	1050
Pressure	High pressure (after O/S)/low pressure (before accumulator)		MPa [psi]	2.90/0.62 [421/90]	2.90/0.62 [421/90]	2.91/0.60 [422/87]
Temp. of each section	Outdoor unit	Discharge (TH4)	°C [°F]	82 [180]	82 [180]	89 [192]
		Heat exchanger outlet (TH3)		-3 [26]	-3 [26]	-4 [25]
		Accumulator inlet		-3 [26]	-3 [26]	-4 [25]
		Accumulator outlet		-3 [26]	-3 [26]	-4 [25]
		Compressor inlet		-3 [26]	-3 [26]	-4 [25]
		Compressor shell bottom		30 [85]	30 [85]	40 [104]
	Indoor unit	LEV inlet		39 [102]		
		Heat exchanger outlet		80 [176]		

Operation				Outdoor unit model		
				PUHY-P1100YSHM-A		
				PUHY-P350YHM-A	PUHY-P350YHM-A	PUHY-P400YHM-A
Operating conditions	Ambient temperature	Indoor	DB/WB	20°C/ - [68°F/ -]		
		Outdoor		7°C/6°C [45°F/43°F]		
	Indoor unit	No. of connected units	Unit	8		
		No. of units in operation		8		
		Model		250/250/200/200/100/50/32/25		
	Piping	Main pipe	m [ft]	5 [16-3/8]		
		Branch pipe		10 [32-3/4]		
		Total pipe length		85 [278-13/16]		
	Fan speed		-	Hi		
	Amount of refrigerant		kg [lbs-oz]	52 [115]		
Outdoor unit	Electric current		A	59.2		
	Voltage		V	400		
	Compressor frequency		Hz	101	101	102
LEV opening	Indoor unit		Pulse	400/400/332/332/332/373/254/229		
	SC (LEV1)			0		
	LEV2			960	960	1050
Pressure	High pressure (after O/S)/low pressure (before accumulator)		MPa [psi]	2.90/0.62 [421/90]	2.90/0.62 [421/90]	2.91/0.60 [422/87]
Temp. of each section	Outdoor unit	Discharge (TH4)	°C [°F]	82 [180]	82 [180]	89 [192]
		Heat exchanger outlet (TH3)		-3 [26]	-3 [26]	-4 [25]
		Accumulator inlet		-3 [26]	-3 [26]	-4 [25]
		Accumulator outlet		-3 [26]	-3 [26]	-4 [25]
		Compressor inlet		-3 [26]	-3 [26]	-4 [25]
		Compressor shell bottom		30 [85]	30 [85]	40 [104]
	Indoor unit	LEV inlet		39 [102]		
		Heat exchanger outlet		80 [176]		

Operation				Outdoor unit model		
				PUHY-P1150YSHM-A		
				PUHY-P350YHM-A	PUHY-P350YHM-A	PUHY-P450YHM-A
Operating conditions	Ambient temperature	Indoor	DB/WB	20°C/ - [68°F/ -]		
		Outdoor		7°C/6°C [45°F/43°F]		
	Indoor unit	No. of connected units	Unit	8		
		No. of units in operation		8		
		Model		250/250/200/200/100/50/32/25		
	Piping	Main pipe	m [ft]	5 [16-3/8]		
		Branch pipe		10 [32-3/4]		
		Total pipe length		85 [278-13/16]		
	Fan speed		-	Hi		
	Amount of refrigerant		kg [lbs-oz]	52 [115]		
Outdoor unit	Electric current		A	62.6		
	Voltage		V	400		
	Compressor frequency		Hz	106	105	105
LEV opening	Indoor unit		Pulse	400/400/332/332/332/373/254/229		
	SC (LEV1)			0		
	LEV2			960	960	1050
Pressure	High pressure (after O/S)/low pressure (before accumulator)		MPa [psi]	2.90/0.62 [421/90]	2.90/0.62 [421/90]	2.91/0.60 [422/87]
Temp. of each section	Outdoor unit	Discharge (TH4)	°C [°F]	82 [180]	82 [180]	89 [192]
		Heat exchanger outlet (TH3)		-3 [26]	-3 [26]	-4 [25]
		Accumulator inlet		-3 [26]	-3 [26]	-4 [25]
		Accumulator outlet		-3 [26]	-3 [26]	-4 [25]
		Compressor inlet		-3 [26]	-3 [26]	-4 [25]
		Compressor shell bottom		30 [85]	30 [85]	40 [104]
	Indoor unit	LEV inlet		39 [102]		
		Heat exchanger outlet		80 [176]		

Operation				Outdoor unit model			
				PUHY-P1200YSHM-A			
				PUHY-P350YHM-A	PUHY-P400YHM-A	PUHY-P450YHM-A	
Operating conditions	Ambient temperature	Indoor	DB/WB	20°C/ - [68°F/ -]			
		Outdoor		7°C/6°C [45°F/43°F]			
	Indoor unit	No. of connected units	Unit	8			
		No. of units in operation		8			
		Model		-	250/250/250/250/100/50/32/32		
	Piping	Main pipe	m [ft]	5 [16-3/8]			
		Branch pipe		10 [32-3/4]			
		Total pipe length		85 [278-13/16]			
	Fan speed		-	Hi			
	Amount of refrigerant		kg [lbs-oz]	51.5 [114]			
Outdoor unit	Electric current		A	64.3			
	Voltage		V	400			
	Compressor frequency		Hz	106	107	107	
LEV opening	Indoor unit		Pulse	400/400/400/400/332/373/254/254			
	SC (LEV1)			0			
	LEV2			960	1050	1050	
Pressure	High pressure (after O/S)/low pressure (before accumulator)		MPa [psi]	0.90/0.62 [421/90]	2.91/0.60 [422/87]	2.91/0.60 [422/87]	
Temp. of each section	Outdoor unit	Discharge (TH4)	°C [°F]	82 [180]	89 [192]	89 [192]	
		Heat exchanger outlet (TH3)		-3 [26]	-4 [25]	-4 [25]	
		Accumulator inlet		-3 [26]	-4 [25]	-4 [25]	
		Accumulator outlet		-3 [26]	-4 [25]	-4 [25]	
		Compressor inlet		-3 [26]	-4 [25]	-4 [25]	
		Compressor shell bottom		30 [85]	40 [104]	40 [104]	
	Indoor unit	LEV inlet		39 [102]			
		Heat exchanger outlet		80 [176]			

Operation				Outdoor unit model			
				PUHY-P1250YSHM-A			
				PUHY-P350YHM-A	PUHY-P450YHM-A	PUHY-P450YHM-A	
Operating conditions	Ambient temperature	Indoor	DB/WB	20°C/ - [68°F/ -]			
		Outdoor		7°C/6°C [45°F/43°F]			
	Indoor unit	No. of connected units	Unit	8			
		No. of units in operation		8			
		Model		-	250/250/250/250/100/100/25/25		
	Piping	Main pipe	m [ft]	5 [16-3/8]			
		Branch pipe		10 [32-3/4]			
		Total pipe length		85 [278-13/16]			
	Fan speed		-	Hi			
	Amount of refrigerant		kg [lbs-oz]	52.5 [116]			
Outdoor unit	Electric current		A	67.4			
	Voltage		V	400			
	Compressor frequency		Hz	111	112	112	
LEV opening	Indoor unit		Pulse	400/400/400/400/332/332/229/229			
	SC (LEV1)			0			
	LEV2			960	1050	1050	
Pressure	High pressure (after O/S)/low pressure (before accumulator)		MPa [psi]	2.90/0.62 [421/90]	2.91/0.60 [422/87]	2.91/0.60 [422/87]	
Temp. of each section	Outdoor unit	Discharge (TH4)	°C [°F]	82 [180]	89 [192]	89 [192]	
		Heat exchanger outlet (TH3)		-3 [26]	-4 [25]	-4 [25]	
		Accumulator inlet		-3 [26]	-4 [25]	-4 [25]	
		Accumulator outlet		-3 [26]	-4 [25]	-4 [25]	
		Compressor inlet		-3 [26]	-4 [25]	-4 [25]	
		Compressor shell bottom		30 [85]	40 [104]	40 [104]	
	Indoor unit	LEV inlet		39 [102]			
		Heat exchanger outlet		80 [176]			

4. Single unit (High-COP)

(1) Cooling operation

Operation				Outdoor unit model	
				PUHY-EP200YHM-A	PUHY-EP250YHM-A
Operating conditions	Ambient temperature	Indoor	DB/WB	27°C/19°C [81°F/66°F]	27°C/19°C [81°F/66°F]
		Outdoor		35°C/ - [95°F/ -]	35°C/ - [95°F/ -]
	Indoor unit	No. of connected units	Unit	2	2
		No. of units in operation		2	2
		Model		-	100/100
	Piping	Main pipe	m [ft]	5 [16-3/8]	5 [16-3/8]
		Branch pipe		10 [32-3/4]	10 [32-3/4]
		Total pipe length		25 [82]	25 [82]
	Fan speed		-	Hi	Hi
	Amount of refrigerant		kg [lbs-oz]	13.5 [30]	16 [35]
Outdoor unit	Electric current		A	8.3	10.9
	Voltage		V	400	400
	Compressor frequency		Hz	52	65
LEV opening	Indoor unit		Pulse	325/325	387/387
	SC (LEV1)			80	100
	LEV2			-	-
Pressure	High pressure (after O/S)/low pressure (before accumulator)		MPa [psi]	2.63/0.74 [382/107]	2.76/0.86 [400/125]
Temp. of each section	Outdoor unit	Discharge (TH4)	°C [°F]	84 [181]	80 [174]
		Heat exchanger outlet (TH3)		44 [111]	44 [111]
		Accumulator inlet		7 [45]	7 [45]
		Accumulator outlet		7 [45]	7 [45]
		SCC outlet (TH6)		22 [72]	24 [75]
		Compressor inlet		19 [66]	19 [66]
		Compressor shell bottom		47 [117]	38 [100]
	Indoor unit	LEV inlet		19 [66]	19 [66]
		Heat exchanger outlet		6 [43]	6 [43]

Operation				Outdoor unit model	
				PUHY-EP300YHM-A	PUHY-EP350YHM-A
Operating conditions	Ambient temperature	Indoor	DB/WB	27°C/19°C [81°F/66°F]	27°C/19°C [81°F/66°F]
		Outdoor		35°C/ - [95°F/ -]	35°C/ - [95°F/ -]
	Indoor unit	No. of connected units	Unit	3	3
		No. of units in operation		3	3
		Model		-	100/100/100
	Piping	Main pipe	m [ft]	5 [16-3/8]	5 [16-3/8]
		Branch pipe		10 [32-3/4]	10 [32-3/4]
		Total pipe length		35 [114-13/16]	35 [114-13/16]
	Fan speed		-	Hi	Hi
	Amount of refrigerant		kg [lbs-oz]	17 [37]	17.5 [39]
Outdoor unit	Electric current		A	13.2	17.9
	Voltage		V	400	400
	Compressor frequency		Hz	74	95
LEV opening	Indoor unit		Pulse	325/325/325	325/387/387
	SC (LEV1)			100	100
	LEV2			-	-
Pressure	High pressure (after O/S)/low pressure (before accumulator)		MPa [psi]	2.63/0.84 [382/122]	2.86/0.76 [415/110]
Temp. of each section	Outdoor unit	Discharge (TH4)	°C [°F]	79 [172]	90 [194]
		Heat exchanger outlet (TH3)		44 [111]	43 [109]
		Accumulator inlet		7 [45]	7 [45]
		Accumulator outlet		7 [45]	7 [45]
		SCC outlet (TH6)		22 [72]	22 [72]
		Compressor inlet		19 [66]	19 [66]
		Compressor shell bottom		42 [108]	42 [108]
	Indoor unit	LEV inlet		19 [66]	19 [66]
		Heat exchanger outlet		6 [43]	6 [43]

(2) Heating operation

Operation				Outdoor unit model	
				PUHY-EP200YHM-A	PUHY-EP250YHM-A
Operating conditions	Ambient temperature	Indoor	DB/WB	20°C/ - [68°F/ -]	20°C/ - [68°F/ -]
		Outdoor		7°C/6°C [45°F/43°F]	7°C/6°C [45°F/43°F]
	Indoor unit	No. of connected units	Unit	2	2
		No. of units in operation		2	2
		Model		-	100/100
	Piping	Main pipe	m [ft]	5 [16-3/8]	5 [16-3/8]
		Branch pipe		10 [32-3/4]	10 [32-3/4]
		Total pipe length		25 [82]	25 [82]
	Fan speed		-	Hi	Hi
	Amount of refrigerant		kg [lbs-oz]	13.5 [30]	16 [35]
Outdoor unit	Electric current		A	9.2	12.1
	Voltage		V	400	400
	Compressor frequency		Hz	51	69
LEV opening	Indoor unit		Pulse	332/332	406/406
	SC (LEV1)			0	0
	LEV2			-	-
Pressure	High pressure (after O/S)/low pressure (before accumulator)		MPa [psi]	2.81/0.68 [408/99]	2.85/0.62 [413/90]
Temp. of each section	Outdoor unit	Discharge (TH4)	°C [°F]	82 [180]	82 [180]
		Heat exchanger outlet (TH3)		0 [32]	0 [32]
		Accumulator inlet		0 [32]	0 [32]
		Accumulator outlet		0 [32]	0 [32]
		Compressor inlet		0 [32]	0 [32]
		Compressor shell bottom		42 [108]	42 [108]
	Indoor unit	LEV inlet		37 [99]	38 [100]
		Heat exchanger outlet		80 [176]	80 [176]

Operation				Outdoor unit model	
				PUHY-EP300YHM-A	PUHY-EP350YHM-A
Operating conditions	Ambient temperature	Indoor	DB/WB	20°C/ - [68°F/ -]	20°C/ - [68°F/ -]
		Outdoor		7°C/6°C [45°F/43°F]	7°C/6°C [45°F/43°F]
	Indoor unit	No. of connected units	Unit	3	3
		No. of units in operation		3	3
		Model		-	100/100/100
	Piping	Main pipe	m [ft]	5 [16-3/8]	5 [16-3/8]
		Branch pipe		10 [32-3/4]	10 [32-3/4]
		Total pipe length		35 [114-13/16]	35 [114-13/16]
	Fan speed		-	Hi	Hi
	Amount of refrigerant		kg [lbs-oz]	17 [37]	17.5 [39]
Outdoor unit	Electric current		A	14.8	19.3
	Voltage		V	400	400
	Compressor frequency		Hz	80	101
LEV opening	Indoor unit		Pulse	332/332/332	332/406/406
	SC (LEV1)			0	0
	LEV2			-	-
Pressure	High pressure (after O/S)/low pressure (before accumulator)		MPa [psi]	2.78/0.62 [403/90]	2.81/0.57 [408/83]
Temp. of each section	Outdoor unit	Discharge (TH4)	°C [°F]	82 [180]	82 [180]
		Heat exchanger outlet (TH3)		0 [32]	-3 [27]
		Accumulator inlet		0 [32]	-3 [27]
		Accumulator outlet		0 [32]	-3 [27]
		Compressor inlet		0 [32]	-3 [27]
		Compressor shell bottom		43 [109]	40 [104]
	Indoor unit	LEV inlet		39 [102]	39 [102]
		Heat exchanger outlet		80 [176]	80 [176]

5. 2-unit combination

(1) Cooling operation

Operation				Outdoor unit model	
				PUHY-EP400YSHM-A	
				PUHY-EP200YHM-A	PUHY-EP200YHM-A
Operating conditions	Ambient temperature	Indoor	DB/WB	27°C/19°C [81°F/66°F]	
		Outdoor		35°C/ - [95°F/ -]	
	Indoor unit	No. of connected units	Unit	4	
		No. of units in operation		4	
		Model		100/100/100/100	
	Piping	Main pipe	m [ft]	5 [16-3/8]	
		Branch pipe		10 [32-3/4]	
		Total pipe length		45 [147-5/8]	
	Fan speed		-	Hi	
	Amount of refrigerant		kg [lbs-oz]	25.5 [56]	
Outdoor unit	Electric current		A	16.6	
	Voltage		V	400	
	Compressor frequency		Hz	52	52
LEV opening	Indoor unit		Pulse	325/325/325/325	
	SC (LEV1)			100	100
	LEV2			1400	1400
Pressure	High pressure (after O/S)/low pressure (before accumulator)		MPa [psi]	2.63/0.74 [382/107]	2.63/0.74 [382/107]
Temp. of each section	Outdoor unit	Discharge (TH4)	°C [°F]	84 [181]	84 [181]
		Heat exchanger outlet (TH3)		44 [111]	44 [111]
		Accumulator inlet		7 [45]	7 [45]
		Accumulator outlet		7 [45]	7 [45]
		SCC outlet (TH6)		22 [72]	22 [72]
		Compressor inlet		19 [66]	19 [66]
		Compressor shell bottom		47 [117]	47 [117]
	Indoor unit	LEV inlet		19 [66]	
		Heat exchanger outlet		6 [43]	

Operation				Outdoor unit model	
				PUHY-EP450YSHM-A1	
				PUHY-EP200YHM-A	PUHY-EP250YHM-A
Operating conditions	Ambient temperature	Indoor	DB/WB	27°C/19°C [81°F/66°F]	
		Outdoor		35°C/ - [95°F/ -]	
	Indoor unit	No. of connected units	Unit	4	
		No. of units in operation		4	
		Model		100/100/125/125	
	Piping	Main pipe	m [ft]	5 [16-3/8]	
		Branch pipe		10 [32-3/4]	
		Total pipe length		45 [147-5/8]	
	Fan speed		-	Hi	
	Amount of refrigerant		kg [lbs-oz]	28 [62]	
Outdoor unit	Electric current		A	19	
	Voltage		V	400	
	Compressor frequency		Hz	52	65
LEV opening	Indoor unit		Pulse	325/325/387/387	
	SC (LEV1)			100	100
	LEV2			1400	1400
Pressure	High pressure (after O/S)/low pressure (before accumulator)		MPa [psi]	2.63/0.74 [382/107]	2.76/0.86 [400/125]
Temp. of each section	Outdoor unit	Discharge (TH4)	°C [°F]	84 [181]	80 [174]
		Heat exchanger outlet (TH3)		44 [111]	44 [111]
		Accumulator inlet		7 [45]	7 [45]
		Accumulator outlet		7 [45]	7 [45]
		SCC outlet (TH6)		22 [72]	24 [75]
		Compressor inlet		19 [66]	19 [66]
		Compressor shell bottom		47 [117]	38 [100]
	Indoor unit	LEV inlet		19 [66]	
		Heat exchanger outlet		6 [43]	

Operation				Outdoor unit model	
				PUHY-EP500YSHM-A	
				PUHY-EP250YHM-A	PUHY-EP250YHM-A
Operating conditions	Ambient temperature	Indoor	DB/WB	27°C/19°C [81°F/66°F]	
		Outdoor		35°C/ - [95°F/ -]	
	Indoor unit	No. of connected units	Unit	4	
		No. of units in operation		4	
		Model		125/125/125/125	
	Piping	Main pipe	m [ft]	5 [16-3/8]	
		Branch pipe		10 [32-3/4]	
		Total pipe length		45 [147-5/8]	
	Fan speed		-	Hi	
	Amount of refrigerant		kg [lbs-oz]	31.4 [69]	
Outdoor unit	Electric current		A		21.5
	Voltage		V		400
	Compressor frequency		Hz		65 65
LEV opening	Indoor unit		Pulse		387/387/387/387
	SC (LEV1)				100 100
	LEV2				1400 1400
Pressure	High pressure (after O/S)/low pressure (before accumulator)		MPa [psi]		2.76/0.86 [400/125] 2.76/0.86 [400/125]
Temp. of each section	Outdoor unit	Discharge (TH4)	°C [°F]	80 [174] 80 [174]	
		Heat exchanger outlet (TH3)		44 [111] 44 [111]	
		Accumulator inlet		7 [45] 7 [45]	
		Accumulator outlet		7 [45] 7 [45]	
		SCC outlet (TH6)		24 [75] 24 [75]	
		Compressor inlet		19 [66] 19 [66]	
		Compressor shell bottom		38 [100] 38 [100]	
	Indoor unit	LEV inlet		19 [66]	
		Heat exchanger outlet		6 [43]	

Operation				Outdoor unit model	
				PUHY-EP550YSHM-A1	
				PUHY-EP250YHM-A	PUHY-EP300YHM-A
Operating conditions	Ambient temperature	Indoor	DB/WB	27°C/19°C [81°F/66°F]	
		Outdoor		35°C/ - [95°F/ -]	
	Indoor unit	No. of connected units	Unit	6	
		No. of units in operation		6	
		Model		20/100/100/100/125/125	
	Piping	Main pipe	m [ft]	5 [16-3/8]	
		Branch pipe		10 [32-3/4]	
		Total pipe length		65 [213-1/4]	
	Fan speed		-	Hi	
	Amount of refrigerant		kg [lbs-oz]	32.3 [71]	
Outdoor unit	Electric current		A		24.7
	Voltage		V		400
	Compressor frequency		Hz		65 74
LEV opening	Indoor unit		Pulse		222/325/325/325/387/387
	SC (LEV1)				159 237
	LEV2				1400 1400
Pressure	High pressure (after O/S)/low pressure (before accumulator)		MPa [psi]		2.76/0.86 [400/125] 2.63/0.84 [382/122]
Temp. of each section	Outdoor unit	Discharge (TH4)	°C [°F]	80 [174] 79 [172]	
		Heat exchanger outlet (TH3)		44 [111] 44 [111]	
		Accumulator inlet		7 [45] 7 [45]	
		Accumulator outlet		7 [45] 7 [45]	
		SCC outlet (TH6)		24 [75] 22 [72]	
		Compressor inlet		19 [66] 19 [66]	
		Compressor shell bottom		38 [100] 42 [108]	
	Indoor unit	LEV inlet		19 [66]	
		Heat exchanger outlet		6 [43]	

Operation				Outdoor unit model	
				PUHY-EP600YSHM-A	
				PUHY-EP300YHM-A	PUHY-EP300YHM-A
Operating conditions	Ambient temperature	Indoor	DB/WB	27°C/19°C [81°F/66°F]	
		Outdoor		35°C/- [95°F/-]	
	Indoor unit	No. of connected units	Unit	6	
		No. of units in operation		6	
		Model		50/100/100/100/125/125	
	Piping	Main pipe	m [ft]	5 [16-3/8]	
		Branch pipe		10 [32-3/4]	
		Total pipe length		65 [213-1/4]	
	Fan speed		-	Hi	
	Amount of refrigerant		kg [lbs-oz]	32.3 [71]	
Outdoor unit	Electric current		A		27.2
	Voltage		V		400
	Compressor frequency		Hz		74 74
LEV opening	Indoor unit		Pulse	362/325/325/325/387/387	
	SC (LEV1)			105 105	
	LEV2			1400 1400	
Pressure	High pressure (after O/S)/low pressure (before accumulator)		MPa [psi]	2.63/0.84 [382/122] 2.63/0.84 [382/122]	
Temp. of each section	Outdoor unit	Discharge (TH4)	°C [°F]	79 [172] 79 [172]	
		Heat exchanger outlet (TH3)		44 [111] 44 [111]	
		Accumulator inlet		7 [45] 7 [45]	
		Accumulator outlet		7 [45] 7 [45]	
		SCC outlet (TH6)		22 [72] 22 [72]	
		Compressor inlet		19 [66] 19 [66]	
		Compressor shell bottom		42 [108] 42 [108]	
	Indoor unit	LEV inlet		19 [66]	
		Heat exchanger outlet		6 [43]	

Operation				Outdoor unit model	
				PUHY-EP650YSHM-A	
				PUHY-EP300YHM-A	PUHY-EP350YHM-A
Operating conditions	Ambient temperature	Indoor	DB/WB	27°C/19°C [81°F/66°F]	
		Outdoor		35°C/ - [95°F/ -]	
	Indoor unit	No. of connected units	Unit	6	
		No. of units in operation		6	
		Model		100/100/100/100/125/125	
	Piping	Main pipe	m [ft]	5 [16-3/8]	
		Branch pipe		10 [32-3/4]	
		Total pipe length		65 [213-1/4]	
	Fan speed		-	Hi	
	Amount of refrigerant		kg [lbs-oz]	32.6 [72]	
Outdoor unit	Electric current		A	29.4	
	Voltage		V	400	
	Compressor frequency		Hz	74	95
LEV opening	Indoor unit		Pulse	325/325/325/325/387/387	
	SC (LEV1)			105	105
	LEV2			1400	1400
Pressure	High pressure (after O/S)/low pressure (before accumulator)		MPa [psi]	2.63/0.84 [382/122]	2.86/0.76 [415/110]
Temp. of each section	Outdoor unit	Discharge (TH4)	°C [°F]	79 [172]	90 [194]
		Heat exchanger outlet (TH3)		44 [111]	43 [109]
		Accumulator inlet		7 [45]	7 [45]
		Accumulator outlet		7 [45]	7 [45]
		SCC outlet (TH6)		22 [72]	22 [72]
		Compressor inlet		19 [66]	19 [66]
		Compressor shell bottom		42 [108]	42 [108]
	Indoor unit	LEV inlet		19 [66]	
		Heat exchanger outlet		6 [43]	

(2) Heating operation

Operation				Outdoor unit model	
				PUHY-EP400YSHM-A	
				PUHY-EP200YHM-A	PUHY-EP200YHM-A
Operating conditions	Ambient temperature	Indoor	DB/WB	20°C/ - [68°F/ -]	
		Outdoor		7°C/ 6°C [45°F/43°F]	
	Indoor unit	No. of connected units	Unit	4	
		No. of units in operation		4	
		Model		100/100/100/100	
	Piping	Main pipe	m [ft]	5 [16-3/8]	
		Branch pipe		10 [32-3/4]	
		Total pipe length		45 [147-5/8]	
	Fan speed		-	Hi	
	Amount of refrigerant		kg [lbs-oz]	25.5 [56]	
Outdoor unit	Electric current		A	18.5	
	Voltage		V	400	
	Compressor frequency		Hz	51	51
LEV opening	Indoor unit		Pulse	332/332/332/332	
	SC (LEV1)			0	
	LEV2			1400	1400
Pressure	High pressure (after O/S)/low pressure (before accumulator)		MPa [psi]	2.74/0.68 [397/99]	2.74/0.68 [397/99]
Temp. of each section	Outdoor unit	Discharge (TH4)	°C [°F]	83 [181]	83 [181]
		Heat exchanger outlet (TH3)		0 [32]	0 [32]
		Accumulator inlet		0 [32]	0 [32]
		Accumulator outlet		0 [32]	0 [32]
		Compressor inlet		0 [32]	0 [32]
		Compressor shell bottom		42 [108]	42 [108]
	Indoor unit	LEV inlet		37 [99]	
		Heat exchanger outlet		80 [176]	

Operation				Outdoor unit model	
				PUHY-EP450YSHM-A1	
				PUHY-EP200YHM-A	PUHY-EP250YHM-A
Operating conditions	Ambient temperature	Indoor	DB/WB	20°C/ - [68°F/ -]	
		Outdoor		7°C/ 6°C [45°F/43°F]	
	Indoor unit	No. of connected units	Unit	4	
		No. of units in operation		4	
		Model		100/100/125/125	
	Piping	Main pipe	m [ft]	5 [16-3/8]	
		Branch pipe		10 [32-3/4]	
		Total pipe length		45 [147-5/8]	
	Fan speed		-	Hi	
	Amount of refrigerant		kg [lbs-oz]	28 [62]	
Outdoor unit	Electric current		A		20.9
	Voltage		V		400
	Compressor frequency		Hz		51 69
LEV opening	Indoor unit		Pulse	332/332/406/406	
	SC (LEV1)			0	
	LEV2			1400 1400	
Pressure	High pressure (after O/S)/low pressure (before accumulator)		MPa [psi]	2.81/0.68 [408/99]	2.81/0.68 [408/99]
Temp. of each section	Outdoor unit	Discharge (TH4)	°C [°F]	83 [181]	83 [181]
		Heat exchanger outlet (TH3)		0 [32]	0 [32]
		Accumulator inlet		0 [32]	0 [32]
		Accumulator outlet		0 [32]	0 [32]
		Compressor inlet		0 [32]	0 [32]
		Compressor shell bottom		42 [108]	42 [108]
	Indoor unit	LEV inlet		37 [99]	
		Heat exchanger outlet		80 [176]	

Operation				Outdoor unit model	
				PUHY-EP500YSHM-A	
				PUHY-EP250YHM-A	PUHY-EP250YHM-A
Operating conditions	Ambient temperature	Indoor	DB/WB	20°C/ - [68°F/ -]	
		Outdoor		7°C/ 6°C [45°F/43°F]	
	Indoor unit	No. of connected units	Unit	4	
		No. of units in operation		4	
		Model		125/125/125/125	
	Piping	Main pipe	m [ft]	5 [16-3/8]	
		Branch pipe		10 [32-3/4]	
		Total pipe length		45 [147-5/8]	
	Fan speed		-	Hi	
	Amount of refrigerant		kg [lbs-oz]	31.4 [69]	
Outdoor unit	Electric current		A		24.2
	Voltage		V		400
	Compressor frequency		Hz		69 69
LEV opening	Indoor unit		Pulse	406/406/406/406	
	SC (LEV1)			0	
	LEV2			1400	1400
Pressure	High pressure (after O/S)/low pressure (before accumulator)		MPa [psi]	2.85/0.62 [413/90]	2.85/0.62 [413/90]
Temp. of each section	Outdoor unit	Discharge (TH4)	°C [°F]	82 [180]	82 [180]
		Heat exchanger outlet (TH3)		0 [32]	0 [32]
		Accumulator inlet		0 [32]	0 [32]
		Accumulator outlet		0 [32]	0 [32]
		Compressor inlet		0 [32]	0 [32]
		Compressor shell bottom		42 [108]	42 [108]
	Indoor unit	LEV inlet		37 [99]	
		Heat exchanger outlet		80 [176]	

Operation				Outdoor unit model	
				PUHY-EP550YSHM-A1	
				PUHY-EP250YHM-A	PUHY-EP300YHM-A
Operating conditions	Ambient temperature	Indoor	DB/WB	20°C/ - [68°F/ -]	
		Outdoor		7°C/ 6°C [45°F/43°F]	
	Indoor unit	No. of connected units	Unit	6	
		No. of units in operation		6	
		Model		20/100/100/100/125/125	
	Piping	Main pipe	m [ft]	5 [16-3/8]	
		Branch pipe		10 [32-3/4]	
		Total pipe length		65 [213-1/4]	
	Fan speed		-	Hi	
	Amount of refrigerant		kg [lbs-oz]	32.3 [71]	
Outdoor unit	Electric current		A		26.9
	Voltage		V		400
	Compressor frequency		Hz		69 80
LEV opening	Indoor unit		Pulse	229/332/332/332/406/406	
	SC (LEV1)			0	
	LEV2			1400	1400
Pressure	High pressure (after O/S)/low pressure (before accumulator)		MPa [psi]	2.85/0.62 [413/90]	2.78/0.62 [403/90]
Temp. of each section	Outdoor unit	Discharge (TH4)	°C [°F]	82 [180]	82 [180]
		Heat exchanger outlet (TH3)		0 [32]	0 [32]
		Accumulator inlet		0 [32]	0 [32]
		Accumulator outlet		0 [32]	0 [32]
		Compressor inlet		0 [32]	0 [32]
		Compressor shell bottom		42 [108]	43 [109]
	Indoor unit	LEV inlet		35 [95]	
		Heat exchanger outlet		80 [176]	

Operation				Outdoor unit model	
				PUHY-EP600YSHM-A	
				PUHY-EP300YHM-A	PUHY-EP300YHM-A
Operating conditions	Ambient temperature	Indoor	DB/WB	20°C / - [68°F / -]	
		Outdoor		7°C/6°C [45°F/43°F]	
	Indoor unit	No. of connected units	Unit	6	
		No. of units in operation		6	
		Model		50/100/100/100/125/125	
	Piping	Main pipe	m [ft]	5 [16-3/8]	
		Branch pipe		10 [32-3/4]	
		Total pipe length		65 [213-1/4]	
	Fan speed		-	Hi	
	Amount of refrigerant		kg [lbs-oz]	32.3 [71]	
Outdoor unit	Electric current		A	30.3	
	Voltage		V	400	
	Compressor frequency		Hz	80	80
LEV opening	Indoor unit		Pulse	373/332/332/332/406/406	
	SC (LEV1)			0	
	LEV2			1400	1400
Pressure	High pressure (after O/S)/low pressure (before accumulator)		MPa [psi]	2.78/0.62 [403/90]	2.78/0.62 [403/90]
Temp. of each section	Outdoor unit	Discharge (TH4)	°C [°F]	82 [180]	82 [180]
		Heat exchanger outlet (TH3)		0 [32]	0 [32]
		Accumulator inlet		0 [32]	0 [32]
		Accumulator outlet		0 [32]	0 [32]
		Compressor inlet		0 [32]	0 [32]
		Compressor shell bottom		43 [109]	43 [109]
	Indoor unit	LEV inlet		35 [95]	
		Heat exchanger outlet		80 [176]	

Operation				Outdoor unit model	
				PUHY-EP650YSHM-A	
				PUHY-EP300YHM-A	PUHY-EP350YHM-A
Operating conditions	Ambient temperature	Indoor	DB/WB	20°C / - [68°F / -]	
		Outdoor		7°C/6°C [45°F/43°F]	
	Indoor unit	No. of connected units	Unit	6	
		No. of units in operation		6	
		Model		100/100/100/100/125/125	
	Piping	Main pipe	m [ft]	5 [16-3/8]	
		Branch pipe		10 [32-3/4]	
		Total pipe length		65 [213-1/4]	
	Fan speed		-	Hi	
	Amount of refrigerant		kg [lbs-oz]	32.6 [72]	
Outdoor unit	Electric current		A		30.6
	Voltage		V		400
	Compressor frequency		Hz		80 101
LEV opening	Indoor unit		Pulse	350/350/340/340/330/330	
	SC (LEV1)			0	
	LEV2			1400	1400
Pressure	High pressure (after O/S)/low pressure (before accumulator)		MPa [psi]	2.78/0.62 [403/90]	2.81/0.57 [408/83]
Temp. of each section	Outdoor unit	Discharge (TH4)	°C [°F]	82 [180]	82 [180]
		Heat exchanger outlet (TH3)		0 [32]	-3 [27]
		Accumulator inlet		0 [32]	-3 [27]
		Accumulator outlet		0 [32]	-3 [27]
		Compressor inlet		0 [32]	-3 [27]
		Compressor shell bottom		43 [109]	40 [104]
	Indoor unit	LEV inlet		35 [95]	
		Heat exchanger outlet		80 [176]	

6. 3-unit combination
(1) Cooling operation

Operation				Outdoor unit model		
				PUHY-EP700YSHM-A		
				PUHY-EP200YHM-A	PUHY-EP200YHM-A	PUHY-EP300YHM-A
Operating conditions	Ambient temperature	Indoor	DB/WB	27°C/19°C [81°F/66°F]		
		Outdoor		35°C/ - [95°F/ -]		
	Indoor unit	No. of connected units	Unit	6		
		No. of units in operation		6		
		Model		100/100/125/125/125/125		
	Piping	Main pipe	m [ft]	5 [16-3/8]		
		Branch pipe		10 [32-3/4]		
		Total pipe length		65 [213-1/4]		
	Fan speed		-	Hi		
	Amount of refrigerant		kg [lbs-oz]	40.6 [90]		
Outdoor unit	Electric current		A	33.6		
	Voltage		V	400		
	Compressor frequency		Hz	52	52	74
LEV opening	Indoor unit		Pulse	325/325/387/387/387/387		
	SC (LEV1)			100	100	105
	LEV2			1400	1400	1400
Pressure	High pressure (after O/S)/low pressure (before accumulator)		MPa [psi]	2.63/0.74 [382/107]	2.63/0.74 [382/107]	2.63/0.84 [382/122]
	Temp. of each section	Outdoor unit	Discharge (TH4)	°C [°F]	84 [181]	84 [181]
Heat exchanger outlet (TH3)			44 [111]		44 [111]	44 [111]
Accumulator inlet			7 [45]		7 [45]	7 [45]
Accumulator outlet			7 [45]		7 [45]	7 [45]
SCC outlet (TH6)			22 [72]		22 [72]	22 [72]
Compressor inlet			19 [66]		19 [66]	19 [66]
Compressor shell bottom			47 [117]		47 [117]	42 [108]
Indoor unit		LEV inlet	19 [66]			
		Heat exchanger outlet	6 [43]			

Operation				Outdoor unit model		
				PUHY-EP750YSHM-A1		
				PUHY-EP200YHM-A	PUHY-EP250YHM-A	PUHY-EP300YHM-A
Operating conditions	Ambient temperature	Indoor	DB/WB	27°C/19°C [81°F/66°F]		
		Outdoor		35°C/ - [95°F/ -]		
	Indoor unit	No. of connected units	Unit	6		
		No. of units in operation		6		
		Model		125/125/125/125/125/125		
	Piping	Main pipe	m [ft]	5 [16-3/8]		
		Branch pipe		10 [32-3/4]		
		Total pipe length		65 [213-1/4]		
	Fan speed		-	Hi		
	Amount of refrigerant		kg [lbs-oz]	45.1 [99]		
Outdoor unit	Electric current		A	32.7		
	Voltage		V	400		
	Compressor frequency		Hz	52	65	74
LEV opening	Indoor unit		Pulse	387/387/387/387/387/387		
	SC (LEV1)			100	100	141
	LEV2			1400	1400	1400
Pressure	High pressure (after O/S)/low pressure (before accumulator)		MPa [psi]	2.63/0.74 [382/107]	2.76/0.86 [400/125]	2.63/0.84 [382/122]
	Temp. of each section	Outdoor unit	Discharge (TH4)	°C [°F]	84 [181]	80 [174]
Heat exchanger outlet (TH3)			44 [111]		44 [111]	44 [111]
Accumulator inlet			7 [45]		7 [45]	7 [45]
Accumulator outlet			7 [45]		7 [45]	7 [45]
SCC outlet (TH6)			22 [72]		24 [75]	22 [72]
Compressor inlet			19 [66]		19 [66]	19 [66]
Compressor shell bottom			47 [117]		38 [100]	42 [108]
Indoor unit		LEV inlet	17 [63]			
		Heat exchanger outlet	4 [39]			

Operation				Outdoor unit model		
				PUHY-EP800YSHM-A		
				PUHY-EP200YHM-A	PUHY-EP300YHM-A	PUHY-EP300YHM-A
Operating conditions	Ambient temperature	Indoor	DB/WB	27°C/19°C [81°F/66°F]		
		Outdoor		35°C/ - [95°F/ -]		
	Indoor unit	No. of connected units	Unit	6		
		No. of units in operation		6		
		Model		125/125/125/140/140/140		
	Piping	Main pipe	m [ft]	5 [16-3/8]		
		Branch pipe		10 [32-3/4]		
		Total pipe length		65 [213-1/4]		
	Fan speed		-	Hi		
	Amount of refrigerant		kg [lbs-oz]	45.1 [99]		
Outdoor unit	Electric current		A	35.2		
	Voltage		V	400		
	Compressor frequency		Hz	52	74	74
LEV opening	Indoor unit		Pulse	387/387/387/310/310/310		
	SC (LEV1)			116	130	130
	LEV2			1400	1400	1400
Pressure	High pressure (after O/S)/low pressure (before accumulator)		MPa [psi]	2.63/0.74 [382/107]	2.63/0.84 [382/122]	2.63/0.84 [382/122]
	Temp. of each section	Outdoor unit	Discharge (TH4)	°C [°F]	84 [181]	79 [172]
Heat exchanger outlet (TH3)			44 [111]		44 [111]	44 [111]
Accumulator inlet			7 [45]		7 [45]	7 [45]
Accumulator outlet			7 [45]		7 [45]	7 [45]
SCC outlet (TH6)			22 [72]		22 [72]	22 [72]
Compressor inlet			19 [66]		19 [66]	19 [66]
Compressor shell bottom			47 [117]		42 [108]	42 [108]
Indoor unit		LEV inlet	17 [63]			
		Heat exchanger outlet	4 [39]			

Operation				Outdoor unit model		
				PUHY-EP850YSHM-A1		
				PUHY-EP250YHM-A	PUHY-EP300YHM-A	PUHY-EP300YHM-A
Operating conditions	Ambient temperature	Indoor	DB/WB	27°C/19°C [81°F/66°F]		
		Outdoor		35°C/ - [95°F/ -]		
	Indoor unit	No. of connected units	Unit	6		
		No. of units in operation		6		
		Model		140/140/140/140/140/140		
	Piping	Main pipe	m [ft]	5 [16-3/8]		
		Branch pipe		10 [32-3/4]		
		Total pipe length		65 [213-1/4]		
	Fan speed		-	Hi		
	Amount of refrigerant		kg [lbs-oz]	48.6 [107]		
Outdoor unit	Electric current		A	37.8		
	Voltage		V	400		
	Compressor frequency		Hz	65	74	74
LEV opening	Indoor unit		Pulse	395/395/395/395/395/395		
	SC (LEV1)			116	130	130
	LEV2			1400	1400	1400
Pressure	High pressure (after O/S)/low pressure (before accumulator)		MPa [psi]	2.76/0.86 [400/125]	2.63/0.84 [382/122]	2.63/0.84 [382/122]
	Temp. of each section	Outdoor unit	Discharge (TH4)	°C [°F]	80 [174]	79 [172]
Heat exchanger outlet (TH3)			44 [111]		44 [111]	44 [111]
Accumulator inlet			7 [45]		7 [45]	7 [45]
Accumulator outlet			7 [45]		7 [45]	7 [45]
SCC outlet (TH6)			24 [75]		22 [72]	22 [72]
Compressor inlet			19 [66]		19 [66]	19 [66]
Compressor shell bottom			38 [100]		42 [108]	42 [108]
Indoor unit		LEV inlet	17 [63]			
		Heat exchanger outlet	4 [39]			

Operation				Outdoor unit model		
				PUHY-EP900YSHM-A		
				PUHY-EP300YHM-A	PUHY-EP300YHM-A	PUHY-EP300YHM-A
Operating conditions	Ambient temperature	Indoor	DB/WB	27°C/19°C [81°F/66°F]		
		Outdoor		35°C/ - [95°F/ -]		
	Indoor unit	No. of connected units	Unit	7		
		No. of units in operation		7		
		Model		100/100/100/125/125/125/125		
	Piping	Main pipe	m [ft]	5 [16-3/8]		
		Branch pipe		10 [32-3/4]		
		Total pipe length		75 [246-1/16]		
	Fan speed		-	Hi		
	Amount of refrigerant		kg [lbs-oz]	50.2 [111]		
Outdoor unit	Electric current		A	39.8		
	Voltage		V	400		
	Compressor frequency		Hz	74	74	74
LEV opening	Indoor unit		Pulse	325/325/325/387/387/387/387		
	SC (LEV1)			130	130	130
	LEV2			1400	1400	1400
Pressure	High pressure (after O/S)/low pressure (before accumulator)		MPa [psi]	2.63/0.84 [382/122]	2.63/0.84 [382/122]	2.63/0.84 [382/122]
	Temp. of each section	Outdoor unit	Discharge (TH4)	°C [°F]	79 [172]	79 [172]
Heat exchanger outlet (TH3)			44 [111]		44 [111]	44 [111]
Accumulator inlet			7 [45]		7 [45]	7 [45]
Accumulator outlet			7 [45]		7 [45]	7 [45]
SCC outlet (TH6)			22 [72]		22 [72]	22 [72]
Compressor inlet			19 [66]		19 [66]	19 [66]
Compressor shell bottom			42 [108]		42 [108]	42 [108]
Indoor unit		LEV inlet	17 [63]			
		Heat exchanger outlet	4 [39]			

(2) Heating operation

Operation				Outdoor unit model		
				PUHY-EP700YSHM-A		
				PUHY-EP200YHM-A	PUHY-EP200YHM-A	PUHY-EP300YHM-A
Operating conditions	Ambient temperature	Indoor	DB/WB	20°C / - [68°F / -]		
		Outdoor		7°C/6°C [45°F/43°F]		
	Indoor unit	No. of connected units	Unit	6		
		No. of units in operation		6		
		Model		100/100/125/125/125/125		
	Piping	Main pipe	m [ft]	5 [16-3/8]		
		Branch pipe		10 [32-3/4]		
		Total pipe length		65 [213-1/4]		
	Fan speed		-	Hi		
	Amount of refrigerant		kg [lbs-oz]	40.6 [90]		
Outdoor unit	Electric current		A	32		
	Voltage		V	400		
	Compressor frequency		Hz	51	51	80
LEV opening	Indoor unit		Pulse	332/332/406/406/406/406		
	SC (LEV1)			0		
	LEV2			1400	1400	1400
Pressure	High pressure (after O/S)/low pressure (before accumulator)		MPa [psi]	2.81/0.68 [408/99]	2.81/0.68 [408/99]	2.78/0.62 [403/90]
	Temp. of each section	Outdoor unit	Discharge (TH4)	°C [°F]	82 [180]	82 [180]
Heat exchanger outlet (TH3)			0 [32]		0 [32]	0 [32]
Accumulator inlet			0 [32]		0 [32]	0 [32]
Accumulator outlet			0 [32]		0 [32]	0 [32]
Compressor inlet			0 [32]		0 [32]	0 [32]
Compressor shell bottom			42 [108]		42 [108]	43 [109]
Indoor unit		LEV inlet	35 [95]			
		Heat exchanger outlet	80 [176]			

Operation				Outdoor unit model		
				PUHY-EP750YSHM-A1		
				PUHY-EP200YHM-A	PUHY-EP250YHM-A	PUHY-EP300YHM-A
Operating conditions	Ambient temperature	Indoor	DB/WB	20°C / - [68°F / -]		
		Outdoor		7°C/6°C [45°F/43°F]		
	Indoor unit	No. of connected units	Unit	6		
		No. of units in operation		6		
		Model		125/125/125/125/125/125		
	Piping	Main pipe	m [ft]	5 [16-3/8]		
		Branch pipe		10 [32-3/4]		
		Total pipe length		65 [213-1/4]		
	Fan speed		-	Hi		
	Amount of refrigerant		kg [lbs-oz]	45.1 [99]		
Outdoor unit	Electric current		A	35.5		
	Voltage		V	400		
	Compressor frequency		Hz	51	69	80
LEV opening	Indoor unit		Pulse	332/332/406/406/406/406		
	SC (LEV1)			0		
	LEV2			1400	1400	1400
Pressure	High pressure (after O/S)/low pressure (before accumulator)		MPa [psi]	2.81/0.68 [408/99]	2.85/0.62 [413/90]	2.78/0.62 [403/90]
	Temp. of each section	Outdoor unit	Discharge (TH4)	°C [°F]	82 [180]	82 [180]
Heat exchanger outlet (TH3)			0 [32]		0 [32]	0 [32]
Accumulator inlet			0 [32]		0 [32]	0 [32]
Accumulator outlet			0 [32]		0 [32]	0 [32]
Compressor inlet			0 [32]		0 [32]	0 [32]
Compressor shell bottom			42 [108]		42 [108]	43 [109]
Indoor unit		LEV inlet	39 [102]			
		Heat exchanger outlet	80 [176]			

Operation				Outdoor unit model		
				PUHY-EP800YSHM-A		
				PUHY-EP200YHM-A	PUHY-EP300YHM-A	PUHY-EP300YHM-A
Operating conditions	Ambient temperature	Indoor	DB/WB	20°C / - [68°F / -]		
		Outdoor		7°C/6°C [45°F/43°F]		
	Indoor unit	No. of connected units	Unit	6		
		No. of units in operation		6		
		Model		125/125/125/140/140/140		
	Piping	Main pipe	m [ft]	5 [16-3/8]		
		Branch pipe		10 [32-3/4]		
		Total pipe length		65 [213-1/4]		
	Fan speed		-	Hi		
	Amount of refrigerant		kg [lbs-oz]	45.1 [99]		
Outdoor unit	Electric current		A	37.5		
	Voltage		V	400		
	Compressor frequency		Hz	51	80	80
LEV opening	Indoor unit		Pulse	406/406/406/414/414/414		
	SC (LEV1)			0		
	LEV2			1400	1400	1400
Pressure	High pressure (after O/S)/low pressure (before accumulator)		MPa [psi]	2.81/0.68 [408/99]	2.78/0.62 [403/90]	2.78/0.62 [403/90]
	Temp. of each section	Outdoor unit	Discharge (TH4)	°C [°F]	82 [180]	82 [180]
Heat exchanger outlet (TH3)			0 [32]		0 [32]	0 [32]
Accumulator inlet			0 [32]		0 [32]	0 [32]
Accumulator outlet			0 [32]		0 [32]	0 [32]
Compressor inlet			0 [32]		0 [32]	0 [32]
Compressor shell bottom			42 [108]		43 [109]	43 [109]
Indoor unit		LEV inlet	39 [102]			
	Heat exchanger outlet	80 [176]				

Operation				Outdoor unit model		
				PUHY-EP850YSHM-A1		
				PUHY-EP250YHM-A	PUHY-EP300YHM-A	PUHY-EP300YHM-A
Operating conditions	Ambient temperature	Indoor	DB/WB	20°C / - [68°F / -]		
		Outdoor		7°C/6°C [45°F/43°F]		
	Indoor unit	No. of connected units	Unit	6		
		No. of units in operation		6		
		Model		140/140/140/140/140/140		
	Piping	Main pipe	m [ft]	5 [16-3/8]		
		Branch pipe		10 [32-3/4]		
		Total pipe length		65 [213-1/4]		
	Fan speed		-	Hi		
	Amount of refrigerant		kg [lbs-oz]	48.6 [107]		
Outdoor unit	Electric current		A	41		
	Voltage		V	400		
	Compressor frequency		Hz	69	80	80
LEV opening	Indoor unit		Pulse	414/414/414/414/414/414		
	SC (LEV1)			0		
	LEV2			1400	1400	1400
Pressure	High pressure (after O/S)/low pressure (before accumulator)		MPa [psi]	2.85/0.62 [413/90]	2.78/0.62 [403/90]	2.78/0.62 [403/90]
	Temp. of each section	Outdoor unit	Discharge (TH4)	°C [°F]	82 [180]	82 [180]
Heat exchanger outlet (TH3)			0 [32]		0 [32]	0 [32]
Accumulator inlet			0 [32]		0 [32]	0 [32]
Accumulator outlet			0 [32]		0 [32]	0 [32]
Compressor inlet			0 [32]		0 [32]	0 [32]
Compressor shell bottom			42 [108]		43 [109]	43 [109]
Indoor unit		LEV inlet	39 [102]			
		Heat exchanger outlet	80 [176]			

Operation				Outdoor unit model		
				PUHY-EP900YSHM-A		
				PUHY-EP300YHM-A	PUHY-EP300YHM-A	PUHY-EP300YHM-A
Operating conditions	Ambient temperature	Indoor	DB/WB	20°C / - [68°F / -]		
		Outdoor		7°C/6°C [45°F/43°F]		
	Indoor unit	No. of connected units	Unit	7		
		No. of units in operation		7		
		Model		100/100/100/125/125/125/125		
	Piping	Main pipe	m [ft]	5 [16-3/8]		
		Branch pipe		10 [32-3/4]		
		Total pipe length		75 [246-1/16]		
	Fan speed		-	Hi		
	Amount of refrigerant		kg [lbs-oz]	50.2 [111]		
Outdoor unit	Electric current		A	44.7		
	Voltage		V	400		
	Compressor frequency		Hz	80	80	80
LEV opening	Indoor unit		Pulse	332/332/332/406/406/406/406		
	SC (LEV1)			0		
	LEV2			1400	1400	1400
Pressure	High pressure (after O/S)/low pressure (before accumulator)		MPa [psi]	2.78/0.62 [403/90]	2.78/0.62 [403/90]	2.78/0.62 [403/90]
	Temp. of each section	Outdoor unit	Discharge (TH4)	°C [°F]	82 [180]	82 [180]
Heat exchanger outlet (TH3)			0 [32]		0 [32]	0 [32]
Accumulator inlet			0 [32]		0 [32]	0 [32]
Accumulator outlet			0 [32]		0 [32]	0 [32]
Compressor inlet			0 [32]		0 [32]	0 [32]
Compressor shell bottom			43 [109]		43 [109]	43 [109]
Indoor unit		LEV inlet	39 [102]			
		Heat exchanger outlet	80 [176]			

IX Troubleshooting

[1] Error Code Lists	181
[2] Responding to Error Display on the Remote Controller.....	184
[3] Investigation of Transmission Wave Shape/Noise.....	245
[4] Troubleshooting Principal Parts.....	248
[5] Refrigerant Leak	268
[6] Compressor Replacement Instructions.....	270
[7] Troubleshooting Using the Outdoor Unit LED Error Display.....	272



[1] Error Code Lists

Error Code	Preliminary error code	Error (preliminary) detail code	Error code definition	Searched unit				Notes
				Outdoor unit	Indoor unit	LOSSNAY	Remote controller	
0403	4300 4305	01 05 (Note)	Serial communication error	O				
0900	-	-	Test run			O		
1102	1202	-	Discharge temperature fault	O				
1301	-	-	Low pressure fault	O				
1302	1402	-	High pressure fault	O				
1500	1600	-	Refrigerant overcharge	O				
-	1605	-	Preliminary suction pressure fault	O				
2500	-	-	Drain sensor submergence		O			
2502	-	-	Drain pump fault		O			
2503	-	-	Drain sensor (Thd) fault		O	O		
2600	-	-	Water leakage			O		
2601	-	-	Water supply cutoff			O		
4102	4152	-	Open phase	O				
4106	-	-	Transmission power supply fault	O				
4115	-	-	Power supply signal sync error	O				
4116	-	-	RPM error/Motor error		O	O		
4220 4225 (Note)	4320 4325 (Note)	[108]	Abnormal bus voltage drop	O				
		[109]	Abnormal bus voltage rise	O				
		[111]	Logic error	O				
		[131]	Low bus voltage at startup	O				
4230	4330	-	Heatsink overheat protection	O				
4240	4340	-	Overload protection	O				
4250 4255 (Note)	4350 4355 (Note)	[101]	IPM error	O				
		[104]	Short-circuited IPM/Ground fault	O				
		[105]	Overcurrent error due to short-circuited motor	O				
		[106]	Instantaneous overcurrent	O				
		[107]	Overcurrent	O				
4260	-	-	Heatsink overheat protection at startup	O				
5101	1202	-	Temperature sensor fault	Return air temperature (TH21)		O		
				OA processing unit inlet temperature (TH4)			O	

Error Code	Preliminary error code	Error (preliminary) detail code	Error code definition		Searched unit				Notes
					Outdoor unit	Indoor unit	LOSSNAY	Remote controller	
5102	1217	-	Temperature sensor fault	Indoor unit pipe temperature (TH22)		O			
				OA processing unit pipe temperature (TH2)			O		
				HIC bypass circuit outlet temperature (TH2)	O				
5103	1205	00	Temperature sensor fault	Indoor unit gas-side pipe temperature (TH23)		O			
				OA processing unit gas-side pipe temperature (TH3)			O		
				Pipe temperature at heatexchanger outlet (TH3)	O				
5104	1202	-	Temperature sensor fault	OA processing unit intake air temperature (TH1)			O		
				Outside temperature (TH24)		O			Detectable only by the All-Fresh type indoor units
				Outdoor unit discharge temperature (TH4)	O				
5105	1204	-	Temperature sensor fault	Accumulator inlet temperature (TH5)	O				
5106	1216	-	Temperature sensor fault	HIC circuit outlet temperature (TH6)	O				
5107	1221	-	Temperature sensor fault	Outside temperature (TH7)	O				
5110	1214	01	Temperature sensor fault	Heatsink temperature (THHS)	O				
5201	-	-	High-pressure sensor fault (63HS1)		O				
5301	4300	[115]	ACCT sensor fault		O				
		[117]	ACCT sensor circuit fault		O				
		[119]	Open-circuited IPM/Loose ACCT connector		O				
		[120]	Faulty ACCT wiring		O				
5701	-	-	Loose float switch connector			O			
6201	-	-	Remote controller board fault (nonvolatile memory error)					O	
6202	-	-	Remote controller board fault (clock IC error)					O	
6600	-	-	Address overlap		O	O	O	O	
6601	-	-	Polarity setting error		O				
6602	-	-	Transmission processor hardware error		O	O	O	O	
6603	-	-	Transmission line bus busy error		O	O	O	O	
6606	-	-	Communication error between device and transmission processors		O	O	O	O	
6607	-	-	No ACK error		O	O	O	O	

Error Code	Preliminary error code	Error (preliminary) detail code	Error code definition	Searched unit				Notes
				Outdoor unit	Indoor unit	LOSSNAY	Remote controller	
6608	-	-	No response error	○	○	○	○	
6831	-	-	MA controller signal reception error (No signal reception)		○		○	
6832	-	-	MA remote controller signal transmission error (Synchronization error)		○		○	
6833	-	-	MA remote controller signal transmission error (Hardware error)		○		○	
6834	-	-	MA controller signal reception error (Start bit detection error)		○		○	
7100	-	-	Total capacity error	○				
7101	-	-	Capacity code setting error	○	○	○		
7102	-	-	Wrong number of connected units	○				
7105	-	-	Address setting error	○				
7106	-	-	Attribute setting error			○		
7110	-	-	Connection information signal transmission/reception error	○				
7111	-	-	Remote controller sensor fault		○	○		
7113	-	-	Function setting error	○				
7117	-	-	Model setting error	○				
7130	-	-	Incompatible unit combination	○				

Note

The last digit in the check error codes in the 4000's and 5000's and two-digit detail codes indicate if the codes apply to compressor inverter or fan inverter.

Example

Code 4225 (detail code 108): Bus voltage drop in the fan inverter system

Code 4230 : Heatsink overheat protection in the compressor inverter system

The last digit	Inverter system
0 or 1	Compressor inverter system
5	Fan inverter system

[2] Responding to Error Display on the Remote Controller

1. Error Code

0403

Serial communication error

2. Error definition and error detection method

Serial communication error between the control board and the INV board on the compressor, and between the control board and the Fan board

Detail code 01: Between the control board and the INV board

Detail code 05: Between the control board and the Fan board

3. Cause, check method and remedy

(1) Faulty wiring

Check the following wiring connections.

1) Between Control board and Fan board

Control board	FAN board
CN2	CN21
CN4	CN5
CN332	CN18V

2) Between Fan board and INV board

FAN board	INV board
CN22	CN2 CN5V
CN4	CN4

(2) INV board failure, Fan board failure and Control board failure

Replace the INV board or the Fan board or control board when the power turns on automatically, even if the power source is reset.

Note

Refer to section -6- "Inverter" under part [4] Troubleshooting Principal Parts for error codes related to the inverter.(page 258)

1. Error Code

1102

Discharge temperature fault

2. Error definition and error detection method

- 1) If the discharge temperature of 120 °C [248°F] or more is detected during the above operation (the first detection), the outdoor unit stops once, turns to anti-restart mode for 3 minutes, and restarts after 3 minutes automatically.
- 2) If the discharge temperature of 120° C [248°F] or more is detected again (the second detection) within 30 minutes after the second stop of the outdoor unit described above, the mode will be changed to 3 - minute restart mode, then the outdoor unit will restart in 3 minutes.
- 3) If the discharge temperature of 120°C [248°F] or more is detected (the 30th detection) within 30 minutes after the 29th Stop-page of the outdoor unit described above, the outdoor unit will make an error stop, and the error code "1102" will be displayed.
- 4) If the discharge temperature of 120°C [248°F] or more is detected more than 30 minutes after the previous stop of the outdoor unit, the detection is regarded as the first detection, and the operation described in step 1 above will start.
- 5) For 30 minutes after the stop (the first stop or the second stop) of the outdoor unit, preliminary errors will be displayed on the LED display.

3. Cause, check method and remedy

Cause	Check method and remedy
(1) Gas leak, gas shortage	Refer to the page on refrigerant amount evaluation.(page 109)
(2) Overload operation	Check operating conditions and operation status of indoor/ outdoor units.
(3) LEV failure on the indoor unit (4) Outdoor unit LEV1 actuation failure Outdoor unit LEV2a, b actuation failure	Perform a cooling or heating operation to check the operation. Cooling: Indoor unit LEV LEV1 LEV2a,b Heating: Indoor unit LEV LEV2a,b Refer to the section on troubleshooting the LEV.(page 252)
(5) Closed refrigerant service valve	Confirm that the refrigerant service valve is fully open.
(6) Outdoor fan (including fan parts) failure, motor failure, or fan controller malfunction Rise in discharge temp. by low pressure drawing for (3) - (6).	Check the fan on the outdoor unit. Refer to the section on troubleshooting the outdoor unit fan.(page 251)
(7) Gas leak between low and high pressures (4-way valve failure, Compressor failure, Solenoid valve (SV1a) failure)	Perform a cooling or heating operation and check the operation.
(8) Thermistor failure (TH4)	Check the thermistor resistor.(page 205)
(9) Input circuit failure on the controller board thermistor	Check the inlet air temperature on the LED monitor.

1. Error Code

1301

Low pressure fault

2. Error definition and error detection method

When starting the compressor from Stop Mode for the first time if low pressure reads 0.098MPa [14psi] immediately before start-up, the operation immediately stops.

3. Cause, check method and remedy

Cause	Check method and remedy
(1) Inner pressure drop due to a leakage.	Refer to the section on troubleshooting the low pressure sensor.(page 249)
(2) Low pressure sensor failure	
(3) Short-circuited pressure sensor cable due to torn outer rubber	
(4) A pin on the male connector is missing.	
(5) Disconnected wire	
(6) Failure of the low pressure input circuit on the controller board	

1. Error Code

1302

High pressure fault 1 (Outdoor unit)

2. Error definition and error detection method

- 1) If the pressure of 3.78MPa [548psi] or higher is detected by the pressure sensor during operation (the first detection), the outdoor stops once, turns to antirestart mode for 3 minutes, and restarts after 3 minutes automatically.
- 2) If the pressure of 3.78MPa [548psi] or higher is detected by the pressure sensor again (the second detection) within 30 minutes after the first stop of the outdoor unit, the outdoor unit stops once, turns to anti-restart mode for 3 minutes, and restarts after 3 minutes automatically.
- 3) If the pressure of 3.87MPa [561psi] or higher is detected by the pressure sensor (the third detection) within 30 minutes of the second stop of the outdoor unit, the outdoor unit will make an error stop, and the error code "1302" will be displayed.
- 4) If the pressure of 3.78MPa [548psi] or higher is detected more than 30 minutes after the stop of the outdoor unit, the detection is regarded as the first detection, and the operation described in step 1 above will start.
- 5) For 30 minutes after the stop of the outdoor unit, preliminary errors will be displayed on the LED display.
- 6) The outdoor unit makes an error stop immediately when not only the pressure sensor but also the pressure switch detects $4.15^{+0,-0.15}$ MPa [$601^{+0,-22}$ psi]
- 7) Open phase due to unstable power supply voltage may cause the pressure switch to malfunction or cause the units to come to an abnormal stop.

3. Cause, check method and remedy

Cause	Check method and remedy
(1) Indoor unit LEV2a, b actuation failure -> Cooling Indoor unit LEV actuation failure -> Heating	Perform a cooling or heating operation to check the operation. Cooling: Indoor unit LEV2a, b Heating: Indoor unit LEV Refer to the section on troubleshooting the LEV.(page 252)
(2) Closed refrigerant service valve	Confirm that the refrigerant service valve is fully open.
(3) Short cycle on the indoor unit side	Check the indoor units for problems and correct them, if any.
(4) Clogged filter on the indoor unit	
(5) Reduced air flow due to dirty fan on the indoor unit fan	
(6) Dirty heat exchanger of the indoor unit	
(7) Indoor fan (including fan parts) failure or motor failure Rise in high pressure caused by lowered condensing capacity in heating operation for (2) - (7).	Check the outdoor units for problems and correct them, if any.
(8) Short cycle on the outdoor unit	
(9) Dirty heat exchanger of the outdoor unit	Check the fan on the outdoor unit. Refer to the section on troubleshooting the outdoor unit fan.(page 251)
(10) Outdoor fan (including fan parts) failure, motor failure, or fan controller malfunction Rise in discharge temp. by low pressure drawing for (8) - (10).	
(11) Solenoid valve (SV1a) malfunction (The by-pass valve (SV1a) can not control rise in high pressure).	Refer to the section on troubleshooting the solenoid valve.(page 250)
(12) Thermistor failure (TH3, TH7)	Check the thermistor resistor.(page 205)
(13) Pressure sensor failure	Refer to the page on the troubleshooting of the high pressure sensor. (page 248)
(14) Failure of the thermistor input circuit and pressure sensor input circuit on the controller board	Check the temperature and the pressure of the sensor with LED monitor.
(15) Thermistor mounting problem (TH3, TH7)	Check the temperature and the pressure of the sensor with LED monitor.
(16) Disconnected male connector on the pressure switch (63H1) or disconnected wire	
(17) Voltage drop caused by unstable power supply voltage	Check the input voltage at the power supply terminal block (TB1).

1. Error Code

1302

High pressure fault 2 (Outdoor unit)

2. Error definition and error detection method

If the pressure of 0.098MPa [14psi] or lower is registered on the pressure sensor immediately before start-up, it will trigger an abnormal stop, and error code "1302" will be displayed.

3. Cause, check method and remedy

	Cause	Check method and remedy
(1)	Inner pressure drop due to a leakage.	Refer to the page on the troubleshooting of the high pressure sensor.(page 248)
(2)	Pressure sensor failure	
(3)	Shorted-circuited pressure sensor cable due to torn outer rubber	
(4)	A pin on the male connector on the pressure sensor is missing or contact failure	
(5)	Disconnected pressure sensor cable	
(6)	Failure of the pressure sensor input circuit on the controller board	

1. Error Code

1500

Refrigerant overcharge

2. Error definition and error detection method

An error can be detected by the discharge temperature superheat.

- 1) If the formula " $TdSH \leq 10^{\circ}C [18^{\circ}F]$ " is satisfied during operation (first detection), the outdoor unit stops, goes into the 3-minute restart mode, and starts up in three minutes.
- 2) If the formula " $TdSH \leq 10^{\circ}C [18^{\circ}F]$ " is satisfied again within 30 minutes of the fifth stoppage of the outdoor unit (sixth detection), the unit comes to an abnormal stop, and the error code "1500" appears.
- 3) If the formula " $TdSH \leq 10^{\circ}C [18^{\circ}F]$ " is satisfied 30 minutes or more after the first stoppage of the outdoor unit, the same sequence as Item "1 above (first detection) is followed.
- 4) For 30 minutes after the stop of the outdoor unit, preliminary errors will be displayed on the LED display.

3. Cause, check method and remedy

	Cause	Check method and remedy
(1)	Overcharged refrigerant	Refer to the page on refrigerant amount evaluation.(page 109)
(2)	Thermistor input circuit failure on the control board	Check the temperature and pressure readings on the sensor that are displayed on the LED monitor.
(3)	Faulty mounting of thermistor (TH4)	Check the temperature and pressure readings on the thermistor that are displayed on the LED monitor.
(4)	Outdoor unit LEV2a, b actuation failure -> Heating	Refer to the section on troubleshooting the LEV. (page 252)

1. Error Code

2500

Drain sensor submergence (Models with a drain sensor)

2. Error definition and error detection method

- 1) If an immersion of the drain sensor in the water is detected while the unit is in any mode other than the Cool/Dry mode and when the drain pump goes from OFF to ON, this condition is considered preliminary water leakage. While this error is being detected, humidifier output cannot be turned on. (Applicable to the units manufactured in or after October 2006)
- 2) If the immersion of the sensor in the water is detected four consecutive times at an hour interval, this is considered water leakage, and "2500" appears on the monitor.
- 3) Detection of water leakage is also performed while the unit is stopped.
- 4) Preliminary water leakage is cancelled when the following conditions are met:
 - One hour after the preliminary water leakage was detected, it is not detected that the drain pump goes from OFF to ON.
 - The operation mode is changed to Cool/Dry.
 - The liquid pipe temperature minus the inlet temperature is -10°C [-18°F] or less.

3. Cause, check method and remedy

Cause	Check method and remedy
(1) Drain water drainage problem • Clogged drain pump • Clogged drain piping • Backflow of drain water from other units	Check for proper drainage.
(2) Adhesion of water drops to the drain sensor • Trickling of water along the lead wire • Rippling of drain water caused by filter clogging	1) Check for proper lead wire installation. 2) Check for clogged filter.
(3) Failure of the relay circuit for the solenoid valve	Replace the relay.
(4) Indoor unit control board failure • Drain sensor circuit failure	If the above item checks out OK, replace the indoor unit control board.

1. Error Code

2500

Drain sensor submergence (Models with a float switch)

2. Error definition and error detection method

- 1) If an immersion of the float switch in the water is detected while the unit is in any mode other than the Cool/Dry mode and when the drain pump goes from OFF to ON, this condition is considered preliminary water leakage. While this error is being detected, humidifier output cannot be turned on.
- 2) If the drain pump turns on within one hour after preliminary water leakage is detected and the above-mentioned condition is detected two consecutive times, water leakage error water leakage is detected, and "2500" appears on the monitor.
- 3) Detection of water leakage is also performed while the unit is stopped.
- 4) Preliminary water leakage is cancelled when the following conditions are met:
 - One hour after the preliminary water leakage was detected, it is not detected that the drain pump goes from OFF to ON.
 - The operation mode is changed to Cool/Dry.
 - The liquid pipe temperature minus the inlet temperature is - 10°C [-18°F] or less.

3. Cause, check method and remedy

Cause	Check method and remedy
(1) Drain water drainage problem •Clogged drain pump •Clogged drain piping •Backflow of drain water from other units	Check for proper drainage.
(2) Stuck float switch Check for slime in the moving parts of the float switch.	Check for normal operation of the float switch.
(3) Float switch failure	Check the resistance with the float switch turned on and turned off.

<Reference>

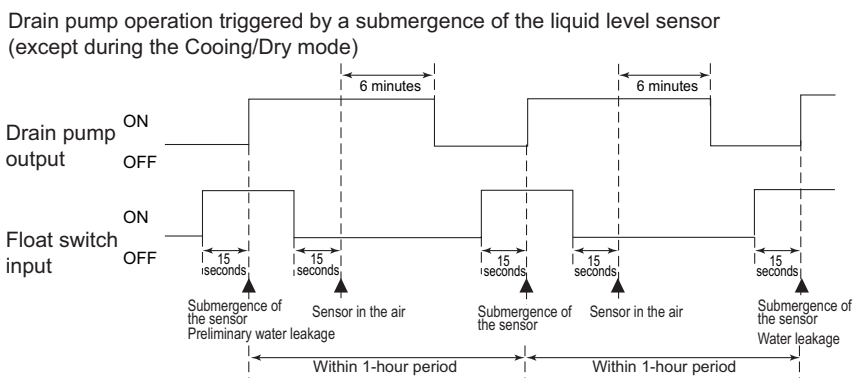

1. Error Code

2502

Drain pump fault (Models with a drain sensor)

2. Error definition and error detection method

- 1) Make the drain sensor thermistor self-heat. If the temperature rise is small, it is interpreted that the sensor is immersed in water. This condition is considered to be a preliminary error, and the unit goes into the 3-minute restart delay mode.
- 2) If another episode of the above condition is detected during the preliminary error, this is considered a drain pump error, and "2502" appears on the monitor.
- 3) This error is always detected while the drain pump is in operation.
- 4) The following criteria are met when the criteria for the forced stoppage of outdoor unit (system stoppage) are met.
 - *"Liquid pipe temperature - inlet temperature $\leq -10^{\circ}\text{C}$ [-18°F] " has been detected for 30 minutes.
 - *The immersion of drain sensor is detected 10 consecutive times.
 - *The conditions that are listed under items 1) through 3) above are always met before the criteria for the forced stoppage of the outdoor unit.
- 5) The indoor unit that detected the conditions that are listed in item 4) above brings the outdoor unit in the same refrigerant circuit to an error stop (compressor operation prohibited), and the outdoor unit brings all the indoor units in the same refrigerant circuit that are in any mode other than Fan or Stop to an error stop. "2502" appears on the monitor of the units that came to an error stop.
- 6) Forced stoppage of the outdoor unit
 Detection timing: The error is detected whether the unit is in operation or stopped.
- 7) Ending criteria for the forced stoppage of outdoor unit
 Power reset the indoor unit that was identified as the error source and the outdoor unit that is connected to the same refrigerant circuit.
 Forced stoppage of the outdoor unit cannot be cancelled by stopping the unit via the remote controller.
 (Note) Items 1) - 3) and 4) - 7) are detected independently from each other.

Note

The address and attribute that appear on the remote controller are those of the indoor unit (or OA processing unit) that caused the error.

3. Cause, check method and remedy

Cause	Check method and remedy
(1) Drain pump failure	Check for proper functioning of the drain pump.
(2) Drain water drainage problem •Clogged drain pump •Clogged drain piping	Check for proper drainage.
(3) Adhesion of water drops to the drain sensor •Trickling of water along the lead wire •Rippling of drain water caused by filter clogging	1) Check for proper lead wire installation. 2) Check for clogged filter.
(4) Indoor unit control board failure •Drain pump drive circuit failure •Drain heater output circuit failure	If the above item checks out OK, replace the indoor unit control board.
(5) Items (1) through (4) above and an indoor unit electronic valve closure failure (leaky valve) occurred simultaneously.	Check the solenoid valves on the indoor unit for leaks.

1. Error Code

2502

Drain pump fault (Models with a float switch)

2. Error definition and error detection method

- 1) The immersion of sensor tip in water is detected by the ON/OFF signal from the float switch.
 - *Submergence of the sensor
When it is detected that the float switch has been ON for 15 seconds, it is interpreted that the sensor tip is immersed in water.
 - *Sensor in the air
When it is detected that the float switch has been OFF for 15 seconds, it is interpreted that the sensor tip is not immersed in water.
- 2) If it is detected that the float switch has been ON for 3 minutes after the immersion of the sensor tip was detected, this is considered a drain pump failure, and "2502" appears on the monitor.
 - *The total time it takes for this error to be detected is 3 minutes and 15 seconds, including the time it takes for the first immersion of the sensor tip to be detected.
- 3) Detection of drain pump failure is performed while the unit is stopped.
- 4) The following criteria are met when the criteria for the forced stoppage of outdoor unit (system stoppage) are met.
 - *"Liquid pipe temperature - inlet temperature $\leq -10^{\circ}\text{C}$ [-18°F]" has been detected for 30 minutes.
 - *It is detected by the float switch that the sensor tip has been immersed in water for 15 minutes or more.
 - *The conditions that are listed under items 1) through 3) above are always met before the criteria for the forced stoppage of the outdoor unit.
- 5) The indoor unit that detected the conditions that are listed in item 4) above brings the outdoor unit in the same refrigerant circuit to an error stop (compressor operation prohibited), and the outdoor unit brings all the indoor units in the same refrigerant circuit that are in any mode other than Fan or Stop to an error stop.
- 6) Forced stoppage of the outdoor unit
Detection timing: The error is detected whether the unit is in operation or stopped.
This error is detected whether the unit is in operation or stopped.
- 7) Ending criteria for the forced stoppage of outdoor unit
Power reset the indoor unit that was identified as the error source and the outdoor unit that is connected to the same refrigerant circuit.
Forced stoppage of the outdoor unit cannot be cancelled by stopping the unit via the remote controller.
(Note) Items 1) - 3) and 4) - 7) are detected independently from each other.

Note

The address and attribute that appear on the remote controller are those of the indoor unit (or OA processing unit) that caused the error.

3. Cause, check method and remedy

Cause	Check method and remedy
(1) Drain pump failure	Check for proper functioning of the drain pump mechanism
(2) Drain water drainage problem •Clogged drain pump •Clogged drain piping	Check for proper drainage.
(3) Stuck float switch Check for slime in the moving parts of the float switch.	Check for normal operation of the float switch.
(4) Float switch failure	Check the resistance with the float switch turned on and turned off.
(5) Indoor unit control board failure •Drain pump drive circuit failure •Float switch input circuit failure	Replace indoor unit control board.
(6) Items (1) through (5) above and an indoor unit electronic valve closure failure (leaky valve) occurred simultaneously.	Check the solenoid valves on the indoor unit for leaks.

1. Error Code

2503

Drain sensor (Thd) fault

2. Error definition and error detection method

- If the open or short circuit of the thermistor has been detected for 30 seconds, this condition is considered to be a preliminary error, and the unit goes into the 3-minute restart delay mode.
- If another episode of the above condition is detected during the preliminary error, this is considered a drain sensor error.(If the short or open circuit of the thermistor is no longer detected, normal operation will be restored in 3 minutes.)
- This error is detected when one of the following conditions are met.
 - *During Cool/Dry operation
 - *Liquid pipe temperature minus inlet temperature is equal to or smaller than - 10°C [-18°F] (except during the defrost cycle)
 - *When the liquid temperature thermistor or suction temperature thermistor or short or open circuited.
 - *Drain pump is in operation.
 - *One hour has elapsed since the drain sensor went off.
 - Short: 90°C [194 °F] or above
 - Open: - 20°C [-4 °F] or below

3. Cause, check method and remedy

Cause	Check method and remedy
(1) Faulty connector (CN31) insertion.	1) Check for connector connection failure. Reinsert the connector, restart the operation, and check for proper operation.
(2) Broken or semi-broken thermistor wire	2) Check for a broken thermistor wire.
(3) Thermistor failure	3) Check the resistance of the thermistor. 0°C[32 °F]:6.0kΩ 10°C[50 °F]:3.9kΩ 20°C[68°F]:2.6kΩ 30°C[86°F]:1.8kΩ 40°C[104 °F]:1.3kΩ
(4) Indoor unit control board (error detection circuit) failure	4) Replace the indoor unit control board if the problem recurs when the unit is operated with the No.-1 and No.-2 pins on the drain sensor connector (CN31) being short-circuited. If the above item checks out OK, there are no problems with the drain sensor. Turn off the power and turn it back on.

1. Error Code

2600

Water leakage

2. Cause, check method and remedy

Check that water does not leak from the pipes in such as the humidifier.

1. Error Code

2601

Water supply cutoff

2. Cause, check method and remedy

Cause		Check method and remedy
(1)	The water tank of the humidifier is empty.	Check the amount of supply water. Check for the solenoid valve and for the connection.
(2)	The solenoid valve for humidification is OFF.	Check the connector.
(3)	Disconnected float switch	Check the connecting part.
(4)	Poor operation of float switch	Check for the float switch.
(5)	Frozen water tank	Turn off the power source of the water tank to defrost, and turn it on again.

1. Error Code

4102

Open phase

2. Error definition and error detection method

- An open phase of the power supply (L1 phase, N phase) was detected at power on.
- The L3 phase current is outside of the specified range.

Note

The open phase of the power supply may not always be detected if a power voltage from another circuit is applied.

3. Cause, check method and remedy

Cause	Check method and remedy
(1) Power supply problem •Open phase voltage of the power supply •Power supply voltage drop	Check the input voltage to the power supply terminal block TB1.
(2) Noise filter problem •Coil problem •Circuit board failure	<ul style="list-style-type: none"> •Check the coil connections. •Check for coil burnout. •Confirm that the voltage at the CN3 connector is 198 V or above.
(3) Wiring failure	<p>Confirm that the voltage at the control board connector CNAC is 198 V or above. If the voltage is below 198V, check the wiring connection between the noise filter board CN3, noise filter board CN2 and control board CNAC. Confirm that the wiring between noise filter TB23 and INV board SC-L3 is put through CT3.</p>
(4) Blown fuse	<p>Check for a blown fuse (F01) on the control board. ->If a blown fuse is found, check for a short-circuiting or earth fault of the actuator.</p>
(5) CT3 failure	Replace the inverter if this problem is detected after the compressor has gone into operation.
(6) Control board failure	Replace the control board if none of the above is causing the problem.

1. Error Code

4106

<Transmission power supply fault Error detail code FF (Outdoor unit)>

2. Error definition and error detection method

Transmission power output failure

3. Cause

- 1) Wiring failure
- 2) Transmission power supply cannot output voltage because overcurrent was detected.
- 3) Voltage cannot be output due to transmission power supply problem.
- 4) Transmission voltage detection circuit failure

4. Check method and remedy

Check the items in IX [4] -7- (2) Troubleshooting transmission power circuit of outdoor unit on all outdoor units in the same refrigerant circuit.(page 267)

<Transmission power supply fault other than error detail code FF (Outdoor unit)>

2. Error definition and error detection method

Transmission power reception failure

3. Cause

One of the outdoor units stopped supplying power, but no other outdoor units start supplying power.

4. Check method and remedy

Check the items in IX [4] -7- (2) Troubleshooting transmission power circuit of outdoor unit on all outdoor units in the same refrigerant circuit.(page 267)

1. Error Code

4115

Power supply signal sync error

2. Error definition and error detection method

The frequency cannot be determined when the power is switched on.

3. Cause, check method and remedy

Cause		Check method and remedy
(1)	Power supply error	Check the voltage of the power supply terminal block (TB1).
(2)	Noise filter problem •Coil problem •Circuit board failure	•Check the coil connections. •Check for coil burnout. •Confirm that the voltage at the CN3 connector is 198 V or above.
(3)	Faulty wiring	Check fuse F01 on the control board.
(4)	Wiring failure Between noise filter CN3 and noise filter CN2 and control board CNAC	Confirm that the voltage at the control board connector CNAC is 198 V or above.
(5)	Control board failure	If none of the items described above is applicable, and if the trouble reappears even after the power is switched on again, replace the control board.

1. Error Code

4116

RPM error/Motor error

2. Error definition and error detection method

•LOSSNAY

- *The motor keep running even if the power is OFF.
- *The thermal overload relay is ON. (Only for the three-phase model)

•Indoor unit

If detected less than 180rpm or more than 2000rpm, the indoor unit will restart and keep running for 3 minutes.If detected again, the display will appear.

3. Cause, check method and remedy

Cause		Check method and remedy
(1)	Board failure	Replace the board.
(2)	Motor malfunction	Check for the motor and the solenoid switch.
(3)	Solenoid switch malfunction	

1. Error Code

4220
4225

Abnormal bus voltage drop (Detail code 108)

2. Error definition and error detection method

If Vdc 289V or less is detected during Inverter operation. (S/W detection)

3. Cause, check method and remedy

(1) Power supply environment

Check whether the unit makes an instantaneous stop when the detection result is abnormal or a power failure occurs.
Check whether the power voltage (Between L1 and L2, L2 and L3, and L1 and L3) is 342V or less across all phases.

(2) Voltage drop detected

4220

•Check the voltage between the FT-P and FT-N terminals on the INV board while the inverter is stopped and if it is 420 V or above, check the following items.

- 1) Confirm on the LED monitor that the bus voltage is above 289V.

Replace the INV board if it is below 289 V.

- 2) Check the voltage at CN72 on the control board. ->Go to (3).
- 3) Check the noise filter coil connections and for coil burnout.
- 4) Check the wiring connections between the following sections
Between the noise filter board and INV board. Between the INV board and DCL.
Replace 72C if no problems are found.

- 5) Check the IGBT module resistance on the INV board (Refer to the Trouble shooting for IGBT module).

•Check the voltage between the FT-P and FT-N terminals on the INV board while the inverter is stopped and if it is less than 420 V, check the following items.

- 1) Check the coil connections and for coil burnout on the noise filter.
- 2) Check the wiring between the noise filter board and INV board.
- 3) Check the connection to SCP1 and SC-P2 on the INV board.
- 4) Check the in-rush current resistor value.
- 5) Check the 72C resistance value.
- 6) Check the DCL resistance value.

Replace the INV board if no problems are found.

4225

•Check the voltage at CNVDC on the Fan board while the inverter is stopped and if it is 420 V or above, check the following items.

- 1) Check the voltage at CN72 on the control board. ->Go to 3).
- 2) Check the noise filter coil connections and for coil burnout.
- 3) Check the wiring connections between the following sections
Between the INV board and the Fan board.
- 4) Check contents 4220

Replace the Fan board if no problems are found.

•Check the voltage at CNVDC on the Fan board while the inverter is stopped and if it is less than 420 V, check the following items.

- 1) Check the state of the wiring connections between the INV board and the Fan board.
- 2) Check contents 4220

Replace the Fan board if no problems are found.

(3) Control board failure

Confirm that DC12V is applied to the connector CN72 on the control board while the inverter is operating. If not, replace the control board.

Note

Refer to section -6- "Inverter" under part [4] Troubleshooting Principal Parts for error codes related to the inverter.(page 258)

1. Error Code

<p>4220 4225</p>

Abnormal bus voltage rise (Detail code 109)

2. Error definition and error detection method

If Vdc ≥ 830V is detected during inverter operation.

3. Cause, check method and remedy

(1) Different voltage connection

Check the power supply voltage on the power supply terminal block (TB1).

(2) INV board failure

If the problem recurs, replace the INV board.

In the case of 4220: INV board

In the case of 4225: Fan board

Note

Refer to section -6- "Inverter" under part [4] Troubleshooting Principal Parts for error codes related to the inverter.(page 258)

1. Error Code

<p>4220 4225</p>

Logic error (Detail code 111)

2. Error definition and error detection method

H/W error

If only the H/W error logic circuit operates, and no identifiable error is detected.

3. Cause, Check method and remedy

In the case of 4220

Cause	Check method and remedy
(1) External noise	
(2) INV board failure	Refer to IX [4] -6- (2) [1].(page 260)

In the case of 4225

Cause	Check method and remedy
(1) External noise	
(2) Fan board failure	Refer to IX [4] -6- (2) [6].(page 262)

Note

Refer to section -6- "Inverter" under part [4] Troubleshooting Principal Parts for error codes related to the inverter.(page 258)

1. Error Code

4220 4225

Low bus voltage at startup (Detail code 131)

2. Error definition and error detection method

When $V_{dc} \leq 160$ V is detected just before the inverter operation.

3. Cause, check method and remedy

(1) Inverter main circuit failure

Same as detail code 108 of 4220 error

Note

Refer to section -6- "Inverter" under part [4] Troubleshooting Principal Parts for error codes related to the inverter.(page 258)

1. Error Code

4230

Heatsink overheat protection

2. Error definition and error detection method

When the heat sink temperature (THHS) remains at or above 105°C [221°F] is detected.

3. Cause, check method and remedy

Cause	Check method and remedy
(1) Fan board failure	Refer to IX [4] -6- (2) [6].(page 262)
(2) Outdoor unit fan failure	Check the outdoor unit fan operation. If any problem is found with the fan operation, check the fan motor. ->Refer to IX [4] -6- (2) [5].(page 261)
(3) Air passage blockage	Check that the heat sink cooling air passage is not blocked
(4) THHS failure	1) Check for proper installation of the INV board IGBT. (Check for proper installation of the IGBT heatsink.) 2) Check the THHS sensor reading on the LED monitor. ->If an abnormal value appears, replace the INV board.

Note

Refer to section -6- "Inverter" under part [4] Troubleshooting Principal Parts for error codes related to the inverter.(page 258)

1. Error Code

4240

Overload protection

2. Error definition and error detection method

If the output current of "(Iac) > I_{max} (Arms)" or "THHS > 100°C [212°F]" is continuously detected for 10 minutes or more during inverter operation.

Model	I _{max} (Arms)
P200, P250, EP200	19
P300 - P450, EP250, EP300	27

3. Cause, check method and remedy

Cause	Check method and remedy
(1) Air passage blockage	Check that the heat sink cooling air passage is not blocked
(2) Power supply environment	Power supply voltage is 342 V or above.
(3) Inverter failure	Refer to IX [4] -6-.(page 258)
(4) Compressor failure	Check that the compressor has not overheated during operation. -> Check the refrigerant circuit (oil return section). Refer to IX [4] -6- (2) [2].(page 260)

Note

Refer to section -6- "Inverter" under part [4] Troubleshooting Principal Parts for error codes related to the inverter.(page 258)

1. Error Code

4250
4255

IPM error (Detail code 101)

2. Error definition and error detection method

In the case of 4250

Overcurrent is detected by the overcurrent detection resistor (RSH) on the INV board.

In the case of 4255

IPM error signal is detected.

3. Cause, check method and remedy

In the case of 4250

Cause	Check method and remedy
(1) Inverter output related	Refer to IX [4] -6- (2) [1] - [4].(page 260) Check the IGBT module resistance value of the INV board, if no problems are found. (Refer to the Trouble shooting for IGBT module)

In the case of 4255

Cause	Check method and remedy
(1) Fan motor abnormality	Refer to IX [4] -6- (2) [5].(page 261)
(2) Fan board failure	Refer to IX [4] -6- (2) [6].(page 262)

Note

Refer to section -6- "Inverter" under part [4] Troubleshooting Principal Parts for error codes related to the inverter.(page 258)

1. Error Code

4250

**Instantaneous overcurrent (Detail code 106)
Overcurrent (Detail code 107)**

2. Error definition and error detection method

P200, P250, and EP200 models
Overcurrent 94 Apeak or 22 Arms and above is detected by the current sensor.
P300 - P450, EP250, and EP300 models
Overcurrent 94 Apeak or 35 Arms and above is detected by the current sensor.

3. Cause, check method and remedy

Cause	Check method and remedy
(1) Inverter output related	Refer to IX [4] -6- (2) [1] - [4].(page 260) Check the IGBT module resistance value of the INV board, if no problems are found. (Refer to the Trouble shooting for IGBT module)

Note

Refer to section -6- "Inverter" under part [4] Troubleshooting Principal Parts for error codes related to the inverter.(page 258)

1. Error Code

**4250
4255**

Short-circuited IPM/Ground fault (Detail code 104)

2. Error definition and error detection method

When IPM/IGBT short damage or grounding on the load side is detected just before starting the inverter.

3. Cause, check method and remedy

In the case of 4250

Cause	Check method and remedy
(1) Grounding fault compressor	Refer to IX [4] -6- (2) [2].(page 260)
(2) Inverter output related	Refer to IX [4] -6- (2) [1] - [4].(page 260)

In the case of 4255

Cause	Check method and remedy
(1) Grounding fault of fan motor	Refer to IX [4] -6- (2) [5].(page 261)
(2) Fan board failure	Refer to IX [4] -6- (2) [6].(page 262)

Note

Refer to section -6- "Inverter" under part [4] Troubleshooting Principal Parts for error codes related to the inverter.(page 258)

1. Error Code

4250 4255

Overcurrent error due to short-circuited motor (Detail code 105)

2. Error definition and error detection method

When a short is detected on the load side just before starting the inverter operation.

3. Cause, Check method and remedy

In the case of 4250

Cause	Check method and remedy
(1) Short - circuited compressor	Refer to IX [4] -6- (2) [2].(page 260)
(2) Output wiring	Check for a short circuit.

In the case of 4255

Cause	Check method and remedy
(1) Short - circuited fan motor	Refer to IX [4] -6- (2) [5].(page 261)
(2) Output wiring	Check for a short circuit.

Note

Refer to section -6- "Inverter" under part [4] Troubleshooting Principal Parts for error codes related to the inverter.(page 258)

1. Error Code

4260

Heatsink overheat protection at startup

2. Error definition and error detection method

The heatsink temperature (THHS) remains at or above 105°C [221°F] for 10 minutes or more at inverter startup.

3. Cause, check method and remedy

Same as 4230 error

1. Error Code

5101

**Return air temperature sensor (TH21) fault (Indoor unit)
Return air temperature sensor (TH4) fault (OA processing unit)**

5102

**Pipe temperature sensor (TH22) fault (Indoor unit)
Pipe temperature sensor (TH2) fault (OA processing unit)**

5103

**Gas-side pipe temperature sensor (TH23) fault (Indoor unit)
Gas-side pipe temperature sensor (TH3) fault (OA processing unit)**

5104

**Intake air temperature sensor (TH1) fault (OA processing unit)
Intake air temperature sensor (TH24) fault (All-fresh (100% outdoor air) type indoor unit)**

2. Error definition and error detection method

•If a short or an open is detected during thermostat ON, the outdoor unit turns to anti-restart mode for 3 minutes. When the error is not restored after 3 minutes (if restored, the outdoor unit runs normally), the outdoor unit makes an error stop.

Short: detectable at 90°C [194°F] or higher

Open: detectable at -40°C [-40°F] or lower

•Sensor error at gas-side cannot be detected under the following conditions.

*During heating operation

*During cooling operation for 3 minutes after the compressor turns on.

3. Cause, check method and remedy

Cause		Check method and remedy
(1)	Thermistor failure	Check the thermistor resistor. 0°C [32°F]: 15 kohm 10°C [50°F]: 9.7 kohm 20°C [68°F]: 6.4 kohm 30°C [86°F]: 4.3 kohm 40°C [104°F]: 3.1 kohm
(2)	Connector contact failure	
(3)	Disconnected wire or partial disconnected thermistor wire	
(4)	Unattached thermistor or contact failure	
(5)	Indoor board (detection circuit) failure	
		Check the connector contact. When no fault is found, the indoor board is a failure.

1. Error Code

5102

HIC bypass circuit outlet temperature sensor (TH2) fault (Outdoor unit)

5103

Heat exchanger outlet temperature sensor (TH3) fault (Outdoor unit)

5104

Discharge temperature sensor (TH4) fault (Outdoor unit)

5105

Accumulator inlet temperature sensor (TH5) fault (Outdoor unit)

5106

HIC circuit outlet temperature sensor (TH6) fault (Outdoor unit)

5107

Outside temperature sensor (TH7) fault (Outdoor unit)

2. Error definition and error detection method

- When a short (high temperature intake) or an open (low temperature intake) of the thermistor is detected (the first detection), the outdoor unit stops, turns to anti-restart mode for 3 minutes, and restarts when the detected temperature of the thermistor.
- When a short or an open is detected again (the second detection) after the first restart of the outdoor unit, the outdoor unit stops, turns to anti-restart mode for 3 minutes, and restarts in 3 minutes when the detected temperature is within the normal range.
- When a short or an open is detected again (the third detection) after the previous restart of the outdoor unit, the outdoor unit makes an error stop.
- When a short or an open of the thermistor is detected just before the restart of the outdoor unit, the outdoor unit makes an error stop, and the error code "5102", "5103", "5104", "5105", "5106" or "5107" will appear.
- During 3-minute antirestart mode, preliminary errors will be displayed on the LED display.
- A short or an open described above is not detected for 10 minutes after the compressor start, during defrost mode, or for 3 minutes after defrost mode.

3. Cause, check method and remedy

	Cause	Check method and remedy
(1)	Thermistor failure	Check thermistor resistance.
(2)	Pinched lead wire	Check for pinched lead wire.
(3)	Torn wire coating	Check for wire coating.
(4)	A pin on the male connector is missing or contact failure	Check connector.
(5)	Disconnected wire	Check for wire.
(6)	Thermistor input circuit failure on the control board	Check the intake temperature of the sensor with the LED monitor. When the temperature is far different from the actual temperature, replace the control board.

<Reference>

	Short detection	Open detection
TH2	70 °C [158 °F] and above (0.4 k Ω)	-40 °C [-40 °F] and below (130 k Ω)
TH3	110 °C [230 °F] and above (0.4 k Ω)	-40 °C [-40 °F] and below (130 k Ω)
TH4	240 °C [464 °F] and above (0.57 k Ω)	0 °C [32 °F] and below (698 k Ω)
TH5	70 °C [158 °F] and above (0.4 k Ω)	-40 °C [-40 °F] and below (130 k Ω)
TH6	70 °C [158 °F] and above (1.14 k Ω)	-40 °C [-40 °F] and below (130 k Ω)
TH7	110 °C [230 °F] and above (0.4 k Ω)	-40 °C [-40 °F] and below (130 k Ω)

1. Error Code

5110

Heatsink temperature sensor (THHS) fault (Detail code 01)

2. Error definition and error detection method

When a short or an open of THHS is detected just before or during the inverter operation.

3. Cause, check method and remedy

Cause	Check method and remedy
(1) INV board failure	If the problem recurs when the unit is put into operation, replace the INV board.

Note

Refer to section -6- "Inverter" under part [4] Troubleshooting Principal Parts for error codes related to the inverter.(page 258)

1. Error Code

5201

High-pressure sensor fault (63HS1)

2. Error definition and error detection method

- If the high pressure sensor detects 0.098MPa [14psi] or less during the operation, the outdoor unit stops once, turns to anti-restart mode for 3 minutes, and restarts after 3 minutes when the detected high pressure sensor is 0.098MPa [14psi] or more.
- If the high pressure sensor detects 0.098MPa [14psi] or less just before the restart, the outdoor unit makes an error stop, and the error code "5201" will appear.
- During 3-minute antirestart mode, preliminary errors will be displayed on the LED display.
- A error is not detected for 3 minutes after the compressor start, during defrost operation, or 3 minutes after defrost operation.

3. Cause, check method and remedy

Cause	Check method and remedy
(1) High pressure sensor failure	Refer to the page on the troubleshooting of the high pressure sensor. (IX [4] -1- (page 248))
(2) Pressure drop due to refrigerant leak	
(3) Torn wire coating	
(4) A pin on the male connector is missing or contact failure	
(5) Disconnected wire	
(6) High pressure sensor input circuit failure on the control board	

1. Error Code

5301

ACCT sensor fault (Detail code 115)

2. Error definition and error detection method

When the formula "output current < 1.5 Arms" remains satisfied for 10 seconds while the inverter is in operation.

3. Cause, check method and remedy

Cause	Check method and remedy
(1) Inverter open output phase	Check the output wiring connections.
(2) Compressor failure	Refer to IX [4] -6- (2) [2].(page 260)
(3) INV board failure	Refer to IX [4] -6- (2) [1],[3],[4]..(page 260)

Note

Refer to section -6-"Inverter" under part [4] Troubleshooting Principal Parts for error codes related to the inverter.(page 258)

1. Error Code

5301

ACCT sensor circuit fault (Detail code 117)

2. Error definition and error detection method

When an error value is detected with the ACCT detection circuit just before the inverter starts

3. Cause, check method and remedy

Cause	Check method and remedy
(1) INV board failure	Refer to IX [4] -6- (2) [1],[3],[4]..(page 260)
(2) Compressor failure	Refer to IX [4] -6- (2) [2].(page 260)

Note

Refer to section -6-"Inverter" under part [4] Troubleshooting Principal Parts for error codes related to the inverter.(page 258)

1. Error Code

5301

Open-circuited IPM/Loose ACCT connector (Detail code 119)

2. Error definition and error detection method

Presence of enough current cannot be detected during the self-diagnostic operation immediately before inverter startup.

3. Cause, check method and remedy

Cause	Check method and remedy
(1) Inverter output wiring problem	Check output wiring connections. Confirm that the U- and W-phase output cables are put through CT12 and CT22 on the INV board respectively.
(2) Inverter failure	Refer to IX [4] -6- (2) [3], [4].(page 261)
(3) Compressor failure	Refer to IX [4] -6- (2) [2].(page 260)

Note

Refer to section -6- "Inverter" under part [4] Troubleshooting Principal Parts for error codes related to the inverter.(page 258)

1. Error Code

5301

Faulty ACCT wiring (Detail code 120)

2. Error definition and error detection method

Presence of target current cannot be detected during the self-diagnostic operation immediately before startup. (Detection of improperly mounted ACCT sensor)

3. Cause, check method and remedy

Cause	Check method and remedy
(1) Inverter output wiring problem	Check output wiring connections. Confirm that the U- and W-phase output cables are put through CT12 and CT22 on the INV board respectively.
(2) Inverter failure	Refer to IX [4] -6- (2) [3], [4].(page 261)
(3) Compressor failure	Refer to IX [4] -6- (2) [2].(page 260)

Note

Refer to section -6- "Inverter" under part [4] Troubleshooting Principal Parts for error codes related to the inverter.(page 258)

1. Error Code

5701

Loose float switch connector

2. Error definition and error detection method

Detection of the disconnected float switch (open-phase condition) during operation

3. Cause, check method and remedy

(1) CN4F disconnection or contact failure

Check for disconnection of the connector (CN4F) on the indoor unit control board.

1. Error Code

6201

Remote controller board fault (nonvolatile memory error)

2. Error definition and error detection method

This error is detected when the data cannot be read out from the built-in nonvolatile memory on the remote controller.

3. Cause, check method and remedy

(1) Remote controller failure

Replace the remote controller.

1. Error Code

6202

Remote controller board fault (clock IC error)

2. Error definition and error detection method

This error is detected when the built-in clock on the remote controller is not properly functioning.

3. Cause, check method and remedy

(1) Remote controller failure

Replace the remote controller.

1. Error Code

6600

Address overlap

2. Error definition and error detection method

An error in which signals from more than one indoor units with the same address are received

Note

The address and attribute that appear on the remote controller indicate the controller that detected the error.

3. Cause, check method and remedy

Cause	Check method and remedy
Two or more of the following have the same address: Outdoor units, indoor units, LOSSNAY units, controllers such as ME remote controllers. <Example> 6600 "01" appears on the remote controller Unit #01 detected the error. Two or more units in the system have 01 as their address.	Find the unit that has the same address as that of the error source. Once the unit is found, correct the address. Then, turn off the outdoor units, indoor units, and LOSSNAY units, keep them all turned off for at least five minutes, and turn them back on.

1. Error Code

6601

Polarity setting error

2. Error definition and error detection method

The error detected when transmission processor cannot distinguish the polarities of the M-NET transmission line.

3. Cause, check method and remedy

Cause	Check method and remedy
(1) No voltage is applied to the M-NET transmission line that G(B)-50A is connected to.	Check if power is supplied to the M-NET transmission line of the G(B)-50A, and correct any problem found.
(2) M-NET transmission line to which G(B)-50A is connected is short-circuited.	

1. Error Code

6602

Transmission processor hardware error

2. Error definition and error detection method

Although "0" was surely transmitted by the transmission processor, "1" is displayed on the transmission line.

Note

The address/attribute appeared on the display on the remote controller indicates the controller where an error occurred.

3. Cause

- 1) When the wiring work of or the polarity of either the indoor or outdoor transmission line is performed or is changed while the power is on, the transmitted data will collide, the wave shape will be changed, and an error will be detected.
- 2) Grounding fault of the transmission line
- 3) When grouping the indoor units that are connected to different outdoor units, the male power supply connectors on the multiple outdoor units are connected to the female power supply switch connector (CN40).
- 4) When the power supply unit for transmission lines is used in the system connected with MELANS, the male power supply connector is connected to the female power supply switch connector (CN40) on the outdoor unit.
- 5) Controller failure of the source of the error
- 6) When the transmission data is changed due to the noise on the transmission line
- 7) Voltage is not applied on the transmission line for centralized control (in case of grouped indoor units connected to different outdoor units or in case of the system connected with MELANS)

4. Check method and remedy

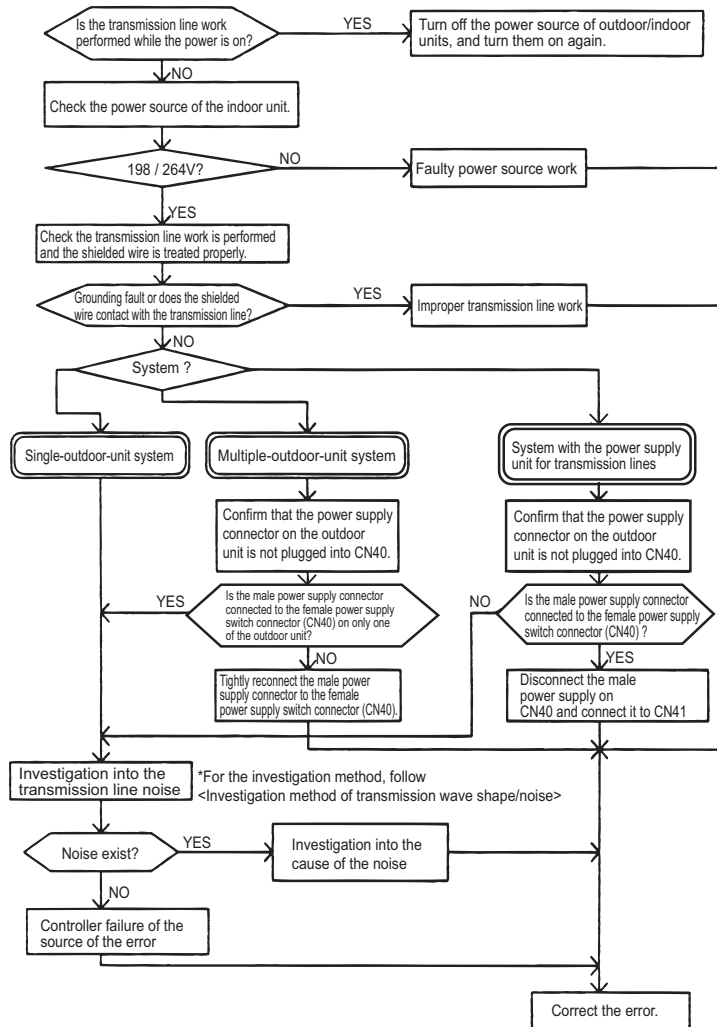

1. Error Code

6603

Transmission line bus busy error

2. Error definition and error detection method

- Generated error when the command cannot be transmitted for 4-10 minutes in a row due to bus-busy
- Generated error when the command cannot be transmitted to the transmission line for 4-10 minutes in a row due to noise

Note

The address/attribute appeared on the display on the remote controller indicates the controller where an error occurred.

3. Cause, check method and remedy

	Cause	Check method and remedy
(1)	The transmission processor cannot be transmitted as the short-wavelength voltage like noise exists consecutively on the transmission line.	No noise indicates that the error source controller is a failure. If noise exists, investigate the noise. -> No noise indicates that the error source controller is a failure. -> If noise exists, investigate the noise.
(2)	Error source controller failure	

1. Error Code

6606

Communication error between device and transmission processors

2. Error definition and error detection method

Communication error between the main microcomputer on the indoor unit board and the microcomputer for transmission

Note

The address/attribute appeared on the display on the remote controller indicates the controller where an error occurred.

3. Cause, check method and remedy

	Cause	Check method and remedy
(1)	Data is not properly transmitted due to accidental erroneous operation of the controller of the error source.	Turn off the power source of the outdoor and the indoor units.(When the power source is turned off separately, the microcomputer will not be reset, and the error will not be corrected.) -> If the same error occurs, the error source controller is a failure.
(2)	Error source controller failure	

1. Error Code

6607

No ACK error

2. Error definition and error detection method

The error is detected when no acknowledgement (ACK signal) is received after the transmission. (eg. When the data is transmitted six times in a row with 30 seconds interval, the error is detected on the transmission side.)

Note

The address/attribute appeared on the display on the remote controller indicates the controller which did not provide the response (ACK).

3. System configuration

(1) System with one outdoor unit

Error source address	Error display	Detection method	Cause	Check method and remedy
Outdoor unit (OC)	ME remote controller (RC) MA remote controller (MA)	No acknowledgement (ACK) at IC transmission to OC	(1) Contact failure of transmission line of OC or IC (2) Decrease of transmission line voltage/signal by exceeding acceptable range of transmission wiring. Farthest:200 m [656ft] or less Remote controller wiring: 10m [32ft] or less (3) Erroneous sizing of transmission line (Not within the range below). Wire diameter: 1.25mm ² [AWG16] or more (4) Indoor unit control board failure	Turn off the power source of the outdoor unit, and turn it on again. If the error is accidental, it will run normally. If not, check the causes (1) - (4).
Indoor unit (IC)	ME remote controller (RC) MA remote controller (MA)	No acknowledgement (ACK) at RC transmission to IC	(1) When IC unit address is changed or modified during operation. (2) Faulty or disconnected IC transmission wiring (3) Disconnected IC connector (CN2M) (4) Indoor unit controller failure (5) ME remote controller failure	Turn off the outdoor/indoor units for 5 or more minutes, and turn them on again. If the error is accidental, they will run normally. If not, check the causes (1) - (5).
LOSSNAY (LC)	ME remote controller (RC) MA remote controller (MA)	No acknowledgement (ACK) at IC transmission to LC	(1) The power source of LOSSNAY has been shut off. (2) When the address of LOSSNAY is changed in the middle of the operation (3) Faulty or disconnected transmission wiring of LOSSNAY (4) Disconnected connector (CN1) on LOSSNAY (5) Controller failure of LOSSNAY	Turn off the power source of LOSSNAY and turn it on again. If the error is accidental, it will run normally. If not, check the causes (1) - (5).
ME remote controller (RC)	ME remote controller (RC) MA remote controller (MA)	No acknowledgement (ACK) at IC transmission to RC	(1) Faulty transmission wiring at IC unit side. (2) Faulty wiring of the transmission line for ME remote controller (3) When the address of ME remote controller is changed in the middle of the operation (4) ME remote controller failure	Turn off the power source of the outdoor unit for 5 minutes or more, and turn it on again. If the error is accidental, it will run normally. If not, check the causes (1) - (4).

1. Error Code

6607

No ACK error

2. Error definition and error detection method

The error is detected when no acknowledgement (ACK signal) is received after the transmission. (eg. When the data is transmitted six times in a row with 30 seconds interval, the error is detected on the transmission side.)

Note

The address/attribute appeared on the display on the remote controller indicates the controller which did not provide the response (ACK).

3. System configuration

(2) Grouping of units in a system with multiple outdoor units

Error source address	Error display	Detection method	Cause	Check method and remedy
Outdoor unit (OC)	ME remote controller (RC) MA remote controller (MA)	No acknowledgement (ACK) at IC transmission to OC	Same cause as that for system with one outdoor unit	Same remedy as that for system with one outdoor unit
Indoor unit (IC)	ME remote controller (RC) MA remote controller (MA)	No acknowledgement (ACK) at RC transmission to IC	(1) Same causes as (1) - (5) for system with one outdoor unit (2) Disconnection or short circuit of the transmission line for the outdoor unit on the terminal block for centralized control line connection (TB7) (3) When multiple outdoor units are connected and the power source of one of the outdoor units has been shut off. (4) The male power supply connector of the outdoor unit is not connected to the female power supply switch connector (CN40). (5) The male power supply connectors on 2 or more outdoor units are connected to the female power supply switch connector (CN40) for centralized control. If an error occurs, after the unit runs normally once, the following causes may be considered. ♦Total capacity error (7100) ♦Capacity code error (7101) ♦Error in the number of connected units (7102) ♦Address setting error (7105)	1) Turn off the power sources of the outdoor and indoor units for 5 or more minutes, and turn them on again. If the error is accidental, the will run normally. If not, check the cause 2). 2) Check the causes of (1) - (5). If the cause is found, correct it. If no cause is found, check 3). 3) Check the LED displays for troubleshooting on other remote controllers whether an error occurs. If an error is found, -> If an error is found, check the check code definition, and correct the error. If no error is found, -> Indoor unit board failure

1. Error Code

6607

No ACK error

2. Error definition and error detection method

The error is detected when no acknowledgement (ACK signal) is received after the transmission. (eg. When the data is transmitted six times in a row with 30 seconds interval, the error is detected on the transmission side.)

Note

The address/attribute appeared on the display on the remote controller indicates the controller which did not provide the response (ACK).

3. System configuration

(2) Grouping of units in a system with multiple outdoor units

Error source address	Error display	Detection method	Cause	Check method and remedy
LOSS-NAY (LC)	ME remote controller (RC) MA remote controller (MA)	No acknowledgement (ACK) at IC transmission to LC	<p>(1) Factors (1) through (5) in the "Factors in system with one outdoor unit" (When performing an interlocked operation of the LOSSNAY unit and the indoor units that are connected to different outdoor units.)</p> <p>(2) Disconnection or short circuit of the transmission line for the outdoor unit on the terminal block for centralized control line connection (TB7)</p> <p>(3) When multiple outdoor units are connected and the power source of one of the outdoor units has been shut off.</p> <p>(4) The male power supply connector of the outdoor unit is not connected to the female power supply switch connector (CN40).</p> <p>(5) The male power supply connectors on 2 or more outdoor units are connected to the female power supply switch connector (CN40) for centralized control.</p> <p>If an error occurs, after the unit runs normally once, the following causes may be considered.</p> <ul style="list-style-type: none"> ◆Total capacity error (7100) ◆Capacity code error (7101) ◆Error in the number of connected units (7102) ◆Address setting error (7105) 	<p>1) Turn off the power source of LOSSNAY for 5 or more minutes, and turn it on again. If the error is accidental, it will run normally. If not, check the cause 2).</p> <p>2) Check the causes of (1) - (5). If the cause is found, correct it. If no cause is found, check 3).</p> <p>3) Same cause as that for indoor unit described in 3)</p>

1. Error Code

6607

No ACK error

2. Error definition and error detection method

The error is detected when no acknowledgement (ACK signal) is received after the transmission. (eg. When the data is transmitted six times in a row with 30 seconds interval, the error is detected on the transmission side.)

Note

The address/attribute appeared on the display on the remote controller indicates the controller which did not provide the response (ACK).

3. System configuration

(2) Grouping of units in a system with multiple outdoor units

Error source address	Error display	Detection method	Cause	Check method and remedy
ME remote controller (RC)	ME remote controller (RC) MA remote controller (MA)	No acknowledgement (ACK) at IC transmission to RC	(1) Same causes as (1) - (4) for system with one outdoor unit (2) Disconnection or short circuit of the transmission line for the outdoor unit on the terminal block for centralized control line connection (TB7) (3) When multiple outdoor units are connected and the power source of one of the outdoor units has been shut off. (4) The male power supply connector of the outdoor unit is not connected to the female power supply switch connector (CN40). (5) The male power supply connectors on 2 or more outdoor units are connected to the female power supply switch connector (CN40) for centralized control. If the problem recurs after normal operation is restored, the problem is caused by one of the following factors: ♦Total capacity error (7100) ♦Capacity code setting error (7101) ♦Error in the number of connected units (7102) ♦Address setting error (7105)	1) Turn off the power source of LOSSNAY for 5 or more minutes, and turn it on again. If the error is accidental, it will run normally. If not, check the cause 2). 2) Check the causes of (1) - (5). If the cause is found, correct it. If no cause is found, check 3). 3) Same cause as that for indoor unit described in 3)

1. Error Code

6607

No ACK error

2. Error definition and error detection method

The error is detected when no acknowledgement (ACK signal) is received after the transmission. (eg. When the data is transmitted six times in a row with 30 seconds interval, the error is detected on the transmission side.)

Note

The address/attribute appeared on the display on the remote controller indicates the controller which did not provide the response (ACK).

3. System configuration

(3) System connected to the system controllers (MELANS)

Error source address	Error display	Detection method	Cause	Check method and remedy
Outdoor unit (OC)	ME remote controller (RC) System controller (SC) MA remote controller (MA)	No acknowledgement (ACK) at IC transmission to OC	Same cause as that for system with one outdoor unit	Same remedy as that for system with one outdoor unit
Indoor unit (IC)	ME remote controller (RC) MA remote controller (MA)	No acknowledgement (ACK) at RC transmission to IC	Same as grouping of units in a system with multiple outdoor units	Same remedy as that for grouping of units in a system with multiple outdoor units
	System controller (SC)	No acknowledgement (ACK) at SC transmission to IC	1. Error occurrence on some IC (1) Same cause as that for system with one outdoor unit	Same remedy as that for system with one outdoor unit
			2. Error occurrence on all IC in the system with one outdoor unit (1) Total capacity error (7100) (2) Capacity code error (7101) (3) Error in the number of connected units (7102) (4) Address setting error (7105) (5) Disconnection or short circuit of the transmission line for the outdoor unit on the terminal block for centralized control line connection (TB7) (6) Turn off the power source of the outdoor unit (7) Malfunction of electrical system for the outdoor unit	1) Check the LED display for troubleshooting on the outdoor unit. •If an error is found, check the check code definition, and correct the error. •If no error is found, check 2). 2) Check (5) - (7) on the left.
3. Error occurrence on all IC (1) Same causes as (1) - (7) described in 2. (2) The male power supply connectors on 2 or more outdoor units are connected to the female power supply switch connector (CN40) for the transmission line for centralized control. (3) Disconnection or shutdown of the power source of the power supply unit for transmission line (4) System controller (MELANS) malfunction	Check voltage of the transmission line for centralized control. •20V or more: Check (1) and (2) on the left. •Less than 20V: Check (3) on the left.			

1. Error Code

6607

No ACK error

2. Error definition and error detection method

The error is detected when no acknowledgement (ACK signal) is received after the transmission. (eg. When the data is transmitted six times in a row with 30 seconds interval, the error is detected on the transmission side.)

Note

The address/attribute appeared on the display on the remote controller indicates the controller which did not provide the response (ACK).

3. System configuration

(3) System connected to the system controllers (MELANS)

Error source address	Error display	Detection method	Cause	Check method and remedy
ME remote controller (RC)	ME remote controller (RC) System controller (SC) MA remote controller (MA)	No acknowledgement (ACK) at IC transmission to RC	Same as grouping of units in a system with multiple outdoor units	Same remedy as that for grouping of units in a system with multiple outdoor units
	System controller (SC)	No acknowledgement (ACK) at MELANS transmission to RC	1. Error occurrence on some IC (1) Same cause as that for system with one outdoor unit	Same remedy as that for system with one outdoor unit
			2. Error occurrence on all IC in the system with one outdoor unit (1) An error is found by the outdoor unit. Total capacity error (7100) Capacity code error (7101) Error in the number of connected units (7102) Address setting error (7105) (2) Disconnection or short circuit of the transmission line for the outdoor unit on the terminal block for centralized control line connection (TB7) (3) Turn off the power source of the outdoor unit (4) Malfunction of electrical system for the outdoor unit	1) Check the LED display for troubleshooting on the outdoor unit. ♦ If an error is found, check the check code definition, and correct the error. ♦ If no error is found, check the cause 2). 2) Check (2) - (4) on the left.
		3. Error occurrence on all IC (1) Same causes as (1) - (4) described in 2. (2) When the power supply unit for transmission lines is used and the male power supply connector is connected to the female power supply switch connector (CN40) for the transmission line for centralized control (3) Disconnection or shutdown of the power source of the power supply unit for transmission line (4) System controller (MELANS) malfunction	Check (1) - (4) on the left.	

1. Error Code

6607

No ACK error

2. Error definition and error detection method

The error is detected when no acknowledgement (ACK signal) is received after the transmission. (eg. When the data is transmitted six times in a row with 30 seconds interval, the error is detected on the transmission side.)

Note

The address/attribute appeared on the display on the remote controller indicates the controller which did not provide the response (ACK).

3. System configuration

(3) System connected to the system controllers (MELANS)

Error source address	Error display	Detection method	Cause	Check method and remedy
System controller (SC) ME remote controller (RC) MA remote controller (MA)		No acknowledgement (ACK) at IC transmission to SC	1. Error display on some displays on ME remote controllers (1) Faulty wiring of the transmission line for ME remote controller (2) Disconnection or contact failure of the transmission connector for ME remote controller (3) ME remote controller failure	Check (1) - (3) on the left.
			2. Error occurrence on all IC in the system with one outdoor unit (1) An error is found by the outdoor unit. Total capacity error (7100) Capacity code error (7101) Error in the number of connected units (7102) Address setting error (7105) (2) Disconnection or short circuit of the transmission line for the outdoor unit on the terminal block for centralized control line connection (TB7) (3) Turn off the power source of the outdoor unit (4) Malfunction of electrical system for the outdoor unit	1) Check the LED display for troubleshooting on the outdoor unit. ♦ If an error is found, check the check code definition, and correct the error. ♦ If no error is found, check the cause 2) 2) Check (2) - (4) on the left.
			3. Error display on all displays on ME remote controllers (1) Same causes as (1) - (4) described in 2. (2) When the power supply unit for transmission lines is used and the male power supply connector is connected to the female power supply switch connector (CN40) for the transmission line for centralized control (3) Disconnection or shutdown of the power source of the power supply unit for transmission line (4) System controller (MELANS) malfunction	Check (1) - (4) on the left

1. Error Code

6607

No ACK error

2. Error definition and error detection method

The error is detected when no acknowledgement (ACK signal) is received after the transmission. (eg. When the data is transmitted six times in a row with 30 seconds interval, the error is detected on the transmission side.)

Note

The address/attribute appeared on the display on the remote controller indicates the controller which did not provide the response (ACK).

3. System configuration

(4) Errors that are not limited to a particular system

Error source address	Error display	Detection method	Cause	Check method and remedy
Address which should not be existed	-	-	<p>(1) Although the address of ME remote controller has been changed after the group is set using ME remote controller, the indoor unit is keeping the memory of the previous address. The same symptom will appear for the registration with SC.</p> <p>(2) Although the address of LOSSNAY has been changed after the interlock registration of LOSSNAY is made using ME remote controller, the indoor unit is keeping the memory of the previous address.</p>	<p>Delete unnecessary information of non-existing address which some indoor units have. Use either of the following two methods for deletion.</p> <p>1) Address deletion by ME remote controller Delete unnecessary address information using the manual setting function of ME remote controller. Refer to this service handbook "IV [2] Group Settings and Interlock Settings via the ME Remote Controller 1. (3) Address deletion".</p> <p>2) Deletion of connection information of the outdoor unit by the deleting switch</p> <p>Note that this switch deletes all the group information set via ME remote controller and all the interlock information of LOSSNAY and the indoor unit.</p> <ul style="list-style-type: none"> ♦ Turn off the power source of the outdoor unit, and wait for 5 minutes. ♦ Turn on the dip switch (SW2-2) on the outdoor unit control board. ♦ Turn on the power source of the outdoor unit, and wait for 5 minutes. ♦ Turn off the power source of the outdoor unit, and wait for 5 minutes. ♦ Turn off the dip switch (SW2-2) on the outdoor unit control board. ♦ Turn on the power source of the outdoor unit.

1. Error Code

6608

No response error

2. Error definition and error detection method

- When no response command is returned although acknowledgement (ACK) is received after transmission, an error is detected.
- When the data is transmitted 10 times in a row with 3 seconds interval, an error is detected on the transmission side.

Note

The address/attribute appeared on the display on the remote controller indicates the controller where an error occurred.

3. Cause

- 1) The transmission line work is performed while the power is on, the transmitted data will collide, and the wave shape will be changed.
- 2) The transmission is sent and received repeatedly due to noise.
- 3) Decrease of transmission line voltage/signal by exceeding acceptable range of transmission wiring.
Farthest:200m [656ft] or less
Remote controller wiring:12m [39ft] or less
- 4) The transmission line voltage/signal is decreased due to erroneous sizing of transmission line.
Wire diameter: 1.25mm²[AWG16] or more

4. Check method and remedy

- 1) When an error occurs during commissioning, turn off the power sources for the outdoor unit, indoor unit, and LOSSNAY for 5 or more minutes, and then turn them on again.
 - When they return to normal operation, the cause of the error is the transmission line work performed with the power on.
 - If an error occurs again, check the cause 2).
- 2) Check 3) and 4) above.
 - If the cause is found, correct it.
 - If no cause is found, check 3).
- 3) Check transmission wave shape/ noise on trans-mission line by following "IX [3] Investigation of Transmission Wave Shape/ Noise".(page 245).

Noise is the most possible cause of the error "6608".

1. Error Code

6831

MA controller signal reception error (No signal reception)

2. Error definition and error detection method

- Communication between the MA remote controller and the indoor unit is not done properly.
- No proper data has been received for 3 minutes.

3. Cause

- 1) Contact failure of the remote controller lines of MA remote controller or the indoor unit.
- 2) All the remote controllers are set to SUB.
- 3) Failure to meet wiring regulations
 - Wire length
 - Wire size
 - Number of remote controllers
 - Number of indoor units
- 4) The remote controller is removed after the installation without turning the power source off.
- 5) Noise interference on the remote controller transmission lines
- 6) Faulty circuit that is on the indoor board and performs transmission/ reception of the signal from the remote controller
- 7) Problems with the circuit on the remote controller that sends or receives the signals from the remote controller

4. Check method and remedy

- 1) Check for disconnected or loose transmission lines for the indoor units or MA remote controllers.
- 2) Confirm that the power is supplied to the main power source and the remote controller line.
- 3) Confirm that MA remote controller's capacity limit is not exceeded.
- 4) Check the sub/main setting of the MA remote controllers. One of them must be set to MAIN.
- 5) Diagnose the remote controller (described in the remote controller installation manual).
[OK]: no problems with the remote controller (check the wiring regulations)
[NG]: Replace the MA remote controller.
[6832, 6833, ERC]: Due to noise interference <Go to 6>
- 6) Check wave shape/noise on MA remote controller line by following "IX [3] Investigation of Transmission Wave Shape/ Noise". (page 245)
- 7) When no problems are found with items 1) through 6), replace the indoor unit board or the MA remote controller.
The following status can be confirmed on LED1 and 2 on the indoor unit board.
 - If LED1 is lit, the main power source of the indoor unit is turned on.
 - If LED2 is lit, the MA remote controller line is being powered.

1. Error Code

6832

MA remote controller signal transmission error (Synchronization error)

2. Error definition and error detection method

- MA remote controller and the indoor unit is not done properly.
- Failure to detect opening in the transmission path and unable to send signals
 - *Indoor unit : 3 minutes
 - *Remote controller : 6 seconds

3. Cause

- 1) Contact failure of the remote controller lines of MA remote controller or the indoor unit
- 2) 2 or more remote controllers are set to MAIN
- 3) Overlapped indoor unit address
- 4) Noise interference on the remote controller lines
- 5) Failure to meet wiring regulations
 - Wire length
 - Wire size
 - Number of remote controllers
 - Number of indoor units
- 6) Problems with the circuit on the remote controller that sends or receives the signals from the remote controller

4. Check method and remedy

- 1) Check for disconnected or loose transmission lines for the indoor units or MA remote controllers.
- 2) Confirm that the power is supplied to the main power source and the remote controller line.
- 3) Confirm that MA remote controller's capacity limit is not exceeded.
- 4) Check the sub/main setting of the MA remote controllers. One of them must be set to MAIN.
- 5) Diagnose the remote controller (described in the remote controller installation manual).
[OK]: no problems with the remote controller (check the wiring regulations)
[NG]: Replace the MA remote controller.
[6832, 6833, ERC]: Due to noise interference <Go to 6>
- 6) Check wave shape/noise on MA remote controller line by following "IX [3] Investigation of Transmission Wave Shape/ Noise".(page 245)
- 7) When no problems are found with items 1) through 6), replace the indoor unit board or the MA remote controller.
The following status can be confirmed on LED1 and 2 on the indoor unit board.
 - If LED1 is lit, the main power source of the indoor unit is turned on.
 - If LED2 is lit, the MA remote controller line is being powered.

1. Error Code

6833

MA remote controller signal transmission error (Hardware error)

2. Error definition and error detection method

- Communication between the MA remote controller and the indoor unit is not done properly.
- An error occurs when the transmitted data and the received data differ for 30 times in a row.

3. Cause

- 1) Contact failure of the remote controller lines of MA remote controller or the indoor unit
- 2) 2 or more remote controllers are set to MAIN
- 3) Overlapped indoor unit address
- 4) Noise interference on the remote controller lines
- 5) Failure to meet wiring regulations
 - Wire length
 - Wire size
 - Number of remote controllers
 - Number of indoor units
- 6) Problems with the circuit on the remote controller that sends or receives the signals from the remote controller

4. Check method and remedy

- 1) Check for disconnected or loose transmission lines for the indoor units or MA remote controllers.
- 2) Confirm that the power is supplied to the main power source and the remote controller line.
- 3) Confirm that MA remote controller's capacity limit is not exceeded.
- 4) Check the sub/main setting of the MA remote controllers. One of them must be set to MAIN.
- 5) Diagnose the remote controller (described in the remote controller installation manual).
 - [OK]: no problems with the remote controller (check the wiring regulations)
 - [NG]: Replace the MA remote controller.
 - [6832, 6833, ERC]: Due to noise interference <Go to 6>
- 6) Check wave shape/noise on MA remote controller line by following "IX [3] Investigation of Transmission Wave Shape/ Noise".(page 245)
- 7) When no problems are found with items 1) through 6), replace the indoor unit board or the MA remote controller.
 - The following status can be confirmed on LED1 and 2 on the indoor unit board.
 - If LED1 is lit, the main power source of the indoor unit is turned on.
 - If LED2 is lit, the MA remote controller line is being powered.

1. Error Code

6834

MA controller signal reception error (Start bit detection error)

2. Error definition and error detection method

- Communication between the MA remote controller and the indoor unit is not done properly.
- No proper data has been received for 2 minutes.

3. Cause

- 1) Contact failure of the remote controller lines of MA remote controller or the indoor unit.
- 2) All the remote controllers are set to SUB.
- 3) Failure to meet wiring regulations
 - Wire length
 - Wire size
 - Number of remote controllers
 - Number of indoor units
- 4) The remote controller is removed after the installation without turning the power source off.
- 5) Noise interference on the remote controller transmission lines
- 6) Faulty circuit that is on the indoor board and performs transmission/ reception of the signal from the remote controller
- 7) Problems with the circuit on the remote controller that sends or receives the signals from the remote controller

4. Check method and remedy

- 1) Check for disconnected or loose transmission lines for the indoor units or MA remote controllers.
- 2) Confirm that the power is supplied to the main power source and the remote controller line.
- 3) Confirm that MA remote controller's capacity limit is not exceeded.
- 4) Check the sub/main setting of the MA remote controllers. One of them must be set to MAIN.
- 5) Diagnose the remote controller (described in the remote controller installation manual).
[OK]: no problems with the remote controller (check the wiring regulations)
[NG]: Replace the MA remote controller.
[6832, 6833, ERC]: Due to noise interference <Go to 6>
- 6) Check wave shape/noise on MA remote controller line by following "IX [3] Investigation of Transmission Wave Shape/ Noise". (page 245)
- 7) When no problems are found with items 1) through 6), replace the indoor unit board or the MA remote controller.
The following status can be confirmed on LED1 and 2 on the indoor unit board.
 - If LED1 is lit, the main power source of the indoor unit is turned on
 - If LED2 is lit, the MA remote controller line is being powered.

1. Error Code

7100

Total capacity error

2. Error definition and error detection method

The model total of indoor units in the system with one outdoor unit exceeds limitations.

3. Error source, cause, check method and remedy,

Error source	Cause	Check method and remedy																																														
Outdoor unit	(1) The model total of indoor units in the system with one outdoor unit exceeds the following table. <table border="1" style="margin: 10px auto; border-collapse: collapse; text-align: center;"> <thead> <tr> <th style="width: 50%;">Model</th> <th style="width: 50%;">Capacity Total</th> </tr> </thead> <tbody> <tr><td>200 model</td><td>260</td></tr> <tr><td>250 model</td><td>325</td></tr> <tr><td>300 model</td><td>390</td></tr> <tr><td>350 model</td><td>455</td></tr> <tr><td>400 model</td><td>520</td></tr> <tr><td>450 model</td><td>585</td></tr> <tr><td>500 model</td><td>650</td></tr> <tr><td>550 model</td><td>715</td></tr> <tr><td>600 model</td><td>780</td></tr> <tr><td>650 model</td><td>845</td></tr> <tr><td>700 model</td><td>910</td></tr> <tr><td>750 model</td><td>975</td></tr> <tr><td>800 model</td><td>1040</td></tr> <tr><td>850 model</td><td>1105</td></tr> <tr><td>900 model</td><td>1170</td></tr> <tr><td>950 model</td><td>1235</td></tr> <tr><td>1000 model</td><td>1300</td></tr> <tr><td>1050 model</td><td>1365</td></tr> <tr><td>1100 model</td><td>1430</td></tr> <tr><td>1150 model</td><td>1495</td></tr> <tr><td>1200 model</td><td>1560</td></tr> <tr><td>1250 model</td><td>1625</td></tr> </tbody> </table>	Model	Capacity Total	200 model	260	250 model	325	300 model	390	350 model	455	400 model	520	450 model	585	500 model	650	550 model	715	600 model	780	650 model	845	700 model	910	750 model	975	800 model	1040	850 model	1105	900 model	1170	950 model	1235	1000 model	1300	1050 model	1365	1100 model	1430	1150 model	1495	1200 model	1560	1250 model	1625	1) Check the model total (capacity code total) of indoor units connected. 2) Check the model name (capacity code) of the connected indoor unit set by the switch (SW2 on indoor unit board). When the model name set by the switch is different from that of the unit connected, turn off the power source of the outdoor and the indoor units, and change the setting of the model name (capacity code).
	Model	Capacity Total																																														
	200 model	260																																														
250 model	325																																															
300 model	390																																															
350 model	455																																															
400 model	520																																															
450 model	585																																															
500 model	650																																															
550 model	715																																															
600 model	780																																															
650 model	845																																															
700 model	910																																															
750 model	975																																															
800 model	1040																																															
850 model	1105																																															
900 model	1170																																															
950 model	1235																																															
1000 model	1300																																															
1050 model	1365																																															
1100 model	1430																																															
1150 model	1495																																															
1200 model	1560																																															
1250 model	1625																																															
	(2) The model selection switches (SW5-1 - 5-4) on the outdoor unit are set incorrectly. <table border="1" style="margin: 10px auto; border-collapse: collapse; text-align: center;"> <thead> <tr> <th rowspan="2" style="width: 20%;">Model</th> <th colspan="4" style="width: 80%;">SW5</th> </tr> <tr> <th style="width: 10%;">1</th> <th style="width: 10%;">2</th> <th style="width: 10%;">3</th> <th style="width: 10%;">4</th> </tr> </thead> <tbody> <tr><td>200 model</td><td>OFF</td><td>ON</td><td>OFF</td><td>OFF</td></tr> <tr><td>250 model</td><td>ON</td><td>ON</td><td>OFF</td><td>OFF</td></tr> <tr><td>300 model</td><td>OFF</td><td>OFF</td><td>ON</td><td>OFF</td></tr> <tr><td>350 model</td><td>OFF</td><td>ON</td><td>ON</td><td>OFF</td></tr> <tr><td>400 model</td><td>ON</td><td>ON</td><td>ON</td><td>OFF</td></tr> <tr><td>450 model</td><td>OFF</td><td>OFF</td><td>OFF</td><td>ON</td></tr> </tbody> </table>	Model	SW5				1	2	3	4	200 model	OFF	ON	OFF	OFF	250 model	ON	ON	OFF	OFF	300 model	OFF	OFF	ON	OFF	350 model	OFF	ON	ON	OFF	400 model	ON	ON	ON	OFF	450 model	OFF	OFF	OFF	ON	Check the setting for the model selection switch on the outdoor unit (Dipswitches SW5-1 - 5-4 on the outdoor unit control board).							
Model	SW5																																															
	1	2	3	4																																												
200 model	OFF	ON	OFF	OFF																																												
250 model	ON	ON	OFF	OFF																																												
300 model	OFF	OFF	ON	OFF																																												
350 model	OFF	ON	ON	OFF																																												
400 model	ON	ON	ON	OFF																																												
450 model	OFF	OFF	OFF	ON																																												
	(3) The outdoor unit and the auxiliary unit (OS) that is connected to the same system are not properly connected.	Confirm that the TB3 on the OC and OS are properly connected.																																														

1. Error Code

7101

Capacity code setting error

2. Error definition and error detection method

Connection of incompatible (wrong capacity code) indoor unit or outdoor unit

3. Error source, cause, check method and remedy

Error source	Cause	Check method and remedy																																							
Outdoor unit Indoor unit	(1) The model name (capacity code) set by the switch (SW2) is wrong. *The capacity of the indoor unit can be confirmed by the self-diagnosis function (SW1 operation) of the outdoor unit.	1) Check the model name (capacity code) of the indoor unit which has the error source address set by the switch (SW2 on indoor unit board). When the model name set by the switch is different from that of the unit connected, turn off the power source of the outdoor and the indoor units, and change the setting of the capacity code.																																							
Outdoor unit	(2) The model selection switches (SW5-1 - 5-4) on the outdoor unit are set incorrectly. <table border="1" style="margin-left: auto; margin-right: auto; border-collapse: collapse; text-align: center;"> <thead> <tr> <th rowspan="2">Model</th> <th colspan="4">SW5</th> </tr> <tr> <th>1</th> <th>2</th> <th>3</th> <th>4</th> </tr> </thead> <tbody> <tr> <td>200 model</td> <td>OFF</td> <td>ON</td> <td>OFF</td> <td>OFF</td> </tr> <tr> <td>250 model</td> <td>ON</td> <td>ON</td> <td>OFF</td> <td>OFF</td> </tr> <tr> <td>300 model</td> <td>OFF</td> <td>OFF</td> <td>ON</td> <td>OFF</td> </tr> <tr> <td>350 model</td> <td>OFF</td> <td>ON</td> <td>ON</td> <td>OFF</td> </tr> <tr> <td>400 model</td> <td>ON</td> <td>ON</td> <td>ON</td> <td>OFF</td> </tr> <tr> <td>450 model</td> <td>OFF</td> <td>OFF</td> <td>OFF</td> <td>ON</td> </tr> </tbody> </table>	Model	SW5				1	2	3	4	200 model	OFF	ON	OFF	OFF	250 model	ON	ON	OFF	OFF	300 model	OFF	OFF	ON	OFF	350 model	OFF	ON	ON	OFF	400 model	ON	ON	ON	OFF	450 model	OFF	OFF	OFF	ON	Check the setting for the model selection switch on the outdoor unit (Dipswitches SW5-1 - 5-4 on the outdoor unit control board).
Model	SW5																																								
	1	2	3	4																																					
200 model	OFF	ON	OFF	OFF																																					
250 model	ON	ON	OFF	OFF																																					
300 model	OFF	OFF	ON	OFF																																					
350 model	OFF	ON	ON	OFF																																					
400 model	ON	ON	ON	OFF																																					
450 model	OFF	OFF	OFF	ON																																					

1. Error Code

7102

Wrong number of connected units

2. Error definition and error detection method

The number of connected indoor units is "0" or exceeds the allowable value.

3. Error source, cause, check method and remedy

Error source	Cause	Check method and remedy								
Outdoor unit	<p>(1) Number of indoor units connected to the outdoor terminal block (TB3) for indoor/ outdoor transmission lines exceeds limitations described below.</p> <table border="1" data-bbox="469 640 906 1220"> <thead> <tr> <th data-bbox="469 640 628 674">Number of units</th> <th data-bbox="628 640 906 674">Restriction on the number of units</th> </tr> </thead> <tbody> <tr> <td data-bbox="469 674 628 707">Total number of indoor units</td> <td data-bbox="628 674 906 981"> 17 : 200 model 21 : 250 models 26 : 300 models 30 : 350 models 34 : 400 models 39 : 450 models 43 : 500 models 47 : 550 models 50 : 600 - 1250 models </td> </tr> <tr> <td data-bbox="469 981 628 1122">Total number of LOSSNAY units (During auto address start-up only)</td> <td data-bbox="628 981 906 1122">0 or 1</td> </tr> <tr> <td data-bbox="469 1122 628 1220">Total number of outdoor units</td> <td data-bbox="628 1122 906 1220"> 1 : P200 - P450, EP200 - EP300 models 2 : P500 - P900, EP400 - EP650 models 3 : P950 - P1250, EP700 - EP900 models </td> </tr> </tbody> </table>	Number of units	Restriction on the number of units	Total number of indoor units	17 : 200 model 21 : 250 models 26 : 300 models 30 : 350 models 34 : 400 models 39 : 450 models 43 : 500 models 47 : 550 models 50 : 600 - 1250 models	Total number of LOSSNAY units (During auto address start-up only)	0 or 1	Total number of outdoor units	1 : P200 - P450, EP200 - EP300 models 2 : P500 - P900, EP400 - EP650 models 3 : P950 - P1250, EP700 - EP900 models	<p>1) Check whether the number of units connected to the outdoor terminal block (TB3) for indoor/ outdoor transmission lines does not exceed the limitation. (See (1) and (2) on the left.)</p>
	Number of units	Restriction on the number of units								
	Total number of indoor units	17 : 200 model 21 : 250 models 26 : 300 models 30 : 350 models 34 : 400 models 39 : 450 models 43 : 500 models 47 : 550 models 50 : 600 - 1250 models								
	Total number of LOSSNAY units (During auto address start-up only)	0 or 1								
	Total number of outdoor units	1 : P200 - P450, EP200 - EP300 models 2 : P500 - P900, EP400 - EP650 models 3 : P950 - P1250, EP700 - EP900 models								
(2) Disconnected transmission line of the outdoor unit	2) Check (2) - (3) on the left.									
(3) Short-circuited transmission line When (2) and (3) apply, the following display will appear. ♦ME remote controller Nothing appears on the remote controller because it is not powered. ♦MA remote controller "HO" or "PLEASE WAIT" blinks.	3) Check whether the transmission line for the terminal block for centralized control (TB7) is not connected to the terminal block for the indoor/outdoor transmission line (TB3).									
(4) The model selection switch (SW5-7) on the outdoor unit is set to OFF. (Normally set to ON)	4) Check the setting for the model selection switch on the outdoor unit (Dipswitches SW5-7 on the outdoor unit control board).									
(5) Outdoor unit address setting error The outdoor units in the same refrigerant circuit do not have sequential address numbers.										

1. Error Code

7105

Address setting error

2. Error definition and error detection method

Erroneous setting of OC unit address

3. Cause, check method and remedy

Error source	Cause	Check method and remedy
Outdoor unit	Erroneous setting of OC unit address The address of outdoor unit is not being set to 51 - 100.	Check that the address of OC unit is set to 51-100. Reset the address if it stays out of the range, while shutting the power source off.

1. Error Code

7106

Attribute setting error

2. Error definition and error detection method

Error source	Cause	Check method and remedy						
-	A remote controller for use with indoor units, such as the MA remote controller, is connected to the OA processing unit whose attribute is FU.	<p>To operate the OA processing unit directly via a remote controller for use with indoor units, such as the MA remote controller, set the DIP SW 3-1 on the OA processing unit to ON.</p> <table border="1" style="margin-left: auto; margin-right: auto;"> <tr> <td style="padding: 2px;">Operation Method</td> <td style="padding: 2px;">SW3-1</td> </tr> <tr> <td style="padding: 2px;">Interlocked operation with the indoor unit</td> <td style="padding: 2px;">OFF</td> </tr> <tr> <td style="padding: 2px;">Direct operation via the MA remote controller</td> <td style="padding: 2px;">ON</td> </tr> </table>	Operation Method	SW3-1	Interlocked operation with the indoor unit	OFF	Direct operation via the MA remote controller	ON
Operation Method	SW3-1							
Interlocked operation with the indoor unit	OFF							
Direct operation via the MA remote controller	ON							

1. Error Code

7110

Connection information signal transmission/reception error

2. Error definition and error detection method

The given indoor unit is inoperable because it is not properly connected to the outdoor unit in the same system.

3. Error source, cause, check method and remedy

Error source	Cause	Check method and remedy
Outdoor unit	(1) Power to the transmission booster is cut off.	1) Confirm that the power to the transmission booster is not cut off by the booster being connected to the switch on the indoor unit. (The unit will not function properly unless the transmission booster is turned on.) ->Reset the power to the outdoor unit.
	(2) Power resetting of the transmission booster and outdoor unit.	
	(3) Wiring failure between OC and OS	2) Confirm that the TB3 on the OC and OS are properly connected.
	(4) Broken wire between OC and OS.	3) Check the model selection switch on the outdoor unit (Dipswitch SW5-7 on the control board.).
	(5) The model selection switch (SW5-7) on the outdoor unit is set to OFF. (Normally set to ON)	

1. Error Code

7111

Remote controller sensor fault

2. Error definition and error detection method

This error occurs when the temperature data is not sent although the remote controller sensor is specified.

3. Error source, cause, check method and remedy

Error source	Cause	Check method and remedy
Indoor unit OA processing unit	The remote controller without the temperature sensor (the wireless remote controller or the ME compact remote controller (mounted type)) is used and the remote controller sensor for the indoor unit is specified. (SW1-1 is ON.)	Replace the remote controller with the one with built-in temperature sensor.

1. Error Code

7113

Function setting error

2. Error source, cause, check method and remedy

Error source	Cause	Check method and remedy
Outdoor unit	(1) Wiring failure	1) Control board connector Check the CNTYP2,4,5 connector connection. INV board connector Check the CNTYP connector connection
	(2) Disconnected connector, short circuit, contact failure	2) Check the compatibility of the circuit board, and replace it with a correct one if necessary.
	(3) Incompatibility between the control board and INV board (Replacement of the circuit board with the wrong one)	3) Check the model selection switch on the outdoor unit (Dipswitch SW5-7 on the control board.).

1. Error Code

7117

Model setting error

2. Error source, cause, check method and remedy

Error source	Cause	Check method and remedy
Outdoor unit	(1) Wiring failure	1) Control board connector Check the CNTYP2,4,5 connector connection. INV board connection Check the CNTYP connector connection
	(2) Disconnected connector, short circuit, contact failure	

1. Error Code

7130

Incompatible unit combination

2. Error definition and error detection method

The check code will appear when the indoor units with different refrigerant systems are connected.

3. Error source, cause, check method and remedy

Error source	Cause	Check method and remedy
Outdoor unit	The connected indoor unit is for use with R22 or R407C. Incorrect type of indoor units are connected. The M-NET connection adapter is connected to the indoor unit system in a system in which the Slim Model (A control) of units are connected to the M-NET.	Check the connected indoor unit model. Check whether the connecting adapter for M-NET is not connected to the indoor unit. (Connect the connecting adapter for M-NET to the outdoor unit.)

-1- Troubleshooting according to the remote controller malfunction or the external input error

In the case of MA remote controller

1. Phenomena

Even if the operation button on the remote controller is pressed, the display remains unlit and the unit does not start running. (Power indicator  does not appear on the screen.)

(1) Cause

- 1) The power is not supplied to the indoor unit.
 - The main power of the indoor unit is not on.
 - The connector on the indoor unit board has come off.
 - The fuse on the indoor unit board has melted.
 - Transformer failure and disconnected wire of the indoor unit.
- 2) Incorrect wiring for the MA remote controller
 - Disconnected wire for the MA remote controller or disconnected line to the terminal block.
 - Short-circuited MA remote controller wiring
 - Incorrect wiring of the MA remote controller cables
 - Incorrect connection of the MA remote wiring to the terminal block for transmission line (TB5) on the indoor unit
 - Wiring mixup between the MA remote controller cable and 200 VAC power supply cable
 - Reversed connection of the wire for the MA remote controller and the M-NET transmission line on the indoor unit
- 3) The number of the MA remote controllers that are connected to an indoor unit exceeds the allowable range (2 units).
- 4) The length or the diameter of the wire for the MA remote controller are out of specification.
- 5) Short circuit of the wire for the remote display output of the outdoor unit or reversed polarity connection of the relay.
- 6) The indoor unit board failure
- 7) MA remote controller failure

(2) Check method and remedy

- 1) Measure voltages of the MA remote controller terminal (among 1 to 3).
 - If the voltage is between DC 9 and 12V, the remote controller is a failure.
 - If no voltage is applied, check the causes 1) and 3) and if the cause is found, correct it.
If no cause is found, refer to 2).
- 2) Remove the wire for the remote controller from the terminal block (TB13) on the MA remote controller for the indoor unit, and check voltage among 1 to 3.
 - If the voltage is between DC 9 and 12 V, check the causes 2) and 4) and if the cause is found, correct it.
 - If no voltage is applied, check the cause 1) and if the cause is found, correct it.
If no cause is found, check the wire for the remote display output (relay polarity).
If no further cause is found, replace the indoor unit board.

In the case of MA remote controller

2. Phenomena

When the remote controller operation SW is turned on, the operation status briefly appears on the display, then it goes off, and the display lights out immediately, and the unit stops.

(1) Cause

- 1) The power for the M-NET transmission line is not supplied from the outdoor unit.
- 2) Short circuit of the transmission line.
- 3) Incorrect wiring of the M-NET transmission line on the outdoor unit.
 - Disconnected wire for the MA remote controller or disconnected line to the terminal block.
 - The indoor transmission line is connected incorrectly to the transmission terminal block for centralized controller (TB7).
 - The male power supply connectors on the multiple outdoor units are connected to the female power supply switch connector (CN40).

In the system to which the power supply unit for transmission lines is connected, the male power supply connector is connected to the female power supply switch connector (CN40) on the outdoor unit.
- 4) Disconnected M-NET transmission line on the indoor unit side.
- 5) Disconnected wire between the terminal block for M-NET line (TB5) of the indoor unit and the indoor unit board (CN2M) or disconnected connector.

(2) Check method and remedy

- 1) **When 2) and 3) above apply, check code 7102 will be displayed on the self-diagnosis LED.**

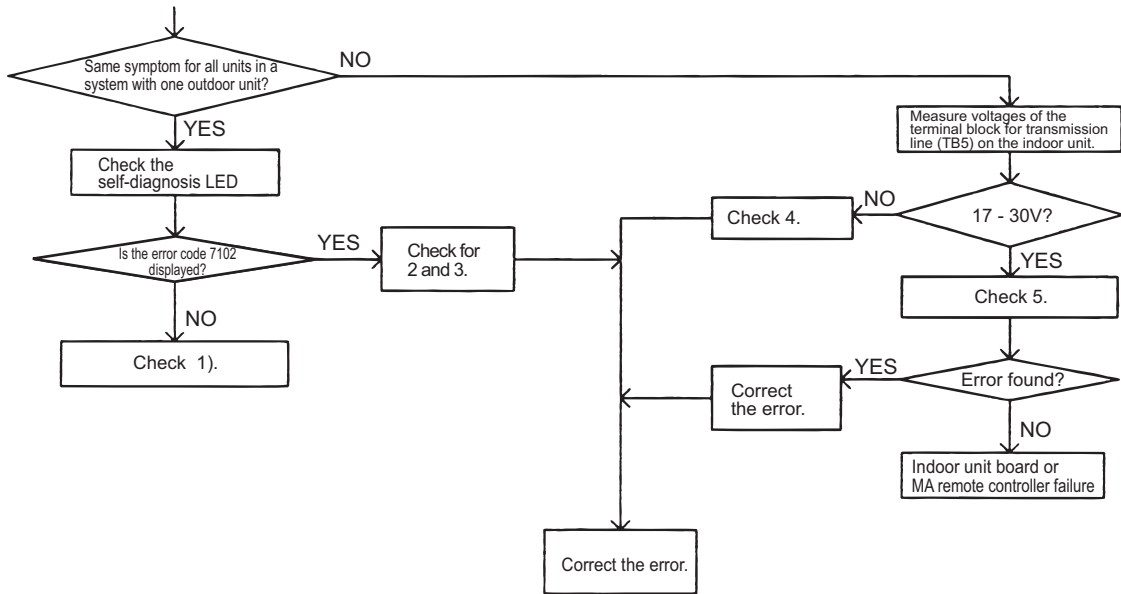

See Section IX [4] -7- (2) Troubleshooting transmission power circuit of outdoor unit for how to check the items in Section 1 in the flowchart above.(page 267)

In the case of MA remote controller

3. Phenomena

"HO" or "PLEASE WAIT" display on the remote controller does not disappear, and no operation is performed even if the button is pressed. ("HO" or "PLEASE WAIT" display will normally turn off 5 minutes later after the power on.)

(1) Cause

- 1) The power for the M-NET transmission line is not supplied from the outdoor unit.
- 2) Short-circuited transmission line
- 3) Incorrect wiring of the M-NET transmission line on the outdoor unit.
 - Disconnected wire for the MA remote controller or disconnected line to the terminal block.
 - The indoor transmission line is connected incorrectly to the transmission terminal block for centralized controller (TB7).
 - The male power supply connectors on the multiple outdoor units are connected to the female power supply switch connector (CN40).

In the system to which the power supply unit for transmission lines is connected, the male power supply connector is connected to the female power supply switch connector (CN40) on the outdoor unit
- 4) Disconnected M-NET transmission line on the indoor unit.
- 5) Disconnected wire between the terminal block for M-NET line (TB5) of the indoor unit and the indoor unit board (CN2M) or disconnected connector.
- 6) Incorrect wiring for the MA remote controller
 - Short-circuited wire for the MA remote controller
 - Disconnected wire for the MA remote controller (No.2) and disconnected line to the terminal block.
 - Reversed daisy-chain connection between groups
 - Incorrect wiring for the MA remote controller to the terminal block for transmission line connection (TB5) on the indoor unit
 - The M-NET transmission line is connected incorrectly to the terminal block (TB13) for the MA remote controller.
- 7) The sub/main setting of the MA remote controller is set to sub.
- 8) 2 or more main MA remote controllers are connected.
- 9) Indoor unit board failure (MA remote controller communication circuit)
- 10) Remote controller failure
- 11) Outdoor unit failure (Refer to IX [7] Troubleshooting Using the Outdoor Unit LED Error Display.)(page 272)

(2) Check method and remedy

- 1) **When 2) and 3) above apply, check code 7102 will be displayed on the self-diagnosis LED.**

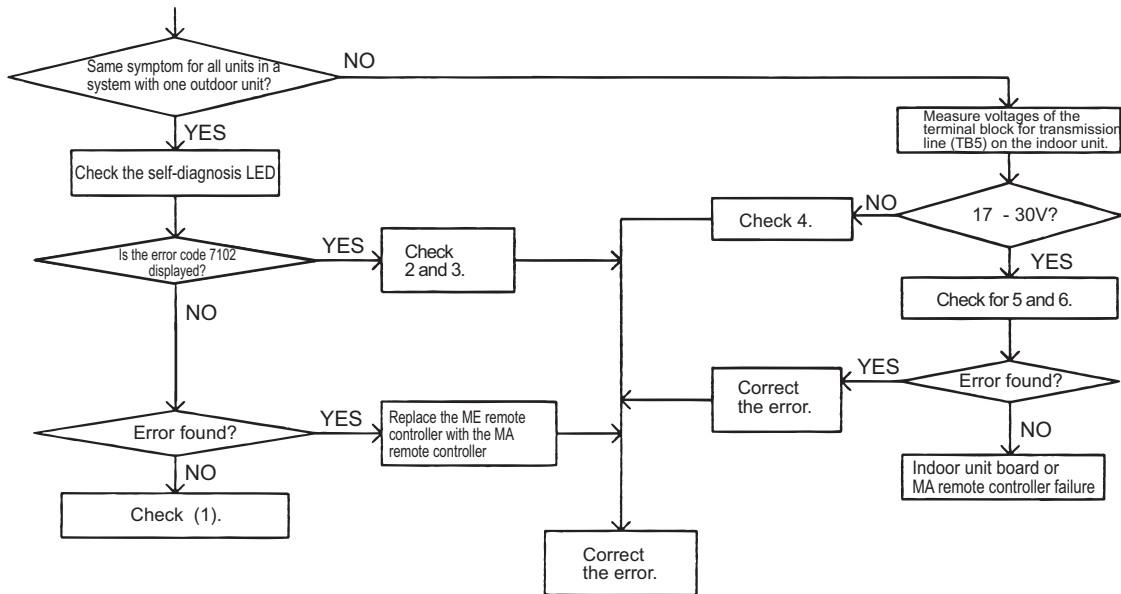

See Section IX [4] -7- (2) Troubleshooting transmission power circuit of outdoor unit for how to check the items in Section 1 in the flowchart above.(page 267)

Flow chart

Even if the operation button on the remote controller is pressed, the indoor and the outdoor units do not start running.

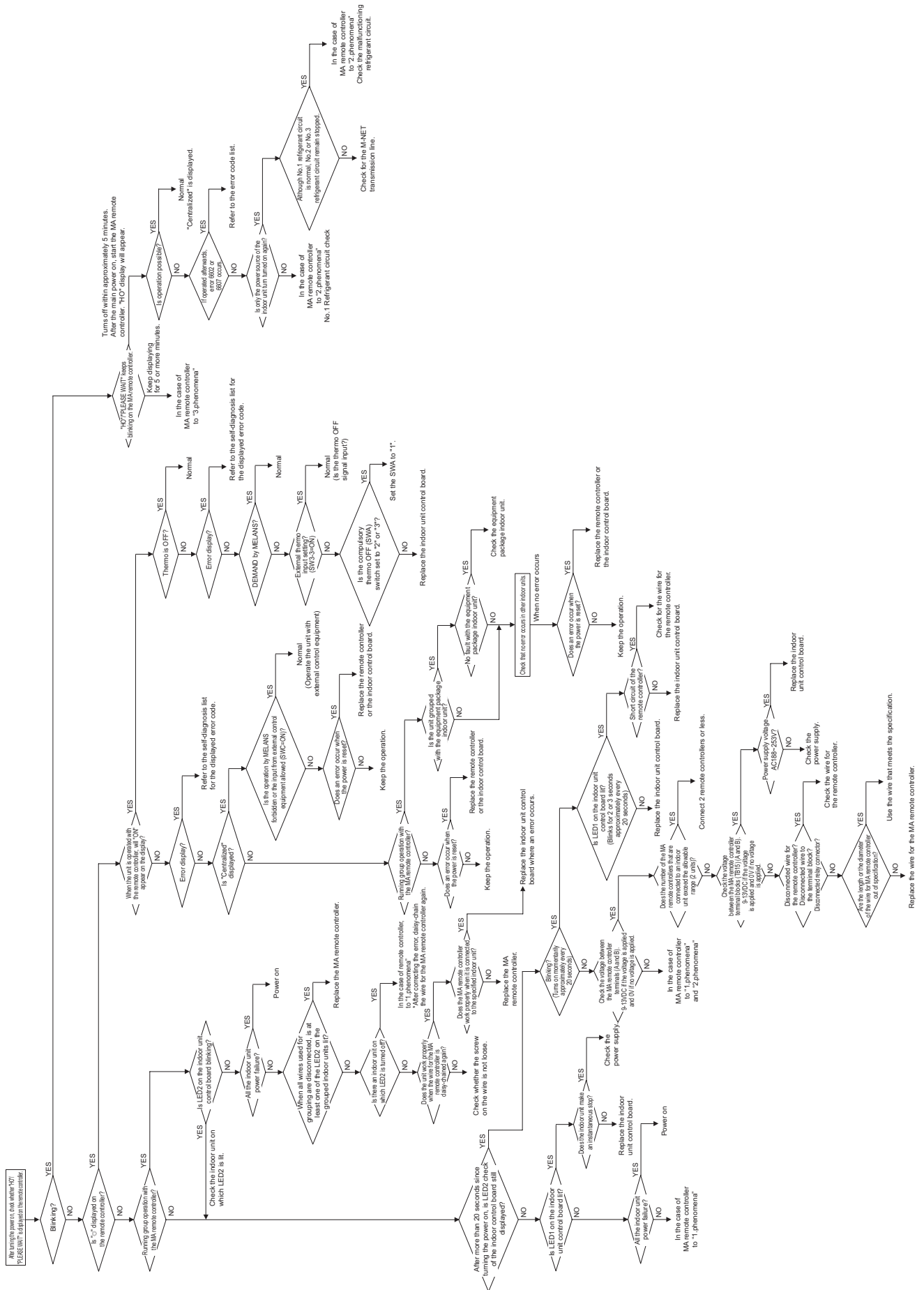

In case of ME remote controller

1. Phenomena

Even if the operation button on the remote controller is pressed, the display remains unlit and the unit does not start running. (Power indicator ☉ does not appear on the screen.)

(1) Cause

- 1) The power for the M-NET transmission line is not supplied from the outdoor unit.
- 2) Short circuit of the transmission line.
- 3) Incorrect wiring of the M-NET transmission line on the outdoor unit.
 - Disconnected wire for the MA remote controller or disconnected line to the terminal block.
 - The indoor transmission line is connected incorrectly to the transmission terminal block for centralized controller (TB7).
- 4) Disconnected transmission line on the remote controller.
- 5) Remote controller failure
- 6) Outdoor unit failure (Refer to IX [7] Troubleshooting Using the Outdoor Unit LED Error Display)(page 272)

(2) Check method and remedy

- 1) Check voltage of the transmission terminal block for of the ME remote controller.
 - If voltage between is 17V and 30V -> ME remote controller failure
 - When voltage is 17V or less -> Refer to IX [4] -7- (2) " Troubleshooting transmission power circuit of outdoor unit".(page 267)
- 2) **When 2) and 3) above apply, check code 7102 will be displayed on the self-diagnosis LED.**

In case of ME remote controller

2. Phenomena

When the remote controller operation SW is turned on, a temporary operation display is indicated, and the display lights out immediately.

(1) Cause

- 1) The power is not supplied to the indoor unit.
 - The main power of the indoor unit (AC220V) is not on.
 - The connector on the indoor unit board has come off.
 - The fuse on the indoor unit board has melted.
 - Transformer failure and disconnected wire of the indoor unit
 - The indoor unit board failure
- 2) The outdoor control board failure
 - As the indoor unit does not interact with the outdoor unit, the outdoor unit model cannot be recognized.

(2) Check method and remedy

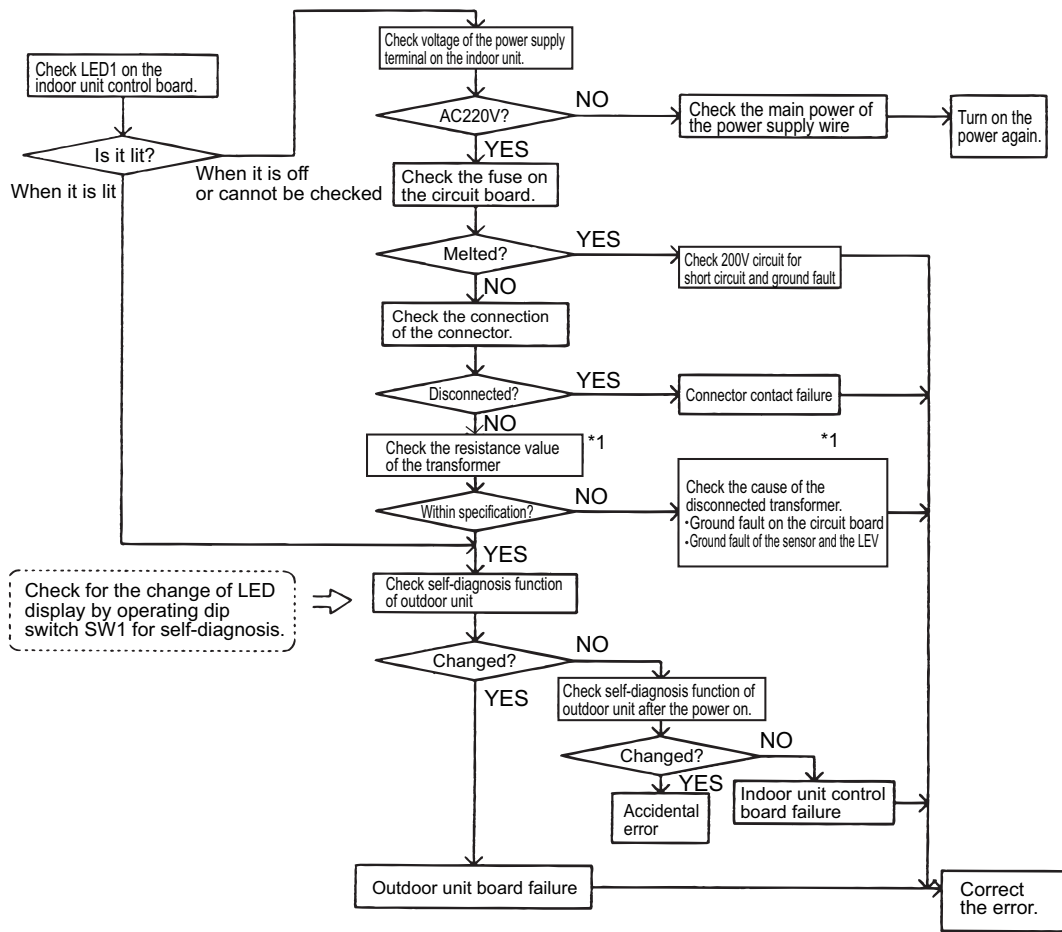

*1. Refer to the parts catalog "transformer check".

In case of ME remote controller

3. Phenomena

"HO" display on the remote controller does not disappear, and no operation is performed even if the button is pressed.

(1) Cause

Without using MELANS

- 1) Outdoor unit address is set to "00"
- 2) A wrong address is set.
 - The address of the indoor unit that is connected to the remote controller is incorrect. (It should equal the ME remote controller address plus 100.)
 - A wrong address is set to the ME remote controller. (100 must be added to the address of the indoor unit.)
- 3) Faulty wiring of the terminal block for transmission line (TB5) of the indoor unit in the same group with the remote controller.
- 4) The centralized control switch (SW2-1) on the outdoor unit is set to ON.
- 5) Disconnection or faulty wiring of indoor unit transmission line.
- 6) Disconnection between the terminal block for M-NET line connection (TB5) of the indoor unit and the male connector (CN2M)
- 7) The male power supply connectors on 2 or more outdoor units are connected to the female power supply switch connector (CN40) for the transmission line for centralized control.
- 8) Outdoor unit control board failure
- 9) Outdoor unit control board failure
- 10) Remote controller failure

Interlocking control with MELANS

- 1) No group registration is made using MELANS. (The indoor unit and the ME remote controller are not grouped.)
- 2) Disconnected transmission line for centralized control (TB7) of the outdoor unit
- 3) The male power supply connector is connected to CN40 on more than one outdoor unit, or the connector is connected to CN40 on the outdoor unit in the system to which a power supply unit for transmission line is connected.

Using MELANS

- 1) When MELANS is used, "HO" display on the remote controller will disappear when the indoor unit and the local remote controller (ME remote controller) are grouped.
If "HO" does not disappear after the registration, check the causes (2) 1) - 3).

(2) Check method and remedy

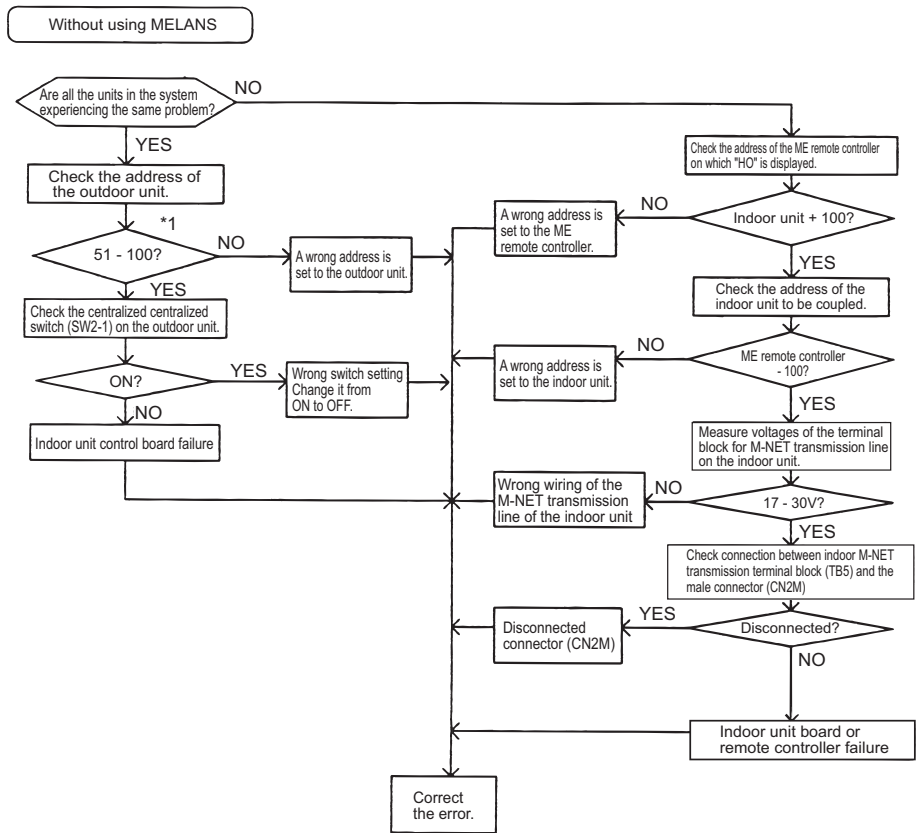

*1. When the indoor unit address is set to 1 - 50, the address will be forcibly set to 100.

In case of ME remote controller

4. Phenomena

"88" appears on the remote controller when the address is registered or confirmed.

(1) Cause, check method and remedy



Cause	Check method and remedy
An error occurs when the address is registered or confirmed. (common)	
1. A wrong address is set to the unit to be coupled.	(1) Confirm the address of unit to be coupled.
2. The transmission line of the unit to be coupled is disconnected or is not connected.	(2) Check the connection of transmission line.
3. Circuit board failure of the unit to be coupled	(3) Check voltage of the terminal block for transmission line of the unit to be coupled.
4. Improper transmission line work	1) Normal if voltage is between DC17 and 30V. 2) Check (5) in case other than 1).
Generates at interlocking registration between LOSSNAY and the indoor unit	
5. The power of LOSSNAY is OFF.	(5) Check for the main power of LOSSNAY.
Generates at confirmation of controllers used in the system in which the indoor units connected to different outdoor units are grouped	
6. The power of the outdoor unit to be confirmed has been cut off.	(6) Check the power supply of the outdoor unit which is coupled with the unit to be confirmed.
7. Transmission line is disconnected from the terminal block for central control system connection (TB7) on the outdoor unit.	(7) Check that the transmission line for centralized control (TB7) of the outdoor unit is not disconnected.
8. When the indoor units connected to different outdoor units are grouped without MELANS, the male power supply connector is not connected to the female power supply switch connector (CN40) for the transmission line for centralized control.	(8) Check voltage of the transmission line for centralized control.
9. The male power supply connectors on 2 or more outdoor units are connected to the female power supply switch connector (CN40) for the transmission line for centralized control.	1) Normal when voltage is between 10V and 30V
10. In the system to which MELANS is connected, the male power supply connector is connected to the female power supply switch connector (CN40) for the transmission line for centralized control.	2) Check 8 - 11 described on the left in case other than 1).
11. Short circuit of the transmission line for centralized control	

Both for MA remote controller and ME remote controller

1. Phenomena

Although cooling operation starts with the normal remote controller display, the capacity is not enough

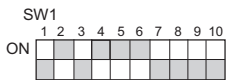
(1) Cause, check method and remedy

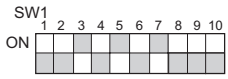
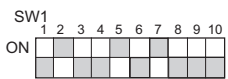
Cause	Check method and remedy
<p>1. Compressor frequency does not rise sufficiently.</p> <ul style="list-style-type: none"> ♦Faulty detection of pressure sensor. ♦Protection works and compressor frequency does not rise due to high discharge temperature ♦Protection works and compressor frequency does not rise due to high pressure ♦Pressure drops excessively. 	<p>(1) Check pressure difference between the detected pressure by the pressure sensor and the actual pressure with self-diagnosis LED. -> If the accurate pressure is not detected, check the pressure sensor. (Refer to the page on Troubleshooting of Pressure Sensor).</p> <p>Note: Lower inlet pressure by the low pressure sensor than the actual pressure causes insufficient capacity. SW1 setting</p> <p>High pressure sensor</p>  <p>Low pressure sensor</p>  <p>(2) Check temperature difference between the evaporating temperature (Te) and the target evaporating temperature (Tem) with self-diagnosis LED.</p> <p>Note: Higher Te than Tem causes insufficient capacity. SW1 setting</p> <p>Evaporating temperature Te</p>  <p>Target evaporating temperature Tem</p>  <p>Note: Protection works and compressor frequency does not rise even at higher Te than Tem due to high discharge temperature and high pressure. At high discharge temperature: Refer to 1102.(page 185) At high pressure: Refer to 1302.(page 187)</p>
<p>2. Indoor unit LEV malfunction</p> <ul style="list-style-type: none"> ♦Insufficient refrigerant flows due to LEV malfunction (not enough opening) or protection works and compressor frequency does not rise due to pressure drop. ♦Refrigerant leak from LEV on the stopping unit causes refrigerant shortage on the running unit. 	<p>Refer to the page of LEV troubleshooting ([4] -5).(page 252)</p>
<p>3. RPM error of the outdoor unit FAN</p> <ul style="list-style-type: none"> ♦Motor failure or board failure, or airflow rate decrease due to clogging of the heat exchanger ♦The fan is not properly controlled as the outdoor temperature cannot be precisely detected by the temperature sensor. ♦The fan is not properly controlled as the pressure cannot be precisely detected by the pressure sensor. 	<p>Refer to the page on troubleshooting of the outdoor unit fan. Refer to 5106.(page 205) Refer to 1302.(page 187)</p>

Cause	Check method and remedy
4. Long piping length The cooling capacity varies greatly depending on the pressure loss. (When the pressure loss is large, the cooling capacity drops.)	Check the piping length to determine if it is contributing to performance loss. Piping pressure loss can be estimated from the temperature difference between the indoor unit heat exchanger outlet temperature and the saturation temperature (Te) of 63LS. ->Correct the piping.
5. Piping size is not proper (thin)	
6. Insufficient refrigerant amount Protection works and compressor frequency does not rise due to high discharge temperature.	Refer to 1-1. (Compressor frequency does not rise sufficiently.)Refer to the page on refrigerant amount adjustment
7. Clogging by foreign object	Check the temperature difference between in front of and behind the place where the foreign object is clogging the pipe (upstream side and downstream side). When the temperature drops significantly, the foreign object may clog the pipe. -> Remove the foreign object inside the pipe.
8. The indoor unit inlet temperature is excessively. (Less than 15°C [59°F] WB)	Check the inlet air temperature and for short cycling. Change the environment where the indoor unit is used.
9. Compressor failure The amount of circulating refrigerant decreases due to refrigerant leak in the compressor.	Check the discharge temperature to determine if the refrigerant leaks, as it rises if there is a leak.
10. LEV1 malfunction Sufficient liquid refrigerant is not be supplied to the indoor unit as sufficient sub cool cannot be secured due to LEV1 malfunction.	Refer to the page of LEV troubleshooting ([4] -5-).(page 252) It most likely happens when there is little difference or no difference between TH3 and TH6.
11. TH3, TH6 and 63HS1 sensor failure or faulty wiring LEV1 is not controlled normally.	<ul style="list-style-type: none"> •Check the thermistor. •Check wiring.
12. LEV2 actuation failure A drop in the low pressure that is caused either by a blockage of liquid pipe or by a pressure loss and the resultant slowing of refrigerant flow causes a tendency for the discharge temperature to rise.	Refer to the page on troubleshooting the LEV ([4] -5-).(page 252)

2. Phenomena

Although heating operation starts with the normal remote controller display, the capacity is not enough.

(1) Cause, check method and remedy

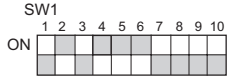
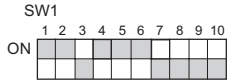
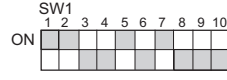
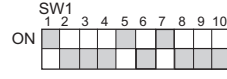
Cause	Check method and remedy
<p>1. Compressor frequency does not rise sufficiently.</p> <ul style="list-style-type: none"> •Faulty detection of pressure sensor. •Protection works and compressor frequency does not rise due to high discharge temperature •Protection works and compressor frequency does not rise due to high pressure. 	<p>(1) Check pressure difference between the detected pressure by the pressure sensor and the actual pressure with self-diagnosis LED. -> If the accurate pressure is not detected, check the pressure sensor.(Refer to the page on Troubleshooting of Pressure Sensor)</p> <p>Note: Higher inlet pressure by the high pressure sensor than the actual pressure causes insufficient capacity. SW1 setting</p> <p>High pressure sensor</p>  <p>Low pressure sensor</p>  <p>(2) Check the difference between the condensing temperature (Tc) and the target condensing temperature (Tcm) with self-diagnosis LED.</p> <p>Note: Higher Tc than Tcm causes insufficient capacity. SW1 setting</p> <p>Condensing temperature Tc</p>  <p>Target condensing temperature Tcm</p>  <p>Note: Protection works and compressor frequency does not rise even at lower Tc than Tcm due to high discharge temperature and high pressure. At high discharge temperature: Refer to 1102.(page 185) At high pressure: Refer to 1302.(page 187)</p>

Cause	Check method and remedy
2. Indoor unit LEV malfunction Insufficient refrigerant flows due to LEV malfunction (not enough opening).	Refer to the page of LEV troubleshooting ([4] -5-).(page 252)
3. Temperature reading error on the indoor unit piping temperature sensor If the temperature reading on the sensor is higher than the actual temperature, it makes the subcool seem smaller than it is, and the LEV opening decreases too much.	Check the thermistor.
4. RPM error of the outdoor unit FAN ♦Motor failure or board failure, or airflow rate decrease, pressure drop due to clogging of the heat exchanger leading to high discharge temperature ♦The fan is not properly controlled as the temperature cannot be precisely detected with the piping sensor.	Refer to the page on outdoor unit fan ([4] -4-).(page 251)
5. Insulation failure of the refrigerant piping	
6. Long piping length Excessively long piping on the high pressure side causes pressure loss leading to increase in the high pressure.	Confirm that the characteristic of capacity drop due to piping length. -> Change the pipe
7. Piping size is not proper (thin)	
8. Clogging by foreign object	Check the temperature difference between the upstream and the downstream of the pipe section that is blocked. Since blockage in the extended section is difficult to locate, operate the unit in the cooling cycle, and follow the same procedures that are used to locate the blockage of pipe during cooling operation. ->Remove the blockage in the pipe.
9. The indoor unit inlet temperature is excessively high.(exceeding 28°C [82°F])	Check the inlet air temperature and for short cycling. Change the environment where the indoor unit is used.
10. Insufficient refrigerant amount Protection works and compressor frequency does not rise due to low discharge temperature Refrigerant recovery operation is likely to start.	Refer to 2 - 1. (Compressor frequency does not rise sufficiently).(page 242) Refer to the page on refrigerant amount adjustment.(page 109)
11. Compressor failure (same as in case of cooling)	Check the discharge temperature.
12. LEV2 actuation failure A drop in the low pressure that is caused either by a blockage of liquid pipe or by a pressure loss and the resultant slowing of refrigerant flow causes a tendency for the discharge temperature to rise.	Refer to the page on troubleshooting the LEV ([4] -5-).(page 252)

3. Phenomena

Outdoor unit stops at times during operation.

(1) Cause, check method and remedy

Cause	Check method and remedy
<p>The first stop is not considered as an error, as the unit turns to anti-restart mode for 3 minutes as a preliminary error.</p> <p>Error mode</p> <p>1) Abnormal high pressure</p> <p>2) Abnormal discharge air temperature</p> <p>3) Heatsink thermistor failure</p> <p>4) Thermistor failure</p> <p>5) Pressure sensor failure</p> <p>6) Over-current break</p> <p>7) Refrigerant overcharge</p> <p>Note1: Frost prevention tripping only under cooling mode may be considered in addition to the above. (Freeze protection is detected by one or all indoor units.)</p> <p>Note2: Even the second stop is not considered as an error when some specified errors occur. (eg. The third stop is considered as an error when the thermistor error occurs.)</p>	<p>(1) Check the mode operated in the past by displaying preliminary error history on LED display with SW1.</p> <p>(2) Reoperate the unit to find the mode that stops the unit by displaying preliminary error history on LED display with SW1. Refer to the reference page for each error mode.</p> <p>*Display the indoor piping temperature table with SW1 to check whether the freeze proof operation runs properly, and check the temperature.</p>

[3] Investigation of Transmission Wave Shape/Noise

1. M-NET transmission

Control is performed by exchanging signals between the outdoor unit and the indoor unit (ME remote controller) through M-NET transmission. Noise interference on the transmission line will interrupt the normal transmission, leading to erroneous operation.

(1) Symptoms caused by noise interference on the transmission line

Cause	Erroneous operation	Error code	Error code definition
Noise interference on the transmission line	Signal is transformed and will be misjudged as the signal of another address.	6600	Address overlap
	Transmission wave pattern is transformed due to the noise creating a new signal	6602	Transmission processor hardware error
	Transmission wave pattern is transformed due to the noise, and will not be received normally leading to no acknowledgement (ACK).	6607	No ACK error
	Transmission cannot be performed due to the fine noise.	6603	Transmission line bus busy error
	Transmission is successful; however, the acknowledgement (ACK) or the response cannot be received normally due to the noise.	6607 6608	No ACK error No response error

(2) Wave shape check

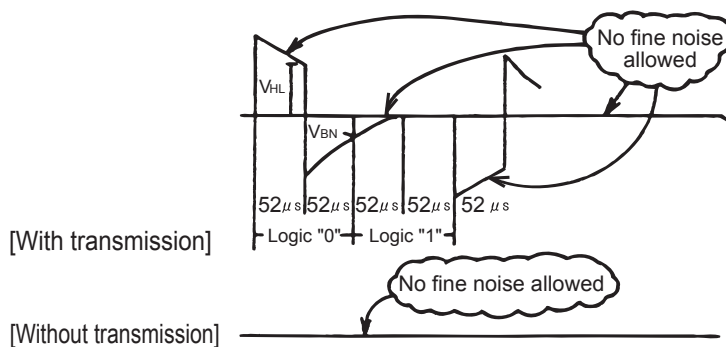

Wave shape check

Check the wave pattern of the transmission line with an oscilloscope. The following conditions must be met.

- Small wave pattern (noise) must not exist on the transmission signal. (Minute noise (approximately 1V) can be generated by DC-DC converter or the inverter operation; however, such noise is not a problem when the shield of the transmission line is grounded.)
- The sectional voltage level of transmission signal should be as follows.

Logic	Voltage level of the transmission line
0	$V_{HL} = 2.5V$ or higher
1	$V_{BN} = 1.3V$ or below

(3) Check method and remedy

1) Measures against noise

Check the followings when noise exists on the wave or the errors described in (1) occur.

	Error code definition	Remedy
Check that the wiring work is performed according to wiring specifications.	1. The transmission line and the power line are not wired too closely.	Isolate the transmission line from the power line (5cm [1-31/32"] or more). Do not insert them in the same conduit.
	2. The transmission line is not bundled with that for another systems.	The transmission line must be isolated from another transmission line. When they are bundled, erroneous operation may be caused.
	3. The specified wire is used for the transmission line.	Use the specified transmission line. Type: Shielded wire CVVS/CPEVS/MVVS (For ME remote controller) Diameter: 1.25mm ² [AWG16] or more (Remote controller wire: 0.3 - 1.25mm ² [AWG22-16])
	4. When the transmission line is daisy-chained on the indoor unit terminals, are the shields daisy-chained on the terminals, too?	The transmission is two-wire daisy-chained. The shielded wire must be also daisy-chained. When the shielded cable is not daisy-chained, the noise cannot be reduced enough.
Check that the grounding work is performed according to grounding specifications.	5. Is the shield of the indoor-outdoor transmission cable grounded to the earth terminal on the outdoor unit?	Connect the shield of the indoor-outdoor transmission cable to the earth terminal (⌚) on the outdoor unit. If no grounding is provided, the noise on the transmission line cannot escape leading to change of the transmission signal.
	6. Check the treatment method of the shield of the transmission line (for centralized control).	The transmission cable for centralized control is less subject to noise interference if it is grounded to the outdoor unit whose power jumper cable was moved from CN41 to CN40 or to the power supply unit. The environment against noise varies depending on the distance of the transmission lines, the number of the connected units, the type of the controllers to be connected, or the environment of the installation site. Therefore, the transmission line work for centralized control must be performed as follows. 1. When no grounding is provided: Ground the shield of the transmission cable by connecting to the outdoor unit whose power jumper connector was moved from CN41 to CN40 or to the power supply unit. 2. When an error occurs even though one point grounding is provided: Ground the shield on all outdoor units.

2) Check the followings when the error "6607" occurs, or "HO" appears on the display on the remote controller.

Error code definition	Remedy
7. The farthest distance of transmission line is 200m [656ft] or longer.	Check that the farthest distance from the outdoor unit to the indoor unit and to the remote controller is within 200m [656ft].
8. The types of transmission lines are different.	Use the specified transmission line. Type: Shielded wire CVVS/CPEVS/MVVS (For ME remote controller) Diameter: 1.25mm ² [AWG16] or more (Remote controller wire: 0.3-1.25mm ² [AWG22-16])
9. Outdoor unit circuit board failure	Replace the outdoor unit control board or the power supply board for the transmission line.
10. Indoor unit circuit board failure or remote controller failure	Replace the indoor unit circuit board or the remote controller.
11. The MA remote controller is connected to the M-NET transmission line.	Connect the MA remote controller to the terminal block for MA remote controller (TB15).

2. MA remote controller transmission

The communication between the MA remote controller and the indoor unit is performed with current tone burst.

(1) Symptoms caused by noise interference on the transmission line

If noise is generated on the transmission line, and the communication between the MA remote controller and the indoor unit is interrupted for 3 minutes in a row, MA transmission error (6831) will occur.

(2) Confirmation of transmission specifications and wave pattern

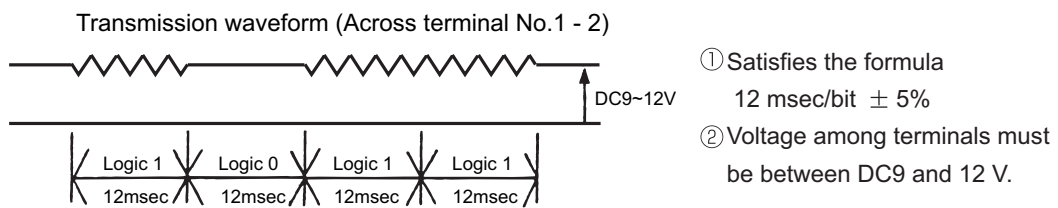
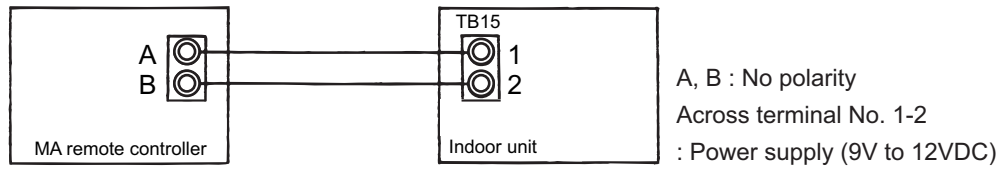

[4] Troubleshooting Principal Parts

-1- High-Pressure Sensor (63HS1)

1. Compare the pressure that is detected by the high pressure sensor, and the high-pressure gauge pressure to check for failure.

By configuring the digital display setting switch (SW1) as shown in the figure below, the pressure as measured by the high-pressure sensor appears on the LED1 on the control board.

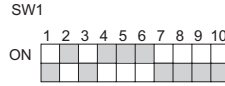

- (1) While the sensor is stopped, compare the gauge pressure and the pressure displayed on self-diagnosis LED1.

- 1) When the gauge pressure is between 0 and 0.098MPa [14psi], internal pressure is caused due to gas leak.
- 2) When the pressure displayed on self-diagnosis LED1 is between 0 and 0.098MPa [14psi], the connector may be defective or be disconnected. Check the connector and go to (4).
- 3) When the pressure displayed on self-diagnosis LED1 exceeds 4.15MPa [601psi], go to (3).
- 4) If other than 1), 2) or 3), compare the pressures while the sensor is running. Go to (2).

- (2) Compare the gauge pressure and the pressure displayed on self-diagnosis LED1 while the sensor is running. (Compare them by MPa [psi] unit.)

- 1) When the difference between both pressures is within 0.098MPa [14psi], both the high pressure sensor and the control board are normal.
- 2) When the difference between both pressures exceeds 0.098MPa [14psi], the high pressure sensor has a problem. (performance deterioration)
- 3) When the pressure displayed on self-diagnosis LED1 does not change, the high pressure sensor has a problem.

- (3) Remove the high pressure sensor from the control board to check the pressure on the self-diagnosis LED1.

- 1) When the pressure displayed on self-diagnosis LED1 is between 0 and 0.098MPa [14psi], the high pressure sensor has a problem.
- 2) When the pressure displayed on self-diagnosis LED1 is approximately 4.15MPa [601psi], the control board has a problem.

- (4) Remove the high pressure sensor from the control board, and short-circuit between the No.2 and 3 connectors (63HS1) to check the pressure with self-diagnosis LED1.

- 1) When the pressure displayed on the self-diagnosis LED1 exceeds 4.15MPa [601psi], the high pressure sensor has a problem.
- 2) If other than 1), the control board has a problem.

2. High-pressure sensor configuration

The high pressure sensor consists of the circuit shown in the figure below. If DC 5V is applied between the red and the black wires, voltage corresponding to the pressure between the white and the black wires will be output, and the value of this voltage will be converted by the microcomputer. The output voltage is 0.071V per 0.098MPa [14psi].

Note

The pressure sensor on the body side is designed to connect to the connector. The connector pin number on the body side is different from that on the control board side.

	Body side	Control board side
Vcc	Pin 1	Pin 3
Vout	Pin 2	Pin 2
GND	Pin 3	Pin 1

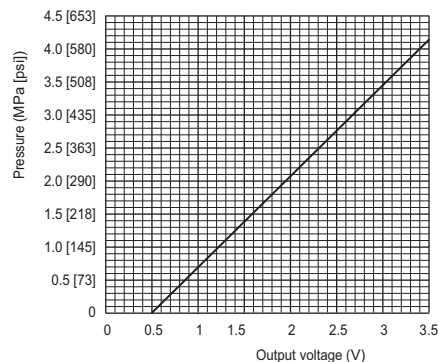
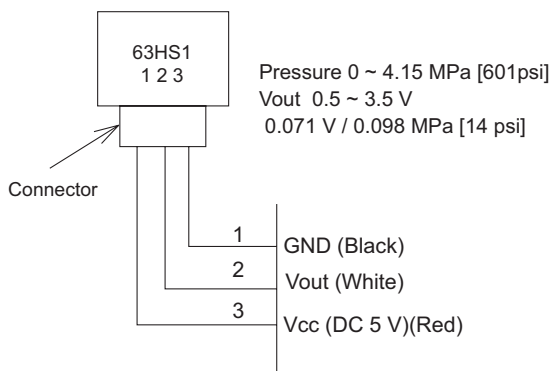

-2- Low-Pressure Sensor (63LS)

1. Compare the pressure that is detected by the low pressure sensor, and the low pressure gauge pressure to check for failure.

By configuring the digital display setting switch (SW1) as shown in the figure below, the pressure as measured by the low-pressure sensor appears on the LED1 on the control board.

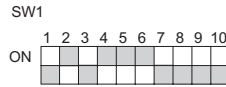

(1) While the sensor is stopped, compare the gauge pressure and the pressure displayed on self-diagnosis LED1.

- 1) When the gauge pressure is between 0 and 0.098MPa [14psi], internal pressure is caused due to gas leak.
- 2) When the pressure displayed on self-diagnosis LED1 is between 0 and 0.098MPa [14psi], the connector may be defective or be disconnected. Check the connector and go to (4).
- 3) When the pressure displayed on self-diagnosis LED1 exceeds 1.7MPa [247psi], go to (3).
- 4) If other than 1), 2) or 3), compare the pressures while the sensor is running. Go to (2).

(2) Compare the gauge pressure and the pressure displayed on self-diagnosis LED1 while the sensor is running.(Compare them by MPa [psi] unit.)

- 1) When the difference between both pressures is within 0.03MPa [4psi], both the low pressure sensor and the control board are normal.
- 2) When the difference between both pressures exceeds 0.03MPa [4psi], the low pressure sensor has a problem. (performance deterioration)
- 3) When the pressure displayed on the self-diagnosis LED1 does not change, the low pressure sensor has a problem.

(3) Remove the low pressure sensor from the control board to check the pressure with the self-diagnosis LED1 display.

- 1) When the pressure displayed on the self-diagnosis LED1 is between 0 and 0.098MPa [14psi], the low pressure sensor has a problem.
- 2) When the pressure displayed on self-diagnosis LED1 is approximately 1.7MPa [247psi], the control board has a problem.
 - When the outdoor temperature is 30°C [86°F] or less, the control board has a problem.
 - When the outdoor temperature exceeds 30°C [86°F], go to (5).

(4) Remove the low pressure sensor from the control board, and short-circuit between the No.2 and 3 connectors (63LS:CN202) to check the pressure with the self-diagnosis LED1.

- 1) When the pressure displayed on the self-diagnosis LED1 exceeds 1.7MPa [247psi], the low pressure sensor has a problem.
- 2) If other than 1), the control board has a problem.

(5) Remove the high pressure sensor (63HS1) from the control board, and insert it into the connector for the low pressure sensor (63LS) to check the pressure with the self-diagnosis LED1.

- 1) When the pressure displayed on the self-diagnosis LED1 exceeds 1.7MPa [247psi], the control board has a problem.
- 2) If other than 1), the control board has a problem.

2. Low-pressure sensor configuration

The low pressure sensor consists of the circuit shown in the figure below. If DC5V is applied between the red and the black wires, voltage corresponding to the pressure between the white and the black wires will be output, and the value of this voltage will be converted by the microcomputer. The output voltage is 0.173V per 0.098MPa [14psi].

Note

The pressure sensor on the body side is designed to connect to the connector. The connector pin number on the body side is different from that on the control board side.

	Body side	Control board side
Vcc	Pin 1	Pin 3
Vout	Pin 2	Pin 2
GND	Pin 3	Pin 1

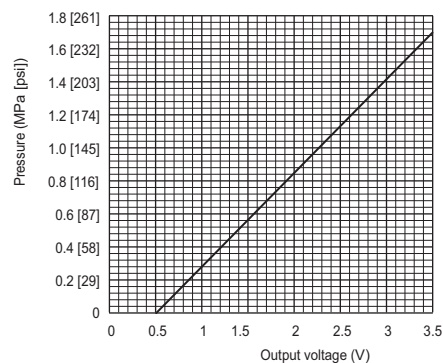
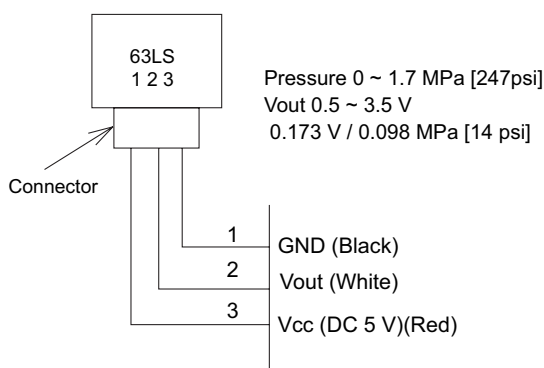

-3- Solenoid Valve

Check whether the output signal from the control board and the operation of the solenoid valve match. Setting the self-diagnosis switch (SW1) as shown in the figure below causes the ON signal of each relay to be output to the LED's. Each LED shows whether the relays for the following parts are ON or OFF. LEDs light up when relays are ON.

Note

The circuits on some parts are closed when the relays are ON. Refer to the following instructions.

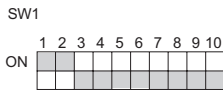
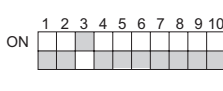
SW1		Display							
		LD1	LD2	LD3	LD4	LD5	LD6	LD7	LD8
	Upper	21S4a		CH11		SV1a			
	Lower			21S4b	SV5b				
	Upper				SV5c	21S4c		SV9	
	Lower								

When a valve malfunctions, check if the wrong solenoid valve coil is not attached the lead wire of the coil is not disconnected, the connector on the board is not inserted wrongly, or the wire for the connector is not disconnected.

(1) In case of 21S4a (4-way switching valve)

About this 4-way valve

When not powered:

Conducts electricity between the oil separator outlet and heat exchanger, and between the gas ball valve (BV1) and the accumulator to complete the circuit for the cooling cycle.

When powered:

The electricity runs between the oil separator and the gas ball valve, and between the heat exchanger and the accumulator. This circulation is for heating.

Check the LED display and the intake and the discharge temperature for the 4-way valve to check whether the valve has no faults and the electricity runs between where and where. Do not touch the pipe when checking the temperature, as the pipe on the oil separator side will be hot.

Note

Do not give an impact from outside, as the outer hull will be deformed leading to the malfunction of the inner valve.

(2) In case of 21S4b (4-way switching valve), 21S4c (4-way switching valve) (only for P350-P450, EP250, and EP300 models)

About this 4-way valve

When not powered:

Conducts electricity between the oil separator outlet and the heat exchanger1 (the top heat exchanger) and opens and closes the heat exchanger circuit for the heating and cooling cycles.

When powered:

The electricity runs between the heat exchanger and the accumulator, and the valve opens or closes the heat exchanger circuit when cooling or heating.

Whether the valve has no fault can be checked by checking the LED display and the switching sound; however, it may be difficult to check by the sound, as the switching coincides with 21S4b or 21S4c. In this case, check the intake and the discharge temperature for the 4-way valve to check that the electricity runs between where and where.

Note

- Do not touch the valve when checking the temperature, as it will be hot.
- Do not give an impact from outside, as the outer hull will be deformed leading to the malfunction of the inner valve.

(3) In case of SV1a (Bypass valve)

This solenoid valve opens when powered (Relay ON).

- 1) At compressor start-up, the SV1a turns on for 4 minutes, and the operation can be checked by the self-diagnosis LED display and the closing sound.
- 2) To check whether the valve is open or closed, check the change of the SV1a downstream piping temperature while the valve is being powered. Even when the valve is closed, high-temperature refrigerant flows inside the capillary next to the valve. (Therefore, temperature of the downstream piping will not be low with the valve closed.)

(4) In the case of SV5b (Solenoid valve) , SV5c (Solenoid valve) (only for P350-P450, EP250, and EP300 models)

This solenoid valve is a switching valve that opens when energized. Proper operation of this valve can be checked on the LED and by the switching sound. During the cooling mode, SV5b and 21S4b, SV5c and 21S4c, are switched simultaneously, which may make it difficult to check for proper operation of the SV5b or SV5c by listening for the switching sound. If this is the case, the temperature before and after SV5b or SV5c can be used to determine if the refrigerant is the pipe.

(5) In the case of SV9 (Solenoid valve)

This solenoid valve is a switching valve that opens when energized. Proper operation of this valve can be checked on the LED display and by the switching sound.

Note

Do not give an impact from outside, as the outer hull will be deformed leading to the malfunction of the inner valve.

-4- Outdoor Unit Fan

- To check the revolution of the fan, check the inverter output state on the self-diagnosis LED, as the inverter on the outdoor fan controls the revolutions of the fan.
- When starting the fan, the fan runs at full speed for 5 seconds.
- When setting the DIP SW1 as shown in the figure below, the inverter output [%] will appear. 100% indicates the full speed and 0% indicates the stopping.

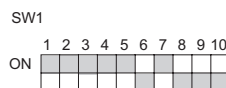

- As the revolution of the fan changes under control, at the interphase or when the indoor unit operation capacity is low, the revolution of the fan may change.
- If the fan does not move or it vibrates, Fan board problem or fan motor problem is suspected. Refer to IX [4] -6- (2) [5] "Check the fan motor ground fault or the winding."(page 261) and IX [4] -6- (2) [6] "Check the Fan board failure."(page 262)

-5- LEV

LEV operation

LEV (Indoor unit: Linear expansion valve), LEV2a, and LEV2b (Outdoor unit: Linear expansion valve) are stepping-motor-driven valves that operate by receiving the pulse signals from the indoor and outdoor unit control boards.

(1) Indoor LEV and Outdoor LEV (LEV2a, LEV2b)

The valve opening changes according to the number of pulses.

1) Indoor and outdoor unit control boards and the LEV (Indoor unit: Linear expansion valve)

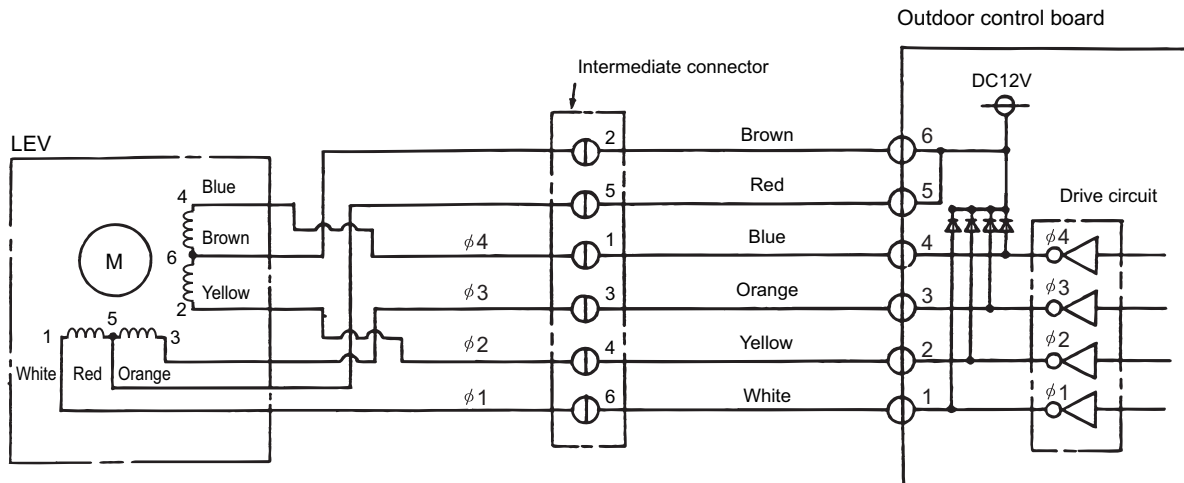

Note. The connector numbers on the intermediate connector and the connector on the control board differ. Check the color of the lead wire to judge the number.

2) Pulse signal output and valve operation

Output (phase) number	Output state			
	1	2	3	4
$\phi 1$	ON	OFF	OFF	ON
$\phi 2$	ON	ON	OFF	OFF
$\phi 3$	OFF	ON	ON	OFF
$\phi 4$	OFF	OFF	ON	ON

Output pulses change in the following orders when the Valve is closed; 1 → 2 → 3 → 4 → 1
 Valve is open; 4 → 3 → 2 → 1 → 4

- *1. When the LEV opening angle does not change, all the output phases will be off.
- *2. When the output is open phase or remains ON, the motor cannot run smoothly, and rattles and vibrates.

3) LEV valve closing and opening operation

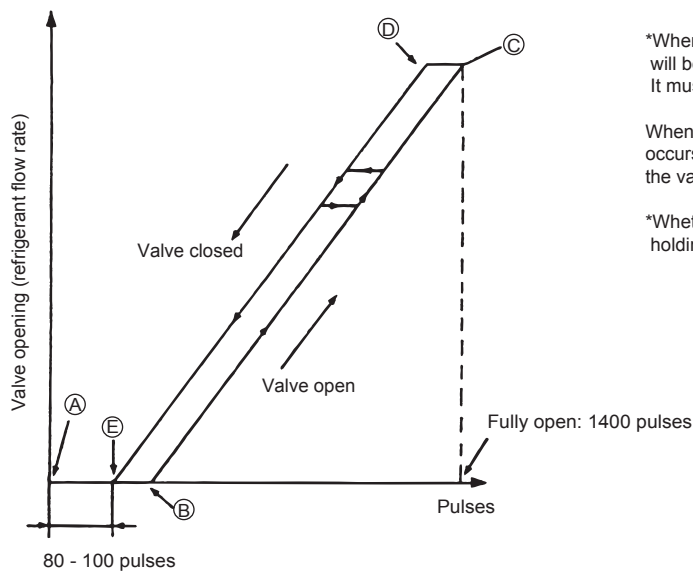

*When the power is turned on, the valve closing signal of 2200 pulses will be output from the indoor board to LEV to fix the valve position. It must be fixed at point (A)

When the valve operates smoothly, no sound from LEV or no vibration occurs, however, when the pulses change from (E) to (A) in the chart or the valve is locked, a big sound occurs.

*Whether a sound is generated or not can be determined by holding a screwdriver against it, then placing your ear against the handle.

(2) Outdoor LEV (LEV1)

The valve opening changes according to the number of pulses.

1) Connections between the outdoor control board and LEV1 (outdoor expansion valve)

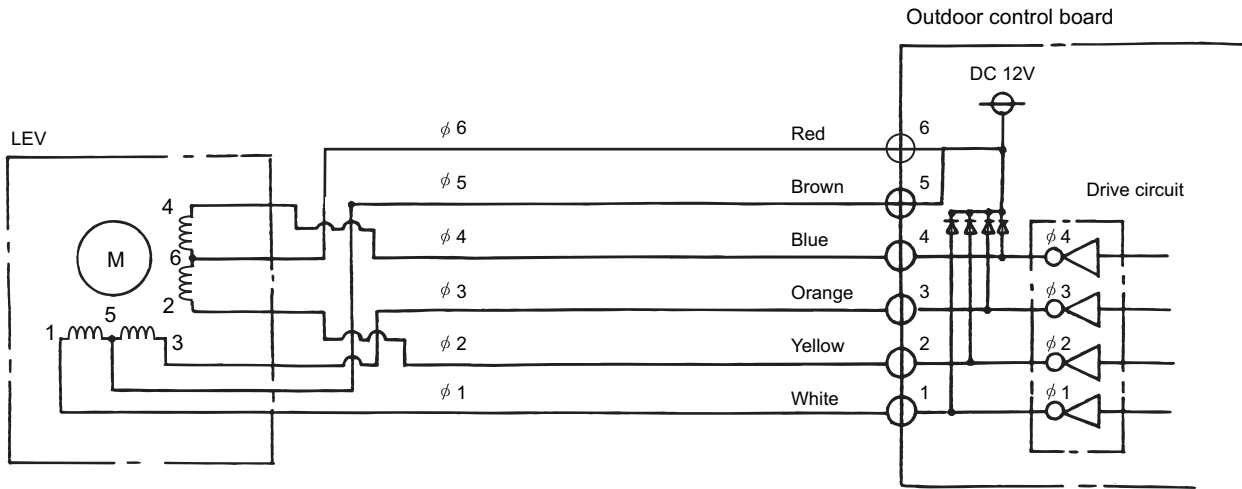

2) Pulse signal output and valve operation

Output (phase) number	Output state							
	1	2	3	4	5	6	7	8
φ 1	ON	OFF	OFF	OFF	OFF	OFF	ON	ON
φ 2	ON	ON	ON	OFF	OFF	OFF	OFF	OFF
φ 3	OFF	OFF	ON	ON	ON	OFF	OFF	OFF
φ 4	OFF	OFF	OFF	OFF	ON	ON	ON	OFF

Output pulses change in the following orders when the
 Valve is open; 1 → 2 → 3 → 4 → 5 → 6 → 7 → 8 → 1
 Valve is closed; 8 → 7 → 6 → 5 → 4 → 3 → 2 → 1 → 8

- *1. When the LEV opening angle does not change, all the output phases will be off.
- *2. When the output is open phase or remains ON, the motor cannot run smoothly, and rattles and vibrates.

3) LEV valve closing and opening operation

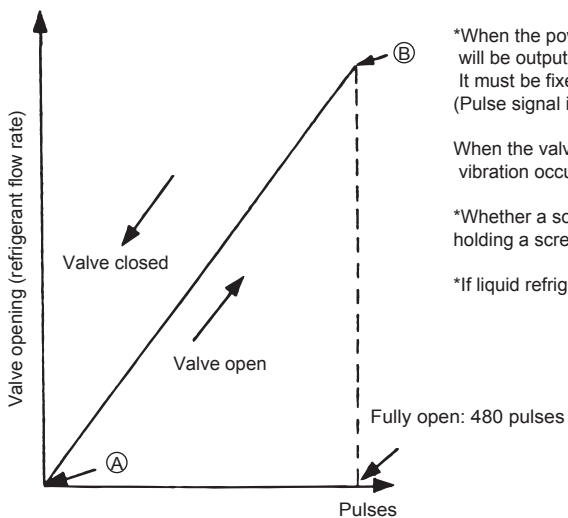

*When the power is turned on, the valve closing signal of 520 pulses will be output from the indoor board to LEV to fix the valve position. It must be fixed at point (A) (Pulse signal is output for approximately 17 seconds.)

When the valve operates smoothly, there is no sound from the LEV and no vibration occurs, but when the valve is locked, noise is generated.

*Whether a sound is generated or not can be determined by holding a screwdriver against it, then placing your ear against the handle.

*If liquid refrigerant flows inside the LEV, the sound may become smaller.

(3) Judgment methods and possible failure mode

Note

The specifications of the outdoor unit (outdoor LEV) and the indoor unit (indoor LEV) differ. Therefore, remedies for each failure may vary. Check the remedy specified for the appropriate LEV as indicated in the right column.

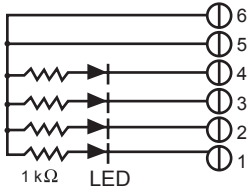
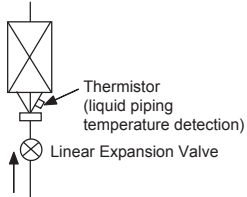
Malfunction mode	Judgment method	Remedy	Target LEV
Microcomputer driver circuit failure	<p>Disconnect the control board connector and connect the check LED as shown in the figure below.</p>  <p>resistance : 0.25W 1kΩ LED : DC15V 20mA or more</p> <p>When the main power is turned on, the indoor unit circuit board outputs pulse signals to the indoor unit LEV for 10 seconds, and the outdoor unit circuit board outputs pulse signals to the outdoor unit LEV for 17 seconds.</p> <p>If any of the LED remains lit or unlit, the drive circuit is faulty.</p>	When the drive circuit has a problem, replace the control board.	Indoor Outdoor
LEV mechanism is locked	If the LEV is locked, the drive motor runs idle, and makes a small clicking sound. When the valve makes a closing and opening sound, the valve has a problem.	Replace the LEV.	Indoor Outdoor
Disconnected or short-circuited LEV motor coil	Measure resistance between the coils (red - white, red -orange, brown - yellow, brown - blue) using a tester. They are normal if resistance is 150ohm ± 10%.	Replace the LEV coils.	Indoor Outdoor (LEV2a, LEV2b)
	Measure resistance between the coils (red - white, red -orange, brown - yellow, brown - blue) using a tester. They are normal if resistance is 46ohm ± 3%.	Replace the LEV coils.	Outdoor (LEV1)
Incomplete sealing (leak from the valve)	<p>When checking the refrigerant leak from the indoor LEV, run the target indoor unit in the fan mode, and the other indoor units in the cooling mode. Then, check the liquid temperature (TH22) with the self-diagnosis LED.</p> <p>When the unit is running in the fan mode, the LEV is fully closed, and the temperature detected by the thermistor is not low. If there is a leak, however, the temperature will be low. If the temperature is extremely low compared with the inlet temperature displayed on the remote controller, the LEV is not properly sealed, however, if there is a little leak, it is not necessary to replace the LEV when there are no effects to other parts.</p> 	If there is a large amount of leakage, replace the LEV.	Indoor
Faulty wire connections in the connector or faulty contact	<ol style="list-style-type: none"> Check for loose pins on the connector and check the colors of the lead wires visually Disconnect the control board's connector and conduct a continuity check using a tester. 	Check the continuity at the points where an error occurs.	Indoor Outdoor

(4) Outdoor unit LEV (LEV1) coil removal procedure

1) LEV component

As shown in the figure, the outdoor LEV is made in such a way that the coils and the body can be separated.

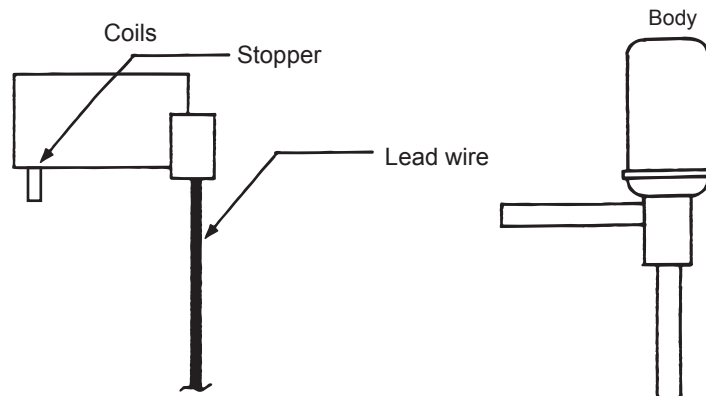

2) Removing the coils

Fasten the body tightly at the bottom (Part A in the figure) so that the body will not move, then pull out the coils toward the top. If the coils are pulled out without the body gripped, undue force will be applied and the pipe will be bent.

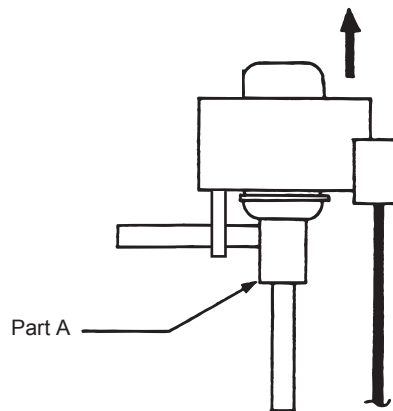

3) Installing the coils

Fix the body tightly at the bottom (Part A in the figure) so that the body will not move, then insert the coils from the top, and insert the coil stopper securely in the pipe on the body. Hold the body when pulling out the coils to prevent so that the pipe will not be bent.

If the coils are pushed without the body gripped, undue force will be applied and the pipe will be bent. Hold the body when pulling out the coils to prevent so that the pipe will not be bent.

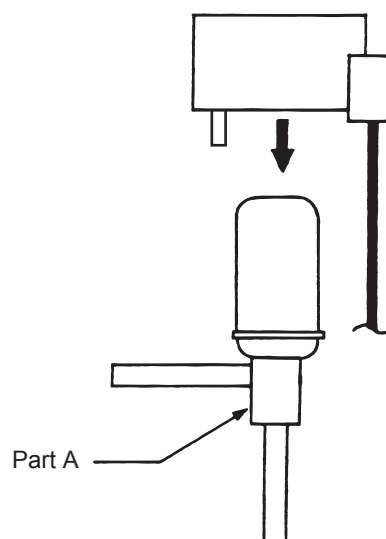

(5) Outdoor unit LEV (LEV2a,2b) coil removal procedure

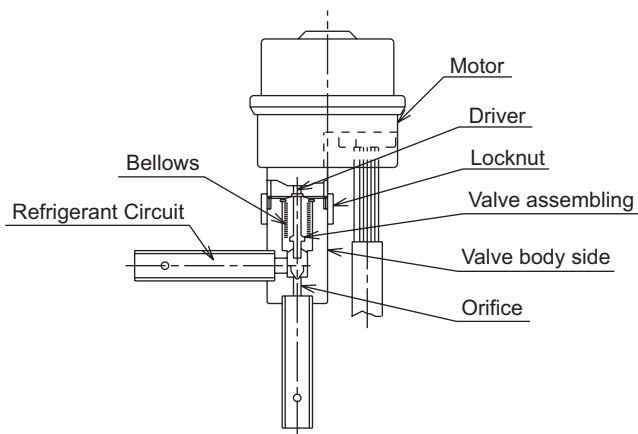

Notes on the procedure

- 1) Do not put undue pressure on the motor.
- 2) Do not use motors if dropped.
- 3) Do not remove the cap until immediately before the procedure.
- 4) Do not wipe off any molybdenum.
- 5) Do not remove the packing.
- 6) Do not apply any other than specified liquid such as screw lock agent, grease and etc.

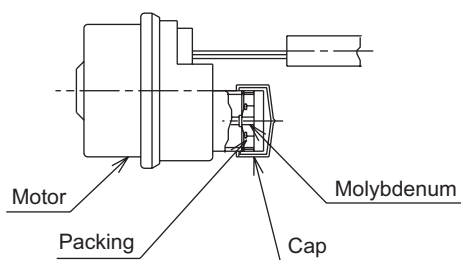

Replacement procedure

- 1) Stop the air conditioner. After checking that the air conditioner is stopped, turn off the power of the outdoor unit.
- 2) Prepare two spanners. Hold the valve body with one spanner and loosen the locknut with another one.
Turning the locknut counter-clockwise from motor side view can loosen it.
Two spanners must be used.
Do not hold the motor with one hand and loosen the locknut with only one spanner.
- 3) Turning the locknut several times. The locknut will come off and then the motor can be removed.
- 4) Prepare a motor replacement. Use only factory settings, which the head part of the driver does not come out. **Use of other than factory settings may result in malfunction and failure of valve flow rate control.**
- 5) Keep dust, contaminants, and water out of the space between the motor and the valve body during replacement. (The space is the mechanical section of the valve.) Do not damage the junction with tools.
After removing the motor, **blow N₂ gas or etc. into bellows in order to blow off water from inside.**
- 6) Remove the cap of the motor replacement. Joint the axis of the motor and the one of the valve body with the locknut to stick precisely. **Apply screw lock agent to whole part of the screw. Do not introduce screw lock agent into the motor.** Use new motors if problems are found on the motor during the replacement.
- 7) After rotating the locknut 2~3 times by hands, hold the valve body with the spanner, and tighten the locknut with the specified torque with a torque wrench. Apply the tightening torque of 15N · m (150kgf · cm) (administration value 15 ± 1 N · m (150 ± 10kgf · cm)).
Note that undue tightening may cause breaking a flare nut.
- 8) When tightening the locknut, hold the motor with hands so that undue rotary torque and load can not be applied.
- 9) The differences of relative position after assembling the motor and the valve body do not affect the valve control and the switching function.
Do not relocate the motor and the valve body after tightening the locknut. Even the relative position is different from before and after assembling.

Difference in rotational direction is acceptable.

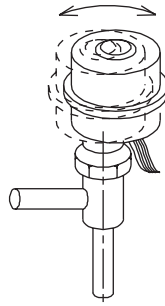

The motor may not be fixed with clamp because of the changing of the motor configuration. However, the fixing is not necessary due to the pipe fixing.

- 10) Connect the connector. Do not pull hard on the lead wire. Make sure that the connector is securely inserted into the specified position, and check that the connector does not come off easily.
- 11) Turn on the indoor unit, and operate the air conditioner. Check that no problems are found.

-6- Inverter

- Replace only the compressor if only the compressor is found to be defective.
- Replace only the fan motor if only the fan motor is found to be defective.
- Replace the defective components if the inverter is found to be defective.
- If both the compressor and the inverter are found to be defective, replace the defective component(s) of both devices.

(1) Inverter-related problems: Troubleshooting and remedies

- 1) The INV board has a large-capacity electrolytic capacitor, in which residual voltage remains even after the main power is turned off, posing a risk of electric shock. Before inspecting the inside of the control box, turn off the power, keep the unit off for at least 10 minutes, and confirm that the voltage between FT-P and FT-N on INV Board has dropped to DC20V or less. (It takes about 10 minutes to discharge electricity after the power supply is turn off.)
- 2) The IPM on the inverter becomes damaged if there are loose screws or connectors. If a problem occurs after replacing some of the parts, mixed up wiring is often the cause of the problem. Check for proper connection of the wiring, screws, connectors, and Faston terminals.
- 3) To avoid damage to the circuit board, do not connect or disconnect the inverter-related connectors with the main power turned on.
- 4) Faston terminals have a locking function. Make sure the terminals are securely locked in place after insertion.

Press the tab on the terminals to remove them.

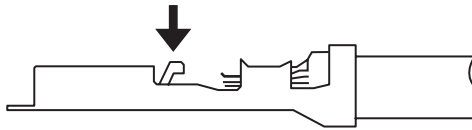

- 5) When the IPM or IGBT is replaced, apply a thin layer of heat radiation grease that is supplied evenly to these parts. Wipe off any grease that may get on the wiring terminal to avoid terminal contact failure.
- 6) Faulty wiring to the compressor damages the compressor. Connect the wiring in the correct phase sequence.

	Error display/failure condition	Measure/inspection item
[1]	Inverter related errors 4250, 4255, 4220, 4225, 4230, 4240, 4260, 5301, 0403	Check the details of the inverter error in the error log at 10.[1] Table of LED codes. Take appropriate measures to the error code and the error details in accordance with 9. [2] Self-diagnosis on the basis of Error Display on Remote Controller and Remedy for Error.
[2]	Main power breaker trip	Refer to "(3) Trouble treatment when the main power breaker is tripped". (page 263)
[3]	Main power earth leakage breaker trip	Refer to "(4) Trouble treatment when the main power earth leakage breaker is tripped". (page 263)
[4]	Only the compressor does not operate.	Check the inverter frequency on the LED monitor and proceed to (2) - [4] if the compressor is in operation. (page 261)
[5]	The compressor vibrates violently at all times or makes an abnormal sound.	See (2)-[4]. (page 261)
[6]	Only the fan motor does not operate.	Check the inverter frequency on the LED monitor and proceed to (2)-[6] if the fan motor is in operation. (page 262)
[7]	The fan motor shakes violently at all times or makes an abnormal sound.	Check the inverter frequency on the LED monitor and proceed to (2)-[6] if the fan motor is in operation. (page 262)
[8]	Noise is picked up by the peripheral device	<p><1> Check that power supply wiring of the peripheral device does not run close to the power supply wiring of the outdoor unit.</p> <p><2> Check if the inverter output wiring is not running parallel to the power supply wiring and the transmission lines.</p> <p><3> Check that the shielded wire is used as the transmission line when it is required, and check that the grounding work is performed properly on the shielded wire.</p> <p><4> Meg failure for electrical system other than the inverter</p> <p><5> Attach a ferrite core to the inverter output wiring. (Contact the factory for details of the service part settings.)</p> <p><6> Provide separate power supply to the air conditioner and other electric appliances.</p> <p><7> If the error occurred suddenly, a ground fault of the inverter output can be considered. See (2)-[4]. (page 261)</p> <p>*Contact the factory for cases other than those listed above.</p>
[9]	Sudden malfunction (as a result of external noise.)	<p><1> Check that the grounding work is performed properly.</p> <p><2> Check that the shielded wire is used as the transmission line when it is required, and check that the grounding work is performed properly on the shielded wire.</p> <p><3> Check that neither the transmission line nor the external connection wiring does not run close to another power supply system or does not run through the same conduit pipe.</p> <p>* Contact the factory for cases other than those listed above.</p>

(2) Inverter output related troubles

	Items to be checked	Phenomena	Remedy
[1] Check the INV board error detection circuit.	(1) Disconnect the inverter output wire from the terminals of the INV board (SC-U, SC-V, SC-W).	1) Overcurrent error (4250 Detail code No. 101, 104, 105, 106, and 107)	Replace the INV board.
	(2) Put the outdoor unit into operation.	2) Logic error (4220 Detail code No. 111)	Replace the INV board.
		3) ACCT sensor circuit failure (5301 Detail code No.117)	Replace the INV board.
		4) IPM open (5301 Detail code No.119)	Normal
[2] Check for compressor ground fault or coil error.	Disconnect the compressor wiring, and check the compressor Meg, and coil resistance.	1) Compressor Meg failure Error if less than 1 Mohm.	Check that there is no liquid refrigerant in the compressor. If there is none, replace the compressor.
		2) Compressor coil resistance failure Coil resistance value of 1 ohm (20°C [68°F]): P200, P250, and EP200 model Coil resistance value of 0.6 ohm (20°C [68°F]): P300 - P450, EP250, and EP300 models	Replace the compressor.

	Items to be checked	Phenomena	Remedy
<p>[3] Check whether the inverter is damaged. (No load)</p>	<p>(1) Disconnect the inverter output wire from the terminals of the INV board (SC-U, SC-V, SC-W).</p> <p>(2) Disconnect the short-circuit connector from CN6 on the INV board.</p> <p>(3) Put the outdoor unit into operation. Check the inverter output voltage after the inverter output frequency has stabilized.</p>	1) Inverter-related problems are detected.	Connect the short-circuit connector to CN6, and go to section [1].
		2) Inverter voltage is not output at the terminals (SC-U, SC-V, and SC-W)	Replace the INV board.
		3) There is a voltage imbalance between the wires. Greater than 5% imbalance or 5V	Replace the INV board.
		4) There is no voltage imbalance between the wires.	Normal *Reconnect the short-circuit connector to CN6 after checking the voltage.
<p>[4] Check whether the inverter is damaged. (During compressor operation)</p>	<p>Put the outdoor unit into operation. Check the inverter output voltage after the inverter output frequency has stabilized.</p>	1) Overcurrent-related problems occur immediately after compressor startup. Error code : 4250 Detail code : 101, 106, 107	<p>a. Check items [1] through [3] for problems.</p> <p>b. Check that high and low pressures are balanced.</p> <p>c. Check that no liquid refrigerant is present in the compressor. →Go to "d." when the problem persists after compressor startup was repeated several times. If normal operation is restored, check the crankcase heater for problems.</p> <p>d. Check that there is a pressure difference between high and low pressures after compressor startup. →Check the high pressure with LED monitor for changes. Replace the compressor if there is no pressure difference. (the compressor may be locked.)</p>
		2) There is a voltage imbalance between the wires after the inverter output voltage is stabilized. Greater than the larger of the following values: imbalance of 5% or 5V	Replace the INV board if there is a voltage imbalance. Check the crankcase heater for problems if there is no voltage imbalance. →When the error occurred, liquid refrigerant may have been present in the compressor.
<p>[5] Check the fan motor ground fault or the winding.</p>	<p>Remove the wire for the outdoor fan motor, and check the fan motor megger and the winding resistance.</p>	1) Fan motor megger failure Failure when the megger is 1Mohm or less.	<p>Replace the fan motor.</p>
		2) Fan motor disconnection Standard: The winding resistance is approximately several ohm. (It varies depending on the temperature, or while the inner thermo is operating, it will be ∞ ohm)	

	Items to be checked	Phenomena	Remedy
[6] Check the fan inverter board failure.	(1) Check the fan output wiring.	Connector contact failure •Board side (CNINV) •Fan motor side	Connect the connector.
	(2) Check the connector CN-VDC connection.	Cnconnector contact failure	Connect the connector.
	(3) Check the FAN board failure.	1) The voltage imbalance among each motor wiring during operation (The voltage imbalance is greater than the larger of the values represented by 5% or 5V.)	Replace the FAN board.
		2) The same error occurs even after the operation is restarted.	

(3) Trouble treatment when the main power breaker is tripped

	Items to be checked	Phenomena	Remedy
[1]	Check the breaker capacity.	Use of a non-specified breaker	Replace it with a specified breaker.
[2]	Perform Meg check between the terminals on the power terminal block TB1.	Zero to several ohm, or Meg failure	Check each part and wiring. *Refer to (5) "Simple checking Procedures for individual components of main inverter circuit".(page 264) ♦IGBT module ♦Rush current protection resistor ♦Electromagnetic relay ♦DC reactor
[3]	Turn on the power again and check again.	1) Main power breaker trip 2) No remote control display	♦IGBT module ♦Rush current protection resistor ♦Electromagnetic relay ♦DC reactor
[4]	Turn on the outdoor unit and check that it operates normally.	1) Operates normally without tripping the main breaker. 2) Main power breaker trip	a) The wiring may have been short-circuited. Search for the wire that short-circuited, and repair it. b) If item a) above is not the cause of the problem, refer to (2)-[1]-[6].

(4) Trouble treatment when the main power earth leakage breaker is tripped

	Items to be checked	Phenomena	Remedy
[1]	Check the earth leakage breaker capacity and the sensitivity current.	Use of a non-specified earth leakage breaker	Replace with a regulation earth leakage breaker.
[2]	Check the resistance at the power supply terminal block with a megger.	Failure resistance value	Check each part and wiring. *Refer to (5) "Simple checking Procedures for individual components of main inverter circuit".(page 264) ♦IGBT module ♦Rush current protection resistor ♦Electromagnetic relay ♦DC reactor
[3]	Disconnect the compressor wirings and check the resistance of the compressor with a megger.	Failure compressor if the insulating resistance value is not in specified range. Failure when the insulating resistance value is 1 Mohm or less.	Check that there is no liquid refrigerant in the compressor. If there is none, replace the compressor.
[4]	Disconnect the fan motor wirings and check the resistance of the fan motor with a megger.	Failure fan motor if the insulating resistance value is not in specified range. Failure when the insulating resistance value is 1 Mohm or less.	Replace the fan motor.

Note

The insulation resistance could go down to close to 1Mohm after installation or when the power is kept off for an extended period of time because of the accumulation of refrigerant in the compressor. If the earth leakage breaker is triggered, please use the following procedure to take care of this.

- ♦Disconnect the wires from the compressor's terminal block.
- ♦If the resistance is less than 1 Mohm, switch on the power for the outdoor unit with the wires still disconnected.
- ♦Leave the power on for at least 12 hours.
- ♦Check that the resistance has recovered to 1 Mohm or greater.

Earth leakage current measurement method

- ♦For easy on-site measurement of the earth leakage current, enable the filter with a measurement instrument that has filter functions as below, clamp all the power supply wires, and measure.
- Recommended measurement instrument: CLAMP ON LEAK HiTESTER 3283 made by HIOKI E.E. CORPORATION
- ♦When measuring one device alone, measure near the device's power supply terminal block.

(5) Simple checking procedure for individual components of main inverter circuit

Note

Before inspecting the inside of the control box, turn off the power, keep the unit off for at least 10 minutes, and confirm that the voltage between FT-P and FT-N on INV Board has dropped to DC20V or less.

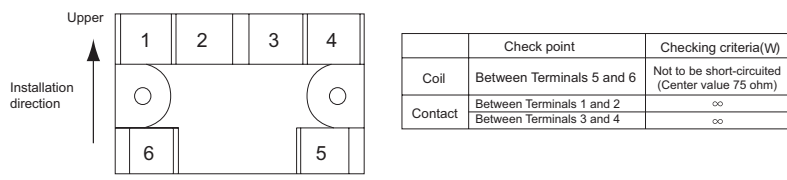
Part name	Judgment method													
IGBT module	See "Troubleshooting for IGBT Module ". (9 [4] - 6 - (6))(page 264)													
Rush current protection resistor R1, R5	Measure the resistance between terminals R1 and R5: 22 ohm \pm 10%													
Electromagnetic relay 72C	<p>Note</p> <p>This electromagnetic relay is rated at DC12V and is driven by a coil. Check the resistance between terminals</p>  <p>The diagram shows a relay with terminals 1, 2, 3, 4 on the top row and 6, 5 on the bottom row. An arrow labeled 'Installation direction' points upwards. To the right is a table:</p> <table border="1"> <thead> <tr> <th></th> <th>Check point</th> <th>Checking criteria(W)</th> </tr> </thead> <tbody> <tr> <td rowspan="2">Coil</td> <td>Between Terminals 5 and 6</td> <td>Not to be short-circuited (Center value 75 ohm)</td> </tr> <tr> <td>Between Terminals 1 and 2</td> <td>∞</td> </tr> <tr> <td rowspan="2">Contact</td> <td>Between Terminals 1 and 2</td> <td>∞</td> </tr> <tr> <td>Between Terminals 3 and 4</td> <td>∞</td> </tr> </tbody> </table>		Check point	Checking criteria(W)	Coil	Between Terminals 5 and 6	Not to be short-circuited (Center value 75 ohm)	Between Terminals 1 and 2	∞	Contact	Between Terminals 1 and 2	∞	Between Terminals 3 and 4	∞
	Check point	Checking criteria(W)												
Coil	Between Terminals 5 and 6	Not to be short-circuited (Center value 75 ohm)												
	Between Terminals 1 and 2	∞												
Contact	Between Terminals 1 and 2	∞												
	Between Terminals 3 and 4	∞												
DC reactor DCL	Measure the resistance between terminals: 1ohm or lower (almost 0 ohm) Measure the resistance between terminals and the chassis: ∞													

(6) Troubleshooting for IGBT Module

Measure the resistances between each pair of terminals on the IGBT with a tester, and use the results for troubleshooting. The terminals on the INV board are used for the measurement.

1) Notes on measurement

- Check the polarity before measuring. (On the tester, black normally indicates plus.)
- Check that the resistance is not open (∞ ohm) or not shorted (to 0 ohm).
- The values are for reference, and the margin of errors is allowed.
- The result that is more than double or half of the result that is measured at the same measurement point is not allowed.
- Disconnect all the wiring connected the INV board, and make the measurement.

2) Tester restriction

- Use the tester whose internal electrical power source is 1.5V or greater
- Use the dry-battery-powered tester.

Note

(The accurate diode-specific resistance cannot be measured with the button-battery-powered card tester, as the applied voltage is low.)

- Use a low-range tester if possible. A more accurate resistance can be measured.

Judgment value (reference)

		Black (+)				
		SC-P1	FT-N	SC-L1	SC-L2	SC-L3
Red (-)	SC-P1	-	-	5 - 200 ohm	5 - 200 ohm	5 - 200 ohm
	FT-N	-	-	∞	∞	∞
	SC-L1	∞	5 - 200 ohm	-	-	-
	SC-L2	∞	5 - 200 ohm	-	-	-
	SC-L3	∞	5 - 200 ohm	-	-	-

		Black (+)				
		SC-P2	FT-N	SC-U	SC-V	SC-W
Red (-)	SC-P2	-	-	5 - 200 ohm	5 - 200 ohm	5 - 200 ohm
	FT-N	-	-	∞	∞	∞
	SC-U	∞	5 - 200 ohm	-	-	-
	SC-V	∞	5 - 200 ohm	-	-	-
	SC-W	∞	5 - 200 ohm	-	-	-

INV board external diagram

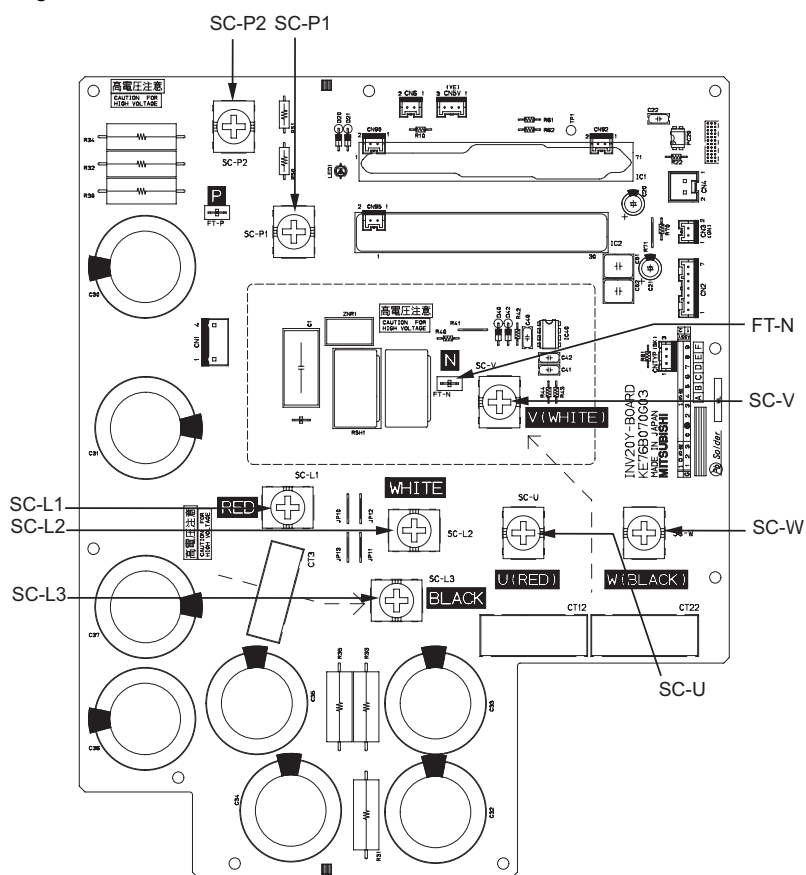

-7- Control Circuit

(1) Control power source function block

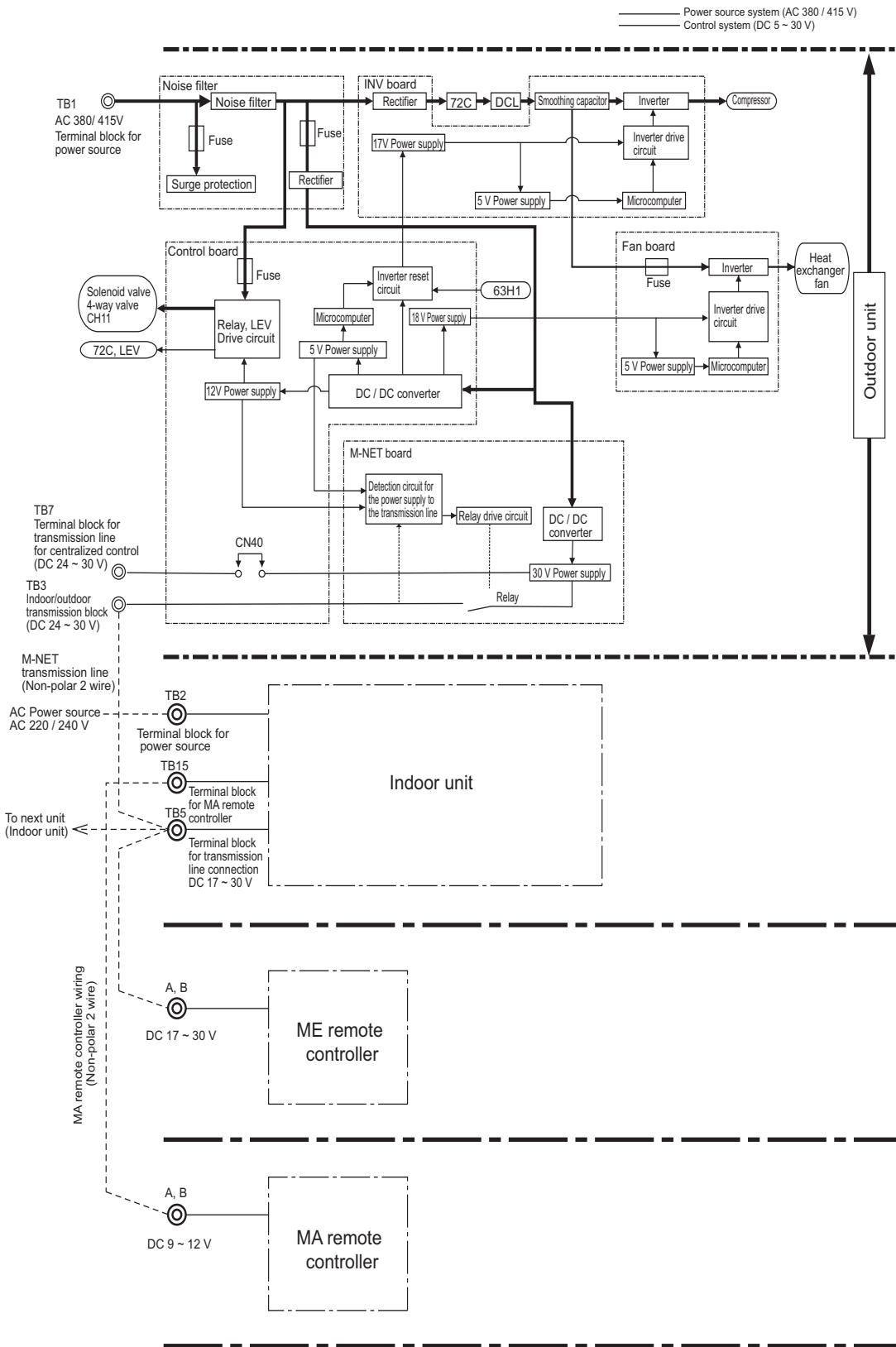

* MA remote controllers and ME remote controllers cannot be used together.
 (Both the ME and MA remote controller can be connected to a system with a system controller.)

(2) Troubleshooting transmission power circuit of outdoor unit

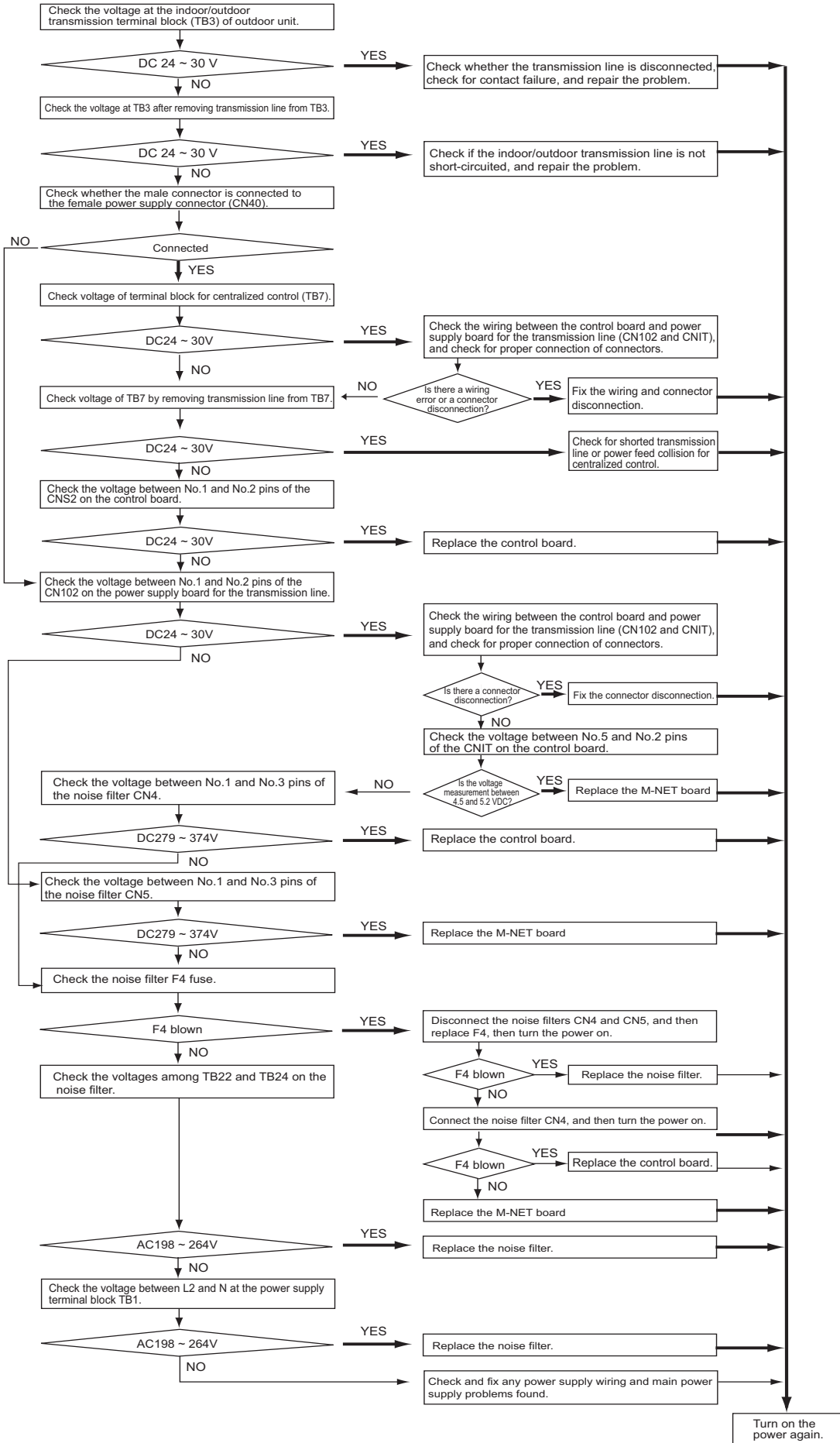

[5] Refrigerant Leak

1. Leak spot: In the case of extension pipe for indoor unit (Cooling season)

- 1) Mount a pressure gauge on the service check joint (CJ2) on the low-pressure side.
- 2) Stop all the indoor units, and close the liquid service valve (BV2) inside the outdoor unit while the compressor is being stopped.
- 3) Stop all the indoor units; turn on SW2-4 on the outdoor unit control board while the compressor is being stopped. (Pump down mode will start, and all the indoor units will run in cooling test run mode.)
- 4) In the pump down mode (SW2-4 is ON), all the indoor units will automatically stop when the low pressure (63LS) reaches 0.383MPa [55psi] or less or 15 minutes have passed after the pump mode started. Stop all the indoor units and compressors when the pressure indicated by the pressure gauge, which is on the check joint (CJ2) for low-pressure service, reaches 0.383MPa [55psi] or 20 minutes pass after the pump down operation is started.
- 5) Close the gas service valve (BV1) inside the outdoor unit.
- 6) Collect the refrigerant that remains in the extended pipe for the indoor unit. Do not discharge refrigerant into the atmosphere when it is collected.
- 7) Repair the leak.
- 8) After repairing the leak, vacuum the extension pipe and the indoor unit.
- 9) To adjust refrigerant amount, open the service valves (BV1 and BV2) inside the outdoor unit and turn off SW2-4.

2. Leak spot: In the case of outdoor unit (Cooling season)

(1) Run all the indoor units in the cooling test run mode.

- 1) To run the indoor unit in test run mode, turn SW3-2 from ON to OFF when SW3-1 on the outdoor control board is ON.
- 2) Change the setting of the remote controller for all the indoor units to the cooling mode.
- 3) Check that all the indoor units are performing a cooling operation.

(2) Check the values of Tc and TH6.

(To display the values on the LED screen, use the self-diagnosis switch (SW1) on the outdoor unit control board.)

- 1) When Tc-TH6 is 10°C [18°F] or more : See the next item (3).
- 2) When Tc-TH6 is less than 10°C [18°F] : After the compressor stops, collect the refrigerant inside the system, repair the leak, perform evacuation, and recharge new refrigerant. (Leak spot: 4. In the case of outdoor unit, handle in the same way as heating season.)

Tc self-diagnosis switch

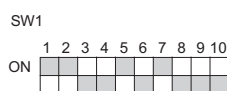

TH6 self-diagnosis switch

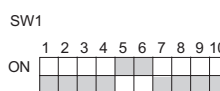

(3) Stop all the indoor units, and stop the compressor.

- 1) To stop all the indoor units and the compressors, turn SW3-2 from ON to OFF when SW3-1 on the outdoor control board is ON.
- 2) Check that all the indoor units are being stopped.

(4) Close the service valves (BV1 and BV2).

(5) To prevent the liquid seal, extract small amount of refrigerant from the check joint of the liquid service valve (BV2), as the liquid seal may cause a malfunction of the unit.

(6) Collect the refrigerant that remains inside the outdoor unit. Do not discharge refrigerant into air into the atmosphere when it is collected.

(7) Repair the leak.

(8) After repairing the leak, replace the dryer with the new one, and perform evacuation inside the outdoor unit.

(9) To adjust refrigerant amount, open the service valves (BV1 and BV2) inside the outdoor unit.

Note

When the power to the outdoor/indoor unit must be turned off to repair the leak after closing the service valves specified in the item 4, turn the power off in approximately one hour after the outdoor/indoor units stop.

- 1) When 30 minutes have passed after the item 4 above, the indoor unit lev turns from fully closed to slightly open to prevent the refrigerant seal.

LEV2a and LEV2b open when the outdoor unit remains stopped for 15 minutes to allow for the collection of refrigerant in the outdoor unit heat exchanger and to enable the evacuation of the outdoor unit heat exchanger.

If the power is turned of in less than 5 minutes, LEV2a and LEV2b may close, trapping high-pressure refrigerant in the outdoor unit heat exchanger and creating a highly dangerous situation.

- 2) Therefore, if the power source is turned off within 30 minutes, the lev remains fully closed and the refrigerant remains sealed. When only the power for the indoor unit is turned off, the indoor unit LEV turns from faintly open to fully closed.
- 3) In the cooling cycle, the section between "21S4b, c" and "LEV 2a, b" will form a closed circuit. To recover the refrigerant or evacuate the system, "LEV1" and "SV5b, c" will be open by setting SW5-8 to ON in the stop mode.
Set SW5-8 to OFF upon completion of all work.

3. Leak spot: In the case of extension pipe for indoor unit (Heating season)

(1) Run all the indoor units in heating test run mode.

- 1) To run the indoor unit in test run mode, turn SW3-2 from ON to OFF when SW3-1 on the outdoor control board is ON.
- 2) Change the setting of the remote controller for all the indoor units to the heating mode.
- 3) Check that all the indoor units are performing a heating operation.

(2) Stop all the indoor units, and stop the compressor.

- 1) To stop all the indoor units and the compressors, turn SW3-2 from ON to OFF when SW3-1 on the outdoor control board is ON.
- 2) Check that all the indoor units are stopped.

(3) Close the service valves (BV1 and BV2).

(4) Collect the refrigerant that remains inside the indoor unit. Do not discharge refrigerant into air into the atmosphere when it is collected.

(5) Repair the leak.

(6) After repairing the leak, perform evacuation of the extension pipe for the indoor unit, and open the service valves (BV1 and BV2) to adjust refrigerant.

4. Leak spot: In the case of outdoor unit (Heating season)

- 1) Collect the refrigerant in the entire system (outdoor unit, extended pipe and indoor unit). Do not discharge refrigerant into the atmosphere when it is collected.
- 2) Repair the leak.
- 3) After repairing the leak, replace the dryer with the new one, and perform evacuation of the entire system, and calculate the standard amount of refrigerant to be added (for outdoor unit, extended pipe and indoor unit), and charge the refrigerant. Refer to "VIII [4] 3. "(page 110)

Note

If the indoor or outdoor units need to be turned off for repairing leaks during Step 1) above, turn off the power approximately 1 hour after the units came to a stop.

If the power is turned off in less than 15 minutes, LEV2a and LEV2b may close, trapping high-pressure refrigerant in the outdoor unit heat exchanger and creating a highly dangerous situation.

In the cooling cycle, the section between "21S4b, c" and "LEV 2a, b" will form a closed circuit.

To recover the refrigerant or evacuate the system, "LEV1" and "SV5b, c" will be open by setting SW5-8 to ON in the stop mode.

Set SW5-8 to OFF upon completion of all work.

[6] Compressor Replacement Instructions

[Compressor replacement procedures]

Follow the procedures below (Steps 1 through 6) to remove the compressor components and replace the compressor. Reassemble them in the reverse order after replacing the compressor.

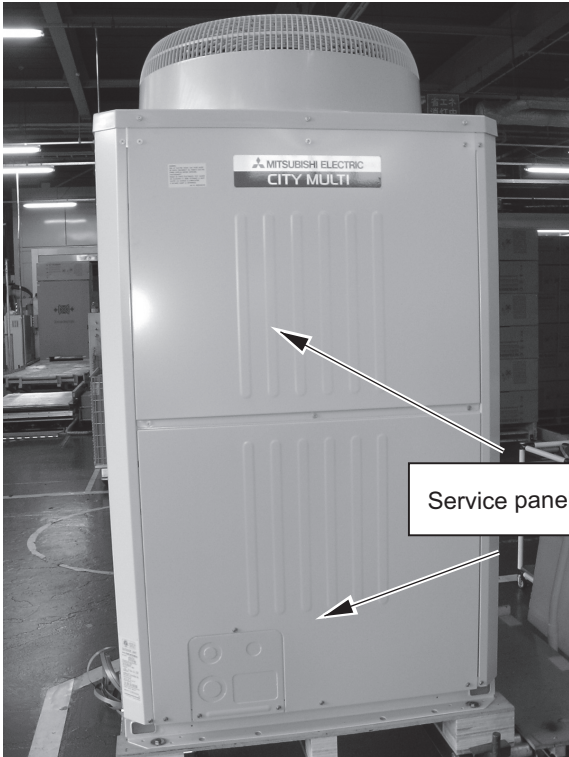

1. Remove both the top and bottom service panels (front panels).

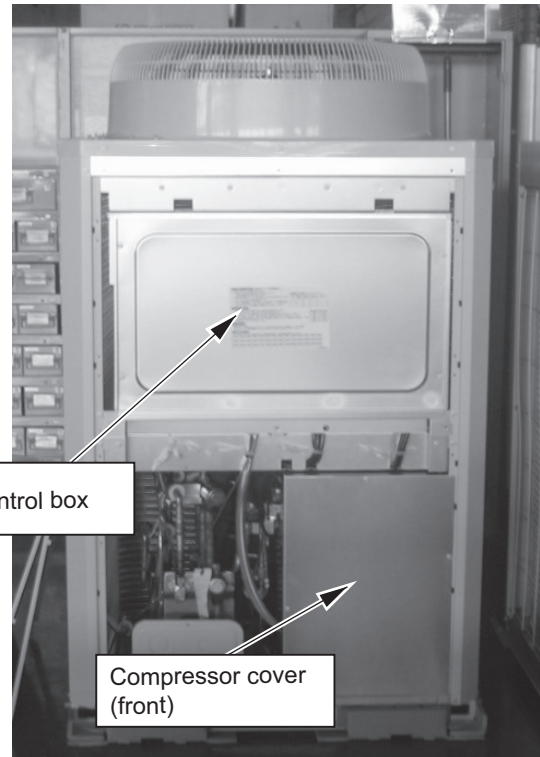

2. Remove the control box and the compressor cover (front).

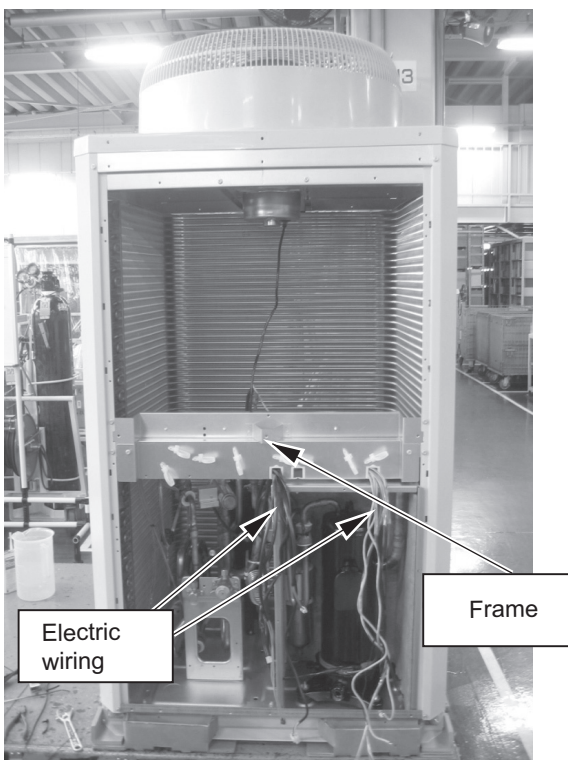

3. Remove the wires that are secured to the frame, and remove the frame.



4. Remove the compressor cover (top).

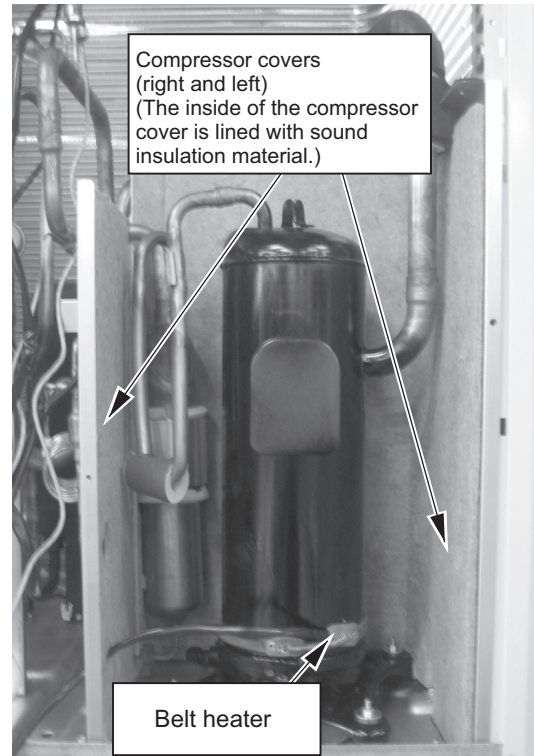

5. Remove the compressor wires, compressor covers (right and left), and belt heater.

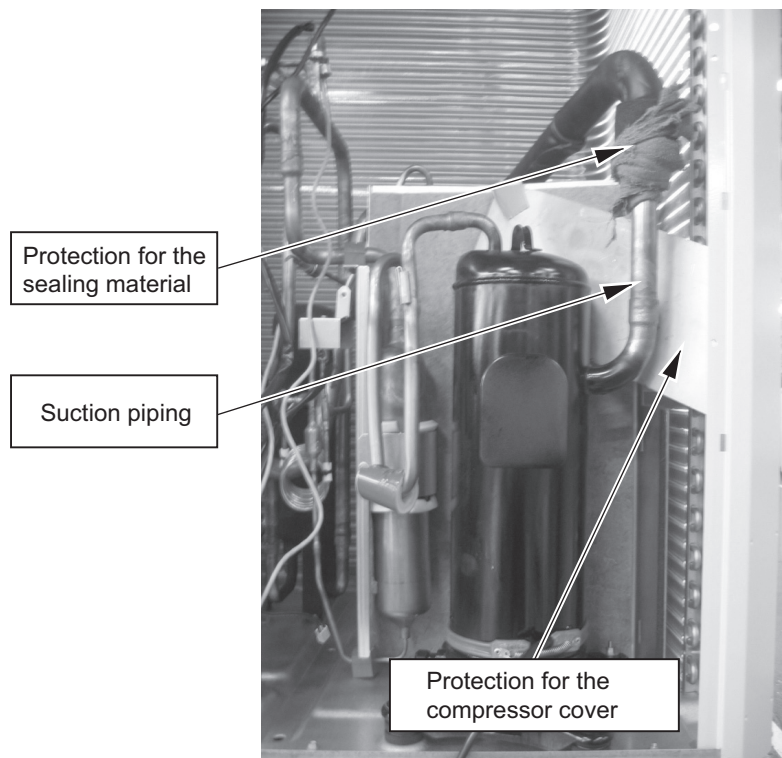

6. Place protective materials on the insulation lining of the compressor cover and on the sealing material on the compressor suction pipe to protect them from the torch flame, debraze the pipe, and replace the compressor.

[7] Troubleshooting Using the Outdoor Unit LED Error Display

If the LED error display appear as follows while all the SW1 switches are set to OFF, check the items under the applicable item numbers below.

1. Error code appears on the LED display.

Refer to IX [2] Responding to Error Display on the Remote Controller.

2. LED is blank.

Take the following troubleshooting steps.

- (1) If the voltage between pins 1 and 3 of CNDC on the control board is outside the range between 220 VDC and 380 VDC, refer to IX [4] -7- (2) Troubleshooting transmission power circuit of outdoor unit.**
- (2) If the LED error display becomes lit when the power is turned on with all the connectors on the control board except CNDC disconnected, there is a problem with the wiring to those connectors or with the connectors themselves.**
- (3) If nothing appears on the display under item (2) above AND the voltage between pins 1 and 3 of CNDC is within the range between 220 VDC and 380 VDC, control board failure is suspected.**

3. Only the software version appears on the LED display.

(1) Only the software version appears while the transmission cables to TB3 and TB7 are disconnected.

- 1) Wiring failure between the control board and the transmission line power supply board.(CNIT, CNS2, CN102)
- 2) If item 1) checks out OK, the transmission line power supply board failure is suspected.
- 3) If items 1) and 2) check out OK, control board failure is suspected.

(2) If the LED display appears as noted in "X [1] 2. LED display at Initial setting"(page 275) while the transmission cables to TB3 and TB7 are disconnected, failure with the transmission cable or the connected equipment is suspected.

X LED Monitor Display on the Outdoor Unit Board

[1] How to Read the LED on the Service Monitor	275
------------------------------------------------------	-----



[1] How to Read the LED on the Service Monitor

1. How to read the LED

By setting the DIP SW 1-1 through 1-10 (Switch number 10 is represented by 0), the operating condition of the unit can be monitored on the service monitor. (Refer to the table on the following pages for DIP SW settings.)
 The service monitor uses 4-digit 7-segment LED to display numerical values and other types of information.

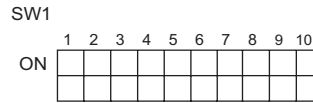
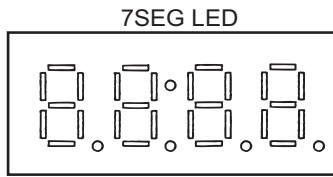

SW1-10 is represented as "0" in the table.

Pressure and temperature are examples of numerical values, and operating conditions and the on-off status of solenoid valve are examples of flag display.

1) Display of numerical values

Example: When the pressure data sensor reads 18.8kg/cm² (Item No. 58)

- The unit of pressure is in kg/cm²
 - Use the following conversion formula to convert the displayed value into a value in SI unit.
- Value in SI unit (MPa) = Displayed value (kg/cm²) x 0.098

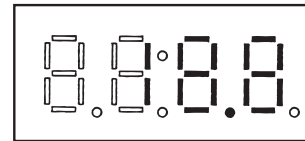

2) Flag display

Example: When 21S4a, 21S4b, SV1a are ON. (Item No. 3)

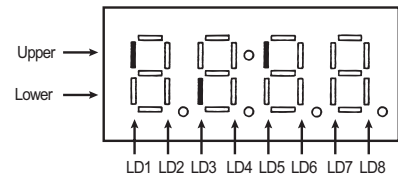

Example: 3-minutes restart mode (Item No. 14)

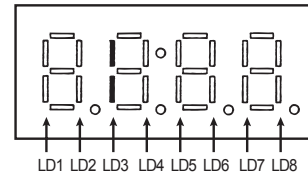

2. LED display at initial setting

From power on until the completion of initial settings, the following information will be displayed on the monitor screen. (Displays No. 1 through No. 4 in order repeatedly.)

No	Item	Display	Remarks
1	Software version		[0103] : Version 1.03
2	Refrigerant type		[410] : R410A
3	Model and capacity		[H-20] : Cooling/Heating 20 HP For the first few minutes after power on, the capacity of each outdoor unit is displayed. Thereafter, the combined capacity is displayed.
4	Communication address		[51] : Address 51

After the initial settings have been completed, the information on these items can be checked by making the switch setting that corresponds to No. 517 in the LED display table.

Note

Only item No. 1 "Software Version" appears on the display if there is a wiring failure between the control board and the transmission line power supply board or if the circuit board has failed.

3. Time data storage function

The outdoor unit has a simple clock function that enables the unit to calculate the current time with an internal timer by receiving the time set by the system controller, such as G(B)-50A.
 If an error (including a preliminary error) occurs, the error history data and the error detection time are stored into the service memory.
 The error detection time stored in the service memory and the current time can be seen on the service LED.

Note

- 1) Use the time displayed on the service LED as a reference.
- 2) The date and the time are set to "00" by default. If a system controller that sets the time, such as G(B)-50A is not connected, the elapsed time and days since the first power on will be displayed.
 If the time set on a system controller is received, the count will start from the set date and the time.
- 3) The time is not updated while the power of the indoor unit is turned off. When the power is turned off and then on again, the count will resume from the time before the power was turned off. Thus, the time that differs the actual time will be displayed. (This also applies when a power failure occurs.)
 The system controller, such as G(B)-50A, adjusts the time once a day. When the system controller is connected, the time will be automatically updated to the correct current time after the time set by the system controller is received. (The data stored into the memory before the set time is received will not be updated.)

(1) Reading the time data:

- 1) Time display
 Example: 12 past 9

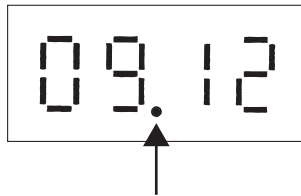

* Disappears if the time data is deviated due to a power failure, or if a system controller that sets the time is not connected.

- 2) Date display
 •When the main controller that can set the time is connected
 Example: May 10, 2003

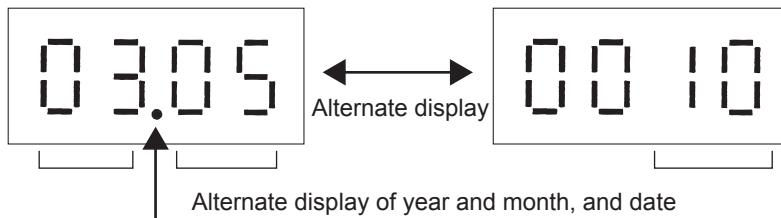

* Appears between the year and the month, and nothing appears when the date is displayed.

- When the main controller that can set the time is not connected
 Example: 52 days after power was turned on

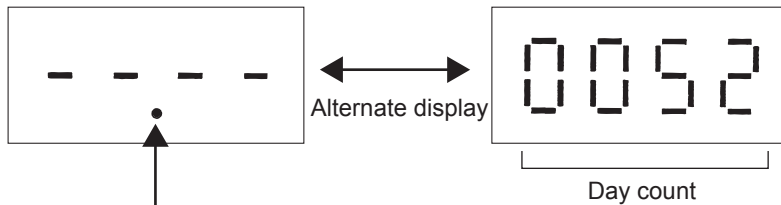

* Appears between the year and the month, and nothing appears when the date is displayed.

**LED monitor display
Current data**

No.	SW1 1234567890	Item	Display								Unit (A, B) ^{*1}		Remarks		
			LD1	LD2	LD3	LD4	LD5	LD6	LD7	LD8	OC	OS			
0	0000000000	Relay output display 1 Lighting											A	A	
		Check (error) display 1 OC/OS error	0000 to 9999 (Address and error codes highlighted)								B	B			
1	1000000000	Check (error) display 2 OC/OS error	0000 to 9999 (Address and error codes highlighted)								A	A	Display of the latest preliminary error If no preliminary errors are detected, "----" appears on the display.		
2	0100000000	Check (error) display 3 (Including IC and BC)	0000 to 9999 (Address and error codes highlighted)								B	B	If no errors are detected, "----" appears on the display.		
3	1100000000	Relay output display 2 Top Bottom			CH11			SV1a					A	A	
4	0010000000	Relay output display 3 Top Bottom			21S4b			SV5b					A	A	Power supply for indoor transmission line
5	1010000000														
6	0110000000														
7	1110000000	Special control													Communication error between the OC and OS
8	0001000000														Communication error 3-minute re-start delay mode
9	1001000000	Communication demand capacity	0000 to 9999								B	B	If not demanded controlled, "----" [%] appears on the display.		
10	0101000000	Contact point demand capacity	0000 to 9999								B	B	If not demanded controlled, "----" [%] appears on the display.		

*1 A: The condition of either OC or OS is displayed individually. B: The condition of the entire refrigerant system is displayed.

Current data		SW1	Item	Display										Unit ^{*1}		Remarks	
				LD1	LD2	LD3	LD4	LD5	LD6	LD7	LD8	OC	OS				
11	1234567890	1101000000	External signal (Open input contact point)	Contact point demand	Low-noise mode (Capacity priority)	Snow sensor	Cooling-heating changeover (Cooling)	Cooling-heating changeover (Heating)							A	A	
12	0011000000	0011000000	External signal (Open input contact point)											Low-noise mode (Quiet priority)	A	A	
13	1011000000	1011000000															
14	0111000000	0111000000	Outdoor unit operation status			3-minutes restart mode	Compressor in operation	Preliminary error	Error	3-minutes restart after instantaneous power failure				Preliminary low pressure error	A	A	
15	1111000000	1111000000	OC/OS identification	OC/OS-1/OS-2										A	A		
16	0000100000	0000100000	Indoor unit check	Top	Unit No. 1	Unit No. 2	Unit No. 3	Unit No. 4	Unit No. 5	Unit No. 6	Unit No. 7	Unit No. 8					The lamp that corresponds to the unit that came to an abnormal stop lights. The lamp goes off when the error is reset. Each unit that comes to an abnormal unit will be given a sequential number in ascending order starting with 1.
17	1000100000	1000100000		Bottom	Unit No. 9	Unit No. 10	Unit No. 11	Unit No. 12	Unit No. 13	Unit No. 14	Unit No. 15	Unit No. 16					
18	0100100000	0100100000	Indoor unit Operation mode	Top	Unit No. 17	Unit No. 18	Unit No. 19	Unit No. 20	Unit No. 21	Unit No. 22	Unit No. 23	Unit No. 24					Lit during cooling Lit during heating Unit while the unit is stopped or in the fan mode
19	1100100000	1100100000		Bottom	Unit No. 25	Unit No. 26	Unit No. 27	Unit No. 28	Unit No. 29	Unit No. 30	Unit No. 31	Unit No. 32					
20	0010100000	0010100000	Indoor unit Operation mode	Top	Unit No. 33	Unit No. 34	Unit No. 35	Unit No. 36	Unit No. 37	Unit No. 38	Unit No. 39	Unit No. 40					
21	1010100000	1010100000		Bottom	Unit No. 41	Unit No. 42	Unit No. 43	Unit No. 44	Unit No. 45	Unit No. 46	Unit No. 47	Unit No. 48					
22	0110100000	0110100000	Indoor unit Operation mode	Top	Unit No. 49	Unit No. 50											
23	1110100000	1110100000		Bottom	Unit No. 1	Unit No. 2	Unit No. 3	Unit No. 4	Unit No. 5	Unit No. 6	Unit No. 7	Unit No. 8					

*1 A: The condition of either OC or OS is displayed individually. B: The condition of the entire refrigerant system is displayed.

No.	SW1	Item	Display										Unit**1		Remarks
			LD1	LD2	LD3	LD4	LD5	LD6	LD7	LD8	OC	OS			
24	0001100000	Indoor unit thermostat	Unit No. 1	Unit No. 2	Unit No. 3	Unit No. 4	Unit No. 5	Unit No. 6	Unit No. 7	Unit No. 8	B	Lit when thermostat is on Unit when thermostat is off			
			Unit No. 9	Unit No. 10	Unit No. 11	Unit No. 12	Unit No. 13	Unit No. 14	Unit No. 15	Unit No. 16					
25	1001100000	Top	Unit No. 17	Unit No. 18	Unit No. 19	Unit No. 20	Unit No. 21	Unit No. 22	Unit No. 23	Unit No. 24					
		Bottom	Unit No. 25	Unit No. 26	Unit No. 27	Unit No. 28	Unit No. 29	Unit No. 30	Unit No. 31	Unit No. 32					
26	0101100000	Top	Unit No. 33	Unit No. 34	Unit No. 35	Unit No. 36	Unit No. 37	Unit No. 38	Unit No. 39	Unit No. 40					
		Bottom	Unit No. 41	Unit No. 42	Unit No. 43	Unit No. 44	Unit No. 45	Unit No. 46	Unit No. 47	Unit No. 48					
27	1101100000	Top	Unit No. 49	Unit No. 50											
		Bottom													
28	0011100000														
29	1011100000														
30	0111100000														
31	1111100000														
32	0000010000														
33	1000010000														
34	0100010000														
35	1100010000														
36	0010010000														
37	1010010000														
38	0110010000														
39	1110010000	Outdoor unit Operation mode	Permissible stop	Standby	Cooling		Heating				B				
40	0001010000														
41	1001010000														
42	0101010000	Outdoor unit control mode	Stop	Thermo OFF	Abnormal stop	Scheduled control	Initial start up	Defrost	Oil balance	Low frequency oil recovery	A	A			
43	1101010000			Refrigerant recovery							A	A			
44	0011010000														

*1 A: The condition of either OC or OS is displayed individually. B: The condition of the entire refrigerant system is displayed.

Current data

No.	SW1	Item	Display								Unit *1			Remarks		
			LD1	LD2	LD3	LD4	LD5	LD6	LD7	LD8	OC	OS				
45	1011010000	TH4											A	A	The unit is [°C]	
46	0111010000	TH3												A	A	
47	1111010000	TH7												A	A	
48	0000110000	TH6												A	A	
49	1000110000	TH2												A	A	
50	0100110000	TH5												A	A	
51	1100110000															
52	0010110000															
53	1010110000															
54	0110110000															
55	1110110000															
56	0001110000	THHS1												A	A	The unit is [°C]
57	1001110000	THBOX												A	A	
58	0101110000	High-pressure sensor data												A	A	The unit is [kgf/cm ²]
59	1101110000	Low-pressure sensor data												A	A	
60	0011110000															
61	1011110000															
62	0111110000															
63	1111110000															
64	0000010000															
65	1000010000															
66	0100010000															
67	1100010000															
68	0010010000															
69	1010010000															
70	0110010000															
71	1110010000															

*1 A: The condition of either OC or OS is displayed individually. B: The condition of the entire refrigerant system is displayed.

Current data

No.	SW1	Item	Display								Unit ^{*1} (A, B) ^{*1}		Remarks	
			LD1	LD2	LD3	LD4	LD5	LD6	LD7	LD8	OC	OS		
72	0001001000													
73	1001001000													
74	0101001000													
75	1101001000													
76	0011001000													
77	1011001000													
78	0111001000	Σ Qj					0000 to 9999					B	B	
79	1111001000	Σ Qjc					0000 to 9999					B	B	
80	0000101000	Σ Qjh					0000 to 9999					B	B	
81	1000101000	Target Tc					-99.9 to 999.9					B		The unit is [°C]
82	0100101000	Target Te					-99.9 to 999.9					B		
83	1100101000	Tc					-99.9 to 999.9					A	A	
84	0010101000	Te					-99.9 to 999.9					A	A	
85	1010101000													
86	0110101000	Total frequencies (OC+OS)					0000 to 9999					B		Control data [Hz]
87	1110101000	Total frequency of each unit					0000 to 9999					A	A	
88	0001101000	COMP frequency					0000 to 9999					A	A	
89	1001101000													
90	0101101000													
91	1101101000	COMP operating fre- quency					0000 to 9999					A	A	The unit is [rps] Output frequency of the inverter depends on the type of compressor and equals the integer multi- ples (x1, x2 etc.) of the operating frequency of the compressor
92	0011101000													
93	1011101000	All AK (OC+OS)					0000 to 9999					B		

*1 A: The condition of either OC or OS is displayed individually. B: The condition of the entire refrigerant system is displayed.

Current data

No.	SW1 1234567890	Item	Display								Unit (A, B)*1		Remarks
			LD1	LD2	LD3	LD4	LD5	LD6	LD7	LD8	OC	OS	
94	0111101000	AK	0000 to 9999								A	A	
95	1111101000	FAN	0000 to 9999								A	A	Fan output [%]
96	0000011000	Fan inverter output frequency	0000 to 9999								A	A	Twice the actual output frequency
97	1000011000												
98	0100011000												
99	1100011000												
100	0010011000												
101	1010011000												
102	0110011000												
103	1110011000	LEV1	0 to 480								A	A	Outdoor LEV opening (Fully open: 480)
104	0001011000	LEV2	60 to 1400								A	A	Outdoor LEV opening (Fully open: 1400)
105	1001011000												
106	0101011000												
107	1101011000												
108	0011011000												
109	1011011000												
110	0111011000												
111	1111011000	COMP bus voltage	00.0 to 999.9								A	A	The unit is [V]
112	0000111000												
113	1000111000												
114	0100111000												
115	1100111000												
116	0010111000	Number of times the unit went into the mode to remedy wet vapor suction	0000 to 9999								B		

*1 A: The condition of either OC or OS is displayed individually. B: The condition of the entire refrigerant system is displayed.

Current data

No.	SW1	Item	Display								Unit (A, B)*1		Remarks	
			LD1	LD2	LD3	LD4	LD5	LD6	LD7	LD8	OC	OS		
117	1010111000	COMP Operation time Upper 4 digits	0000 to 9999								A	A	The unit is [h]	
118	0110111000	COMP Operation time Lower 4 digits	0000 to 9999								A	A		
119	1110111000	Integrated cleaning time (minute)	0000 to 9999								B			
120	0001111000													
121	1001111000	Backup mode	Abnormal pressure rise	High-pres- sure drop	Low-pres- sure drop	Abnormal Td rise						A	A	Stays lit for 90 seconds after the completion of backup control
122	0101111000													
123	1101111000	COMP number of start- stop events Upper 4 digits	0000 to 9999								A	A	Count-up at start-up The unit is [Time]	
124	0011111000	COMP number of start- stop events Lower 4 digits	0000 to 9999								A	A		
125	1011111000													
126	0111111000													
127	1111111000													
128	0000000100													
129	1000000100	Integrated operation time of compressor (for rotation purpose)	0000 to 9999								B		The unit is [h]	
130	0100000100													
131	1100000100													
132	0010000100													
133	1010000100													
134	0110000100													
135	1110000100													
136	0001000100													
137	1001000100													

*1 A: The condition of either OC or OS is displayed individually. B: The condition of the entire refrigerant system is displayed.

Current data		SW1	Item	Display								Unit *1		Remarks		
				LD1	LD2	LD3	LD4	LD5	LD6	LD7	LD8	OC	OS			
138		0101000100														
139		1101000100														
140		0011000100														
141		1011000100														
142		0111000100														
143		1111000100														
144		0000100100														
145		1000100100														
146		0100100100														
147		1100100100														
148		0010100100														
149		1010100100														
150		0110100100														
151		1110100100														
152		0001100100														
153		1001100100														
154		0101100100														
155		1101100100														
156		0011100100														
157		1011100100														
158		0111100100														
159		1111100100														
160		0000010100														
161		1000010100														
162		0100010100														
163		1100010100														
164		0010010100														
165		1010010100														

*1 A: The condition of either OC or OS is displayed individually. B: The condition of the entire refrigerant system is displayed.

Current data

No.	SW1	Item	Display								Unit ^{*1}		Remarks	
			LD1	LD2	LD3	LD4	LD5	LD6	LD7	LD8	OC	OS		
166	1234567890													
167	0110010100													
168	1110010100													
169	0001010100													
170	1001010100													
171	0101010100													
172	1101010100													
173	0011010100													
174	1011010100													
175	0111010100													
176	1111010100													
177	0000110100													
177	1000110100													

*1 A: The condition of either OC or OS is displayed individually. B: The condition of the entire refrigerant system is displayed.

Current data

No.	SW1	Item	Display										Unit ^{*1} (A, B) ^{*1}			Remarks
			LD1	LD2	LD3	LD4	LD5	LD6	LD7	LD8	OC	OS	OS			
178	0100110100	Error history 1	0000 to 9999										B	B	Address and error codes highlighted If no errors are detected, "----" appears on the display. Preliminary error information of the OS does not appear on the OC. Neither preliminary error information of the OC nor error information of the IC appears on the OS.	
179	1100110100	Error details of inverter	Error details of inverter (0001-0120)										A	A		
180	0010110100	Error history 2	0000 to 9999										B	B		
181	1010110100	Error details of inverter	Error details of inverter (0001-0120)										A	A		
182	0110110100	Error history 3	0000 to 9999										B	B		
183	1110110100	Error details of inverter	Error details of inverter (0001-0120)										A	A		
184	0001110100	Error history 4	0000 to 9999										B	B		
185	1001110100	Error details of inverter	Error details of inverter (0001-0120)										A	A		
186	0101110100	Error history 5	0000 to 9999										B	B		
187	1101110100	Error details of inverter	Error details of inverter (0001-0120)										A	A		
188	0011110100	Error history 6	0000 to 9999										B	B		
189	1011110100	Error details of inverter	Error details of inverter (0001-0120)										A	A		
190	0111110100	Error history 7	0000 to 9999										B	B		
191	1111110100	Error details of inverter	Error details of inverter (0001-0120)										A	A		
192	0000001100	Error history 8	0000 to 9999										B	B		
193	1000001100	Error details of inverter	Error details of inverter (0001-0120)										A	A		
194	0100001100	Error history 9	0000 to 9999										B	B		
195	1100001100	Error details of inverter	Error details of inverter (0001-0120)										A	A		
196	0010001100	Error history 10	0000 to 9999										B	B		
197	1010001100	Error details of inverter	Error details of inverter (0001-0120)										A	A		
198	0110001100	Error history of inverter (At the time of last data backup before error)	0000 to 9999										B	B		
199	1110001100	Error details of inverter	Error details of inverter (0001-0120)										A	A		
200	0001001100															

*1 A: The condition of either OC or OS is displayed individually. B: The condition of the entire refrigerant system is displayed.

Data before error

No.	SW1	Item	Display								Unit ^{*1}		Remarks
			LD1	LD2	LD3	LD4	LD5	LD6	LD7	LD8	OC	OS	
201	1001001100	Outdoor unit operation status			3-minutes restart mode	Compressor in operation	Preliminary error	Error	3-minutes restart after instantaneous power failure	Preliminary low pressure error	A	A	
202	0101001100	OC/OS identification	OC/OS-1/OS-2								A	A	
203	1101001100												
204	0011001100												
205	1011001100	Outdoor unit Operation mode	Permissible stop	Standby	Cooling		Heating					B	
206	0111001100												
207	1111001100												
208	0000101100	Outdoor unit control mode	Stop	Thermo OFF	Abnormal stop	Scheduled control	Initial start up	Defrost	Oil balance	Low frequency oil recovery	A	A	
209	1000101100			Refrigerant recovery							A	A	
210	0100101100												
211	1100101100	Relay output display 1 Lighting	Comp in operation				72C		OC	Always lit	A	A	
212	0010101100	Relay output display 2 Lighting	21S4a		CH11		SV1a					A	A
					21S4b		SV5b					A	A
213	1010101100	Relay output display 3 Lighting	Top							Lit while power to the indoor units is being supplied			A
			Bottom				21S4c		SV9				
214	0110101100												
215	1110101100												

*1 A: The condition of either OC or OS is displayed individually. B: The condition of the entire refrigerant system is displayed.

Data before error		SW1	Item	Display								Unit *1			Remarks
				LD1	LD2	LD3	LD4	LD5	LD6	LD7	LD8	OC	OS		
216	0001101100	1234567890	TH4										A	A	The unit is [°C]
217	1001101100		TH3										A	A	
218	0101101100		TH7										A	A	
219	1101101100		TH6										A	A	
220	0011101100		TH2										A	A	
221	1011101100		TH5										A	A	
222	0111101100														
223	1111101100														
224	0000011100														
225	1000011100														
226	0100011100														
227	1100011100		THHS1										A	A	The unit is [°C]
228	0010011100		THBOX										A	A	
229	1010011100		High-pressure sensor data										A	A	The unit is [kgf/cm ²]
230	0110011100		Low-pressure sensor data										A	A	
231	1110011100														
232	0001011100														
233	1001011100														
234	0101011100														
235	1101011100														
236	0011011100														
237	1011011100														
238	0111011100														
239	1111011100														
240	0000111100														
241	1000111100														
242	0100111100														

*1 A: The condition of either OC or OS is displayed individually. B: The condition of the entire refrigerant system is displayed.

Data before error		SW1	Item	Display								Unit ^{*1}		Remarks	
				LD1	LD2	LD3	LD4	LD5	LD6	LD7	LD8	OC	OS		
243		1234567890													
244		1100111100													
245		0010111100													
246		1010111100													
247		0110111100													
248		1110111100													
249		0001111100													
249		1001111100	Σ Qj						0000 to 9999			B	B		
250		0101111100	Σ Qjc						0000 to 9999			B	B		
251		1101111100	Σ Qjh						0000 to 9999			B	B		
252		0011111100	Target Tc						-99.9 to 999.9			B			The unit is [°C]
253		1011111100	Target Te						-99.9 to 999.9			B			
254		0111111100	Tc						-99.9 to 999.9			A	A		The unit is [°C]
255		1111111100	Te						-99.9 to 999.9			A	A		
256		0000000010													
257		1000000010	Total frequencies (OC+OS)						0000 to 9999			B			Control data [Hz]
258		0100000010	Total frequency of each unit						0000 to 9999			A	A		
259		1100000010	COMP frequency						0000 to 9999			A	A		
260		0010000010													
261		1010000010													
262		0110000010	COMP operating frequency						0000 to 9999			A	A		The unit is [rps]
263		1110000010													
264		0001000010	All AK (OC+OS)						0000 to 9999			B			
265		1001000010	AK						0000 to 9999			A	A		
266		0101000010	FAN						0000 to 9999			A	A		Fan inverter output [%]
267		1101000010	Fan inverter output frequency						0000 to 9999			A	A		Twice the actual output frequency

*1 A: The condition of either OC or OS is displayed individually. B: The condition of the entire refrigerant system is displayed.

Data before error

No.	SW1	Item	Display								Unit**1		Remarks	
			LD1	LD2	LD3	LD4	LD5	LD6	LD7	LD8	OC	OS		
268	0011000010													
269	1011000010													
270	0111000010													
271	1111000010													
272	0000100010													
273	1000100010													
274	0100100010	LEV1					0 to 480					A	A	Outdoor unit LEV opening (Fully open: 480)
275	1100100010	LEV2					60 to 1400					A	A	Outdoor unit LEV opening (Fully open: 1400)
276	0010100010													
277	1010100010													
278	0110100010													
279	1110100010													
280	0001100010													
281	1001100010													
282	0101100010	COMP bus voltage					00.0 to 999.9					A	A	The unit is [V]
283	1101100010													
284	0011100010													
285	1011100010													
286	0111100010													
287	1111100010													
288	0000010010	COMP Operation time Upper 4 digits					0000 to 9999					A	A	The unit is [h]
289	1000010010	COMP Operation time Lower 4 digits					0000 to 9999					A	A	
290	0100010010													
291	1100010010													
292	0010010010													

*1 A: The condition of either OC or OS is displayed individually. B: The condition of the entire refrigerant system is displayed.

Data before error

No.	SW1	Item	Display								Unit ^{*1}		Remarks		
			LD1	LD2	LD3	LD4	LD5	LD6	LD7	LD8	OC	OS			
293	1010010010														
294	0110010010	COMP number of start-stop events Upper 4 digits	0000 to 9999								A	A	Count-up at start-up The unit is [Time]		
295	1110010010	COMP number of start-stop events Lower 4 digits	0000 to 9999								A	A			
296	0001010010														
297	1001010010														
298	0101010010														
299	1101010010														
300	0011010010	Integrated operation time of compressor (for rotation purpose)	0000 to 9999								B		The unit is [h]		

*1 A: The condition of either OC or OS is displayed individually. B: The condition of the entire refrigerant system is displayed.

Current data

No.	SW1	Item	Display								Unit (A, B) ^{*1}		Remarks	
			LD1	LD2	LD3	LD4	LD5	LD6	LD7	LD8	OC	OS		
301	1011010010	Power supply unit											B	
302	0111010010	Start-up unit											B	
303	1111010010													
304	0000110010													
305	1000110010													
306	0100110010													
307	1100110010													
308	0010110010													
309	1010110010													
310	0110110010													
311	1110110010													
312	0001110010													
313	1001110010													
314	0101110010													
315	1101110010													
316	0011110010													
317	1011110010													
318	0111110010													
319	1111110010													
320	0000001010													
321	1000001010													
322	0100001010													
323	1100001010													
324	0010001010													
325	1010001010													
326	0110001010													
327	1110001010													

*1 A: The condition of either OC or OS is displayed individually. B: The condition of the entire refrigerant system is displayed.

Current data

No.	SW1 1234567890	Item	Display								Unit (A, B) ^{*1}		Remarks	
			LD1	LD2	LD3	LD4	LD5	LD6	LD7	LD8	OC	OS		
328	0001001010													
329	1001001010													
330	0101001010													
331	1101001010													
332	0011001010													
333	1011001010													
334	0111001010													
335	1111001010													
336	0000101010													
337	1000101010													
338	0100101010													
339	1100101010													
340	0010101010													
341	1010101010													
342	0110101010													
343	1110101010													
344	0001101010													
345	1001101010													
346	0101101010													
347	1101101010													
348	0011101010													
349	1011101010													
350	0111101010													

*1 A: The condition of either OC or OS is displayed individually. B: The condition of the entire refrigerant system is displayed.

Data on indoor unit system

No.	SW1	Item	Display								Unit (A, B) ^{*1}		Remarks		
			LD1	LD2	LD3	LD4	LD5	LD6	LD7	LD8	OC	OS			
351	1111101010	IC1 Address/capacity code	0000 to 9999												Displayed alternately every 5 seconds
352	0000011010	IC2 Address/capacity code	0000 to 9999												
353	1000011010	IC3 Address/capacity code	0000 to 9999												
354	0100011010	IC4 Address/capacity code	0000 to 9999												
355	1100011010	IC5 Address/capacity code	0000 to 9999												
356	0010011010	IC6 Address/capacity code	0000 to 9999												
357	1010011010	IC7 Address/capacity code	0000 to 9999												
358	0110011010	IC8 Address/capacity code	0000 to 9999												
359	1110011010	IC9 Address/capacity code	0000 to 9999												
360	0001011010	IC10 Address/capacity code	0000 to 9999												
361	1001011010	IC11 Address/capacity code	0000 to 9999												
362	0101011010	IC12 Address/capacity code	0000 to 9999												
363	1101011010	IC13 Address/capacity code	0000 to 9999												
364	0011011010	IC14 Address/capacity code	0000 to 9999												
365	1011011010	IC15 Address/capacity code	0000 to 9999												
366	0111011010	IC16 Address/capacity code	0000 to 9999												
367	1111011010	IC17 Address/capacity code	0000 to 9999												

*1 A: The condition of either OC or OS is displayed individually. B: The condition of the entire refrigerant system is displayed.

Data on indoor unit system

No.	SW1	Item	Display								Unit (A, B) *1		Remarks		
			LD1	LD2	LD3	LD4	LD5	LD6	LD7	LD8	OC	OS			
396	0011000110	IC46 Address/capacity code	0000 to 9999							0000 to 9999					Displayed alternately every 5 seconds
397	1011000110	IC47 Address/capacity code	0000 to 9999							0000 to 9999					
398	0111000110	IC48 Address/capacity code	0000 to 9999							0000 to 9999					
399	1111000110	IC49 Address/capacity code	0000 to 9999							0000 to 9999					
400	0000100110	IC50 Address/capacity code	0000 to 9999							0000 to 9999					
401	1000100110														
402	0100100110														
403	1100100110														
404	0010100110														
405	1010100110														
406	0110100110														
407	1110100110														
408	0001100110	IC1 Suction temperature													The unit is [°C]
409	1001100110	IC2 Suction temperature													
410	0101100110	IC3 Suction temperature													
411	1101100110	IC4 Suction temperature													

*1 A: The condition of either OC or OS is displayed individually. B: The condition of the entire refrigerant system is displayed.

Data on indoor unit system

No.	SW1	Item	Display								Unit (A, B) *1		Remarks		
			LD1	LD2	LD3	LD4	LD5	LD6	LD7	LD8	OC	OS			
412	0011100110	IC5 Suction temperature											B		The unit is [°C]
413	1011100110	IC6 Suction temperature													
414	0111100110	IC7 Suction temperature													
415	1111100110	IC8 Suction temperature													
416	0000010110	IC9 Suction temperature													
417	1000010110	IC10 Suction temperature													
418	0100010110	IC11 Suction temperature													
419	1100010110	IC12 Suction temperature													
420	0010010110	IC13 Suction temperature													
421	1010010110	IC14 Suction temperature													
422	0110010110	IC15 Suction temperature													
423	1110010110	IC16 Suction temperature													
424	0001010110	IC17 Suction temperature													
425	1001010110	IC18 Suction temperature													
426	0101010110	IC19 Suction temperature													
427	1101010110	IC20 Suction temperature													
428	0011010110	IC21 Suction temperature													
429	1011010110	IC22 Suction temperature													
430	0111010110	IC23 Suction temperature													
431	1111010110	IC24 Suction temperature													
432	0000110110	IC25 Suction temperature													
433	1000110110	IC26 Suction temperature													
434	0100110110	IC27 Suction temperature													
435	1100110110	IC28 Suction temperature													

*1 A: The condition of either OC or OS is displayed individually. B: The condition of the entire refrigerant system is displayed.

Data on indoor unit system

No.	SW1	Item	Display								Unit (A, B) *1		Remarks
			LD1	LD2	LD3	LD4	LD5	LD6	LD7	LD8	OC	OS	
436	0010110110	IC29 Suction temperature	-99.9 to 999.9								B		The unit is [°C]
437	1010110110	IC30 Suction temperature	-99.9 to 999.9										
438	0110110110	IC31 Suction temperature	-99.9 to 999.9										
439	1110110110	IC32 Suction temperature	-99.9 to 999.9										
440	0001110110	IC33 Suction temperature	-99.9 to 999.9										
441	1001110110	IC34 Suction temperature	-99.9 to 999.9										
442	0101110110	IC35 Suction temperature	-99.9 to 999.9										
443	1101110110	IC36 Suction temperature	-99.9 to 999.9										
444	0011110110	IC37 Suction temperature	-99.9 to 999.9										
445	1011110110	IC38 Suction temperature	-99.9 to 999.9										
446	0111110110	IC39 Suction temperature	-99.9 to 999.9										
447	1111110110	IC40 Suction temperature	-99.9 to 999.9										
448	0000001110	IC41 Suction temperature	-99.9 to 999.9										
449	1000001110	IC42 Suction temperature	-99.9 to 999.9										
450	0100001110	IC43 Suction temperature	-99.9 to 999.9										
451	1100001110	IC44 Suction temperature	-99.9 to 999.9										
452	0010001110	IC45 Suction temperature	-99.9 to 999.9										
453	1010001110	IC46 Suction temperature	-99.9 to 999.9										
454	0110001110	IC47 Suction temperature	-99.9 to 999.9										
455	1110001110	IC48 Suction temperature	-99.9 to 999.9										
456	0001001110	IC49 Suction temperature	-99.9 to 999.9										
457	1001001110	IC50 Suction temperature	-99.9 to 999.9										
458	0101001110	IC1 Liquid pipe temperature	-99.9 to 999.9								B		The unit is [°C]
459	1101001110	IC2 Liquid pipe temperature	-99.9 to 999.9										
460	0011001110	IC3 Liquid pipe temperature	-99.9 to 999.9										
461	1011001110	IC4 Liquid pipe temperature	-99.9 to 999.9										
462	0111001110	IC5 Liquid pipe temperature	-99.9 to 999.9										
463	1111001110	IC6 Liquid pipe temperature	-99.9 to 999.9										

*1 A: The condition of either OC or OS is displayed individually. B: The condition of the entire refrigerant system is displayed.

Data on indoor unit system

No.	SW1	Item	Display								Unit (A, B) *1		Remarks	
			LD1	LD2	LD3	LD4	LD5	LD6	LD7	LD8	OC	OS		
464	0000101110	IC7 Liquid pipe temperature												The unit is [°C]
465	1000101110	IC8 Liquid pipe temperature												
466	0100101110	IC9 Liquid pipe temperature												
467	1100101110	IC10 Liquid pipe temperature												
468	0010101110	IC11 Liquid pipe temperature												
469	1010101110	IC12 Liquid pipe temperature												
470	0110101110	IC13 Liquid pipe temperature												
471	1110101110	IC14 Liquid pipe temperature												
472	0001101110	IC15 Liquid pipe temperature												
473	1001101110	IC16 Liquid pipe temperature												
474	0101101110	IC17 Liquid pipe temperature												
475	1101101110	IC18 Liquid pipe temperature												
476	0011101110	IC19 Liquid pipe temperature												
477	1011101110	IC20 Liquid pipe temperature												
478	0111101110	IC21 Liquid pipe temperature												
479	1111101110	IC22 Liquid pipe temperature												
480	0000011110	IC23 Liquid pipe temperature												
481	1000011110	IC24 Liquid pipe temperature												
482	0100011110	IC25 Liquid pipe temperature												
483	1100011110	IC26 Liquid pipe temperature												
484	0010011110	IC27 Liquid pipe temperature												
485	1010011110	IC28 Liquid pipe temperature												
486	0110011110	IC29 Liquid pipe temperature												
487	1110011110	IC30 Liquid pipe temperature												
488	0001011110	IC31 Liquid pipe temperature												
489	1001011110	IC32 Liquid pipe temperature												
490	0101011110	IC33 Liquid pipe temperature												
491	1101011110	IC34 Liquid pipe temperature												

*1 A: The condition of either OC or OS is displayed individually. B: The condition of the entire refrigerant system is displayed.

Data on indoor unit system

No.	SW1	Item	Display								Unit (A, B) *1		Remarks	
			LD1	LD2	LD3	LD4	LD5	LD6	LD7	LD8	OC	OS		
492	0011011110	IC35 Liquid pipe temperature											B	The unit is [°C]
493	1011011110	IC36 Liquid pipe temperature												
494	0111011110	IC37 Liquid pipe temperature												
495	1111011110	IC38 Liquid pipe temperature												
496	0000111110	IC39 Liquid pipe temperature												
497	1000111110	IC40 Liquid pipe temperature												
498	0100111110	IC41 Liquid pipe temperature												
499	1100111110	IC42 Liquid pipe temperature												
500	0010111110	IC43 Liquid pipe temperature												
501	1010111110	IC44 Liquid pipe temperature												
502	0110111110	IC45 Liquid pipe temperature												
503	1110111110	IC46 Liquid pipe temperature												
504	0001111110	IC47 Liquid pipe temperature												
505	1001111110	IC48 Liquid pipe temperature												
506	0101111110	IC49 Liquid pipe temperature												
507	1101111110	IC50 Liquid pipe temperature												
508	0011111110													
509	1011111110													
510	0111111110													
511	1111111110													

*1 A: The condition of either OC or OS is displayed individually. B: The condition of the entire refrigerant system is displayed.

Setting data

No.	SW1	Item	Display								Unit (A, B) ^{*1}		Remarks
			LD1	LD2	LD3	LD4	LD5	LD6	LD7	LD8	OC	OS	
512	0000000001	Self-address	Alternate display of self address and unit model								A	A	
513	1000000001	IC/FU address	Count-up display of number of connected units								B		
514	0100000001	RC address	Count-up display of number of connected units								B		
515	1100000001	BC/BS/TU address	Count-up display of number of connected units										
516	0010000001	OS address	Count-up display of number of connected units								B		
517	1010000001	Version/Capacity	S/W version -> Refrigerant type -> Model and capacity -> Communication address								A	A	
518	0110000001	OC address	OC address display									B	
519	1110000001												
520	0001000001												
521	1001000001												
522	0101000001												

*1 A: The condition of either OC or OS is displayed individually. B: The condition of the entire refrigerant system is displayed.

Data on indoor unit system

No.	SW1	Item	Display								Unit (A, B) ^{*1}		Remarks			
			LD1	LD2	LD3	LD4	LD5	LD6	LD7	LD8	OC	OS				
523	1101000001	IC1 Gas pipe temperature												B		The unit is [°C]
524	0011000001	IC2 Gas pipe temperature														
525	1011000001	IC3 Gas pipe temperature														
526	0111000001	IC4 Gas pipe temperature														
527	1111000001	IC5 Gas pipe temperature														
528	0000100001	IC6 Gas pipe temperature														
529	1000100001	IC7 Gas pipe temperature														
530	0100100001	IC8 Gas pipe temperature														
531	1100100001	IC9 Gas pipe temperature														
532	0010100001	IC10 Gas pipe temperature														
533	1010100001	IC11 Gas pipe temperature														
534	0110100001	IC12 Gas pipe temperature														
535	1110100001	IC13 Gas pipe temperature														
536	0001100001	IC14 Gas pipe temperature														
537	1001100001	IC15 Gas pipe temperature														
538	0101100001	IC16 Gas pipe temperature														
539	1101100001	IC17 Gas pipe temperature														
540	0011100001	IC18 Gas pipe temperature														
541	1011100001	IC19 Gas pipe temperature														
542	0111100001	IC20 Gas pipe temperature														
543	1111100001	IC21 Gas pipe temperature														
544	0000010001	IC22 Gas pipe temperature														
545	1000010001	IC23 Gas pipe temperature														
546	0100010001	IC24 Gas pipe temperature														
547	1100010001	IC25 Gas pipe temperature														
548	0010010001	IC26 Gas pipe temperature														
549	1010010001	IC27 Gas pipe temperature														

*1 A: The condition of either OC or OS is displayed individually. B: The condition of the entire refrigerant system is displayed.

Data on indoor unit system

No.	SW1	Item	Display								Unit (A, B) *1		Remarks	
			LD1	LD2	LD3	LD4	LD5	LD6	LD7	LD8	OC	OS		
550	1234567890	IC28 Gas pipe temperature												The unit is [°C]
551	0110010001	IC29 Gas pipe temperature												
552	1110010001	IC30 Gas pipe temperature												
553	0001010001	IC31 Gas pipe temperature												
554	1001010001	IC32 Gas pipe temperature												
555	0101010001	IC33 Gas pipe temperature												
556	1101010001	IC34 Gas pipe temperature												
557	0011010001	IC35 Gas pipe temperature												
558	1011010001	IC36 Gas pipe temperature												
559	0111010001	IC37 Gas pipe temperature												
560	1111010001	IC38 Gas pipe temperature												
561	0000110001	IC39 Gas pipe temperature												
562	1000110001	IC40 Gas pipe temperature												
563	0100110001	IC41 Gas pipe temperature												
564	1100110001	IC42 Gas pipe temperature												
565	0010110001	IC43 Gas pipe temperature												
566	1010110001	IC44 Gas pipe temperature												
567	0110110001	IC45 Gas pipe temperature												
568	1110110001	IC46 Gas pipe temperature												
569	0001110001	IC47 Gas pipe temperature												
570	1001110001	IC48 Gas pipe temperature												
571	0101110001	IC49 Gas pipe temperature												
572	1101110001	IC50 Gas pipe temperature												

*1 A: The condition of either OC or OS is displayed individually. B: The condition of the entire refrigerant system is displayed.

Data on indoor unit system

No.	SW1	Item	Display								Unit (A, B) ^{*1}		Remarks	
			LD1	LD2	LD3	LD4	LD5	LD6	LD7	LD8	OC	OS		
573	1011110001	IC1SH												The unit is [°C]
574	0111110001	IC2SH												
575	1111110001	IC3SH												
576	000001001	IC4SH												
577	100001001	IC5SH												
578	010001001	IC6SH												
579	110001001	IC7SH												
580	0010001001	IC8SH												
581	1010001001	IC9SH												
582	0110001001	IC10SH												
583	1110001001	IC11SH												
584	0001001001	IC12SH												
585	1001001001	IC13SH												
586	0101001001	IC14SH												
587	1101001001	IC15SH												
588	0011001001	IC16SH												
589	1011001001	IC17SH												
590	0111001001	IC18SH												
591	1111001001	IC19SH												
592	0000101001	IC20SH												
593	1000101001	IC21SH												
594	0100101001	IC22SH												
595	1100101001	IC23SH												
596	0010101001	IC24SH												
597	1010101001	IC25SH												
598	0110101001	IC26SH												
599	1110101001	IC27SH												

*1 A: The condition of either OC or OS is displayed individually. B: The condition of the entire refrigerant system is displayed.

Data on indoor unit system

No.	SW1	Item	Display								Unit (A, B) ^{*1}		Remarks	
			LD1	LD2	LD3	LD4	LD5	LD6	LD7	LD8	OC	OS		
600	0001101001	IC28SH												The unit is [°C]
601	1001101001	IC29SH												
602	0101101001	IC30SH												
603	1101101001	IC31SH												
604	0011101001	IC32SH												
605	1011101001	IC33SH												
606	0111101001	IC34SH												
607	1111101001	IC35SH												
608	0000011001	IC36SH												
609	1000011001	IC37SH												
610	0100011001	IC38SH												
611	1100011001	IC39SH												
612	0010011001	IC40SH												
613	1010011001	IC41SH												
614	0110011001	IC42SH												
615	1110011001	IC43SH												
616	0001011001	IC44SH												
617	1001011001	IC45SH												
618	0101011001	IC46SH												
619	1101011001	IC47SH												
620	0011011001	IC48SH												
621	1011011001	IC49SH												
622	0111011001	IC50SH												

*1 A: The condition of either OC or OS is displayed individually. B: The condition of the entire refrigerant system is displayed.

Data on indoor unit system

No.	SW1	Item	Display								Unit (A, B) ^{*1}		Remarks	
			LD1	LD2	LD3	LD4	LD5	LD6	LD7	LD8	OC	OS		
623	1111011001	IC1SC												The unit is [°C]
624	0000111001	IC2SC												
625	1000111001	IC3SC												
626	0100111001	IC4SC												
627	1100111001	IC5SC												
628	0010111001	IC6SC												
629	1010111001	IC7SC												
630	0110111001	IC8SC												
631	1110111001	IC9SC												
632	0001111001	IC10SC												
633	1001111001	IC11SC												
634	0101111001	IC12SC												
635	1101111001	IC13SC												
636	0011111001	IC14SC												
637	1011111001	IC15SC												
638	0111111001	IC16SC												
639	1111111001	IC17SC												
640	0000000101	IC18SC												
641	1000000101	IC19SC												
642	0100000101	IC20SC												
643	1100000101	IC21SC												
644	0010000101	IC22SC												
645	1010000101	IC23SC												
646	0110000101	IC24SC												
647	1110000101	IC25SC												
648	0001000101	IC26SC												
649	1001000101	IC27SC												

*1 A: The condition of either OC or OS is displayed individually. B: The condition of the entire refrigerant system is displayed.

Data on indoor unit system

No.	SW1	Item	Display								Unit (A, B) ^{*1}			Remarks
			LD1	LD2	LD3	LD4	LD5	LD6	LD7	LD8	OC	OS		
650	0101000101	IC28SC											B	The unit is [°C]
651	1101000101	IC29SC												
652	0011000101	IC30SC												
653	1011000101	IC31SC												
654	0111000101	IC32SC												
655	1111000101	IC33SC												
656	0000100101	IC34SC												
657	1000100101	IC35SC												
658	0100100101	IC36SC												
659	1100100101	IC37SC												
660	0010100101	IC38SC												
661	1010100101	IC39SC												
662	0110100101	IC40SC												
663	1110100101	IC41SC												
664	0001100101	IC42SC												
665	1001100101	IC43SC												
666	0101100101	IC44SC												
667	1101100101	IC45SC												
668	0011100101	IC46SC												
669	1011100101	IC47SC												
670	0111100101	IC48SC												
671	1111100101	IC49SC												
672	0000010101	IC50SC												
673	1000010101													
674	0100010101													
675	1100010101													

*1 A: The condition of either OC or OS is displayed individually. B: The condition of the entire refrigerant system is displayed.

Setting data

No.	SW1	Item	Display								Unit (A, B)*1		Remarks	
			LD1	LD2	LD3	LD4	LD5	LD6	LD7	LD8	OC	OS		
676	0010010101	INV board S/W version										A	A	
677	1010010101													
678	0110010101													
679	1110010101	Fan board S/W version										A	A	
680	0001010101													
681	1001010101													
682	0101010101													
683	1101010101													
684	0011010101													
685	1011010101													
686	0111010101													
687	1111010101													

*1 A: The condition of either OC or OS is displayed individually. B: The condition of the entire refrigerant system is displayed.

Setting data

No.	SW1	Item	Display								Unit (A, B)*1		Remarks
			LD1	LD2	LD3	LD4	LD5	LD6	LD7	LD8	OC	OS	
688	0000110101	Current time	00:00 to 23:59								A	A	Hour: minute
689	1000110101	Current time -2	00.00 to 99.12/1 to 31										Year and month, and date alternate display
690	0100110101	Time of error detection 1	00:00 to 23:59										Hour: minute
691	1100110101	Time of error detection 1-2	00.00 to 99.12/1 to 31										Year and month, and date alternate display
692	0010110101	Time of error detection 2	00:00 to 23:59										Hour: minute
693	1010110101	Time of error detection 2-2	00.00 to 99.12/1 to 31										Year and month, and date alternate display
694	0110110101	Time of error detection 3	00:00 to 23:59										Hour: minute
695	1110110101	Time of error detection 3-2	00.00 to 99.12/1 to 31										Year and month, and date alternate display
696	0001110101	Time of error detection 4	00:00 to 23:59										Hour: minute
697	1001110101	Time of error detection 4-2	00.00 to 99.12/1 to 31										Year and month, and date alternate display
698	0101110101	Time of error detection 5	00:00 to 23:59										Hour: minute
699	1101110101	Time of error detection 5-2	00.00 to 99.12/1 to 31										Year and month, and date alternate display
700	0011110101	Time of error detection 6	00:00 to 23:59										Hour: minute
701	1011110101	Time of error detection 6-2	00.00 to 99.12/1 to 31										Year and month, and date alternate display

*1 A: The condition of either OC or OS is displayed individually. B: The condition of the entire refrigerant system is displayed.

Setting data

No.	SW1	Item	Display								Unit (A, B)*1		Remarks
			LD1	LD2	LD3	LD4	LD5	LD6	LD7	LD8	OC	OS	
702	0111110101	Time of error detection 7	00:00 to 23:59								A	A	Hour: minute
703	1111110101	Time of error detection 7-2	00.00 to 99.12/1 to 31										Year and month, and date alternate display
704	0000001101	Time of error detection 8	00:00 to 23:59										Hour: minute
705	1000001101	Time of error detection 8-2	00.00 to 99.12/1 to 31										Year and month, and date alternate display
706	0100001101	Time of error detection 9	00:00 to 23:59										Hour: minute
707	1100001101	Time of error detection 9-2	00.00 to 99.12/1 to 31										Year and month, and date alternate display
708	0010001101	Time of error detection 10	00:00 to 23:59										Hour: minute
709	1010001101	Time of error detection 10-2	00.00 to 99.12/1 to 31										Year and month, and date alternate display
710	0110001101	Time of last data backup before error	00:00 to 23:59										Hour: minute
711	1110001101	Time of last data backup before error -2	00.00 to 99.12/1 to 31										Year and month, and date alternate display
712	0001001101												
713	1001001101												

*1 A: The condition of either OC or OS is displayed individually. B: The condition of the entire refrigerant system is displayed.

Data on indoor unit system

No.	SW1	Item	Display								Unit (A, B) * 1		Remarks
			LD1	LD2	LD3	LD4	LD5	LD6	LD7	LD8	OC	OS	
714	0101001101	IC1 LEV opening	0000 to 9999								B		Fully open: 2000
715	1101001101	IC2 LEV opening	0000 to 9999										
716	0011001101	IC3 LEV opening	0000 to 9999										
717	1011001101	IC4 LEV opening	0000 to 9999										
718	0111001101	IC5 LEV opening	0000 to 9999										
719	1111001101	IC6 LEV opening	0000 to 9999										
720	0000101101	IC7 LEV opening	0000 to 9999										
721	1000101101	IC8 LEV opening	0000 to 9999										
722	0100101101	IC9 LEV opening	0000 to 9999										
723	1100101101	IC10 LEV opening	0000 to 9999										
724	0010101101	IC11 LEV opening	0000 to 9999										
725	1010101101	IC12 LEV opening	0000 to 9999										
726	0110101101	IC13 LEV opening	0000 to 9999										
727	1110101101	IC14 LEV opening	0000 to 9999										
728	0001101101	IC15 LEV opening	0000 to 9999										
729	1001101101	IC16 LEV opening	0000 to 9999										
730	0101101101	IC17 LEV opening	0000 to 9999										
731	1101101101	IC18 LEV opening	0000 to 9999										
732	0011101101	IC19 LEV opening	0000 to 9999										
733	1011101101	IC20 LEV opening	0000 to 9999										
734	0111101101	IC21 LEV opening	0000 to 9999										
735	1111101101	IC22 LEV opening	0000 to 9999										
736	0000011101	IC23 LEV opening	0000 to 9999										
737	1000011101	IC24 LEV opening	0000 to 9999										
738	0100011101	IC25 LEV opening	0000 to 9999										
739	1100011101	IC26 LEV opening	0000 to 9999										
740	0010011101	IC27 LEV opening	0000 to 9999										

*1 A: The condition of either OC or OS is displayed individually. B: The condition of the entire refrigerant system is displayed.

Data on indoor unit system

No.	SW1	Item	Display								Unit (A, B) *1		Remarks
			LD1	LD2	LD3	LD4	LD5	LD6	LD7	LD8	OC	OS	
741	1010011101	IC28 LEV opening	0000 to 9999								B		Fully open: 2000
742	0110011101	IC29 LEV opening	0000 to 9999										
743	1110011101	IC30 LEV opening	0000 to 9999										
744	0001011101	IC31 LEV opening	0000 to 9999										
745	1001011101	IC32 LEV opening	0000 to 9999										
746	0101011101	IC33 LEV opening	0000 to 9999										
747	1101011101	IC34 LEV opening	0000 to 9999										
748	0011011101	IC35 LEV opening	0000 to 9999										
749	1011011101	IC36 LEV opening	0000 to 9999										
750	0111011101	IC37 LEV opening	0000 to 9999										
751	1111011101	IC38 LEV opening	0000 to 9999										
752	0000111101	IC39 LEV opening	0000 to 9999										
753	1000111101	IC40 LEV opening	0000 to 9999										
754	0100111101	IC41 LEV opening	0000 to 9999										
755	1100111101	IC42 LEV opening	0000 to 9999										
756	0010111101	IC43 LEV opening	0000 to 9999										
757	1010111101	IC44 LEV opening	0000 to 9999										
758	0110111101	IC45 LEV opening	0000 to 9999										
759	1110111101	IC46 LEV opening	0000 to 9999										
760	0001111101	IC47 LEV opening	0000 to 9999										
761	1001111101	IC48 LEV opening	0000 to 9999										
762	0101111101	IC49 LEV opening	0000 to 9999										
763	1101111101	IC50 LEV opening	0000 to 9999										
764	0011111101	IC1 Operation mode	0000 : Stop 0001 : Ventilation 0002 : Cooling 0003 : Heating 0004 : Dry								B		
765	1011111101	IC2 Operation mode											
766	0111111101	IC3 Operation mode											
767	1111111101	IC4 Operation mode											
768	0000000011	IC5 Operation mode											

*1 A: The condition of either OC or OS is displayed individually. B: The condition of the entire refrigerant system is displayed.

Data on indoor unit system

No.	SW1	Item	Display								Unit (A, B) *1		Remarks		
			LD1	LD2	LD3	LD4	LD5	LD6	LD7	LD8	OC	OS			
769	1000000011	IC6 Operation mode											B		
770	0100000011	IC7 Operation mode													
771	1100000011	IC8 Operation mode													
772	0010000011	IC9 Operation mode													
773	1010000011	IC10 Operation mode													
774	0110000011	IC11 Operation mode													
775	1110000011	IC12 Operation mode													
776	0001000011	IC13 Operation mode													
777	1001000011	IC14 Operation mode													
778	0101000011	IC15 Operation mode													
779	1101000011	IC16 Operation mode													
780	0011000011	IC17 Operation mode													
781	1011000011	IC18 Operation mode													
782	0111000011	IC19 Operation mode													
783	1111000011	IC20 Operation mode													
784	0000100011	IC21 Operation mode													
785	1000100011	IC22 Operation mode													
786	0100100011	IC23 Operation mode													
787	1100100011	IC24 Operation mode													
788	0010100011	IC25 Operation mode													
789	1010100011	IC26 Operation mode													
790	0110100011	IC27 Operation mode													
791	1110100011	IC28 Operation mode													
792	0001100011	IC29 Operation mode													
793	1001100011	IC30 Operation mode													
794	0101100011	IC31 Operation mode													
795	1101100011	IC32 Operation mode													
796	0011100011	IC33 Operation mode													

0000 : Stop 0001 : Ventilation 0002 : Cooling 0003 : Heating 0004 : Dry

*1 A: The condition of either OC or OS is displayed individually. B: The condition of the entire refrigerant system is displayed.

Data on indoor unit system

No.	SW1	Item	Display											Unit (A, B) ^{*1}		Remarks	
			LD1	LD2	LD3	LD4	LD5	LD6	LD7	LD8	OC	OS					
797	1011100011	IC34 Operation mode													B		
798	0111100011	IC35 Operation mode															
799	1111100011	IC36 Operation mode															
800	0000010011	IC37 Operation mode															
801	1000010011	IC38 Operation mode															
802	0100010011	IC39 Operation mode															
803	1100010011	IC40 Operation mode															
804	0010010011	IC41 Operation mode															
805	1010010011	IC42 Operation mode															
806	0110010011	IC43 Operation mode															
807	1110010011	IC44 Operation mode															
808	0001010011	IC45 Operation mode															
809	1001010011	IC46 Operation mode															
810	0101010011	IC47 Operation mode															
811	1101010011	IC48 Operation mode															
812	0011010011	IC49 Operation mode															
813	1011010011	IC50 Operation mode															
814	0111010011	IC1 filter															Hours since last maintenance [h]
815	1111010011	IC2 filter															
816	0000110011	IC3 filter															
817	1000110011	IC4 filter															
818	0100110011	IC5 filter															
819	1100110011	IC6 filter															
820	0010110011	IC7 filter															
821	1010110011	IC8 filter															
822	0110110011	IC9 filter															
823	1110110011	IC10 filter															
824	0001110011	IC11 filter															

0000 : Stop 0001 : Ventilation 0002 : Cooling 0003 : Heating 0004 : Dry

0000 to 9999
 0000 to 9999
 0000 to 9999
 0000 to 9999
 0000 to 9999
 0000 to 9999
 0000 to 9999
 0000 to 9999
 0000 to 9999
 0000 to 9999
 0000 to 9999

*1 A: The condition of either OC or OS is displayed individually. B: The condition of the entire refrigerant system is displayed.

Data on indoor unit system

No.	SW1	Item	Display								Unit (A, B) *1		Remarks
			LD1	LD2	LD3	LD4	LD5	LD6	LD7	LD8	OC	OS	
825	1001110011	IC12 filter	0000 to 9999								B		Hours since last maintenance [h]
826	0101110011	IC13 filter	0000 to 9999										
827	1101110011	IC14 filter	0000 to 9999										
828	0011110011	IC15 filter	0000 to 9999										
829	1011110011	IC16 filter	0000 to 9999										
830	0111110011	IC17 filter	0000 to 9999										
831	1111110011	IC18 filter	0000 to 9999										
832	0000001011	IC19 filter	0000 to 9999										
833	1000001011	IC20 filter	0000 to 9999										
834	0100001011	IC21 filter	0000 to 9999										
835	1100001011	IC22 filter	0000 to 9999										
836	0010001011	IC23 filter	0000 to 9999										
837	1010001011	IC24 filter	0000 to 9999										
838	0110001011	IC25 filter	0000 to 9999										
839	1110001011	IC26 filter	0000 to 9999										
840	0001001011	IC27 filter	0000 to 9999										
841	1001001011	IC28 filter	0000 to 9999										
842	0101001011	IC29 filter	0000 to 9999										
843	1101001011	IC30 filter	0000 to 9999										
844	0011001011	IC31 filter	0000 to 9999										
845	1011001011	IC32 filter	0000 to 9999										
846	0111001001	IC33 filter	0000 to 9999										
847	1111001011	IC34 filter	0000 to 9999										
848	0000101011	IC35 filter	0000 to 9999										
849	1000101011	IC36 filter	0000 to 9999										
850	0100101011	IC37 filter	0000 to 9999										
851	1100101011	IC38 filter	0000 to 9999										
852	0010101011	IC39 filter	0000 to 9999										

*1 A: The condition of either OC or OS is displayed individually. B: The condition of the entire refrigerant system is displayed.

Data on indoor unit system

No.	SW1 1234567890	Item	Display								Unit (A, B) ^{*1}		Remarks
			LD1	LD2	LD3	LD4	LD5	LD6	LD7	LD8	OC	OS	
853	1010101011	IC40 filter	0000 to 9999								B		Hours since last maintenance [h]
854	0110101011	IC41 filter	0000 to 9999										
855	1110101011	IC42 filter	0000 to 9999										
856	0001101011	IC43 filter	0000 to 9999										
857	1001101011	IC44 filter	0000 to 9999										
858	0101101011	IC45 filter	0000 to 9999										
859	1101101011	IC46 filter	0000 to 9999										
860	0011101011	IC47 filter	0000 to 9999										
861	1011101011	IC48 filter	0000 to 9999										
862	0111101011	IC49 filter	0000 to 9999										
863	1111101011	IC50 filter	0000 to 9999										

*1 A: The condition of either OC or OS is displayed individually. B: The condition of the entire refrigerant system is displayed.

Other types of data

No.	SW1	Item	Display								Unit (A, B) *1		Remarks	
			LD1	LD2	LD3	LD4	LD5	LD6	LD7	LD8	OC	OS		
864	0000011011													
865	1000011011													
866	0100011011													
867	1100011011													
868	0010011011													
869	1010011011													
870	0110011011													
871	1110011011	U-phase current effective value 1							-99.9 to 999.9			A	A	The unit is [A]
872	0001011011	W-phase current effective value 1							-99.9 to 999.9			A	A	
873	1001011011	Power factor phase angle 1							-99.9 to 999.9			A	A	The unit is [deg]
874	0101011011													
875	1101011011													
876	0011011011													
877	1011011011													
878	0111011011													
879	1111011011													
880	0000111011	Control board Reset counter							0 to 254			A	A	The unit is [time]
881	1000111011	INV board Reset counter							0 to 254			A	A	
882	0100111011													
883	1100111011													
884	0010111011	Fan board Reset counter							0 to 254			A	A	The unit is [time]
885	1010111011													
886	0110111011													

*1 A: The condition of either OC or OS is displayed individually. B: The condition of the entire refrigerant system is displayed.

Other types of data

No.	SW1	Item	Display								Unit (A, B) *1		Remarks	
			LD1	LD2	LD3	LD4	LD5	LD6	LD7	LD8	OC	OS		
887	1110111011													
888	0001111011													
889	1001111011													
890	0101111011													
891	1101111011													
892	0011111011													
893	1011111011													
894	0111111011													
895	1111111011													
896	0000000111													
897	1000000111													
898	0100000111													
899	1100000111													
900	0010000111													
901	1010000111													
902	0110000111													
903	1110000111													
904	0001000111													
905	1001000111													
906	0101000111													
907	1101000111													
1020	0011111111													
1021	1011111111													
1022	0111111111													
1023	1111111111													

*1 A: The condition of either OC or OS is displayed individually. B: The condition of the entire refrigerant system is displayed.

Service Handbook PUHY-P200, P250, P300, P350YHM-A
PUHY-P400, P450YHM-A
PUHY-P500, P550, P600, P650YSHM-A
PUHY-P700, P750, P800, P850, P900YSHM-A
PUHY-P950, P1000, P1050, P1100, P1150, P1200, P1250YSHM-A

PUHY-EP200, EP250, EP300YHM-A
PUHY-EP400, EP450YSHM-A(1)
PUHY-EP500, EP550, EP600, EP650YSHM-A(1)
PUHY-EP700, EP750, EP800, EP850, EP900YSHM-A(1)

