



# thermoscreens®

PHV RECESSED HEAT PUMP AIR CURTAINS

## INSTALLATION, OPERATION & MAINTENANCE INSTRUCTIONS



For use with CITY MULTI VRF units

**PLEASE READ THESE INSTRUCTIONS CAREFULLY BEFORE ATTEMPTING INSTALLATION**

Thermoscreens Ltd  
St. Mary's Road Nuneaton  
Warwickshire England  
CV11 5AU

Email: [sales@thermoscreens.com](mailto:sales@thermoscreens.com)

Tel: +44 (0) 24 7638 4646

Fax: +44 (0) 24 7638 8578

[www.thermoscreens.com](http://www.thermoscreens.com)



English

## Thermoscreens / Mitsubishi Electric

Thermoscreens City Multi Heat Pump Air Curtains can be used with Mitsubishi Electric City Multi Y/WY-Series (Heat Pump) or City Multi R2/WR2-Series (Heat Recovery) systems.

### City Multi Y/WY-Series Heat Pump Air Curtain System

City Multi Y/WY-Series Heat Pump Air Curtain Schematic :-

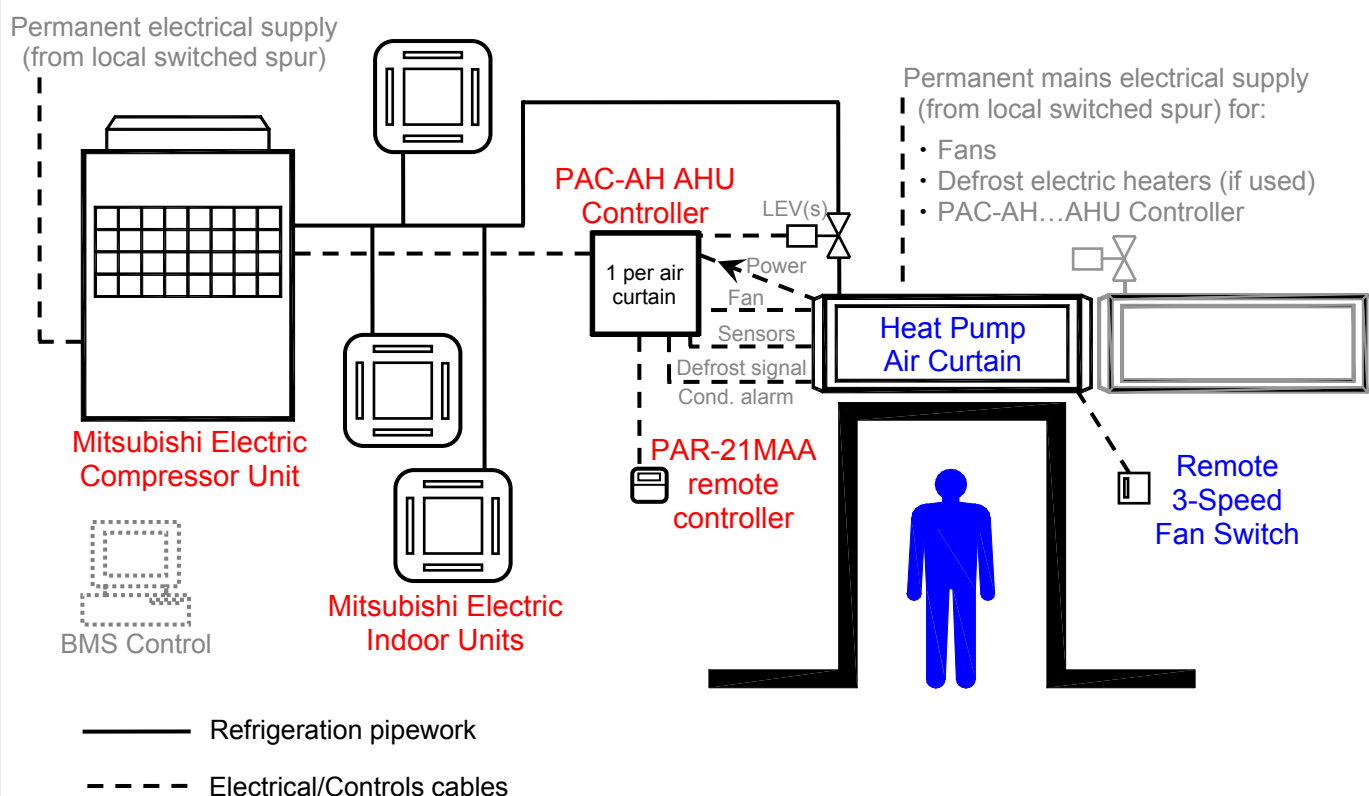

City Multi Y-Series System:-

Indoor Units and Air Curtains(s) all operate on heating at the same time, or all operate on cooling at the same time.

The City Multi Y Series Heat Pump Air Curtain system consists of :-

- One or more Thermoscreens VRF PHVR Heat Pump (heating & cooling) Air Curtains \*
- A Mitsubishi Electric PAC-AH...M-G AHU Controller or PAC-AH...M-H AHU Controller (one for each air curtain) \*
- A Mitsubishi Electric PAR-21MAA Remote Controller (one for each AHU Controller) +
- One or more Mitsubishi Electric City Multi Y/WY-Series Compressor Unit +
- Mitsubishi Electric Indoor Unit(s) + [NB. Can be used on a full air curtain basis if required up to 100% diversity]
- Mitsubishi Electric BMS System or Centralised Controller, if required +

\* - supplied by Thermoscreens Ltd.; + - supplied by others

# City Multi R2/WR2-Series Heat Pump Air Curtain System

## City Multi R2/WR2-Series Heat Recovery Heat Pump Air Curtain Schematic :-

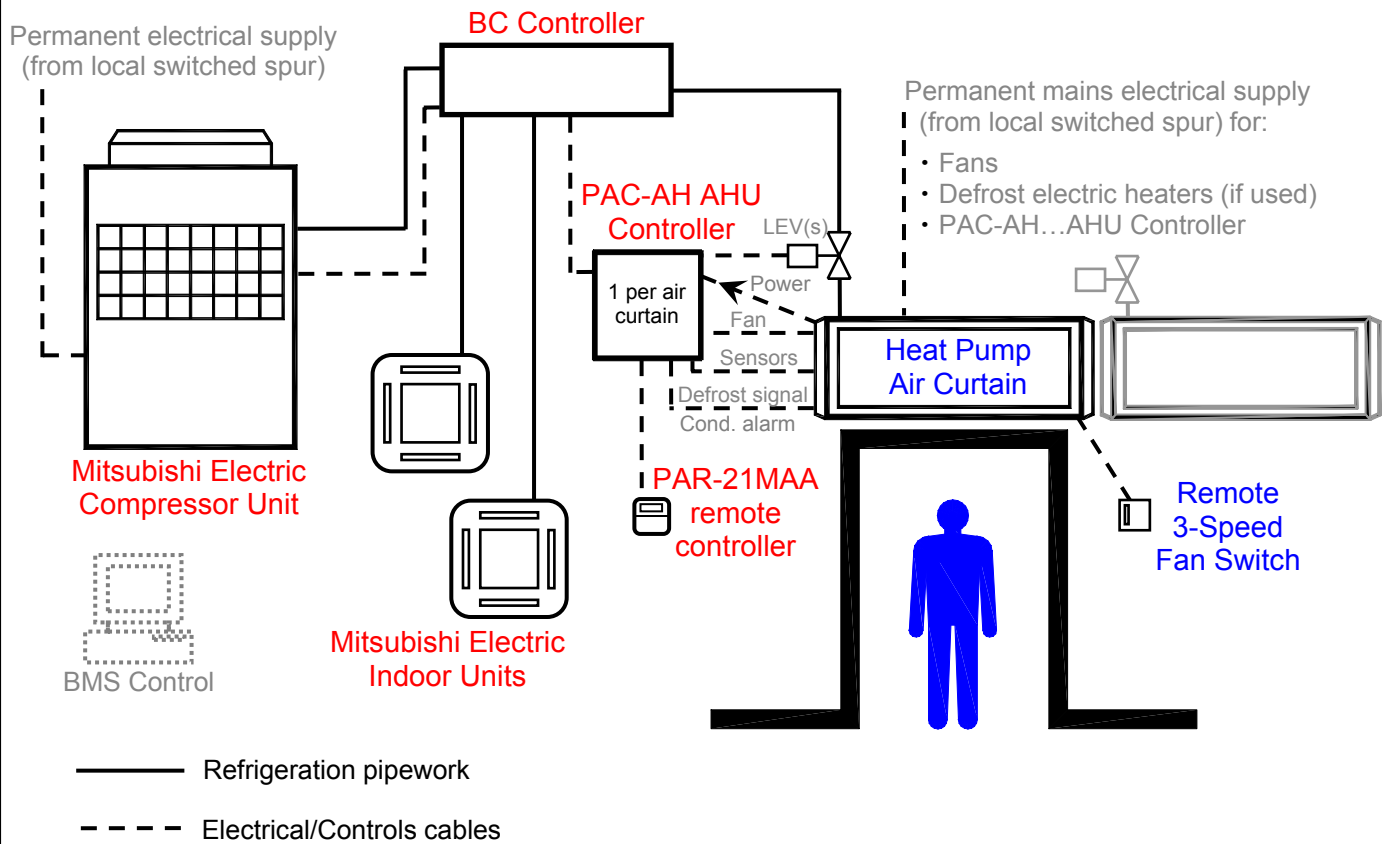

### City Multi R2/WR2-Series System:-

Indoor Units and Air Curtains(s) can operate on heating or cooling simultaneously, e.g. some indoor units are cooling whilst other indoor units and air curtain are heating at the same time.

The City Multi R2/WR2-Series heat recovery system with Heat Pump Air Curtain(s) consists of :-

- One or more Thermoscreens VRF PHVR Heat Pump (heating & cooling) Air Curtains \*
  - A Mitsubishi Electric PAC-AH...M-G AHU Controller or PAC-AH...M-H AHU Controller (one for each air curtain) \*
  - A Mitsubishi Electric PAR-21MAA Remote Controller (one for each AHU Controller) +
  - One or more Mitsubishi Electric City Multi R2/WR2-Series Compressor Unit +
  - Mitsubishi Electric BC Controller +
  - Mitsubishi Electric Indoor Unit(s) + [NB. Can be used on a full air curtain basis if required up to 100% diversity]
  - Mitsubishi Electric BMS System or Centralised Controller, if required +
- \* - supplied by Thermoscreens Ltd.; + - supplied by others

## DESIGN INFORMATION

Each Thermoscreens Heat Pump Air Curtain needs to operate with a Mitsubishi Electric PAC-AH...AHU Controller. There are two versions that can be used; PAC-AH...**M-G** and PAC-AH...**M-H** the supply of which is dependent on the EU state/country where the installation is being carried out.

The rated size of the PAC-AH...AHU Controller needs to be matched to the size of the heat pump air curtain. Each size of AHU Controller comes with different size LEV(s) and number of LEVs so they need to be matched to the air curtain. The table shows the AHU Controller to be selected and maximum outputs and air volume flow rates of the heat pump air curtain.

Air Curtain	PAC-AH...AHU Controller	LEV(s) No.Off Index Size	Maximum Heat Pump Output (kW)		Air Volume Flow (m <sup>3</sup> /h)
			Heating	Cooling	
VRF PHV1000R DXE HO	PAC-AH125M-G or PAC-AH125M-H	Type P632411X01 1 off P100	9.0	8.1	1400
VRF PHV1500R DXE LO	PAC-AH125M-G or PAC-AH125M-H	Type P632411X01 1 off P125	10.6	9.0	2500
VRF PHV1500R DXE HO	PAC-AH140M-G or PAC-AH140M-H	Type P632414X01 1 off P140	15.1	13.6	2600
VRF PHV2000R DXE LO	PAC-AH140M-G or PAC-AH140M-H	Type P632414X01 1 off P140	16.4	14.8	3300
VRF PHV2000R DXE HO	PAC-AH250M-G or PAC-AH250M-H	Type P632411X01 2 off P200	21.4	19.3	3130

Maximum heat pump output refers to the heating or cooling output from the air curtain air stream. Figures are derived from laboratory testing with reference to test standard EN14511. They are with the air curtain operating at high fan speed, outdoor air temperature 7/6°C db/wb indoor air temperature 20°C db for heating; outdoor air temperature 35/27°C db/wb indoor air temperature 27°C db for cooling. Contact Mitsubishi Electric for performance at other outdoor and indoor conditions. The air curtain normally operates under automatic temperature control set on the PAR-21MAA remote controller and can also run at part load.

The following City Multi compressor units can be connected:

For Y/WY-Series systems:

PUHY-(E)P200 .... 1250Y(S)HM-A  
 PQHY-P200 .... 600Y(S)HM-A  
 PUMY-P100 .... 140V(Y)HMB  
 PUHY-HP200 .... 500Y(S)HM-A

For R2/WR2-Series systems:

PURY-(E)P200 .... 800Y(S)HM-A  
 PQRY-P200 .... 600Y(S)HM-A

The Thermoscreens Air Curtain requires a permanent mains electrical supply from a local switched isolator. Electrical power to the PAC-AH...AHU controller is then fed from the air curtain. Electrical power to the Mitsubishi Electric compressor unit(s) and BC Controller is fed separately in the normal way (see separate Mitsubishi Electric instructions). If the defrost cycle electric heaters inside the air curtain are to be used during the heating mode defrost cycle the electrical supply to the air curtain needs to be 3-phase (3L+N+E). If the defrost cycle electric heaters are not required they can be permanently disconnected at installation and a single phase electrical supply (1L+N+E) fed to the air curtain instead, see 'Installation - Electrical Supply'.

**Warning:** Air curtain fans continue to operate during heating mode system defrost to maintain an air stream across the doorway. With the defrost cycle electric heaters operating the discharge air temperature from the air curtain is kept to a few degrees below that of the indoor ambient air temperature during the duration of system defrost. If the electric heaters are disconnected, discharge air temperatures could be very cold, approximately 6°C during the defrost and defrost times will also be extended, particularly with the R2-Series System. Defrost does not occur with WY and WR2 systems so the defrost cycle electric heaters should be disconnected on these systems.

There are various control cables that are wired on site to the PAC-AH...AHU Controller and the Thermoscreens Air Curtain that provide control for the operation of the unit. These are:-

- Start/Stop of air curtain fans
- Operation of LEV(s) for control of heating or cooling output
- Thermistor sensors
- PAR-21MAA Remote Controller for end user manual control, if used
- On/Off of electric heaters inside the air curtain during system defrost (if used)
- Condensate alarm derived from condensate pump alarm sensor (if used)
- M-Net communications link to the Mitsubishi Electric Compressor Unit.  
(see also wiring diagrams)

The Thermoscreens Air Curtain is supplied with an integral condensate drain tray to enable the air curtain to be used in cooling mode during warm weather, if so desired. If it is intended to use the air curtain in cooling mode a condensate drain system is required. It is possible to gravity drain condensate from these recessed air curtains via a condensate outlet hole that is c.40mm minimum above the top surface of the ceiling within the ceiling void. Means of condensate disposal must then be provided within the ceiling void.

Alternatively, a suitable condensate pump (not supplied by Thermoscreens) can be supplied and fitted by the installer to remove condensate directly from the unit. The condensate pump must be of sufficient capacity (see Page 20) and if located above the drain tray; self priming and capable of providing the appropriate suction head so the pump will lift condensate out from the top of the air curtain. Suitable condensate pumps with a suction head are Peristaltic or Rotary Diaphragm type. We recommend the Blue Diamond rotary diaphragm type with cooling signal sensor (drainStik) manufactured by Charles Austen Pumps Ltd. ([www.miniblue.co.uk](http://www.miniblue.co.uk)). It is recommended that the condensate pump has the facility so it only operates when the air curtain is in cooling mode by detection of water in the drain tray or by detecting a cooling differential in the airflow. It should also have a pump overrun to empty the drain tray as much as possible when the air curtain is switched off.

The condensate disposal system should have an alarm system with appropriate sensor fitted in the drain tray that will give a volt-free signal (open circuit = alarm). This will stop

the air curtain cooling if the condensate drain tray is in danger of flooding, air curtain fans will continue to operate. Other indoor units on the same City Multi system are unaffected if the air curtain condensate alarm occurs. There is a plastic fixing bracket with 8mm diameter hole attached to the drain tray inside the air curtain so a condensate sensor can be fixed in the tray by the installer. The hole can be enlarged, if necessary, to suit the type of sensor used so it is located in the tray at the appropriate position, see the manufacturer's instructions that come with the condensate pump for further information. The 230v AC, single phase electrical supply to operate the condensate pump will come from the air curtain.

**Warning:** The air curtain condensate collection system is designed to remove condensate with the air curtain operating in cooling mode during normal summer weather conditions in countries with a temperate climate. In case of extreme weather conditions or failure of the condensate disposal system, which can occur, it is vital that the design of the floor beneath the air curtain and its surface is such that it will not become slippery or damaged if it became wet. This is similar to the conditions that might be experienced with heavy rainfall in at an open doorway or wet pedestrian foot traffic, so careful consideration must be paid to the design of the floor and its surface finish.

If it is intended that the air curtain should not be operated in cooling mode and a condensate disposal system/pump is not fitted, the BMS System, Centralised Controller or PAR-21MAA manual Remote Controller must be configured at commissioning so that COOL or AUTO mode can never be selected (see Section – Commissioning). It is still recommended, however, that the floor design and surface be as described above in case cooling mode is used in the future and to cope with heavy rainfall or wet pedestrian foot traffic.

**Note:** It could still be possible for an end user to unlock a PAR-21MAA Remote Controller if they found out how to and switch it into cooling, not realising that condensate would then flood out of the drain tray. It may therefore be considered prudent to install a condensate disposal system even if it is intended that the unit should only be used in HEAT or FAN mode.

If a Building Management System (BMS) or Centralised Controller is to be used for control of the air curtain please contact Mitsubishi Electric for more details.

The air curtain is designed only for use with a Mitsubishi Electric City Multi VRF system for use on R410A. The complete Thermoscreens/Mitsubishi Electric heat pump system, including fridge pipework, wiring, controls, etc. must be installed only by an approved Mitsubishi Electric refrigeration contractor.

The air curtain is not intended for use by persons (including children) with reduced physical, sensory or mental capabilities, or lack of experience and knowledge, unless they have been given supervision or instruction concerning the use of the appliance by a person responsible for their safety.

High Output (HO) and Low Output (LO) in this document refers to the heat pump heating or cooling capacity of the Air Curtain, not to any electrical rating. HO air curtains have a 3-row coil, LO air curtains have a 2-row coil.

These instructions must be read in conjunction with the Mitsubishi Electric instructions that come with other components of the heat pump system, e.g. Compressor Unit, BC Controller, PAR-21MAA Remote Controller, BMS System, Centralised Controller, etc. They should be kept by the building facilities manager for future reference.

## UNPACKING THE HEAT PUMP AIR CURTAIN

The following items are supplied and packaged within the Thermoscreens air curtain box:-

### VRF Recessed Heat Pump Air Curtain

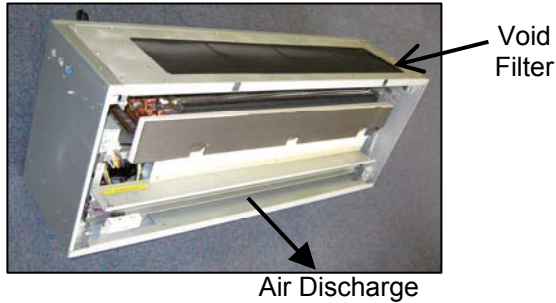

### Remote 3-Speed Fan Switch



The Recessed Grille is packed in a separate box but comes with the air curtain:-

### Recessed Grille with Filter

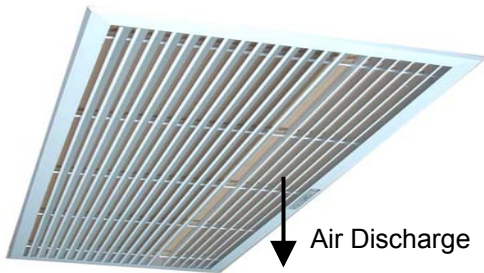

The Mitsubishi Electric PAC-AH...M-G AHU Controller or PAC-AH...M-H AHU Controller comes in its original Mitsubishi Electric box. It is delivered with the Thermoscreens air curtain and Recessed grille. It is factory pre-wired as much as possible to reduce installation time on site:-

### PAC-AH..M-G or M-H..AHU Controller



Check with the cross-reference labels on the Thermoscreens air curtain box and the Mitsubishi Electric AHU Controller box that the correct AHU Controller is matched with the correct air curtain.

Other components for the heat pump system are as described above on the System Schematics on pages 2 and 3.

The Installer will also need to supply and install the following:-

**PAR-21 MAA Remote Controller**



If Air Curtain is to be manually controlled, also needed for commissioning

**Condensate Disposal System and Condensate Pump (if non-gravity drain)**



If Air Curtain is to be operated in COOL or AUTO mode – see text for more information

The following optional equipment is also available for the air curtain:-

**Fan Speed Controller for low speeds**



For your records:

Date of Purchase.....

Place of Purchase.....

Serial Number.....

For warranty purposes proof of purchase is necessary so please keep a copy of your invoice.



## INSTALLATION OF THE HEAT PUMP AIR CURTAIN

The air curtain is designed to be recessed within ceiling voids or bulkheads within a building and located horizontally over a doorway. It must not be installed outside of the building.

### ■ Location

The air curtain must be mounted so the recessed grille is between 1.8m minimum and 3.5m maximum above floor level and situated as close to the doorway as possible. The Air Discharge section of the recessed grille must be nearest to the doorway and the Air Inlet section furthest from the doorway. Beware of doorway top edges, structural beams, door opening devices, etc. which may interfere with the air stream and affect the location of the unit. The air curtain must be installed level or condensate may leak out, particularly if it tilts down at the left hand side (looking out of the doorway from inside). It is better to tilt down slightly at the right hand side as the drain tray spout is this side.

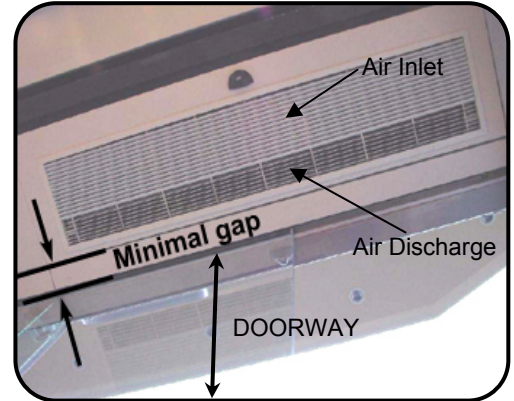

Ensure there will be adequate clear space above the top of the unit within the ceiling void to safely allow for pipework brazing operations.

The PHVR Recessed Heat Pump air curtain has a rectangular air ventilation hole with Void Filter on one side of the unit, see photo of unit on Page 7. This air ventilation hole will be inside the ceiling void once the air curtain is installed and air from the void needs to enter it for the correct operation of the unit. There must be a clearance gap of 80mm minimum between this ventilation hole and any obstruction/bulkhead within the ceiling void to allow ventilation air from the void to easily enter the air curtain. Furthermore, the ceiling void must be sufficiently large and freely ventilated so there will be an adequate supply of ventilation air ( $m^3/hr$ ) to the unit (see table below). If the ceiling void is enclosed around the air curtain it will need an air ventilation grille of effective free area ( $cm^2$ ) as given in the table below and an adequate air path within the void for air to enter the rectangular air ventilation hole.

Air curtain	Required air flow within ceiling void ( $m^3/hr$ )	Effective free area of ventilation grille for an enclosed ceiling void ( $cm^2$ )
VRF PHV1000R DXE	353	500
VRF PHV1500R DXE	421	700
VRF PHV2000R DXE	707	1200

## ■ Ceiling Suspension

Make the cut-out in the ceiling to the dimensions given in Figure 1 being as accurate as possible. The air curtain can be manoeuvred straight up through the ceiling cut-out. Ensure there is sufficient height clearance within the ceiling void to do this. Alternatively the ceiling can be fitted after the air curtain is installed. Bear in mind it will be necessary to carry out pipework brazing operations above the air curtain once it is located in position.

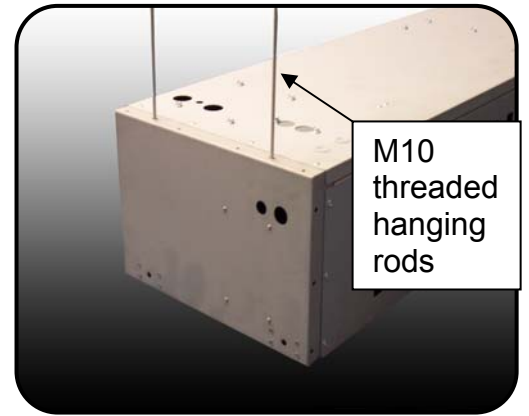

Holes are provided in the top face of the casing (see Figure 1 for positions) to allow the unit to be suspended on M10 threaded rods (not provided). All suspension points must be used.

Air Curtain	Weight (kg)	Number of hanging points
VRF PHV1000R DXE HO	45	4
VRF PHV1500R DXE LO	66	6
VRF PHV1500R DXE HO	67	6
VRF PHV2000R DXE LO	85	6
VRF PHV2000R DXE HO	88	6



Four of the threaded rods (the two at each end of the unit) enter the casing from above and are attached to fixing brackets near the bottom of the unit (see adjacent figure). The two centre threaded rods (on PHV1500 and PHV2000 Units) are attached to the top face of the casing.

Ensure each of the threaded rods is secured on to a suitable structure that can support the weight of the unit (see table above)\*. When fitting the threaded rod ensure that it does not interfere with internal components. Threaded rod should engage into fixing holes by a minimum of 20mm and locking nuts fitted to prevent the rod rotating and coming away from its fixing point.

*Note: When installing the air curtain ensure that the underside of the unit is between 40mm and 65mm above the exposed bottom face of the ceiling tile/plasterboard (see Figure 1). The recessed grille and other air curtain components have adjustment within this range, although aim to achieve the minimum 40mm if possible.*

\* It is the sole responsibility of the installer to ensure that the building fixing points and suspension system used are suitable for the air curtain being installed.

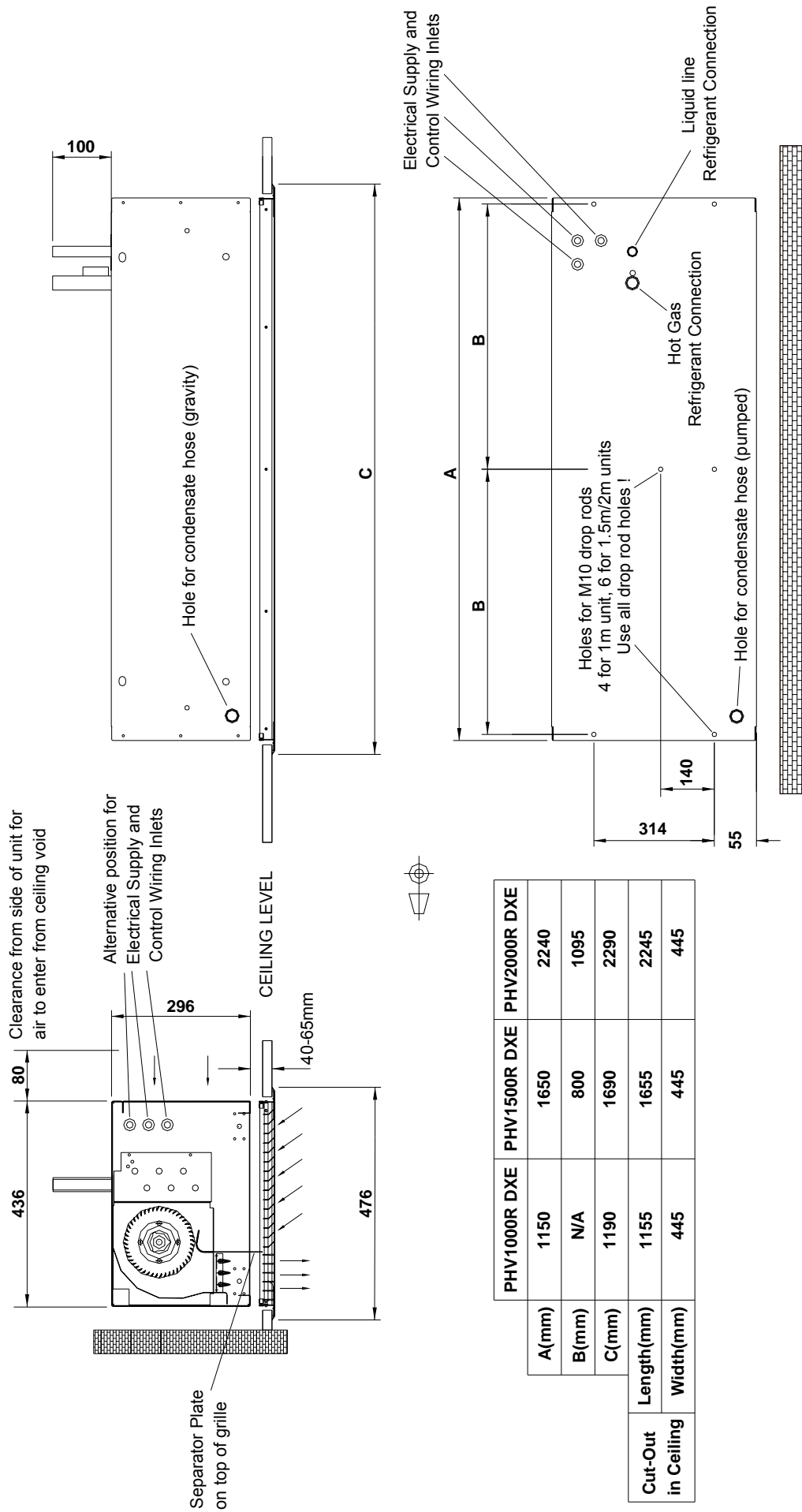

	PHV1000R DXE	PHV1500R DXE	PHV2000R DXE
A(mm)	1150	1650	2240
B(mm)	N/A	800	1095
C(mm)	1190	1690	2290
Length(mm)	1155	1655	2245
Width(mm)	445	445	445

**FIGURE 1 – DIMENSIONS OF PHVR HEAT PUMP AIR CURTAIN**

### ■ Fitting the Recessed Grille

The grille consists of a frame, grille core with filter attached to the grille core and four fixing brackets.

Fix the four fixing brackets to the grille frame using an M4 screw to fit each fixing bracket. Note which fixing brackets go where (see photo), there are two shapes.

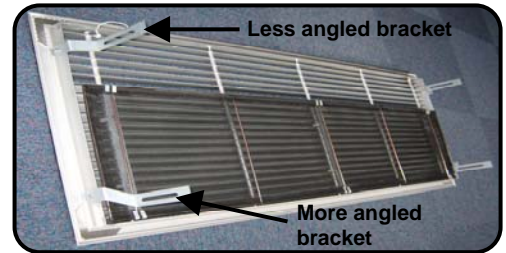

Remove the grille core from the grille frame by unfastening the two conical bolts fitted at each end of the grille core using an 8mm spanner.



Then push the grille sideways against the spring loaded pins and the grille core with filter now comes clear of its frame.

*Note: The grille core with filter attached will still be attached to the frame via safety cords.*



Locate the four M6 bolts that will hold the grille fixing brackets to the air curtain (two inside each end of the unit) and remove these M6 bolts. Lift the frame into position so the air discharge section of the grille will align with the air discharge vanes from the air curtain (see Figure 1 and photos on Page 7). Screw an M6 bolt through the slot in each grille fixing bracket until all four are located in place. Adjust the height of the grille frame (via the slots in the fixing brackets) so the frame fits neatly against the cut-out in the ceiling. Tighten each M6 bolt in place locking the grille frame in the correct position up against the underside of the finished ceiling.

The grille core will now be hanging down on its safety cords exposing all the components up inside the air curtain. Within the air curtain there are sliding separator plates, two on the PHV2000 and one on the PHV1500. These need to be adjusted up or down to stop the discharge air re-circulating back into the air curtain. Release the M6 bolts at each end of the plate, extend the sliding plate down so it will just touch the topside of the grille along its whole length when the grille core is fitted and tighten the bolts (see Figure 1). It is necessary to temporarily fit the grille core to gauge the required height of the separator plate(s).



Re-fit the grille core by locating each spring loaded pin in its locating hole, push against the spring loaded pins so the fixed pins at the other side of the grille core locate in their fixing holes in the frame. Tighten and secure the conical bolts fitted at each end of the grille core to lock it in position.

*Note: Access for electrical connections and all servicing is by removing the grille core.*

Once work on the ceiling is finished remove the protective plastic film from the recessed grille frame.

## Refrigerant Pipework

***This must be carried out before connection of any electrical and controls cables and in accordance with the Instructions that come with the Mitsubishi Electric City Multi equipment. This work must only be undertaken by a Mitsubishi Electric approved Contractor.***

Refrigerant installation pipework sizes need to be as follows :-

Air Curtain	Discharge Line (Gas)	Liquid Line	Index Size
VRF PHV1000R DXE HO	5/8 in.	3/8 in.	P100
VRF PHV1500R DXE LO	5/8 in.	3/8 in.	P125
VRF PHV1500R DXE HO	5/8 in.	3/8 in.	P140
VRF PHV2000R DXE LO	5/8 in.	3/8 in.	P140
VRF PHV2000R DXE HO	3/4 in.	3/8 in.	P200

NOTE: Contact Mitsubishi Electric for recommended pipework lengths, numbers of fittings etc. The installation must be done in accordance with the Mitsubishi Electric Service Manual.

It is intended that refrigerant pipe connections to the air curtain are made using brazed joints and these must be carried out in a professional and safe manner. If installation pipe sizes for the discharge (gas) line and liquid line are different from the pipe connection sizes on the air curtain, suitable pipe reducers must be used for the connection. R410A refrigerant systems can operate at pressures up to 610 psi (c. 42 Bar). These brazed joints may well be located in a public area and a weakness leading to an explosion could be extremely dangerous. The air curtain with its coil is manufactured in accordance with the Pressure Equipment Directive and the installation must be carried out to a good standard of workmanship. Use a heat sink on the copper pipes when brazing to reduce the transfer of heat to the inside of the air curtain where sensitive components are located. Make sure the thermistor (gas) sensor has not been inserted into its pocket on the gas pipe at the top of the air curtain before brazing. Remove it if it has or it will burn when the pipe connection is brazed.

For the City Multi system the LEV needs to be brazed into the liquid line as close as possible to the air curtain (2m maximum). The picture shows an example of this. On the VRF PHV2000R DXE HO there are two LEVs to be fitted in parallel (see Mitsubishi Electric AHU Controller instructions). The LEV(s) should be located in the ceiling void in an accessible position.



For the City Multi VRF R2 and WR2 Series system, pipework from each air curtain must connect to one pair of ports on the Mitsubishi Electric BC Controller. The exception to this is the VRF PHV2000R DXE HO air curtain that requires 2 pairs of ports on the BC Controller to achieve the correct output. Do not combine pipework from two or more air curtains together into one set of pipework and then connect this to one pair of ports.

**NB:** A maximum P140 Index is possible from 1 pair of ports, contact Mitsubishi Electric.

## ■ To gain access inside the Air Curtain

To gain access for connection of the electrical supply, controls wiring and to work on the unit during commissioning, remove the air inlet grilles and the bottom access panel.

Remove the grille core from the grille frame by unfastening the two conical bolts fitted at each end of the grille core using an 8mm spanner.



Then push the grille sideways against the spring loaded pins on one side and the grille core with filter now comes clear of its frame.

*Note: The grille core with filter attached will still be attached to the frame via safety cords and will hang down on the cords.*



## ■ Electrical Supply to the Air Curtain

***This must be carried out AFTER the connection of the refrigerant pipework. All electrical wiring and connections MUST be carried out by a competent qualified electrician in accordance with the latest edition of the IEE wiring regulations and/or local statutory regulations. (see also Wiring Diagrams on Pages 16 and 17)***

- A local isolator having a contact separation of at least 3mm on all poles must be fitted in the electrical supply to the air curtain and located in an accessible position adjacent to the unit. 3 phase if defrost electric heaters are required. 1 phase if defrost electric heaters are not required.
- The appliance must be connected using cables having an appropriate temperature rating (heat resistant).
- Ensure that the supply cables, circuit breakers and other electrical installation equipment are correctly sized for the air curtain being installed. See Table below.
- A 20mm size cable gland or conduit connector should be used for the Electrical Supply into the air curtain.
- This appliance must be Earthed.

Air Curtain	400V/3ph/50Hz if defrost electric heaters are required		230V/1ph/50Hz if defrost electric heaters are not used	
	Rated Electrical Power Input (kW)	Rated Current per phase (A)	Rated Electrical Power Input (kW)	Rated Current (A)
VRF PHV1000R DXE HO	4.8	7.8	0.3	1.3
VRF PHV1500R DXE LO	7.8	12.7	0.35	1.8
VRF PHV1500R DXE HO	7.8	12.7	0.35	1.8
VRF PHV2000R DXE LO	9.5	15.7	0.5	2.7
VRF PHV2000R DXE HO	9.5	15.7	0.5	2.7

If the defrost electric heaters are not to be used they can be disabled by disconnecting the neutral to the contactor coil inside the air curtain (see below and wiring diagrams on Pages 16 & 17).

**Note:** If the defrost electric heaters are disconnected, discharge air temperatures could be very cold, approximately 6°C. Defrost times could also be extended, particularly with the R2-Series System. \*

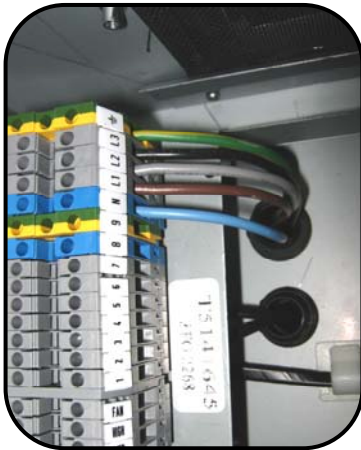

The photo above shows the completed wiring to terminals L1, L2, L3, N and  $\perp$  (Earth) for a 3 phase electrical supply (400v/3ph/50Hz) if defrost electric heaters are used



The photo above shows the completed wiring to terminals L1, N and  $\perp$  (Earth) for a single phase electrical supply (230v/1ph/50Hz) if defrost electric heaters are not used

Do not use cable size of more than 2.5mm<sup>2</sup> or connection will be difficult.

See also wiring diagram on page 16 or page 17.

If the defrost electric heaters are to be disabled this can be done by disconnecting the purple (neutral) wire from terminal A2 on the contactor inside the air curtain. The disconnected purple wire should be terminated safely into unused auxiliary terminal 14NO as shown in the adjacent picture, or into a suitable terminal block.

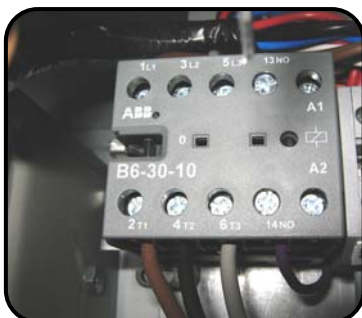

**\*NB.** Defrost does not occur with WY and WR2 systems so the defrost cycle electric heaters should always be disconnected on these systems.









## ■ Wiring to PAC-AH...AHU Controller and Controls Wiring

The Mitsubishi Electric PAC-AH...AHU Controller needs to be located within 7m from the air curtain (cables are 8m long). It would normally be placed lying flat within the ceiling void but it could be fixed to a wall using the four mounting feet. It must be accessible for future service work if necessary. It comes pre-wired with various 8m long cables for power supplies, thermistor sensors, LEV(s), alarms, etc. which have to be connected to the air curtain. Each of the pre-wired cables has a label attached to it at the end of the cable showing where it has to be connected at the air curtain. The following table lists the connections to be made between the PAC-AH...AHU Controller and the Air Curtain. Please note, there are two types of AHU Controller, PAC-AH...**M-G** and PAC-AH...**M-H**, and wiring of some cables and components is different for each type. This is indicated in the table below. See also wiring diagram on Page 16 for PAC-AH...**M-G**, and Page 17 for PAC-AH...**M-H**.



Controller Type	Termination at PAC-AH...	Cable / Component	Termination at Air Curtain
M-G and M-H	8m 3-core cable pre-wired to terminals E N L POWER SUPPLY	Electrical power supply from air curtain to PAC-AH... – 230v ac	wire to terminals 7 8 9
M-G and M-H	8m 2-core cable pre-wired to terminals D1 D2 OPERATION SIGNAL	Operation signal from PAC-AH... to start Air Curtain – 230v ac	wire to terminals 1 & 2
M-G and M-H	8m 2-core cable pre-plugged into CN52 on PAC-AH... pcb	Defrost signal from PAC-AH... to operate contactor in air curtain for defrost electric heaters if used	wire to terminals 5 & 6
M-G and M-H	8m 2-core cable pre-wired to terminals T21 T22 THERMISTOR (GAS)	Thermistor (Gas) temperature sensor – identified Black 	Fit sensor bulb into Hot Gas pocket on refrigerant gas pipe at top of air curtain <u>after</u> brazing pipe connections
M-G and M-H	wire to terminals T11 T12 THERMISTOR (LIQUID)	Thermistor (Liquid) temperature sensor – identified White	8m 2-core cable with sensor bulb factory fitted within air curtain
M-G only	wire to terminals T1 & T2 THERMISTOR (INLET AIR)	Thermistor (Return Air) temperature sensor – identified Red	8m 2-core cable with sensor bulb factory fitted within air curtain
M-H only	wire to terminals T1 & T2 THERMISTOR (OUTLET AIR)	Thermistor (Return Air) temperature sensor – identified Red	8m 2-core cable with sensor bulb factory fitted within air curtain
M-H only	Terminals T31 T32	<b>5.6kΩ</b> resistor factory fitted	Not Applicable
M-G and M-H	8m 6-core cable pre-wired to 6-way colour coded LEV terminals	Linear Expansion Valve(s) - LEV(s) 	Install in liquid line near to air curtain
M-G and M-H	8m 2-core cable pre-plugged into CN31 on PAC-AH... pcb	Condensate alarm from condensate pump alarm system, open circuit = alarm and stops unit	Connect to condensate pump alarm terminals which <u>must</u> be volt free, open cct = alarm

### ■ Remote 3-Speed Fan Switch

A remote 3-speed fan switch is supplied with the air curtain so the end user can remotely select High, Medium or Low fan speeds to suit the local conditions. The 3-Speed Fan Switch should be mounted on a wall with the Mitsubishi Electric PAR-21MAA Remote Controller, if used, so the end user will then have On/Off, temperature control and fan speed control all from one location. The 3-speed fan switch is wired to terminals FAN, HIGH, MED and LOW in the Air Curtain using 230v mains rated, 4 core double insulated cable of size 0.75mm<sup>2</sup>.



If the remote 3-Speed fan switch is not to be used, a permanent wire link must be fitted across the fan terminals in the air curtain or the fans will not operate when the system is started. This will result in an error message from the compressor unit after a time. The picture opposite shows a wire link fitted across terminals FAN and MED and the air curtain would operate at Medium Fan Speed whenever the heat pump system is switched on.



**Note:** Fan speed selection using the PAR-21MAA Remote Controller is not available. The fan speed control logic within the PAC-AH...AHU Controller is not suitable for the operation of an air curtain and so is not used.

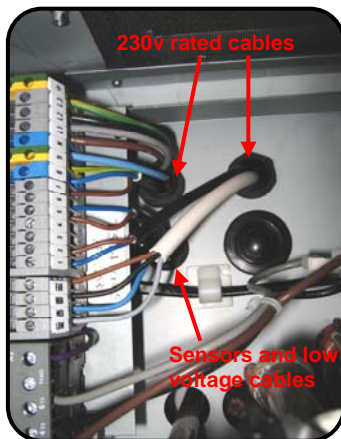

The finished wiring to the air curtain will be as shown in the photo adjacent (wiring is shown with a 3-phase electrical supply for enabled defrost heaters).

Note the use of 20mm conduit with thermistor sensors and low voltage cables routed in a separate conduit to that used for mains rated cables.

### ■ PAR-21MAA Remote Controller

If the air curtain is to be manually controlled by the end user a Mitsubishi Electric PAR-21MAA remote controller (not supplied by Thermoscreens) must be supplied and fitted by the installer. This is wired to the PAC-AH...AHU Controller using 2-core cable. Refer to the Mitsubishi Electric instructions that come with the PAR-21MAA remote controller for installation and wiring of the controller.

A PAR-21MAA Remote Controller is also required for commissioning purposes and if using AUTO mode with a BMS System or Centralised Controller.



### ■ M-NET Communications Cable

The M-NET communications cable is wired to the PAC-AH...AHU Controller in accordance with Mitsubishi Electric instructions. Avoid isolators in the communications cables as this can lead to transmission problems.

## ■ Condensate Disposal System

If it is intended to use the air curtain in cooling mode a condensate disposal system is required.

The air curtain is supplied with a 1m length of 12mm bore plastic hose ready fitted to the outlet spout of the drain tray. The plastic hose can be found curled up inside the air curtain at the right hand side of the unit. There are two condensate outlet holes in the casing, one at the top of the unit and a lower one at the rear, both fitted with rubber plugs. The photo shows the plastic hose going through the lower rear condensate outlet hole.



It is possible to gravity drain condensate from these recessed air curtains via the lower condensate outlet hole at the rear of the unit, which is c.40mm minimum above the top surface of the ceiling within the ceiling void (see Figure 1). Means of condensate disposal must then be provided within the ceiling void. The plastic hose should be pushed through this lower hole at the rear after removing the plug and connected to the condensate disposal system within the ceiling void.

Alternatively, a suitable condensate pump (not supplied by Thermoscreens) can be supplied and fitted by the installer to remove condensate directly from the unit. The condensate pump must be of sufficient capacity and if located above the drain tray; self priming and capable of providing the appropriate suction head so the pump will lift condensate out from the top of the air curtain. Suitable condensate pumps with a suction head are Peristaltic or Rotary Diaphragm type. We recommend the Blue Diamond rotary diaphragm type with cooling signal sensor (drainStik) manufactured by Charles Austen Pumps Ltd. ([www.miniblue.co.uk](http://www.miniblue.co.uk)).

Air Curtain	Maximum likely Condensate flow rate (litres/hour)
VRF PHV1000R DXE HO	6.0
VRF PHV1500R DXE LO	7.0
VRF PHV1500R DXE HO	10.0
VRF PHV2000R DXE LO	11.0
VRF PHV2000R DXE HO	14.0

It is recommended that the condensate pump has the facility so it only operates when the air curtain is in cooling mode by detection of water in the drain tray or by detecting a cooling differential in the airflow. It should also have a pump overrun to empty the drain tray as much as possible when the air curtain is switched off. The plastic hose should be pushed through either of the two condensate outlet holes after removing the plug and connected to the condensate pump using the adapter supplied with the pump. It may be necessary to extend the hose if the pump is remotely located.

Whether a gravity drain system is used to remove the condensate, or a condensate pump, there should be an alarm system with appropriate sensor fitted in the drain tray that will give a volt-free signal (open circuit = alarm). This will stop the air curtain cooling if the condensate drain is in danger of flooding, bringing up error code 2502 or 2503, and the air

curtain fans will continue to operate. Other indoor units on the same City Multi system are unaffected if the air curtain condensate alarm occurs. There is a plastic fixing bracket with 8mm diameter hole attached to the drain tray inside the air curtain so a condensate sensor can be fixed in the tray by the installer. Remove the drain tray at one end to gain access to the plastic fixing bracket. Enlarge the hole if necessary to suit the type of sensor used so it is located in the tray at the appropriate position. If a condensate pump is being used, see the manufacturers instructions that come with the pump for further information.



The 230v AC, single phase electrical supply to operate a condensate pump should come from the air curtain (see wiring diagram). For a condensate pump with cooling mode start and pump overrun, as recommended above, use Terminals:- 7 (Permanent Live), 8 (Neutral), 9 (Earth) which provides a permanent 5A fused supply. Terminal 1 (Switched Live) can be used if a Switched Live is required. This will energise when the air curtain is operating (Heat, Fan or Cool) and de-energise when it is switched off. This is also a 5A fused supply.

#### ■ **Optional Fan Speed Controller**

An optional fan speed controller is available to provide a greater range to the three fan speeds in the air curtain. Three fan speeds are still used but the speeds can be reduced to lower levels than the standard fan motor offers. The controller is useful if noise levels are an issue on site as the fan speeds can be reduced accordingly. The controller can be fitted to the air curtain retrospectively. It does not fit inside the air curtain but comes with 2m cables so it can be hidden remotely from the unit or even inside one of the optional sheet metal covers. Separate instructions come with the fan speed controller showing how it is connected to the air curtain and commissioned.



## COMMISSIONING THE HEAT PUMP AIR CURTAIN

Ensure that the electrical supply to the Air Curtain is switched off before starting any commissioning work.

### ■ Air Curtain Checks

Check that the components inside the air curtain are as shown in the picture below. Check that the thermal overheat cut-out switch has not 'tripped'. Push down on the red button on the top of the thermal overheat switch - if it has tripped it will click back on.

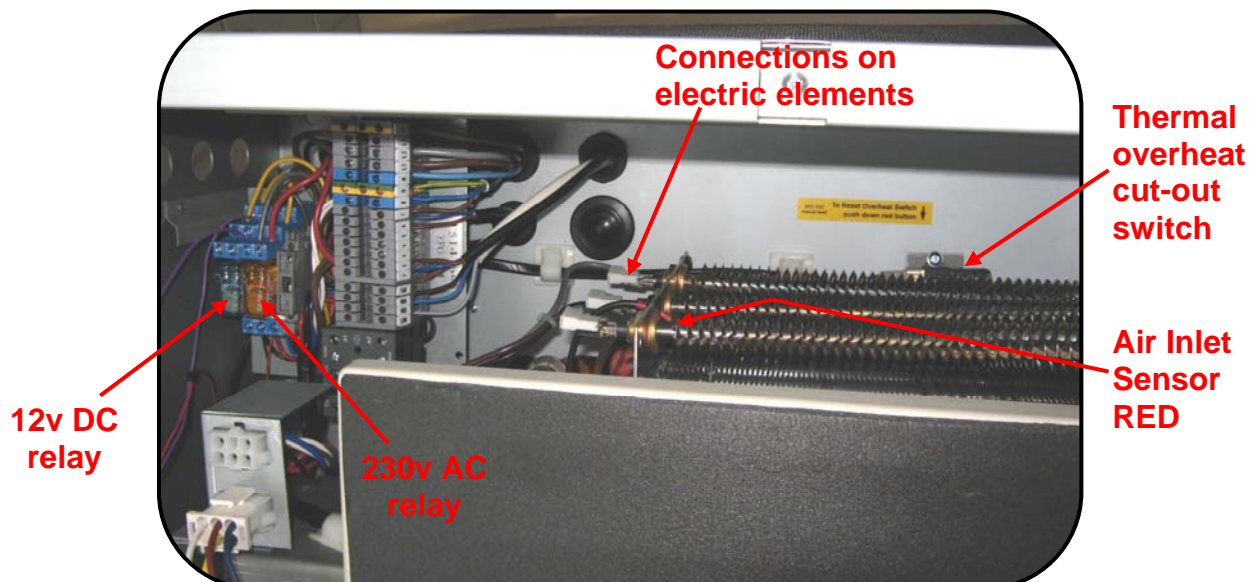

Set the inner aluminium vanes within the air curtain air discharge so they point straight downwards over the doorway.

A PAR-21MAA Remote Controller should be connected and used to carry out commissioning even if the air curtain is to operate under the control of a BMS System or Centralised Controller. Disconnect the remote control plug from inside the PAC-AH...AHU Controller to use the remote controller. Plug it back in again if a BMS/Centralised Controller is to be used and the PAR-21MAA is disconnected after commissioning.

**NB.** If the air curtain is used in AUTO mode under the control of a BMS System or Centralised Controller it is necessary to also have a PAR-21MAA Remote Controller connected.



### ■ Mitsubishi Electric Compressor Unit

For Y-Series systems ensure that the appropriate dip switch has been set in the compressor unit so that the PAR-21MAA Remote Controller will operate in AUTO mode and to enable Auto Re-Start after power failure if required.

PUMY-P model:- SW2-5 ON for AUTO mode

PUHY-P YHM and PQHY-P YHM model:- SW4-5 ON for AUTO mode

SW1-9 and SW1-10 on for Auto Re-Start after power failure.

## ■ Mitsubishi Electric PAC AH...AHU Controller

Remove the access covers of the PAC-AH...AHU Controller and check that the dip switch settings are correct for the controller. These need to be set as follows:

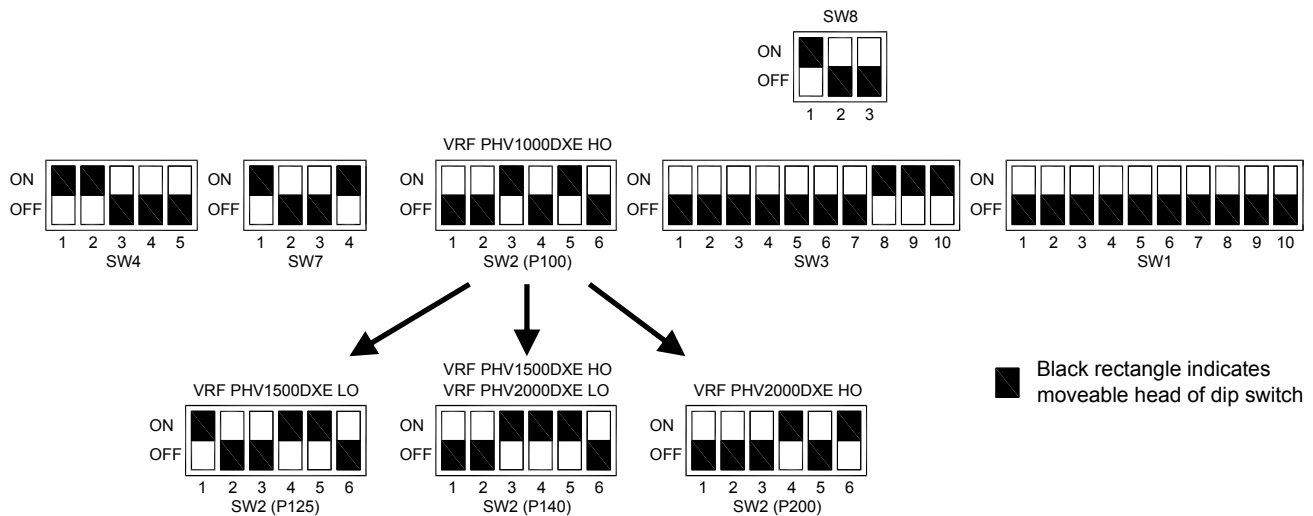

These settings are the same for PAC-AH...M-G and PAC-AH...M-H AHU Controllers.

## ■ Starting the System

Carry out a final inspection to ensure that all wiring is in accordance with the wiring diagram on Page 16 for a PAC-AH...M-G or Page 17 for a PAC-AH...M-H and that all connections have been properly made. Ensure that the refrigerant system is complete, there are no leaks and there is sufficient charge of refrigerant R410A. Switch on the electrical supply to the compressor unit and other City Multi system components. Wait 30 seconds and switch on the electrical supply to the air curtain at the local isolator. The system will boot-up and when the screen on the PAR-21MAA Remote Controller becomes active it will repeat the message "PLEASE WAIT". After several minutes when the PLEASE WAIT message has stopped the system is ready to start.

**DANGER:** Beware of Fans Starting! Turn the air curtain on using the ON/OFF Button on the PAR-21MAA Remote Controller and the air curtain fans will start straight away. Switch the Mode Button on the PAR-21MAA to heating mode and adjust the target temperature to 28°C maximum setting using the ▲TEMP Button. If the 3-Speed fan switch is installed check that the fans run at Low speed, Medium speed and High speed by operating the slider switch. Check there is no mechanical noise coming from the fans at each of the three fan speeds and that all fans are working. If the 3-Speed fan switch is not to be installed a wire link will have been fitted to the fan speed terminals on the air curtain. Set the wire link to one of the three fan speeds (LOW, MED or HIGH) appropriate to the site conditions (see also Page 19).

## ■ Check Heating and Cooling Performance

In heating mode check that the air stream from the discharge grille warms up across the whole length of the air curtain after approximately 20 minutes of operation and that the air stream reaches right down across the doorway with the door open or closed. If necessary the inner aluminium vanes in the air curtain air discharge can be angled either inwards or outwards if this gives better penetration/warming of any incoming draughts. The fan speed can also be adjusted (High, Medium or Low) to suit the

conditions. If an optional fan speed controller has been installed it may be necessary to re-set the voltage tappings on the transformers inside the fan speed controller to achieve a compromise between airstream performance and noise levels. This is explained in the instructions that come with the optional fan speed controller.

If it is intended that the air curtain is to ever operate in cooling mode switch the Mode Button on the PAR-21MAA remote controller to 'COOL' and adjust the target temperature to 14°C minimum setting using the ▼TEMP Button. Wait for the air curtain air stream to go cold. Check the inside of the drain tray is clean, there is no debris in the outlet spout, there are no kinks in condensate hoses, the condensate pump (if fitted) will operate or the gravity condensate drain (if used) is functional. It is unlikely that condensate will fill the drain tray straight away so it will be necessary to fill the tray manually with water to see if the condensate removal system is working satisfactorily. If an alarm sensor is fitted in the drain tray, check it operates to stop the air curtain cooling if the drain tray becomes too full. Test the air curtain for a time in cooling mode with the recessed grille core fitted and if environmental conditions permit check that condensate is being collected and disposed of, or pumped away by the condensate pump. No condensate should leak out of the air curtain. At the end of the cooling test remove the recessed grille core and check that the inside of the air curtain has remained dry and that all condensate was collected by the removal system.

To conserve energy and carbon resources it is recommended to set up the BMS System, Centralised Controller or PAR-21MAA Remote Controller so it can operate in AUTO Mode at a target temperature of 24°C. This is the normal mode of operation for the heat pump air curtain and it should run in this set-up with no further adjustments, automatically heating or cooling as required. If the end user is to operate the air curtain with a PAR-21MAA Remote Controller set up the No.1 locking function on the controller so they can only switch the air curtain ON or OFF, with no control of mode or target temperatures. See user instructions for the Mitsubishi Electric PAR-21MAA Remote Controller.

**BEWARE:** It is possible for the air curtain to go into cooling mode on a warm day if the BMS System, Centralised Controller or PAR-21MAA Remote Controller is set in AUTO mode as described above. A condensate disposal system must therefore be fitted if the air curtain is set in AUTO mode.

If it is intended that the air curtain should only operate in heating mode, never in cooling mode, the PAR-21MAA Remote Controller must be set to HEAT mode with an appropriate heating target temperature (say 24°C) and locked so only the ON/OFF function on the Remote Controller works. If it is to be operated from a BMS System or Centralised Controller this should be configured such that the air curtain can only operate in HEAT or FAN mode, never in AUTO or COOL mode. It is important this is done at commissioning if the air curtain is not to operate in cooling mode and is not fitted with a condensate disposal system.



## Filter Dirty Indicator

The air curtain is fitted with a Filter Dirty Indicator. It is located at the left-hand end of the air discharge grille and signals when the air curtain inlet grille filters should be vacuum cleaned or the air curtain requires servicing.

**NB.** The filter dirty indicator on the PAR-21MAA Remote Controller does not function wired to a PAC-AH...AHU Controller.





The indicator states are outlined below:

Indicator State	Indicator Light	Action Required	Reset Button
GREEN FLASH	On 0.5s; Off 3s	None	N/A
RED ON	On permanently	Vacuum inlet	Quick reset
RED FLASH	On 0.5s; Off 0.5s	Service filters	Press for 5s

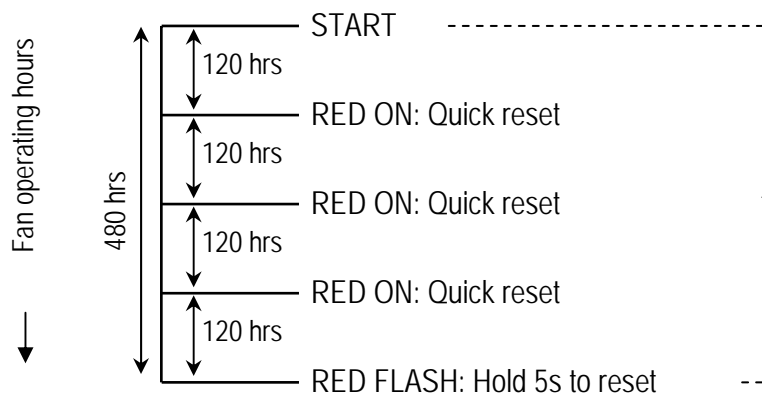
The filter indicator schedule is based on fan operating hours. For the default schedule, shown schematically below, the inlet grille filter should be vacuum cleaned every 120hrs of fan operation (every 1 to 2 weeks) and a full filter service should take place every 480hrs of fan operation.

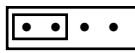

The factory set default schedule is suitable for most applications. However, the actual frequency of cleaning required will depend on the environment. Two alternative indicator schedules are available, and can be selected by changing the 'jumper' position (marked 1, 2 or 3) on the Filter Indicator pcb.

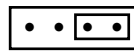
Filter Indicator Schedule	Double-frequency	Default	Half-frequency
Jumper position	 1 2 3	 1 2 3	 1 2 3
Inlet grille vacuum interval	60 hrs	120 hrs	240 hrs
Filter service interval	240 hrs	480 hrs	960 hrs

To access the Filter Indicator pcb to change jumper:-

Switch off the electrical power to the Heat Pump Air Curtain. Remove the recessed grille core from the air curtain (see To gain access inside the Air Curtain, Page 14). Unfasten the two screws as indicated.



The Filter Indicator is now accessible to change the jumper.

Once the filter indicator pcb 'jumper' has been re-positioned, re-fit the filter indicator and replace the recessed grille core.

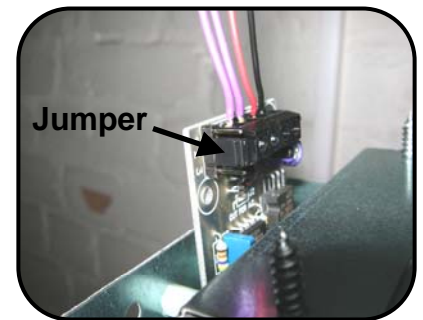

### ■ Hand-over to End-User

Before leaving site it is important that there is a 'Hand-Over Meeting' to hand-over the heat pump system and air curtain installation to the end user or their representative. This should include a full and clear explanation of how the system operates. Be sure to explain the Filter Indicator Schedule, that the air inlet grille must be regularly vacuum cleaned and the unit serviced at regular intervals.

If the air curtain is to be operated under manual control, it is important that the end user understands how the Mitsubishi Electric PAR-21MAA Remote Controller and 3-Speed Fan Switch operate. That the PAR-21MAA Remote Controller has been locked so only the ON/Off button functions and the air curtain operates in AUTO mode with a fixed target temperature of 24°C. If a condensate disposal system has not been fitted it is vital they understand that the air curtain must not be run in COOL or AUTO mode and that the PAR-21MAA Remote Controller has been locked so only the ON/Off button functions and the air curtain operates only in HEAT mode with a fixed target temperature of 24°C.

If the air curtain is to be operated under the control of a BMS System or Centralised Controller, explain all the settings and demonstrate the operation of the system. If a condensate disposal system has not been fitted it is vital they understand that the air curtain must not be run in COOL or AUTO mode, that it must only be operated in HEAT or FAN mode.

If a condensate disposal system has been fitted and they are going to run the air curtain in COOL mode (not just AUTO mode) explain that the target temperature should be adjusted to a comfortable level of cooling, not necessarily to the lowest target temperature possible as this uses a lot more energy and carbon resources.

Ensure that all instructions and manuals are handed to the end user or their representative.

# USER INSTRUCTIONS FOR THE AIR CURTAIN

For manual control using a PAR-21MAA Remote Controller

## To Switch On and Off:

Turn the air curtain on by pressing the ON/OFF Button on the PAR-21MAA Remote Controller and the air curtain fans will start within a few seconds. If a 3-Speed Fan Switch is fitted adjust the fan speed to suit using the slider switch. As set up by the Commissioning Engineer the air curtain will operate in AUTO mode, automatically heating or cooling as required, with a target temperature of 24°C - all other buttons on the Remote Controller are locked out.

**NB.** The air curtain may produce condensate during hot weather so a condensate disposal system must be fitted!



PAR-21MAA  
Remote Controller

3-Speed  
Fan Switch

Turn the air curtain off by pressing the ON/OFF Button on the PAR-21MAA Remote Controller and the air curtain fans will stop.

***If the PAR-21MAA Remote Controller is not locked the following functions operate:-***

### **HEAT Mode:**

Press the Mode Button on the Remote Controller until HEAT appears on the display. Adjust the target temperature using the ▲ or ▼ TEMP Button between 22°C and 28°C maximum. Allow time for the air stream to heat up.

### **AUTO Mode (only if a condensate disposal system is fitted!!):**

Press the Mode Button on the Remote Controller until AUTO appears on the display. Adjust the target temperature using the ▲ or ▼ TEMP Button to 24°C. This is the normal mode of operation for the heat pump air curtain and it should run in this set-up with no further adjustments, automatically heating or cooling as required.

### **FAN Mode (Fan only - no heating or cooling):**

Press the Mode Button on the Remote Controller until FAN appears on the display.

### **COOL Mode (only if a condensate disposal system is fitted!!):**

Press the Mode Button on the Remote Controller until COOL appears on the display. Adjust the target temperature using the ▲ or ▼ TEMP Button between 20°C and 14°C minimum. Allow time for the air stream to chill. Do not necessarily use the lowest target temperature possible as this uses a lot more energy and carbon resources.

The temperature of the air returning to the air curtain is constantly displayed on screen.

## SERVICING THE HEAT PUMP AIR CURTAIN

### ■ Vacuum Clean the Air Inlet Grilles / Filters (Weekly, or when the Filter Dirty Indicator shows PERMANENT RED)

With the air curtain switched OFF, a vacuum cleaner with an extension tube and brush attachment at its end should be used to clean the face of the air inlet grille and the filter. This is important to minimise the build-up of dust and lint on the air filter which will affect the performance of the air curtain. This is a simple service task that can be carried out by the Cleaner or Janitor on a weekly basis from floor level without having to access the air curtain at high level. This should be done weekly as a regular service task and/or when the Filter Dirty Indicator shows permanent red. Reset the Filter Dirty Indicator after cleaning by a quick press of the Reset Button (even if the indicator has not gone red).



### ■ Servicing the Air Curtain (suggest every 3 Months, or if the Filter Dirty Indicator shows FLASHING RED)

**Always disconnect and isolate the mains electricity supply both at the local electrical supply to the Air Curtain and to other Mitsubishi Electric equipment in the City Multi system before servicing, maintaining or repairing the Air Curtain.**

Note: All servicing, maintenance and repairs to the air curtain must be carried out by an approved Service Agent.



Towards the rear of the recessed grille (nearest the doorway), and at either end of the grille, there are two conical bolts that prevent the grille being removed without the use of tools.

Loosen these two conical bolts using an 8mm spanner.

Then push the grille backwards (towards the doorway) against spring loaded pins on one side and the grille core with filter now comes clear of its frame.

*Note: The grille core with filter attached will still be tethered to the frame via safety cords and will hang down on these cords.*



The grille filter can now be unclipped from the grille and brushed and vacuum cleaned.

Looking up at the front edge of the unit there are 2 or 3 screws inset into the frame (see photo). Loosen each of these screws by 2 turns.

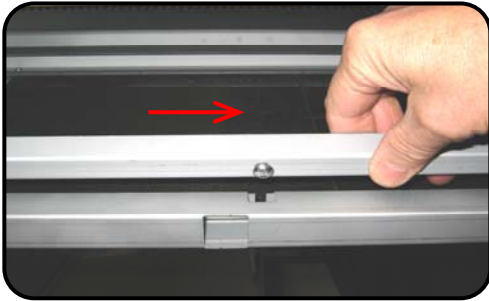
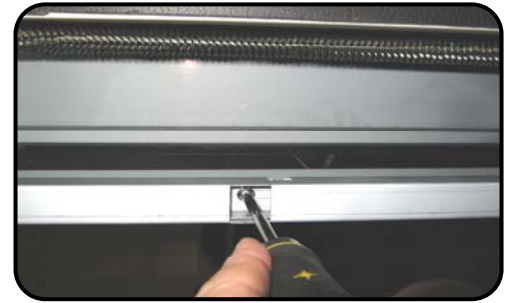

Reach up and pull the metal retaining strip over to one side and remove the retaining strip.



Pull the void filter outwards at the bottom and then remove from the air curtain. It can then be brushed and vacuum cleaned.

Refit the filters opposite to removal. The filters are very durable but may need to be replaced after a number of service intervals.

Vacuum clean and remove any build-up of dust, dirt and debris within the air-curtain, especially on the face of the coil and the electric heating elements.

*Note: Fan motors are permanently lubricated and require no additional lubrication.*

#### **If the Air Curtain has been used in Cooling:-**



Loosen by 4 turns, the rear row of drain tray fixing screws along the whole length of the tray. Do not remove these screws completely.



Remove the front row of drain tray fixing screws along the whole length of the drain tray. Keep the screws.

The drain tray now angles down along its front edge and the inside surface of the tray can be easily cleaned. Remove all debris from the drain tray, outlet spout and condensate hose.



Check there are no kinks in condensate hoses. If a peristaltic condensate pump is fitted change the rubber pump head tube. Refit drain tray opposite to removal.

Once the air curtain has been cleaned, visually inspect the air curtain components. Ensure pipe sensors are located in their pockets and any foam insulation covering these pockets is un-damaged. Check the location of the thermal overheat cut-out and air sensor and that the thermal overheat cut-out switch has not tripped (see Section - Commissioning). Check all electrical connections and terminals within the unit are tight and that crimp connections have not become loose.

After all the components have been re-fitted switch on the electrical supplies and fully function test the air curtain to ensure correct operation (see Section - Commissioning). Check the condensate pump operates, if fitted.

Reset the Filter Dirty Indicator after the service by pressing the Reset Button for at least 5 seconds (even if the indicator has not gone flashing red).and hand back the unit to the end user.

## ■ Fault Conditions

If the Thermoscreens Heat Pump Air Curtain System does not operate as expected refer to the fault finding table below:

Symptom	Possible Cause	Action Required
Air curtain fans do not operate	Electrical power is not switched on to the Mitsubishi Electric City Multi system <u>and</u> at the local electrical isolator next to the Thermoscreens Air Curtain	Switch on power to all components in the heat pump system and wait 30 seconds
	Air curtain is not switched On	Switch on air curtain using the PAR-21MAA Remote Controller, BMS System or Centralised Controller
	Air Curtain fans are not wired to operate with either a 3-Speed Fan Switch or a wire link on fan terminals in air curtain	Wire in 3-Speed Fan Switch or wire link – see wiring diagram
	Problem with air curtain fan motor(s), or internal wiring, or controls	Use wiring diagram to investigate possible cause of fault
Air curtain discharge air stream is not heating or cooling when required	Air curtain has been running for less than 20 minutes and is still warming up or cooling down	Give system sufficient time to reach operating condition
	Air curtain is set to Fan-Only on PAR-21MAA Remote Controller, BMS System or Centralised Controller	Check schedule on Controller and amend if necessary
	Target temperature is set incorrectly, i.e. too low for heating or too high for cooling	Adjust the target temperature on the BMS System, Centralised Controller or PAR-21MAA Remote Controller
	The operating mode is set incorrectly, i.e. set on COOL when heating is required	Select the correct mode for the conditions on the BMS System, Centralised Controller or the PAR-21MAA Remote Controller
	Condensate Alarm circuit is open circuit and air curtain will not COOL	Rectify alarm circuit which must be closed circuit for air curtain to operate in cooling
	Air Curtain filters and/or coil is dirty.	Service air curtain as described in Section - Servicing
Mitsubishi Electric system is indicating an error code	Error Code 2502 or 2503 indicating condensate alarm from condensate pump alarm system	Inspect air curtain condensate tray and condensate pump, service or repair if necessary
	A variety of error codes can occur because of a fault within the air curtain	Refer to Mitsubishi Electric Service Manual to understand fault, then inspect and repair air curtain if there is a fault

If the Heat Pump Air Curtain system is still not operating correctly call for a Mitsubishi Electric Service Agent.

## ■ Warranty

If any problems are encountered with the heat pump air curtain please contact your Mitsubishi Electric Service Agent.

Care has been taken in compiling these instructions to ensure they are correct, although Thermoscreens Ltd. disclaims all liability for damage resulting from any inaccuracies and/or deficiencies in this documentation. Thermoscreens Ltd. retain the right to change the specifications stated in these instructions.

Thermoscreens Ltd  
St. Mary's Road Nuneaton  
Warwickshire England  
CV11 5AU

Email: [sales@thermoscreens.com](mailto:sales@thermoscreens.com)

Tel: + 44 (0) 24 7638 4646

Fax: + 44 (0) 24 7638 8578

[www.thermoscreens.com](http://www.thermoscreens.com)



Thermoscreens Ltd  
St. Mary's Road  
Nuneaton  
Warwickshire  
CV11 5AU  
United Kingdom  
Telephone: +44 (0)24 7638 4646  
Fax: +44 (0)24 7638 8578



**thermoscreens®**

**EC DECLARATION OF CONFORMITY**

as defined by the EC Council Directive on Machinery 2006/42/EC, the Low Voltage Directive 73/23/EEC, the Electromagnetic Compatibility Directive 89/336/EEC and the Pressure Equipment Directive 97/23/EC

Herewith we declare that the air movement equipment designated below, on the basis of its design and construction in the form brought onto the market by us in accordance with the relevant safety, health and performance requirements of the Machinery.

If alterations are made to the machinery without prior consultations with us, this declaration becomes invalid.

**Designation of Equipment :** THERMOSCREENS AIR CURTAINS with CITY MULTI SYSTEM

**Series Type :** VRF PHV1000DXE HO, VRF PHV1000RDXE HO, VRF PHV1500DXE LO, VRF PHV1500RDXE LO, VRF PHV1500DXE HO, VRF PHV1500RDXE HO, VRF PHV2000DXE LO, VRF PHV2000RDXE LO, VRF PHV2000DXE HO, VRF PHV2000DXE HO

**Relevant EC Council** the Machinery Directive (2006/42/EC)  
the Low Voltage Directive (73/23/EEC as amended by 93/68/EEC)  
the Electromagnetic Compatibility Directive (89/336/EEC as amended by 91/31/EEC and 93/68/EEC)  
the Pressure Equipment Directive (97/23/EC)

**Applied Harmonised Standards :** Machinery - EN 292-1, EN 292-2, EN 294, EN 394, EN 414  
LVD - EN 60335-1, EN 60335-2-30, EN 60335-2-40  
EMC - EN55011, EN 61000-3-2, EN 61000-3-3, EN 61000-4-2, EN 61000-4-4, EN61000-4-5, EN61000-4-11, EN61000-6-4  
PED - EN 13134, EN 13133

**Basis of Self Attestation :** Quality Assurance to BS EN ISO 9001 : 2000  
B.S.I. Registered Firm Certificate Number FM 85224

**Responsible Person :** Mr. M. Francis, Managing Director, Thermoscreens Limited

**Date :** 17<sup>th</sup> June 2009

**Signed :**