

# Air-Conditioners For Building Application

## INDOOR UNIT

### PLFY-P·VCM-E

#### OPERATION MANUAL

**FOR USER**

For safe and correct use, please read this operation manual thoroughly before operating the air-conditioner unit.

#### BEDIENUNGSHANDBUCH

**FÜR BENUTZER**

Zum sicheren und einwandfreien Gebrauch der Klimaanlage dieses Bedienungshandbuch vor Inbetriebnahme gründlich durchlesen.

#### MANUEL D'UTILISATION

**POUR L'UTILISATEUR**

Pour une utilisation correcte sans risques, veuillez lire le manuel d'utilisation en entier avant de vous servir du climatiseur.

#### BEDIENINGSHANDLEIDING

**VOOR DE GEBRUIKER**

Voor een veilig en juist gebruik moet u deze bedieningshandleiding grondig doorlezen voordat u de airconditioner gebruikt.

#### MANUAL DE INSTRUCCIONES

**PARA EL USUARIO**

Lea este manual de instrucciones hasta el final antes de poner en marcha la unidad de aire acondicionado para garantizar un uso seguro y correcto.

#### ISTRUZIONI DI FUNZIONAMENTO

**PER L'UTENTE**

Leggere attentamente questi istruzioni di funzionamento prima di avviare l'unità, per un uso corretto e sicuro della stessa.

#### ΕΓΧΕΙΡΙΔΙΟ ΟΔΗΓΙΩΝ ΧΡΗΣΕΩΣ

**ΓΙΑ ΤΟΝ ΧΡΗΣΤΗ**

Για ασφάλεια και σωστή χρήση, παρακαλείστε διαβάσετε προσεκτικά αυτό το εγχειρίδιο χρήσεως πριν θέσετε σε λειτουργία τη μονάδα κλιματισμού.

#### MANUAL DE OPERAÇÃO

**PARA O UTILIZADOR**

Para segurança e utilização correctas, leia atentamente o manual de operação antes de pôr a funcionar a unidade de ar condicionado.

#### İşletme Elkitabı

**KULLANICI İÇİN**

Emniyetli ve doğru biçimde nasıl kullanılacağını öğrenmek için lütfen klima cihazını işletmeden önce bu elkitabını dikkatle okuyunuz.

#### РУКОВОДСТВО ПО ЭКСПЛУАТАЦИИ

**ДЛЯ ПОЛЬЗОВАТЕЛЯ**

Для обеспечения правильного и безопасного использования следует ознакомиться с инструкциями, указанными в данном руководстве по эксплуатации, тщательным образом до того, как приступить к использованию кондиционера.

#### 操作说明书

**用户适用 (安装人员适用)**

在操作空调机之前，请全面阅读本操作说明书，以便安全和正确地使用本机。

English

Deutsch

Français

Nederlands

Español

Italiano

Ελληνικά

Português

Türkçe

Русский

中文

# Contents

1. Safety Precautions .....	2
2. Operation .....	3
3. Care and cleaning .....	5
4. Troubleshooting .....	6
5. Specifications .....	6

## 1. Safety Precautions

- ▶ Before installing the unit, make sure you read all the “Safety precautions”.
- ▶ The “Safety precautions” provide very important points regarding safety. Make sure you follow them.
- ▶ This equipment may cause the adverse effect on the same supply system.
- ▶ Please report to or take consent by the supply authority before connection to the system.

### Symbols used in the text

#### ⚠ Warning:

Describes precautions that should be observed to prevent danger of injury or death to the user.

#### ⚠ Caution:

Describes precautions that should be observed to prevent damage to the unit.

### Symbols used in the illustrations

- ⊘ : Indicates an action that must be avoided.
- ❗ : Indicates that important instructions must be followed.
- ⚡ : Indicates a part which must be grounded.
- ⚠ : Indicates that caution should be taken with rotating parts.
- ⚡ : Indicates that the main switch must be turned off before servicing.
- ⚠ : Beware of electric shock.
- ⚠ : Beware of hot surface.
- ⚡ ELV : At servicing, please shut down the power supply for both of Indoor Unit and Outdoor Unit.

#### ⚠ Warning:

Carefully read the labels affixed to the main unit.

#### ⚠ Warning:

- The unit should not be installed by the user. Ask the dealer or an authorized company to install the unit. If the unit is installed improperly, water leakage, electric shock or fire may result.
- Do not stand on, or place any items on the unit.
- Do not splash water over the unit and do not touch the unit with wet hands. An electric shock may result.
- Do not spray combustible gas close to the unit. Fire may result.
- Do not place a gas heater or any other open-flame appliance where it will be exposed to the air discharged from the unit. Incomplete combustion may result.
- Do not remove the front panel or the fan guard from the outdoor unit when it is running.
- When you notice exceptionally abnormal noise or vibration, stop operation, turn off the power switch, and contact your dealer.
- Never insert fingers, sticks etc. into the intakes or outlets.
- If you detect odd smells, stop using the unit, turn off the power switch and consult your dealer. Otherwise, a breakdown, electric shock or fire may result.
- This air conditioner is NOT intended for use by children or infirm persons without supervision.
- Young children should be supervised to ensure that they do not play with the air conditioner.
- If the refrigeration gas blows out or leaks, stop the operation of the air conditioner, thoroughly ventilate the room, and contact your dealer.
- Never repair the unit or transfer it to another site by yourself.

#### ⚠ Caution:

- Do not use any sharp object to push the buttons, as this may damage the remote controller.
- Never block or cover the indoor or outdoor unit's intakes or outlets.
- Never wipe the remote controller with benzene, as this may damage the remote controller.

### Disposing of the unit

When you need to dispose of the unit, consult your dealer.

## 2. Operation

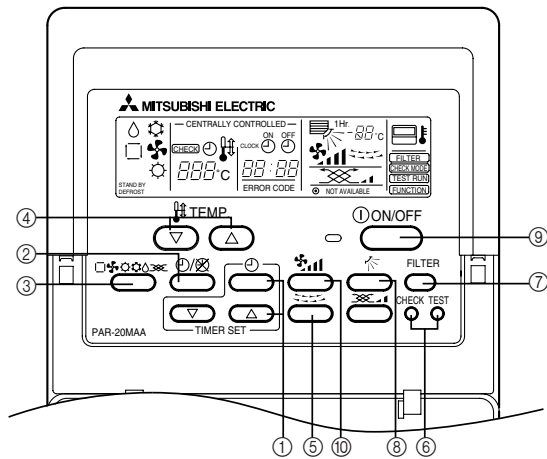

- ① [Time-setting] Button  
Used to set the current time, starting time, and ending time.
- ② [Timer/continuous] Button  
Used to switch between continuous operation and timer operation.
- ③ [Selecting operation] Button  
Used to switch between cooling, dry, air blowing, and heating.
- ④ [Room temperature adjustment] Button  
Setting is made in a unit of 1 °C.  
Used to set the room temperature.
- ⑤ [Louver] Button  
Used to adjust the lateral direction of the airflow.
- ⑥ [Checking/test run] Button  
Used only during checking test run.
- ⑦ [Filter] Button  
Pressed to reset the filter sign.
- ⑧ [Up/down airflow direction] Button
- ⑨ [ON/OFF] Button  
Once the operation has been set, you can use it repeatedly simply by pressing the [ON/OFF] button.
- ⑩ [Fan speed adjustment] Button

\* Some models of the indoor units have no functions. (Operation of the remote controller becomes void.)

### Before starting operation

- Make sure that the power supply is turned ON before use.
- Start running after the “HO” display has disappeared (max. 2 minutes).
- In some systems, more than one indoor unit may be connected to a single outdoor unit. When a remote controller for one indoor unit is used to change modes at the same time as a different indoor unit is working together with the outdoor unit, the operation underway stops, and the new operation begins. Until the old operation is complete, the display on the remote controller flashes to indicate that the new operation is in “waiting” status.

#### ⚠ Warning:

**Check and confirm the power circuit before use.**

### 2.1. ON/OFF

#### Start an operation/Stop an operation

- ① Press [ON/OFF] button  
Operation lamp lights up/off and operation starts/stops.
- Ⓐ Operation lamp

#### ⚠ Caution:

**Even if the operation button is pressed immediately after the operation is stopped, operation is not restarted for about 3 minutes.**

### 2.2. Mode select

- ① If the unit is off, press the ON/OFF button to turn it on.  
Ⓐ The ON indicator should light up.
- ② Press the operation mode (□ ⚙ ⚙ ⚙ ⚙) button and select the operation mode.  
Ⓑ
  - ⚙ Cooling mode
  - ⚙ Fan mode
  - ⚙ Heating mode
  - 💧 Drying mode
  - Automatic (cooling/heating) mode

#### Note:

**The heating display and the automatic display does not appear in models that operate exclusively as cooling only air-conditioner.**

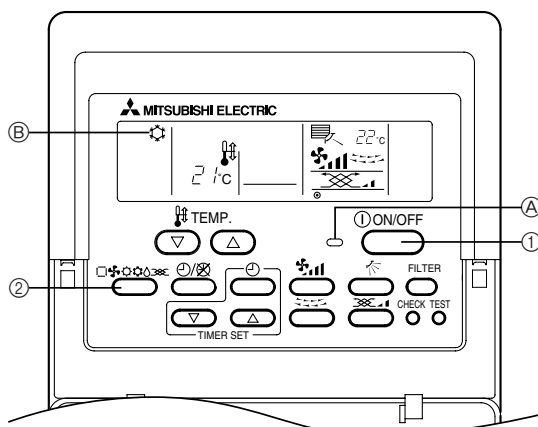
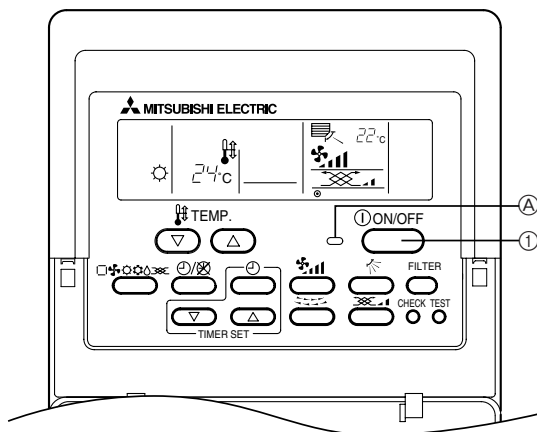

## 2. Operation

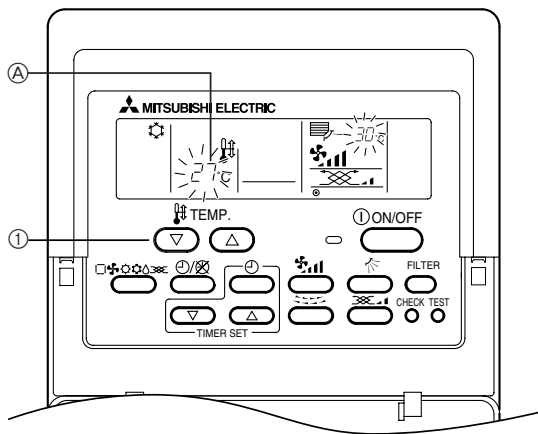

### 2.3. Selecting a temperature TEMP.

#### ► To decrease the room temperature:

① Press  button to set the desired temperature.

Ⓐ The selected temperature is displayed.

- Each time you press the button, the temperature value decreases by 1 °C.

#### ► To increase the room temperature:

① Press  button to set the desired temperature.

Ⓐ The selected temperature is displayed.

- Each time you press the button, the temperature value increases by 1 °C.

- Available temperature ranges are as follows:

Cooling & Drying: 19 - 30 °C

Heating: 17 - 28 °C

Automatic: 19 - 28 °C

Circulation: — (Not available)

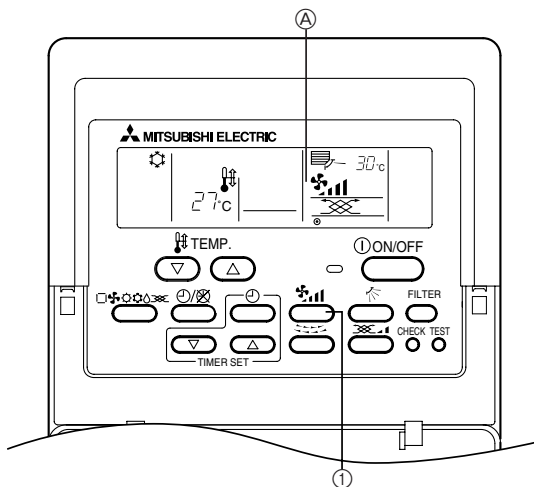

- The display flashes either 8 °C - 39 °C to inform you if the room temperature is lower or higher than the displayed temperature.



### 2.4. Selecting a fan speed

① Press  button to select a desired fan speed.

- Each time you press the button, available options change with the display Ⓐ on the remote controller, as shown below.

Fan speed	Remote controller display		
	Low	Medium	High
3-stage			

The display and the fan speed of the unit will differ in the following situations:

- When STAND BY and DEFROST are displayed.
- Just after the heating mode (while waiting to change to another mode).
- When the temperature of the room is higher than the temperature setting of the unit operating in the heating mode.
- In the dry operation, the indoor fan automatically turns to low-speed operation. Switching of fan speed is impossible.

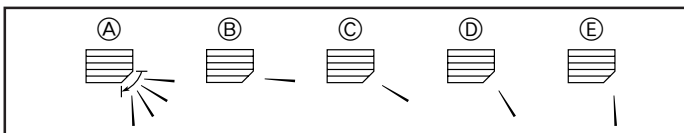

### 2.5. Adjusting vertical airflow direction

The vertical air vane helps select the vertical direction of the airflow.

① Press  button to select the vertical airflow direction.

- Each time you press the button, the option changes are displayed on the remote controller, as shown below.

Ⓐ (Swing) → B → C → D → E → Ⓐ

- If the room temperature is higher than the temperature set on the remote controller while the unit is defrosting or preparing for heating, the vertical air vane will move to the horizontal airflow position (Ⓑ).
- In either cooling or dry mode, if you select C, D or E when the fan speed is low, middle 2, a display reading "1Hr." Ⓔ will appear. After one hour, the air conditioner will switch automatically to horizontal air mode B and the display "1Hr." Ⓔ will disappear.
- When the heating thermostat is OFF, the louver automatically turns horizontally during defrosting or preparation for heating.

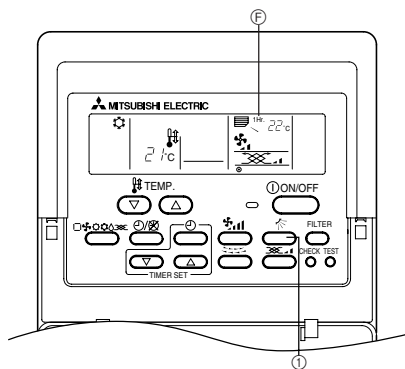

## 2. Operation

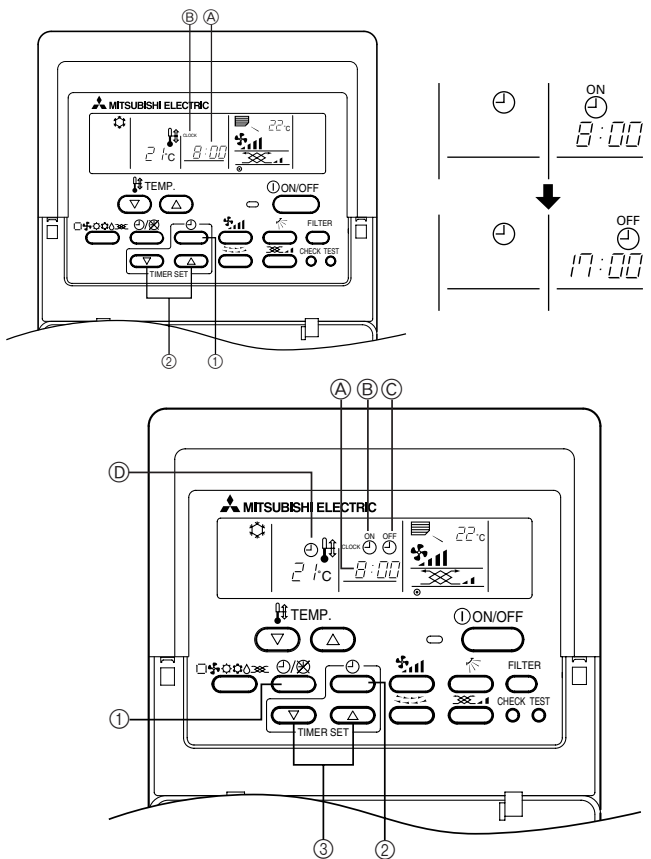

### 2.7. Using the timer

#### 1) Set the current time

- Press **(A)** button to display the "CLOCK" **(B)**.

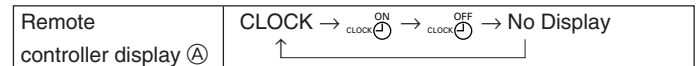

- Each time you press **(A)** button, the time increases in increments of one minute. Each time you press **(B)** button, the time decreases in increments of one minute.
- Press and hold the button to rapidly change the time.
- The time changes in increments of one minute → ten minutes → in units of hour; in this order.
- Approximately ten seconds after pressing the button, the display on the remote controller will turn off.

The example shows a timer set for operation start at 8:00 and end at 17:00.

#### 2) Set the mode to continuous as follows

- Press **(D)** button to display **(D)**.

#### 3) Set the time to start the unit as follows

- Press **(A)** button to display **(B)**.
- Press **(C)** button to set the time that you want the unit to start. The start time is displayed at **(A)**.

#### 4) Set the time to stop the unit as follows

- Press **(A)** button to display **(C)**.
- Press **(C)** button to set the time that you want the unit to stop. The stop time is displayed at **(A)**.

#### 5) Set the mode to timer as follows

- Press **(D)** button to display **(D)**.

## 3. Care and cleaning

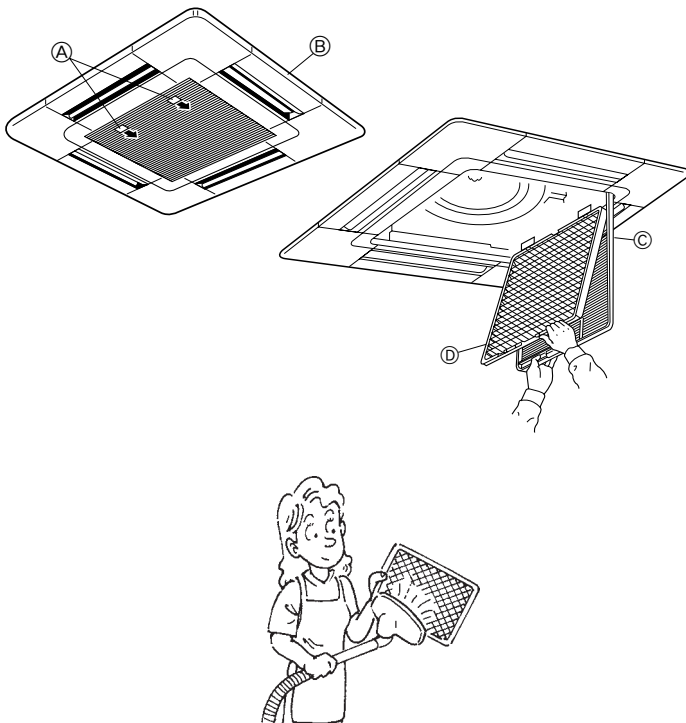

### ⚠ Caution:

- Always turn off the power, first on the remote controller and then the main switch, before cleaning or servicing the unit.
- When installing or removing the filter or the intake grille, do not stand on an unsteady surface. You may fall and injure yourself. Be also careful not to let dust fall into your eyes.

Dirty or clogged filters block the airflow and reduce efficiency. Very dirty filters can damage the air-conditioner itself.

#### Intake grille removal

- Pull the catch on the intake grille in the direction indicated by the arrow and it should open.
- Unhook the hinges to remove the intake grille from the grille.

#### Filter removal

- Open the intake grille.
- Release the catch on the center edge of the intake grille and pull the filter forward to remove the filter.

(A) Catch (B) Grille (C) Intake grille (D) Filter

### 3.1. Cleaning the filters and the indoor unit

#### Cleaning the filter

- Clean the filter using a vacuum cleaner. If you do not have a vacuum cleaner, tap the filter against a solid object to knock off dirt and dust.
- If the filter is especially dirty, wash it in lukewarm water. Take care to rinse off any detergent thoroughly and allow the filter to dry completely before putting it back into the unit.

### ⚠ Caution:

- Do not dry the filter in direct sunlight or by using a heat source, such as an electric heater: this may warp it.
- Do not wash the filter in hot water (above 50°C), as this may warp them.
- Make sure that the air filter is always installed. Operating the unit without air filter can cause malfunction.

### 3. Care and cleaning

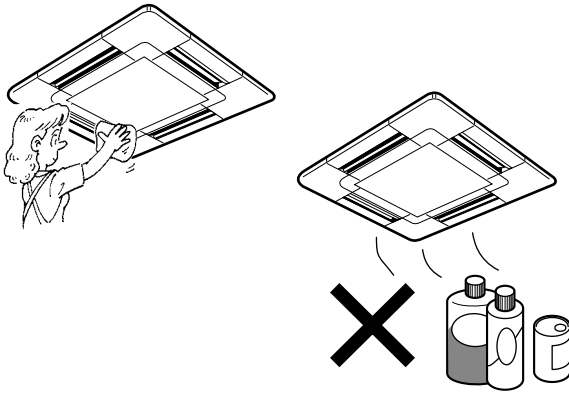

#### Cleaning the indoor unit

- Wipe the outside of the unit with a clean, dry, soft cloth.
- Clean off any oil stains or finger marks using a neutral household detergent (such as dishwashing liquid or laundry detergent).

#### ⚠ Caution:

Never use gasoline, benzene, thinner, scouring powder or any type of non-neutral detergent, as these substances may damage the unit's case.

### 4. Troubleshooting

Before you ask for repair service, check the following points:

State of Machine	Troubleshooting
It does not run.	Press the [ON/OFF] button after power restoration.
Air flows out but it does not cool enough or heat enough.	Check the set temperature. Clean up the filter.
Cool air or warm air does not come out.	Wait for a while. The restart-preventing circuit is in operation for 3 minutes. Wait for a while. Indoor unit operation was started anew during the heating and defrosting operation.
The sound of the exhaust and rotation of the motor can still be heard after stop of running.	Wait for 3 minutes. The machine stops after running a drain-up mechanism for 3 minutes when air-cooling operation is stopped.

#### The following symptoms are not air conditioner failures:

- The air blown out from the air conditioner can sometimes give off odors. This is due to cigarette smoke contained in the air of the room, the smell of cosmetics, the walls, furniture, etc., absorbed in the air conditioner.
- A hissing noise can be heard immediately after the air conditioner is started or stopped. This is the sound of the refrigerant flowing inside the air conditioner. The problem is insignificant.
- The air conditioner sometimes snaps or clicks at the beginning or end of cooling/heating operation. This is the sound of friction on the front panel and other sections due to inflation and contraction caused by temperature change. The problem is insignificant.

#### Range of application

The range of working temperatures for both the indoor and outdoor units of the series Y, R2, Multi-S is as below.

#### ⚠ Caution:

The use of your air conditioner outside the range of working temperature and humidity can result in serious failure.

Mode	Indoor unit	Outdoor unit		
		PUHY	PURY	PUMY
Cooling	15 °C - 24 °C WB	-5 °C - 43 °C DB	-5 °C - 43 °C DB	-5 °C - 46 °C DB
Heating	15 °C - 27 °C DB	-15 °C - 15.5 °C WB	-12 °C - 15 °C WB	-12 °C - 15.5 °C WB

Note: As an applicable humidity standard for both indoors and outdoors, we recommend use within a range of 30 - 80% relative humidity.

#### ⚠ Warning:

If the air conditioner operates but does not cool or heat (depending on model) the room, consult your dealer since there may be a refrigerant leak. Be sure to ask the service representative whether there is refrigerant leakage or not when repairs are carried out.

The refrigerant charged in the air conditioner is safe. Refrigerant normally does not leak, however, if refrigerant gas leaks indoors, and comes into contact with the fire of a fan heater, space heater, stove, etc., harmful substances will be generated.

### 5. Specifications

#### ■ PLFY-P-VCM-E Series

Model	P20	P25	P32	P40
Power source (Voltage<V>/Frequency)	<Hz> ~N/220-230-240/50			
Capacity (Cooling/Heating)	<kW> 2.2/2.5	2.8/3.2	3.6/4.0	4.5/5.0
Dimension (Height)	<mm> 208 (20)			
Dimension (Width)	<mm> 570 (650)			
Dimension (Depth)	<mm> 570 (650)			
Net weight	<kg> 15.5 (3)		17.0 (3)	
Fan Airflow rate (Low-Middle-High)	<m³/min> 8-9-10		8-9-11	
Noise level (Low-Middle-High)	<dB> 28-31-35	28-31-37	29-33-38	30-34-39

\*1 Cooling/Heating capacity indicates the maximum value at operation under the following condition.

Cooling: Indoor 27 °C DB/19 °C WB, Outdoor 35 °C DB

Heating: Indoor 20 °C DB, Outdoor 7 °C DB/6 °C WB

\*2 This figure ( ) indicates panel's.

This product is designed and intended for use in the residential,  
commercial and light-industrial environment.

The product at hand is based on the following EU regulations:

- Low Voltage Directive 73/23/ EEC
- Electromagnetic Compatibility Directive 89/336/ EEC

Please be sure to put the contact address/telephone number on  
this manual before handing it to the customer.