Run / Standby Panel

PANEL_RS3

FOR INSTALLERS

INSTALLATION MANUAL

Version 1.01

For safe and correct use, please read this installation manual thoroughly before installing the PANEL_RS3.

mitsubishi
MITSUBISHI ELECTRIC

1

[Fig. 1]

A

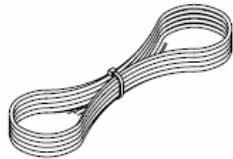

B

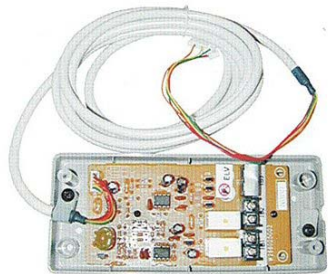

- A 4 x PAC-SA89TA
- B 4 x PAC-SF40RM

2

[Fig. 2]

- A Input / output terminal
- B 240VAC terminal
- C Time clock
- D Relays
- E Control fuses
- F Transformer

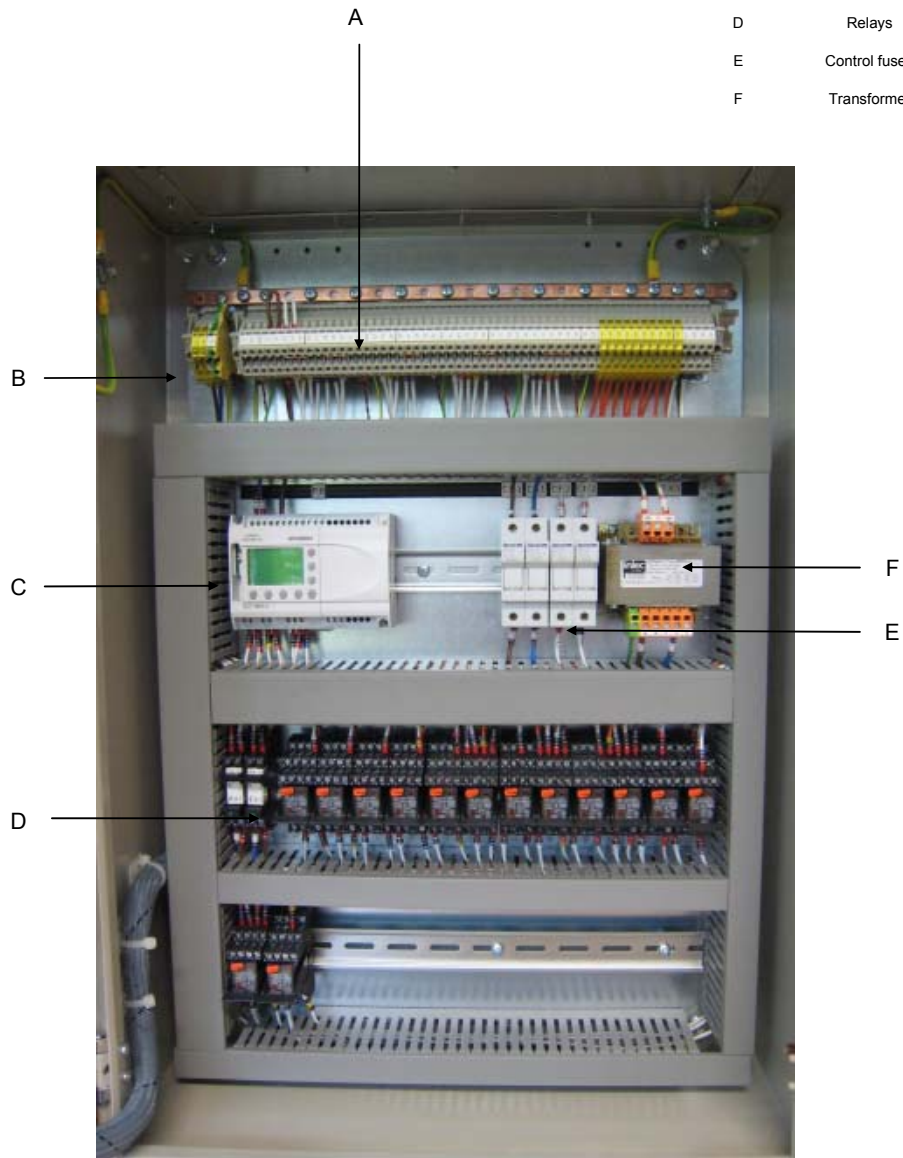

3

[Fig. 3]

- A Thermostat
- B Lamp status
- C Remote controllers
- D Door lock
- E Air conditioning On/Off switch
- F Buzzer switch

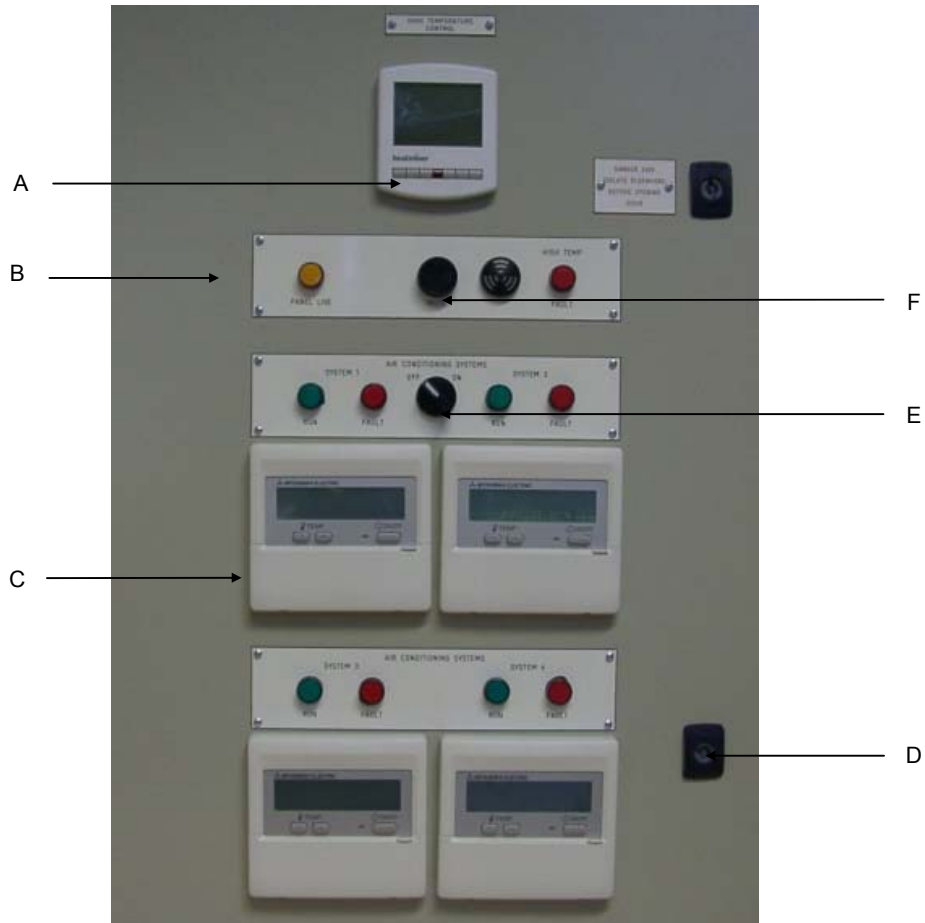

4

[Fig. 4]

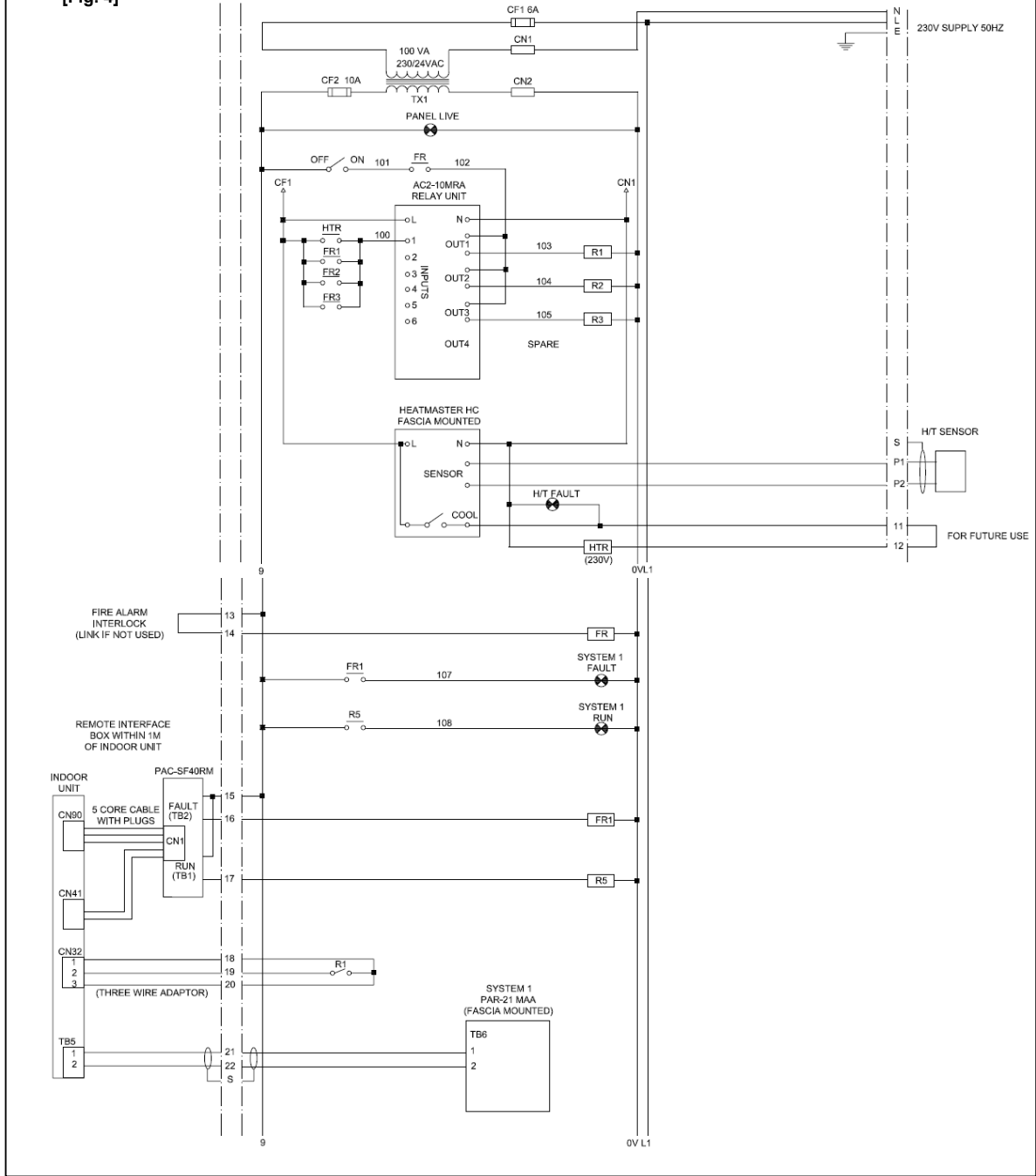

5

[Fig. 5]

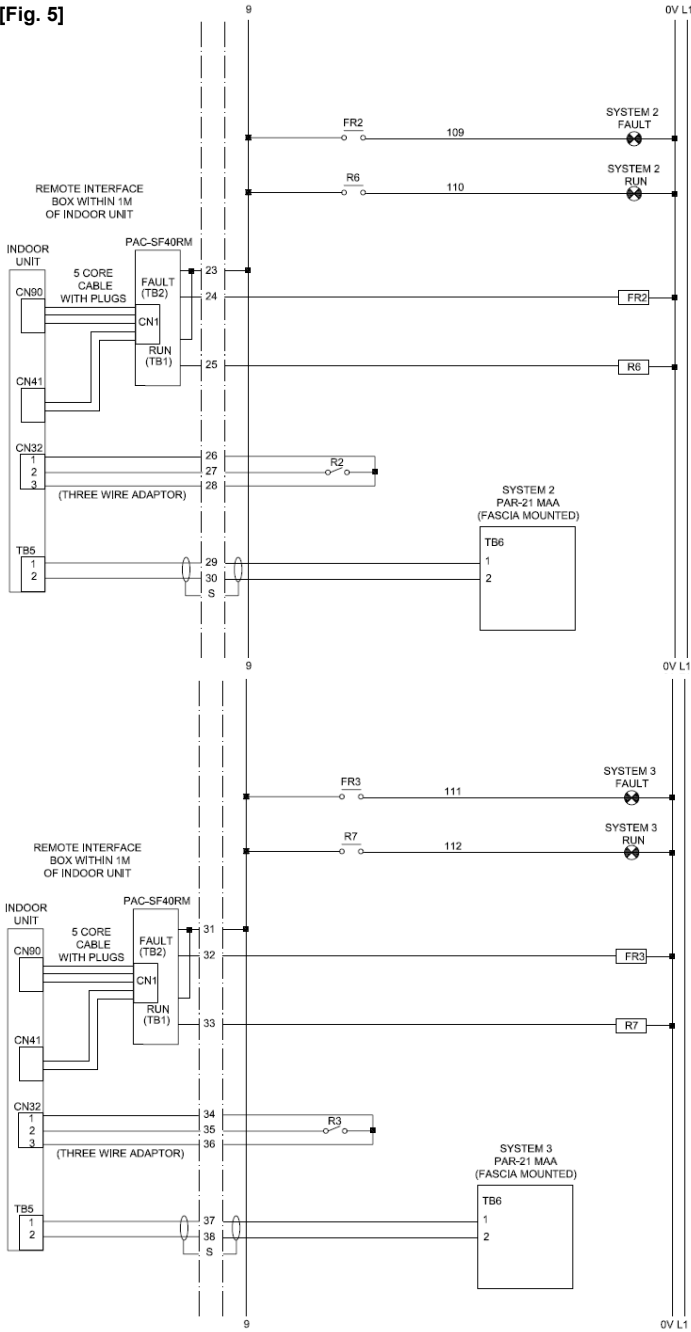

5

[Fig. 5]

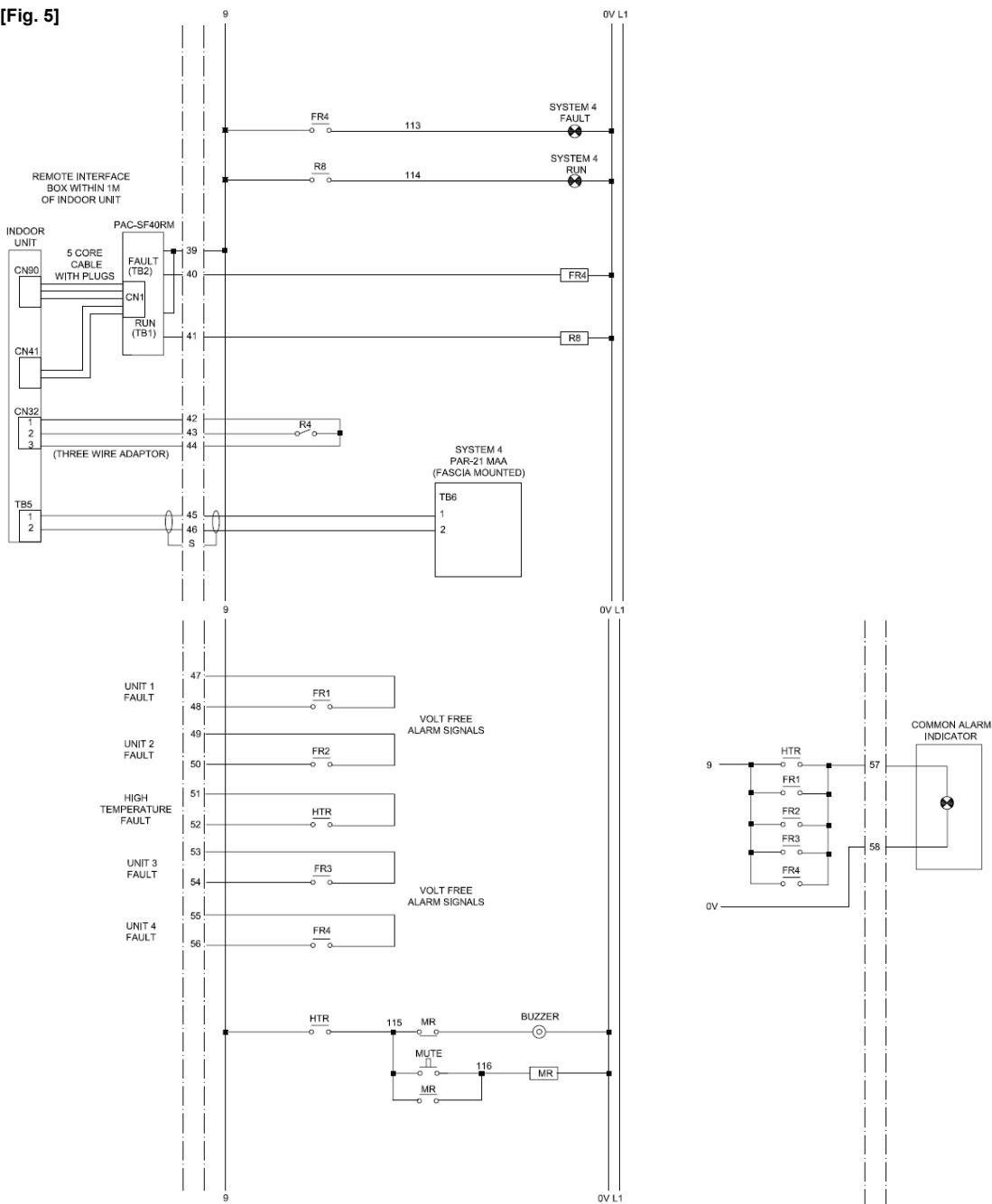

Contents

1.	Safety precautions	9
2.	Overview	10
3.	Panel size and weight	11
4.	Selecting an installation site	12
5.	Installation	13
5.1.	System diagram 1 – Connected to Mr Slim units	13
5.2.	System diagram 2 – Connected to City Multi PFD units.....	14
6.	Electrical wiring	15
6.1.	Precautions on electrical wiring.....	15
6.2.	Types of control cables	15
6.3.	Connecting wiring.....	15
6.3.1.	Power supply wiring.....	15
6.3.2.	Connecting PAC-SA89TA	15
6.3.3.	Connecting PAC-SF40RM (for Mr Slim)	15
6.3.4.	Connecting optional PAR-21MAA.....	15
7.	Applicable Air Conditioning models	16
8.	Additional information	17
8.1.	Heatmiser thermostat	17
8.1.1.	Overview.....	17
8.1.2.	Wiring diagram	17
8.1.3.	Technical Details	17
8.2.	Inlec transformer.....	18
8.2.1.	Overview.....	18
8.3.	Mitsubishi Electric AL2-14MR-A alpha controller	19
8.3.1.	Overview.....	19
8.3.2.	Setup.....	19
8.4.	Mitsubishi Electric PAR-21MAA remote controller	20
8.4.1.	Overview.....	20
8.4.2.	Lock the buttons	21
8.4.3.	Error codes	22

1. Safety precautions

- **Before installing the unit, make sure you read all the "Safety precautions"**
- **The "Safety precautions" provide very important points regarding safety. Make sure you follow them**

Symbols used in the text

Warning:

Describes precautions that should be observed to prevent danger of injury or death to the user.

Caution:

Describes precautions that should be observed to prevent damage to the unit.

-  **Warning:**
Carefully read the labels affixed to the main unit

Warning:

- **Ask the dealer or an authorised technician to install the unit**
 - Improper installation by the user may result in water leakage, electric shock, or fire
- **Use the specified cables for wiring. Make the connections securely so that any outside forces acting on the cables are not applied to the terminals**
 - Inadequate connection and fastening may generate heat and cause a fire
- **Never repair the unit. If the controller must be repaired, consult the dealer**
 - If the unit is repaired improperly, electric shock, or fire may result
- **When handling this product, always wear protective equipment. EG: Gloves, full arm protection and safety glasses**
 - Improper handling may result in injury
- **Have all electric work done by a licensed electrician according to "Electric Facility Engineering Standard", "Interior Wire Regulations" and the instructions given in this manual and always use a special circuit**
 - If the power source capacity is inadequate or electric work is performed improperly, electric shock and fire may result
- **Keep the electric parts away from any water - washing water etc...**
 - Contact may result in electric shock, fire or smoke
- **Do not reconstruct or change the settings of the protection devices**
 - If the protection device is shorted or operated forcibly, or parts other than those specified by Mitsubishi Electric are used, fire or explosion may result
- **To dispose of this product, consult your dealer**

Caution:

- **Ground the unit**
 - Do not connect the ground wire to gas or water pipes, lightning rods, or telephone ground lines. Improper grounding may result in electric shock
- **Install the power cable so that tension is not applied to the cable**
 - Tension may cause the cable to break and generate heat which may, in turn, cause fire
- **Install a leak circuit breaker, as required**
 - If a leak circuit breaker is not installed, electric shock may result
- **Use power line cables of sufficient current carrying capacity and rating**
 - Cables that are too small may leak, generate heat, and cause a fire
- **Use only a circuit breaker and fuse of the specified capacity**
 - A fuse or circuit breaker of a larger capacity or a steel or copper wire may result in a general unit failure or fire
- **Be careful that the installation base is not damaged**
 - If the damage is left uncorrected, the unit may fall and cause personal injury or property damage
- **Be very careful regarding product transportation**
 - Two people should be used to carry products of 20kg or more
 - Some products use PP bands for packaging. Do not use any PP bands for a means of transportation
- **Safely dispose of the packing materials**
 - Packing materials, such as nails and other metal or wooden parts, may cause stabs or other injuries
 - Tear apart and throw away plastic packaging bags so that children will not play with them - If children play with a plastic bag which has not been torn apart, they face the risk of suffocation

2. Overview

The run/standby panel is used to automatically change over four Air Conditioning indoor units.

The panel will be fed with a 240VAC power supply.

The panel is fitted with a day time controller with battery back-up and latching relay to permit three indoor units to run for instance 7 days, after this the panel will automatically change over to the next indoor unit for 7 days etc.

The panel is designed that if one indoor unit goes to fault while running it would automatically bring in the backup indoor unit.

The high temperature thermostat option will allow the four indoor units to run together if a high temperature exists. A high temperature warning lamp will indicate.

The sounder & mute option will allow any fault condition received by the control panel (i.e. unit fault, or high temperature) to initiate a sounder on the panel door. A mute button is fitted to silence the sounder.

Volt free terminals are fitted to allow fault signals to be transmitted to any external monitoring system.

The panel is supplied with accessories to interface with the Air Conditioning indoor unit:

- 3 wire adaptor to control the On/Off
- PAC-SF40RM to monitor Run and Faults with Mr Slim indoor units

Figure 1 shows the accessories supplied with the panel.

Figure 2 shows the inside of the panel.

Figure 3 shows the front panel.

Figure 4 shows the wiring diagram of the panel.

3. Panel size and weight

The panel details are:

- Height 700mm
- Width 500mm
- Depth 210mm
- Weight 30Kg

4. Selecting an installation site

- Avoid locations in direct sunlight
- Avoid locations exposed to steam or oil vapour
- Avoid locations where combustible gas may leak, settle or be generated
- Avoid installation near machines emitting high-frequency waves
- Avoid places where acidic solutions are frequently handled
- Avoid places where sulphur-based or other sprays are frequently used
- Avoid areas of high humidity (when cooling operation is required)
- Install inside the building
- Install near the indoor units monitored and controlled

5. Installation

5.1. System diagram 1 – Connected to Mr Slim units

Four Mr Slim indoor units can be connected to the PANEL_RS3 via four PAC-SF40RM and four PAC-SA89TA.

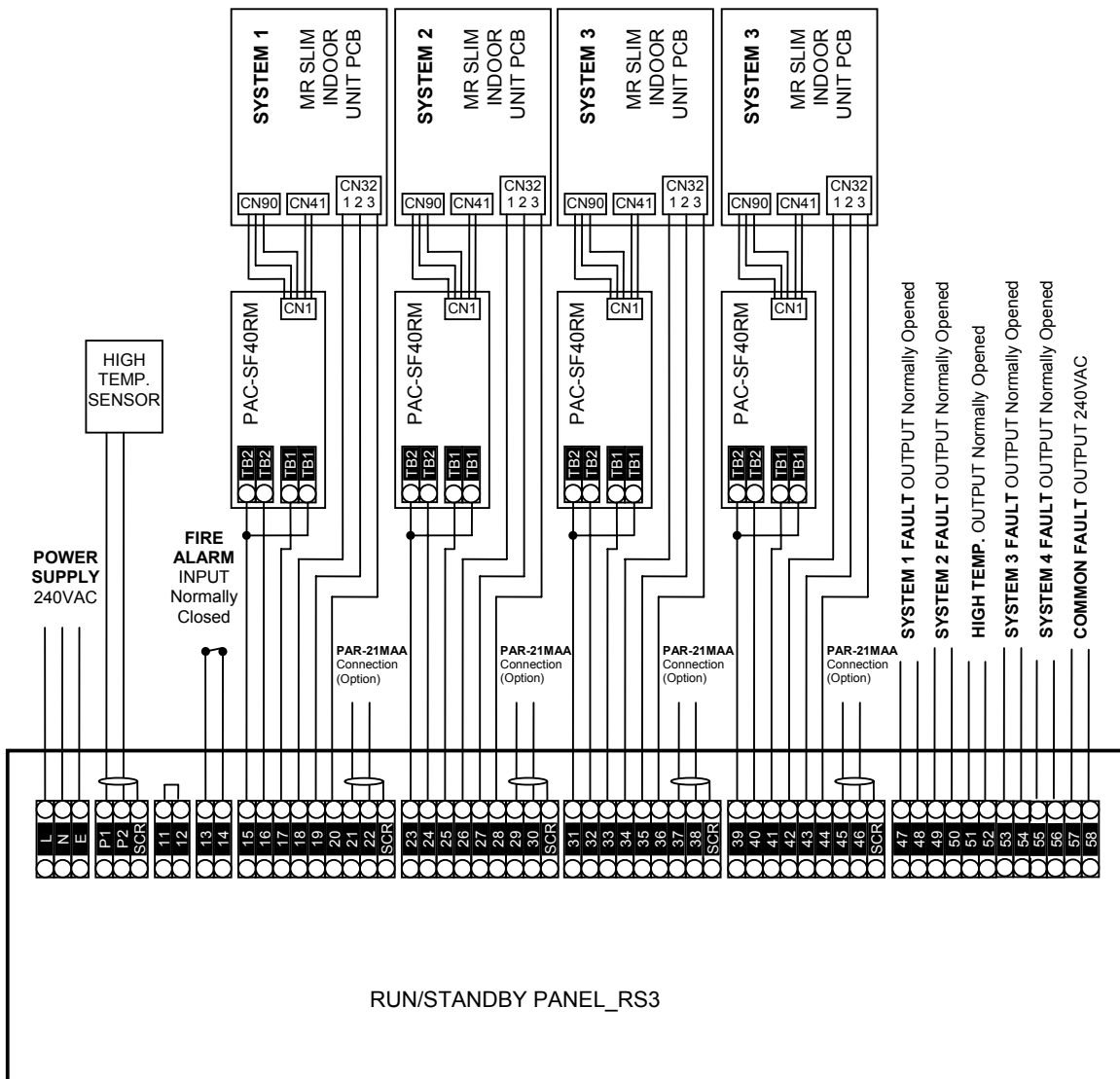

5.2. System diagram 2 – Connected to City Multi PFD units

Four City Multi PFD indoor units can be connected to the PANEL_RS3 via four PAC-SA89TA. The PAC-SF40RM interfaces are not required.

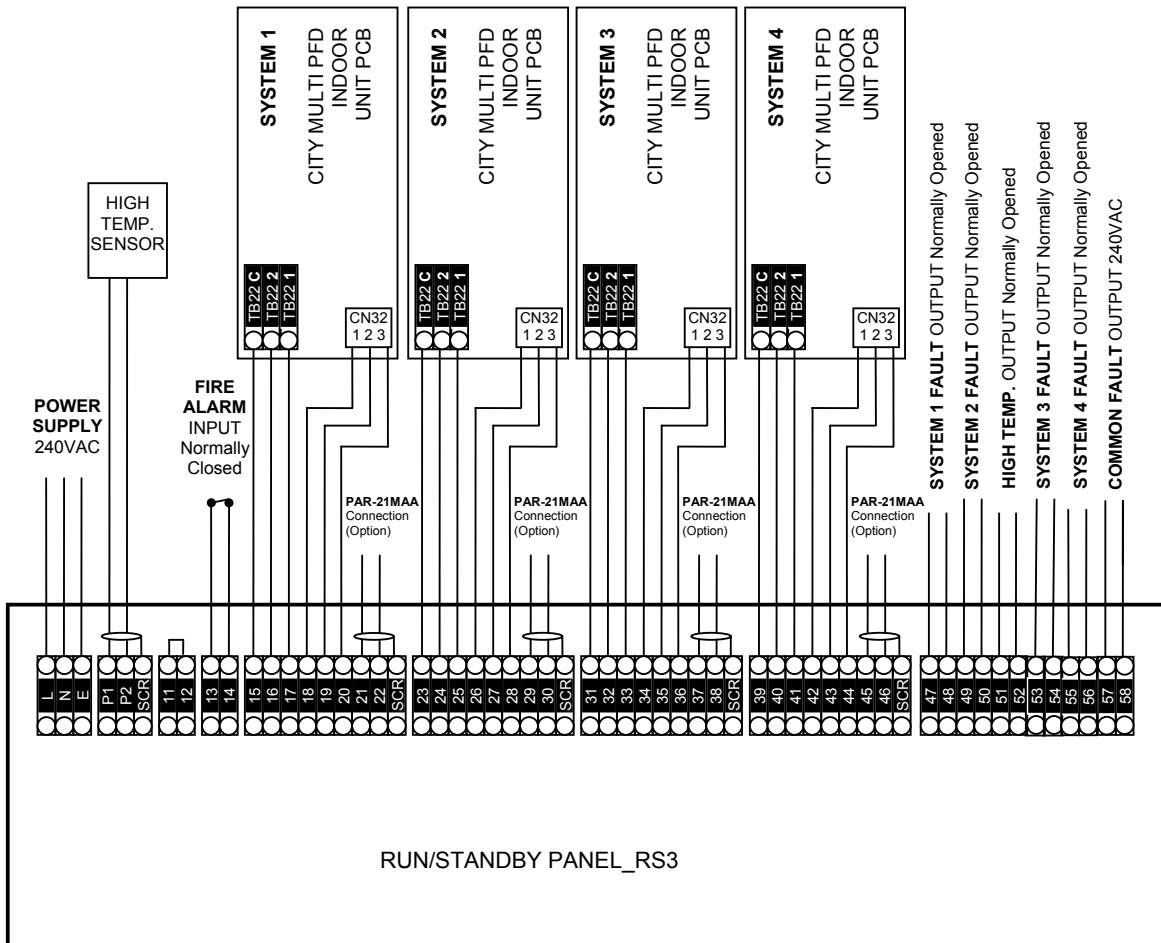

Please note that DIP SWITCH SW1-9 and SW1-10 must be switched **OFF** to activate level input with CN32 instead of pulse input.

6. Electrical wiring

6.1. Precautions on electrical wiring

⚠ Warning:

Electrical work should be done by qualified electrical engineers / electrician in accordance with "Engineering Standards for Electrical Installation" and supplied installation manuals. Dedicated circuits should also be used. If the power circuit lacks capacity or has an installation failure, it may cause a risk of electric shock or fire.

- Be sure to take power from the special branch circuit
- Be sure to install an earth leakage breaker to the power
- Install the unit to prevent any of the control circuit cables (MNET transmission cables) coming into direct contact with the power cable outside the unit
- Ensure that there is no slack on all wire connections
- Never connect the power cable to leads for the transmission cables. This will damage the transmission cable
- Select control cables from the conditions given in "Type of control cables" section

6.2. Types of control cables

Wiring transmission cables

- Cable diameter: More than 1.25 mm² screened cable

6.3. Connecting wiring

6.3.1. Power supply wiring

Power supply cords of appliances shall not be lighter than design 245 IEC 57 or 227 IEC 57.

⚠ Caution:

Do not use anything other than the correct capacity breaker and fuse. Using fuse, wire or copper wire with too large capacity may cause a risk of malfunction or fire.

6.3.2. Connecting PAC-SA89TA

Connect the PAC-SA89TA to the CN32 terminal on the indoor unit. The other end of the wire must be connected to the panel (18, 19 and 20 for system 1, 26, 27 and 28 for system 2, 34, 35 and 36 for system 3 and 42, 43 and 44 for system 4).

6.3.3. Connecting PAC-SF40RM (for Mr Slim)

Connect the PAC-SF40RM to the CN90 and CN41 terminals on the Mr Slim indoor unit. The TB1 and TB2 terminals must be connected to the panel (15, 16 and 17 for system 1, 23, 24 and 25 for system 2, 31, 32 and 33 for system 3 and 39, 40 and 41 for system 4).

6.3.4. Connecting optional PAR-21MAA

Connect the optional PAR-21MAA to the MA remote controller terminal on the indoor unit. The other end of the wire must be connected to the panel (21 and 22 for system 1, 29 and 30 for system 2, 37 and 38 for system 3 and 45 and 46 for system 4). A CN22 connector is required for each wall mounted indoor unit.

7. Applicable Air Conditioning models

Below is a list of Air Conditioning models that can be connected to this panel:

- Mr Slim product range
- PFD City Multi VRF product range

Please note that:

- **A CN22 connector is required for each wall mounted indoor unit**
- The PAC-SF40RM is not required for the PFD units

8. Additional information

8.1. Heatmiser thermostat

8.1.1. Overview



Set Temperature

This is the temperature the thermostat is currently controlling to. At any time, you can press the Up/Down arrow key and the display will show the set Temperature for 30 seconds.

8.1.2. Wiring diagram

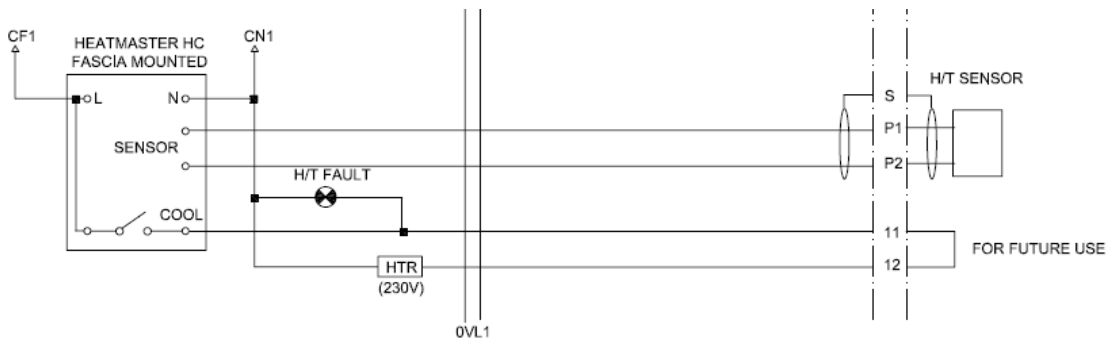

8.1.3. Technical Details

- Large display
- Automatic blue back-light (Turns off after 30 seconds)
- Flush mounting
- Self Learning Optimum Start (Heating Mode only)
- °C / °F Selectable
- Heating, Cooling and Automatic modes available
- 30 minute timing increments
- 5 day/2 day Program
- (Weekday/Weekend programming)
- Up to 4 changes in room temperature
- Fan speed: Auto, High, Medium, Low
- Heating Output, Cooling Output, Frost protection
- Easily increase or decrease the required temperature
- Temperature range 05°C - 35°C
- Supply: 230v / 110v
- Outputs: 230v / 110v

8.2. Inlec transformer

8.2.1. Overview

control panel transformers

- Conforms to EN60742, IEC742, IEC61558
- Double wound with earth screen between windings
- Frequency range 50/60 Hz
- Terminal block connection
- Good access to fixing flanges
- Continuous duty
- Full varnish impregnation for silent running

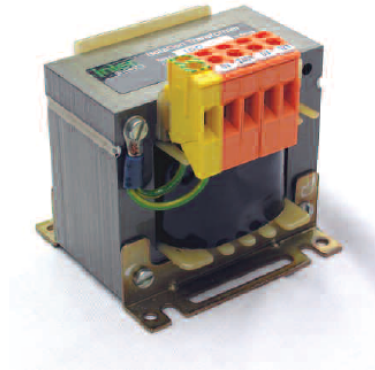

voltages		VA rating part no.	A	B	C	D	E	% reg	inrush VA for 10% drop	weight kg
Primary	0 - 220 - 230 - 240	U CL50	76	70	86	53	47	9	105	1.1
	0 - 380 - 400 - 415	N CL75	76	76	86	53	53	8.8	160	1.5
Secondary	0 - 12	J CL100	84	78	95	60	68	6.7	250	2.2
	0 - 24	B CL150	96	76	102	68	63	6.7	375	3.2
	0 - 48	E CL200	96	86	102	68	73	5.8	550	4.0
	0 - 110	F CL250	96	101	102	68	88	5.3	720	5.0
	0 - 230	U CL300	120	88	122	80	71	5.3	870	6.0
		CL500	120	120	122	80	103	4.1	1700	7.5
		CL750	150	135	140	105	70	5.2	2200	10.0
		CL1000	150	161	140	105	96	3.3	4000	13.0
		CL1500	150	188	140	105	123	3.2	6200	16.0
		CL2000	175	150	165	153	125	3.3	8060	18.0
	CL2500	175	178	165	153	158	2.6	12100	20.0	

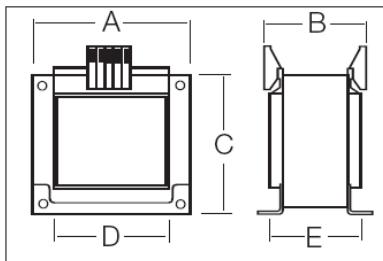

8.3. Mitsubishi Electric AL2-14MR-A alpha controller

8.3.1. Overview

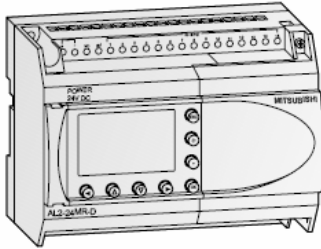

The ALPHA 2 Series

The 'Alpha 2' brings the benefits of the Alpha closer to the functionality of a Micro PLC. A program capacity of 200 functions and fifteen new function blocks including mathematical operations, PWM, 1KHz high speed counter and SMS text messaging, along with a wide operating temperature (-25 to 55°C) open up new possibilities in all areas of building and industrial automation. The large back lit screen features display options including bar graphs and scrolling text. Optional extension units can increase the I/O by 4 points of digital I/O. Features include:

- Expandable
- Analogue out
- GSM options
- Temperature input

Specifications	AL2-14MR-A	AL2-14MR-D A	AL2-24MR-A	AL2-24MR-D
Electrical specifications				
Integrated inputs/outputs	14	14	24	24
Power supply AC range (+10%, -15%)	100–240 V AC	24 V DC	100–240 V AC	24 V DC
Digital Inputs				
Integrated inputs number	8	8	15	15
Input voltage	100–240 V AC	24 V DC	100–240 V AC	24 V DC
Analog inputs				
Channels	—	8	—	8
Analog input range	—	0–500	—	0–500
Voltage	—	0–10 V DC	—	0–10 V DC
Outputs				
Integrated outputs number	6	6	9	9
Type	Relay	Relay	Relay	Relay
Switched voltage (max.) V	250 V AC, 30 V DC	250 V AC, 30 V DC	250 V AC, 30 V DC	250 V AC, 30 V DC
Rated current A	8	8	8	8
Mechanical specifications				
Dimensions (WxDxD) mm	124.6 x 90 x 52	124.6 x 90 x 52	124.6 x 90 x 52	124.6 x 90 x 52
Order information Stock no.	142517	142518	142519	142520

* For Expansion models see the end of this section.

8.3.2. Setup

The Alpha controller is used to switch other the systems every 7 days. The switch over timing (7) can be changed but special programming software is required. Please contact your sales office for more details.

8.4. Mitsubishi Electric PAR-21MAA remote controller

8.4.1. Overview

1. Display Section

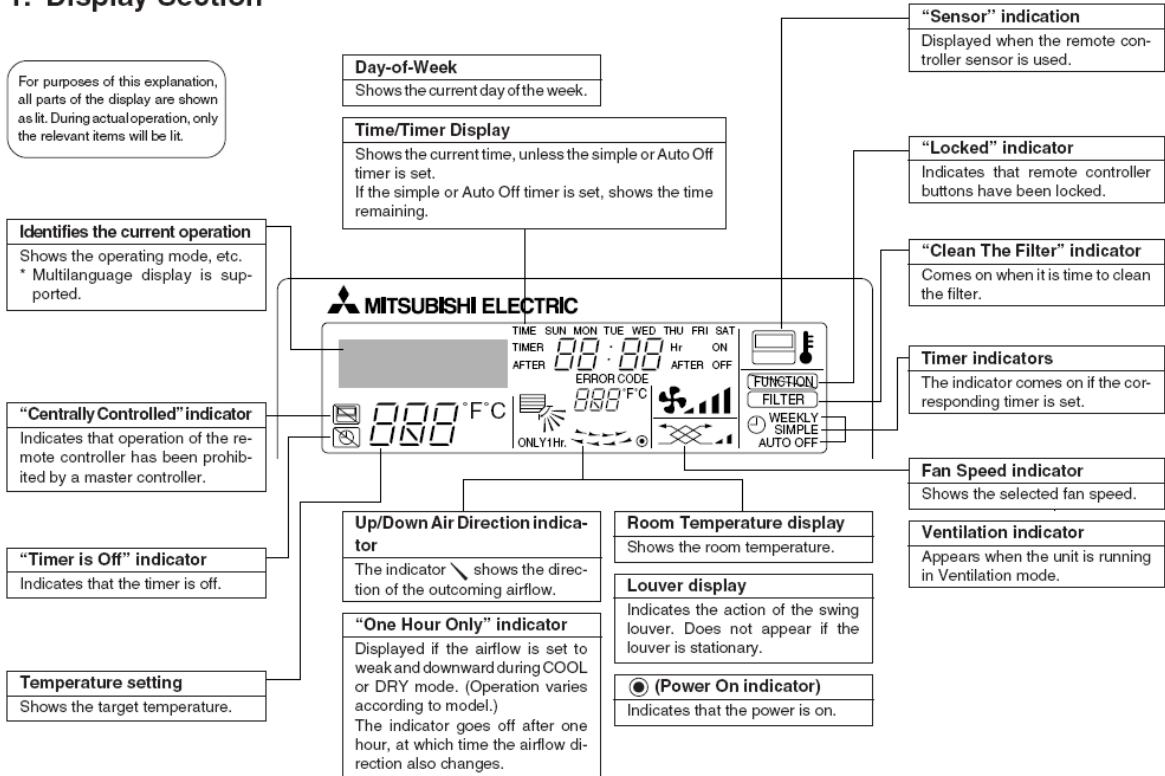

2. Operation Section

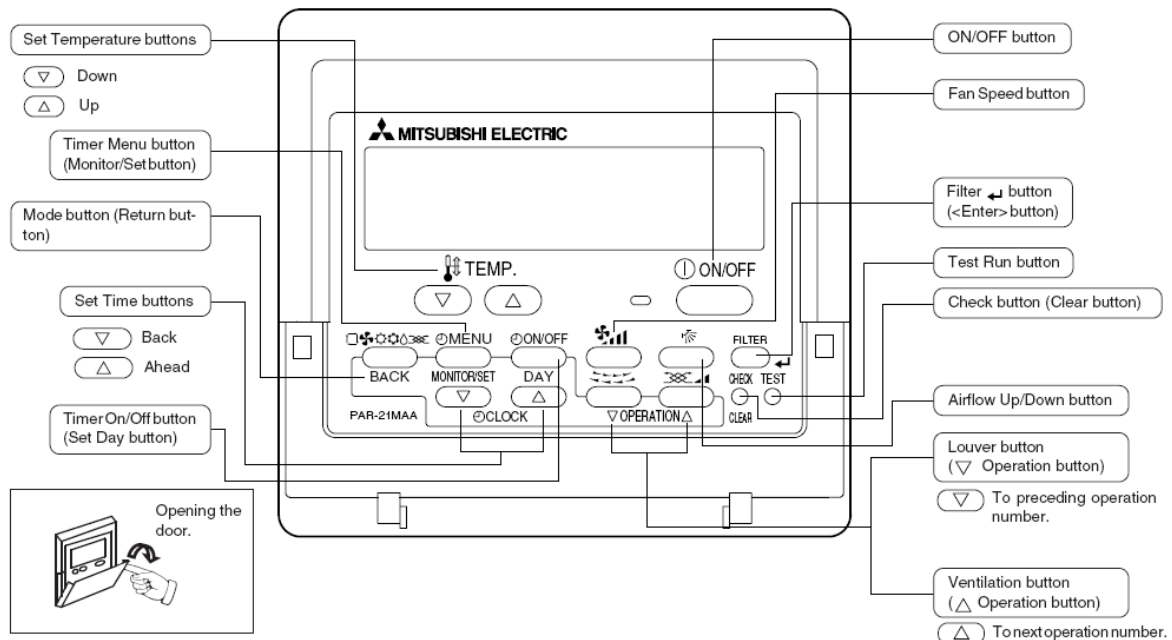

8.4.2. Lock the buttons

The following settings can be made.

- ① no1 : All buttons except for the [ON/OFF] button are locked.
- ② no2 : All buttons are locked.
- ③ OFF (default): No buttons are locked.

* To activate this operation lock function on the normal screen, hold down the **ON/OFF** button for two seconds while holding down the **FILTER** button.

How to Lock the Buttons

■ Display example

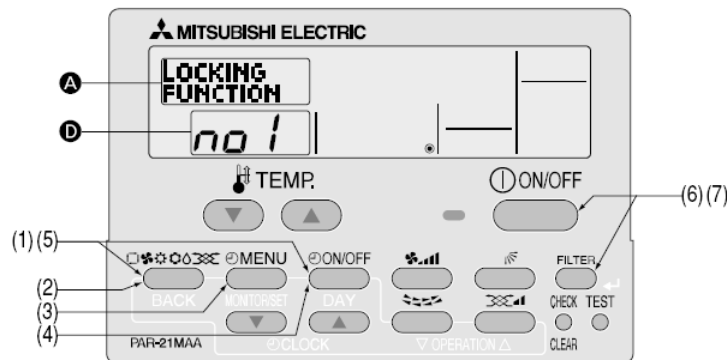

(1) While pressing the **MODE** button, press the **ON/OFF** button for two seconds to activate the remote controller's function selection mode.

(2) Press the **MODE** button to select **FUNCTION SELECTION** on the screen (at **A**).



(3) Press the **MENU** button until "LOCKING FUNCTION" appears on the screen (at **A**).



* Displays the mode that is set in "Temperature Range Limit Setting".

(4) Press the **ON/OFF** button until the desired lock mode appears on the screen (at **D**).

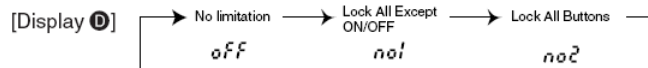

(5) While pressing the **MODE** button, press the **ON/OFF** button for two seconds to return to normal mode. Setting is now complete.

Completing steps (1) to (5) allows use of the operation lock function.
To enable the lock function, carry out the following steps.

Enabling the Lock Function

- (6) While pressing the **FILTER** (↵) button, press the **ON/OFF** button for two seconds to enable the operation lock function. **FUNCTION** appears on the screen (at ⑤).

* If a locked button is pressed while the operation lock function is in use, **FUNCTION** will flash on the screen (at ⑤).

■ Display example when operation lock function is in use



How to Unlock the Buttons

- (7) While pressing the **FILTER** (↵) button, press the **ON/OFF** button for two seconds. **FUNCTION** disappears from the screen (at ⑤).

■ Display example when the operation lock function is not in use

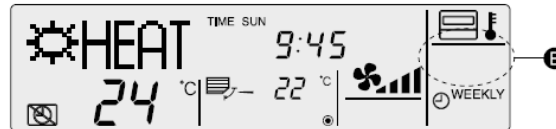

8.4.3. Error codes

Control Error Codes (E)

Displayed on remote controller	Outdoor control board		Error details	Non INV	Power INV	Location of error	Location of inspection		
	LED1 "Green"	LED2 "Red"							
E0	Flashes 2 times	—	Remote controller transmission error	●	●	Remote controller	① If two remote controllers are used, check whether they are set as the main and sub controllers. ② Check if the specified 2-core cable is used. (0.3 to 1.25 mm ²) Cable with 3 or more cores is not acceptable. Check if the cables connecting the indoor and outdoor units are connected firmly and correctly. ③ Check if 3-core VVF-type power cable is used. (In the case of superimposed power supply system) ④ Check if indoor/outdoor unit connecting cables are exposed to rain. ⑤ Check if indoor/outdoor unit connecting cables are extended using extension cable. ⑥ Check if fuse on outdoor control board is blown. ⑦ Check if connectors are connected firmly.		
E3			Flashes 3 times	Remote controller transmission error	●	●		Indoor	
E4			Remote controller transmission error	●	●				
E5			Remote controller transmission error	●	●				
E6			Flashes 2 times	—	Indoor/outdoor unit transmission error	●		●	Indoor
E7					Indoor/outdoor unit transmission error	●		●	
E8					Indoor/outdoor unit transmission error	●		●	
E9					Indoor/outdoor unit transmission error	●		●	
EA			Flash 1 time	—	Mis-wiring of indoor/outdoor units	●		●	Outdoor
Eb					Mis-wiring of indoor/outdoor units (Incorrect connection, disconnection)	●		●	
EC					"Startup" time over	●		●	
EE			Flashes 4 times	—	Combination error	●		●	Indoor
EF					Undefined error (No corresponding M-NET error code)	●		●	
Ed					Flashes 5 times	Transmission error between M-NET adapters		●	
E1	—	—	Remote controller control board error	●	●	Remote controller	① Replace the remote controller		
E2	—	—							

A-Control Error Codes (F/P)

Displayed on remote controller	Outdoor control board		Error details	Non INV	Power INV	Location of error	Location of inspection		
	LED1 "Green"	LED2 "Red"							
F1	Flash 1 time	Flash 1 time	Reverse phase detected / power and indoor-outdoor incorrect connection	—	—	Outdoor	① Power cable and indoor-outdoor cable are misconnected. ② Reverse phase → Replace R-phase with T-phase (outdoor power terminals). ③ Check if all three phases show the same power voltage.		
F2			Detection of loss of power line phase (when no T-phase)	—	—		① Loose connection of T-phase on outdoor unit power terminal block ② Check if all three phases show the same power voltage.		
F3		Flashes 2 times	Connector (63L) open	●	●		① Outdoor control board connector (63L) disconnected ② Low-pressure switch (63L) disconnected		
F5			Connector (63H) open	●	●		① Outdoor control board connector (63H) disconnected ② High-pressure switch (63H) disconnected		
F9		Flashes 3 times	2 or more connectors open	●	●		① Check outdoor control board connector for disconnection and looseness. Replace outdoor control board.		
F7			Reverse-phase detecting circuit (board) error	—	—				
F8			Input circuit (board) error	●	●				
Fb		Flashes 2 times	Flashes 4 times	Indoor control board error	●		●	Indoor	Replace indoor control board.
P1		Flash 1 time	Intake air sensor error	●	●		① Indoor control board connector (CN20) disconnected		
P2	Pipe (fluid pipe) sensor error		●	●	② Indoor control board connector (CN21) disconnected				
P4	Drain sensor error		●	●	③ Indoor control board connector (CN31) disconnected				
P5	Flashes 4 times	Flashes 2 times	Drain overflow protection activated, water leakage	●	●	① Check if drain pipe is tilted or clogged. ② Check if drain pan and drain sensor are dirty. ③ Indoor control board CNP connector disconnected			
P6						Flashes 3 times	Anti-freeze protection (during cool mode) Overheat protection (during heat mode)		●
P8	—	—	Abnormal pipe (fluid) temperature	●	●	① If two or more units are used, check indoor-outdoor connecting cable and pipe for incorrect connection. ② Gas leakage/insufficient gas			
P9						Pipe (two-phase pipe) sensor error	●		●

A-Control Error Codes (U)

Displayed on remote controller	Outdoor control board		Error details	Non INV	Power INV	Location of error	Location of inspection	
	LED1 "Green"	LED2 "Red"						
U2	Flashes 3 times	Flash 1 time	Abnormal discharge temperature / 49C activated (inner thermostat)	—	●	Outdoor	① Check filter for dirt → Clean if dirty. ② Gas leakage/insufficient gas ③ Check for indoor/outdoor short cycle.	
U7			Insufficient refrigerant	—	●		① Check if discharging thermistor is disconnected. ② Check electronic expansion valve for breakdown. ③ Check CNLEV connector on outdoor control board.	
U1		Flashes 2 times	63H activated due to abnormally high pressure	●	●		① Check if ball valve is open. ② Check for indoor/outdoor short cycle.	
UE			63H activated due to abnormally high pressure	●	●		① Check if ball valve is open. ② Check for indoor/outdoor short cycle. ③ Check if there is too much gas.	
UL			63L activated due to abnormally low pressure	●	—		① Check if ball valve is open. ② Gas leakage/insufficient gas	
Ud		Flashes 3 times	Flashes 3 times	Overheat protection (overloaded operation protection / fan error)	●		—	① Check if outdoor unit's heat exchanger is dirty. → Clean if dirty. ② Check for indoor/outdoor short cycle.
U6				Shutoff due to overcurrent in compressor (overload)	●		●	① Check if 12 hours or more have passed since crank-case heater was turned ON. (Replace outdoor control board.)
UC		Flashes 4 times	Power module error	—	●		① Check if ball valve is open.	
UF			Compressor self-protection function activated	—	●		① Check if ball valve is open. ② Check if power capacity is sufficient.	
UP			Compressor overcurrent (lock)	●	●		① Check if ball valve is open. ② Check if power capacity is sufficient.	
UH			Shutoff due to overcurrent in compressor	●	●		① If outdoor control board has been replaced: Check wiring and board design.	
U3		Flashes 5 times	Flashes 5 times	Current sensor error	●		●	① Outdoor control board connector (TH4) disconnected
U4				Discharging thermistor (TH4) open/short-circuit	●		●	① Outdoor control board connector (TH3/TH32) disconnected
				Pipe thermistor (TH3) open/short-circuit	●		●	① Outdoor control board connector (TH6) disconnected
				2-phase pipe thermistor (TH6) open/short-circuit	—		●	① Outdoor control board connector (TH7) disconnected
				Outside air temperature thermistor (TH7) open/short-circuit	—		●	① Outdoor control board connector (TH8) disconnected
U5		Heat sink thermistor (TH8) open/short-circuit	—	●	① Check if there are obstructions in intake/discharge ports of outdoor unit.			
U6		Flashes 6 times	Abnormal heat sink temperature	—	●		① Check power line for open phase. ② Check if power voltage is high enough.	
U6		Flashes 7 times	Abnormal voltage	—	●			

This product is designed and intended for use in the residential, commercial and light-industrial environment.

The product at hand is based on the following EU regulations:

- Low Voltage Directive 73/23/EEC
- Electromagnetic Compatibility Directive 89/336/EEC

Please be sure to put the contact address/telephone number on this manual before handing it to the customer.

mitsubishi electric uk

MITSUBISHI ELECTRIC UK, TRAVELLERS LANE, HATFIELD HERTFORDSHIRE, AL10 8XB