

Revision E:

• INDOOR UNITS COMBINATION SHEETS for MXZ-6C122VA- [E1] have been added.

Please void OBH584 REVISED EDITION-D.

OUTDOOR UNIT SERVICE MANUAL



**No. OBH584
REVISED EDITION-E**

Models

MXZ-2C30VA - [E1]

MXZ-2C40VA - [E1]

MXZ-2C52VA - [E1]

MXZ-3C54VA - [E1]

MXZ-3C68VA - [E1]

MXZ-4C71VA - [E1]

MXZ-4C80VA - [E1]

MXZ-4C80VA2 - [E1]

MXZ-5C100VA - [E1]

MXZ-5C100VA2 - [E1]

MXZ-6C120VA - [E1]

MXZ-6C120VA - [E2]

MXZ-6C122VA - [E1]

Indoor unit service manual

MSZ-FD•VA Series (OBH488)

MSZ-FH•VE Series (OBH623)

MSZ-GE•VA Series (OBH515)

MSZ-EF•VE Series (OBH589)

MSZ-SF•VA Series (OBH555)

MSZ-SF•VE Series (OBH600)

MFZ-KA•VA Series (OB409)

MLZ-KA•VA Series (OBH483)

SLZ-KA•VA Series (OC320)

SEZ-KD•VA(L) Series (HWE07110)

PLA-RP•BA Series (OCH412)

PCA-RP•KA Series (OCH454)

PEAD-RP•JA Series (HWE08130)

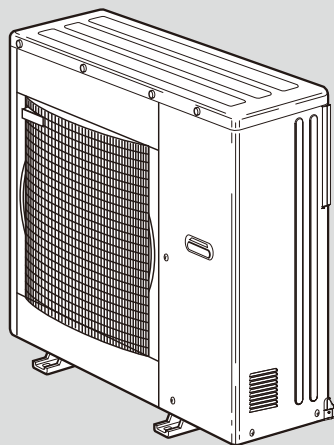

MXZ-4C80VA
MXZ-5C100VA

CONTENTS

1. TECHNICAL CHANGES	3
2. PART NAMES AND FUNCTIONS	4
3. SPECIFICATION	5
4. NOISE CRITERIA CURVES	15
5. OUTLINES AND DIMENSIONS	18
6. WIRING DIAGRAM	24
7. REFRIGERANT SYSTEM DIAGRAM	35
8. PERFORMANCE CURVES	44
9. ACTUATOR CONTROL	75
10. SERVICE FUNCTIONS	76
11. TROUBLESHOOTING	80
12. DISASSEMBLY INSTRUCTIONS	114

INDOOR UNITS COMBINATION SHEETS

PARTS CATALOG (OBB584)

NOTE:

RoHS compliant products have <G> mark on the spec name plate.



Use the specified refrigerant only

Never use any refrigerant other than that specified.

Doing so may cause a burst, an explosion, or fire when the unit is being used, serviced, or disposed of.

Correct refrigerant is specified in the manuals and on the spec labels provided with our products.

We will not be held responsible for mechanical failure, system malfunction, unit breakdown or accidents caused by failure to follow the instructions.

<Preparation before the repair service>

- Prepare the proper tools.
- Prepare the proper protectors.
- Provide adequate ventilation.
- After stopping the operation of the air conditioner, turn off the power-supply breaker and remove the power plug.
- Discharge the capacitor before the work involving the electric parts.

<Precautions during the repair service>

- Do not perform the work involving the electric parts with wet hands.
- Do not pour water into the electric parts.
- Do not touch the refrigerant.
- Do not touch the hot or cold areas in the refrigeration cycle.
- When the repair or the inspection of the circuit needs to be done without turning off the power, exercise great caution not to touch the live parts.

Revision A:

- MXZ-2C30VA- [E1], MXZ-2C40VA- [E1], and MXZ-2C52VA- [E1] have been added.

Revision B:

- MXZ-6C120VA- [E2] has been added.
- FAILURE MODE RECALL FUNCTION has been corrected.

Revision C:

- MXZ-4C80VA2- [E1] and MXZ-5C100VA2- [E1] have been added.

Revision D:

- MXZ-6C122VA- [E1] has been added.

Revision E:

- INDOOR UNITS COMBINATION SHEETS for MXZ-6C122VA- [E1] have been added.

MXZ-3B54VA -[E1] → MXZ-3C54VA -[E1]

MXZ-3B68VA -[E1] → MXZ-3C68VA -[E1]

MXZ-4B71VA -[E1] → MXZ-4C71VA -[E1]

MXZ-4B80VA -[E1] → MXZ-4C80VA -[E1]

MXZ-5A100VA -[E1] → MXZ-5C100VA -[E1]

1. Indoor units combinations have been added (MSZ-EF Series).
2. Outdoor fan motor has been changed.

MXZ-6C120VA -[E1]

1. New model

MXZ-2B30VA -[E1] → MXZ-2C30VA -[E1]

1. Indoor units combinations have been added (MSZ-EF Series).
2. Muffler has been added.

MXZ-2B40VA -[E1] → MXZ-2C40VA -[E1]

1. Indoor units combinations have been added (MSZ-EF Series).
2. Muffler has been added.

MXZ-2B52VA -[E1] → MXZ-2C52VA -[E1]

1. Indoor units combinations have been added (MSZ-EF Series).
2. Muffler has been added.

MXZ-6C120VA -[E1] → MXZ-6C120VA -[E2]

1. Accumulator has been added.
2. Power receiver has been removed.
3. Model name of compressor has been changed.
4. Control P.C. board has been changed.

MXZ-4C80VA -[E1] → MXZ-4C80VA2 -[E1]

1. Front panel has been changed.
2. Grille has been changed.
3. Grille roof has been added.
4. Service panel has been changed.
5. Base has been changed.
6. Rear guard has been changed.
7. Drain socket has been changed.
8. Unit size has been changed. (W x H x D: 900 x 900 x 320 → 900 x 915 x 320)
9. Weight of the unit has been changed. (67 kg → 69 kg)

MXZ-5C100VA -[E1] → MXZ-5C100VA2 -[E1]

1. Front panel has been changed.
2. Grille has been changed.
3. Grille roof has been added.
4. Service panel has been changed.
5. Base has been changed.
6. Rear guard has been changed.
7. Drain socket has been changed.
8. Unit size has been changed. (W x H x D: 900 x 900 x 320 → 900 x 915 x 320)
9. Weight of the unit has been changed. (68 kg → 70 kg)

MXZ-6C120VA -[E2] → MXZ-6C122VA -[E1]

1. Outdoor control P.C. board has been changed.

PART NAMES AND FUNCTIONS

MXZ-2C30VA
MXZ-2C40VA
MXZ-2C52VA

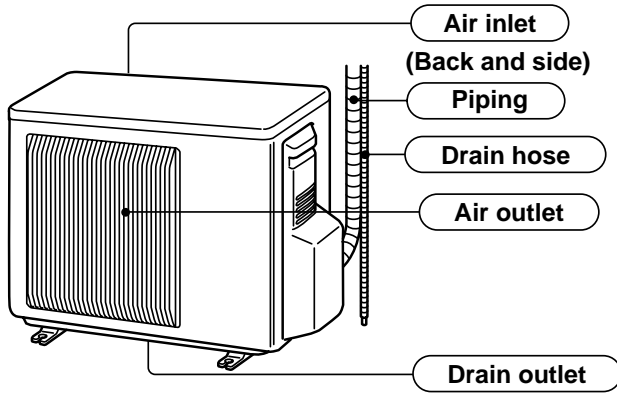

MXZ-3C54VA
MXZ-3C68VA
MXZ-4C71VA

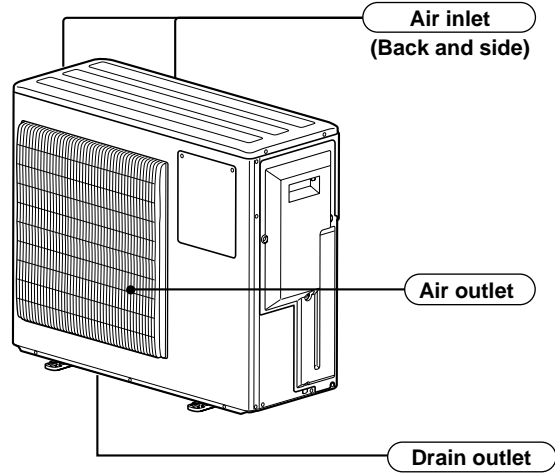

MXZ-4C80VA
MXZ-5C100VA

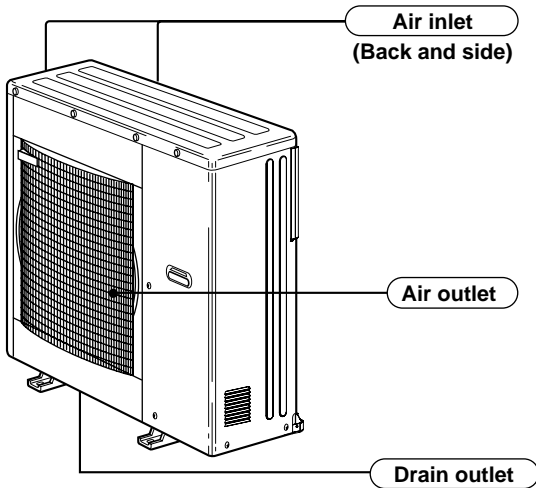

MXZ-4C80VA2
MXZ-5C100VA2

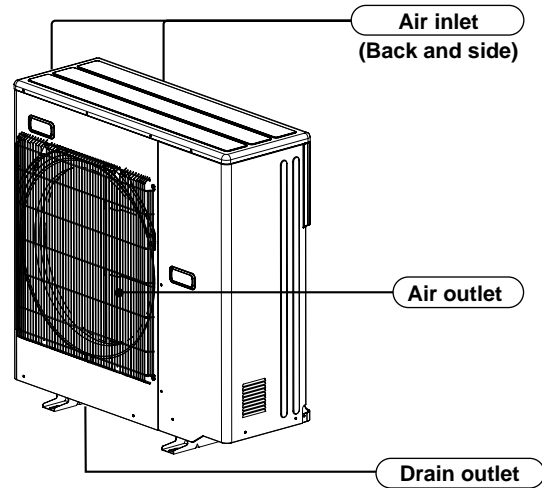

MXZ-6C120VA
MXZ-6C122VA

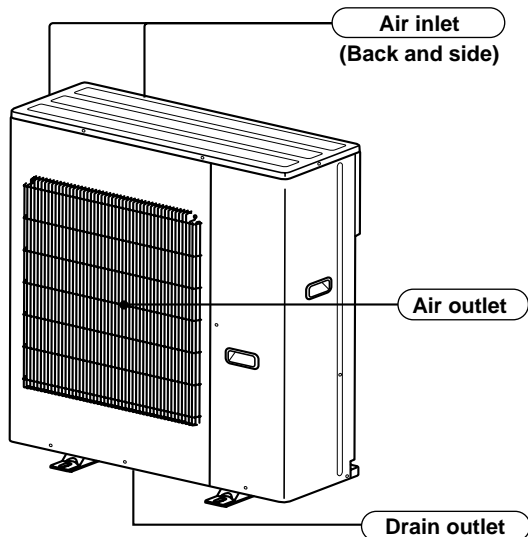

ACCESSORIES

①	Drain socket	1
②	Drain cap (MXZ-3C/4C/5C)	2

3

SPECIFICATION

Outdoor model			MXZ-2C30VA	
Outdoor unit power supply			Single phase 230 V, 50 Hz	
System	Indoor units number		1 to 2	
	Piping total length	m	Max. 20	
	Connecting pipe length	m	Max. 15	
	Height difference (Indoor ~ Outdoor)	m	Refer to 7 REFRIGERANT SYSTEM DIAGRAM.	
	Height difference (Indoor ~ Indoor)	m	Refer to 7 REFRIGERANT SYSTEM DIAGRAM.	
Function			Cooling	Heating
Capacity	Capacity [Rated (Min.-Max.) Hz]	kW	3.0 (1.1 - 4.0)	4.0 (1.0 - 4.4)
	Dehumidification	ℓ/h	—	—
	Outdoor air flow	m ³ /h	1,974	1,878
*2 Electrical data	Breaker capacity	A	10	
	Running current *1	A	2.71	3.94
	Power input *1	W	560	815
	Power factor *1	%	90	
	Starting current *1	A	3.94	
	Compressor motor current *1	A	2.36	3.59
	Fan motor current *1	A	0.35	
Coefficient of performance(C.O.P)*1 *2			5.36	4.91
Compressor	Model		KNB073FGDHC	
	Output	W	750	
	Winding resistance (at 20 °C)	Ω	U-V 1.70 V-W 1.70 W-U 1.70	
Fan motor	Model		RC0J50-CF	
	Winding resistance (at 20 °C)	Ω	BLK-WHT 14.2 WHT-RED 14.2 RED-BLK 14.2	
Dimensions W x H x D		mm	800 x 550 x 285	
Weight		kg	33	
Special remarks	Sound level (High)	dB	46	47
	Fan speed (High)	rpm	860	820
	Refrigerant filling capacity (R410A)	kg	1.15	
	Refrigeration oil (Model)	L	0.32 (NEO22)	

*1 Measured under rated operating frequency.

*2 Electrical data is for only outdoor unit.

NOTE: Test conditions are based on ISO 5151. (Refrigerant piping length (one way): 5 m)

COOLING INDOOR Dry-bulb temperature 27.0°C Wet-bulb temperature 19.0°C

OUTDOOR Dry-bulb temperature 35.0°C Wet-bulb temperature 24.0°C

HEATING INDOOR Dry-bulb temperature 20.0°C

OUTDOOR Dry-bulb temperature 7.0°C Wet-bulb temperature 6.0°C



Outdoor model			MXZ-2C40VA	
Outdoor unit power supply			Single phase 230 V, 50 Hz	
System	Indoor units number		1 to 2	
	Piping total length	m	Max. 30	
	Connecting pipe length	m	Max. 20	
	Height difference (Indoor ~ Outdoor)	m	Refer to 7 REFRIGERANT SYSTEM DIAGRAM.	
	Height difference (Indoor ~ Indoor)	m	Refer to 7 REFRIGERANT SYSTEM DIAGRAM.	
Function			Cooling	Heating
Capacity	Capacity [Rated (Min.-Max.) Hz]	kW	4.0 (1.1 - 4.5)	4.5 (1.0 - 5.0)
	Dehumidification	ℓ/h	—	—
	Outdoor air flow	m ³ /h	1,752	1,596
*2 Electrical data	Breaker capacity	A	15	
	Running current *1	A	4.00	3.98
	Power input *1	W	875	870
	Power factor *1	%	95	
	Starting current *1	A	4.00	
	Compressor motor current *1	A	3.65	3.60
	Fan motor current *1	A	0.35	
Coefficient of performance(C.O.P) *1 *2			4.57	5.17
Compressor	Model		KNB092FFDHC	
	Output	W	1,100	
	Winding resistance (at 20 °C)	Ω	U-V 1.70 V-W 1.70 W-U 1.70	
Fan motor	Model		RC0J50-CF	
	Winding resistance (at 20 °C)	Ω	BLK-WHT 14.2 WHT-RED 14.2 RED-BLK 14.2	
Dimensions W x H x D		mm	800 x 550 x 285	
Weight		kg	35	
Special remarks	Sound level	dB	47	48
	Fan speed	rpm	840	770
	Refrigerant filling capacity (R410A)	kg	1.3	
	Refrigeration oil (Model)	L	0.32 (NEO22)	

*1 Measured under rated operating frequency.

*2 Electrical data is for only outdoor unit.

NOTE: Test conditions are based on ISO 5151. (Refrigerant piping length (one way): 5 m)

COOLING INDOOR Dry-bulb temperature 27.0°C Wet-bulb temperature 19.0°C

OUTDOOR Dry-bulb temperature 35.0°C Wet-bulb temperature 24.0°C

HEATING INDOOR Dry-bulb temperature 20.0°C

OUTDOOR Dry-bulb temperature 7.0°C Wet-bulb temperature 6.0°C



Outdoor model			MXZ-2C52VA	
Outdoor unit power supply			Single phase 230 V, 50 Hz	
System	Indoor units number		1 to 2	
	Piping total length	m	Max. 30	
	Connecting pipe length	m	Max. 20	
	Height difference (Indoor ~ Outdoor)	m	Refer to 7 REFRIGERANT SYSTEM DIAGRAM.	
	Height difference (Indoor ~ Indoor)	m	Refer to 7 REFRIGERANT SYSTEM DIAGRAM.	
Function			Cooling	Heating
Capacity	Capacity [Rated (Min.-Max.) Hz]	kW	5.2 (1.1 - 6.0)	6.4 (1.0 - 7.0)
	Dehumidification	ℓ/h	—	—
	Outdoor air flow	m ³ /h	1,974	1,998
*2 Electrical data	Breaker capacity	A	15	
	Running current *1	A	5.83	7.22
	Power input *1	W	1,300	1,610
	Power factor *1	%	97	
	Starting current *1	A	7.22	
	Compressor motor current *1	A	5.48	6.87
	Fan motor current *1	A	0.35	
Coefficient of performance(C.O.P) *1 *2			4.00	3.98
Compressor	Model		SNB130FGBHT	
	Output	W	1,400	
	Winding resistance (at 20 °C)	Ω	U-V 0.98 V-W 0.98 W-U 0.98	
Fan motor	Model		RC0J50-CF	
	Winding resistance (at 20 °C)	Ω	BLK-WHT 14.2 WHT-RED 14.2 RED-BLK 14.2	
Dimensions W x H x D		mm	800 x 550 x 285	
Weight		kg	38	
Special remarks	Sound level (High/Low)	dB	49	50
	Fan speed (High/Low)	rpm	900	910
	Refrigerant filling capacity (R410A)	kg	1.3	
	Refrigeration oil (Model)	L	0.45 (NEO22)	

*1 Measured under rated operating frequency.

*2 Electrical data is for only outdoor unit.

NOTE: Test conditions are based on ISO 5151. (Refrigerant piping length (one way): 5 m)

COOLING INDOOR Dry-bulb temperature 27.0°C Wet-bulb temperature 19.0°C

OUTDOOR Dry-bulb temperature 35.0°C Wet-bulb temperature 24.0°C

HEATING INDOOR Dry-bulb temperature 20.0°C

OUTDOOR Dry-bulb temperature 7.0°C Wet-bulb temperature 6.0°C



Outdoor model			MXZ-3C54VA	
Outdoor unit power supply			Single phase 230 V, 50 Hz	
System	Indoor units number		1 to 3	
	Piping total length	m	Max. 50	
	Connecting pipe length	m	Max. 25	
	Height difference (Indoor ~ Outdoor)	m	Refer to 7 REFRIGERANT SYSTEM DIAGRAM.	
	Height difference (Indoor ~ Indoor)	m	Refer to 7 REFRIGERANT SYSTEM DIAGRAM.	
Function			Cooling	Heating
Capacity	Capacity [Rated (Min.-Max.) Hz]	kW	5.4 (2.9-6.8)	7.0 (2.6-9.0)
	Dehumidification	ℓ/h	—	—
	Outdoor air flow	m ³ /h	2,526	2,580
*2 Electrical data	Breaker capacity	A	25	
	Running current *1	A	5.23	6.43
	Power input *1	W	1,190	1,465
	Power factor *1	%	99	
	Starting current *1	A	6.43	
	Compressor motor current *1	A	5.03	6.23
	Fan motor current *1	A	0.2	
Coefficient of performance(C.O.P) *1 *2			4.54	4.78
Compressor	Model		SNB130FGBH1T	
	Output	W	1,400	
	Winding resistance (at 20 °C)	Ω	U-V 0.98 V-W 0.98 W-U 0.98	
Fan motor	Model		RC0J60-CB	
	Winding resistance (at 20°C)	Ω	BLK-WHT 15.2 WHT-RED 15.2 RED-BLK 15.2	
Dimensions W x H x D		mm	840 x 710 x 330	
Weight		kg	57	
Special remarks	Sound level	dB	47	51
	Fan speed	rpm	650	660
	Refrigerant filling capacity (R410A)	kg	2.7	
	Refrigeration oil (Model)	L	0.7 (NEO22)	

*1 Measured under rated operating frequency.

*2 Electrical data is for only outdoor unit.

NOTE: Test conditions are based on ISO 5151. (Refrigerant piping length (one way): 5 m)

COOLING INDOOR Dry-bulb temperature 27.0°C Wet-bulb temperature 19.0°C

OUTDOOR Dry-bulb temperature 35.0°C Wet-bulb temperature 24.0°C

HEATING INDOOR Dry-bulb temperature 20.0°C

OUTDOOR Dry-bulb temperature 7.0°C Wet-bulb temperature 6.0°C



Outdoor model			MXZ-3C68VA	
Outdoor unit power supply			Single phase 230 V, 50 Hz	
System	Indoor units number		1 to 3	
	Piping total length	m	Max. 60	
	Connecting pipe length	m	Max. 25	
	Height difference (Indoor ~ Outdoor)	m	Refer to 7 REFRIGERANT SYSTEM DIAGRAM.	
	Height difference (Indoor ~ Indoor)	m	Refer to 7 REFRIGERANT SYSTEM DIAGRAM.	
Function			Cooling	Heating
Capacity	Capacity [Rated (Min.-Max.) Hz]	kW	6.8 (2.9-8.4)	8.6 (2.6-10.6)
	Dehumidification	ℓ/h	—	—
	Outdoor air flow	m ³ /h	2,526	2,580
*2 Electrical data	Breaker capacity	A	25	
	Running current *1	A	7.80	9.00
	Power input *1	W	1,775	2,050
	Power factor *1	%	99	
	Starting current *1	A	9.00	
	Compressor motor current *1	A	7.60	8.80
	Fan motor current *1	A	0.2	
Coefficient of performance(C.O.P) *1 *2			3.83	4.20
Compressor	Model		SNB172FEGH1T	
	Output	W	1,800	
	Winding resistance (at 20 °C)	Ω	U-V 0.72 V-W 0.72 W-U 0.72	
Fan motor	Model		RC0J60-CB	
	Winding resistance (at 20°C)	Ω	BLK-WHT 15.2 WHT-RED 15.2 RED-BLK 15.2	
Dimensions W x H x D		mm	840 x 710 x 330	
Weight		kg	57	
Special remarks	Sound level	dB	48	52
	Fan speed	rpm	650	660
	Refrigerant filling capacity (R410A)	kg	2.7	
	Refrigeration oil (Model)	L	0.7 (NEO22)	

*1 Measured under rated operating frequency.

*2 Electrical data is for only outdoor unit.

NOTE: Test conditions are based on ISO 5151. (Refrigerant piping length (one way): 5 m)

COOLING INDOOR Dry-bulb temperature 27.0°C Wet-bulb temperature 19.0°C

OUTDOOR Dry-bulb temperature 35.0°C Wet-bulb temperature 24.0°C

HEATING INDOOR Dry-bulb temperature 20.0°C

OUTDOOR Dry-bulb temperature 7.0°C Wet-bulb temperature 6.0°C



Outdoor model			MXZ-4C71VA	
Outdoor unit power supply			Single phase 230 V, 50 Hz	
System	Indoor units number		1 to 4	
	Piping total length	m	Max. 60	
	Connecting pipe length	m	Max. 25	
	Height difference (Indoor ~ Outdoor)	m	Refer to 7 REFRIGERANT SYSTEM DIAGRAM.	
	Height difference (Indoor ~ Indoor)	m	Refer to 7 REFRIGERANT SYSTEM DIAGRAM.	
Function			Cooling	Heating
Capacity	Capacity [Rated (Min.-Max.) Hz]	kW	7.1 (3.7-8.8)	8.6 (3.4-10.7)
	Dehumidification	ℓ/h	—	—
	Outdoor air flow	m ³ /h	2,526	2,580
*2 Electrical data	Breaker capacity	A	25	
	Running current *1	A	7.38	7.49
	Power input *1	W	1,680	1,705
	Power factor *1	%	99	
	Starting current *1	A	7.49	
	Compressor motor current *1	A	7.18	7.29
	Fan motor current *1	A	0.2	
Coefficient of performance(C.O.P) *1 *2			4.23	5.04
Compressor	Model		SNB172FEGH1T	
	Output	W	2,000	
	Winding resistance (at 20 °C)	Ω	U-V 0.72 V-W 0.72 W-U 0.72	
Fan motor	Model		RC0J60-CB	
	Winding resistance (at 20°C)	Ω	BLK-WHT 15.2 WHT-RED 15.2 RED-BLK 15.2	
Dimensions W x H x D		mm	840 x 710 x 330	
Weight		kg	58	
Special remarks	Sound level	dB	48	52
	Fan speed	rpm	650	660
	Refrigerant filling capacity (R410A)	kg	2.7	
	Refrigeration oil (Model)	L	0.7 (NEO22)	

*1 Measured under rated operating frequency.

*2 Electrical data is for only outdoor unit.

NOTE: Test conditions are based on ISO 5151. (Refrigerant piping length (one way): 5 m)

COOLING INDOOR Dry-bulb temperature 27.0°C Wet-bulb temperature 19.0°C

OUTDOOR Dry-bulb temperature 35.0°C Wet-bulb temperature 24.0°C

HEATING INDOOR Dry-bulb temperature 20.0°C

OUTDOOR Dry-bulb temperature 7.0°C Wet-bulb temperature 6.0°C



Outdoor model			MXZ-4C80VA MXZ-4C80VA2	
Outdoor unit power supply			Single phase 230 V, 50 Hz	
System	Indoor units number		1 to 4	
	Piping total length	m	Max. 70	
	Connecting pipe length	m	Max. 25	
	Height difference (Indoor ~ Outdoor)	m	Refer to 7 REFRIGERANT SYSTEM DIAGRAM.	
	Height difference (Indoor ~ Indoor)	m	Refer to 7 REFRIGERANT SYSTEM DIAGRAM.	
Function			Cooling	Heating
Capacity	Capacity [Rated (Min.-Max.) Hz]	kW	8.0 (3.7-9.2)	9.4 (3.4-11.6)
	Dehumidification	ℓ/h	—	—
	Outdoor air flow	m ³ /h	2,526	2,628
*2 Electrical data	Breaker capacity	A	25	
	Running current *1	A	8.59	8.48
	Power input *1	W	1,955	1,930
	Power factor *1	%	99	
	Starting current *1	A	8.59	
	Compressor motor current *1	A	8.39	8.28
	Fan motor current *1	A	0.2	
Coefficient of performance(C.O.P) *1 *2			4.09	4.87
Compressor	Model		TNB220FMCH	
	Output	W	2,100	
	Winding resistance (at 20 °C)	Ω	U-V 1.41 V-W 1.41 W-U 1.41	
Fan motor	Model		RC0J60-CA	
	Winding resistance (at 20°C)	Ω	BLK-WHT 15.2 WHT-RED 15.2 RED-BLK 15.2	
Dimensions W x H x D		mm	4C80VA	900 x 900 x 320
			4C80VA2	900 x 915 x 320
Weight		kg	4C80VA	67
			4C80VA2	69
Special remarks	Sound level	dB	46	48
	Fan speed	rpm	560	580
	Refrigerant filling capacity (R410A)	kg	3.5	
	Refrigeration oil (Model)	L	0.87 (NEO22)	

*1 Measured under rated operating frequency.

*2 Electrical data is for only outdoor unit.

NOTE: Test conditions are based on ISO 5151. (Refrigerant piping length (one way): 5 m)

COOLING INDOOR Dry-bulb temperature 27.0°C Wet-bulb temperature 19.0°C

OUTDOOR Dry-bulb temperature 35.0°C Wet-bulb temperature 24.0°C

HEATING INDOOR Dry-bulb temperature 20.0°C

OUTDOOR Dry-bulb temperature 7.0°C Wet-bulb temperature 6.0°C



Outdoor model			MXZ-5C100VA MXZ-5C100VA2	
Outdoor unit power supply			Single phase 230 V, 50 Hz	
System	Indoor units number		1 to 5	
	Piping total length	m	Max. 80	
	Connecting pipe length	m	Max. 25	
	Height difference (Indoor ~ Outdoor)	m	Refer to 7 REFRIGERANT SYSTEM DIAGRAM.	
	Height difference (Indoor ~ Indoor)	m	Refer to 7 REFRIGERANT SYSTEM DIAGRAM.	
Function			Cooling	Heating
Capacity	Capacity [Rated (Min.-Max.) Hz]	kW	10.0 (3.9 - 11.0)	12.0 (4.1 - 14.0)
	Dehumidification	ℓ/h	—	—
	Outdoor air flow	m ³ /h	3,396	3,558
*2 Electrical data	Breaker capacity	A	25	
	Running current *1	A	12.30	12.45
	Power input *1	W	2,800	2,835
	Power factor *1	%	99	
	Starting current *1	A	12.45	
	Compressor motor current	A	12.1	12.25
	Fan motor current	A	0.2	
Coefficient of performance(C.O.P) *1 *2			3.57	4.23
Compressor	Model		TNB220FMCH	
	Output	W	2,700	
	Winding resistance(at 20 °C)	Ω	U-V 1.41 V-W 1.41 W-U 1.41	
Fan motor	Model		RC0J60-CA	
	Winding resistance(at 20 °C)	Ω	BLK-WHT 15.2 WHT-RED 15.2 RED-BLK 15.2	
Dimensions W x H x D		mm	5C100VA 900 x 900 x 320	5C100VA2 900 x 915 x 320
Weight		kg	5C100VA 68	5C100VA2 70
Special remarks	Sound level	dB	51	54
	Fan speed	rpm	720	750
	Refrigerant filling capacity(R410A)	kg	4.0	
	Refrigeration oil (Model)	L	0.87 (NEO22)	

*1 Measured under rated operating frequency.

*2 Electrical data is for only outdoor unit.

NOTE: Test conditions are based on ISO 5151. (Refrigerant piping length (one way): 5 m)

COOLING INDOOR Dry-bulb temperature 27.0°C Wet-bulb temperature 19.0°C

OUTDOOR Dry-bulb temperature 35.0°C Wet-bulb temperature 24.0°C

HEATING INDOOR Dry-bulb temperature 20.0°C

OUTDOOR Dry-bulb temperature 7.0°C Wet-bulb temperature 6.0°C



Outdoor model			MXZ-6C120VA			
Outdoor unit power supply			Single phase 230 V, 50 Hz			
System	Indoor units number		2 to 6			
	Piping total length	m	Max. 80			
	Connecting pipe length	m	Max. 25			
	Height difference (Indoor ~ Outdoor)	m	Refer to 7 REFRIGERANT SYSTEM DIAGRAM.			
	Height difference (Indoor ~ Indoor)	m	Refer to 7 REFRIGERANT SYSTEM DIAGRAM.			
Function			Cooling	Heating		
Capacity	Capacity [Rated (Min.-Max.) Hz]	kW	12.0 (3.5 - 13.5)		14.0 (3.5 - 16.5)	
	Dehumidification	ℓ/h	—		—	
	Outdoor air flow	m ³ /h	E1	3,324	4,194	
E2			3,570			
*2 Electrical data	Breaker capacity	A	32			
	Running current *1	A	15.85	15.24		
	Power input *1	W	3,610	3,470		
	Power factor *1	%	99			
	Starting current *1	A	15.85			
	Compressor motor current	A	15.55	14.94		
	Fan motor current	A	0.3			
Coefficient of performance(C.O.P) *1 *2			3.32	4.03		
Compressor	Model		E1	TNB306FPGM3		
			E2	TNB306FPGM2		
	Output	W	3,000			
Fan motor	Winding resistance(at 20 °C)	Ω	U-V 0.53 V-W 0.53 W-U 0.53			
	Model		SIC-81FW-D888			
Dimensions W x H x D		mm	900 x 1,070 x 320			
Weight	kg	E1	88			
		E2	87			
Special remarks	Sound level	dB	55		57	
	Fan speed	rpm	E1	590		
			E2	630		
	Refrigerant filling capacity(R410A)	kg	E1	5.0		
			E2	4.8		
	Refrigeration oil (Model)	L	E1	1.61 (FV50S)		
E2			1.07 (FV50S)			

*1 Measured under rated operating frequency.

*2 Electrical data is for only outdoor unit.

NOTE: Test conditions are based on ISO 5151. (Refrigerant piping length (one way): 5 m)

COOLING INDOOR Dry-bulb temperature27.0°C Wet-bulb temperature 19.0°C

OUTDOOR Dry-bulb temperature35.0°C Wet-bulb temperature 24.0°C

HEATING INDOOR Dry-bulb temperature20.0°C

OUTDOOR Dry-bulb temperature7.0°C Wet-bulb temperature 6.0°C



Outdoor model			MXZ-6C122VA	
Outdoor unit power supply			Single phase 230 V, 50 Hz	
System	Indoor units number		2 to 6	
	Piping total length	m	Max. 80	
	Connecting pipe length	m	Max. 25	
	Height difference (Indoor ~ Outdoor)	m	Refer to 7 REFRIGERANT SYSTEM DIAGRAM.	
	Height difference (Indoor ~ Indoor)	m	Refer to 7 REFRIGERANT SYSTEM DIAGRAM.	
Function			Cooling	Heating
Capacity Rated frequency (Min.-Max.) *2		kW	12.2 (3.5 - 13.5)	14.0 (3.5 - 16.5)
Breaker capacity		A	32	
Electrical data	Power input (Total) *1, *2	W	4,050	3,810
	Running current (Total) *1, *2	A	17.8	16.7
	Power factor (Total) *1, *2	%	99	
	Starting current (Total) *1, *2	A	4.6	
Coefficient of performance (C.O.P) (Total) *1, *2			3.01	3.67
Compressor	Model		TNB306FPGM2	
	Output	W	3,000	
	Current *1, *2	A	17.12	15.72
	Refrigeration oil (Model)	L	1.07 (FV50S)	
Fan motor	Model		SIC-81FW-D888-1	
	Current *1, *2	A	0.3	
Dimensions W x H x D		mm	900 x 1,070 x 320	
Weight		kg	87	
Special remarks	Air flow (Rated)	m ³ /h	3,570	4,194
	Sound level (Rated)	dB(A)	55	57
	Fan speed (Rated)	rpm	630	670
	Refrigerant filling capacity (R410A)	kg	4.8	

*1 Measured under rated operating frequency.

*2 When connected with below indoor units.

MSZ-EF25VE x 6

NOTE: Test conditions are based on ISO 5151. (Refrigerant piping length (one way): 5 m)

COOLING INDOOR Dry-bulb temperature 27.0 °C Wet-bulb temperature 19.0 °C

OUTDOOR Dry-bulb temperature 35.0 °C Wet-bulb temperature 24.0 °C

HEATING INDOOR Dry-bulb temperature 20.0 °C

OUTDOOR Dry-bulb temperature 7.0 °C Wet-bulb temperature 6.0 °C

4

NOISE CRITERIA CURVES

MXZ-2C30VA

FAN SPEED	FUNCTION	SPL(dB(A))	LINE
High	Cooling	46	●—●
High	Heating	47	○—○

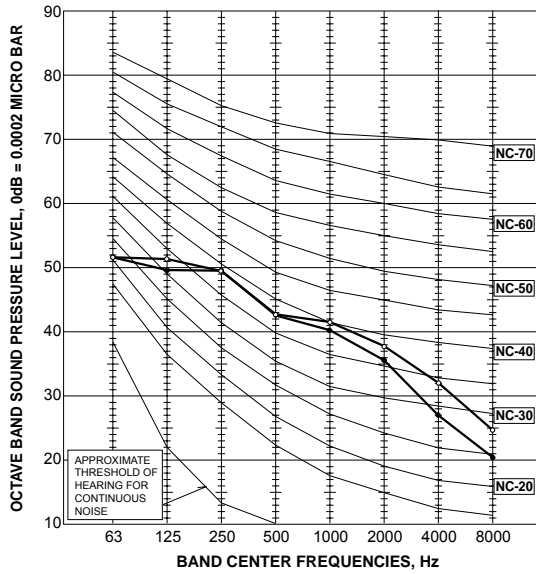

MXZ-2C40VA

FAN SPEED	FUNCTION	SPL(dB(A))	LINE
High	Cooling	47	●—●
High	Heating	48	○—○

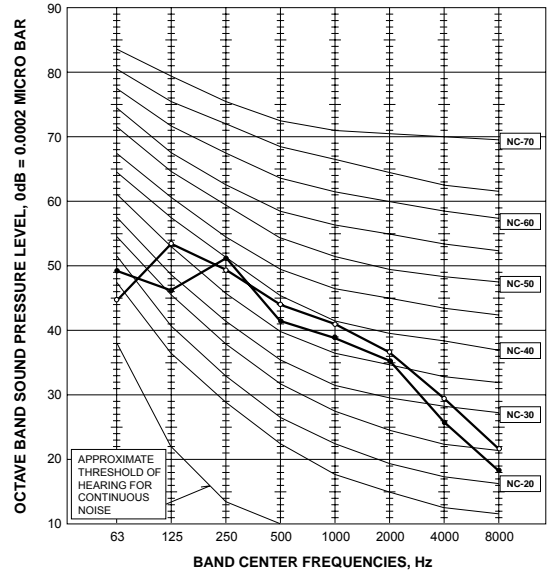

MXZ-2C52VA

FAN SPEED	FUNCTION	SPL(dB(A))	LINE
High	Cooling	49	●—●
High	Heating	50	○—○

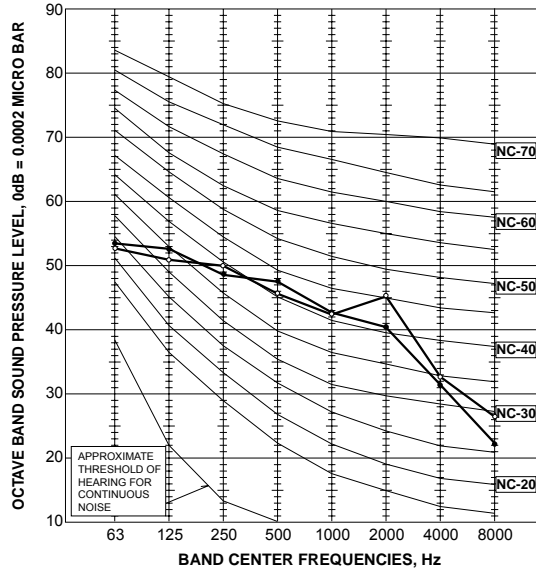

MXZ-3C54VA

FAN SPEED	FUNCTION	SPL(dB(A))	LINE
High	Cooling	47	●—●
High	Heating	51	○—○

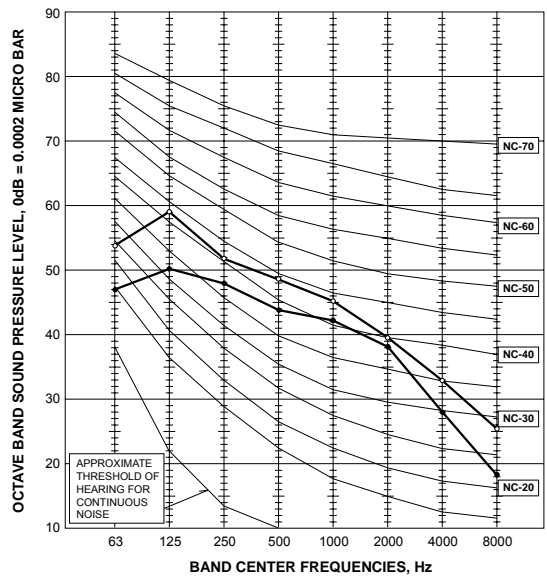

MXZ-3C68VA

FAN SPEED	FUNCTION	SPL(dB(A))	LINE
High	Cooling	48	●—●
High	Heating	52	○—○

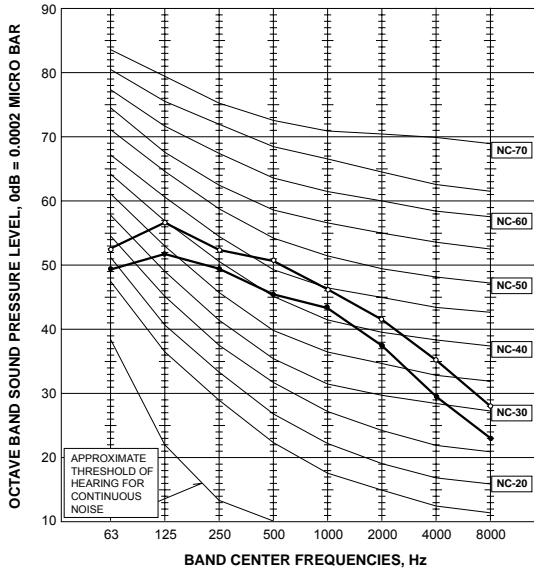

MXZ-4C71VA

FAN SPEED	FUNCTION	SPL(dB(A))	LINE
High	Cooling	48	●—●
High	Heating	52	○—○

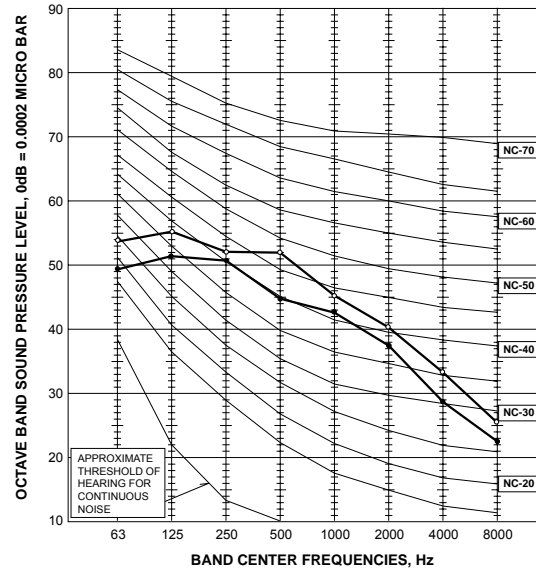

MXZ-4C80VA MXZ-4C80VA2

FAN SPEED	FUNCTION	SPL(dB(A))	LINE
High	Cooling	46	●—●
High	Heating	48	○—○

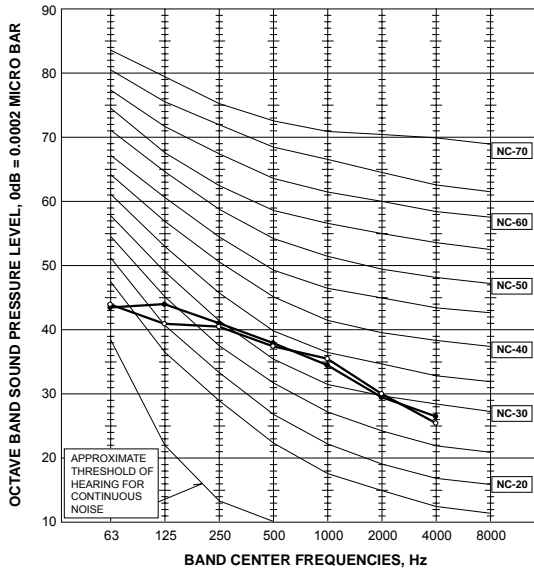

MXZ-5C100VA MXZ-5C100VA2

FAN SPEED	FUNCTION	SPL(dB(A))	LINE
High	Cooling	51	●—●
High	Heating	54	○—○

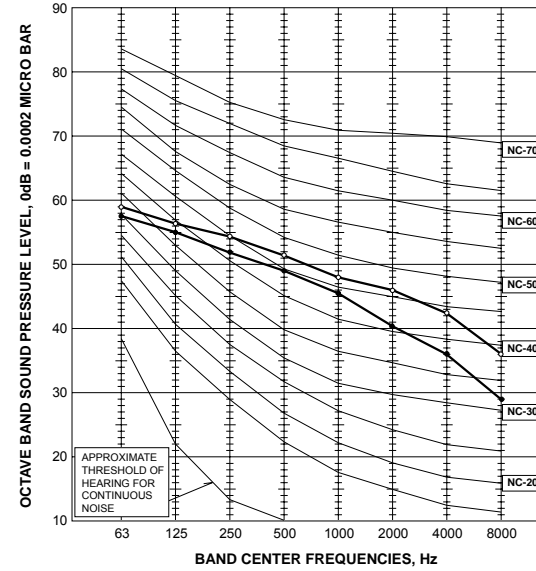

MXZ-6C120VA

FAN SPEED	FUNCTION	SPL(dB(A))	LINE
High	Cooling	55	●—●
High	Heating	57	○—○

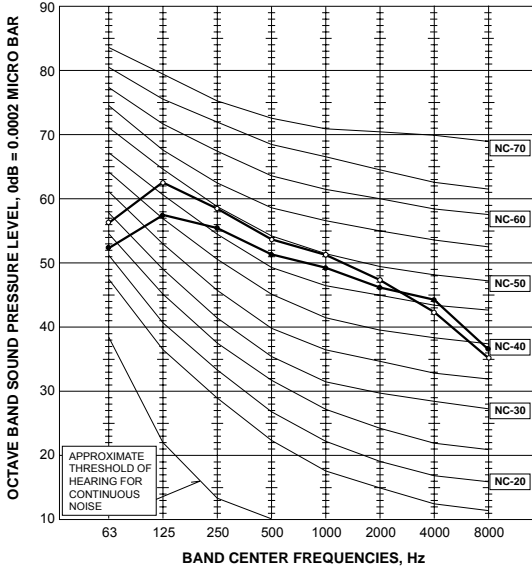

MXZ-6C122VA

FAN SPEED	FUNCTION	SPL(dB(A))	LINE
High	Cooling	55	●—●
High	Heating	57	○—○

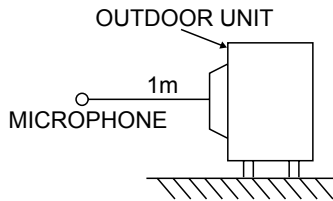
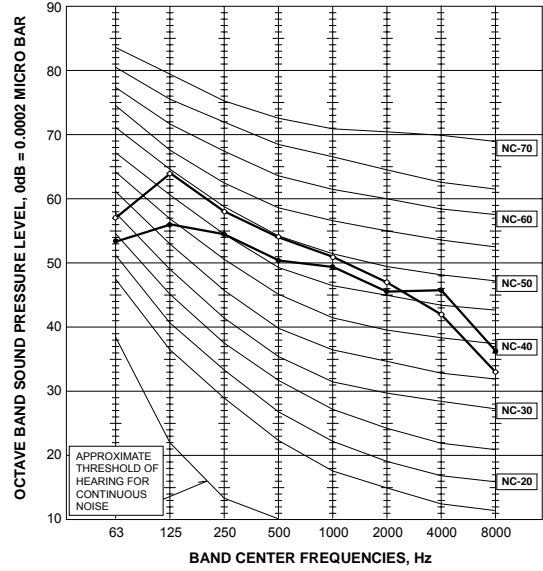

Test conditions

Cooling :Dry-bulb temperature 35°C Wet-bulb temperature 24°C
 Heating :Dry-bulb temperature 7°C Wet-bulb temperature 6°C

MXZ-2C30VA MXZ-2C40VA MXZ-2C52VA

Unit: mm

REQUIRED SPACE

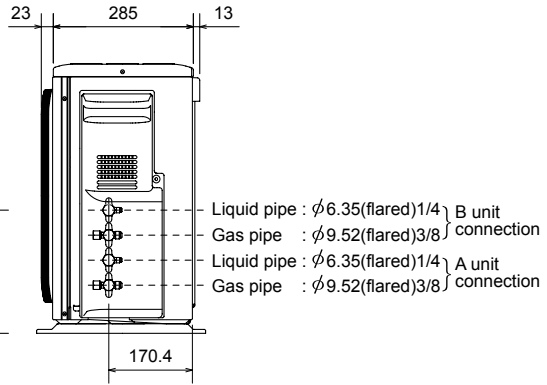
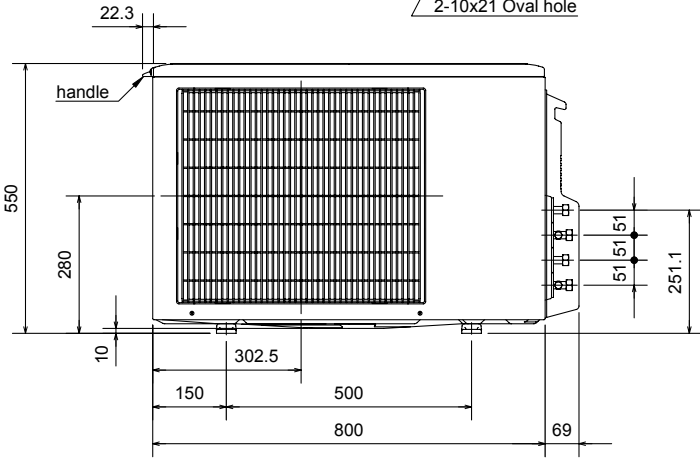
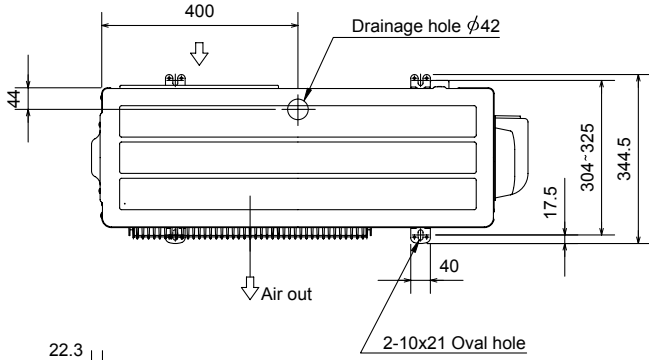
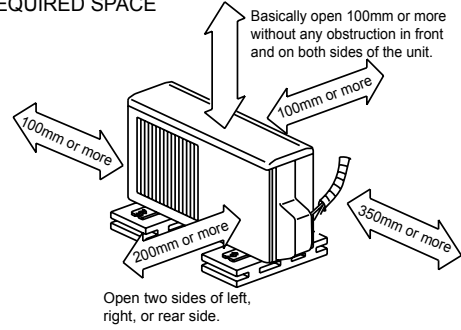

MXZ-3C54VA MXZ-3C68VA

Unit: mm

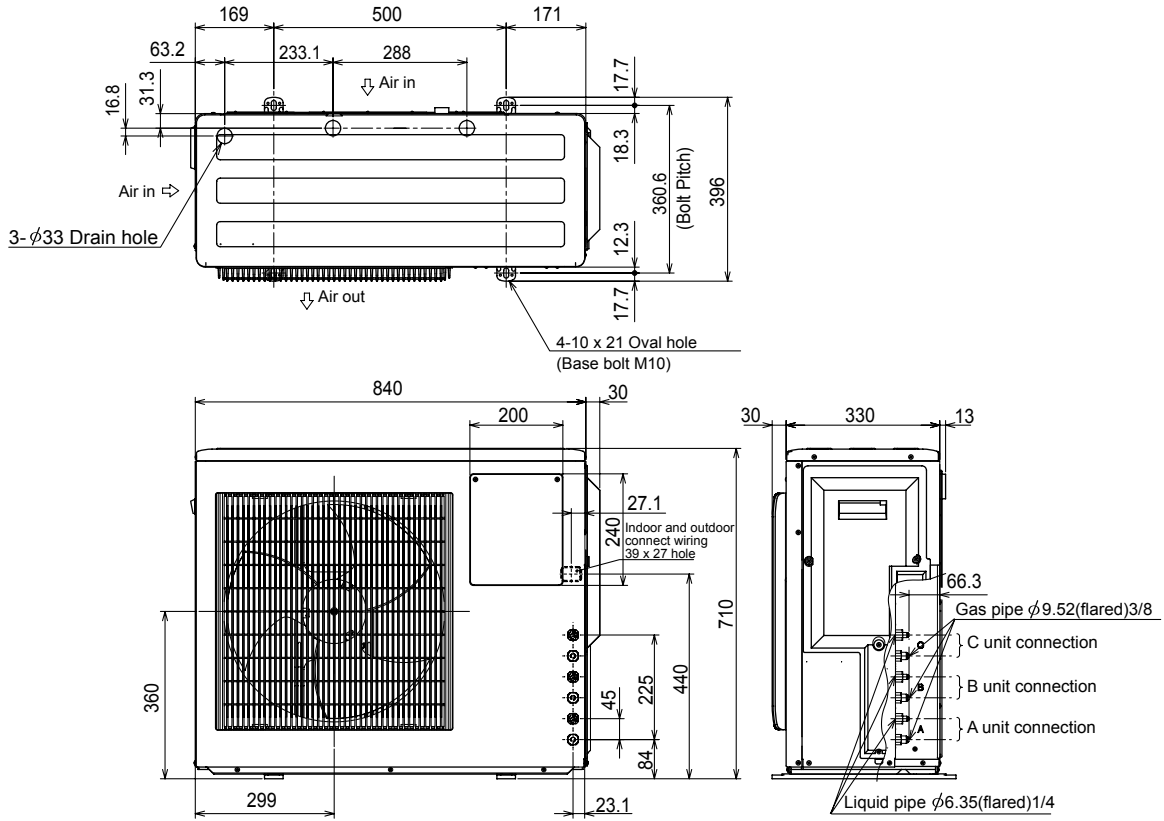

1. Installation space

Note : Leave front and both sides free of obstruction.

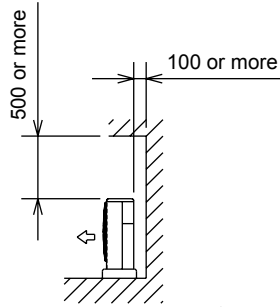

Note : Leave front and overhead free of obstruction.

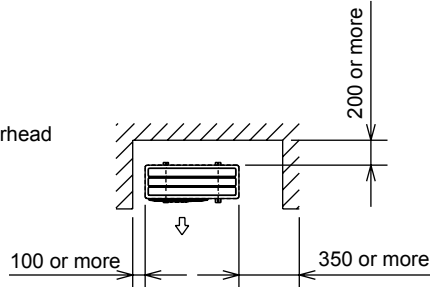

Note : Leave rear, overhead and both sides free of obstruction.

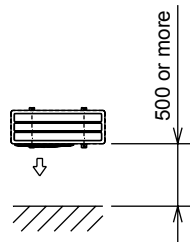

2. Service space

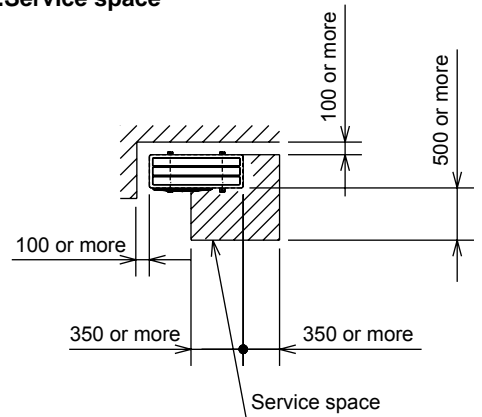

MXZ-4C71VA

Unit: mm

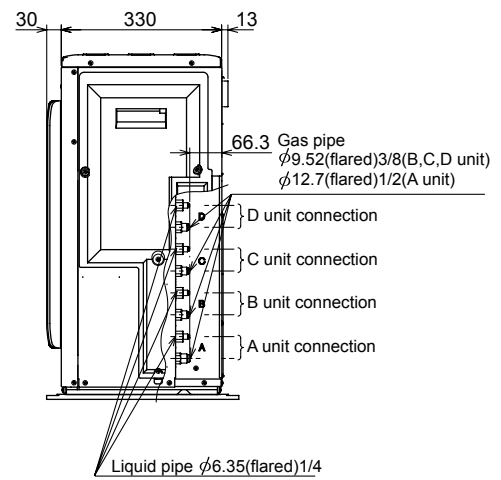
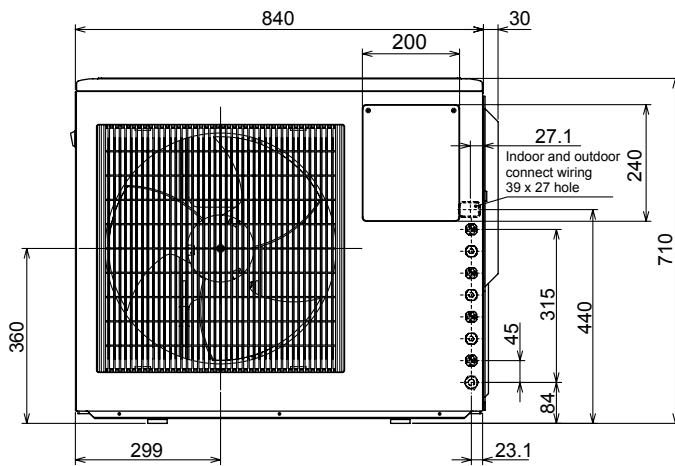
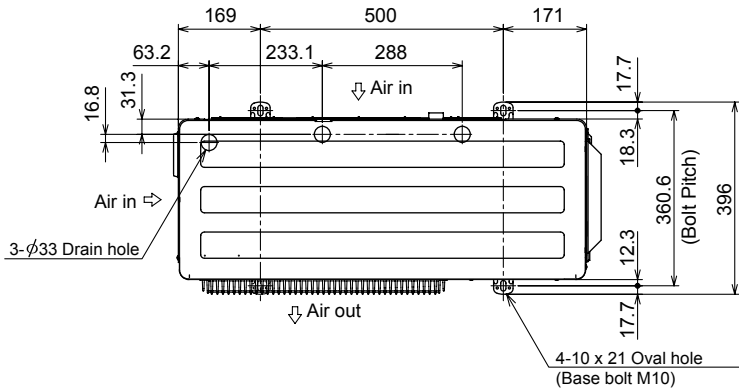

1. Installation space

Note : Leave front and both sides free of obstruction.

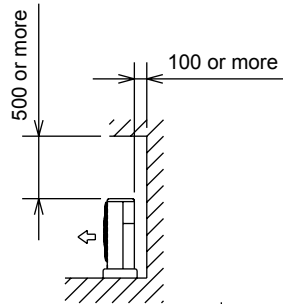

Note : Leave front and overhead free of obstruction.

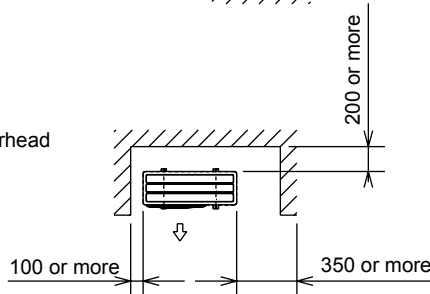

Note : Leave rear, overhead and both sides free of obstruction.

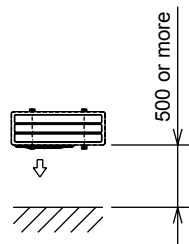

2. Service space

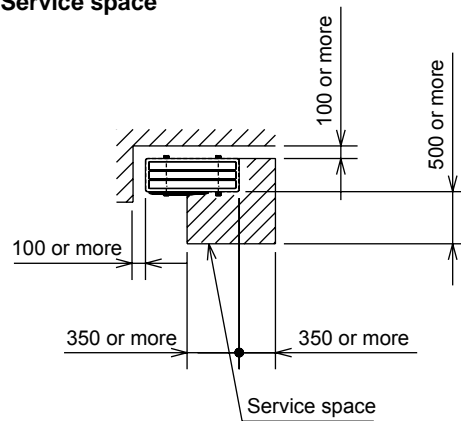

MXZ-4C80VA MXZ-5C100VA

Unit: mm

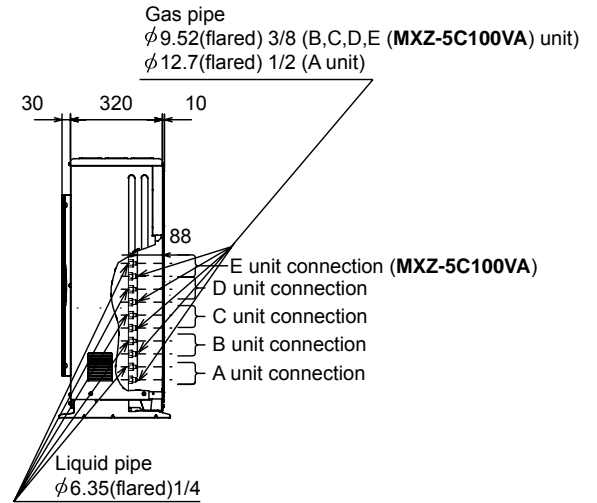
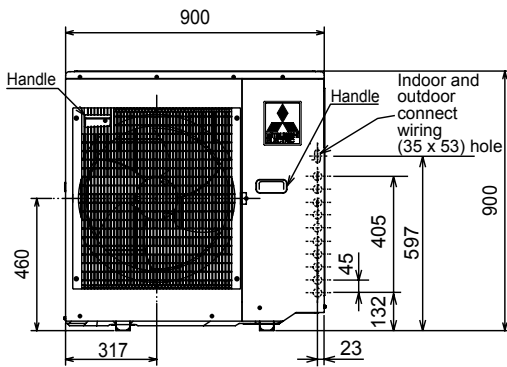
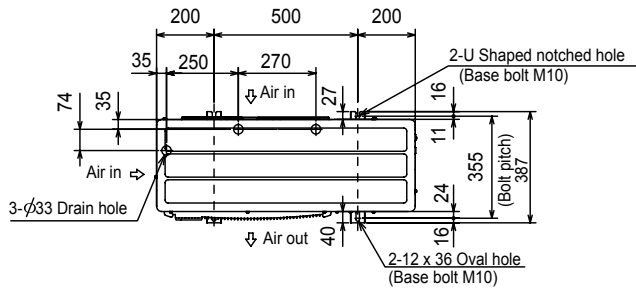

1. Installation space

Note : Leave front and both sides free of obstruction.

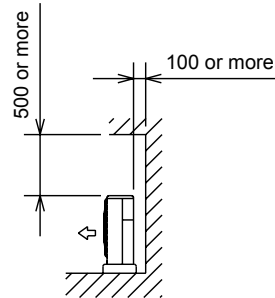

Note : Leave front and overhead free of obstruction.

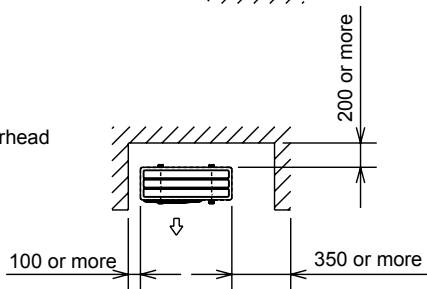

Note : Leave rear, overhead and both sides free of obstruction.

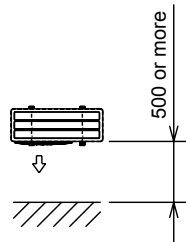

2. Service space

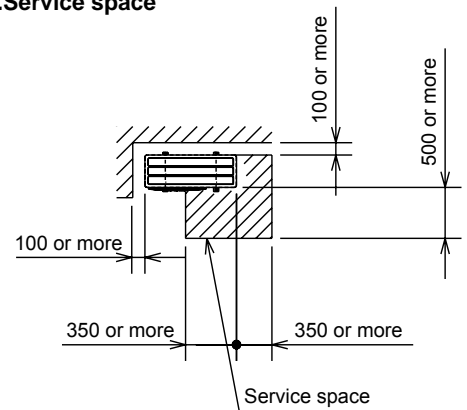

MXZ-4C80VA2 MXZ-5C100VA2

Unit: mm

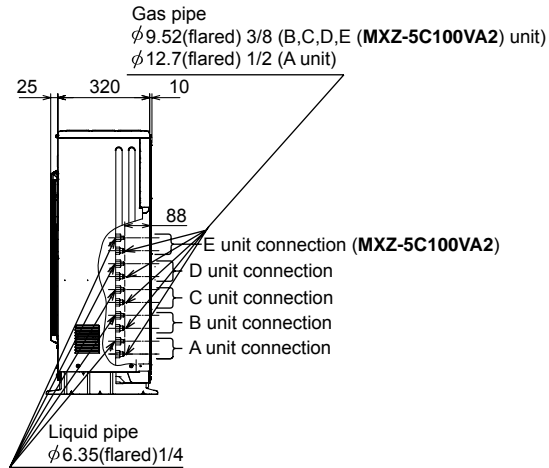
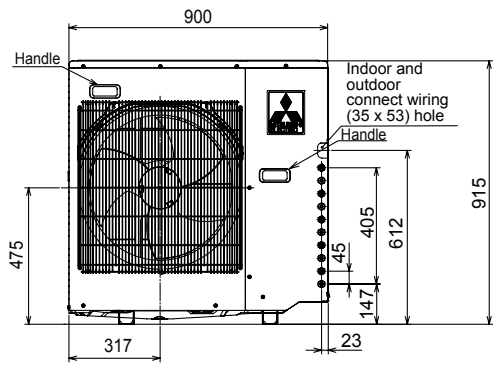
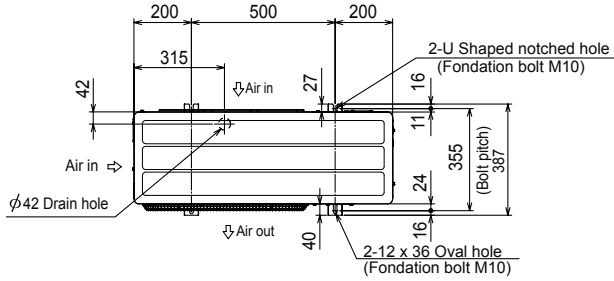

1. Installation space

Note : Leave front and both sides free of obstruction.

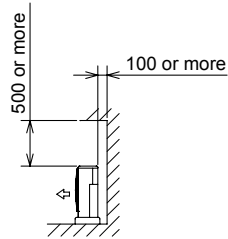

Note : Leave front and overhead free of obstruction.

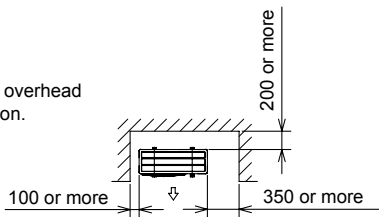

Note : Leave rear, overhead and both sides free of obstruction.

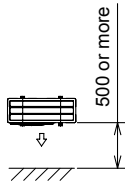

2. Service space

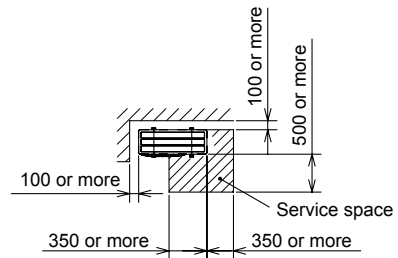

MXZ-6C120VA MXZ-6C122VA

Unit: mm

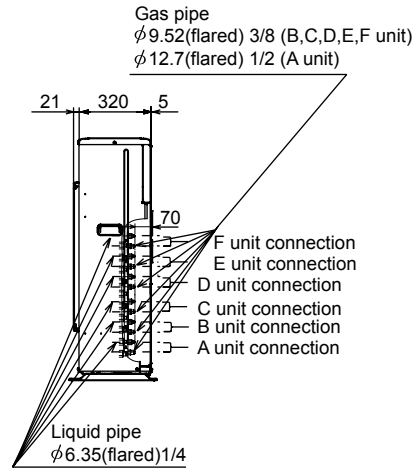
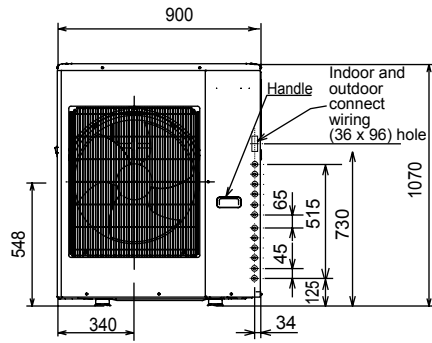
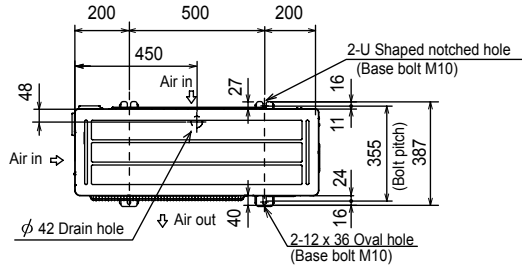

1. Installation space

Note : Leave front and both sides free of obstruction.

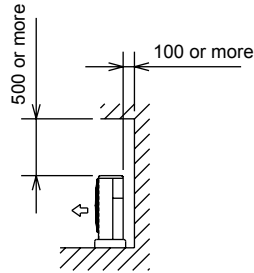

Note : Leave front and overhead free of obstruction.

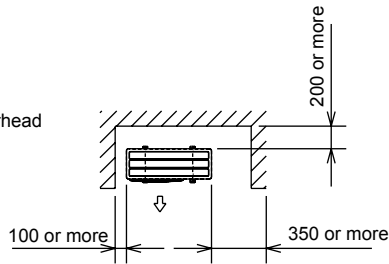

Note : Leave rear, overhead and both sides free of obstruction.

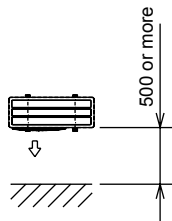

2. Service space

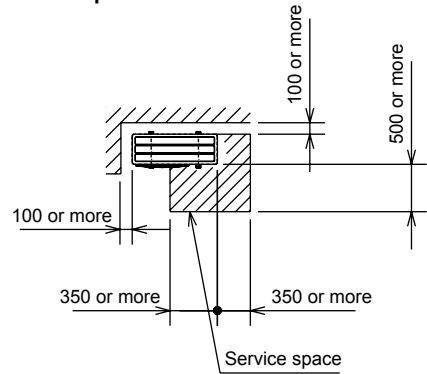

MXZ-2C30VA MXZ-2C40VA MXZ-2C52VA

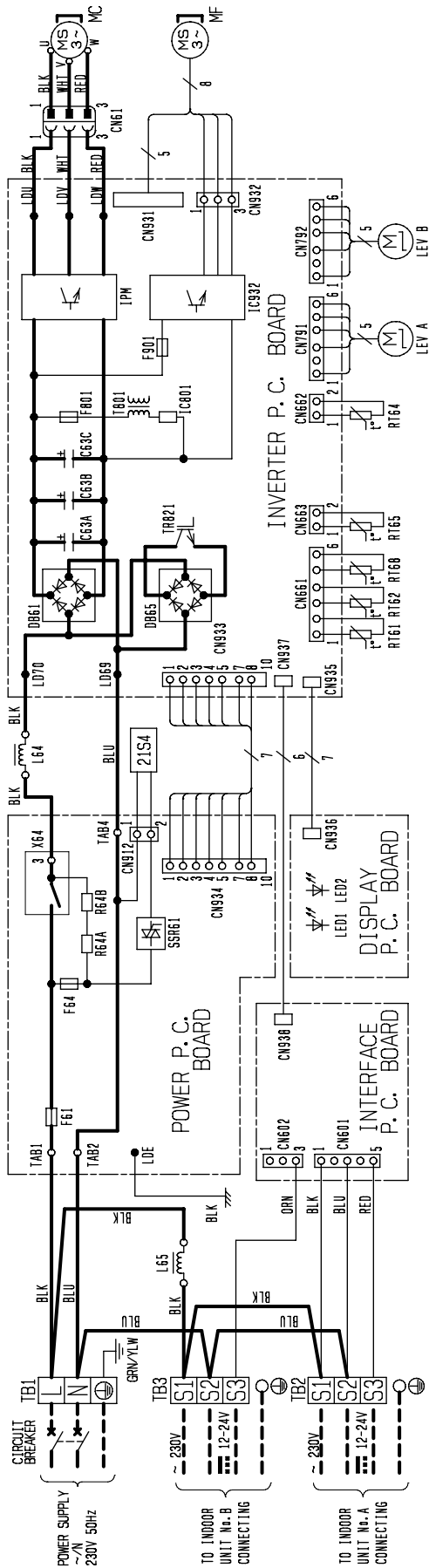

- NOTES:
1. About the indoor side electric wiring refer to the indoor unit electric wiring diagram for servicing.
 2. Use copper conductors only. (For field wiring).
 3. Symbols below indicate.
 - : Terminal block
 - ○ ○ ○ / : Connector

SYMBOL	NAME	SYMBOL	NAME	SYMBOL	NAME
C63A, C63B, C63C	SMOOTHING CAPACITOR	SSR61	COMPRESSOR	SSR61	SOLENOID COIL RELAY
DB61, DB65	DIODE MODULE	MC	FAN MOTOR	TB1, TB2, TB3	TERMINAL BLOCK
F61	FUSE (T20A/250V)	RT61	DEFROST THERMISTOR	TR821	SWITCHING POWER TRANSISTOR
F64, F901, F901	FUSE (T3.15A/250V)	RT62	DISCHARGE TEMP. THERMISTOR	T801	SWITCHING TRANS RELAY
IC801	POWER DEVICE	RT64	F IN TEMP. THERMISTOR	X64	REVERSING VALVE COIL
IPM, IC932	POWER MODULE	RT65	AMBIENT TEMP. THERMISTOR	21S4	REVERSING VALVE COIL
LED1, LED2	LED	RT68	OUTDOOR HEAT EXCHANGER TEMP. THERMISTOR		
LEV A, LEV B	EXPANSION VALVE COIL	R64A, R64B	CURRENT-LIMITING RESISTOR		
L64, L65	REACTOR				

MXZ-3C54VA

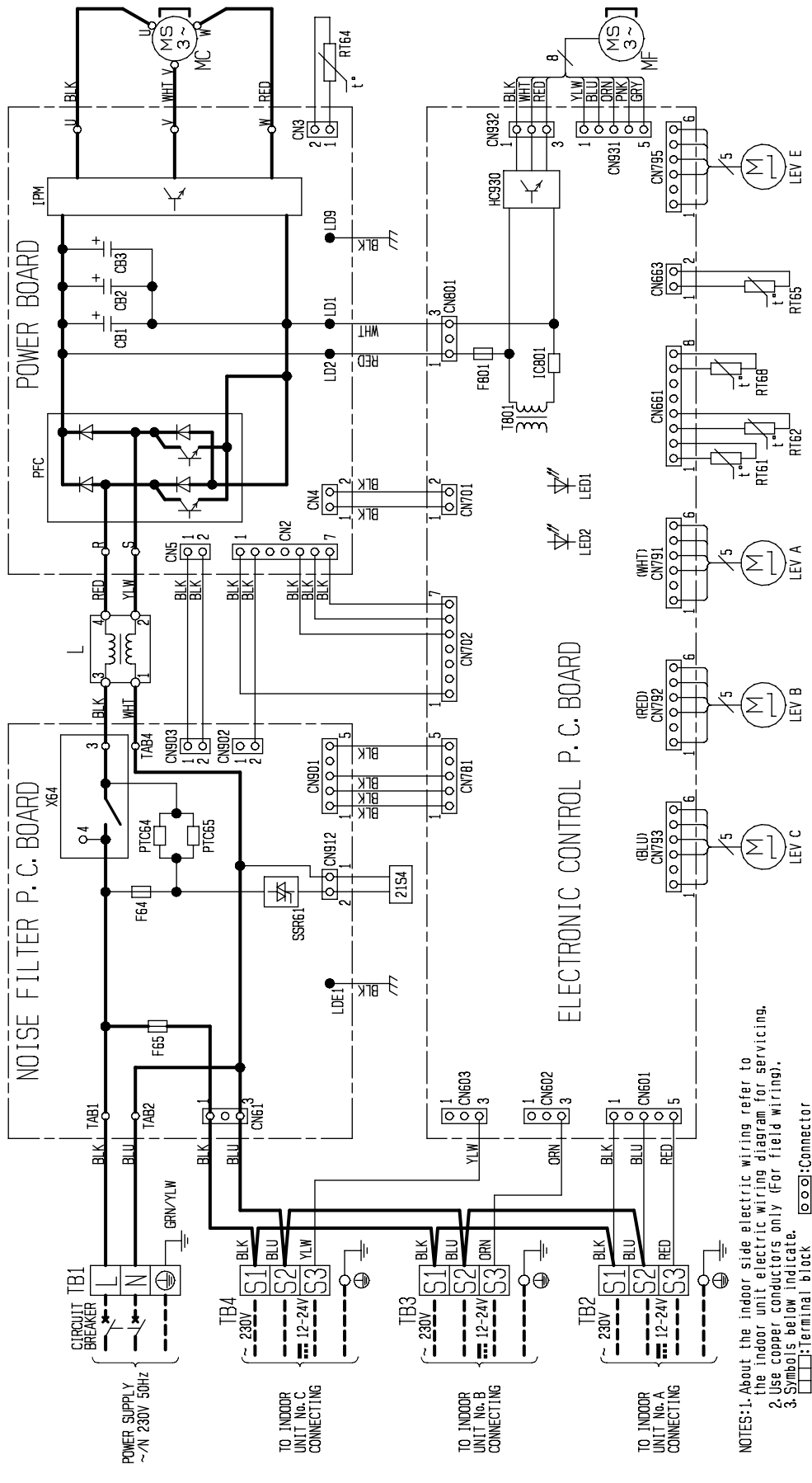

NOTES: 1. About the indoor side electric wiring refer to the indoor unit electric wiring diagram for servicing.
 2. Use copper conductors only (For field wiring).
 3. Symbols below indicate. \square :Terminal block, \square :Connector

SYMBOL	NAME	SYMBOL	NAME	SYMBOL	NAME	SYMBOL	NAME
CB1~3	SMOOTHING CAPACITOR	IPM	POWER MODULE	MF	FAN MOTOR	RT65	AMBIENT TEMP. THERMISTOR
F64	FUSE (7.2A/250V)	L	REACTOR	PTC64.65	CIRCUIT PROTECTION	SSR61	OUTDOOR HEAT EXCHANGER TEMP. THERMISTOR
F65	FUSE (T6.3A/250V)	LED1, 2	LED	RT61	DEFROST THERMISTOR	TB61	SOLENOID COIL RELAY
F801	FUSE (T3.15A/250V)	LEV A-C	EXPANSION VALVE	RT62	DISCHARGE TEMP. THERMISTOR	TB1~4	TRANSFORMER
HC930	POWER MODULE	LEV E	EXPANSION VALVE	RT64	FIN TEMP. THERMISTOR	X64	TERMINAL BLOCK
IC801	POWER DEVICE	MC	COMPRESSOR				RELAY

MXZ-3C68VA

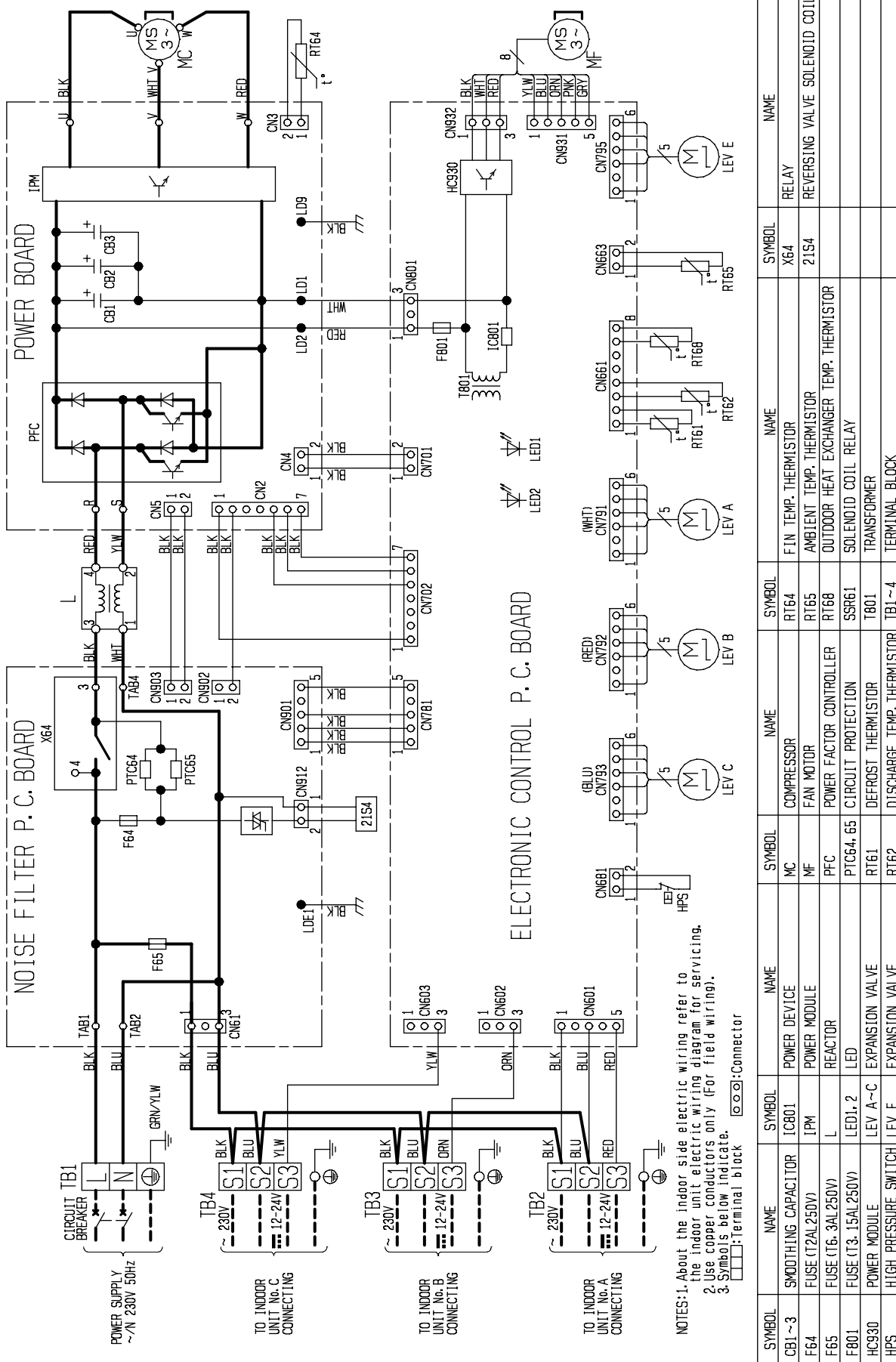

SYMBOL	NAME	SYMBOL	NAME	SYMBOL	NAME	SYMBOL	NAME
CB1 ~ 3	SMOOTHING CAPACITOR	IC801	POWER DEVICE	MC	COMPRESSOR	RT64	F IN TEMP. THERMISTOR
F64	FUSE (T2A/250V)	IPM	POWER MODULE	MF	FAN MOTOR	RT65	AMBIENT TEMP. THERMISTOR
F65	FUSE (T6.3A/250V)	L	REACTOR	PFC	POWER FACTOR CONTROLLER	RT68	OUTDOOR HEAT EXCHANGER TEMP. THERMISTOR
F801	FUSE (T3.15A/250V)	LED1, 2	LED	PTC64, 65	CIRCUIT PROTECTION	SSR61	SOLENOID COIL RELAY
HCS30	POWER MODULE	LEV A ~ C	EXPANSION VALVE	RT61	DEFROST THERMISTOR	T801	TRANSFORMER
HPS	HIGH PRESSURE SWITCH	LEV E	EXPANSION VALVE	RT62	DISCHARGE TEMP. THERMISTOR	TB1 ~ 4	TERMINAL BLOCK
						X64	RELAY
						21S4	REVERSING VALVE SOLENOID COIL

MXZ-4C71VA

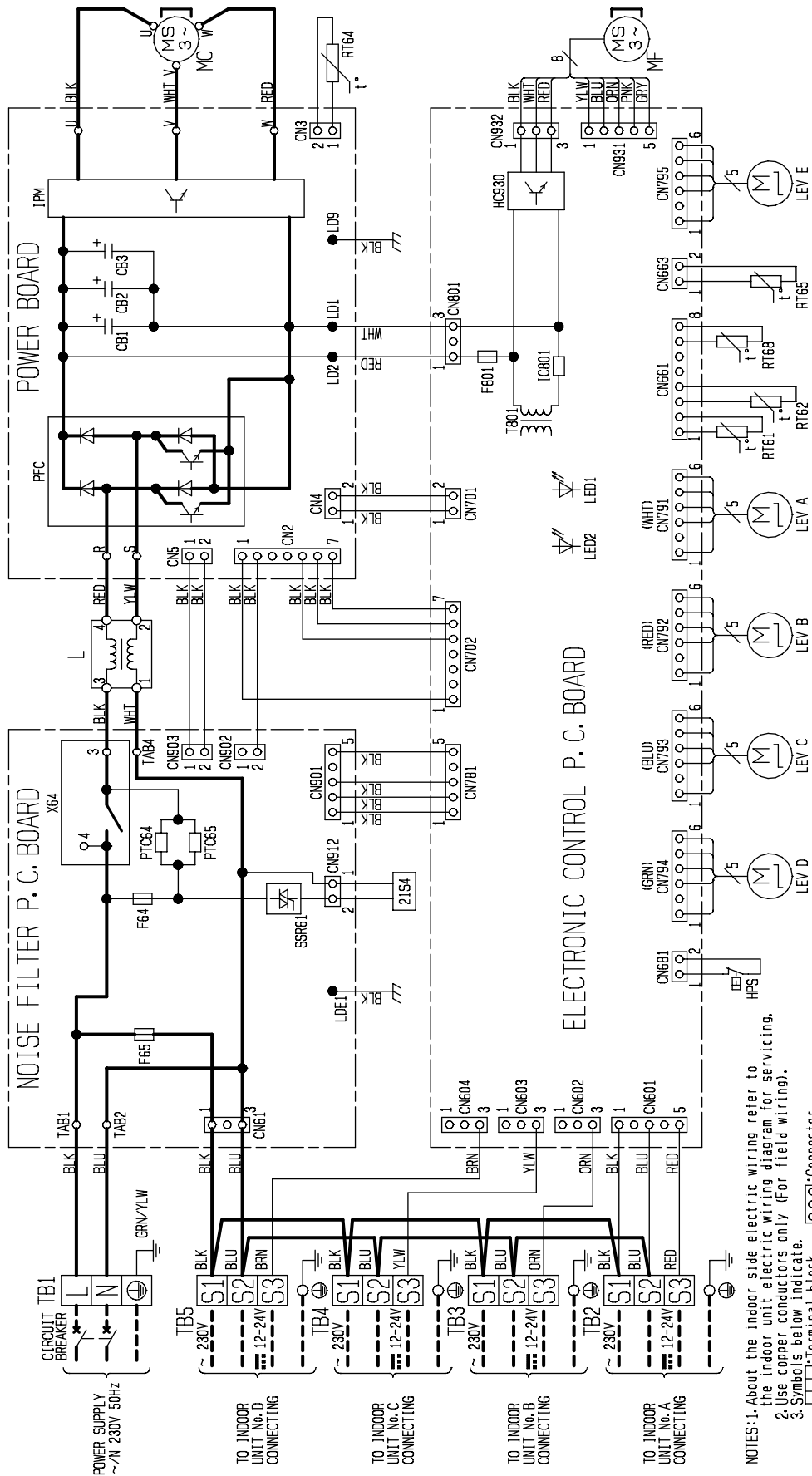

NOTES: 1. About the indoor side electric wiring refer to the indoor unit electric wiring diagram for servicing.
 2. Use copper conductors only (For field wiring).
 3. Symbols below indicate, □:Terminal block, ⊞:Connector

SYMBOL	NAME	SYMBOL	NAME	SYMBOL	NAME	SYMBOL	NAME
CB1~3	SMOOTHING CAPACITOR	IC801	POWER DEVICE	MC	COMPRESSOR	X64	RELAY
F64	FUSE (T2A,250V)	IPM	POWER MODULE	MF	FAN MOTOR	RT64	F.I.N TEMP. THERMISTOR
F65	FUSE (T6.3A,250V)	L	REACTOR	PFC	POWER FACTOR CONTROLLER	RT65	AMBIENT TEMP. THERMISTOR
F801	FUSE (T3.15A,250V)	LED1, 2	LED	PTC64, 65	CIRCUIT PROTECTION	RT68	OUTDOOR HEAT EXCHANGER TEMP. THERMISTOR
HC930	POWER MODULE	LEV A~D	EXPANSION VALVE	RT61	DEFROST THERMISTOR	SSR61	SOLENOID COIL RELAY
HPS	HIGH PRESSURE SWITCH	LEV E	EXPANSION VALVE	RT62	DISCHARGE TEMP. THERMISTOR	T801	TRANSFORMER
						TB1~5	TERMINAL BLOCK

MXZ-4C80VA

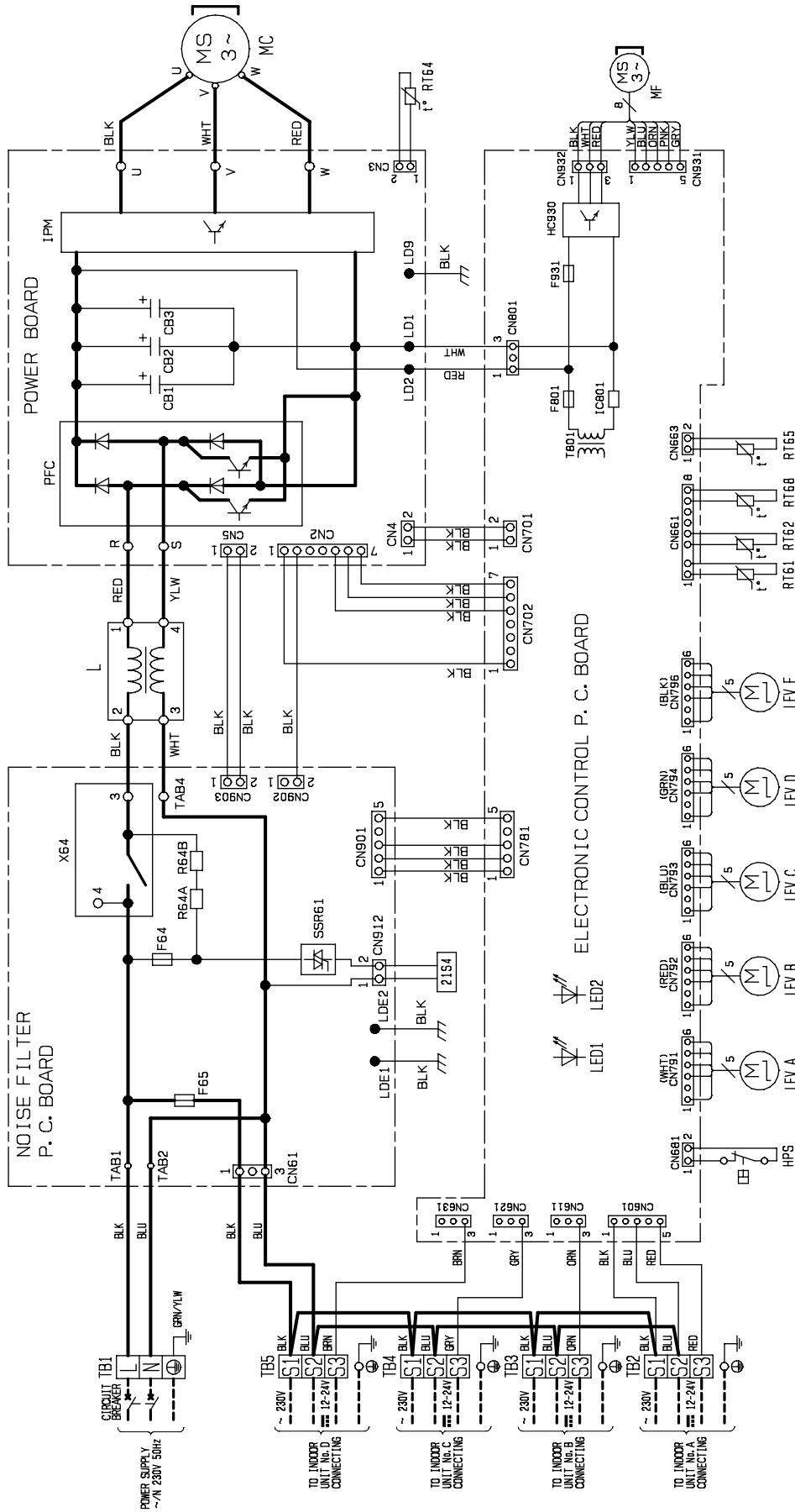

- NOTES:**
- About the indoor side electric wiring refer to the indoor unit electric wiring diagram for servicing.
 - Use copper conductors only (For field wiring).
 - Symbols below indicate,
 - : terminal block
 - : connector

SYMBOL	NAME	SYMBOL	NAME	SYMBOL	NAME	SYMBOL	NAME
CB1~3	SMOOTHING CAPACITOR	HPS	HIGH PRESSURE SWITCH	RT61	EXPANSION VALVE	T801	TRANSFORMER
F64	FUSE (T2AL250V)	IC801	POWER DEVICE	MC	COMPRESSOR	T81~5	TERMINAL BLOCK
F65	FUSE (T6.3AL250V)	IPM	POWER MODULE	MF	FAN MOTOR	X64	RELAY
F801	FUSE (T3.15AL250V)	L	REACTOR	PFC	POWER FACTOR CONTROLLER	21S4	REVERSING VALVE SOLENOID COIL
F931	FUSE (T3.15AL250V)	LED 1,2	LED	R64A, B	RESISTOR	SSR61	SOLENOID COIL RELAY
HC930	POWER MODULE	LEV A~D	EXPANSION VALVE	RT61	DEFROST THERMISTOR		

MXZ-4C80VA2

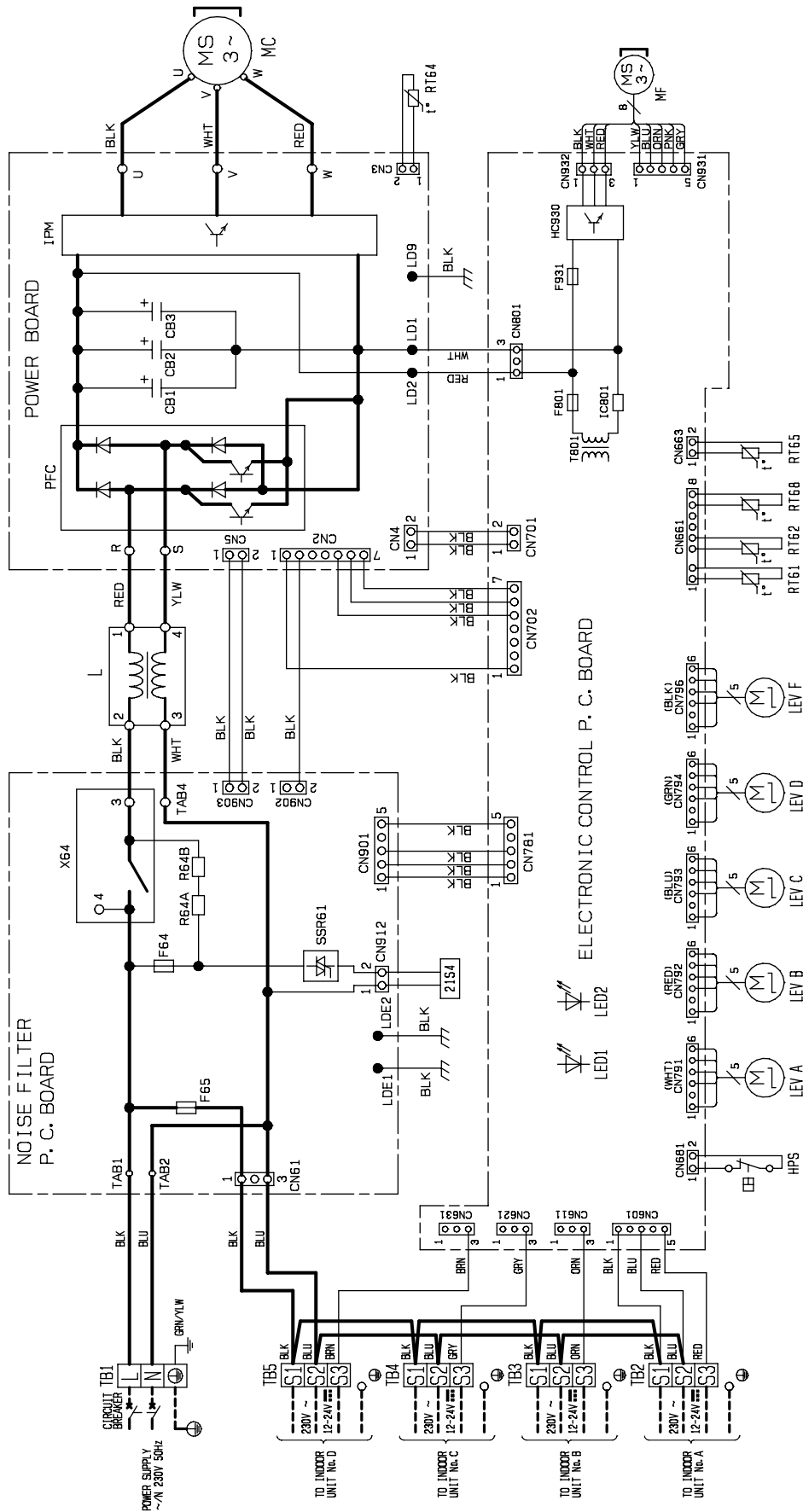

- NOTES:**
- About the indoor side electric wiring refer to the indoor unit electric wiring diagram for servicing.
 - Use copper conductors only (for field wiring).
 - Symbols below indicate.
 - □ □ □ : terminal block
 - ⊞ ⊞ ⊞ ⊞ : connector

SYMBOL	NAME	SYMBOL	NAME	SYMBOL	NAME	SYMBOL	NAME
C81 ~ 3	SMOOTHING CAPACITOR	HPS	HIGH PRESSURE SWITCH	LEV F	EXPANSION VALVE	T801	TRANSFORMER
F64	FUSE (T2AL250V)	IC801	POWER DEVICE	MC	COMPRESSOR	TB1 ~ 5	TERMINAL BLOCK
F65	FUSE (T6. 3AL250V)	IPM	POWER MODULE	MF	FAN MOTOR	XG4	RELAY
F801	FUSE (T3. 15AL250V)	L	REACTOR	PFC	POWER FACTOR CONTROLLER	21S4	REVERSING VALVE SOLENOID COIL
F931	FUSE (T3. 15AL250V)	LED 1, 2	LED	R64A, B	EXPANSION VALVE	SSR61	SOLENOID COIL RELAY
HC930	POWER MODULE	LEV A ~ D	EXPANSION VALVE	RT61	DEFROST THERMISTOR		

MXZ-5C100VA

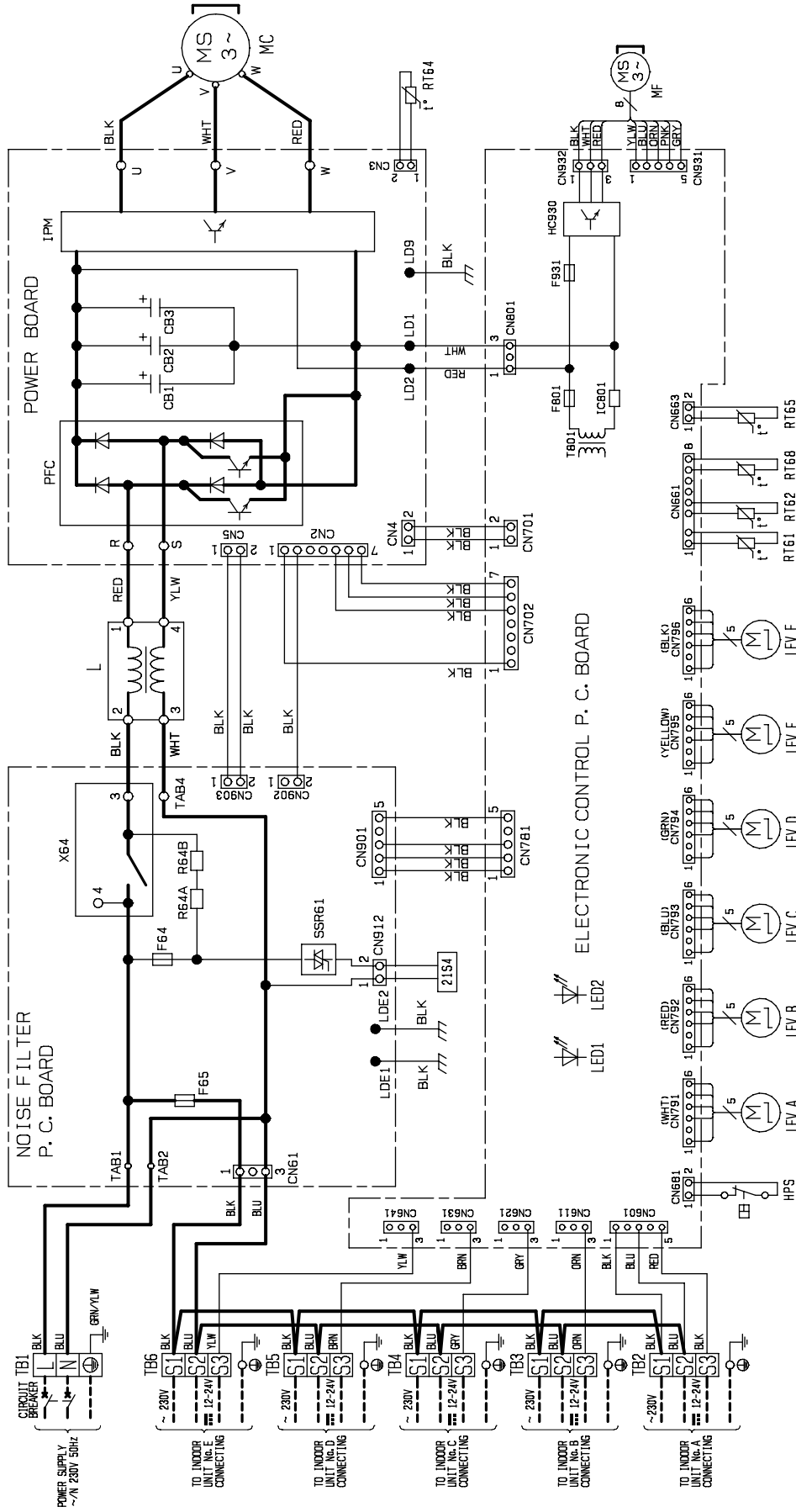

- NOTES:**
- About the indoor side electric wiring refer to the indoor unit electric wiring diagram for servicing.
 - Use copper conductors only (for field wiring).
 - Symbols below indicate.
 - : terminal
 - : connector

SYMBOL	NAME	SYMBOL	NAME	SYMBOL	NAME	SYMBOL	NAME
CB1~3	SMOOTHING CAPACITOR	HPS	HIGH PRESSURE SWITCH	LEV F	EXPANSION VALVE	T801	TRANSFORMER
F64	FUSE (T2A/250V)	IC801	POWER DEVICE	MC	COMPRESSOR	T81~6	TERMINAL BLOCK
F65	FUSE (T6.3A/250V)	TPM	POWER MODULE	MF	FAN MOTOR	X64	RELAY
F801	FUSE (T3.15A/250V)	L	REACTOR	PFC	POWER FACTOR CONTROLLER	21S4	REVERSING VALVE SOLENOID COIL
F931	FUSE (T3.15A/250V)	LED 1,2	LED	R64A,B	RESISTOR	RT61	DEFROST THERMISTOR
HC930	POWER MODULE	LEV A-E	EXPANSION VALVE	RT61	DEFROST THERMISTOR	SSR61	SOLENOID COIL RELAY

MXZ-5C100VA MXZ-5C100VA2

UNIT: mm

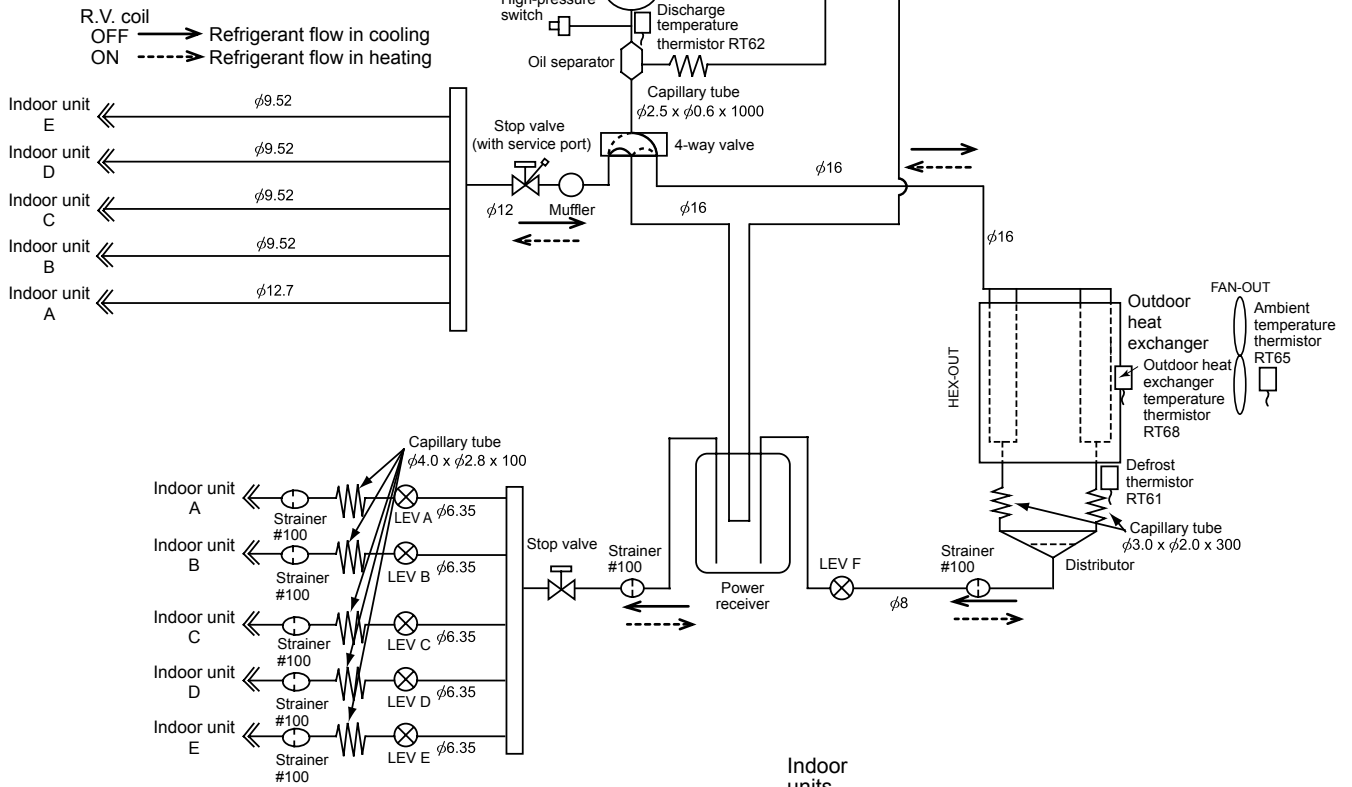

MAX REFRIGERANT PIPING LENGTH

Piping length each indoor unit (a, b, c, d, e)	25m
Total piping length (a+b+c+d+e)	80m
Bending point for each unit	25
Total bending point	80

*It is irrelevant which unit is higher.

ADDITIONAL REFRIGERANT CHARGE

Outdoor unit precharged (g)	Refrigerant piping length (one way, 5 unit total)				
	40m	50m	60m	70m	80m
4,000	0	200	400	600	800

Calculation : $Xg = 20 \text{ g/m} \times (\text{Refrigerant piping length (m)} - 40)$

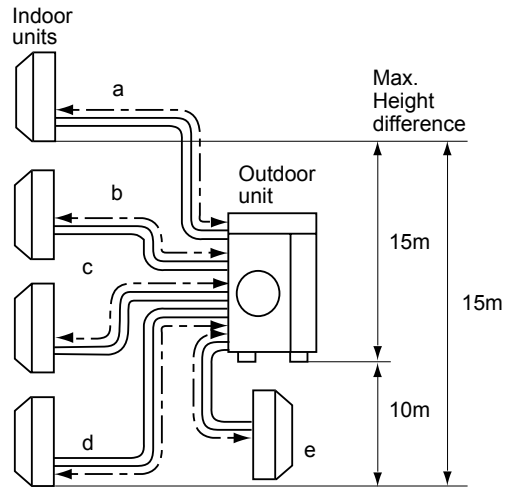

- Refrigerant pipe diameter is different according to indoor unit to be connected. When using extension pipes, refer to the tables below.
- When diameter of refrigerant pipe is different from that of outdoor unit union, use optional Different-diameter pipe. For further information on Different-diameter pipe, refer to "PARTS CATALOG".

UNIT: mm (inch)

Outdoor unit union diameter		
For		
Indoor unit A	Liquid	6.35(1/4)
	Gas	12.7(1/2)
Indoor unit B	Liquid	6.35(1/4)
	Gas	9.52(3/8)
Indoor unit C	Liquid	6.35(1/4)
	Gas	9.52(3/8)
Indoor unit D	Liquid	6.35(1/4)
	Gas	9.52(3/8)
Indoor unit E	Liquid	6.35(1/4)
	Gas	9.52(3/8)

MXZ-6C120VA -[E1]

UNIT: mm

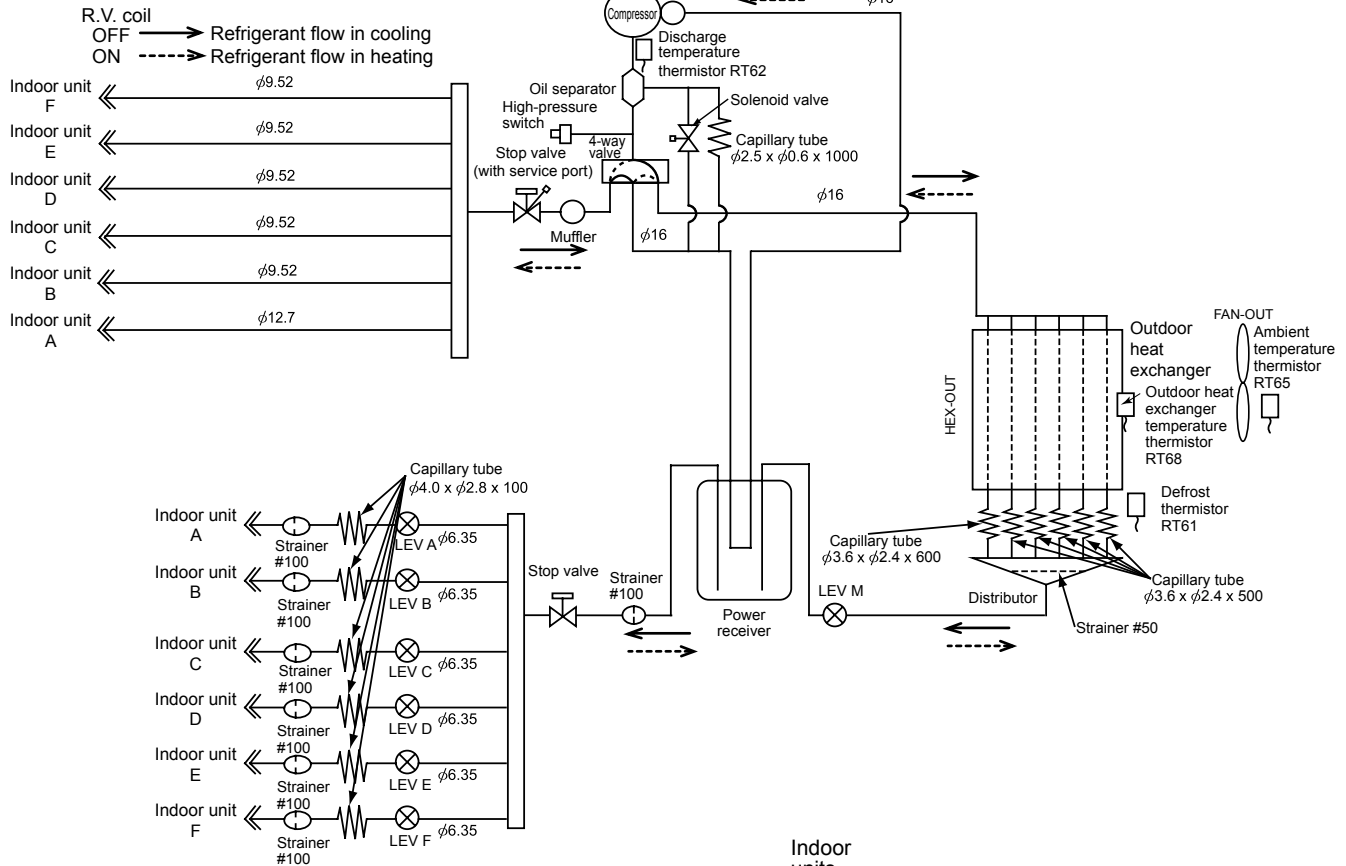

MAX REFRIGERANT PIPING LENGTH

Piping length each indoor unit (a, b, c, d, e, f)	25m
Total piping length (a+b+c+d+e+f)	80m
Bending point for each unit	25
Total bending point	80

*It is irrelevant which unit is higher.

ADDITIONAL REFRIGERANT CHARGE

Outdoor unit precharged (g)	Refrigerant piping length (one way, 6 unit total)				
	40m	50m	60m	70m	80m
5,000	0	0	0	200	400

Calculation : $Xg = 20 \text{ g/m} \times (\text{Refrigerant piping length (m)} - 60)$

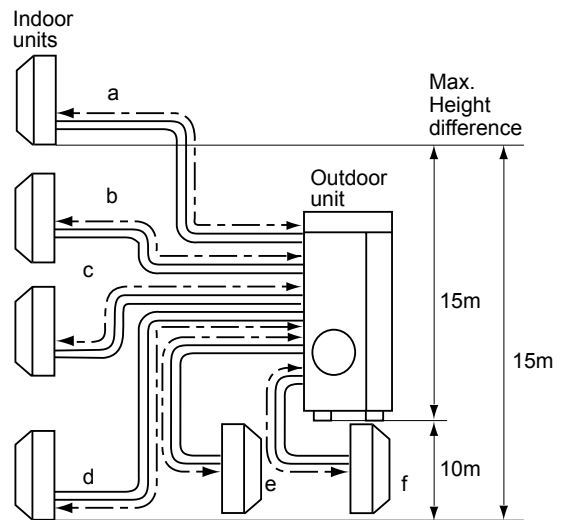

- Refrigerant pipe diameter is different according to indoor unit to be connected.
For the diameter of connection pipe of the indoor unit, refer to the indoor unit installation manual.
- When diameter of refrigerant pipe is different from that of outdoor unit union, use optional Different-diameter pipe.
For further information on Different-diameter pipe, refer to "PARTS CATALOG".

UNIT: mm (inch)

Outdoor unit union diameter		
For		
Indoor unit A	Liquid	6.35(1/4)
	Gas	12.7(1/2)
Indoor unit B	Liquid	6.35(1/4)
	Gas	9.52(3/8)
Indoor unit C	Liquid	6.35(1/4)
	Gas	9.52(3/8)

UNIT: mm (inch)

Outdoor unit union diameter		
For		
Indoor unit D	Liquid	6.35(1/4)
	Gas	9.52(3/8)
Indoor unit E	Liquid	6.35(1/4)
	Gas	9.52(3/8)
Indoor unit F	Liquid	6.35(1/4)
	Gas	9.52(3/8)

MXZ-6C120VA -E2 MXZ-6C122VA

UNIT: mm

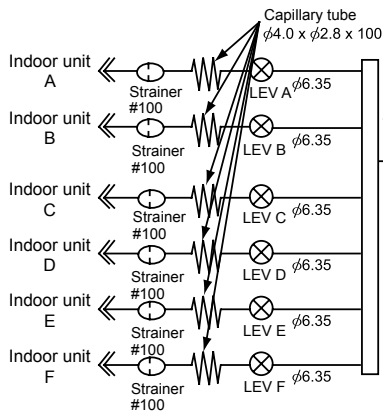
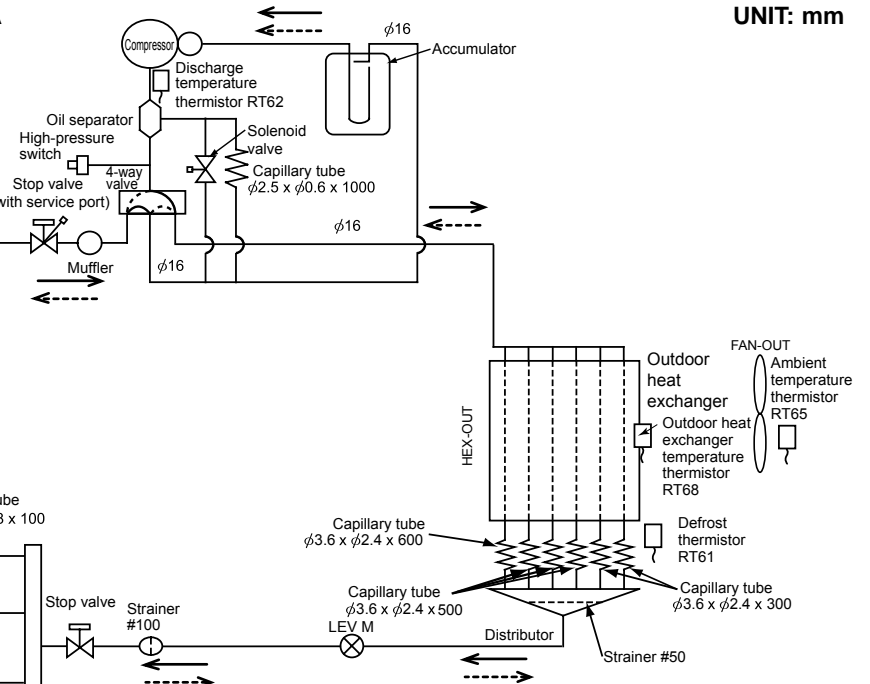
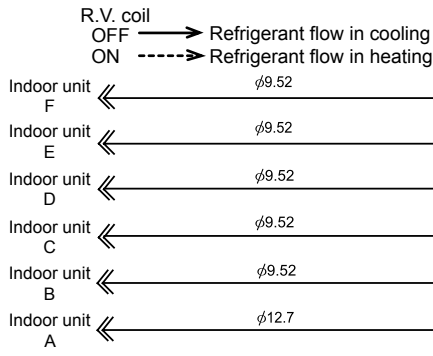

MAX REFRIGERANT PIPING LENGTH

Piping length each indoor unit (a, b, c, d, e, f)	25m
Total piping length (a+b+c+d+e+f)	80m
Bending point for each unit	25
Total bending point	80

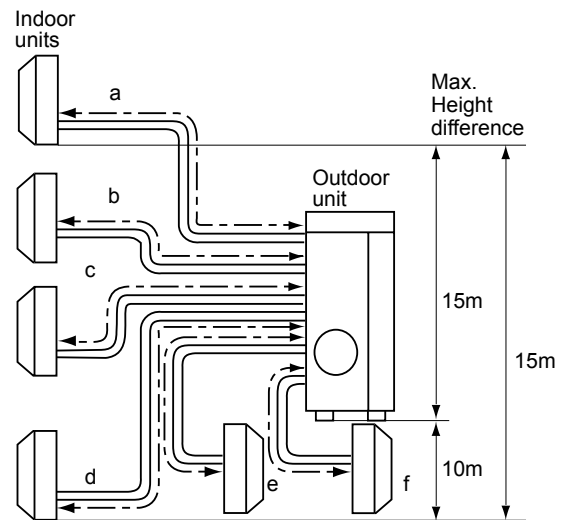

*It is irrelevant which unit is higher.

ADDITIONAL REFRIGERANT CHARGE

Outdoor unit precharged (g)	Refrigerant piping length (one way, 6 unit total)				
	40m	50m	60m	70m	80m
4,800	0	0	0	200	400

Calculation : $Xg = 20 \text{ g/m} \times (\text{Refrigerant piping length (m)} - 60)$

- Refrigerant pipe diameter is different according to indoor unit to be connected. For the diameter of connection pipe of the indoor unit, refer to the indoor unit installation manual.
- When diameter of refrigerant pipe is different from that of outdoor unit union, use optional Different-diameter pipe. For further information on Different-diameter pipe, refer to "PARTS CATALOG".

UNIT: mm (inch)

Outdoor unit union diameter		
For		
Indoor unit A	Liquid	6.35(1/4)
	Gas	12.7(1/2)
Indoor unit B	Liquid	6.35(1/4)
	Gas	9.52(3/8)
Indoor unit C	Liquid	6.35(1/4)
	Gas	9.52(3/8)

UNIT: mm (inch)

Outdoor unit union diameter		
For		
Indoor unit D	Liquid	6.35(1/4)
	Gas	9.52(3/8)
Indoor unit E	Liquid	6.35(1/4)
	Gas	9.52(3/8)
Indoor unit F	Liquid	6.35(1/4)
	Gas	9.52(3/8)

MXZ-2C30VA MXZ-2C40VA MXZ-2C52VA MXZ-3C54VA MXZ-3C68VA MXZ-4C71VA
MXZ-4C80VA MXZ-4C80VA2 MXZ-5C100VA MXZ-5C100VA2 MXZ-6C120VA MXZ-6C122VA

The standard specifications apply only to the operation of the air conditioner under normal conditions.

Since operating conditions vary according to the areas where these units are installed, the following information has been provided to clarify the operating characteristics of the air conditioner under the conditions indicated by the performance curve.

(1) GUARANTEED VOLTAGE

198~264 V 50 Hz

(2) AIR FLOW

Air flow should be set at MAX.

(3) MAIN READINGS

(1) Indoor intake air wet-bulb temperature :	°CWB	} Cooling
(2) Indoor outlet air wet-bulb temperature :	°CWB	
(3) Outdoor intake air dry-bulb temperature :	°CDB	
(4) Total input:	W	} Heating
(5) Indoor intake air dry-bulb temperature :	°CDB	
(6) Outdoor intake air wet-bulb temperature :	°CWB	
(7) Total input :	W	

Indoor air wet and dry bulb temperature difference on the left side of the following chart shows the difference between the indoor intake air wet and dry bulb temperature and the indoor outlet air wet and dry bulb temperature for your reference at service.

How to measure the indoor air wet and dry bulb temperature difference

1. Attach at least 2 sets of wet and dry bulb thermometers to the indoor air intake as shown in the figure, and at least 2 sets of wet and dry bulb thermometers to the indoor air outlet. The thermometers must be attached to the position where air speed is high.
2. Attach at least 2 sets of wet and dry bulb thermometers to the outdoor air intake. Cover the thermometers to prevent direct rays of the sun.
3. Check that the air filter is cleaned.
4. Open windows and doors of room.
5. Press the EMERGENCY OPERATION switch once (twice) to start the EMERGENCY COOL (HEAT) MODE.
6. When system stabilizes after more than 15 minutes, measure temperature and take an average temperature.
7. 10 minutes later, measure temperature again and check that the temperature does not change.

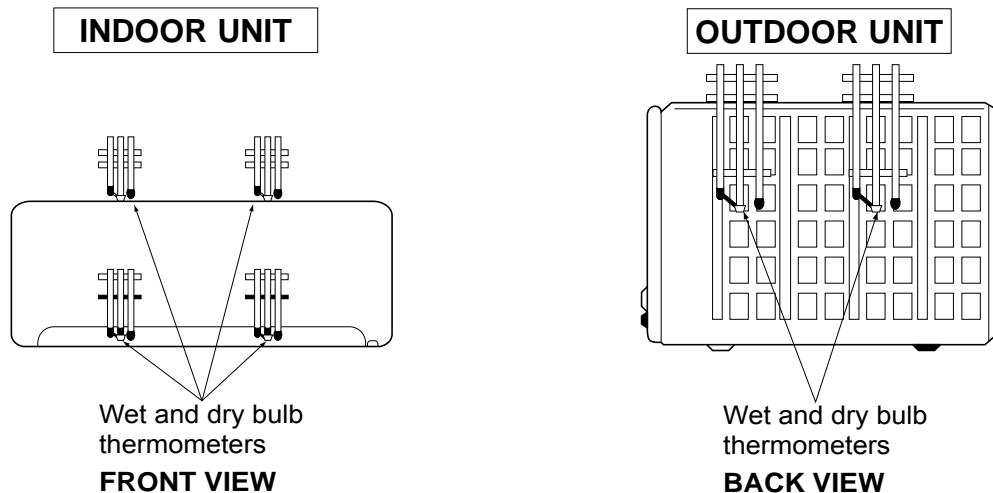

MXZ-2C30VA MXZ-2C40VA MXZ-2C52VA MXZ-3C54VA MXZ-3C68VA MXZ-4C71VA
MXZ-4C80VA MXZ-4C80VA2 MXZ-5C100VA MXZ-5C100VA2 MXZ-6C120VA MXZ-6C122VA

The standard specifications apply only to the operation of the air conditioner under normal conditions.

Since operating conditions vary according to the areas where these units are installed, the following information has been provided to clarify the operating characteristics of the air conditioner under the conditions indicated by the performance curve.

(1) GUARANTEED VOLTAGE

198~264 V 50 Hz

(2) AIR FLOW

Air flow should be set at MAX.

(3) MAIN READINGS

(1) Indoor intake air wet-bulb temperature :	°CWB	} Cooling
(2) Indoor outlet air wet-bulb temperature :	°CWB	
(3) Outdoor intake air dry-bulb temperature :	°CDB	
(4) Total input:	W	} Heating
(5) Indoor intake air dry-bulb temperature :	°CDB	
(6) Outdoor intake air wet-bulb temperature :	°CWB	
(7) Total input :	W	

Indoor air wet and dry bulb temperature difference on the left side of the following chart shows the difference between the indoor intake air wet and dry bulb temperature and the indoor outlet air wet and dry bulb temperature for your reference at service.

How to measure the indoor air wet and dry bulb temperature difference

- Attach at least 2 sets of wet and dry bulb thermometers to the indoor air intake as shown in the figure, and at least 2 sets of wet and dry bulb thermometers to the indoor air outlet. The thermometers must be attached to the position where air speed is high.
- Attach at least 2 sets of wet and dry bulb thermometers to the outdoor air intake. Cover the thermometers to prevent direct rays of the sun.
- Check that the air filter is cleaned.
- Open windows and doors of room.
- Press the EMERGENCY OPERATION switch once (twice) to start the EMERGENCY COOL (HEAT) MODE.
- When system stabilizes after more than 15 minutes, measure temperature and take an average temperature.
- 10 minutes later, measure temperature again and check that the temperature does not change.

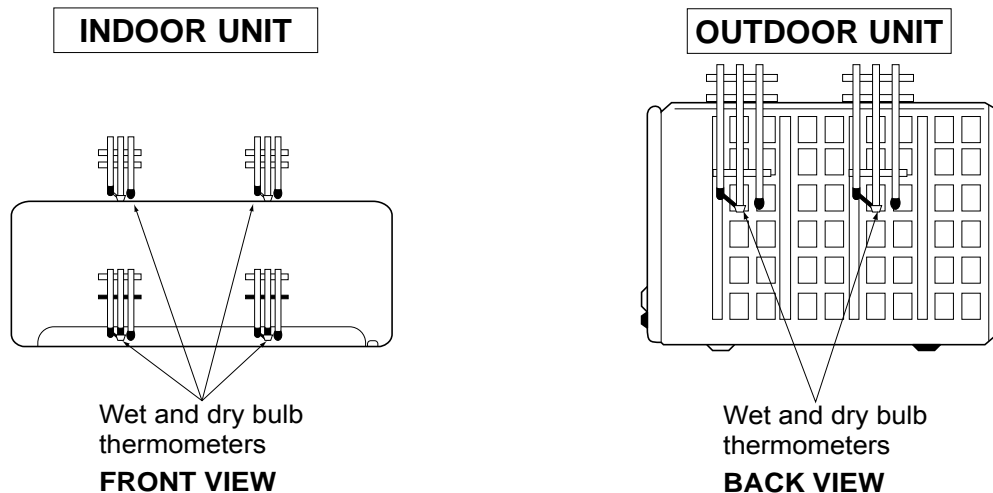

MXZ-4C80VA MXZ-4C80VA2 MXZ-5C100VA MXZ-5C100VA2 MXZ-6C120VA

Indoor air Wet-bulb temperature difference (°C)	6.3	8.0	8.5	9.3	10.6	9.5	13.1	13.7	17.0
	5.8	7.3	7.8	8.5	9.7	8.7	11.9	12.4	15.4
	5.3	6.7	7.1	7.8	8.8	8.0	10.8	11.3	13.9
	4.8	6.0	6.4	7.0	7.9	7.2	9.7	10.1	12.5
	4.3	5.4	5.8	6.3	7.1	6.5	8.7	9.0	11.1
	3.9	4.8	5.1	5.6	6.3	5.7	7.7	8.0	9.7
	15 class	20 class	22 class	25 class	35 class	42 class	50 class	60 class	71 class

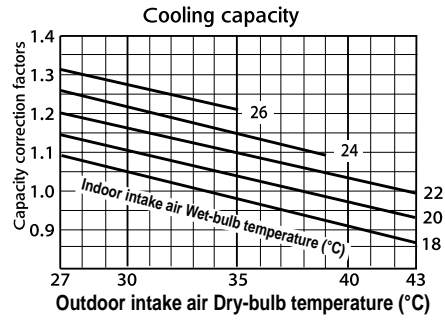

Indoor air Wet-bulb temperature difference (°C)	6.3	8.0	8.5	9.3	10.6	9.5	13.1	13.7	17.0
	5.8	7.3	7.8	8.5	9.7	8.7	11.9	12.4	15.4
	5.3	6.7	7.1	7.8	8.8	8.0	10.8	11.3	13.9
	4.8	6.0	6.4	7.0	7.9	7.2	9.7	10.1	12.5
	4.3	5.4	5.8	6.3	7.1	6.5	8.7	9.0	11.1
	3.9	4.8	5.1	5.6	6.3	5.7	7.7	8.0	9.7
	15 class	20 class	22 class	25 class	35 class	42 class	50 class	60 class	71 class

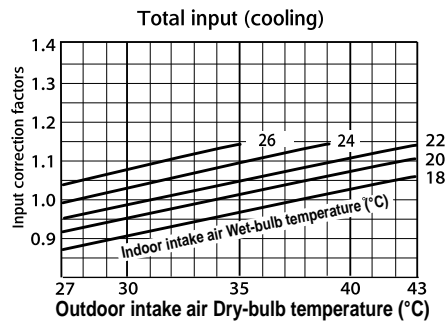

Indoor air Dry-bulb temperature difference (°C)	17.1	19.7	25.4	24.0	25.9	27.0	31.4	31.9	35.1
	15.8	18.2	23.4	22.2	23.9	24.9	29.0	29.4	32.4
	14.5	16.7	21.5	20.3	21.9	22.8	26.6	27.0	29.7
	13.2	15.2	19.5	18.5	19.9	20.7	24.1	24.5	27.0
	11.8	13.6	17.6	16.6	17.9	18.7	21.7	22.1	24.3
	10.5	12.1	15.6	14.8	15.9	16.6	19.3	19.6	21.6
	9.2	10.6	13.7	12.9	13.9	14.5	16.9	17.2	18.9
	7.9	9.1	11.7	11.1	12.0	12.4	14.5	14.7	16.2
	15 class	20 class	22 class	25 class	35 class	42 class	50 class	60 class	71 class

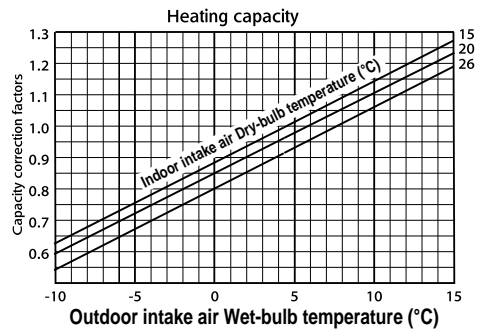

Indoor air Dry-bulb temperature difference (°C)	17.1	19.7	25.4	24.0	25.9	27.0	31.4	31.9	35.1
	15.8	18.2	23.4	22.2	23.9	24.9	29.0	29.4	32.4
	14.5	16.7	21.5	20.3	21.9	22.8	26.6	27.0	29.7
	13.2	15.2	19.5	18.5	19.9	20.7	24.1	24.5	27.0
	11.8	13.6	17.6	16.6	17.9	18.7	21.7	22.1	24.3
	10.5	12.1	15.6	14.8	15.9	16.6	19.3	19.6	21.6
	9.2	10.6	13.7	12.9	13.9	14.5	16.9	17.2	18.9
	7.9	9.1	11.7	11.1	12.0	12.4	14.5	14.7	16.2
	15 class	20 class	22 class	25 class	35 class	42 class	50 class	60 class	71 class

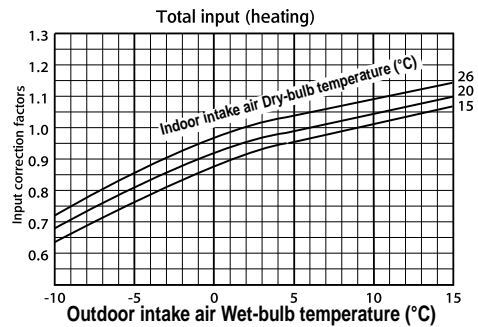

MXZ-6C122VA

Indoor air Wet-bulb temperature difference (°C)	6.3	8.0	8.5	9.3	10.6	9.5	13.1	13.7	17.0
	5.8	7.3	7.8	8.5	9.7	8.7	11.9	12.4	15.4
	5.3	6.7	7.1	7.8	8.8	8.0	10.8	11.3	13.9
	4.8	6.0	6.4	7.0	7.9	7.2	9.7	10.1	12.5
	4.3	5.4	5.8	6.3	7.1	6.5	8.7	9.0	11.1
	3.9	4.8	5.1	5.6	6.3	5.7	7.7	8.0	9.7
	15 class	20 class	22 class	25 class	35 class	42 class	50 class	60 class	71 class

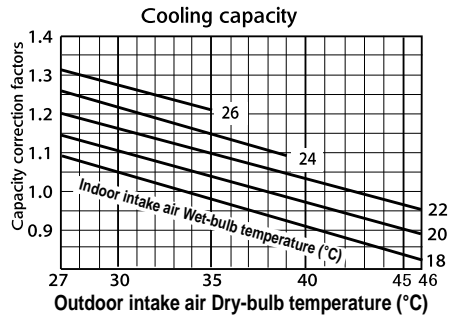

Indoor air Wet-bulb temperature difference (°C)	6.3	8.0	8.5	9.3	10.6	9.5	13.1	13.7	17.0
	5.8	7.3	7.8	8.5	9.7	8.7	11.9	12.4	15.4
	5.3	6.7	7.1	7.8	8.8	8.0	10.8	11.3	13.9
	4.8	6.0	6.4	7.0	7.9	7.2	9.7	10.1	12.5
	4.3	5.4	5.8	6.3	7.1	6.5	8.7	9.0	11.1
	3.9	4.8	5.1	5.6	6.3	5.7	7.7	8.0	9.7
	15 class	20 class	22 class	25 class	35 class	42 class	50 class	60 class	71 class

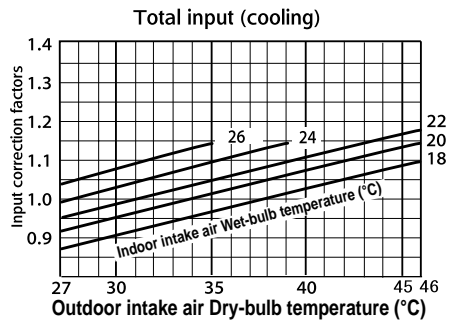

Indoor air Dry-bulb temperature difference (°C)	17.1	19.7	25.4	24.0	25.9	27.0	31.4	31.9	35.1
	15.8	18.2	23.4	22.2	23.9	24.9	29.0	29.4	32.4
	14.5	16.7	21.5	20.3	21.9	22.8	26.6	27.0	29.7
	13.2	15.2	19.5	18.5	19.9	20.7	24.1	24.5	27.0
	11.8	13.6	17.6	16.6	17.9	18.7	21.7	22.1	24.3
	10.5	12.1	15.6	14.8	15.9	16.6	19.3	19.6	21.6
	9.2	10.6	13.7	12.9	13.9	14.5	16.9	17.2	18.9
	7.9	9.1	11.7	11.1	12.0	12.4	14.5	14.7	16.2
	15 class	20 class	22 class	25 class	35 class	42 class	50 class	60 class	71 class

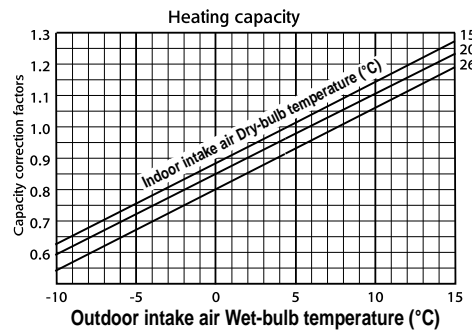

Indoor air Dry-bulb temperature difference (°C)	17.1	19.7	25.4	24.0	25.9	27.0	31.4	31.9	35.1
	15.8	18.2	23.4	22.2	23.9	24.9	29.0	29.4	32.4
	14.5	16.7	21.5	20.3	21.9	22.8	26.6	27.0	29.7
	13.2	15.2	19.5	18.5	19.9	20.7	24.1	24.5	27.0
	11.8	13.6	17.6	16.6	17.9	18.7	21.7	22.1	24.3
	10.5	12.1	15.6	14.8	15.9	16.6	19.3	19.6	21.6
	9.2	10.6	13.7	12.9	13.9	14.5	16.9	17.2	18.9
	7.9	9.1	11.7	11.1	12.0	12.4	14.5	14.7	16.2
	15 class	20 class	22 class	25 class	35 class	42 class	50 class	60 class	71 class

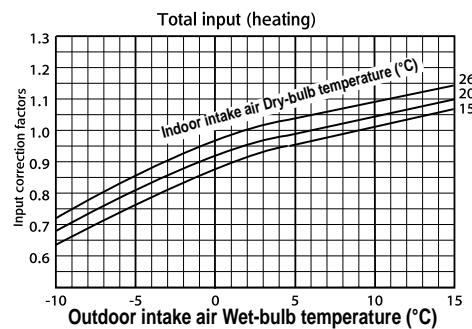

8-2. CAPACITY AND INPUT CORRECTION BY INVERTER OUTPUT FREQUENCY (single operation)

MXZ-2C30VA

15-class unit

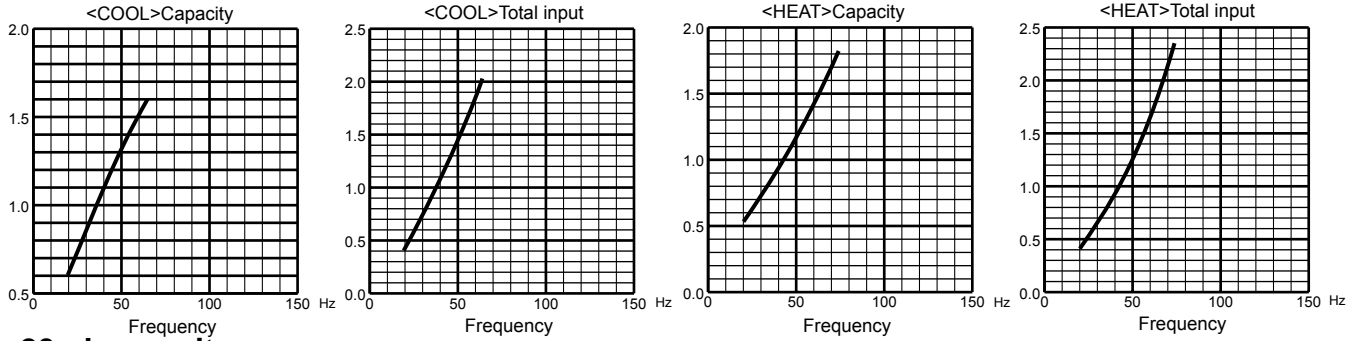

20-class unit

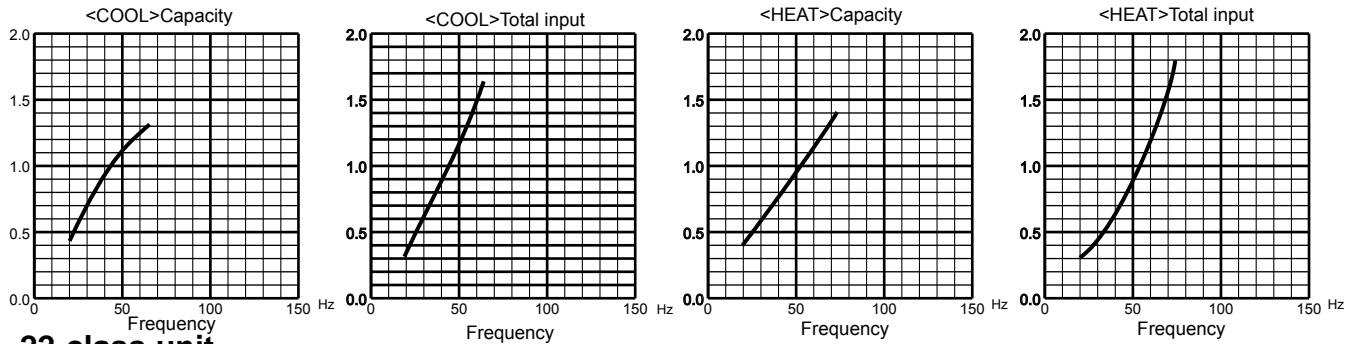

22-class unit

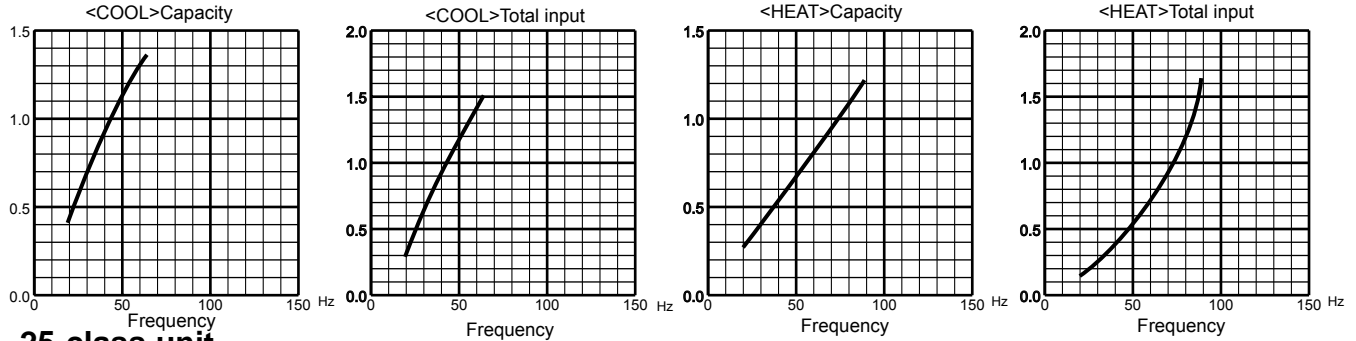

25-class unit

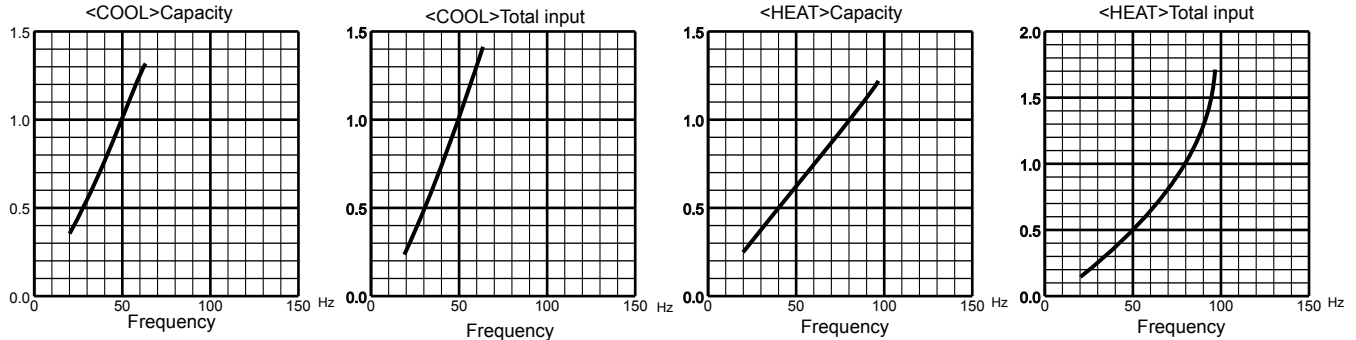

MXZ-2C40VA

15-class unit

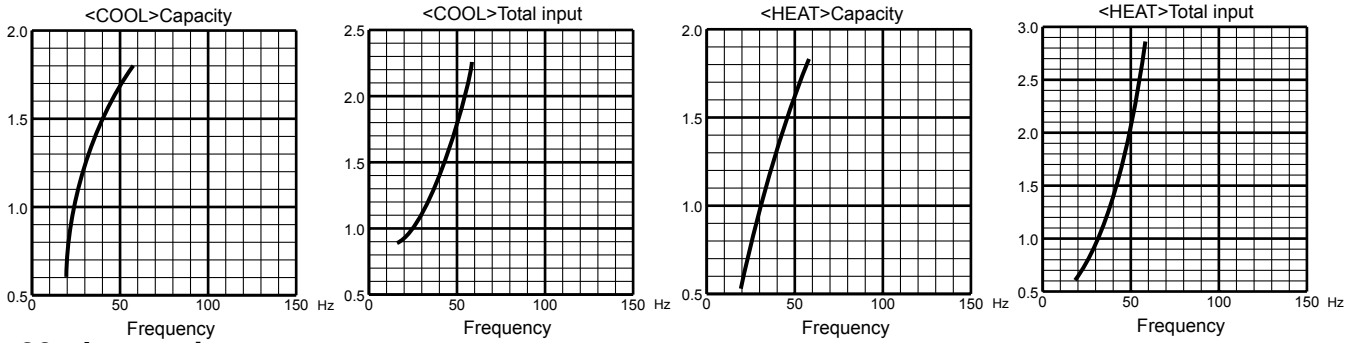

20-class unit

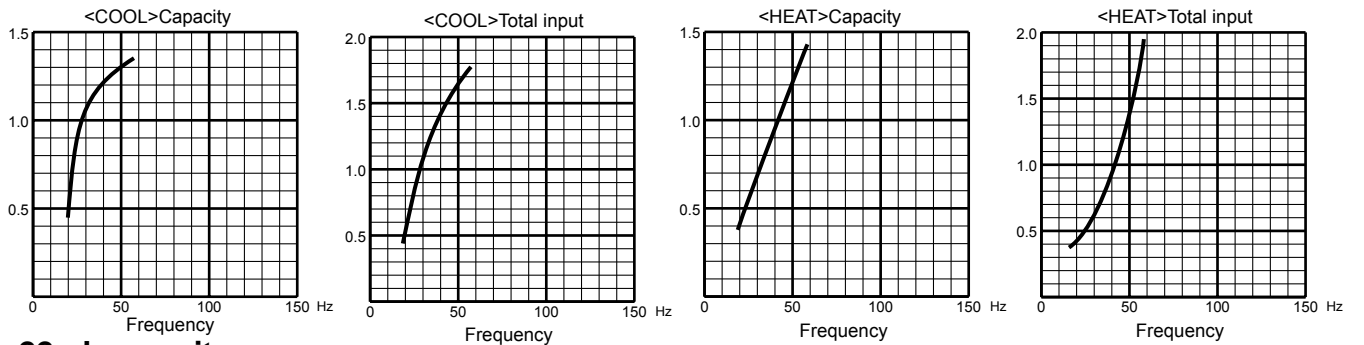

22-class unit

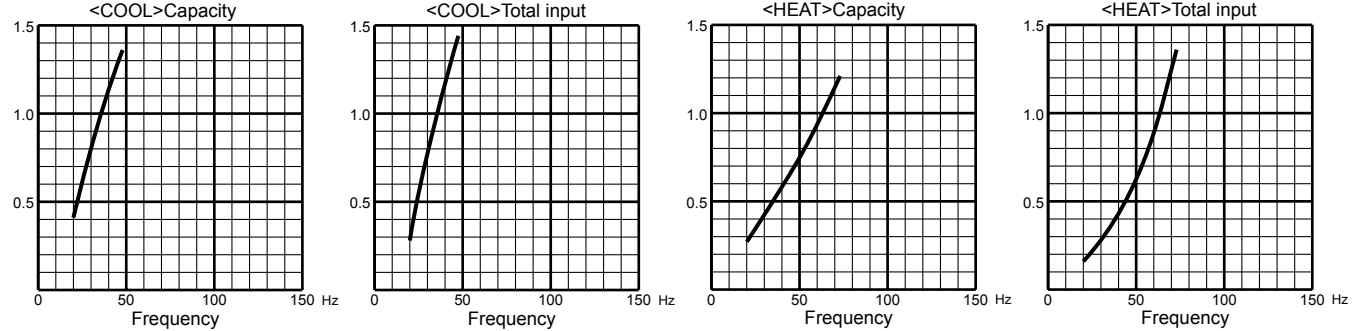

25-class unit

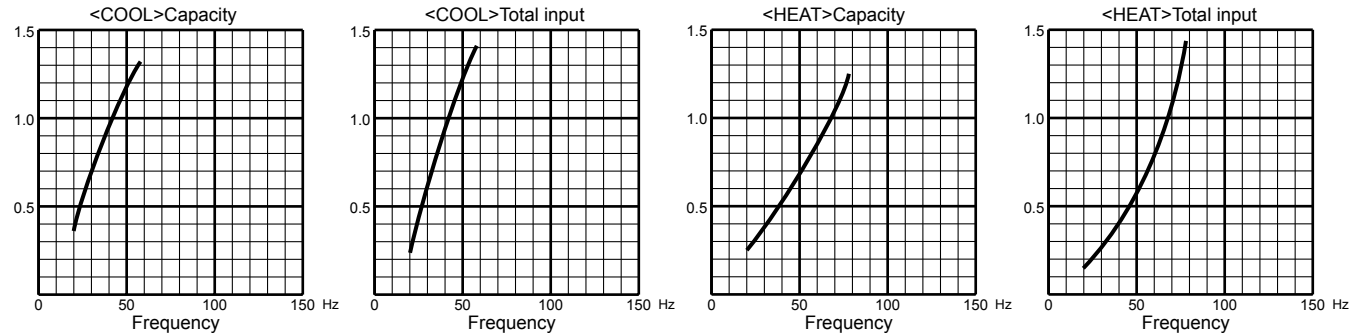

35-class unit

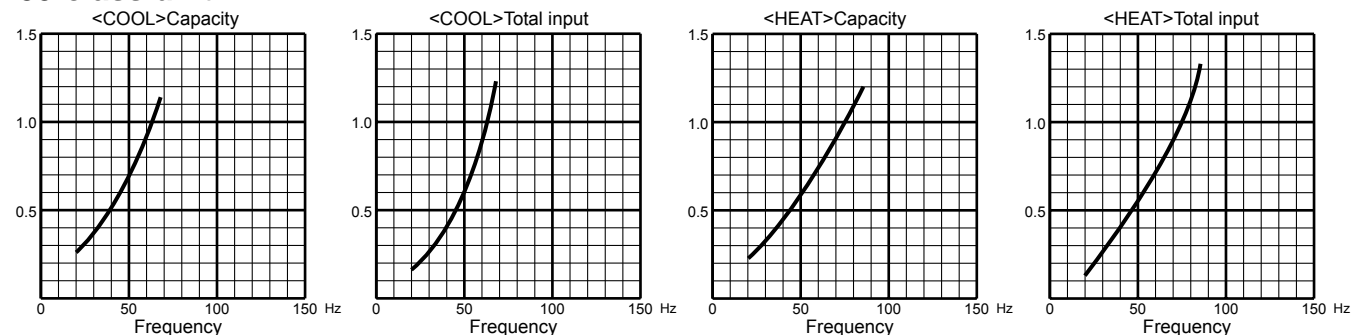

MXZ-2C52VA

15-class unit

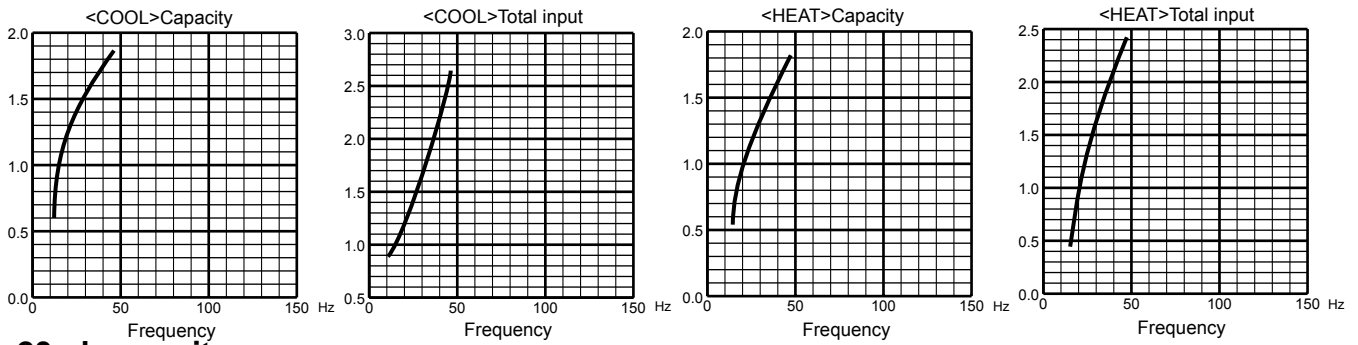

20-class unit

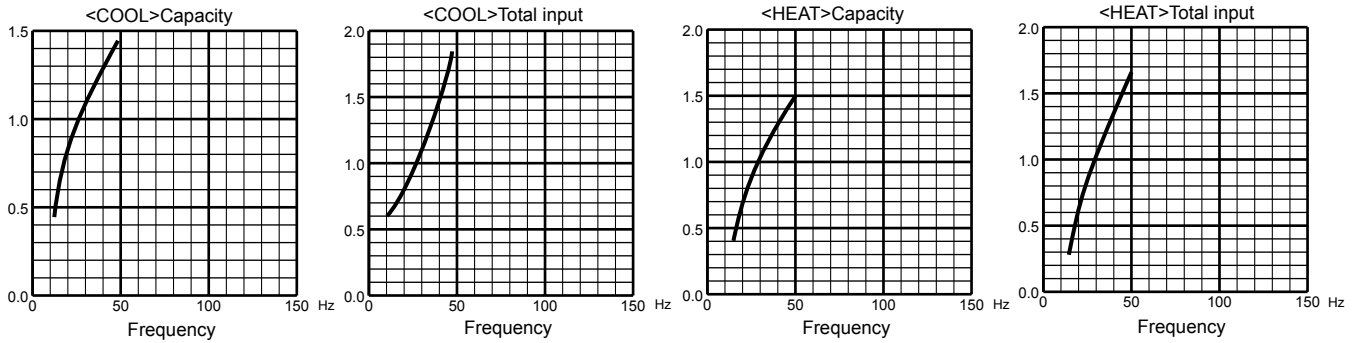

22-class unit

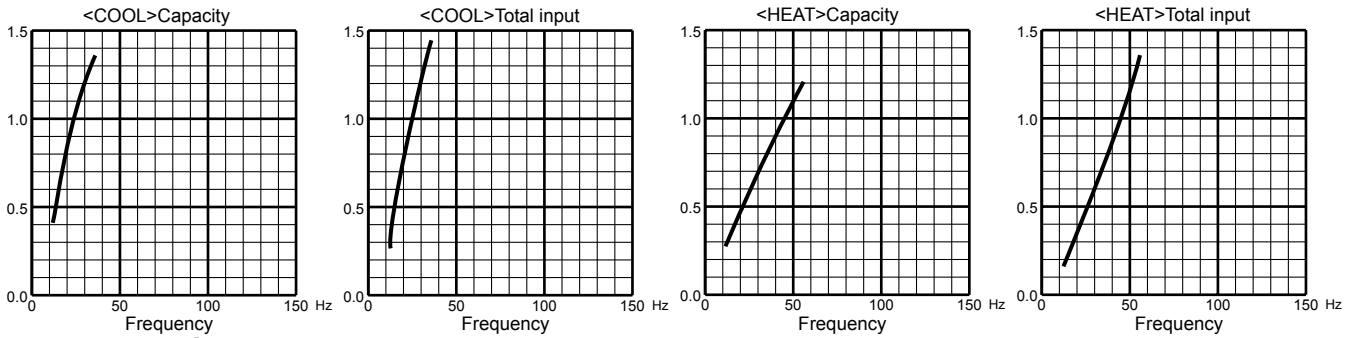

25-class unit

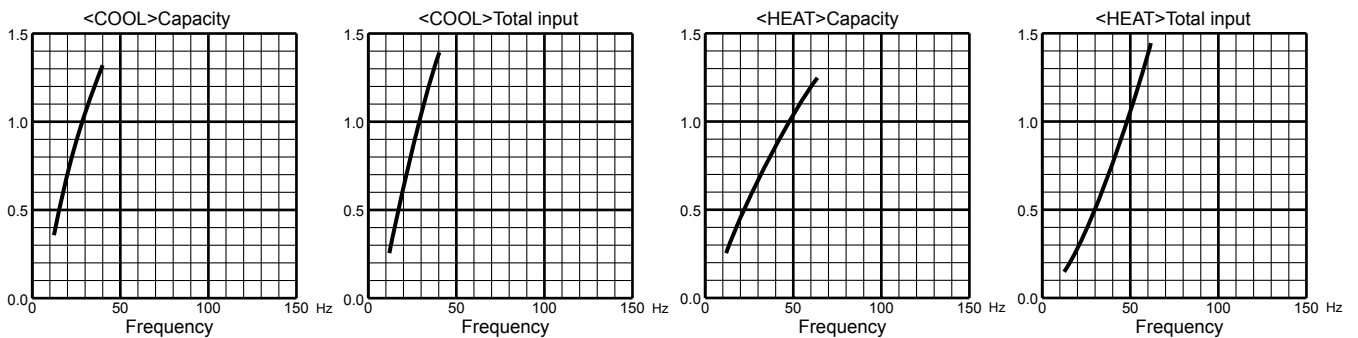

35-class unit

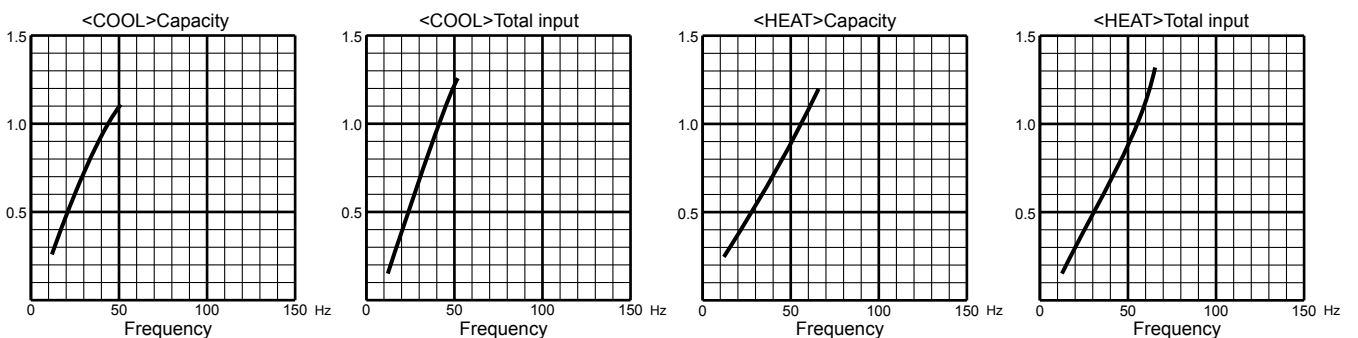

MXZ-6C120VA MXZ-6C122VA

15-class unit

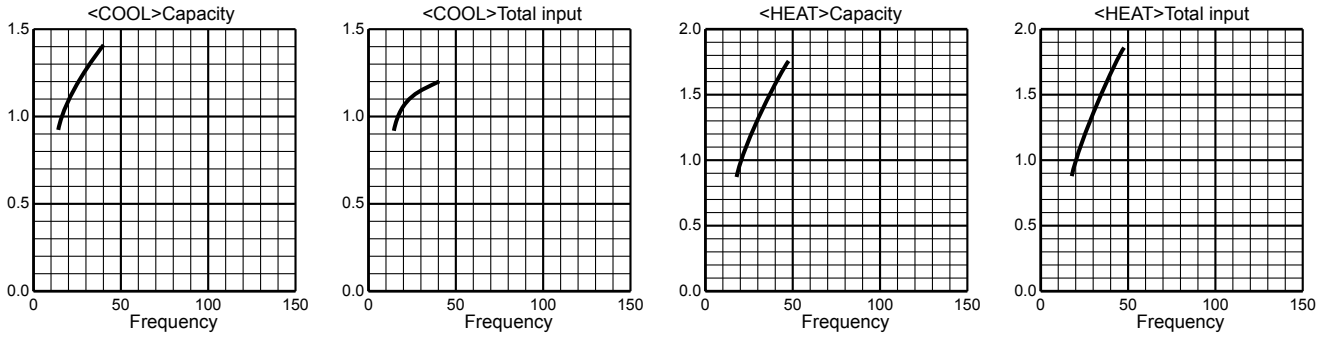

20-class unit

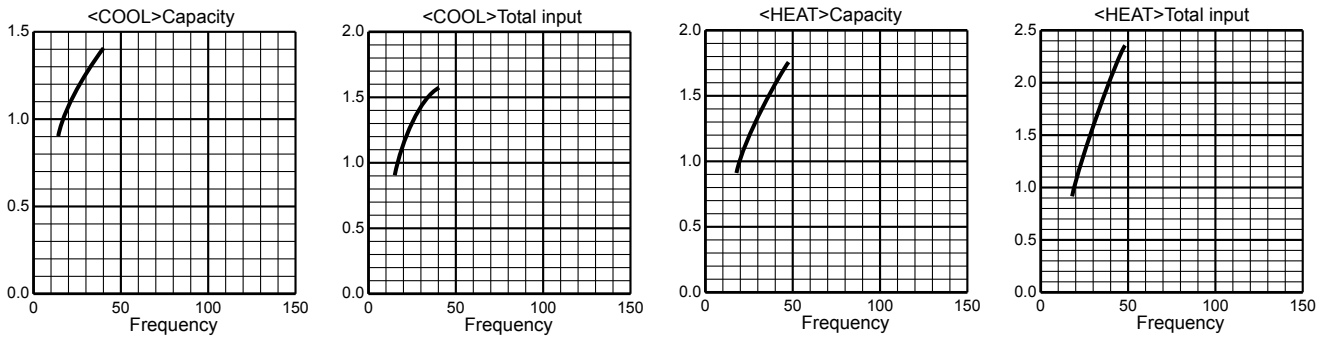

22-class unit

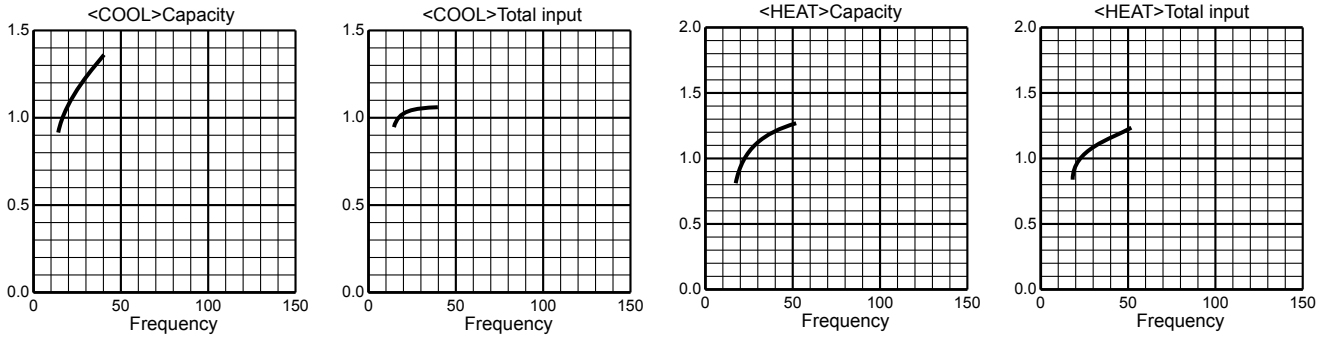

25-class unit

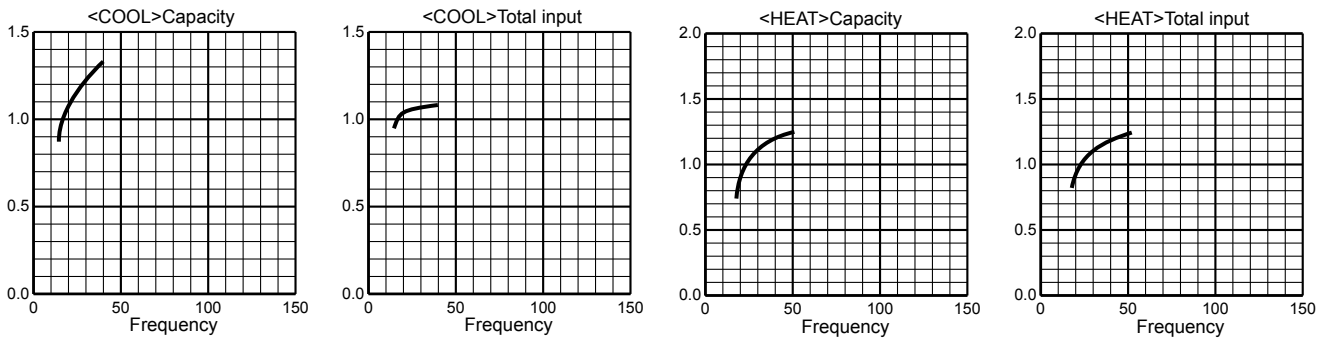

35-class unit

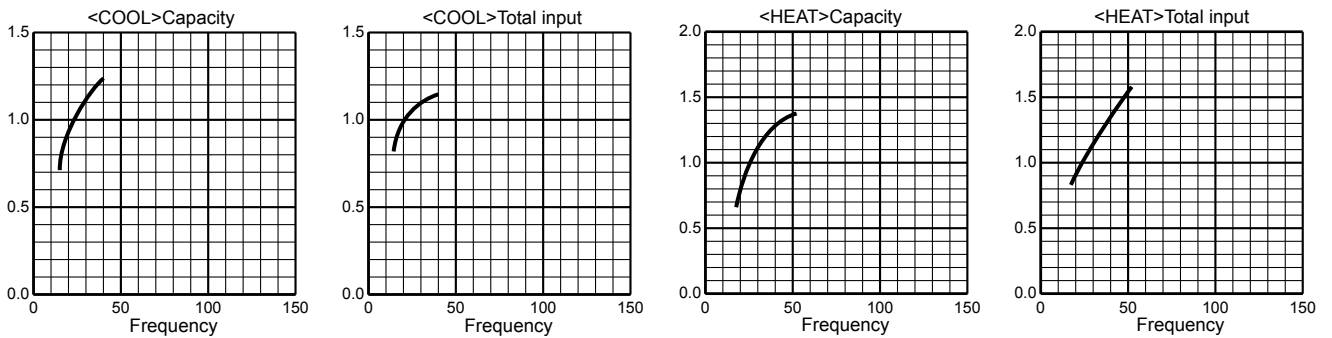

MXZ-6C120VA MXZ-6C122VA

42-class unit

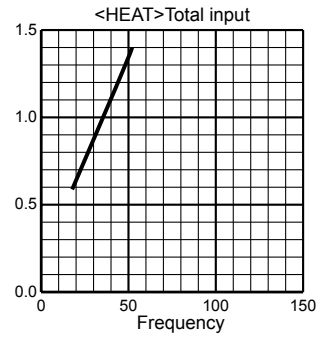
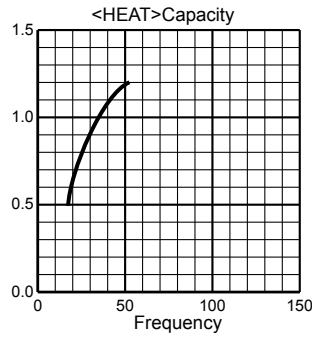
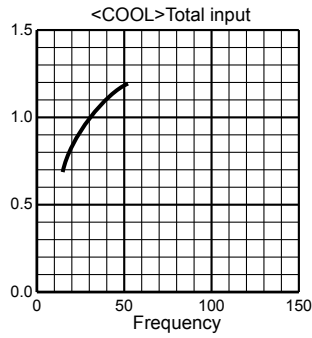
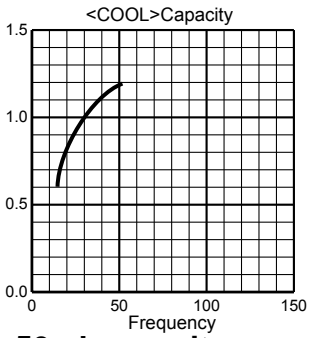

50-class unit

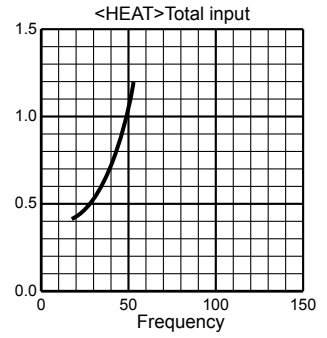
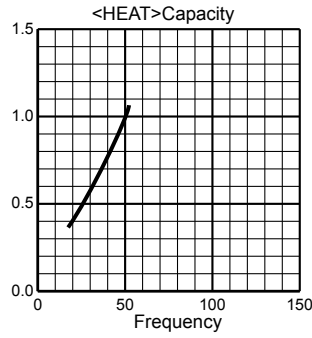
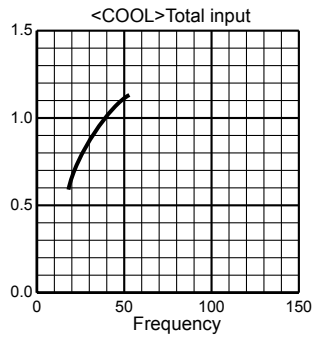
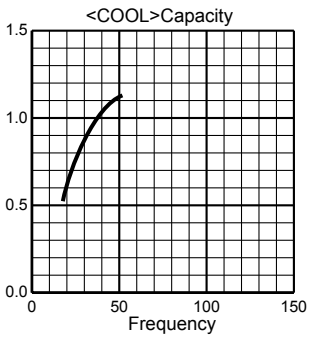

60-class unit

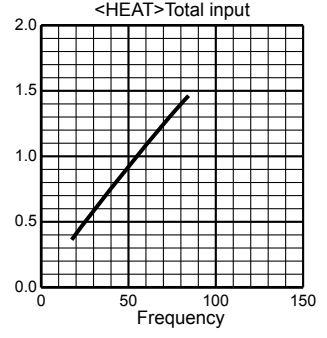
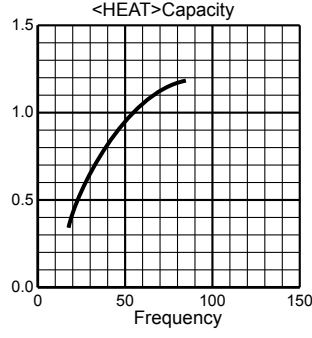
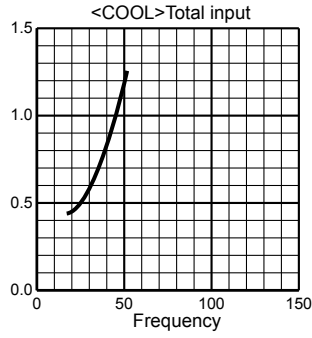
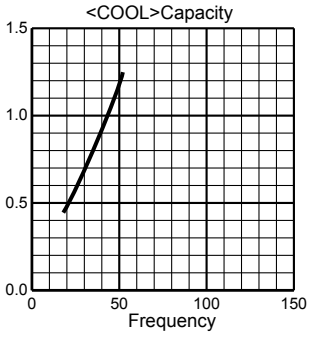

71-class unit

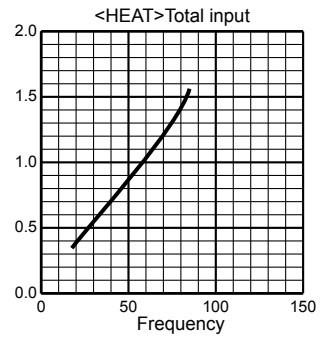
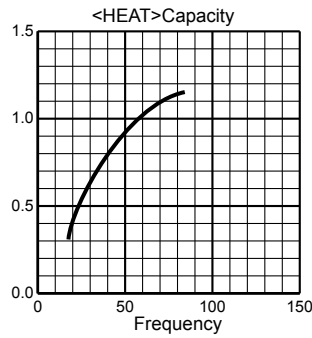
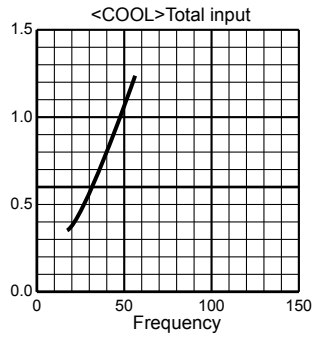
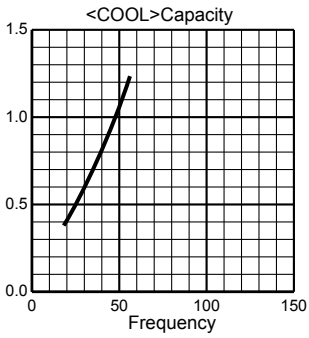

8-3. HOW TO OPERATE FIXED-FREQUENCY OPERATION <Test run operation>

1. Press EMERGENCY OPERATION switch to COOL or HEAT mode (COOL : Press once, HEAT : Press twice).
2. Test run operation starts and continues to operate for 30 minutes.
3. Compressor operates at rated frequency.
4. Indoor fan operates at High speed.
5. After 30 minutes, test run operation finishes and EMERGENCY OPERATION starts (Operation frequency of compressor varies).
6. To cancel test run operation (EMERGENCY OPERATION), press EMERGENCY OPERATION switch or any button on remote controller.

8-4. OUTDOOR LOW PRESSURE AND OUTDOOR UNIT CURRENT CURVE (single operation)

NOTE: The unit of pressure has been changed to MPa on the international system of units (SI unit system).
The conversion factor is : **1 (MPa[Gauge]) = 10.2(kgf/cm² [Gauge])**

(1) COOL operation

- ① Both indoor and outdoor units are under the same temperature/humidity condition.
- ② Operation : TEST RUN OPERATION (Refer to 8-3.)

Dry-bulb temperature (°C)	Relative humidity (%)
20	50
25	60
30	70

MXZ-2C30VA

15-class unit

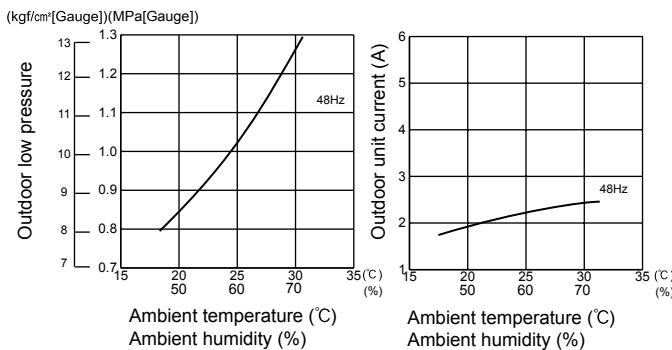

20-class unit

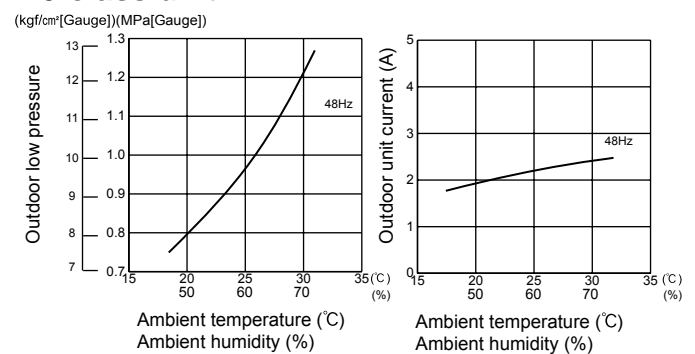

22-class unit

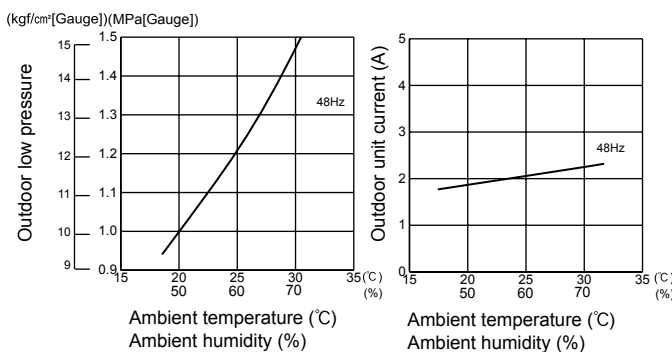

25-class unit

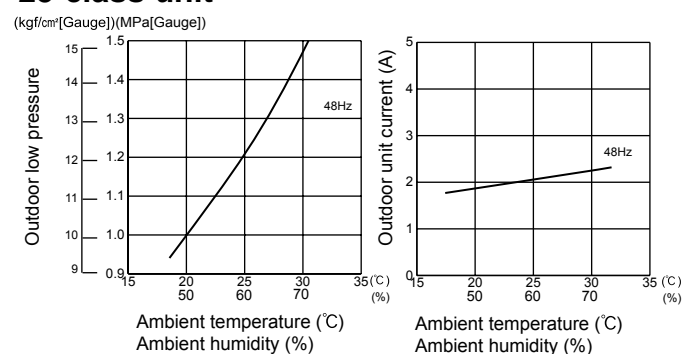

MXZ-2C40VA

15-class unit

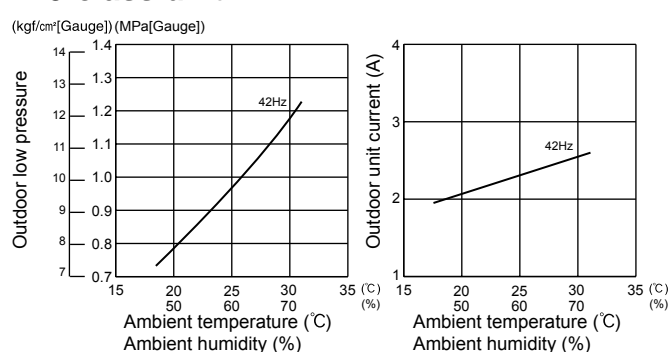

20-class unit

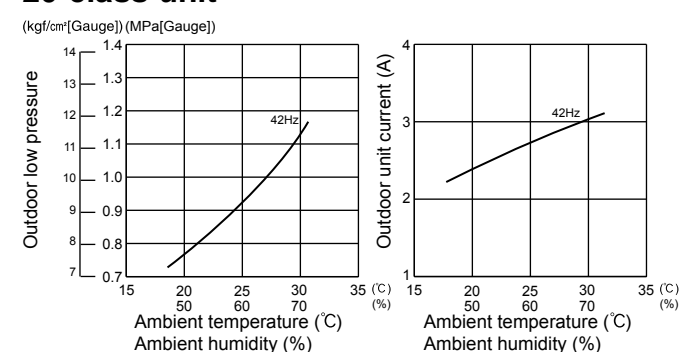

22-class unit

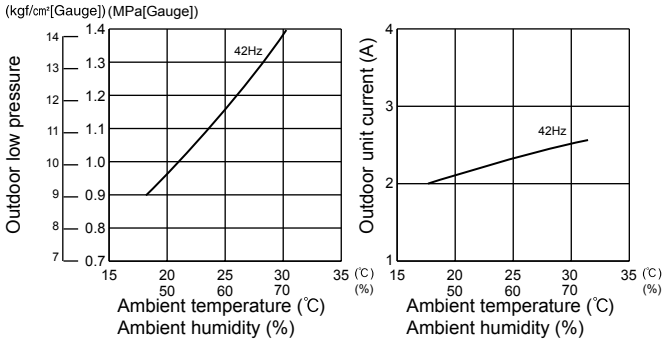

25-class unit

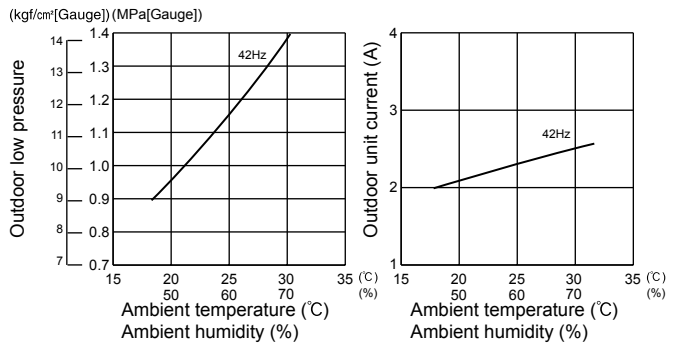

35-class unit

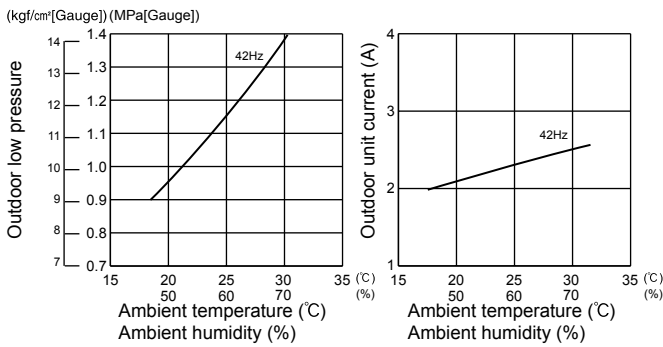

MXZ-2C52VA

15-class unit

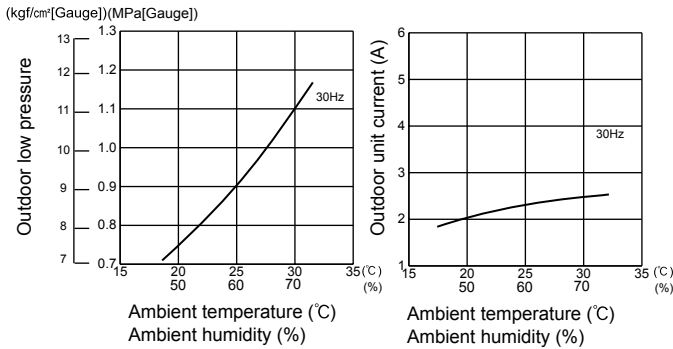

20-class unit

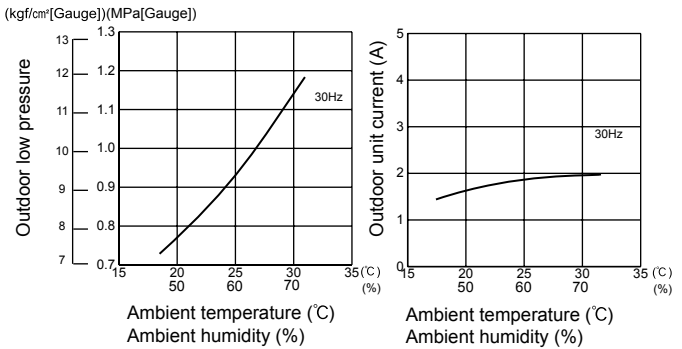

22-class unit

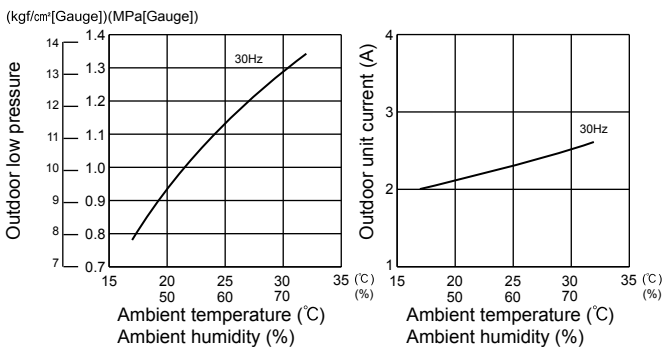

25-class unit

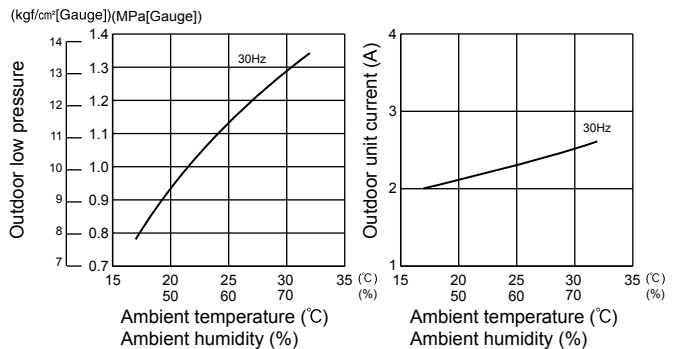

42-class unit

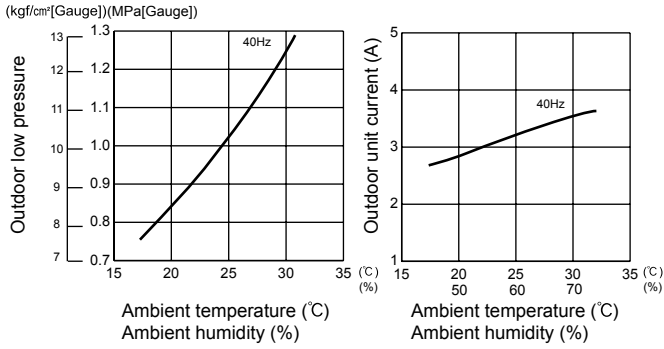

50-class unit

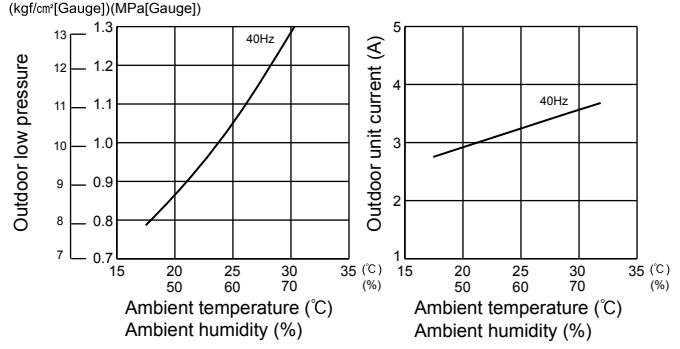

MXZ-3C68VA MXZ-4C71VA

15-class unit

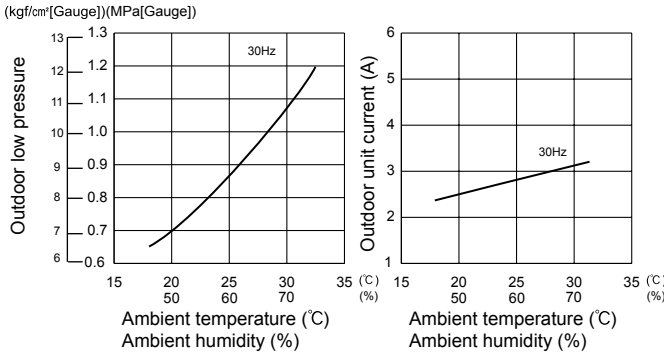

20-class unit

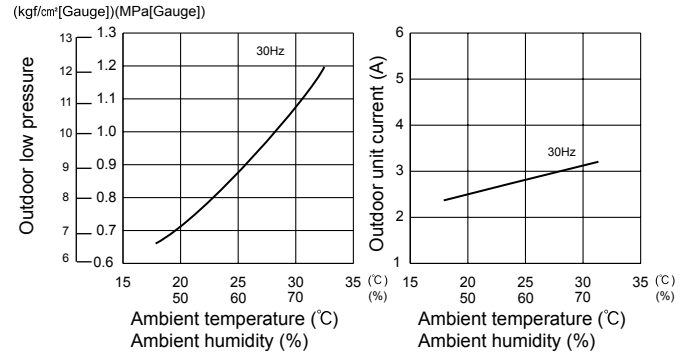

22-class unit

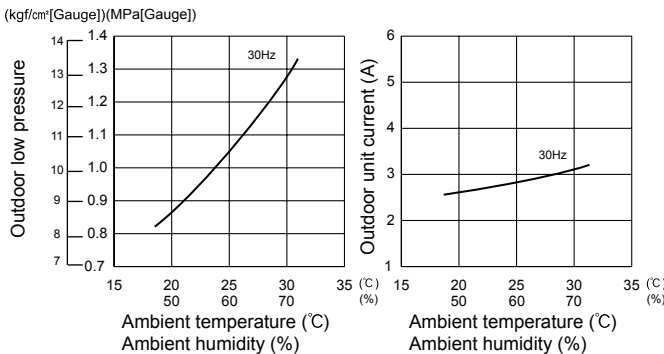

25-class unit

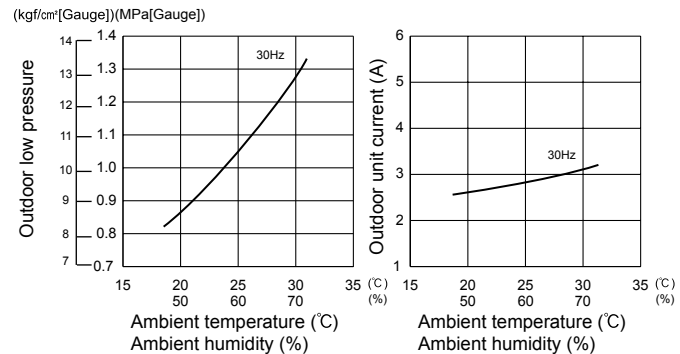

35-class unit

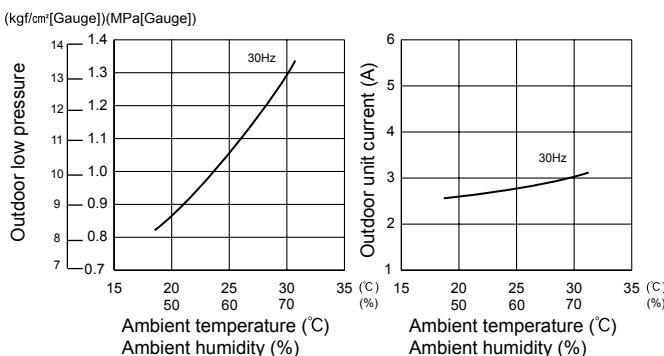

42-class unit

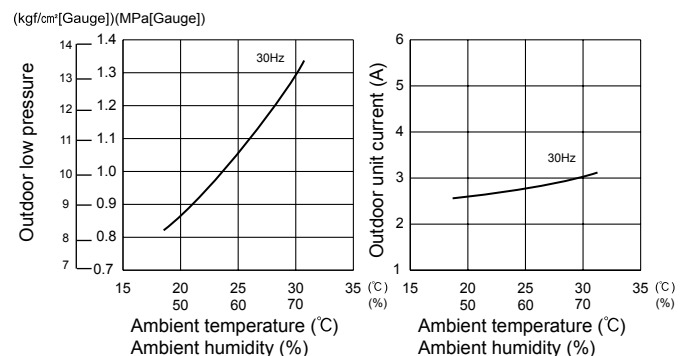

50-class unit

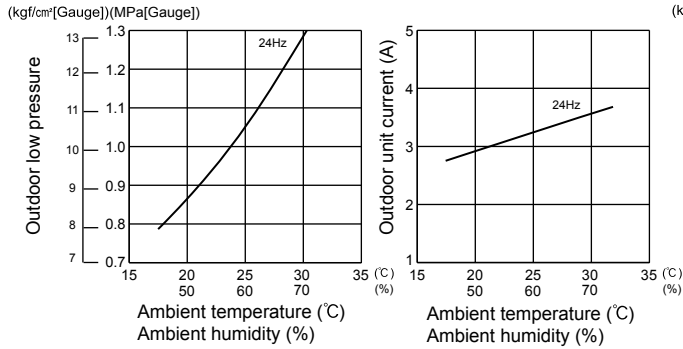

60-class unit

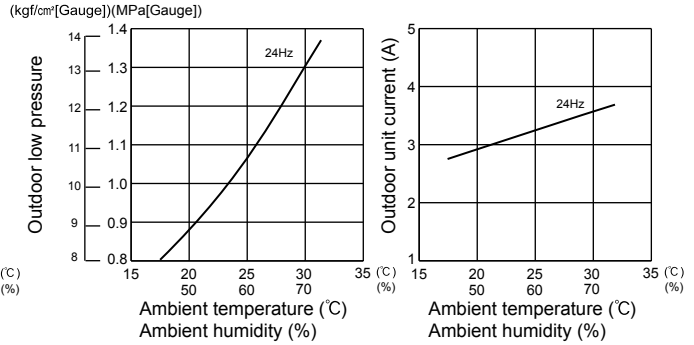

71-class unit

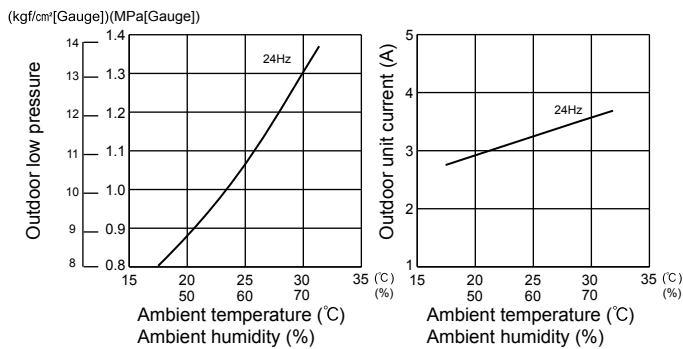

MXZ-5C100VA MXZ-5C100VA2

15-class unit

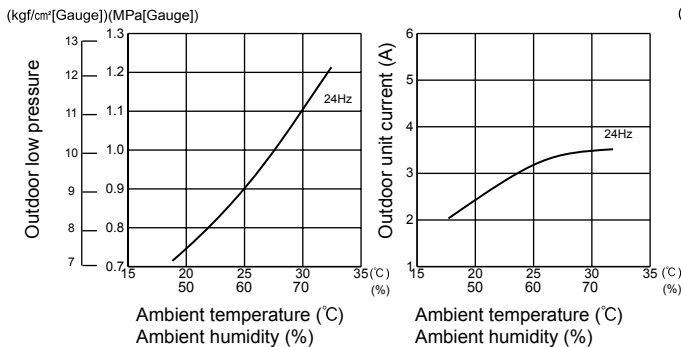

20-class unit

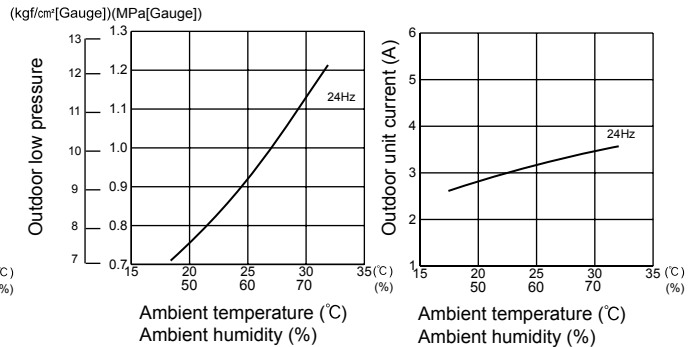

22-class unit

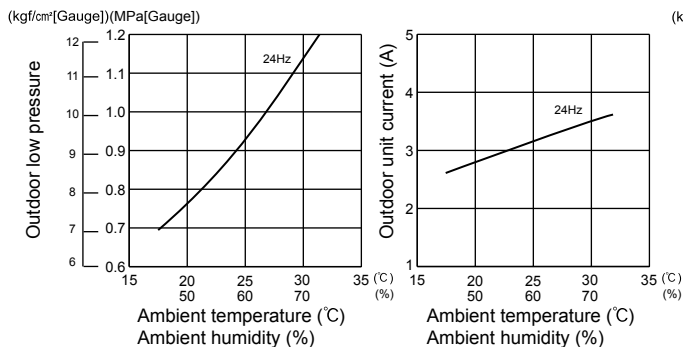

25-class unit

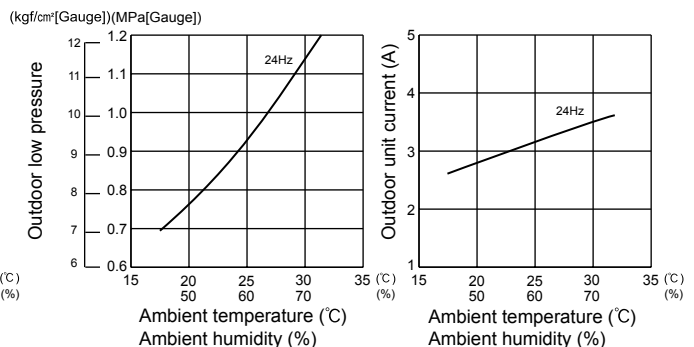

35-class unit

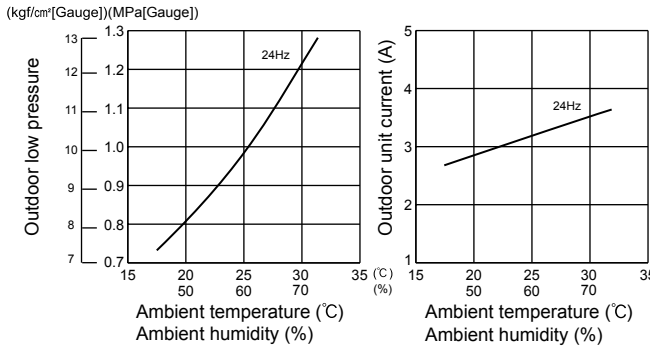

42-class unit

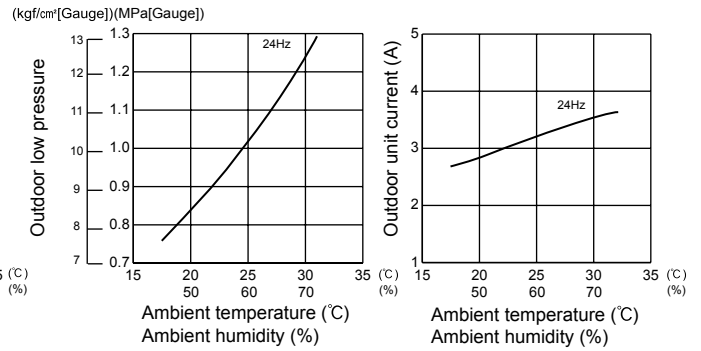

50-class unit

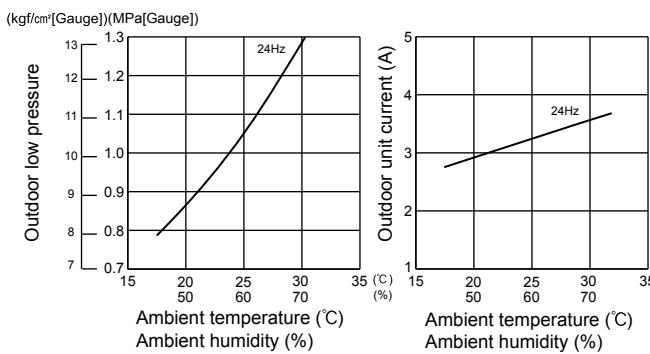

60-class unit

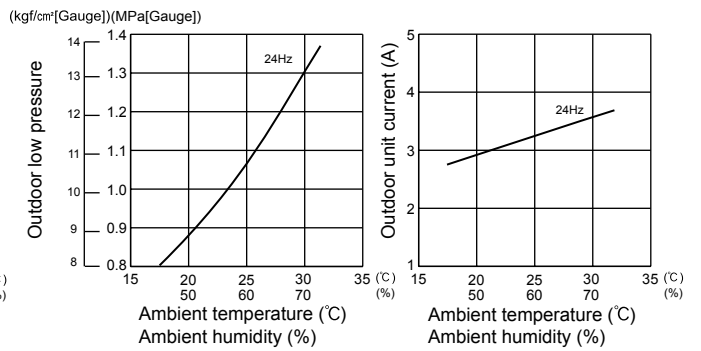

71-class unit

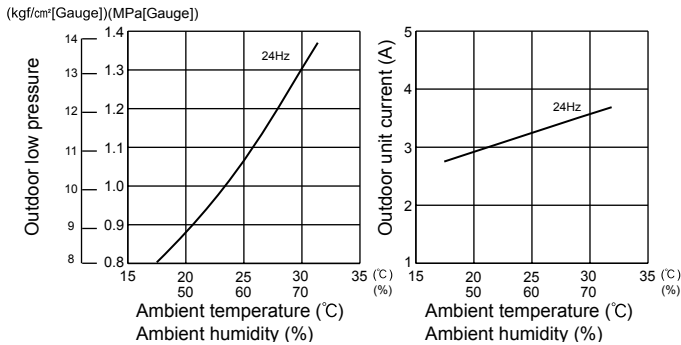

MXZ-6C120VA MXZ-6C122VA

15-class unit

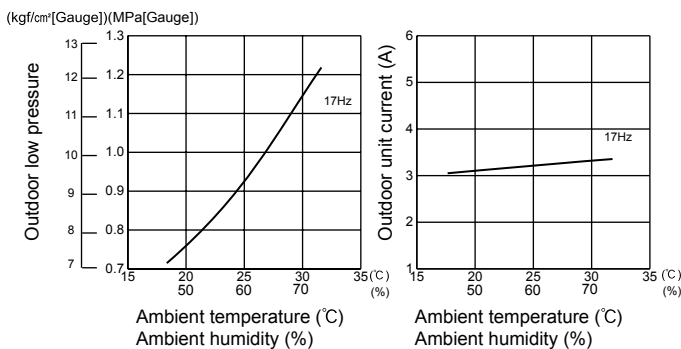

20-class unit

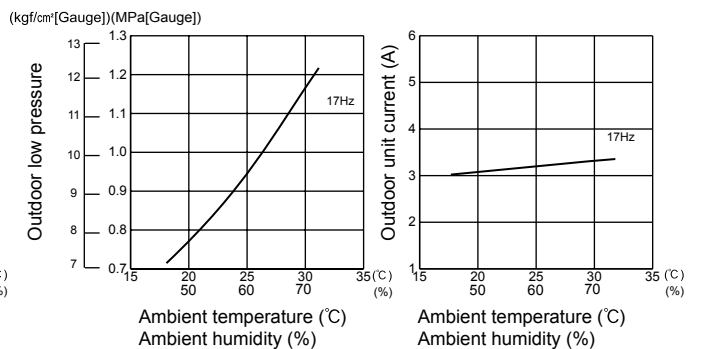

(2) HEAT operation

① Condition :

	Indoor	Outdoor			
Dry bulb temperature (°C)	20.0	2	7	15	20.0
Wet bulb temperature (°C)	14.5	1	6	12	14.5

② Operation : TEST RUN OPERATION (Refer to 8-3.)

MXZ-2C30VA

15-class unit

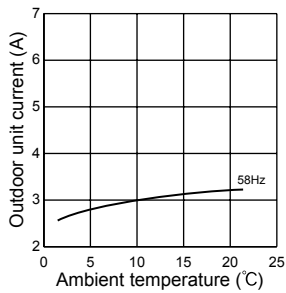

20-class unit

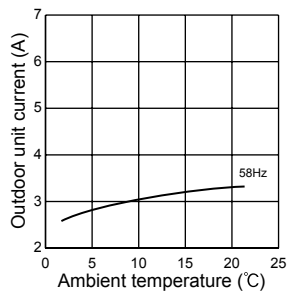

22-class unit

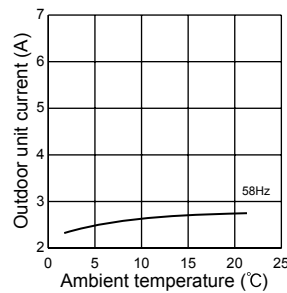

25-class unit

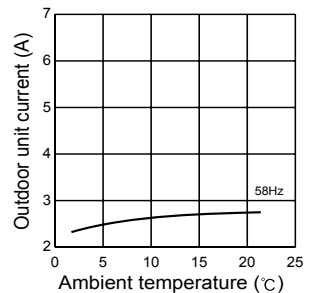

MXZ-2C40VA

15-class unit

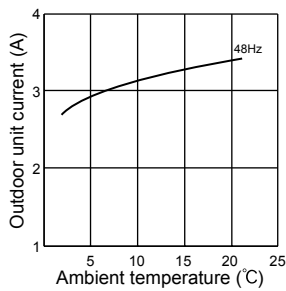

20-class unit

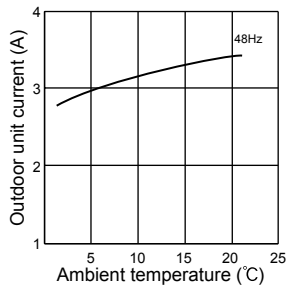

22-class unit

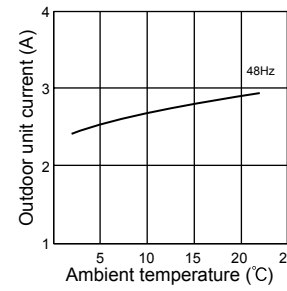

25-class unit

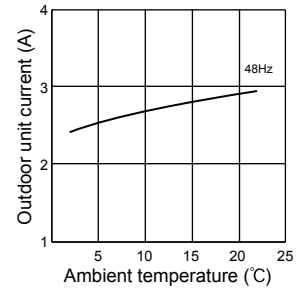

35-class unit

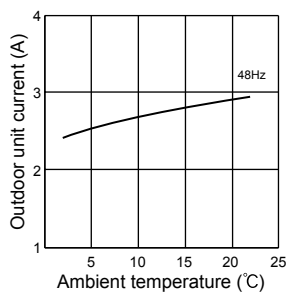

MXZ-2C52VA

15-class unit

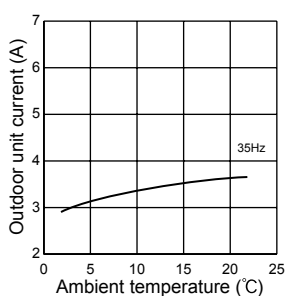

20-class unit

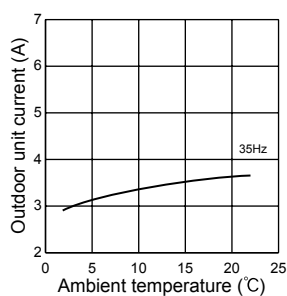

22-class unit

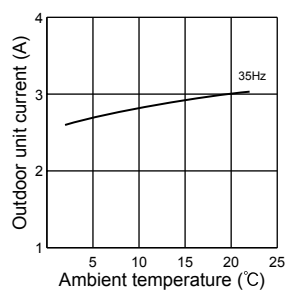

25-class unit

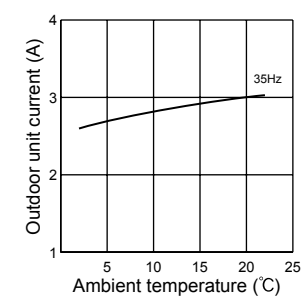

35-class unit

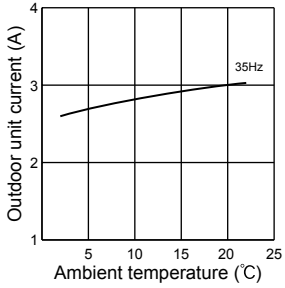

42-class unit

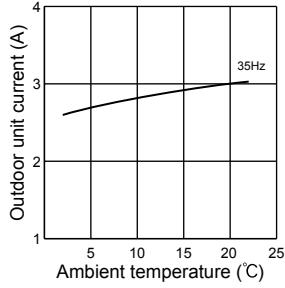

50-class unit

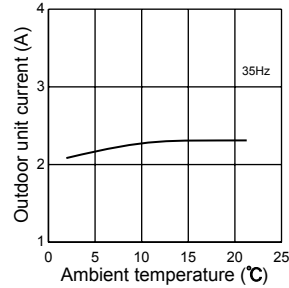

MXZ-3C54VA

15-class unit

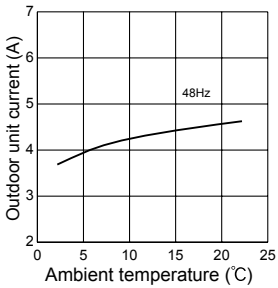

20-class unit

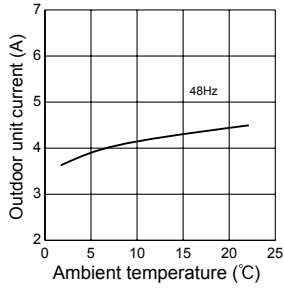

22-class unit

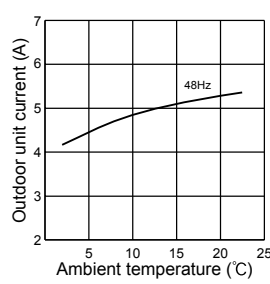

25-class unit

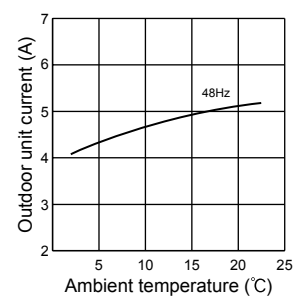

35-class unit

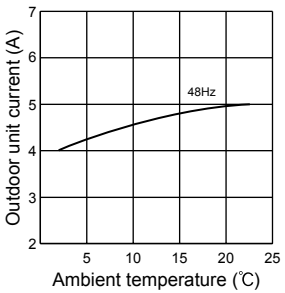

42-class unit

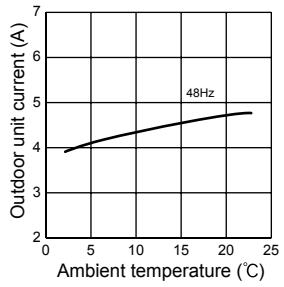

50-class unit

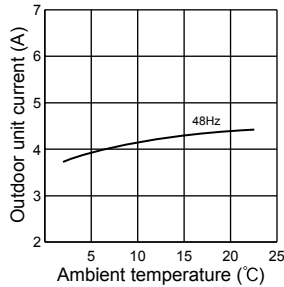

MXZ-3C68VA MXZ-4C71VA

15-class unit

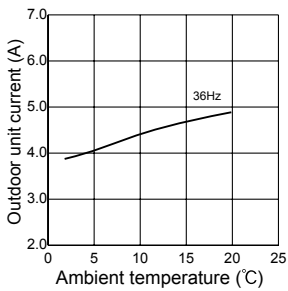

20-class unit

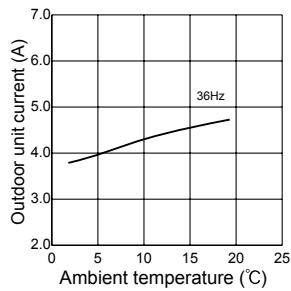

22-class unit

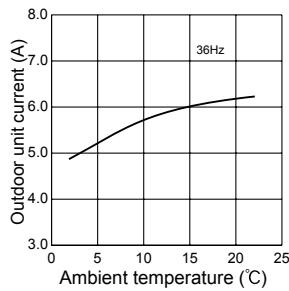

25-class unit

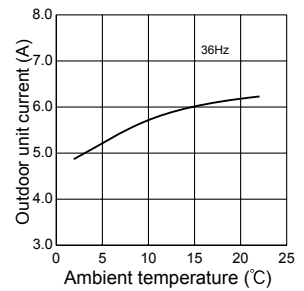

35-class unit

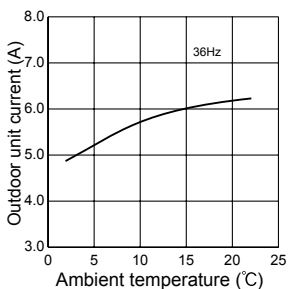

42-class unit

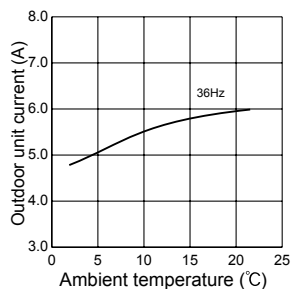

50-class unit

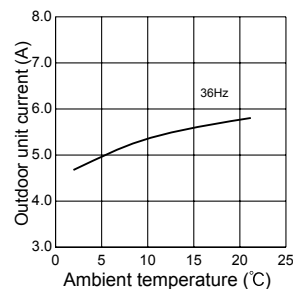

60-class unit

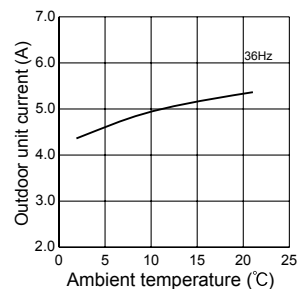

MXZ-4C80VA MXZ-4C80VA2

15-class unit

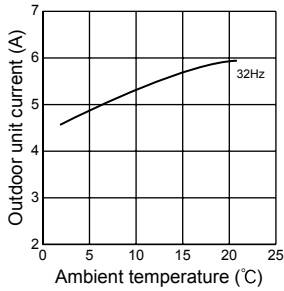

20-class unit

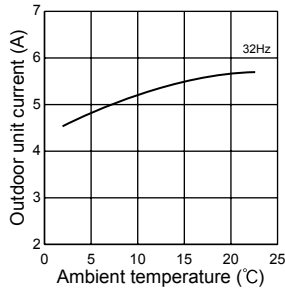

22-class unit

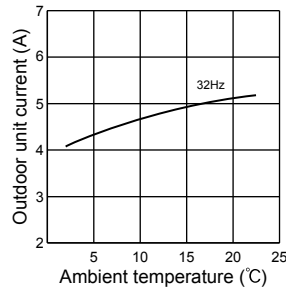

25-class unit

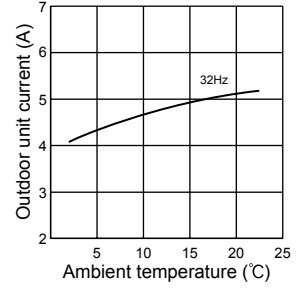

35-class unit

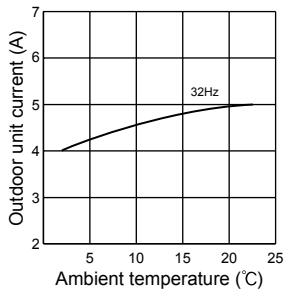

42-class unit

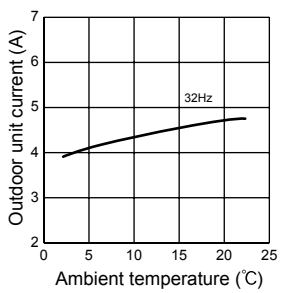

50-class unit

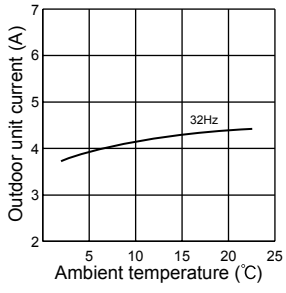

60-class unit

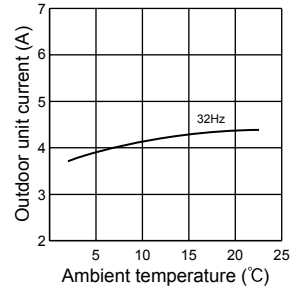

MXZ-5C100VA MXZ-5C100VA2

71-class unit

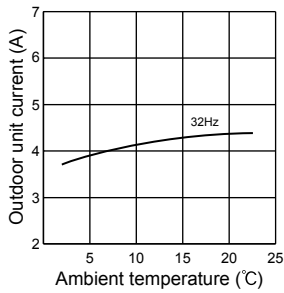

15-class unit

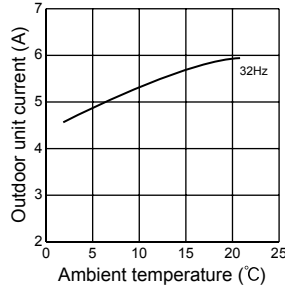

20-class unit

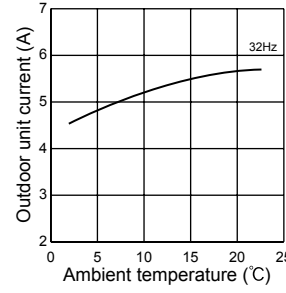

22-class unit

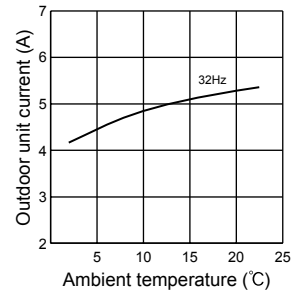

25-class unit

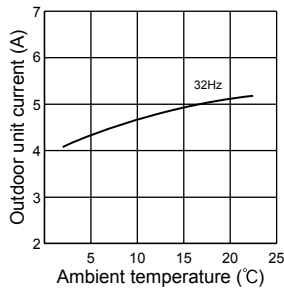

35-class unit

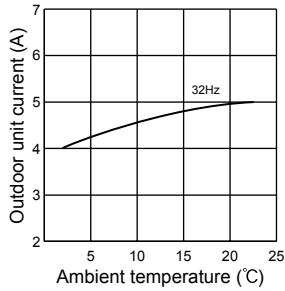

42-class unit

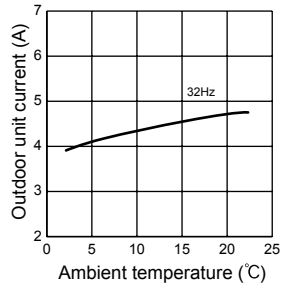

50-class unit

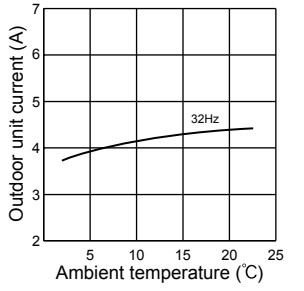

60-class unit

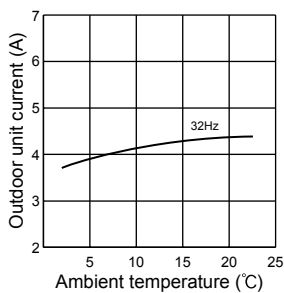

71-class unit

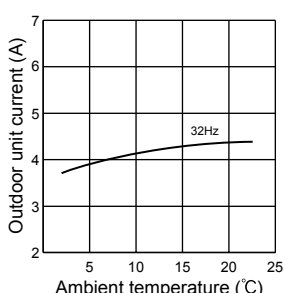

MXZ-6C120VA MXZ-6C122VA

15-class unit

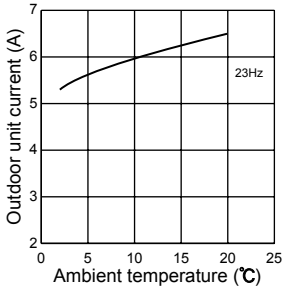

20-class unit

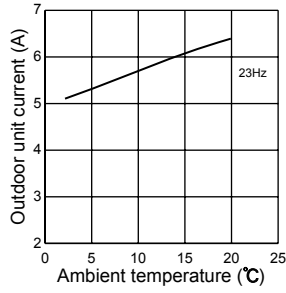

22-class unit

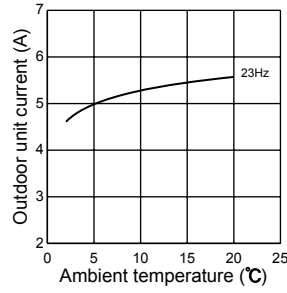

25-class unit

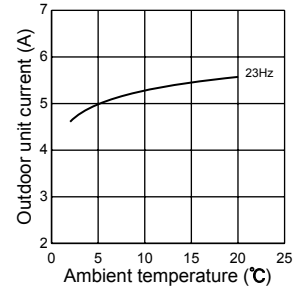

35-class unit

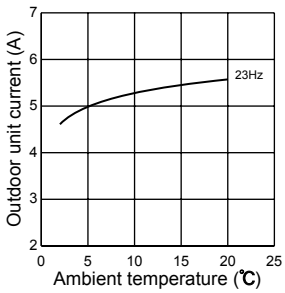

42-class unit

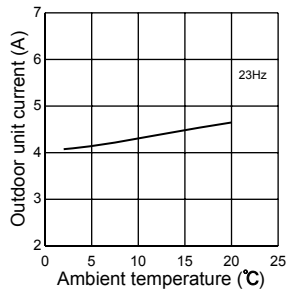

50-class unit

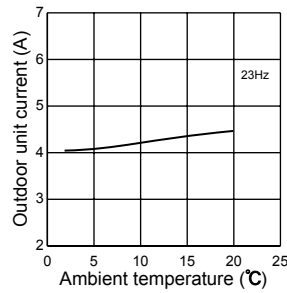

60-class unit

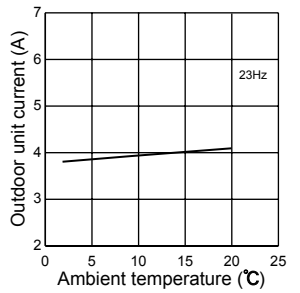

71-class unit

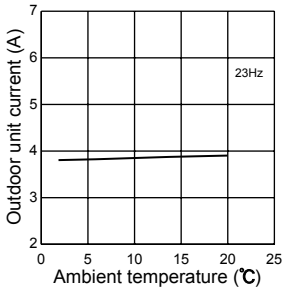

MXZ-2C30VA MXZ-2C40VA MXZ-2C52VA MXZ-3C54VA MXZ-3C68VA MXZ-4C71VA
 MXZ-4C80VA MXZ-4C80VA2 MXZ-5C100VA MXZ-5C100VA2 MXZ-6C120VA MXZ-6C122VA

Relation between main sensor and actuator

Sensor	Purpose	Actuator				
		Compressor	LEV	Outdoor fan motor	Reversing valve	Solenoid valve (MXZ-6C)
Discharge temperature thermistor	Protection	<input type="radio"/>	<input type="radio"/>			<input type="radio"/>
Indoor coil thermistor	Defrosting Protection	<input type="radio"/>	<input type="radio"/>	<input type="radio"/>		<input type="radio"/>
Defrost thermistor	Defrosting	<input type="radio"/>	<input type="radio"/>	<input type="radio"/>	<input type="radio"/>	
Fin temperature thermistor	Protection	<input type="radio"/>		<input type="radio"/>		
Ambient temperature thermistor	Control	<input type="radio"/>	<input type="radio"/>	<input type="radio"/>		<input type="radio"/>
Outdoor heat exchanger temperature	Protection	<input type="radio"/>	<input type="radio"/>	<input type="radio"/>		<input type="radio"/>
Capacity code	Control	<input type="radio"/>	<input type="radio"/>			

MXZ-2C30VA MXZ-2C40VA MXZ-2C52VA MXZ-3C54VA MXZ-3C68VA MXZ-4C71VA
MXZ-4C80VA MXZ-4C80VA2 MXZ-5C100VA MXZ-5C100VA2 MXZ-6C120VA MXZ-6C122VA

10-1. LOCKING THE OPERATION MODE OF THE AIR CONDITIONER (COOL, DRY, HEAT)

Description of the function:

With this function, you can lock the operation mode of the outdoor unit. Once the operation mode is locked to either COOL/DRY mode or HEAT mode, the air conditioner operates in that mode only.

Initial setting is required to activate this function. Please explain about this function to your customers and ask them whether they want to use it.

[How to lock the operation mode]

- ① Turn OFF the power supply for the air conditioner before making the setting.
- ② Set SW1 on the outdoor P.C. board as shown in the right figure.
- ③ Turn ON the power supply for the air conditioner.

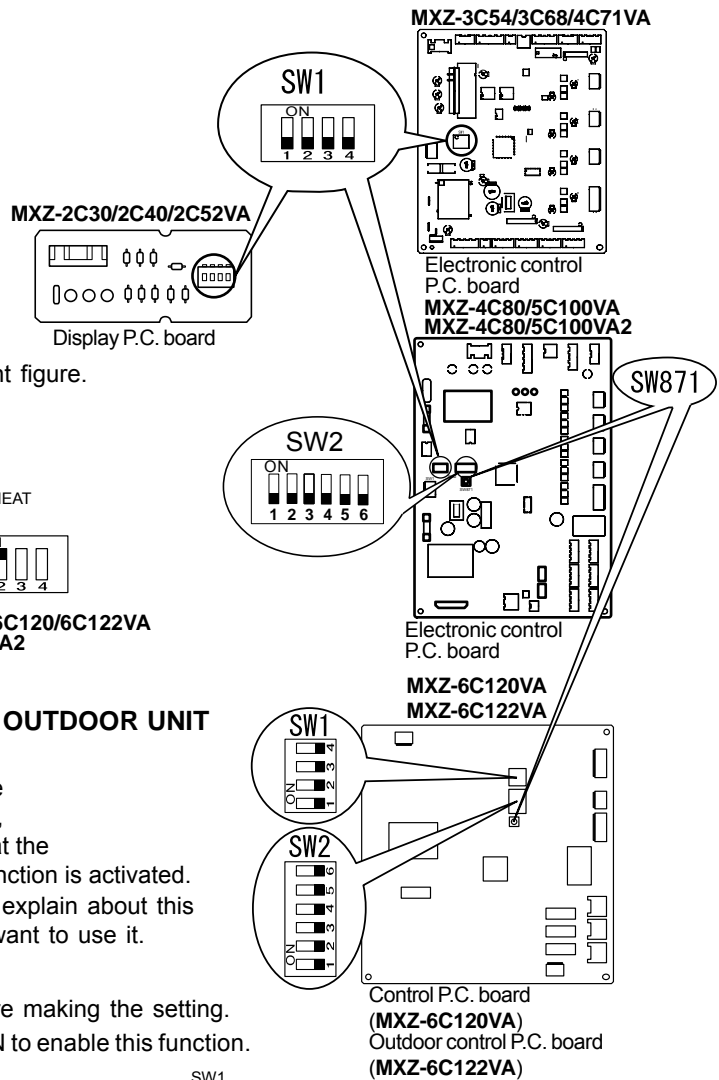
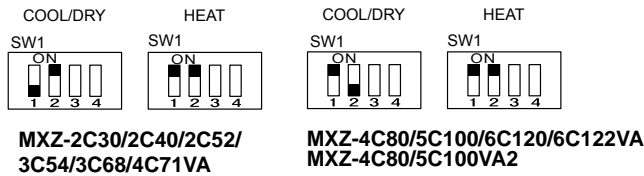

10-2. LOWERING THE OPERATING NOISE OF THE OUTDOOR UNIT

Description of the function:

With this function, you can lower the operating noise of the outdoor unit when the operation load is small, for example, during nighttime in COOL mode. However, please note that the cooling and heating capacity can also be lowered if this function is activated. Initial setting is required to activate this function. Please explain about this function to your customers and ask them whether they want to use it.

[How to lower the operating noise]

- ① Turn OFF the power supply for the air conditioner before making the setting.
- ② Set the "3" Switch of SW1 on the outdoor P.C. board to ON to enable this function.
- ③ Turn ON the power supply for the air conditioner.

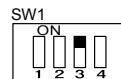

10-3. PRE-HEAT CONTROL

If moisture gets into the refrigerant cycle, or when refrigerant is liquefied and collected in the compressor, it may interfere the start-up of the compressor.

To improve start-up condition, the compressor is energized even while it is not operating.

This is to generate heat at the winding.

The compressor uses about 50 W when pre-heat control is turned ON.

Pre-heat control is ON at initial setting.

[How to deactivate pre-heat control]

- ① Turn OFF the power supply for the air conditioner before making the setting.
- ② Set the "4" of SW2 on the outdoor P.C. board to ON to deactivate pre-heat control function (MXZ-4C80VA, MXZ-4C80VA2, MXZ-5C100VA, MXZ-5C100VA2, MXZ-6C120VA, MXZ-6C122VA).
 Set the "4" of SW1 on the electronic control P.C. board to ON to deactivate pre-heat control function (MXZ-3C54VA, MXZ-3C68VA, MXZ-4C71VA).
 Cut the JK wire of the inverter P.C. board to deactivate pre-heat control function (MXZ-2C30VA, MXZ-2C40VA, MXZ-2C52VA).
- ③ Turn ON the power supply for the air conditioner.

NOTE: Pre-heat control will be turned OFF when the breaker is turned OFF.

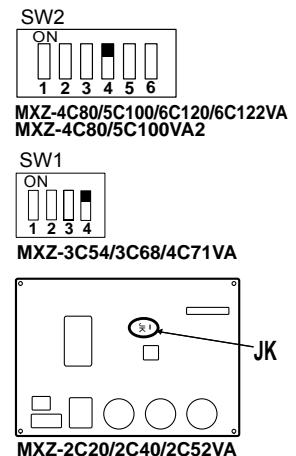

10-4. AUTO LINE CORRECTING

Outdoor unit has an auto line correcting function which automatically detects and corrects improper wiring or piping.

<MXZ-2C30VA, MXZ-2C40VA, MXZ-2C52VA>

Improper wiring or piping can be automatically detected when one indoor unit is operated in COOL mode for 30 minutes. When improper wiring or piping is detected, wiring lines are corrected (A to B/ B to A) with the software.

NOTE:

This function may not work due to the condition or environment of the unit, such as the following:

- gas leak, closed stop valve
- unit failure such as defective LEV
- indoor/outdoor temperature

<Correct line>

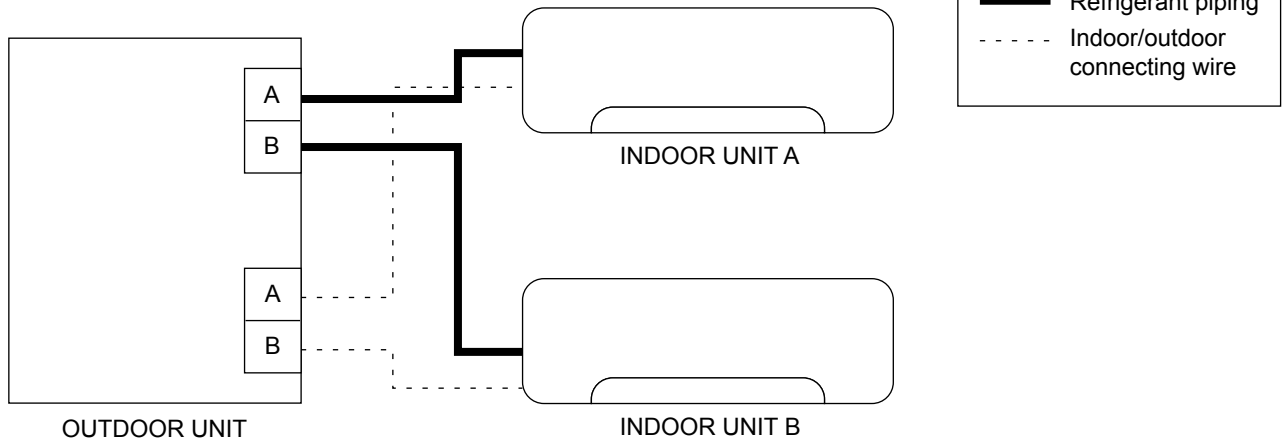

<Incorrect wiring>

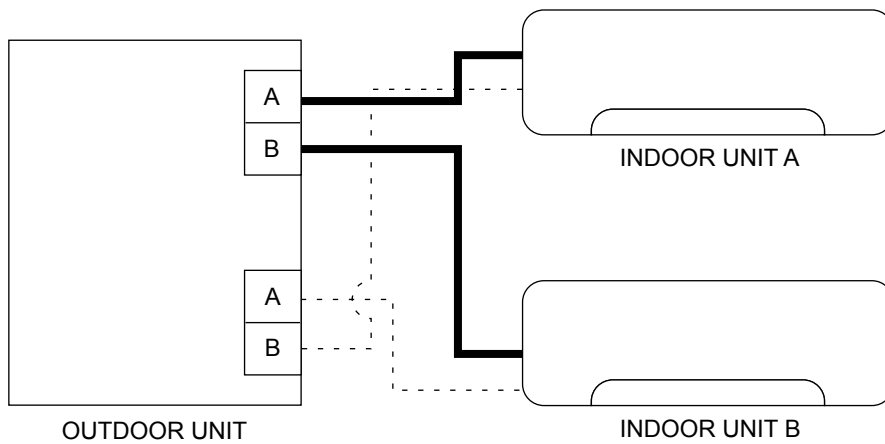

<Incorrect piping>

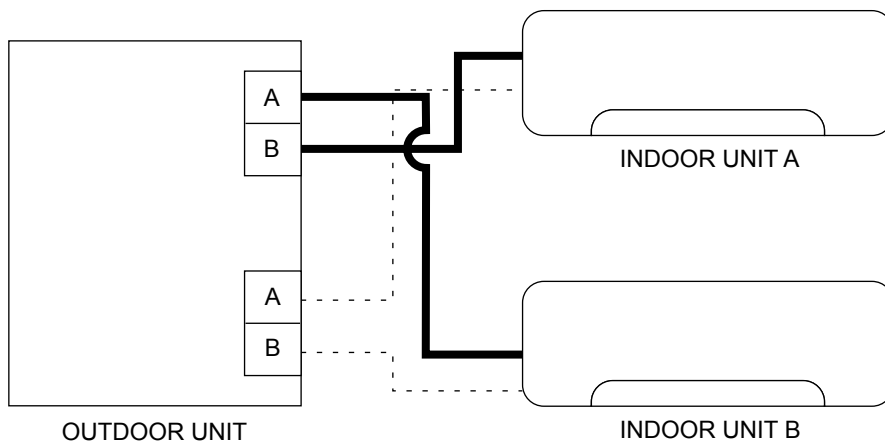

The record of auto line correcting can be confirmed in the following way:

- ① Turn OFF the power supply.
- ② Turn ON the "4" of SW1 on the display P.C. board.
- ③ Turn ON the power supply.
- ④ Confirm the correction by the blinking of LED.



Number of blinks		Wiring line
LED1 (Red)	LED2 (Yellow)	
Once	Once	Not corrected
3 times	3 times	Corrected

- ⑤ Turn OFF the power supply after the confirmation, and turn OFF the "4" of SW1 on the display P.C. board.
- ⑥ Turn ON the power supply.

NOTE: This function does not work when the jumper wire JGO on the inverter P.C. board is cut.

<MXZ-4C80VA, MXZ-4C80VA2, MXZ-5C100VA, MXZ-5C100VA2, MXZ-6C120VA, MXZ-6C122VA>

Improper wiring or piping can be automatically detected by pressing the piping/wiring correction switch (SW871). When improper wiring or piping is detected, wiring lines are corrected. This will be completed in about 10 to 20 minutes.

[How to activate this function]

1. Check that outside temperature is above 0°C .
(This function does not work when outside temperature is not above 0°C.)
2. Check that the stop valves of the liquid pipe and gas pipe are open.
3. Check that the wiring between indoor and outdoor unit is correct.
(If the wiring is not correct, this function does not work.)
4. Turn ON the power supply and wait at least 1 minute.
5. Press the piping/wiring correction switch (SW871) on the outdoor P.C. board.
Do not touch energized parts.

LED indication during detection:

LED1(Red)	LED2(Yellow)	LED3(Green)
Lighted	Lighted	Once

LED indication after detection:

LED1(Red)	LED2(Yellow)	LED3(Green)	Indication
Lighted	Not lighted	Lighted	Completed (Problem corrected/normal)
Blinking	Blinking	Blinking	Not completed (Detectin failed)
Other indications			Refer to "SAFETY PRECAUTIONS WHEN LED FLASHES" located behind the service panel.

*Make sure that the valves are open and the pipes are not collapsed or clogged.

6. Press the switch to cancel.

LED indication after cancel:

LED1(Red)	LED2(Yellow)	LED3(Green)
Lighted	Lighted	Not lighted

NOTE: Indoor unit cannot be operated while this function is activated.

When this function is activated while indoor unit is operating, the operation will be stopped.

Operate indoor unit after the auto line correcting is finished.

Pressing the switch during detection cancels this function.

The record of auto line correcting can be confirmed in the following way:

Press the switch for more than 5 sec.

LED will show the record of auto correcting for about 30 sec. as shown in the table below:

Number of blinks			Wiring line
LED1(Red)	LED2(Yellow)	LED3(Green)	
Once	Once	Lighted	Not corrected
3 times	3 times	Lighted	Corrected

NOTE: Activate this function to confirm the correct wiring after replacing the outdoor P.C. board.

(Previous records are deleted when the outdoor P.C. board is replaced.)

The record cannot be shown if auto line correcting is not canceled (Refer to "How to activate this function").

10-5. INCREASING MAXIMUM COMPRESSOR OPERATIONAL FREQUENCY AND FAN SPEED OF THE OUTDOOR UNIT

<MXZ-4C80VA, MXZ-4C80VA2, MXZ-5C100VA, MXZ-5C100VA2>

Compressor operational frequency and fan speed can be increased.
Capacity of the unit can be improved with this function.

NOTE:

Compressor operational frequency may not be increased under primary current restriction or high pressure protection.
Compressor operational frequency will not be increased when 1 or 2 indoor units are operating.
This function does not work when the function which lowers the operating noise of the outdoor unit is activated.
Noise level of the outdoor unit will increase (You may need to explain this to your customers.)

[How to increase maximum compressor operational frequency and fan speed]

- ① Turn OFF the power supply for the air conditioner before making the setting.
- ② Set the "3" of SW2 on the outdoor P.C. board to ON to enable this function.
- ③ Turn ON the power supply for the air conditioner.



10-6. CHANGING DEFROST FINISH TEMPERATURE AND HEAT OPERATION TIME

<MXZ-4C80VA, MXZ-4C80VA2, MXZ-5C100VA, MXZ-5C100VA2, MXZ-6C120VA, MXZ-6C122VA>

If defrosting operation starts more than necessary, the defrost finish temperature and heat operation time can be changed.
The number of defrosting operation and defrosting time can be reduced with this function.

	Initial setting		Changed
	4C/5C	6C	4C/5C/6C
Defrost finish temperature (°C)	10	13	5
Heat operation time (min.)	31	31	40

[How to change defrost finish temperature and heat operation time]

- ① Turn OFF the power supply for the air conditioner before making the setting.
- ② Set the "1" of SW2 on the outdoor P.C. board to ON to enable this function.
- ③ Turn ON the power supply for the air conditioner.

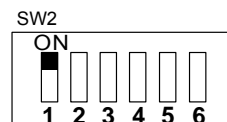

10-7. CHANGING THE AMPERE LIMIT

<MXZ-4C80VA, MXZ-4C80VA2, MXZ-5C100VA, MXZ-5C100VA2, MXZ-6C120VA, MXZ-6C122VA>

With this function, you can change the current that flows in the outdoor unit.

NOTE:

Use this function only when the amount of current exceeds the allowed value.

[How to change the ampere limit]

- ① Turn OFF the power supply for the air conditioner before making the setting.
- ② Make the setting referring to the table on the right.
- ③ Turn ON the power supply for the air conditioner.

SW2	MXZ-4C80VA MXZ-4C80VA2 MXZ-5C100VA MXZ-5C100VA2	MXZ-6C120VA MXZ-6C122VA
	10.5A	20A
	15.5A	25A
	Initial setting Full	

MXZ-2C30VA MXZ-2C40VA MXZ-2C52VA MXZ-3C54VA MXZ-3C68VA MXZ-4C71VA
 MXZ-4C80VA MXZ-4C80VA2 MXZ-5C100VA MXZ-5C100VA2 MXZ-6C120VA MXZ-6C122VA

11-1. CAUTIONS ON TROUBLESHOOTING

1. Before troubleshooting, check the following:

- 1) Check the power supply voltage.
- 2) Check the indoor/outdoor connecting wire for miswiring.

2. Take care of the following during servicing

- 1) Before servicing the air conditioner, be sure to turn OFF the unit first with the remote controller, and after confirming the horizontal vane is closed, turn OFF the breaker and/or disconnect the power plug.
- 2) Be sure to turn OFF the power supply before removing the front panel, the cabinet, the top panel, and the P.C. board.
- 3) When removing the electrical parts, be careful of the residual voltage of smoothing capacitor.
- 4) When removing the P.C. board, hold the edge of the board with care NOT to apply stress on the components.
- 5) When connecting or disconnecting the connectors, hold the housing of the connector. DO NOT pull the lead wires.

<Incorrect>

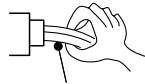

Lead wiring

<Correct>

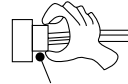

Housing point

3. Troubleshooting procedure

- 1) Check if the OPERATION INDICATOR lamp on the indoor unit is flashing on and off to indicate an abnormality. To make sure, check how many times the OPERATION INDICATOR lamp is flashing on and off before starting service work.
- 2) Before servicing, check that the connector and terminal are connected properly.
- 3) When the P.C. board seems to be defective, check the copper foil pattern for disconnection and the components for bursting and discoloration.
- 4) When troubleshooting, refer to 11-2, 11-3 and 11-4.

11-2. FAILURE MODE RECALL FUNCTION

This air conditioner can memorize the abnormal condition which has occurred once.

Even though LED indication listed on the troubleshooting check table (11-4) disappears, the memorized failure details can be recalled.

1. Flow chart of failure mode recall function for the indoor/outdoor unit

Refer to the service manual of indoor unit.

2. Flow chart of the detailed outdoor unit failure mode recall function

Operational procedure

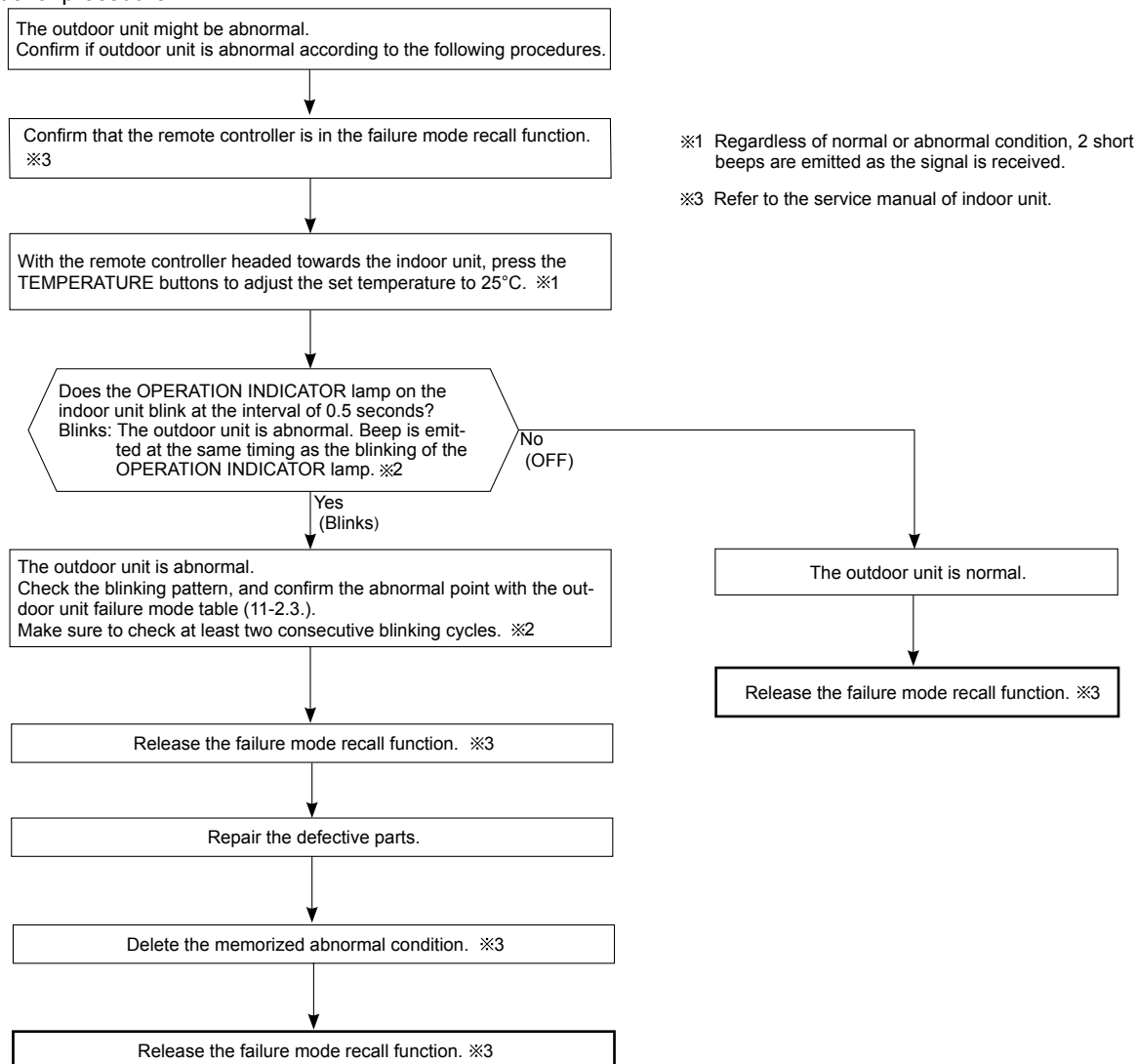

NOTE: 1. Make sure to release the failure mode recall function once it is set up, otherwise the unit cannot operate properly.
2. If the abnormal condition is not deleted from the memory, the last abnormal condition is kept memorized.

※2. Blinking pattern when outdoor unit is abnormal:

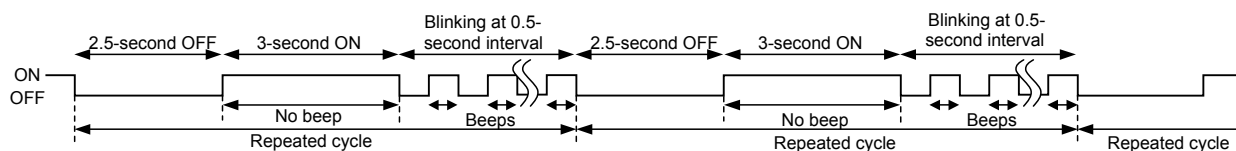

3. Outdoor unit failure mode table

MXZ-2C

Upper or left lamp of OPERATION INDICATOR lamp (Indoor unit)	Abnormal point (Failure mode / protection)	LED indication (Outdoor P.C. board)		Condition	Remedy	Indoor/outdoor unit failure mode recall function
		LED 1	LED 2			
OFF	None (Normal)	Lighted	Lighted	—	—	—
2-time flash	Outdoor power system	Lighted	Lighted	Overcurrent protection cut-out operates 3 consecutive times within 1 minute after the compressor gets started.	<ul style="list-style-type: none"> • Check the connection of the compressor connecting wire. • Refer to 11-6.⑤ "How to check inverter/compressor". • Check the stop valve. 	○
3-time flash	Discharge temperature thermistor	Lighted	Once	Thermistor shorts or opens during compressor running.	<ul style="list-style-type: none"> • Refer to 11-6.⑤ "Check of outdoor thermistors". 	○
	Defrost thermistor	Lighted	Once			
	Ambient temperature thermistor	Lighted	Twice			
	Fin temperature thermistor	Lighted	3 times			
	P.C. board temperature thermistor	Lighted	4 times			
Outdoor heat exchanger temperature thermistor	Lighted	9 times	<ul style="list-style-type: none"> • Replace the inverter P.C. board. • Refer to 11-6.⑤ "Check of outdoor thermistors". 			
4-time flash	Overcurrent	Once	Not lighted	14 A (MXZ-2C30VA)/18 A (MXZ-2C40VA, MXZ-2C52VA) current flows into intelligent power module.	<ul style="list-style-type: none"> • Reconnect compressor connector. • Refer to 11-6.⑤ "How to check inverter/compressor". • Check the stop valve. 	—
	Compressor	Twice	Not lighted	The possibility of intercepting the overcurrent by the compressor lock is high.	<ul style="list-style-type: none"> • Check the connection of the compressor connecting wire. • Refer to 11-6.⑤ "How to check inverter/compressor". 	—
		9 times	Not lighted	The compressor doesn't synchronize with the operating power.		
5-time flash	Discharge temperature	Lighted	Lighted	Discharge temperature exceeds 116°C during operation. Compressor can restart if discharge temperature thermistor reads 100°C or less 3 minutes later.	<ul style="list-style-type: none"> • Check refrigerant circuit and refrigerant amount. • Refer to 11-6.⑥ "Check of LEV". 	—
6-time flash	High pressure	Lighted	Lighted	The outdoor heat exchanger temperature exceeds 70°C during cooling or the indoor gas pipe temperature exceeds 70°C during heating.	<ul style="list-style-type: none"> • Check refrigerant circuit and refrigerant amount. • Check the stop valve. 	—
7-time flash	Fin temperature	3 times	Not lighted	The fin temperature exceeds 90°C during operation.	<ul style="list-style-type: none"> • Check around outdoor unit. • Check outdoor unit air passage. • Refer to 11-6.⑥ "Check of outdoor fan motor". 	—
	P.C. board temperature	4 times	Not lighted	The P.C. board temperature exceeds 78°C during operation.		
8-time flash	Outdoor fan motor	Lighted	Lighted	Failure occurs 3 consecutive times within 30 seconds after the fan gets started.	<ul style="list-style-type: none"> • Refer to 11-6.⑥ "Check of outdoor fan motor". 	—
9-time flash	Nonvolatile memory data	Lighted	5 times	Nonvolatile memory data cannot be read properly.	<ul style="list-style-type: none"> • Replace the inverter P.C. board. 	○
10-time flash	Discharge temperature	Lighted	Lighted	The frequency of the compressor is kept 68 Hz (MXZ-2C30VA, MXZ-2C40VA)/80Hz (MXZ-2C52VA) or more and the discharge temperature is kept under 50°C (COOL mode)/40°C (HEAT mode) for more than 40 minutes.	<ul style="list-style-type: none"> • Check refrigerant circuit and refrigerant amount. • Refer to 11-6.⑥ "Check of LEV". 	—

NOTE: Blinking patterns of this mode differ from the ones of Troubleshooting check table (11-4).



Upper or left lamp of OPERATION INDICATOR lamp (Indoor unit)	Abnormal point (Failure mode / protection)	LED indication (Outdoor P.C. board)		Condition	Remedy	Indoor/outdoor unit failure mode recall function
		LED 1	LED 2			
11-time flash	Current sensor	8 times	Not lighted	A short or open circuit is detected in the current sensor during compressor operating.	• Replace the inverter P.C. board.	_____
	Bus-bar voltage	6 times	Not lighted	The bus-bar voltage exceeds 430 V or falls to 50 V or below during compressor operating.	• Replace the inverter P.C. board.	_____
14-time flash	Power module	7 times	Not lighted	There is a high possibility that the power module is out of order.	• Refer to 11-6. ⑥ "How to check inverter/compressor".	_____
	Stop valve (Closed valve)	Lighted	12 times	Closed valve is detected by compressor current. (MXZ-2C30VA, MXZ-2C40VA)	• Check the stop valve.	_____
15-time flash	LEV and drain pump	Lighted	Lighted	The indoor unit detects abnormality in the LEV and drain pump.	• Refer to 11-6. ⑦ "Check of LEV". • Check the drain pump of the indoor unit.	_____

NOTE: Blinking patterns of this mode differ from the ones of Troubleshooting check table (11-4).

MXZ-3C/4C/5C

Upper or left lamp of OPERATION INDICATOR lamp (Indoor unit)	Abnormal point (Failure mode/protection)	LED indication (Outdoor P.C. board)		Condition	Remedy	Indoor/outdoor unit failure mode recall function
		LED 1	LED 2			
OFF	None (Normal)	Lighted	Lighted	—	—	—
2-time flash	Outdoor power system	Lighted	Lighted	Overcurrent protection cut-out operates 3 consecutive times within 1 minute after the compressor gets started, or converter protection or bus-bar voltage protection cut-out operates 3 consecutive times within 3 minutes after start-up.	<ul style="list-style-type: none"> • Check the connection of the compressor connecting wire. • Refer to 11-6. ㉔ "How to check inverter/compressor". • Check the stop valve. 	○
3-time flash	Discharge temperature thermistor	Lighted	Once	Thermistor shorts or opens during compressor running.	<ul style="list-style-type: none"> • Refer to 11-6. ㉔ "Check of outdoor thermistors". 	○
	Defrost thermistor	Lighted	Once			
	Ambient temperature thermistor	Lighted	Twice			
	Fin temperature thermistor	Lighted	3 times			
	P.C. board temperature thermistor	Lighted	4 times			
Outdoor heat exchanger temperature thermistor	Lighted	9 times	<ul style="list-style-type: none"> • Replace the electronic control P.C. board. • Refer to 11-6. ㉔ "Check of outdoor thermistors". 			
4-time flash	Overcurrent	Once	Not lighted	28 A current flows into intelligent power module.	<ul style="list-style-type: none"> • Reconnect compressor connector. • Refer to 11-6. ㉔ "How to check inverter/compressor". • Check the stop valve. 	—
5-time flash	Discharge temperature	Lighted	Lighted	Discharge temperature exceeds 116°C during operation. Compressor can restart if discharge temperature thermistor reads 100°C or less 3 minutes later.	<ul style="list-style-type: none"> • Check refrigerant circuit and refrigerant amount. • Refer to 11-6. ㉔ "Check of LEV". 	—
6-time flash	High pressure	Lighted	Lighted	High-pressure is detected with the high-pressure switch (HPS) during operation. (MXZ-3C68/4C71/4C80/5C100VA, 4C80/5C100VA2)	<ul style="list-style-type: none"> • Check refrigerant circuit and refrigerant amount. • Check the stop valve. 	—
				The outdoor heat exchanger temperature exceeds 70°C during cooling or the indoor gas pipe temperature exceeds 70°C during heating.		
7-time flash	Fin temperature	3 times	Not lighted	The fin temperature exceeds 89°C during operation.	<ul style="list-style-type: none"> • Check around outdoor unit. • Check outdoor unit air passage. • Refer to 11-6. ㉔ "Check of outdoor fan motor". 	—
	P.C. board temperature	4 times	Not lighted	The P.C. board temperature exceeds 73°C (MXZ-3C54/3C68/4C71VA)/87°C (MXZ-4C80/5C100VA, 4C80/5C100VA2) during operation.		
8-time flash	Outdoor fan motor	Lighted	Lighted	Failure occurs 3 consecutive times within 30 seconds after the fan gets started.	<ul style="list-style-type: none"> • Refer to 11-6. ㉔ "Check of outdoor fan motor". 	—
9-time flash	Nonvolatile memory data	Lighted	5 times	Nonvolatile memory data cannot be read properly.	<ul style="list-style-type: none"> • Replace the electronic control P.C. board. 	○
10-time flash	Discharge temperature	Lighted	Lighted	The frequency of the compressor is kept 80Hz or more and the discharge temperature is kept under 50°C (cooling)/40°C (heating) for more than 40 minutes.	<ul style="list-style-type: none"> • Check refrigerant circuit and refrigerant amount. • Refer to 11-6. ㉔ "Check of LEV". 	—

NOTE: Blinking patterns of this mode differ from the ones of Troubleshooting check table (11-4).

11-4. TROUBLESHOOTING CHECK TABLE

MXZ-2C

No.	Symptom	Indication		Abnormal point / Condition	Condition	Remedy
		LED1(Red)	LED2(Yellow)			
1	Outdoor unit does not operate.	Lighted	Once	LEV and drain pump	The indoor unit detects an abnormality in the LEV and drain pump.	<ul style="list-style-type: none"> Refer to 11-6. ㉔ "Check of LEV". Check the drain pump of the indoor unit.
2		Lighted	Twice	Outdoor power system	Overcurrent protection cut-out operates 3 consecutive times within 1 minute after the compressor gets started.	<ul style="list-style-type: none"> Check the connection of the compressor connecting wire. Refer to 11-6. ㉕ "How to check inverter/compressor". Check the stop valve.
3		Lighted	3 times	Discharge temperature thermistor	A short circuit is detected in the thermistor during operation, or when an open circuit is detected in the thermistor after 10 minutes of compressor start-up.	<ul style="list-style-type: none"> Refer to 11-6. ㉖ "Check of outdoor thermistors".
4		Lighted	4 times	Fin temperature thermistor	A short or open circuit is detected in the thermistor during operation.	<ul style="list-style-type: none"> Refer to 11-6. ㉗ "Check of outdoor thermistors".
				P.C board temperature thermistor		<ul style="list-style-type: none"> Replace the inverter P.C. board.
5		Lighted	5 times	Ambient temperature thermistor	A short or open circuit is detected in the thermistor during operation.	<ul style="list-style-type: none"> Refer to 11-6. ㉘ "Check of outdoor thermistors".
				Outdoor heat exchanger temperature thermistor	A short circuit is detected in the thermistor during operation, or when an open circuit is detected in the thermistor after 5 minutes (in cooling) and 10 minutes (in heating) of compressor start-up.	
			Defrost thermistor	A short circuit is detected in the thermistor during operation, or when an open circuit is detected in the thermistor after 5 minutes of compressor start-up.		
6	Lighted	7 times	Nonvolatile memory data	The nonvolatile memory data cannot be read properly.	<ul style="list-style-type: none"> Replace the inverter P.C. board. 	
7	Lighted	11 times	Stop valve Closed valve	Closed valve is detected by compressor current. (MXZ-2C30VA, MXZ-2C40VA)	<ul style="list-style-type: none"> Check the stop valve. 	
8	'Outdoor unit stops and restarts 3 minutes later' is repeated.	Twice	Not lighted	Overcurrent	14 A (MXZ-2C30VA)/18 A (MXZ-2C40VA, MXZ-2C52VA) current flows into intelligent power module.	<ul style="list-style-type: none"> Reconnect compressor connector. Refer to 11-6. ㉕ "How to check inverter/compressor". Check the stop valve.
9		3 times	Not lighted	Discharge temperature protection	Discharge temperature exceeds 116°C during operation. Compressor can restart if discharge temperature thermistor reads 100°C or less 3 minutes later.	<ul style="list-style-type: none"> Check the amount of gas and refrigerant circuit. Refer to 11-6. ㉔ "Check of LEV".
10		4 times	Not lighted	Fin temperature protection	The fin temperature exceeds 90°C during operation.	<ul style="list-style-type: none"> Check refrigerant circuit and refrigerant amount. Refer to 11-6. ㉗ "Check of outdoor fan motor".
				P.C. board temperature protection	The P.C. board temperature exceeds 78°C during operation.	
11		5 times	Not lighted	High-pressure protection	The outdoor heat exchanger temperature exceeds 70°C during cooling or indoor gas pipe temperature exceeds 70°C during heating.	<ul style="list-style-type: none"> Check the amount of gas and the refrigerant circuit. Check the stop valve.
12		9 times	Not lighted	Bus-bar voltage protection	The bus-bar voltage exceeds 430 V or falls to 50 V or below during compressor operating.	<ul style="list-style-type: none"> Replace the inverter P.C. board.
13		13 times	Not lighted	Outdoor fan motor	Failure occurs 3 consecutive times within 30 seconds after the fan gets started.	<ul style="list-style-type: none"> Refer to 11-6. ㉙ "Check of outdoor fan motor".
14		8 times	Not lighted	Current sensor protection	A short or open circuit is detected in the current sensor during compressor operating.	<ul style="list-style-type: none"> Replace the inverter P.C. board.
15		10 times	Not lighted	Compressor	The compressor does not synchronize with the operating power.	<ul style="list-style-type: none"> Reconnect compressor connector. Refer to 11-6. ㉕ "How to check inverter/compressor". Check the stop valve.
16		Outdoor unit operates.	Once	Lighted	Primary current protection	The input current exceeds 8 A (MXZ-2C30VA)/ 10 A (MXZ-2C40VA, MXZ-2C52VA).
	Secondary current protection				The current of the compressor exceeds 17 A.	
17	Twice	Lighted	High-pressure protection	The indoor gas pipe temperature exceeds 45°C during heating.	<ul style="list-style-type: none"> Check if indoor/outdoor unit air circulation is short cycled. 	
			Defrosting in cooling	The indoor gas pipe temperature falls 3°C or below during cooling.		
18	3 times	Lighted	Discharge temperature protection	The discharge temperature exceeds 100°C during operation.	<ul style="list-style-type: none"> Check refrigerant circuit and refrigerant amount. Refer to 11-6. ㉔ "Check of LEV". Refer to 11-6. ㉖ "Check of outdoor thermistors". 	
19	4 times	Lighted	Low discharge temperature protection	The frequency of the compressor is kept 68 Hz (MXZ-2C30VA, MXZ-2C40VA)/80 Hz (MXZ-2C52VA) or more and the discharge temperature is kept under 50°C (COOL mode)/40°C (HEAT mode) for more than 40 minutes.	<ul style="list-style-type: none"> Refer to 11-6. ㉔ "Check of LEV". Check refrigerant circuit and refrigerant amount. 	

MXZ-6C

Upper or left lamp of OPERATION INDICATOR lamp (Indoor unit)	Abnormal point (Failure mode/protection)	LED indication (Outdoor P.C. board)		Condition	Remedy	Indoor/outdoor unit failure mode recall function
		LED 1	LED 2			
OFF	None (Normal)	Lighted	Lighted			
2-time flash	Outdoor power system	Lighted	Lighted	Overcurrent protection cut-out operates 3 consecutive times, bus-bar voltage protection cut-out operates 3 consecutive times, or primary current protection cut-out operates 3 consecutive times within 1minute after the compressor gets started.	<ul style="list-style-type: none"> • Check the connection of the compressor connecting wire. • Refer to 11-6. ⑥ How to check inverter/compressor. • Check the stop valve. 	○
3-time flash	Discharge temperature thermistor	Lighted	Once	Thermistor shorts or opens during compressor running.	<ul style="list-style-type: none"> • Refer to 11-6. ⑥ "Check of outdoor thermistors". 	○
	Defrost thermistor	Lighted	Once			
	Ambient temperature thermistor	Lighted	Twice			
	Fin temperature thermistor	Lighted	3 times			
	P.C. board temperature thermistor	Lighted	4 times			
Outdoor heat exchanger temperature thermistor	Lighted	9 times	<ul style="list-style-type: none"> • Replace the power board (MXZ-6C120VA)/outdoor power P.C. board (MXZ-6C122VA). • Replace the power board (MXZ-6C120VA)/outdoor power P.C. board (MXZ-6C122VA). • Refer to 11-6. ⑥ "Check of outdoor thermistors". 			
4-time flash	Overcurrent	Once	Not lighted	40 A current flows into intelligent power module.	<ul style="list-style-type: none"> • Reconnect compressor connector. • Refer to 11-6. ⑥ "How to check inverter/compressor". • Check the stop valve. 	—
	Out-of-step protection	9 times	Not lighted	Waveform of compressor current is distorted.	<ul style="list-style-type: none"> • Refer to 11-6. ⑥ " How to check inverter/compressor. 	
5-time flash	Discharge temperature	Lighted	Lighted	Discharge temperature exceeds 114 °C during operation. Compressor can restart if discharge temperature thermistor reads 100 °C or less 3 minutes later.	<ul style="list-style-type: none"> • Check refrigerant circuit and refrigerant amount. • Refer to 11-6. ⑥ "Check of LEV". 	—
6-time flash	High pressure	Lighted	Lighted	High-pressure is detected with the high-pressure switch (HPS) during operation.	<ul style="list-style-type: none"> • Check refrigerant circuit and refrigerant amount. • Check the stop valve. 	—
				The outdoor heat exchanger temperature exceeds 70 °C during cooling or the indoor gas pipe temperature exceeds 70°C during heating.		
7-time flash	Fin temperature	3 times	Not lighted	The fin temperature exceeds:110 °C (MXZ-6C120VC-[E1]) / 105°C (MXZ-6C120VC-[E2], MXZ-6C122VC-[E1]) during operation.	<ul style="list-style-type: none"> • Check around outdoor unit. • Check outdoor unit air passage. • Refer to 11-6. ⑥ "Check of outdoor fan motor". 	—
	P.C. board temperature	4 times	Not lighted	The P.C. board temperature exceeds 95 °C during operation.		
8-time flash	Outdoor fan motor	Lighted	Lighted	The fan motor speed is 50 rpm or less or 1500 rpm or more for 1 minute, or the fan motor speed is 100 rpm or less for 15 seconds when the outside temperature is 20 °C or more.	<ul style="list-style-type: none"> • Refer to 11-6. ⑥ "Check of outdoor fan motor". 	—
9-time flash	Nonvolatile memory data	Lighted	5 times	Nonvolatile memory data cannot be read properly.	<ul style="list-style-type: none"> • Replace the control P.C. board (MXZ-6C120VA)/outdoor control P.C. board (MXZ-6C122VA). • Replace the power board (MXZ-6C120VA)/outdoor power P.C. board (MXZ-6C122VA). 	○
10-time flash	Discharge temperature	Lighted	Lighted	The frequency of the compressor is kept 58Hz or more and the discharge temperature is kept under 50 °C (cooling)/40 °C (heating) for more than 40 minutes.	<ul style="list-style-type: none"> • Check refrigerant circuit and refrigerant amount. • Refer to 11-6. ⑥ "Check of LEV". 	—

MXZ-6C

Upper or left lamp of OPERATION INDICATOR lamp (Indoor unit)	Abnormal point (Failure mode/protection)	LED indication (Outdoor P.C. board)		Condition	Remedy	Indoor/outdoor unit failure mode recall function
		Lighted	6 times			
11-time flash	Communication error between P.C. boards	Lighted	6 times	Communication error occurs between the control P.C. board (MXZ-6C120VA)/outdoor control P.C. board (MXZ-6C122VA) and power board (MXZ-6C120VA)/outdoor power P.C. board (MXZ-6C122VA) for more than 10 seconds. The communication between boards protection cut-out operates 2 consecutive times.	• Check the connecting wire between the control P.C. board (MXZ-6C120VA)/outdoor control P.C. board (MXZ-6C122VA) and power board (MXZ-6C120VA)/outdoor power P.C. board (MXZ-6C122VA).	— ○
	Current sensor	Lighted	7 times	After the operation starts, a short or open circuit is detected in the current sensor when the compressor is not operating. Current sensor has been short or open circuited for 120 seconds.	• Replace the power board (MXZ-6C120VA)/outdoor power P.C. board (MXZ-6C122VA).	— ○
	Zero cross detecting circuit	5 times	Not lighted	Zero cross signal cannot be detected while the compressor is operating. The protection cut-out of the zero cross detecting circuit operates 3 consecutive times.	• Check the connecting wire between control P.C. board (MXZ-6C120VA)/outdoor control P.C. board (MXZ-6C122VA) and power board (MXZ-6C120VA)/outdoor power P.C. board (MXZ-6C122VA).	— ○
						○
	Bus-bar voltage	6 times	Not lighted	The bus-bar voltage exceeds 400 V or falls to 300 V or below during compressor operating.	• Check the voltage of power supply. • Replace the power board (MXZ-6C120VA)/outdoor power P.C. board (MXZ-6C122VA).	—
12-time flash	Compressor (open phase)	10 times	Not lighted	Waveform of compressor current is distorted.	• Check the connection of the compressor connecting wire. • Refer to 11-6. ㉔ "How to check inverter/compressor".	—
14-time flash	Power module	7 times	Not lighted	The overcurrent is detected when the frequency of the compressor is 1 Hz or less.	• Refer to 11-6. ㉔ "How to check inverter/compressor".	—
15-time flash	LEV and drain pump	Lighted	Lighted	The indoor unit detects an abnormality in the LEV and drain pump.	• Refer to 11-6. ㉔ "Check of LEV". • Check the drain pump of the indoor unit.	—

11-3. INSTRUCTION OF TROUBLESHOOTING

- Check the indoor unit by referring to the indoor unit service manual, and confirm whether there is any problem in the indoor unit. Then, check the outdoor unit by referring to this page.

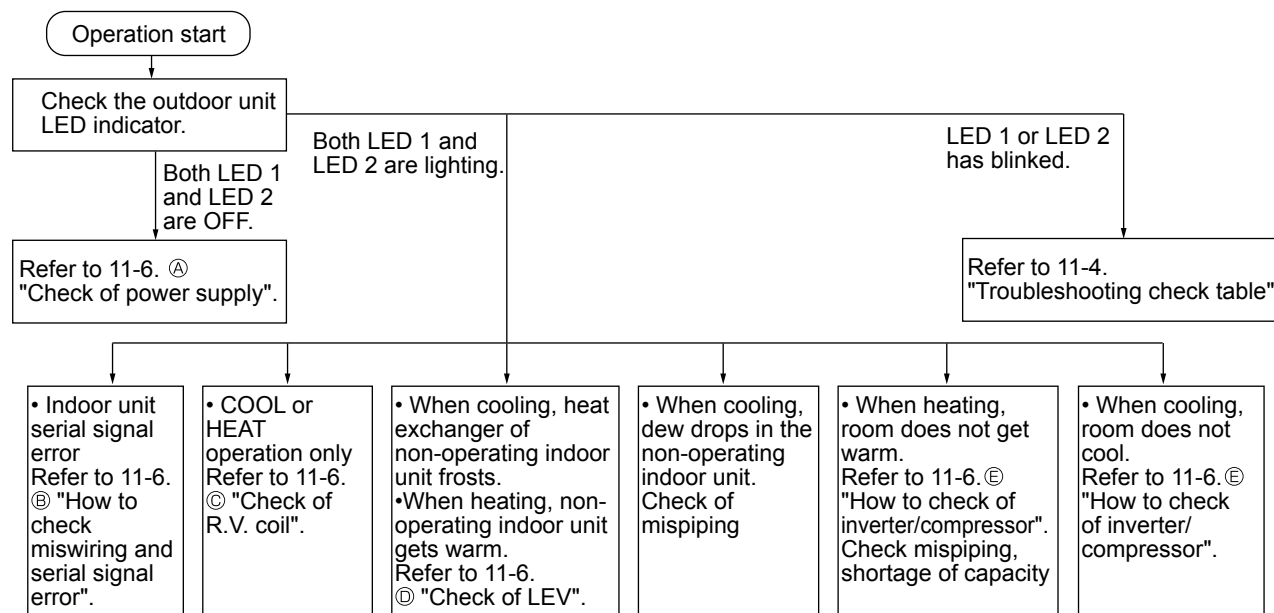

11-4. TROUBLESHOOTING CHECK TABLE

MXZ-2C

No.	Symptom	Indication		Abnormal point / Condition	Condition	Remedy
		LED1(Red)	LED2(Yellow)			
1	Outdoor unit does not operate.	Lighted	Once	LEV and drain pump	The indoor unit detects an abnormality in the LEV and drain pump.	<ul style="list-style-type: none"> Refer to 11-6. ㉔ "Check of LEV". Check the drain pump of the indoor unit.
2		Lighted	Twice	Outdoor power system	Overcurrent protection cut-out operates 3 consecutive times within 1 minute after the compressor gets started.	<ul style="list-style-type: none"> Check the connection of the compressor connecting wire. Refer to 11-6. ㉕ "How to check inverter/compressor". Check the stop valve.
3		Lighted	3 times	Discharge temperature thermistor	A short circuit is detected in the thermistor during operation, or when an open circuit is detected in the thermistor after 10 minutes of compressor start-up.	<ul style="list-style-type: none"> Refer to 11-6. ㉖ "Check of outdoor thermistors".
4		Lighted	4 times	Fin temperature thermistor	A short or open circuit is detected in the thermistor during operation.	<ul style="list-style-type: none"> Refer to 11-6. ㉗ "Check of outdoor thermistors".
				P.C board temperature thermistor		<ul style="list-style-type: none"> Replace the inverter P.C. board.
5		Lighted	5 times	Ambient temperature thermistor	A short or open circuit is detected in the thermistor during operation.	<ul style="list-style-type: none"> Refer to 11-6. ㉘ "Check of outdoor thermistors".
				Outdoor heat exchanger temperature thermistor	A short circuit is detected in the thermistor during operation, or when an open circuit is detected in the thermistor after 5 minutes (in cooling) and 10 minutes (in heating) of compressor start-up.	
6	Lighted	7 times	Defrost thermistor	A short circuit is detected in the thermistor during operation, or when an open circuit is detected in the thermistor after 5 minutes of compressor start-up.	<ul style="list-style-type: none"> Refer to 11-6. ㉙ "Check of outdoor thermistors". 	
6	Lighted	7 times	Nonvolatile memory data	The nonvolatile memory data cannot be read properly.	<ul style="list-style-type: none"> Replace the inverter P.C. board. 	
7	Lighted	11 times	Stop valve Closed valve	Closed valve is detected by compressor current. (MXZ-2C30VA, MXZ-2C40VA)	<ul style="list-style-type: none"> Check the stop valve. 	
8	'Outdoor unit stops and restarts 3 minutes later' is repeated.	Twice	Not lighted	Overcurrent	14 A (MXZ-2C30VA)/18 A (MXZ-2C40VA, MXZ-2C52VA) current flows into intelligent power module.	<ul style="list-style-type: none"> Reconnect compressor connector. Refer to 11-6. ㉚ "How to check inverter/compressor". Check the stop valve.
9		3 times	Not lighted	Discharge temperature protection	Discharge temperature exceeds 116°C during operation. Compressor can restart if discharge temperature thermistor reads 100°C or less 3 minutes later.	<ul style="list-style-type: none"> Check the amount of gas and refrigerant circuit. Refer to 11-6. ㉛ "Check of LEV".
10		4 times	Not lighted	Fin temperature protection	The fin temperature exceeds 90°C during operation.	<ul style="list-style-type: none"> Check refrigerant circuit and refrigerant amount. Refer to 11-6. ㉜ "Check of outdoor fan motor".
				P.C. board temperature protection	The P.C. board temperature exceeds 78°C during operation.	
11		5 times	Not lighted	High-pressure protection	The outdoor heat exchanger temperature exceeds 70°C during cooling or indoor gas pipe temperature exceeds 70°C during heating.	<ul style="list-style-type: none"> Check the amount of gas and the refrigerant circuit. Check the stop valve.
12		9 times	Not lighted	Bus-bar voltage protection	The bus-bar voltage exceeds 430 V or falls to 50 V or below during compressor operating.	<ul style="list-style-type: none"> Replace the inverter P.C. board.
13		13 times	Not lighted	Outdoor fan motor	Failure occurs 3 consecutive times within 30 seconds after the fan gets started.	<ul style="list-style-type: none"> Refer to 11-6. ㉝ "Check of outdoor fan motor".
14		8 times	Not lighted	Current sensor protection	A short or open circuit is detected in the current sensor during compressor operating.	<ul style="list-style-type: none"> Replace the inverter P.C. board.
15		10 times	Not lighted	Compressor	The compressor does not synchronize with the operating power.	<ul style="list-style-type: none"> Reconnect compressor connector. Refer to 11-6. ㉞ "How to check inverter/compressor". Check the stop valve.
16		Outdoor unit operates.	Once	Lighted	Primary current protection	The input current exceeds 8 A (MXZ-2C30VA)/ 10 A (MXZ-2C40VA, MXZ-2C52VA).
	Secondary current protection				The current of the compressor exceeds 17 A.	
17	Twice	Lighted	High-pressure protection	The indoor gas pipe temperature exceeds 45°C during heating.	<ul style="list-style-type: none"> Check if indoor/outdoor unit air circulation is short cycled. 	
			Defrosting in cooling	The indoor gas pipe temperature falls 3°C or below during cooling.		
18	3 times	Lighted	Discharge temperature protection	The discharge temperature exceeds 100°C during operation.	<ul style="list-style-type: none"> Check refrigerant circuit and refrigerant amount. Refer to 11-6. ㉟ "Check of LEV". Refer to 11-6. ㊱ "Check of outdoor thermistors". 	
19	4 times	Lighted	Low discharge temperature protection	The frequency of the compressor is kept 68 Hz (MXZ-2C30VA, MXZ-2C40VA)/80 Hz (MXZ-2C52VA) or more and the discharge temperature is kept under 50°C (COOL mode)/40°C (HEAT mode) for more than 40 minutes.	<ul style="list-style-type: none"> Refer to 11-6. ㊲ "Check of LEV". Check refrigerant circuit and refrigerant amount. 	



No.	Symptom	Indication		Abnormal point / Condition	Condition	Remedy
		LED1(Red)	LED2(Yellow)			
20	Outdoor unit operates.	5 times	Lighted	Cooling high-pressure protection	The outdoor heat exchanger temperature exceeds 58°C during operation.	This symptom does not mean any abnormality of the product, but check the following points. <ul style="list-style-type: none"> • Check if indoor filters are clogged. • Check if refrigerant is short. • Check if indoor/outdoor unit air circulation is short cycled.
21	Outdoor unit operates normally.	9 times	Lighted	Inverter check mode	The connector of compressor is disconnected. Inverter check mode starts.	—
22		Lighted	Lighted	Normal	—	—

NOTE 1. The location of LED is illustrated at the right figure. Refer to 11-7.6.
 2. LED is lighted during normal operation.

The flashing frequency shows the number of times the LED blinks after every 2.5-second OFF.
 (Example) When the flashing frequency is "2".

Display P.C. board (Parts side)

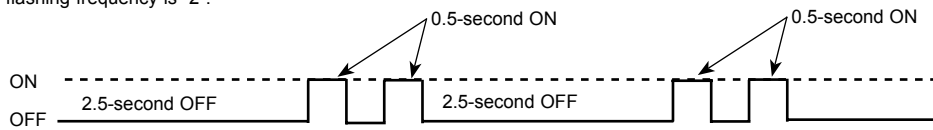
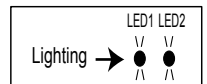

MXZ-3C/4C/5C

No.	Symptom	Indication		Abnormal point / Condition	Condition	Remedy
		LED1(Red)	LED2(Yellow)			
1	Outdoor unit does not operate.	Lighted	Once	LEV and drain pump	The indoor unit detects an abnormality in the LEV and drain pump.	<ul style="list-style-type: none"> Refer to 11-6. ⑥ "Check of LEV". Check the drain pump of the indoor unit.
2		Lighted	Twice	Outdoor power system	Overcurrent protection cut-out operates 3 consecutive times within 1 minute after the compressor gets started, or converter protection or bus-bar voltage protection cut-out operates 3 consecutive times within 3 minutes after start-up.	<ul style="list-style-type: none"> Check the connection of the compressor connecting wire. Refer to 11-6. ⑥ "How to check inverter/compressor". Check the stop valve.
3		Lighted	3 times	Discharge temperature thermistor	A short circuit is detected in the thermistor during operation, or an open circuit is detected in the thermistor 10 minutes after compressor start-up.	<ul style="list-style-type: none"> Refer to 11-6. ⑥ "Check of outdoor thermistors".
4		Lighted	4 times	Fin temperature thermistor	A short or open circuit is detected in the thermistor during operation.	<ul style="list-style-type: none"> Refer to 11-6. ⑥ "Check of outdoor thermistors".
				P.C. board temperature thermistor		<ul style="list-style-type: none"> Replace the electronic control P.C. board.
5		Lighted	5 times	Ambient temperature thermistor	A short or open circuit is detected in the thermistor during operation.	<ul style="list-style-type: none"> Refer to 11-6. ⑥ "Check of outdoor thermistors".
				Outdoor heat exchanger temperature thermistor	A short circuit is detected in the thermistor during operation, or an open circuit is detected in the thermistor 5 minutes (in cooling) and 10 minutes (in heating) after compressor start-up.	
				Defrost thermistor	A short circuit is detected in the thermistor during operation, or an open circuit is detected in the thermistor 5 minutes after compressor start-up.	
6		Lighted	7 times	Nonvolatile memory data	The nonvolatile memory data cannot be read properly.	<ul style="list-style-type: none"> Replace the electronic control P.C. board.
7	Lighted	8 times	Current sensor	Current sensor protection cut-out operates 2 consecutive times.	<ul style="list-style-type: none"> Replace the power board. 	
8	Lighted	11 times	Communication error between P.C. boards	Communication error occurs twice between the electronic control P.C. board and power board for more than 10 seconds.	<ul style="list-style-type: none"> Check the connecting wire between electronic control P.C. board and power board. 	
9	Lighted	12 times	Zero cross detecting circuit	The protection cut-out of the zero cross detecting circuit operates 10 consecutive times.	<ul style="list-style-type: none"> Check the connecting wire between electronic control P.C. board, noise filter P.C. board and power board. 	
10	'Outdoor unit stops and restarts 3 minutes later' is repeated.	Twice	Not lighted	IPM protection	Overcurrent is detected 30 seconds after compressor start-up.	<ul style="list-style-type: none"> Reconnect compressor connector. Refer to 11-6. ⑥ "How to check inverter/compressor".
				Lock protection	Overcurrent is detected within 30 seconds after compressor start-up.	<ul style="list-style-type: none"> Check the stop valve. Check the power module (PAM module).
11		3 times	Not lighted	Discharge temperature protection	Discharge temperature exceeds 116°C during operation. Compressor can restart if discharge temperature thermistor reads 100°C or less 3 minutes later.	<ul style="list-style-type: none"> Check the amount of gas and refrigerant circuit. Refer to 11-6. ⑥ "Check of LEV".
12		4 times	Not lighted	Fin temperature protection	The fin temperature exceeds 89°C during operation.	<ul style="list-style-type: none"> Check refrigerant circuit and refrigerant amount. Refer to 11-6. ⑥ "Check of outdoor fan motor".
				P.C. board temperature protection	The P.C. board temperature exceeds 73°C (MXZ-3C54/3C68/4C71VA)/ 87°C (MXZ-4C80/5C100VA, 4C80/5C100VA2) during operation.	
13		5 times	Not lighted	High-pressure protection	High-pressure is detected with the high-pressure switch (HPS) during operation. (MXZ-3C68/4C71/4C80/5C100VA, 4C80/5C100VA2)	<ul style="list-style-type: none"> Check the amount of gas and the refrigerant circuit. Check the stop valve.
					The outdoor heat exchanger temperature exceeds 70°C during cooling or indoor gas pipe temperature exceeds 70°C during heating.	
14		8 times	Not lighted	Converter protection	A failure is detected in the operation of the converter during operation.	<ul style="list-style-type: none"> Replace the power board.
15		9 times	Not lighted	Bus-bar voltage protection (1)	The bus-bar voltage exceeds 400 V or falls to 200 V or below during compressor operating.	<ul style="list-style-type: none"> Check the voltage of power supply. Replace the power board or the electronic control P.C. board. Refer to 11-6. ⑥ "Check of bus-bar voltage".
			Bus-bar voltage protection (2)	The bus-bar voltage exceeds 400 V (MXZ-3C54/3C68/4C71VA)/ 430 V (MXZ-4C80/5C100VA, 4C80/5C100VA2) or falls to 50 V or below while the compressor is operating.		
16	13 times	Not lighted	Outdoor fan motor	Failure occurs 3 consecutive times within 30 seconds after the fan gets started.	<ul style="list-style-type: none"> Refer to 11-6. ⑥ "Check of outdoor fan motor". 	
17	Lighted	8 times	Current sensor protection	A short or open circuit is detected in the current sensor while the compressor is operating.	<ul style="list-style-type: none"> Replace the power board. 	
18	Lighted	11 times	Communication protection between P.C. boards	Communication error occurs between the electronic control P.C. board and power board for more than 10 seconds.	<ul style="list-style-type: none"> Check the connecting wire between electronic control P.C. board and power board. 	
19	Lighted	12 times	Zero cross detecting circuit protection	Zero cross signal cannot be detected while the compressor is operating.	<ul style="list-style-type: none"> Check the connecting wire between electronic control P.C. board, noise filter P.C. board and power board. 	



No.	Symptom	Indication		Abnormal point / Condition	Condition	Remedy
		LED1(Red)	LED2(Yellow)			
20	Outdoor unit operates.	Once	Lighted	Primary current protection	The primary current exceeds 15 A (MXZ-3C54/3C68/4C71VA)/17 A (MXZ-4C80VA, 4C80VA2)/18 A (MXZ-5C100VA, 5C100VA2).	These symptoms do not mean any abnormality of the product, but check the following points. • Check indoor filters are not clogged. • Check there is sufficient refrigerant. • Check indoor/outdoor unit air circulation is not short cycling.
				Secondary current protection	The current of the compressor exceeds 12 A (MXZ-3C54VA) /12.5A (MXZ-3C68/4C71VA) /10 A (MXZ-4C80/5C100VA, 4C80/5C100VA2).	
21	Twice	Lighted	High-pressure protection	The indoor gas pipe temperature exceeds 45°C during heating.		
			Defrosting in cooling	The indoor gas pipe temperature falls 3°C or below during cooling.		
22	3 times	Lighted	Discharge temperature protection	The discharge temperature exceeds 100°C during operation.	• Check refrigerant circuit and refrigerant amount. • Refer to 11-6. Ⓒ "Check of LEV". • Refer to 11-6. Ⓔ "Check of outdoor thermistors".	
23	4 times	Lighted	Low discharge temperature protection	The frequency of the compressor is kept 80 Hz or more and the discharge temperature is kept under 50°C (cooling) /40°C (heating) for more than 40 minutes.	• Refer to 11-6. Ⓒ "Check of LEV". • Check refrigerant circuit and refrigerant amount.	
24	5 times	Lighted	Cooling high-pressure protection	The outdoor heat exchanger temperature exceeds 58°C during operation.	This symptom does not mean any abnormality of the product, but check the following points. • Check indoor filters are not clogged. • Check there is sufficient refrigerant. • Check indoor/outdoor unit air circulation is not short cycling.	
25	Outdoor unit operates normally.	9 times	Lighted	Inverter check mode	The unit is operated with emergency operation switch.	—
26		Lighted	Lighted	Normal	—	—

NOTE 1. The location of LED is illustrated at the right figure. Refer to 11-7.2.
 2. LED is lighted during normal operation.

Outdoor electronic control P.C. board (Parts side)

The flashing frequency shows the number of times the LED blinks after every 2.5-second OFF.
 (Example) When the flashing frequency is "2".

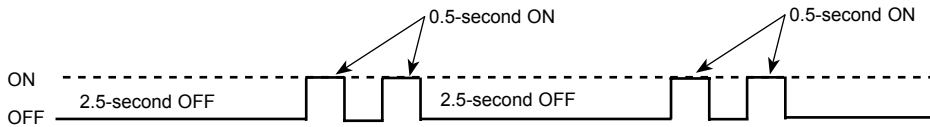

MXZ-3C54/3C68/4C71VA

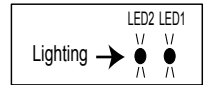

MXZ-4C80/5C100VA

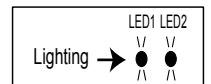

MXZ-6C

No.	Symptom	Indication		Abnormal point / Condition	Condition	Remedy
		LED1(Red)	LED2(Yellow)			
1	'Outdoor unit does not operate.'	Lighted	Once	LEV and drain pump	The indoor unit detects an abnormality in the LEV and drain pump.	<ul style="list-style-type: none"> Refer to 11-6. ㉔ "Check of LEV". Check the drain pump of the indoor unit.
2		Lighted	Twice	Outdoor power system	Overcurrent protection cut-out operates 3 consecutive times, bus-bar voltage protection cut-out operates 3 consecutive times, or primary current protection cut-out operates 3 consecutive times within 1minute after the compressor gets started.	<ul style="list-style-type: none"> Check the connection of the compressor connecting wire. Refer to 11-6. ㉕ "How to check inverter/compressor". Check the stop valve.
3		Lighted	3 times	Discharge temperature thermistor	A short circuit is detected in the thermistor during operation, or an open circuit is detected in the thermistor 10 minutes after compressor start-up.	<ul style="list-style-type: none"> Refer to 11-6. ㉖ "Check of outdoor thermistors".
4		Lighted	4 times	Fin temperature thermistor	A short or open circuit is detected in the thermistor during operation.	<ul style="list-style-type: none"> Replace the power board (MXZ-6C120VA)/ outdoor power P.C. board (MXZ-6C122VA).
				P.C board temperature thermistor		<ul style="list-style-type: none"> Replace the power board (MXZ-6C120VA)/ outdoor power P.C. board (MXZ-6C122VA).
5		Lighted	5 times	Ambient temperature thermistor	A short or open circuit is detected in the thermistor during operation.	<ul style="list-style-type: none"> Refer to 11-6. ㉗ "Check of outdoor thermistors".
				Outdoor heat exchanger temperature thermistor		
				Defrost thermistor		
6		Lighted	7 times	Nonvolatile memory data (Outdoor control P.C. board)	The nonvolatile memory data cannot be read properly.	<ul style="list-style-type: none"> Replace the control P.C. board (MXZ-6C120VA)/ outdoor control P.C. board(MXZ-6C122VA).
7		Lighted	8 times	Current sensor	Current sensor has been short or open circuited for 120 seconds.	<ul style="list-style-type: none"> Replace the power board (MXZ-6C120VA)/ outdoor power P.C. board(MXZ-6C122VA).
8		Lighted	11 times	Communication error between P.C. boards	Communication error occurs twice between the outdoor control P.C. board and power board (MXZ-6C120VA)/outdoor power P.C. board (MXZ-6C122VA) for more than 10 seconds.	<ul style="list-style-type: none"> Check the connecting wire between control P.C. board (MXZ-6C120VA)/outdoor control P.C. board(MXZ-6C122VA) and power board (MXZ-6C120VA)/outdoor power P.C. board (MXZ-6C122VA).
9		Lighted	12 times	Zero cross detecting circuit	The protection cut-out of the zero cross detecting circuit operates 3 consecutive times.	<ul style="list-style-type: none"> Check the connecting wire between control P.C. board (MXZ-6C120VA)/outdoor control P.C. board(MXZ-6C122VA) and power board (MXZ-6C120VA)/outdoor power P.C. board (MXZ-6C122VA).
		Lighted	14 times	Nonvolatile memory data (power board (MXZ-6C120VA)/outdoor power P.C. board (MXZ-6C122VA))	The nonvolatile memory data cannot be read properly.	<ul style="list-style-type: none"> Replace the power board (MXZ-6C120VA)/ outdoor power P.C. board (MXZ-6C122VA).
10		'Outdoor unit stops and restarts 3 minutes later' is repeated.'	Twice	Not lighted	IPM protection	Overcurrent is detected when the frequency of the compressor is 1 Hz or less.
	Overcurrent				Overcurrent is detected when the frequency of the compressor is more than 1 Hz.	
11	3 times		Not lighted	Discharge temperature protection	Discharge temperature exceeds 114°C during operation. Compressor can restart if discharge temperature thermistor reads 100°C or less 3 minutes later.	<ul style="list-style-type: none"> Check the amount of gas and refrigerant circuit. Refer to 11-6. ㉔ "Check of LEV".
12	4 times		Not lighted	Fin temperature protection	The fin temperature exceeds 110°C during operation.	<ul style="list-style-type: none"> Check refrigerant circuit and refrigerant amount.
				P.C. board temperature protection	The P.C. board temperature exceeds 95°C during operation.	
13	5 times		Not lighted	High-pressure protection	High-pressure is detected with the high-pressure switch (HPS) during operation.	<ul style="list-style-type: none"> Check the amount of gas and the refrigerant circuit. Check the stop valve.
					The outdoor heat exchanger temperature exceeds 70°C during cooling or indoor gas pipe temperature exceeds 70°C during heating.	
	7 times		Not lighted	Out-of-step protection	The waveform of compressor current is distorted.	<ul style="list-style-type: none"> Reconnect connector of compressor. Refer to 11-6. ㉕ "How to check inverter/compressor".
15	9 times		Not lighted	Bus-bar voltage protection	The bus-bar voltage exceeds 400 V or falls to 300 V or below while the compressor is operating.	<ul style="list-style-type: none"> Check the voltage of power supply. Replace the power board (MXZ-6C120VA)/ outdoor power P.C. board (MXZ-6C122VA) or the control P.C. board (MXZ-6C120VA)/outdoor control P.C. board (MXZ-6C122VA) . Refer to 11-6. ㉘ "Check of bus-bar voltage".
	10 times		Not lighted	Zero cross loss	Zero cross signal cannot be detected while the compressor is operating.	
	11 times	Not lighted	Low out side temperature protection (cooling)	The ambient temperature became -12°C or less.		
	12 times	Not lighted	Primary current protection	The primary current exceeds 37 A for 10 seconds.		
16	13 times	Not lighted	Outdoor fan motor	The fan motor speed is 50 rpm or less or 1500 rpm or more for 1 minute, or the fan motor speed is 100 rpm or less for 15 seconds when the outside temperature is 20 °C or more.	<ul style="list-style-type: none"> Refer to 11-6. ㉚ "Check of outdoor fan motor". 	



No.	Symptom	Indication		Abnormal point / Condition	Condition	Remedy	
		LED1(Red)	LED2(Yellow)				
17	'Outdoor unit stops and restarts 3 minutes later' is repeated.	Lighted	8 times	Current sensor protection	After the operation starts, a short or open circuit is detected in the current sensor when the compressor is not operating.	• Replace the power board (MXZ-6C120VA)/ outdoor power P.C. board (MXZ-6C122VA).	
18		Lighted	11 times	Communication protection between P.C. boards	Communication error occurs between the control P.C. board (MXZ-6C120VA)/outdoor control P.C. board (MXZ-6C122VA) and power board (MXZ-6C120VA)/outdoor power P.C. board (MXZ-6C122VA) for more than 10 seconds.	• Check the connecting wire between control P.C. board (MXZ-6C120VA)/outdoor control P.C. board (MXZ-6C122VA) and power board (MXZ-6C120VA)/outdoor power P.C. board (MXZ-6C122VA).	
19		Lighted	12 times	Zero cross detecting circuit protection	Zero cross signal cannot be detected when the compressor begins operating.	• Check the connecting wire between outdoor control P.C. board (MXZ-6C120VA)/outdoor control P.C. board (MXZ-6C122VA) and power board (MXZ-6C120VA)/outdoor power P.C. board (MXZ-6C122VA).	
20	Outdoor unit operates	Once	Lighted	Primary current protection	The primary current exceeds 27A.	These symptoms do not mean any abnormality of the product, but check the following points. • Check indoor filters are not clogged. • Check there is sufficient refrigerant. • Check indoor/outdoor unit air circulation is not short cycling.	
21		Twice	Lighted	High-pressure protection	The indoor heat exchanger exceeds 38°C during heating.		
				Defrosting in cooling	The indoor heat exchanger falls 3°C or below during cooling.		
22		3 times	Lighted	Discharge temperature protection	The discharge temperature exceeds 100°C during operation.		• Check refrigerant circuit and refrigerant amount. • Refer to 11-6. © "Check of LEV".
23		4 times	Lighted	Low discharge temperature protection	The frequency of the compressor is kept 58 Hz or more and the discharge temperature is kept under 50°C (cooling) /40°C (heating) for more than 20 minutes		• Refer to 11-6. © "Check of LEV". • Check refrigerant circuit and refrigerant amount.
24	5 times	Lighted	Cooling high-pressure protection	The outdoor heat exchanger temperature exceeds 54°C during operation.	This symptom does not mean any abnormality of the product, but check the following points. • Check indoor filters are not clogged. • Check there is sufficient refrigerant. • Check indoor/outdoor unit air circulation is short cycling.		
	7 times	Lighted	High → Low Pressure bypass valve Cooling evaporating temperature drop prevention control	During cooling operation, the temperature of indoor heat exchanger becomes 3°C or less within 1 hour after the compressor starts running, or it becomes less than 12°C - 16°C* later than that. * It depends on the difference between the set temperature and the room temperature.		This symptom does not mean any abnormality of the product, but check the following points. • Check indoor filters are not clogged. • Check there is sufficient refrigerant. • Check indoor/outdoor unit air circulation is not short cycling.	
25	Outdoor unit operates normally.	7 times	Lighted	High → Low pressure bypass valve High pressure protection control at start-up of heating operation	The room temperature is 24°C or more when 1 or 2 unit(s) start(s) the heating operation.	This symptom does not mean any abnormality of the product.	
				High → Low pressure bypass valve Compressor oil tempering control at start-up of heating operation	Both the following are true: • The outside temperature is -2°C or less when the heating operation is started. • [(Discharge temperature) - (Indoor heat exchanger temperature)] < 5°C		
		8 times	Lighted	Cooling evaporating temperature protection	During cooling operation, the temperature of indoor heat exchanger becomes 7°C - 11°C* or less within 1 hour after the compressor starts running, or it becomes 9°C - 17°C* or less later than that. * It depends on the indoor unit type/model or the difference between the set temperature and the room temperature.		
		9 times	Lighted	Inverter check mode	The connector of compressor is disconnected. Inverter check mode starts.		• Check the connector of the compressor is correctly connected. • Refer to 11-6. © "How to check inverter/ compressor".
26		Lighted	Lighted	Normal			

NOTE 1. The location of LED is illustrated at the right figure. Refer to 11-7.3.
2. LED is lighted during normal operation.

The flashing frequency shows the number of times the LED blinks after every 2.5-second OFF.
(Example) When the flashing frequency is "2".

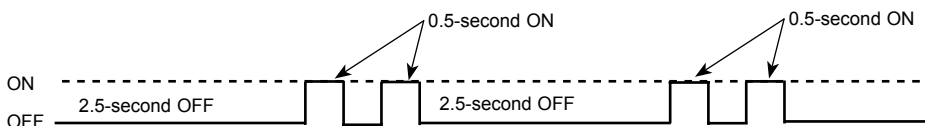

Outdoor control P.C. board (Parts side)

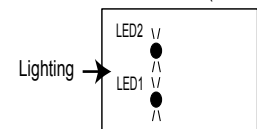

11-5. TROUBLE CRITERION OF MAIN PARTS

MXZ-2C30VA MXZ-2C40VA MXZ-2C52VA MXZ-3C54VA MXZ-3C68VA MXZ-4C71VA
MXZ-4C80VA MXZ-4C80VA2 MXZ-5C100VA MXZ-5C100VA2 MXZ-6C120VA MXZ-6C122VA

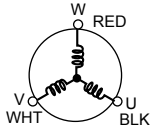
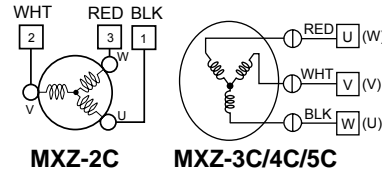
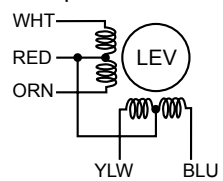
Part name	Check method and criterion															
Defrost thermistor (RT61)	Measure the resistance with a tester.															
Fin temperature thermistor (RT64) MXZ-2C/3C/4C/5C	Refer to 11-7. "TEST POINT DIAGRAM AND VOLTAGE" 1. "Inverter P.C. board", 2. "Electronic control P.C. board", 3. "Control P.C. board/outdoor control P.C. board" or 6. "Power board" for the chart of thermistor.															
Ambient temperature thermistor (RT65)																
Outdoor heat exchanger temperature thermistor (RT68)																
Discharge temperature thermistor (RT62)	Measure the resistance with a tester. Before measurement, hold the thermistor with your hands to warm it up. Refer to 11-7. "TEST POINT DIAGRAM AND VOLTAGE" 1. "Inverter P.C. board", 2. "Electronic control P.C. board" or 3. "Control P.C. board/outdoor control P.C. board" for the chart of thermistor.															
Compressor 	Measure the resistance between terminals using a tester. (Winding temperature : -10°C ~ 40°C) <table border="1" style="width:100%; text-align:center;"> <tr><th colspan="5">Normal (Each phase)</th></tr> <tr> <td>MXZ-2C30VA MXZ-2C40VA</td> <td>MXZ-2C52VA MXZ-3C54VA</td> <td>MXZ-3C68VA MXZ-4C71VA</td> <td>MXZ-4C80VA MXZ-4C80VA2 MXZ-5C100VA MXZ-5C100VA2</td> <td>MXZ-6C120VA MXZ-6C122VA</td> </tr> <tr> <td>1.49 Ω ~ 1.84 Ω</td> <td>0.86 Ω ~ 1.06 Ω</td> <td>0.63 Ω ~ 0.78 Ω</td> <td>1.29 Ω ~ 1.49 Ω</td> <td>0.47 Ω ~ 0.57 Ω</td> </tr> </table>	Normal (Each phase)					MXZ-2C30VA MXZ-2C40VA	MXZ-2C52VA MXZ-3C54VA	MXZ-3C68VA MXZ-4C71VA	MXZ-4C80VA MXZ-4C80VA2 MXZ-5C100VA MXZ-5C100VA2	MXZ-6C120VA MXZ-6C122VA	1.49 Ω ~ 1.84 Ω	0.86 Ω ~ 1.06 Ω	0.63 Ω ~ 0.78 Ω	1.29 Ω ~ 1.49 Ω	0.47 Ω ~ 0.57 Ω
Normal (Each phase)																
MXZ-2C30VA MXZ-2C40VA	MXZ-2C52VA MXZ-3C54VA	MXZ-3C68VA MXZ-4C71VA	MXZ-4C80VA MXZ-4C80VA2 MXZ-5C100VA MXZ-5C100VA2	MXZ-6C120VA MXZ-6C122VA												
1.49 Ω ~ 1.84 Ω	0.86 Ω ~ 1.06 Ω	0.63 Ω ~ 0.78 Ω	1.29 Ω ~ 1.49 Ω	0.47 Ω ~ 0.57 Ω												
Outdoor fan motor 	Measure the resistance between lead wires using a tester. (Part temperature : -10°C ~ 40°C) <table border="1" style="width:100%; text-align:center;"> <tr><th colspan="2">Normal (Each phase)</th></tr> <tr> <td>MXZ-2C</td> <td>MXZ-3C/4C/5C</td> </tr> <tr> <td>12 Ω ~ 16 Ω</td> <td>13.4 Ω ~ 16.4 Ω</td> </tr> </table>	Normal (Each phase)		MXZ-2C	MXZ-3C/4C/5C	12 Ω ~ 16 Ω	13.4 Ω ~ 16.4 Ω									
Normal (Each phase)																
MXZ-2C	MXZ-3C/4C/5C															
12 Ω ~ 16 Ω	13.4 Ω ~ 16.4 Ω															
Outdoor fan motor MXZ-6C	Refer to 11-6. ③ .															
R.V. coil	Measure the resistance using a tester. (Part temperature : -10°C ~ 40°C) <table border="1" style="width:100%; text-align:center;"> <tr><th colspan="4">Normal (Each phase)</th></tr> <tr> <td>MXZ-3C54VA MXZ-3C68VA MXZ-4C71VA</td> <td>MXZ-2C30VA MXZ-2C40VA MXZ-2C52VA</td> <td>MXZ-4C80VA MXZ-4C80VA2 MXZ-5C100VA MXZ-5C100VA2</td> <td>MXZ-6C120VA MXZ-6C122VA</td> </tr> <tr> <td>1.26 kΩ ~ 1.62 kΩ</td> <td>1.2 kΩ ~ 1.56 kΩ</td> <td>1.26 kΩ ~ 1.62 kΩ</td> <td></td> </tr> </table>	Normal (Each phase)				MXZ-3C54VA MXZ-3C68VA MXZ-4C71VA	MXZ-2C30VA MXZ-2C40VA MXZ-2C52VA	MXZ-4C80VA MXZ-4C80VA2 MXZ-5C100VA MXZ-5C100VA2	MXZ-6C120VA MXZ-6C122VA	1.26 kΩ ~ 1.62 kΩ	1.2 kΩ ~ 1.56 kΩ	1.26 kΩ ~ 1.62 kΩ				
Normal (Each phase)																
MXZ-3C54VA MXZ-3C68VA MXZ-4C71VA	MXZ-2C30VA MXZ-2C40VA MXZ-2C52VA	MXZ-4C80VA MXZ-4C80VA2 MXZ-5C100VA MXZ-5C100VA2	MXZ-6C120VA MXZ-6C122VA													
1.26 kΩ ~ 1.62 kΩ	1.2 kΩ ~ 1.56 kΩ	1.26 kΩ ~ 1.62 kΩ														
Solenoid coil MXZ-6C	Measure the resistance using a tester. (Part temperature : -10°C ~ 40°C) <table border="1" style="width:100%; text-align:center;"> <tr><th colspan="1">Normal (Each phase)</th></tr> <tr><td>MXZ-6C120/6C122VA</td></tr> <tr><td>1.17 kΩ ~ 1.43 kΩ</td></tr> </table>	Normal (Each phase)	MXZ-6C120/6C122VA	1.17 kΩ ~ 1.43 kΩ												
Normal (Each phase)																
MXZ-6C120/6C122VA																
1.17 kΩ ~ 1.43 kΩ																
Linear expansion valve 	Measure the resistance using a tester. (Part temperature : -10°C ~ 40°C) <table border="1" style="width:100%; text-align:center;"> <tr><th>Color of lead wire</th><th>Normal</th></tr> <tr><td>WHT - RED</td><td rowspan="4">37.4 Ω ~ 53.9 Ω</td></tr> <tr><td>RED - ORN</td></tr> <tr><td>YLW - RED</td></tr> <tr><td>RED - BLU</td></tr> </table>	Color of lead wire	Normal	WHT - RED	37.4 Ω ~ 53.9 Ω	RED - ORN	YLW - RED	RED - BLU								
Color of lead wire	Normal															
WHT - RED	37.4 Ω ~ 53.9 Ω															
RED - ORN																
YLW - RED																
RED - BLU																
High pressure switch (HPS) MXZ-3C68/4C/5C/6C	<table border="1" style="width:100%; text-align:center;"> <tr><th colspan="2">Pressure</th><th>Normal</th></tr> <tr><td rowspan="2">HPS</td><td>3.7 ± 0.3 MPa</td><td>Close</td></tr> <tr><td>4.8 ± 0.2 MPa</td><td>Open</td></tr> </table>	Pressure		Normal	HPS	3.7 ± 0.3 MPa	Close	4.8 ± 0.2 MPa	Open							
Pressure		Normal														
HPS	3.7 ± 0.3 MPa	Close														
	4.8 ± 0.2 MPa	Open														

11-6. TROUBLESHOOTING FLOW

Outdoor unit does not operate.

Ⓐ Check of power supply

MXZ-2C30/2C40/2C52VA

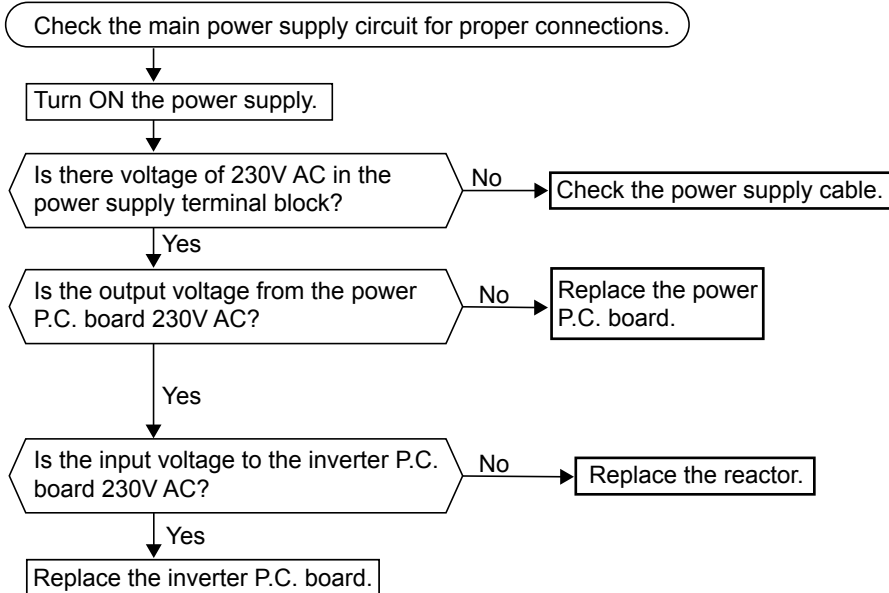

MXZ-3C54/3C68/4C71/4C80/5C100VA MXZ-4C80/5C100VA2

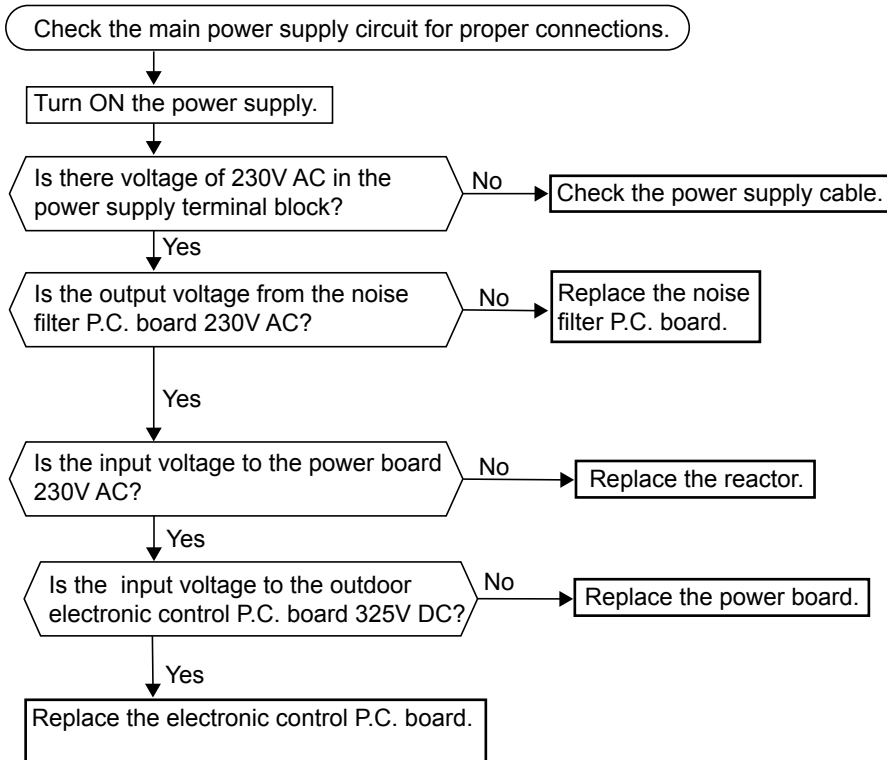

MXZ-6C120/6C122VA

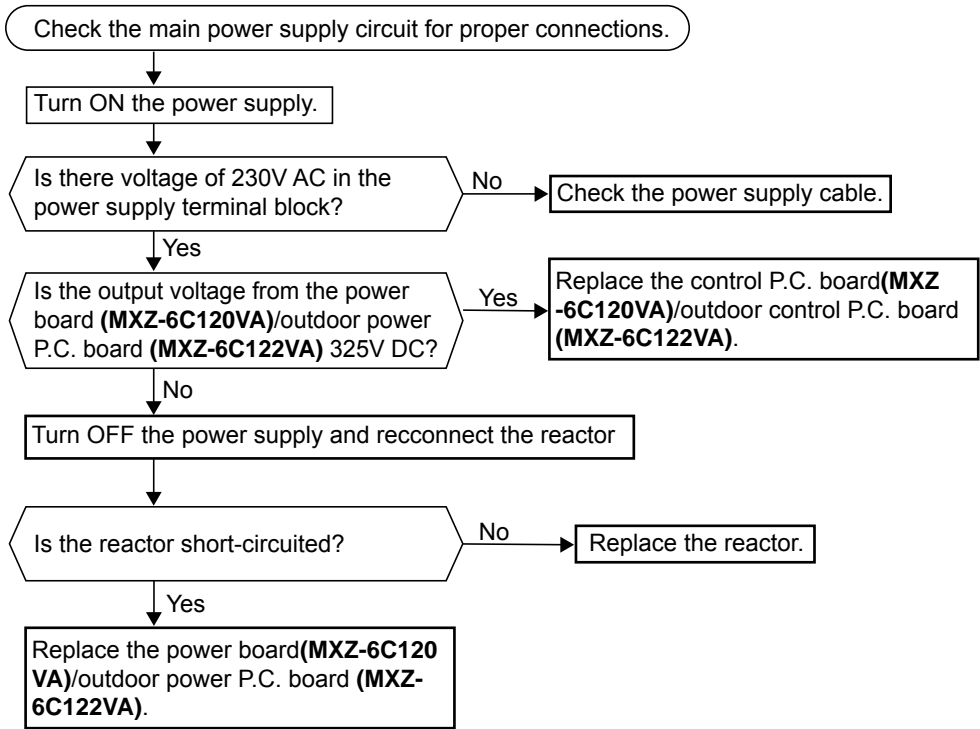

- When unit cannot operate neither by the remote controller nor by EMERGENCY OPERATION switch.
Indoor unit does not operate.
- When OPERATION INDICATOR lamp flashes ON and OFF every 0.5-second.
Outdoor unit does not operate.

Ⓑ How to check miswiring and serial signal error (when outdoor unit does not work)

LED indication

for communication status

Communication status is indicated by the LED.

Unit status

Blinking: normal communication

Lighting: abnormal communication or not connected

Pattern 1 and 2 is repeatedly displayed alternately. Each pattern is displayed for 15 seconds.

NOTE: "Lighting" in the table below does not indicate abnormal communication.

MXZ-2C30/2C40/2C52VA
Display P.C. board

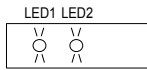

Blinking

LED 1	LED 2
Unit A status	Unit B status

MXZ-3C54/3C68/4C71VA
Electronic control P.C. board (Parts side)

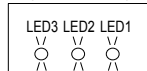

Blinking

Pattern	LED 3	LED 2	LED 1
1	Lighted	Unit B status	Unit A status
2	Not lighted	Unit D status	Unit C status

MXZ-4C80/5C100VA
MXZ-4C80/5C100VA2
Electronic control P.C. board (Parts side)

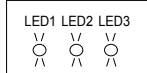

Blinking

Pattern	LED 1	LED 2	LED 3
1	Unit A status	Unit B status	Unit C status
2	Unit D status	Unit E status	Not lighted

MXZ-6C120VA
Control P.C. board

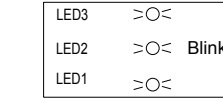

Blinking

Pattern	LED 1	LED 2	LED 3
1	Unit A status	Unit B status	Lighted
2	Unit C status	Unit D status	Not lighted
3	Unit E status	Unit F status	Blinking

A

- Turn OFF inverter-controlled lighting equipment.
- Turn OFF the power supply and turn ON again.
- Press EMERGENCY OPERATION switch.

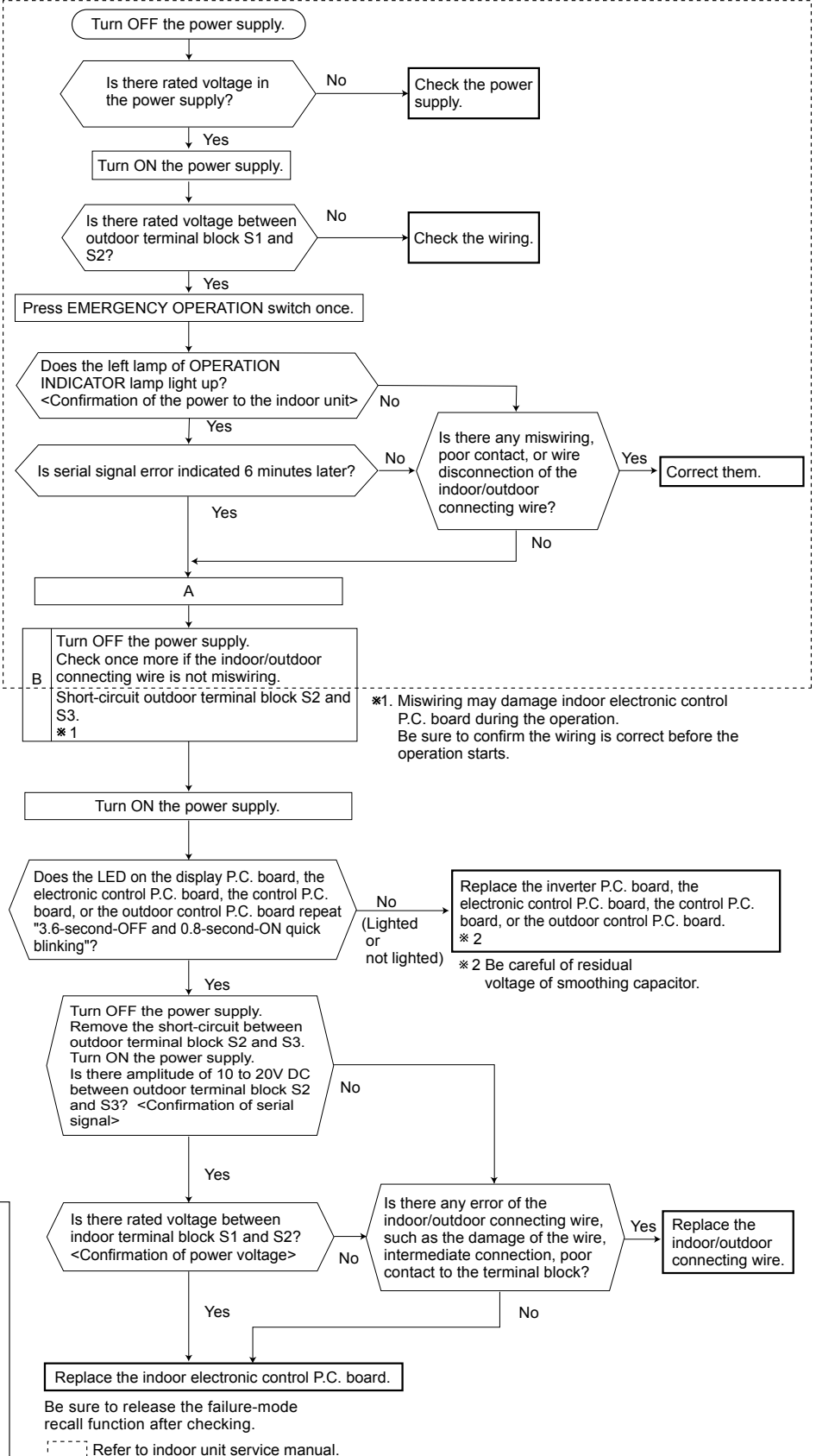
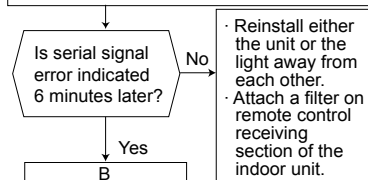

The cooling operation or heating operation does not operate.

© Check of R.V. coil

MXZ-2C30/2C40/2C52/3C54/3C68/4C71/4C80/5C100VA
MXZ-4C80/5C100VA2

	MXZ-2C	MXZ-3C/4C/5C
CN912	Power P.C. board	Noise filter P.C. board
CN781	—————	Electronic control P.C. board
CN933	Inverter P.C. board	—————

• When heating operation does not work.

1. Disconnect the lead wire leading to the compressor.
2. 3 minutes after turning ON the power supply, start EMERGENCY OPERATION in HEAT mode.

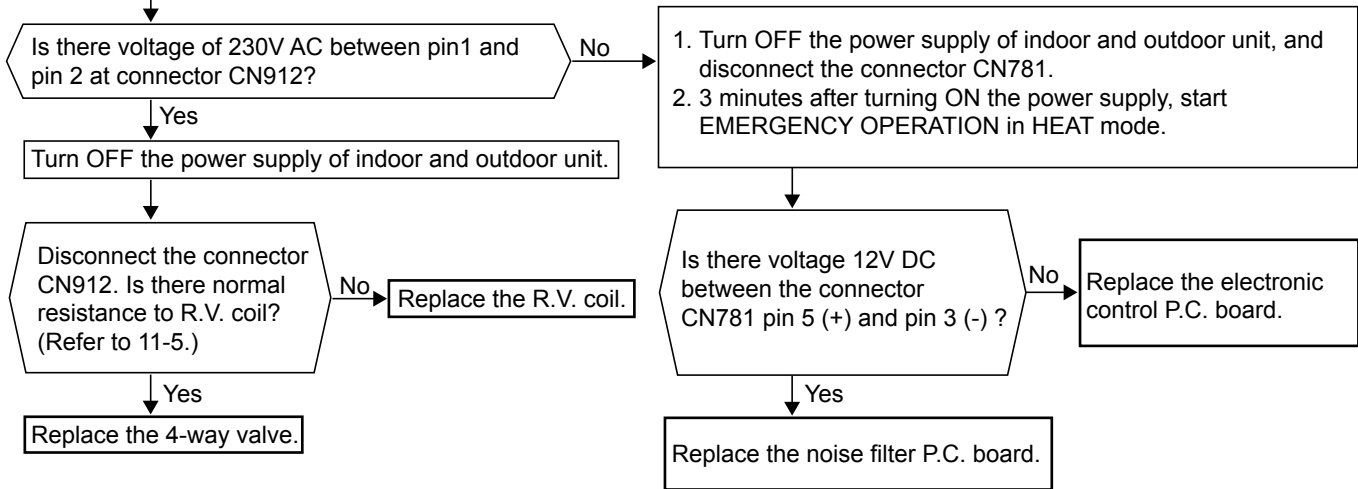

• When cooling operation does not work.

1. Disconnect the lead wire leading to the compressor.
2. 3 minutes after turning ON the power supply, start EMERGENCY OPERATION in COOL mode.

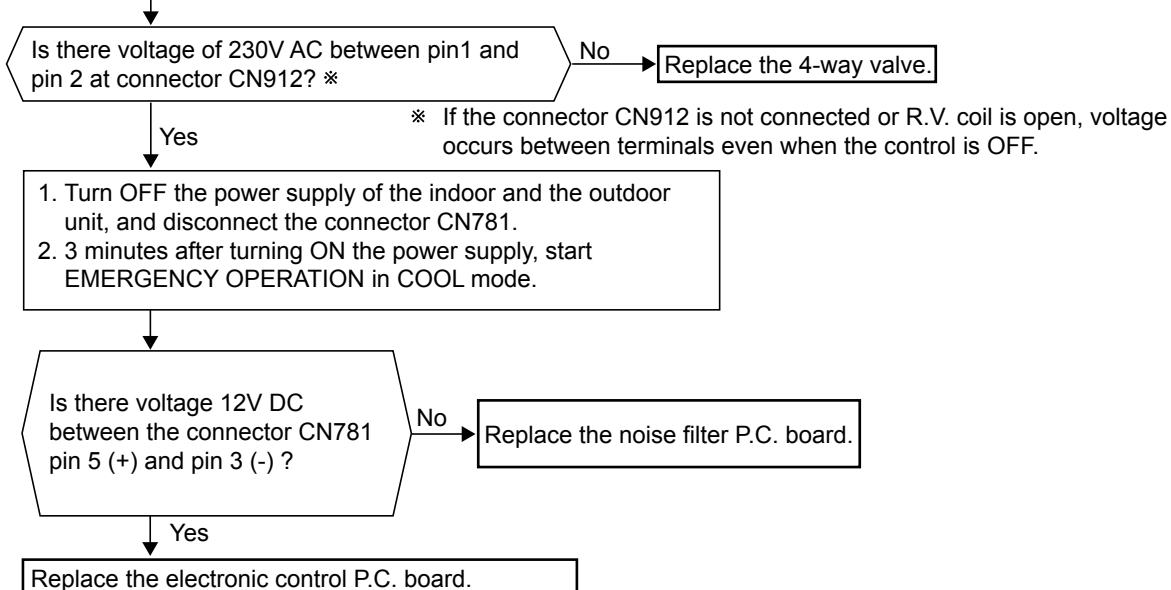

MXZ-6C120/6C122VA

• When heating operation does not work.

1. Disconnect the lead wire leading to the compressor.
2. 3 minutes after turning ON the power supply, start EMERGENCY OPERATION in HEAT mode.

	MXZ-6C120VA	MXZ-6C122VA
CN711	Control P.C. board	Outdoor control P.C. board
CN712		

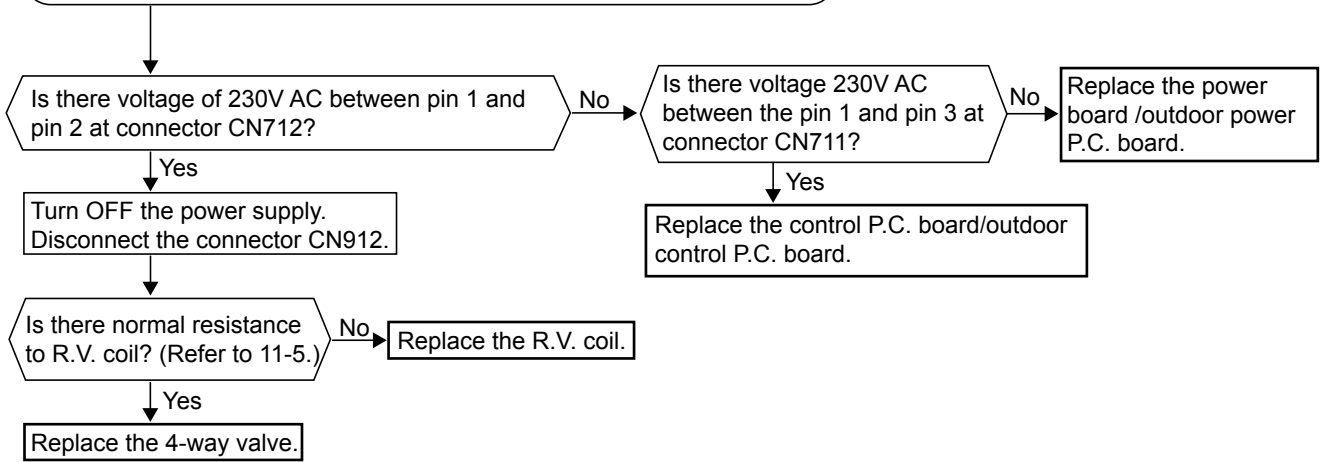

• When cooling operation does not work.

1. Disconnect the lead wire leading to the compressor.
2. 3 minutes after turning ON the power supply, start EMERGENCY OPERATION in COOL mode.

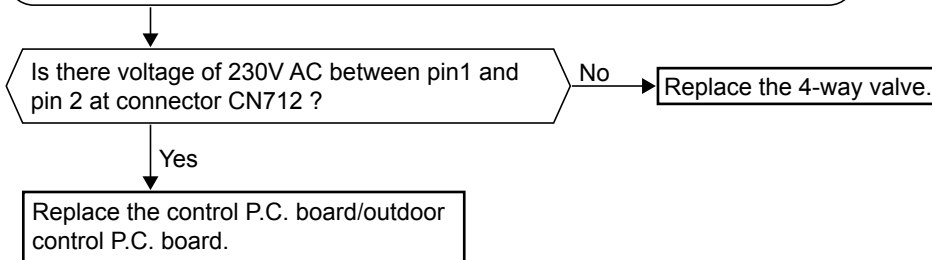

- When cooling, heat exchanger of non-operating indoor unit frosts.
- When heating, non-operating indoor unit gets warm.

Ⓧ Check of LEV

	MXZ-2C	MXZ-3C/ 4C/5C	MXZ-6C120	MXZ-6C122
CN791	Inverter P.C. board	Electronic control P.C. board	Control P.C. board	Outdoor control P.C. board
CN792				
CN793	—			
CN794				
CN795				
CN796				
CN797				

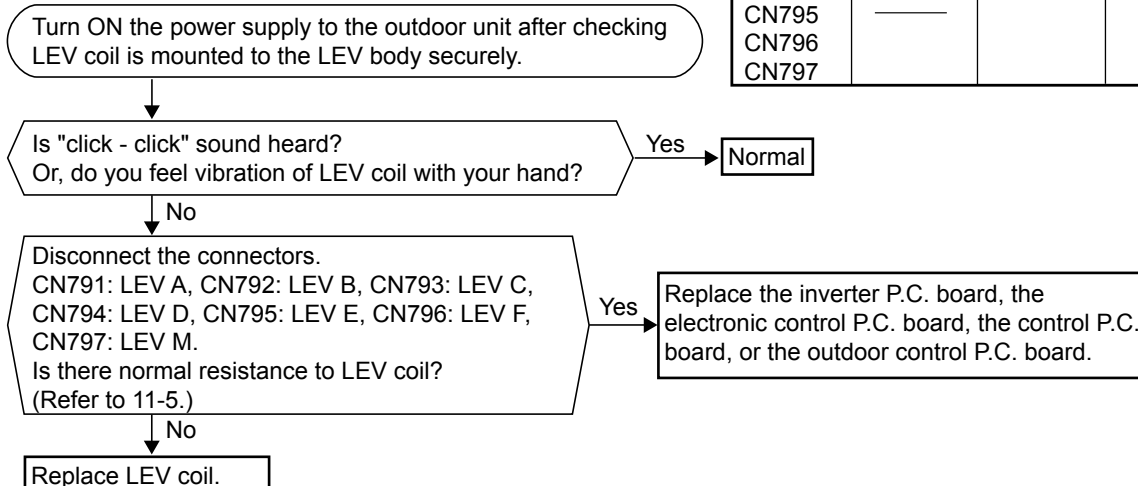

- When heating, room does not get warm.
- When cooling, room does not get cool.

Ⓔ How to check inverter/compressor

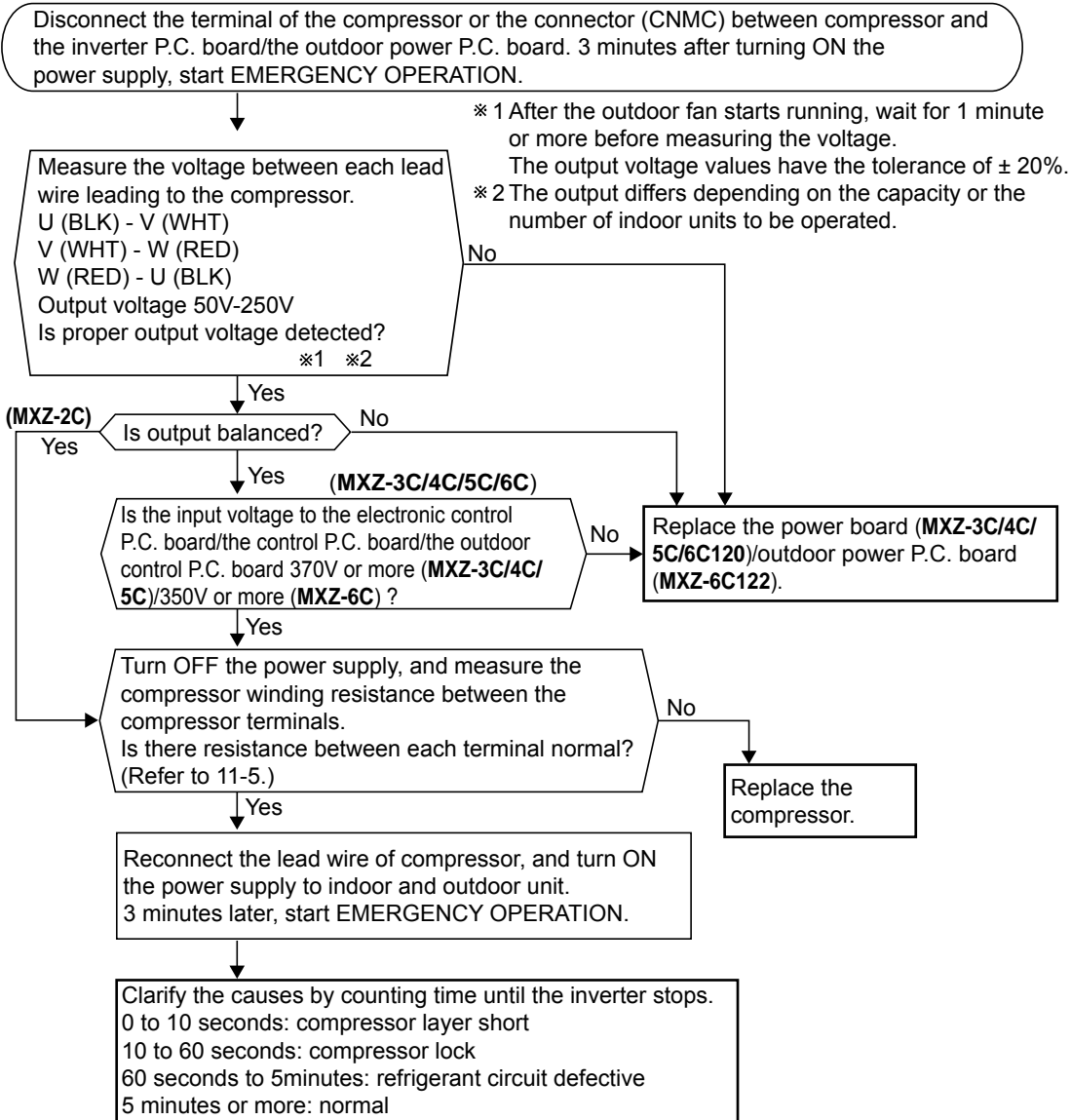

• When thermistor is abnormal.

Ⓕ Check of outdoor thermistors

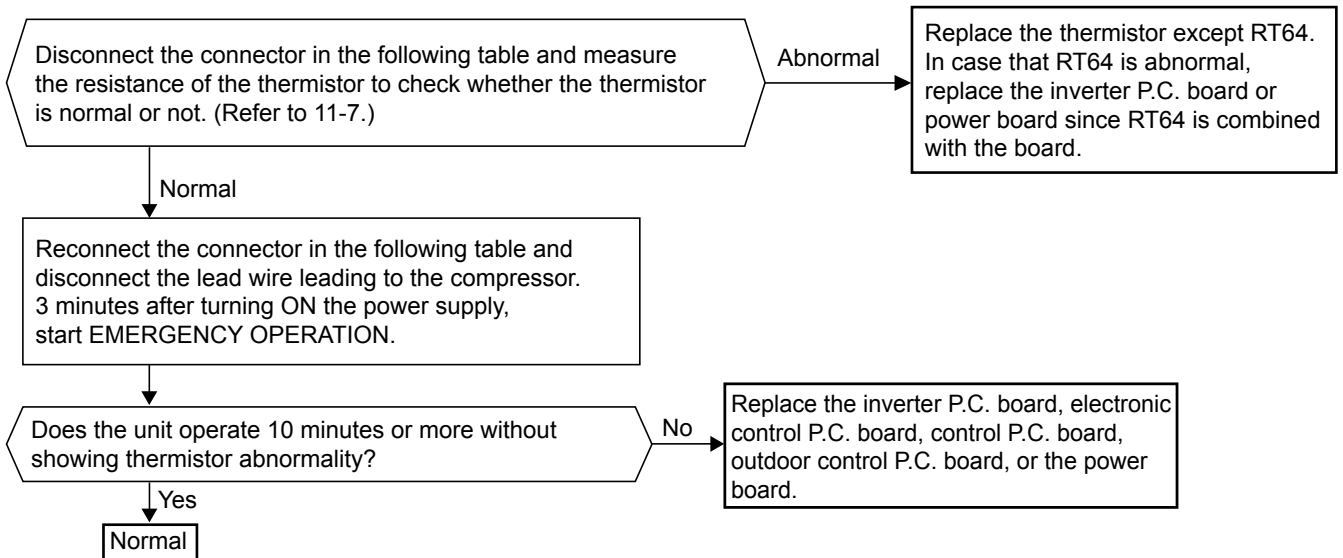

MXZ-2C30/2C40/2C52VA

Thermistor	Symbol	Connector, Pin No.	Board
Defrost	RT61	Between CN661 pin1 and pin2	Inverter P.C. board
Discharge temperature	RT62	Between CN661 pin3 and pin4	
Outdoor heat exchanger temperature	RT68	Between CN661 pin5 and pin6	
Fin temperature	RT64	Between CN662 pin1 and pin2	
Ambient temperature	RT65	Between CN663 pin1 and pin2	

MXZ-3C54/3C68/4C71/4C80/5C100VA MXZ-4C80/5C100VA2

Thermistor	Symbol	Connector, Pin No.	Board
Defrost	RT61	Between CN661 pin1 and pin2	Electronic control P.C. board
Discharge temperature	RT62	Between CN661 pin3 and pin4	
Outdoor heat exchanger temperature	RT68	Between CN661 pin7 and pin8	
Ambient temperature	RT65	Between CN663 pin1 and pin2	
Fin temperature	RT64	Between CN3 pin1 and pin2	Power board

MXZ-6C120VA

Thermistor	Symbol	Connector, Pin No.	Board
Defrost	RT61	Between CN661 pin1 and pin2	Control P.C. board
Discharge temperature	RT62	Between CN661 pin3 and pin4	
Outdoor heat exchanger temperature	RT68	Between CN661 pin5 and pin6	
Ambient temperature	RT65	Between CN663 pin1 and pin2	

MXZ-6C122VA

Thermistor	Symbol	Connector, Pin No.	Board
Defrost	RT61	Between CN661 pin1 and pin2	Outdoor control P.C. board
Discharge temperature	RT62	Between CN661 pin3 and pin4	
Outdoor heat exchanger temperature	RT68	Between CN661 pin5 and pin6	
Ambient temperature	RT65	Between CN663 pin1 and pin2	

• Fan motor does not operate or stops operating shortly after starting the operation.

© Check of outdoor fan motor

MXZ-2C30/2C40/2C52/3C54/3C68/4C71/4C80/5C100VA
MXZ-4C80/5C100VA2

	MXZ-2C	MXZ-3C/4C/5C
CN931	Inverter P.C. board	Electronic control P.C. board
CN932		

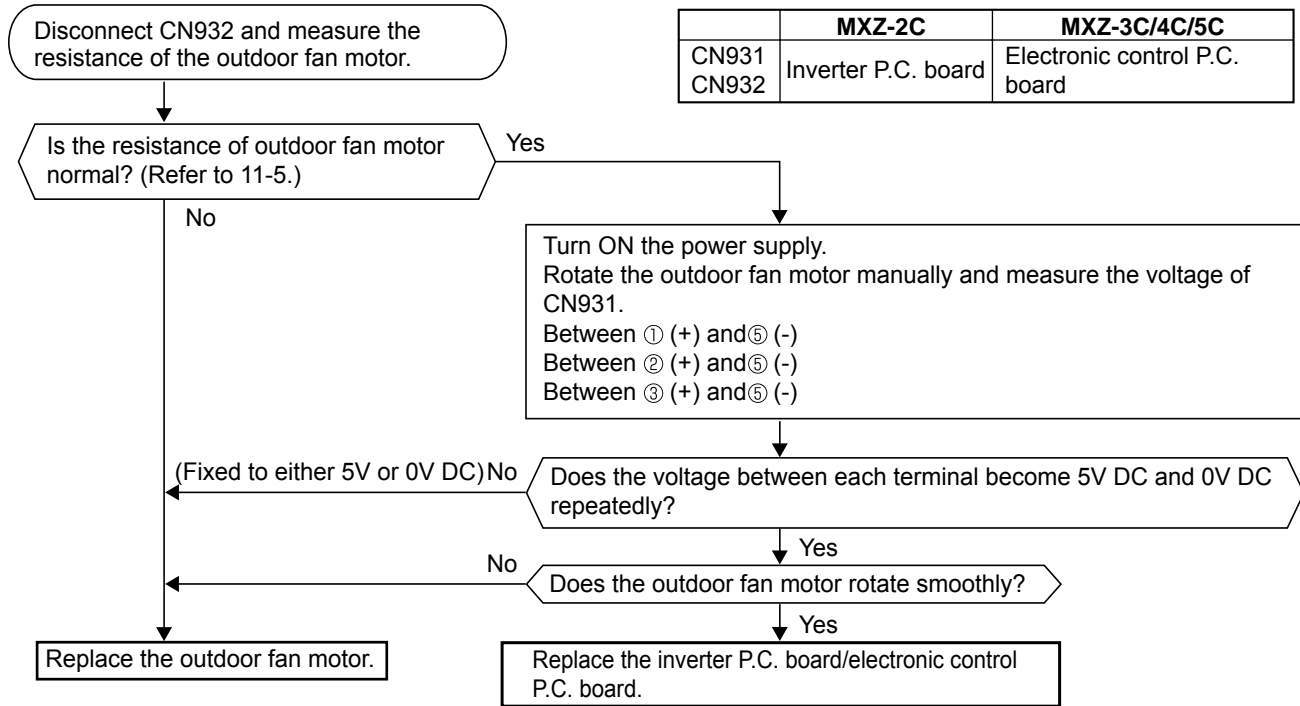

MXZ-6C120/6C122VA

	MXZ-6C120	MXZ-6C122
CN931	Control P.C. board	Outdoor control P.C. board

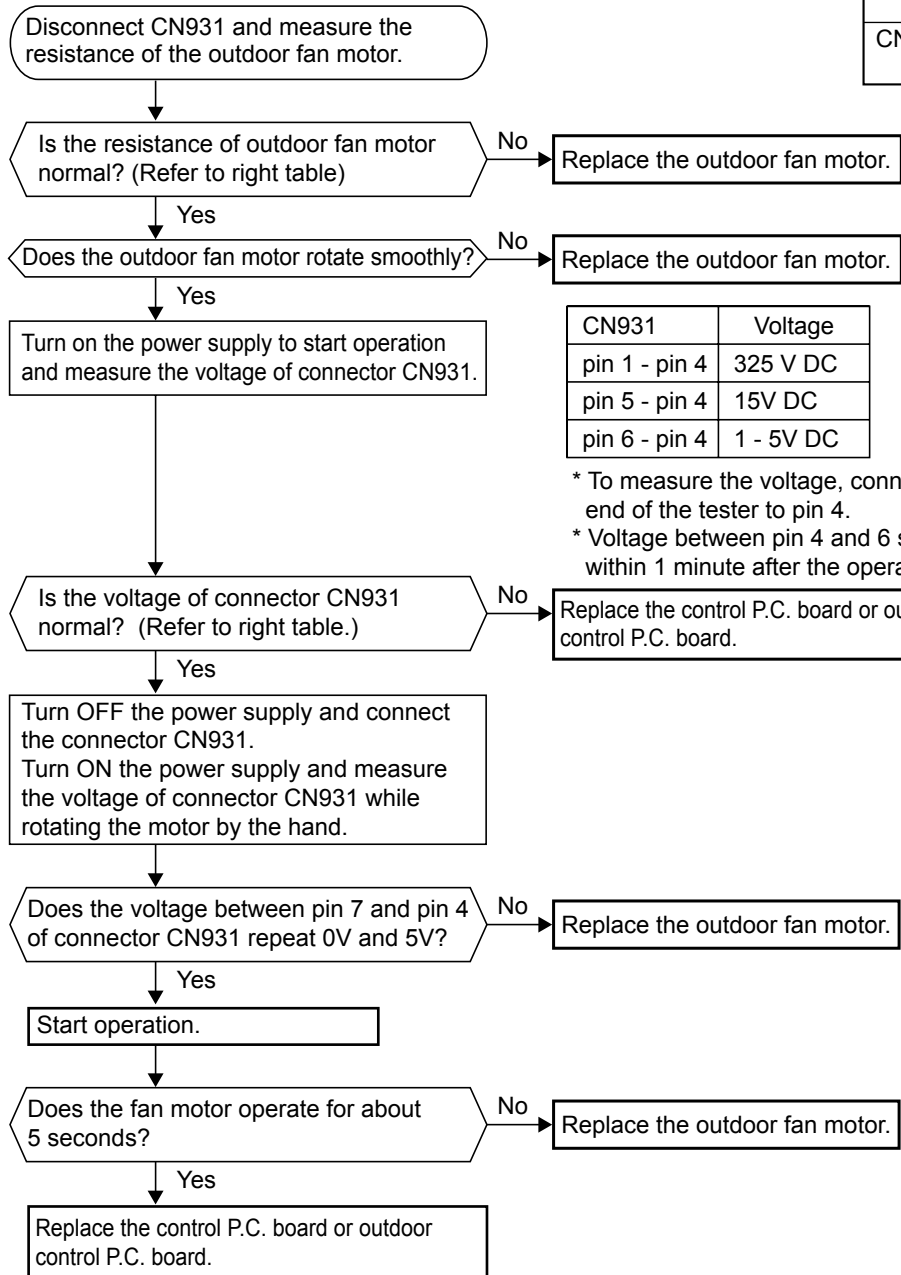

Measuring points	Resistance
pin 1 - pin 4	∞
pin 5 - pin 4	60 kΩ
pin 6 - pin 4	160 kΩ
pin 7 - pin 4	∞

* To measure the resistance, connect the negative (-) end of the tester to pin 4.

CN931	Voltage
pin 1 - pin 4	325 V DC
pin 5 - pin 4	15V DC
pin 6 - pin 4	1 - 5V DC

* To measure the voltage, connect the negative (-) end of the tester to pin 4.

* Voltage between pin 4 and 6 should be measured within 1 minute after the operation starts.

• When the operation frequency does not go up from lowest frequency.

⊕ **Check of HPS**

	MXZ-3C/4C/5C	MXZ-6C120	MXZ-6C1222
CN681	Electronic control P.C. board	Control P.C. board	Outdoor control P.C. board

MXZ-3C68/4C71/4C80/5C100/6C120/6C122VA
MXZ-4C80/5C100VA2

1. Disconnect the connector CN681.
2. Check the resistance of HPS 1 minute after the outdoor unit power supply was turned OFF.

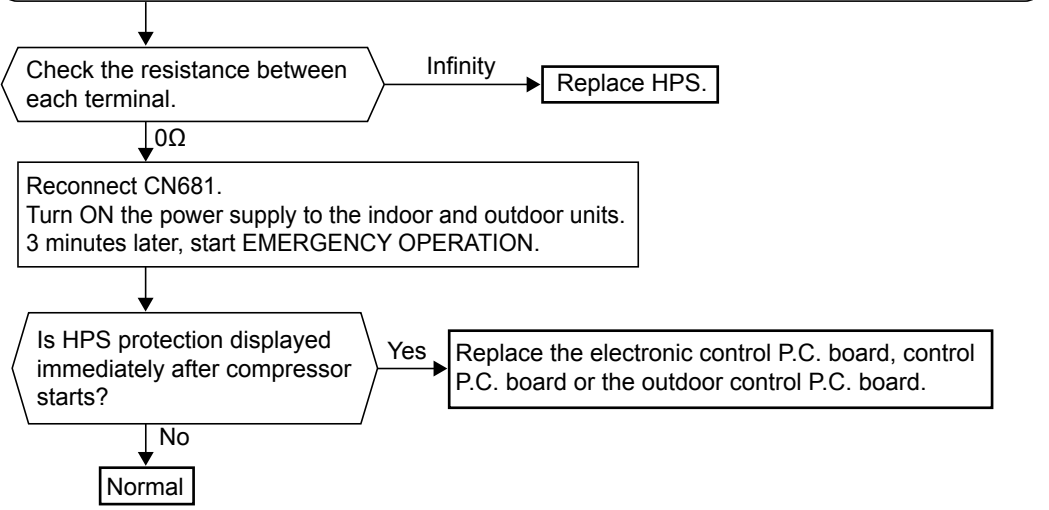

① The other cases

Indoor unit does not operate. (different operating models in multi system)

- When you try to run two indoor units simultaneously, one for cooling and the other for heating, the unit which transmits signal to the outdoor unit first decides the operation mode.
- When the above situation occurs, set all the indoor units to the same mode, turn OFF the indoor units, then turn them back ON.
- Though the top of the indoor unit sometimes gets warm, this does not mean malfunction. The reason is that the refrigerant gas continuously flows into the indoor unit even while it is not operating.

② Check of bus-bar voltage

MXZ-3C/4C/5C

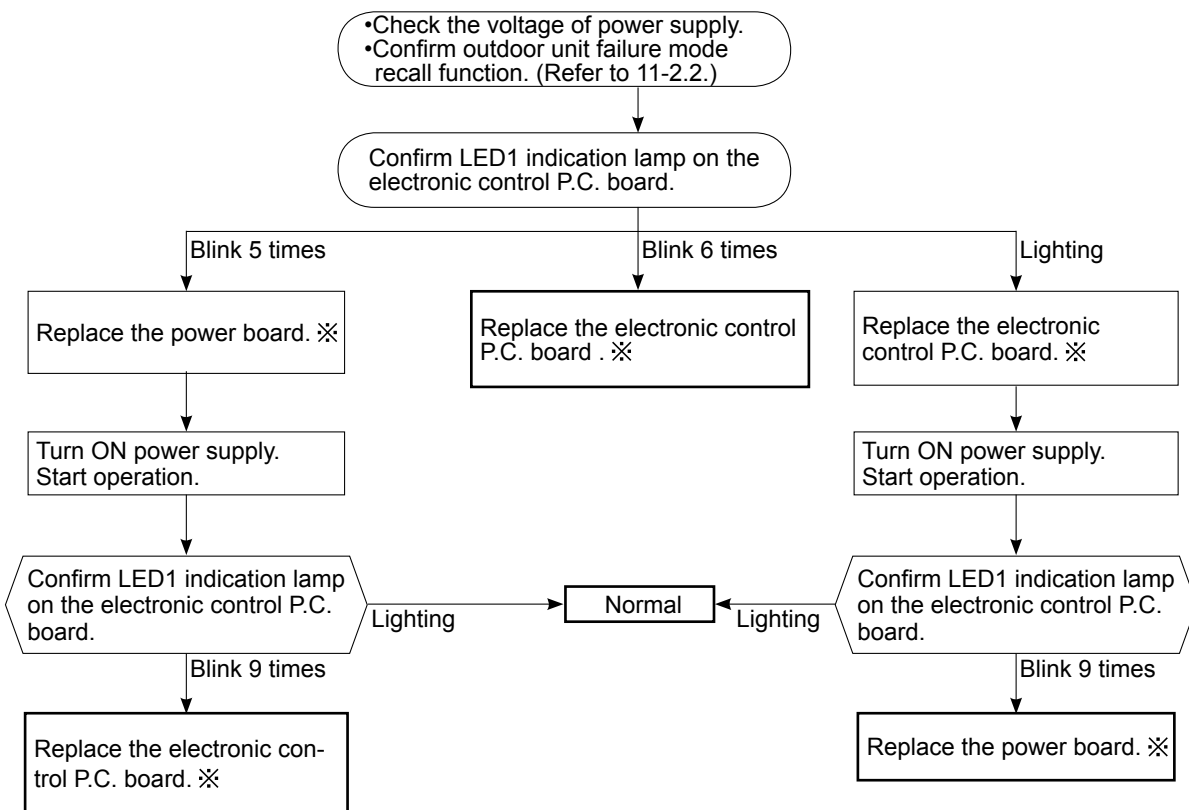

※ Turn OFF power supply before removing P.C. board.

11-7. TEST POINT DIAGRAM AND VOLTAGE

1. Inverter P.C. board

MXZ-2C30VA MXZ-2C40VA MXZ-2C52VA

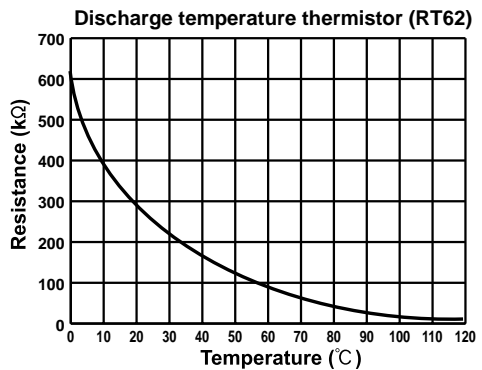
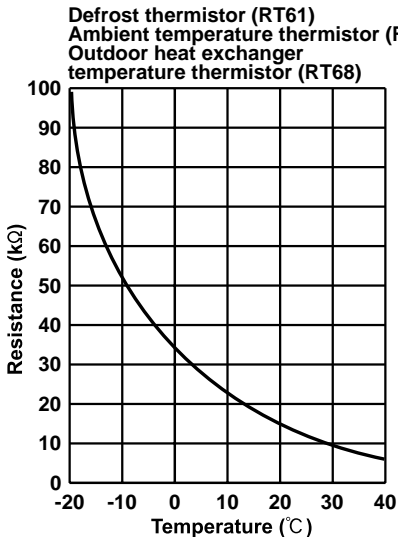
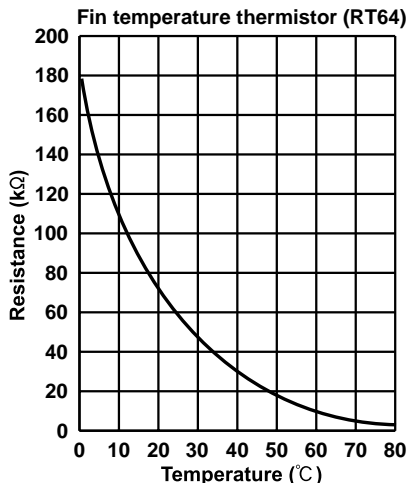
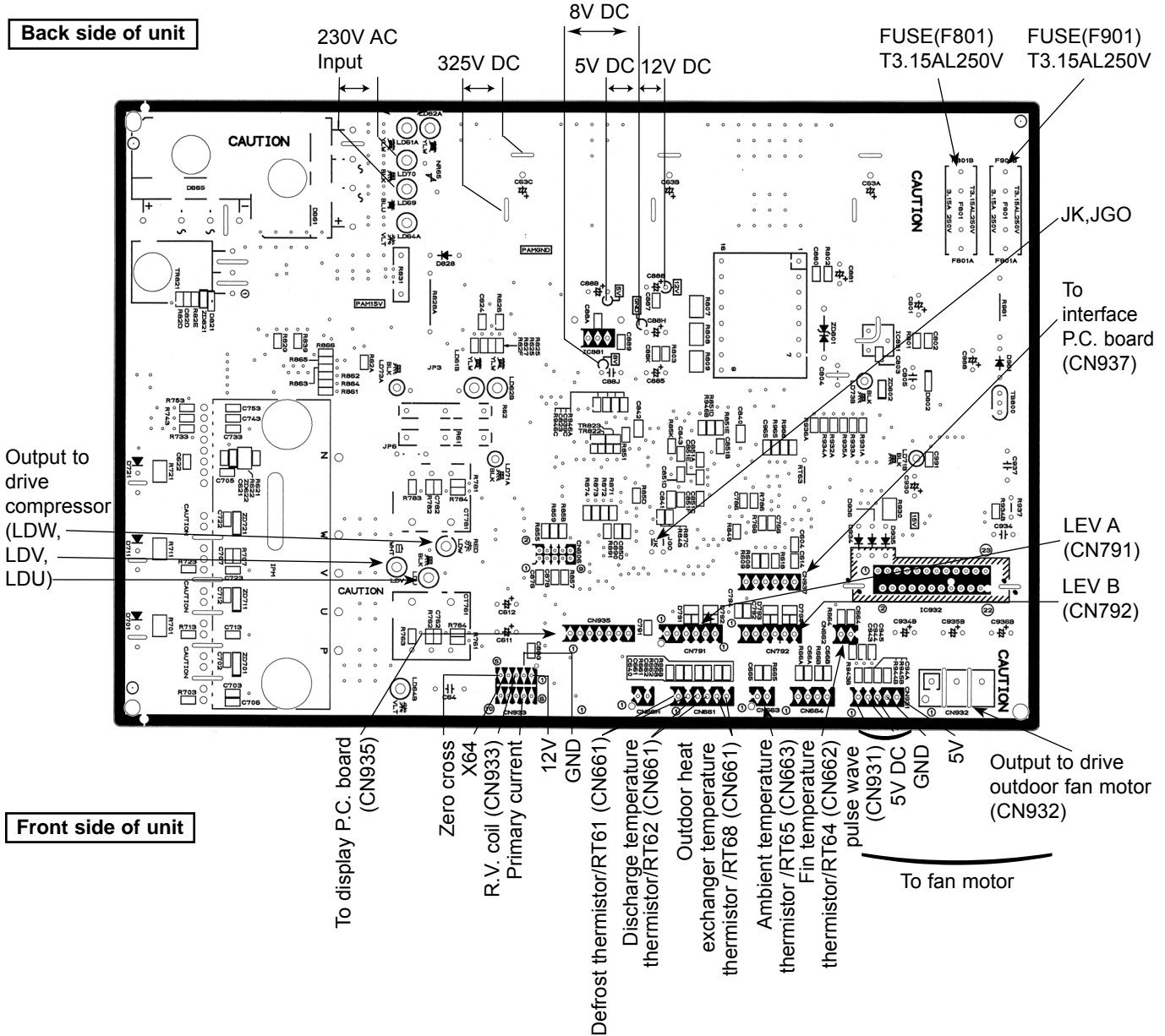

2. Electronic control P.C. board

MXZ-3C54VA MXZ-3C68VA MXZ-4C71VA

Defrost thermistor (RT61)
 Ambient temperature thermistor (RT65)
 Outdoor heat exchanger temperature thermistor (RT68)

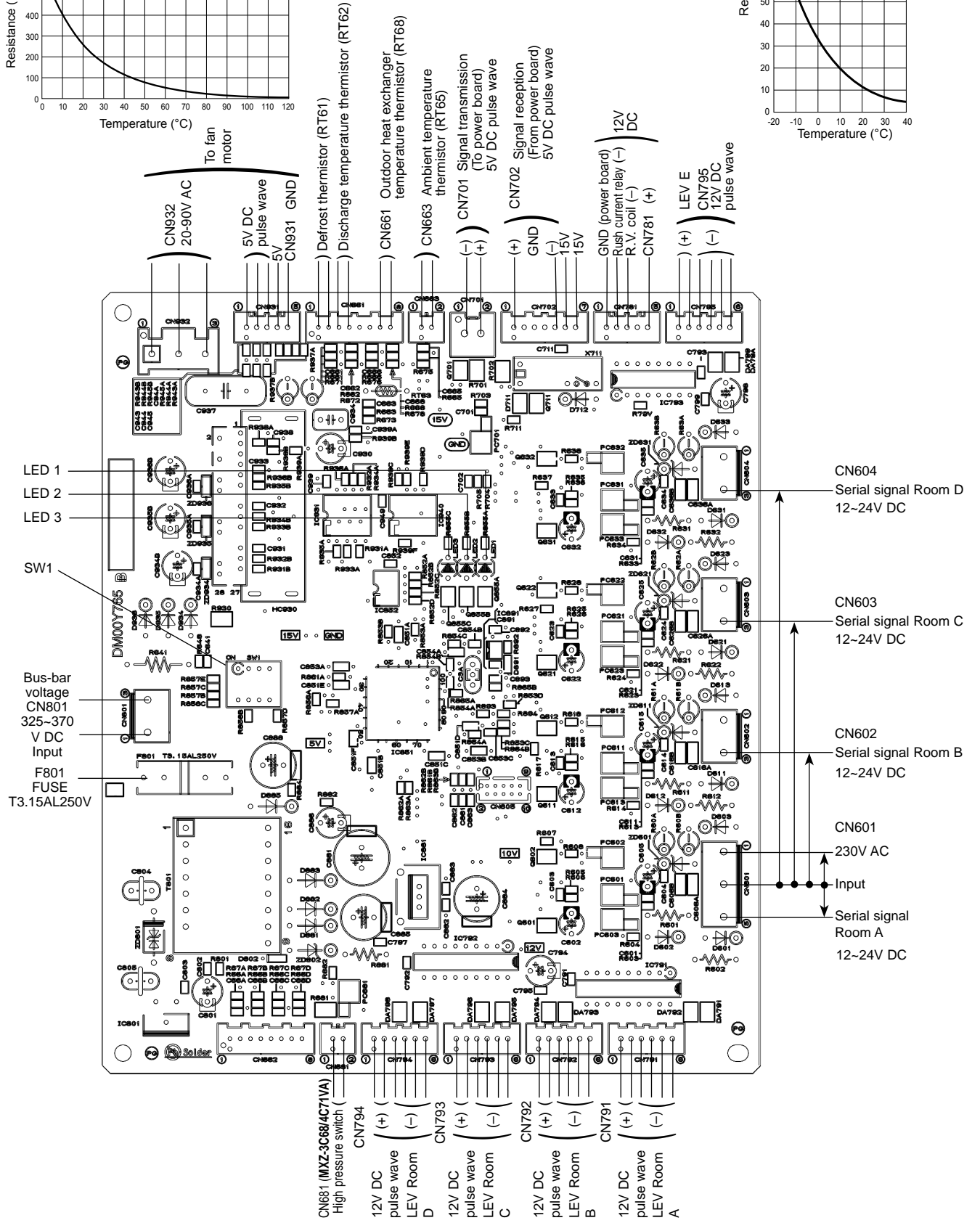
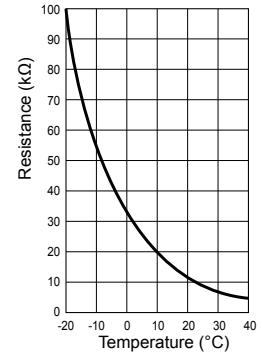
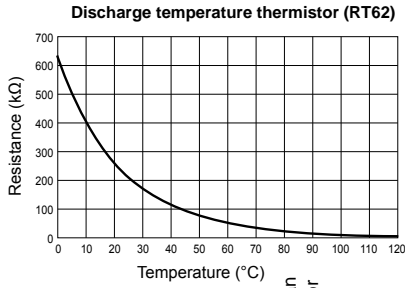

MXZ-4C80VA MXZ-5C100VA
MXZ-4C80VA2 MXZ-5C100VA2

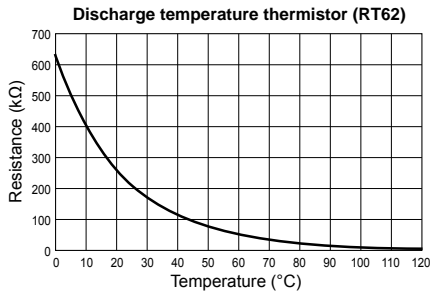

Defrost thermistor (RT61)
 Ambient temperature thermistor (RT65)
 Outdoor heat exchanger temperature thermistor (RT68)

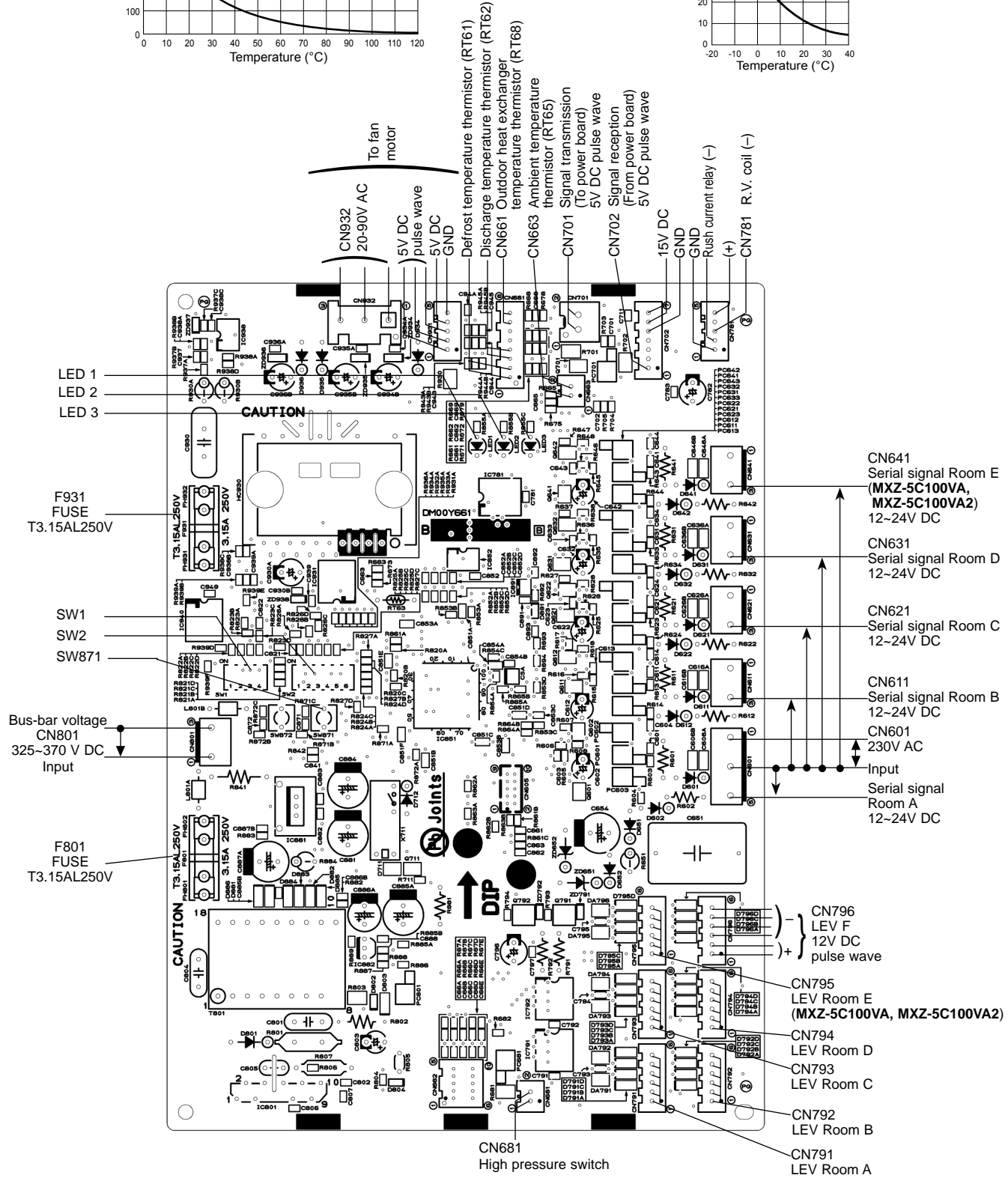
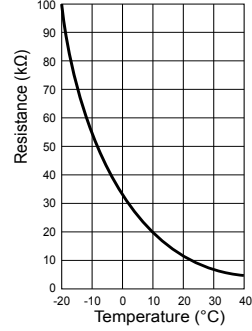

3. Control P.C. board/outdoor control P.C. board MXZ-6C120VA MXZ-6C122VA

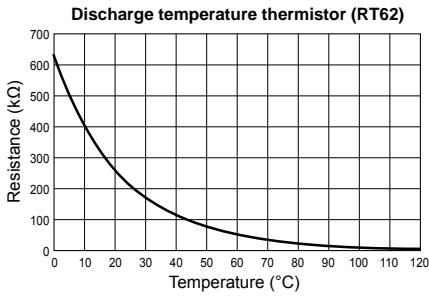

Defrost thermistor (RT61)
Ambient temperature thermistor (RT65)
Outdoor heat exchanger temperature thermistor (RT68)

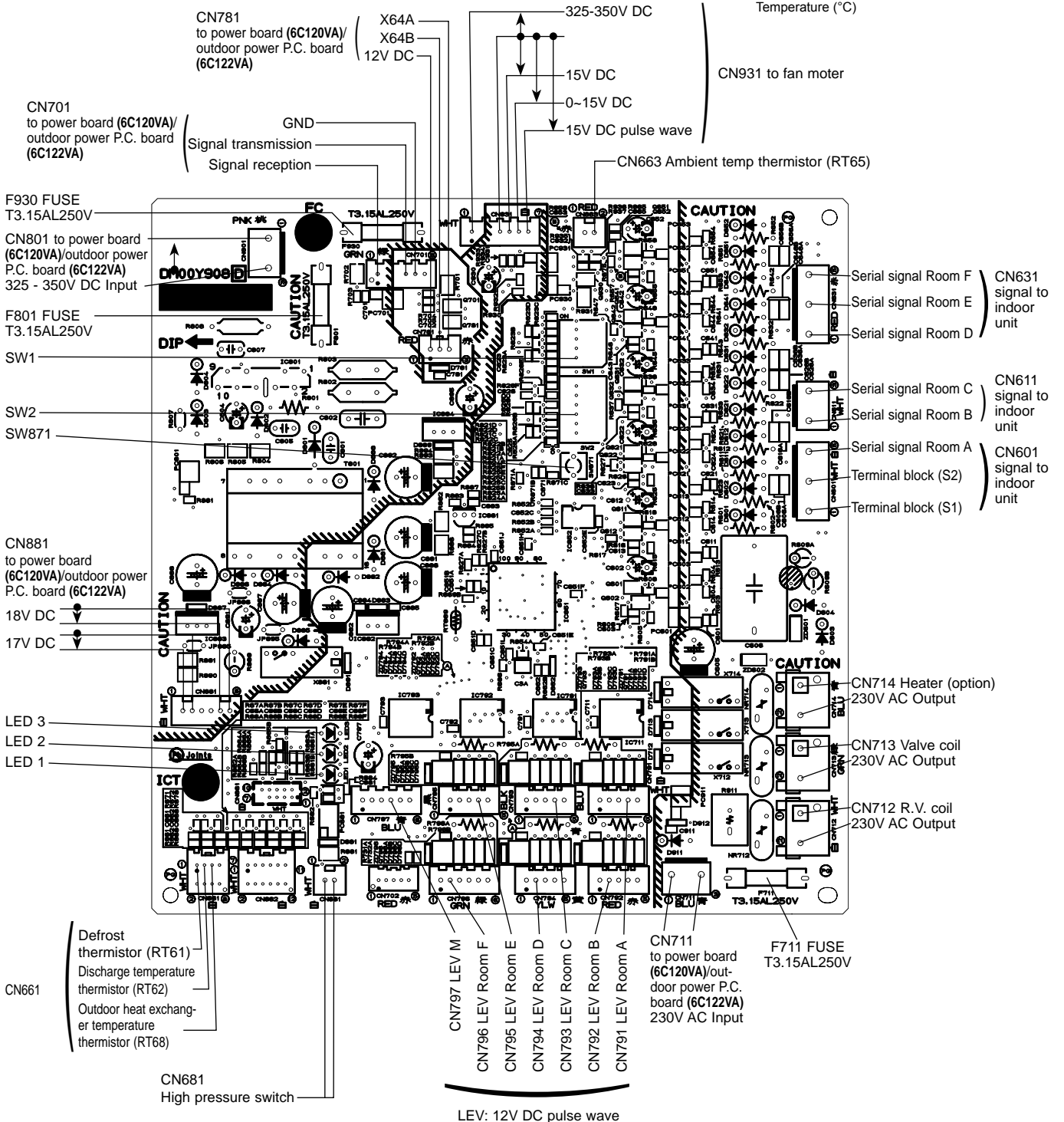
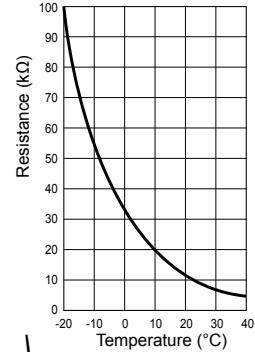

4. Noise filter P.C. board
MXZ-3C54VA MXZ-3C68VA MXZ-4C71VA

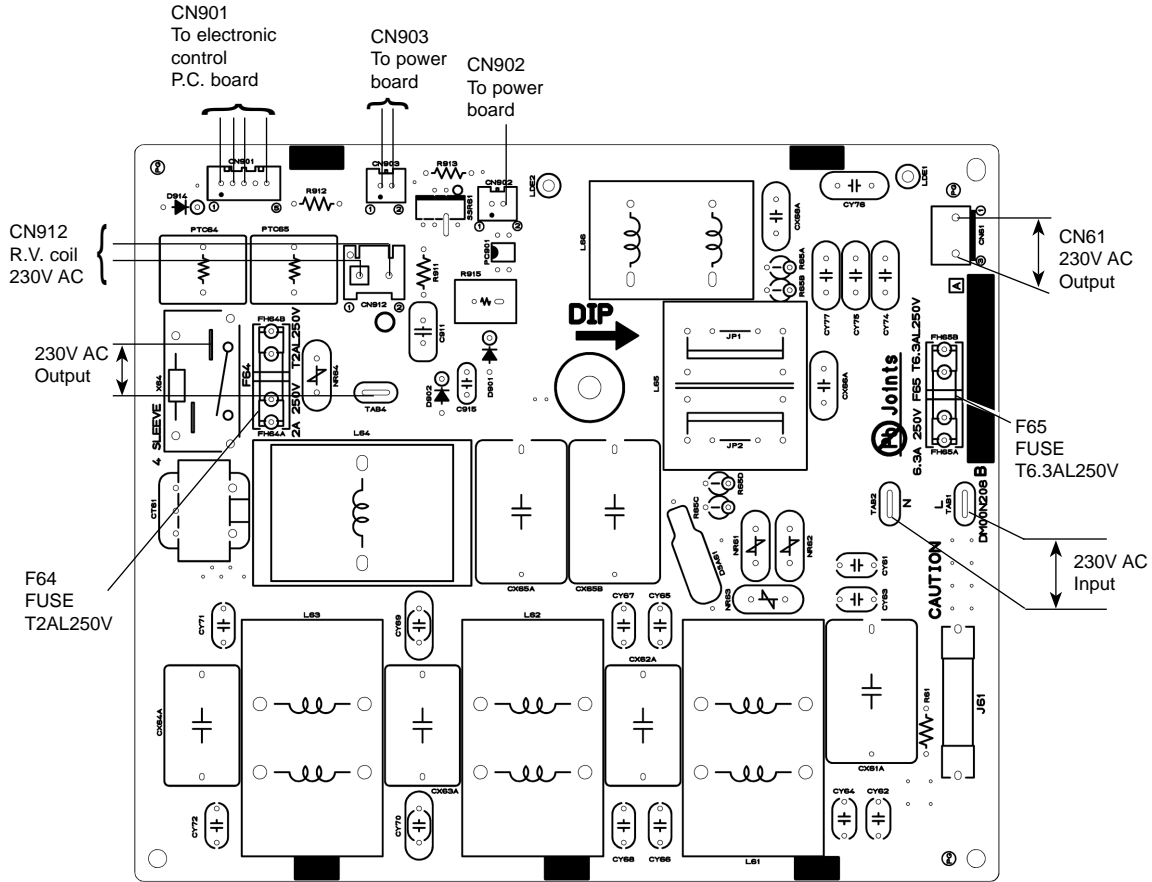

MXZ-4C80VA MXZ-4C80VA2 MXZ-5C100VA MXZ-5C100VA2

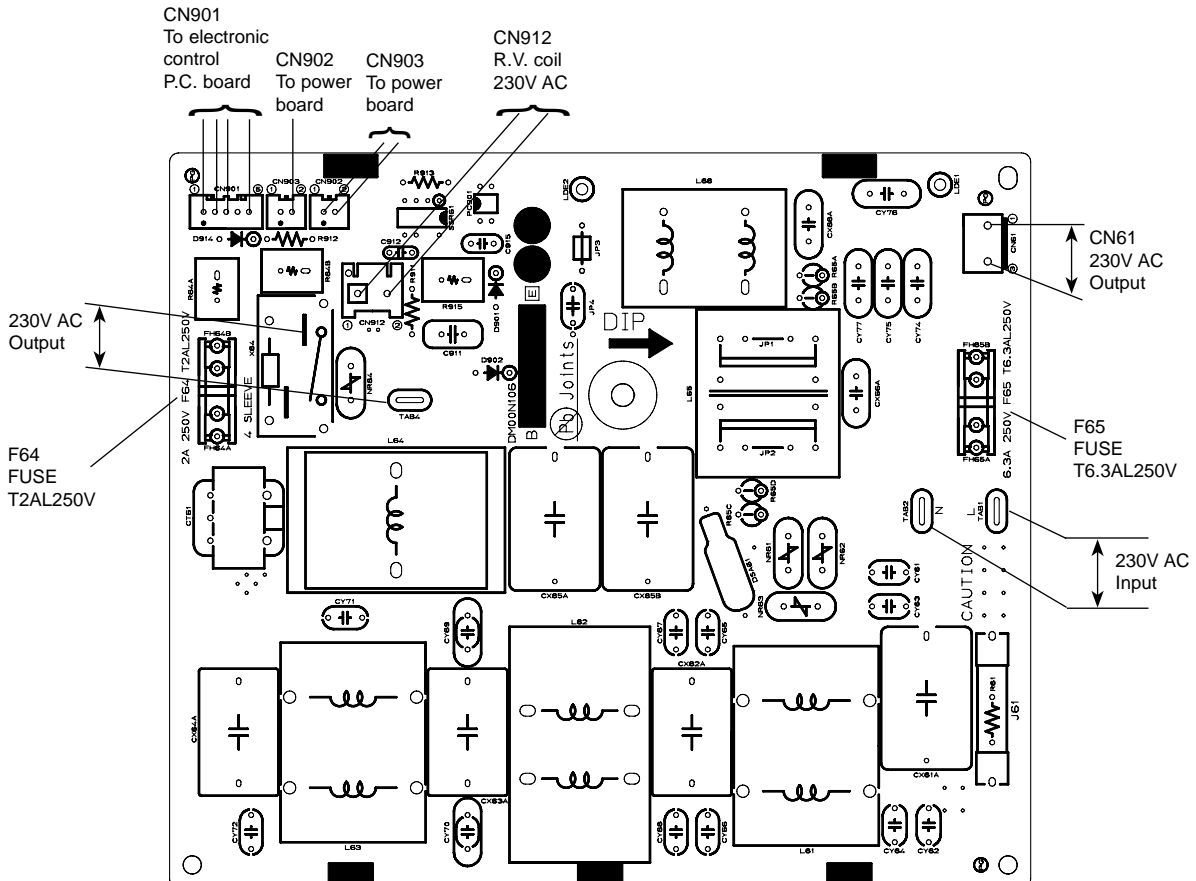

5. Power P.C. board
MXZ-2C30VA MXZ-2C40VA MXZ-2C52VA

Back side of unit

Front side of unit

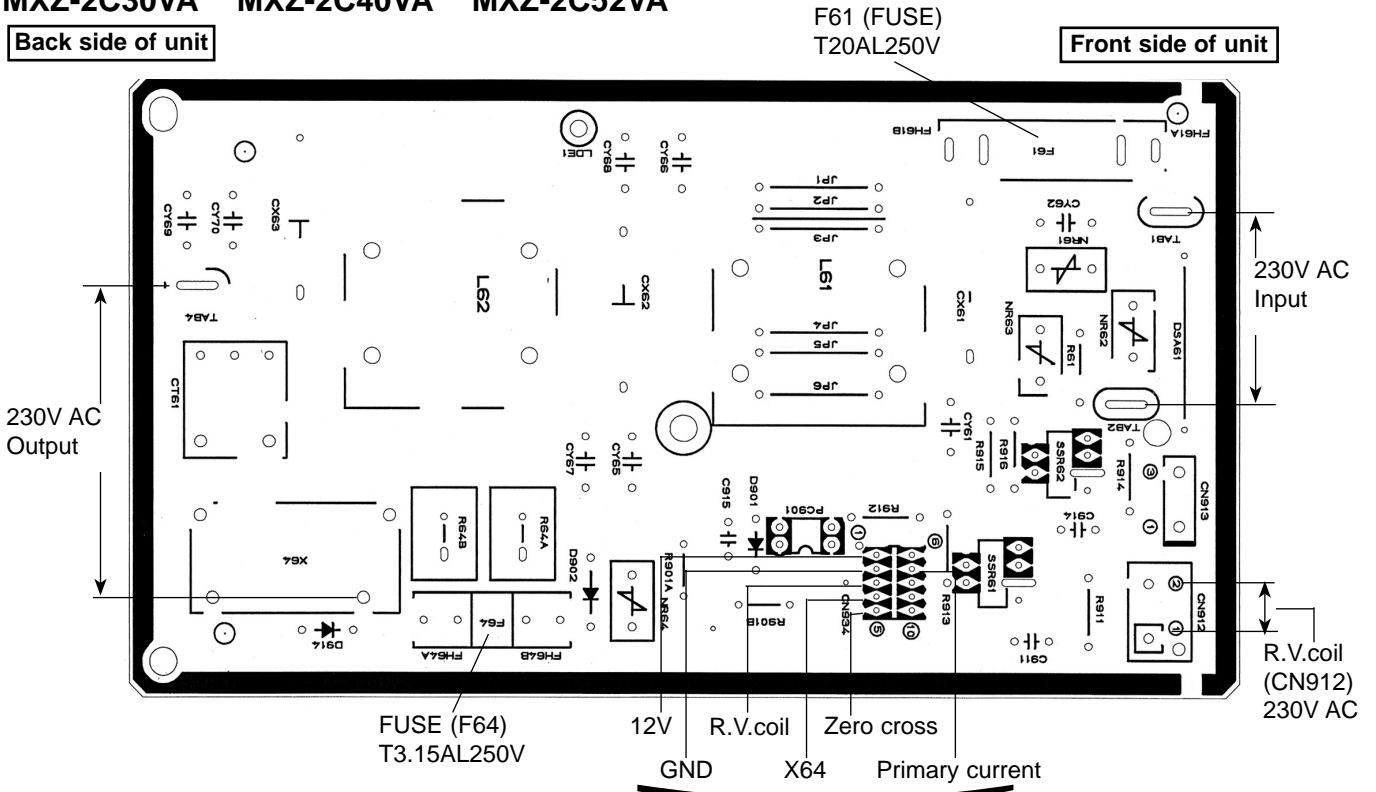

6. Power board
MXZ-3C54VA MXZ-3C68VA MXZ-4C71VA
MXZ-4C80VA MXZ-5C100VA
MXZ-4C80VA2 MXZ-5C100VA2

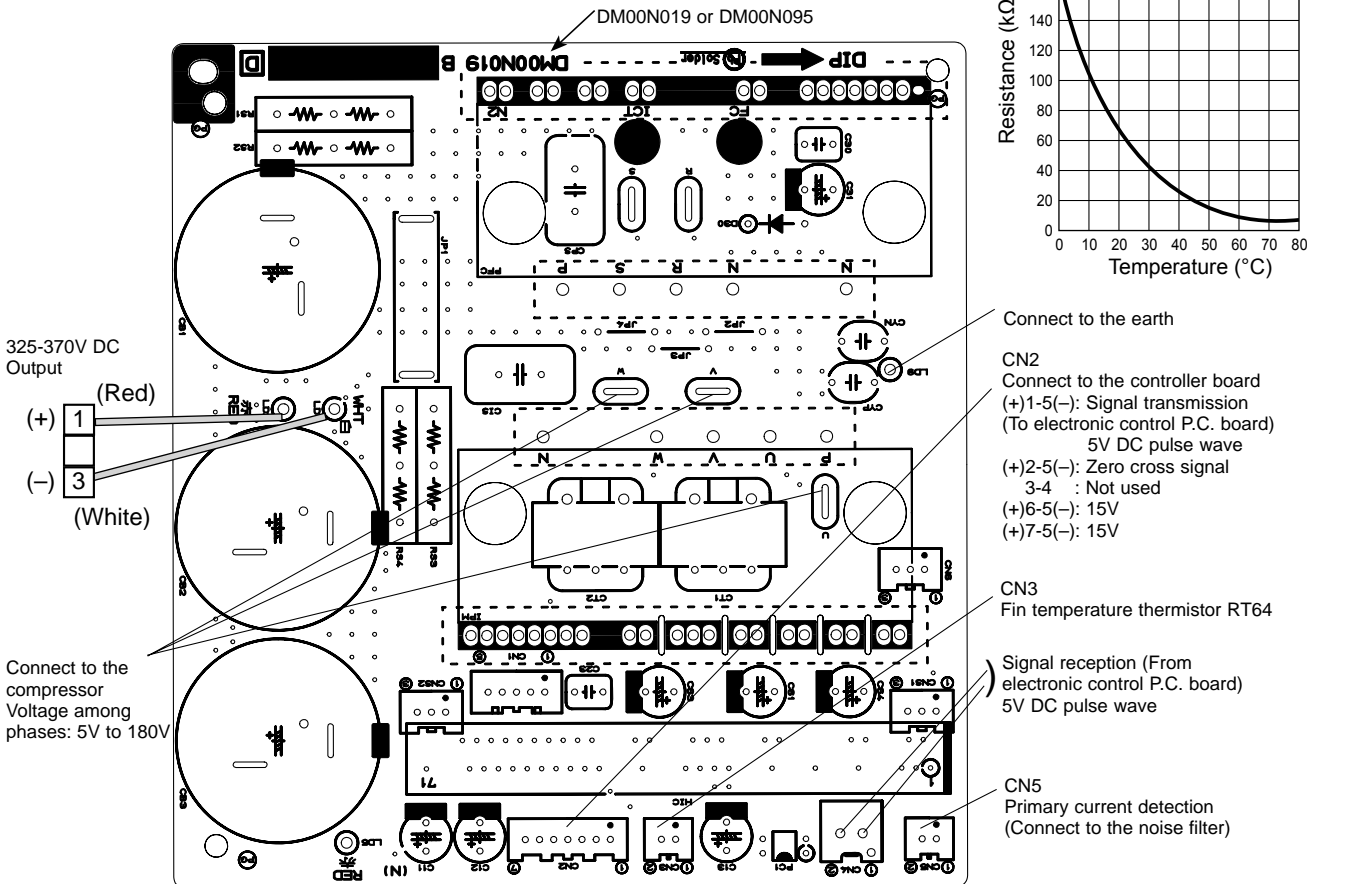

7. Power board/outdoor power P.C. board

MXZ-6C120VA MXZ-6C122VA

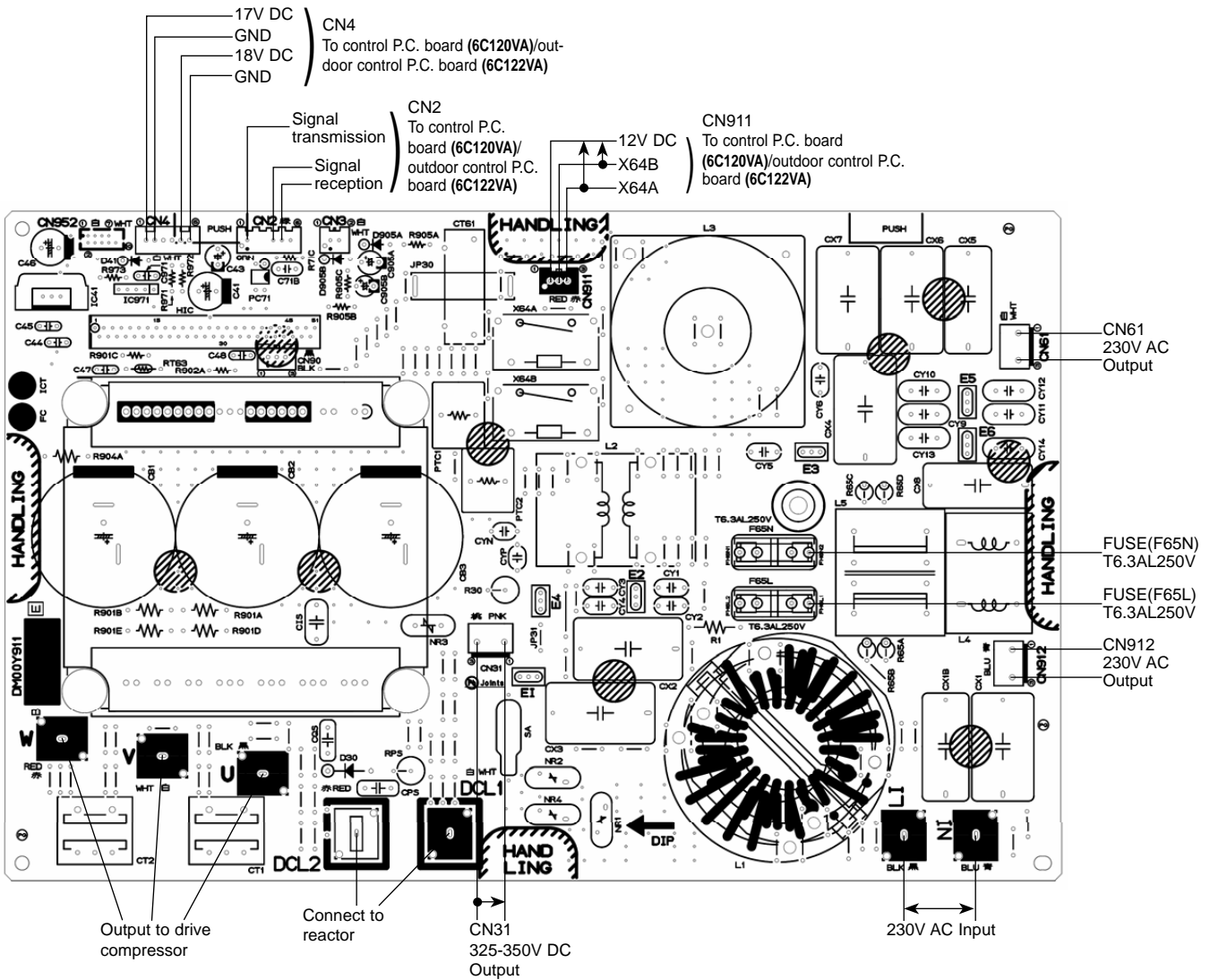

8. Display P.C. board
 MXZ-2C30VA MXZ-2C40VA MXZ-2C52VA

To inverter P.C. board (CN936)

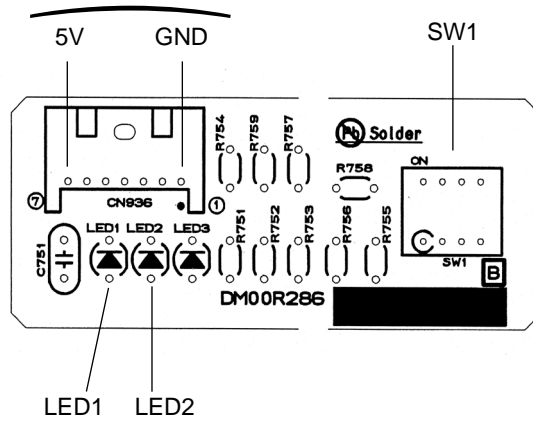

9. Interface P.C. board
 MXZ-2C30VA MXZ-2C40VA MXZ-2C52VA

To inverter P.C. board (CN938)

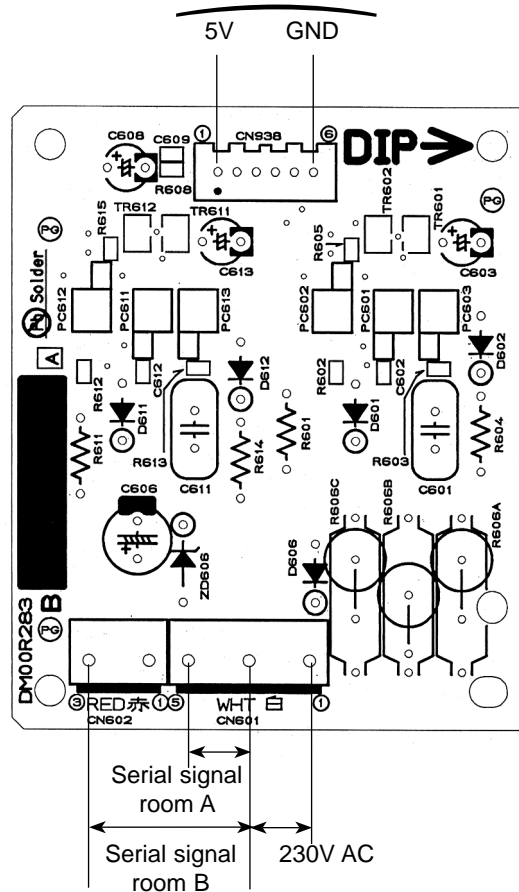

<"Terminal with locking mechanism" Detaching points>

The terminal which has the locking mechanism can be detached as shown below.
There are two types (Refer to (1) and (2)) of the terminal with locking mechanism.
The terminal without locking mechanism can be detached by pulling it out.
Check the shape of the terminal before detaching.

(1) Slide the sleeve and check if there is a locking lever or not.

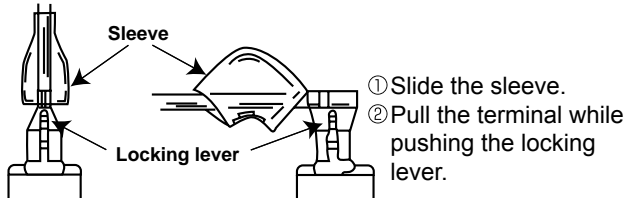

(2) The terminal with this connector has the locking mechanism.

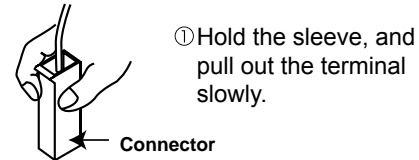

12-1. MXZ-2C30VA MXZ-2C40VA MXZ-2C52VA

NOTE: Turn OFF power supply before disassembly.

OPERATING PROCEDURE	PHOTOS
<p>1. Removing the cabinet</p> <ol style="list-style-type: none"> (1) Remove the screw fixing the service panel. (2) Pull down the service panel and remove it. (3) Disconnect the power supply and indoor/outdoor connecting wire. (4) Remove the screws fixing the top panel. (5) Remove the top panel. (6) Remove the screws fixing the cabinet. (7) Remove the cabinet. (8) Remove the screws fixing the back panel. (9) Remove the back panel. <p>Photo 2</p>	<p>Photo 1</p>

OPERATING PROCEDURE

2. Removing the inverter assembly, inverter P.C. board and power P.C. board

- (1) Remove the top panel, cabinet and service panel (Refer to 1).
- (2) Disconnect the power supply and indoor/outdoor connecting wire and remove the back panel (Refer to 1).
- (3) Disconnect the earth wires, the lead wire to the reactor and the following connectors;
<Power P.C. board>
CN912 (R.V coil)
<Inverter P.C. board>
CN931, CN932 (Fan motor)
CN661 (Defrost thermistor, discharge temperature thermistor and outdoor heat exchanger temperature thermistor)
CN663 (Ambient temperature thermistor)
CN791, CN792 (LEV A, LEV B)
- (4) Remove the compressor connector (CN61).
- (5) Remove the screws fixing the relay panel.
- (6) Remove the inverter assembly.
- (7) Disconnect all connectors and lead wires on the inverter P.C. board.
- (8) Remove the inverter P.C. board from the inverter assembly.
- (9) Remove the screw fixing the power P.C. board.
- (10) Disconnect all connectors and lead wires on the power P.C. board.
- (11) Remove the power P.C. board from the inverter assembly.

3. Removing the R.V. coil

- (1) Remove the top panel, cabinet and service panel (Refer to 1).
- (2) Disconnect the power supply and indoor/outdoor connecting wire and remove the back panel (Refer to 1).
- (3) Remove the inverter assembly (Refer to 2).
- (4) Remove the R.V. coil.

4. Removing the discharge temperature thermistor, defrost thermistor and outdoor heat exchanger temperature thermistor

- (1) Remove the top panel, cabinet and service panel (Refer to 1).
- (2) Disconnect the power supply and indoor/outdoor connecting wire and remove the back panel (Refer to 1).
- (3) Remove the inverter assembly (Refer to 2).
- (4) Pull out the discharge temperature thermistor from its holder.
- (5) Pull out the defrost thermistor from its holder (Photo 6).
- (6) Pull out the outdoor heat exchanger temperature thermistor from its holder (Photo 6).

PHOTOS

Photo 3

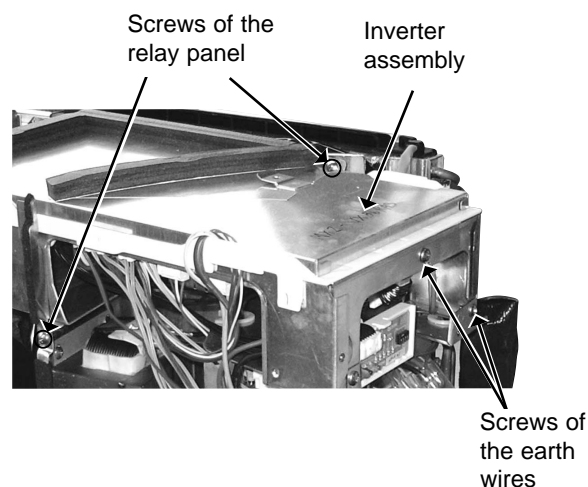

Photo 4

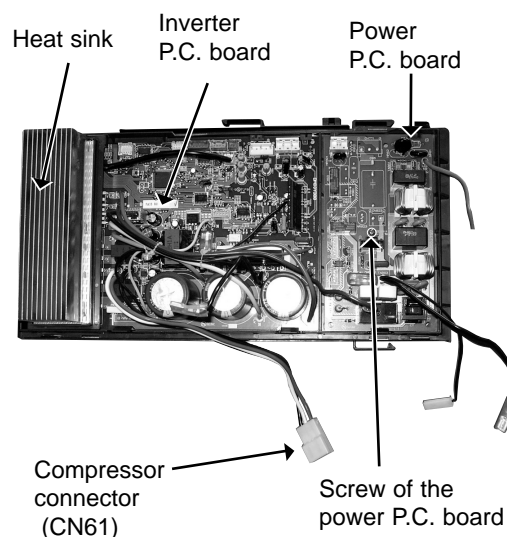
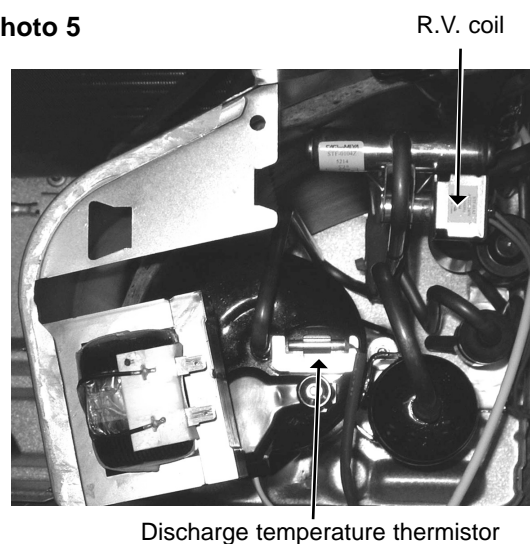

Photo 5



OPERATING PROCEDURE

5. Removing the outdoor fan motor

- (1) Remove the top panel, cabinet and service panel (Refer to 1).
- (2) Disconnect the power supply and indoor/outdoor connecting wire.
- (3) Disconnect the connectors for outdoor fan motor.
- (4) Remove the propeller nut.
- (5) Remove the propeller.
- (6) Remove the screws fixing the fan motor (Photo 7).
- (7) Remove the fan motor.

6. Removing the compressor and 4-way valve

- (1) Remove the top panel, cabinet and service panel (Refer to 1).
- (2) Disconnect the power supply and indoor/outdoor connecting wire and remove the back panel (Refer to 1).
- (3) Remove the inverter assembly (Refer to 2).
- (4) Recover gas from the refrigerant circuit.
NOTE: Recover gas from the pipes until the pressure gauge shows 0 kg/cm² (0 MPa).
- (5) Detach the brazed part of the suction and the discharge pipe connected with compressor.
- (6) Remove the nuts of compressor legs.
- (7) Remove the compressor.
- (8) Detach the brazed part of pipes connected with 4-way valve.

PHOTOS

Photo 6

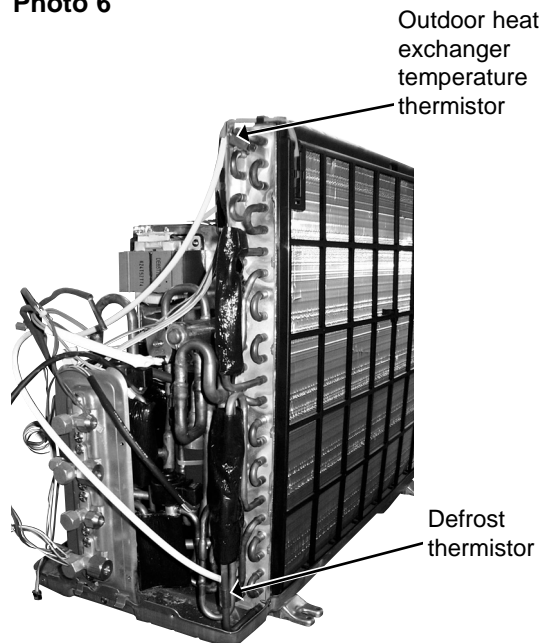

Photo 7

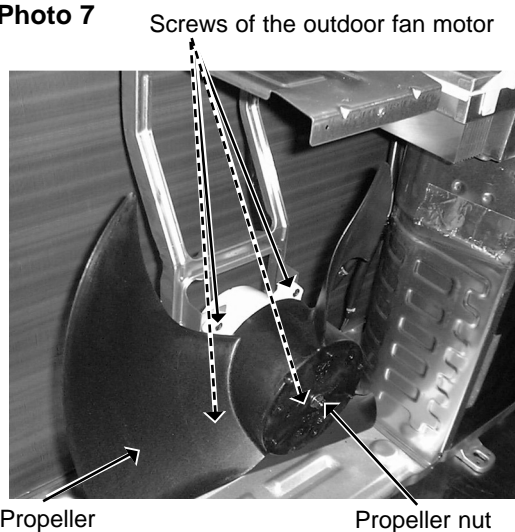
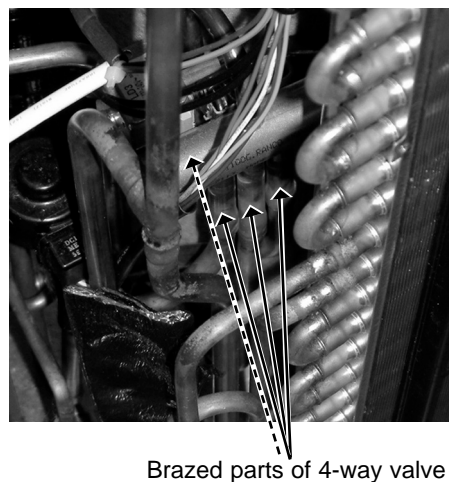
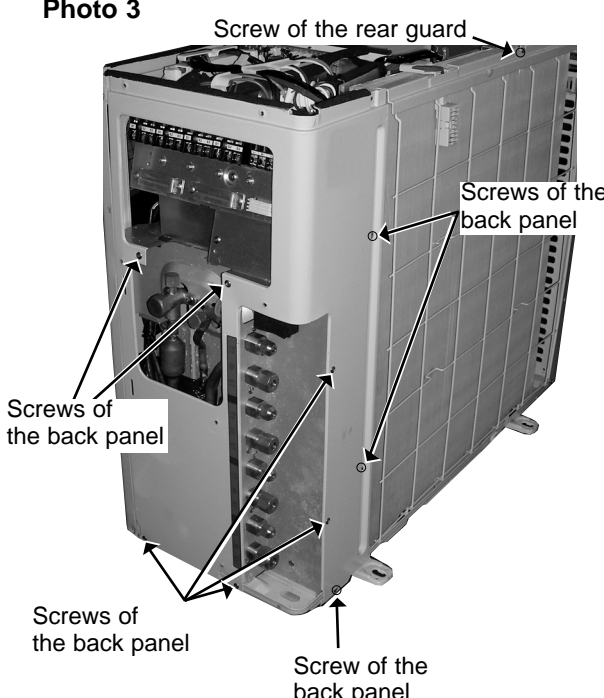
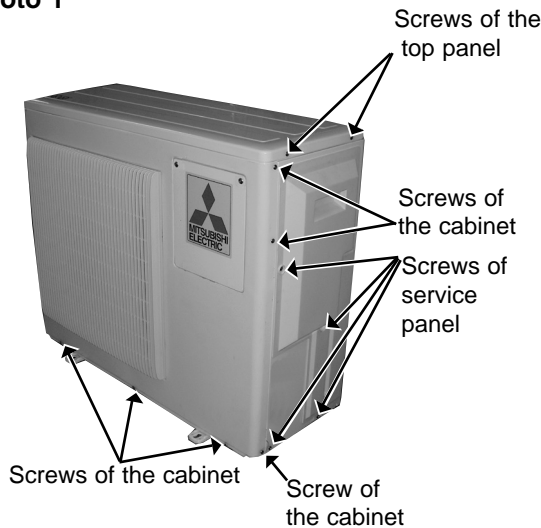
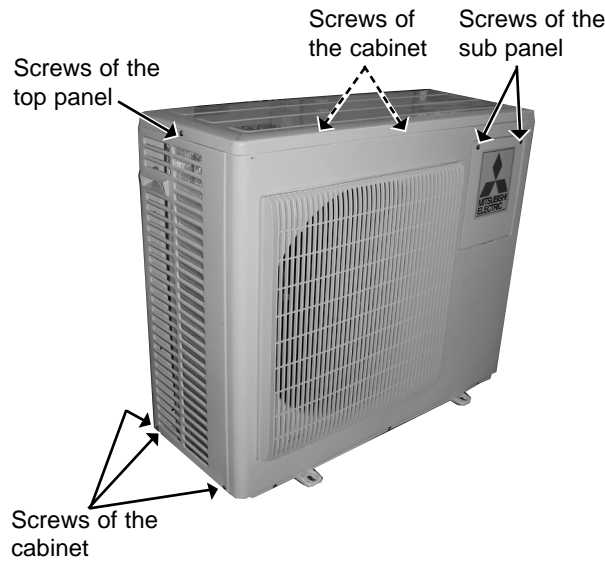

Photo 8



12-2. MXZ-3C54VA MXZ-3C68VA MXZ-4C71VA

NOTE: Turn OFF power supply before disassembly.

OPERATING PROCEDURE	PHOTOS
<p>1. Removing the cabinet</p> <p>(1) Remove the screws of the service panel, and remove the service panel.</p> <p>(2) Remove the screws of the top panel, and remove the top panel.</p> <p>(3) Remove the screws of the cabinet, and remove the cabinet.</p> <p>(4) Remove the screws of the back panel, and remove the back panel.</p> <p>Photo 3</p> 	<p>Photo 1</p>  <p>Photo 2</p> 

OPERATING PROCEDURE

2. Removing the electronic control P.C. board, power board and the noise filter P.C. board

- (1) Remove the screws of the top panel and the sub panel (Photo 1 and 2).
- (2) Remove the top panel and the sub panel (Photo 1 and 2).
- (3) Disconnect all connectors and lead wires on the electronic control P.C. board.
- (4) Remove the electronic control P.C. board.
- (5) Remove the screws fixing the power board.
- (6) Disconnect all connectors and lead wires on the power board.
- (7) Pull up the power P.C. board and remove it upward.
- (8) Disconnect all connectors and lead wires on the noise filter P.C. board.
- (9) Remove the noise filter P.C. board.

PHOTOS

Photo 4

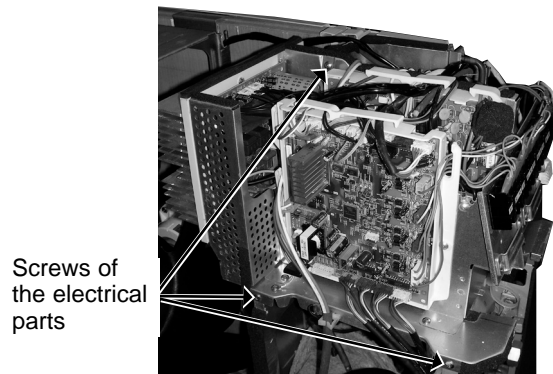

3. Removing the reactor

- (1) Remove the top panel (Photo 1).
- (2) Remove the service panel, cabinet, back panel, and the electrical parts (Photo 1, 2, 3, 4).
- (3) Disconnect the reactor lead wire from the terminal of the reactor.
- (4) Remove the screws of the reactor, and remove the reactor.

Photo 5

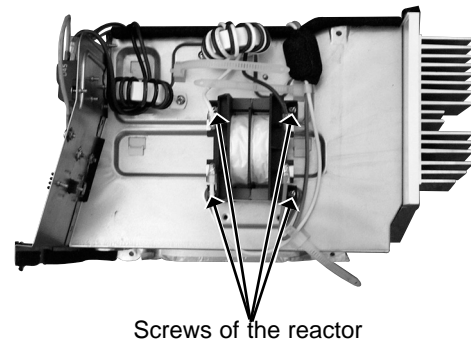

4. Removing the fan motor

- (1) Remove the top panel, the service panel, and the cabinet (Photo 1, 2).
- (2) Disconnect the connector CN931 and CN932 on the electronic control P.C. board.
- (3) Remove the propeller.
- (4) Remove the fan motor.

Photo 6

Screws of the outdoor fan motor

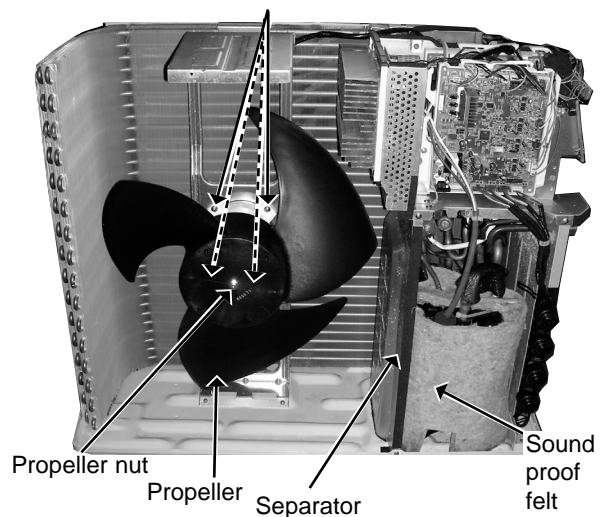

OPERATING PROCEDURE

5. Removing the compressor and the 4-way valve

- (1) Remove the top panel (Photo 1).
- (2) Remove the service panel, the cabinet, and the back panel (Photo 1, 2, 3).
- (3) Recover gas from the refrigerant circuit.

NOTE: Recover gas from the pipes until the pressure gauge shows 0 kg/cm² (0 MPa).

- (4) Disconnect the compressor lead wire from terminal of the compressor (U, V, W).
- (5) Disconnect the electronic control P.C. board connectors: CN661, CN663, CN681 (MXZ-3C68VA, MXZ-4C71VA), CN791, CN792, CN793, CN794 (MXZ-4C71VA), CN795, CN931, CN932
Disconnect the noise filter P.C. board connector: CN912
- (6) Remove the screws of the electrical parts, and remove the electrical parts (Photo 4).
- (7) Remove the propeller (Photo 6).
- (8) Remove the screws of the separator, and remove the separator (Photo 6).
- (9) Remove the sound proof felt (Photo 6).
- (10) Detach the brazed parts of the compressor suction and discharge pipes.
- (11) Remove the compressor nuts and remove the compressor.
- (12) Detach the brazed parts of 4-way valve and pipe.

6. Removing the expansion valve

- (1) Remove the top panel (Photo 1).
- (2) Remove the service panel, the cabinet, and the back panel (Photo 1, 2, 3).
(Gas recovery is not required if the unit is pumped down.)
- (3) Remove the electrical parts for removing LEV E (Photo 4, 7).
- (4) Remove the LEV coils.
- (5) Detach the brazed parts of expansion valves and pipes.

PHOTOS

Photo 7

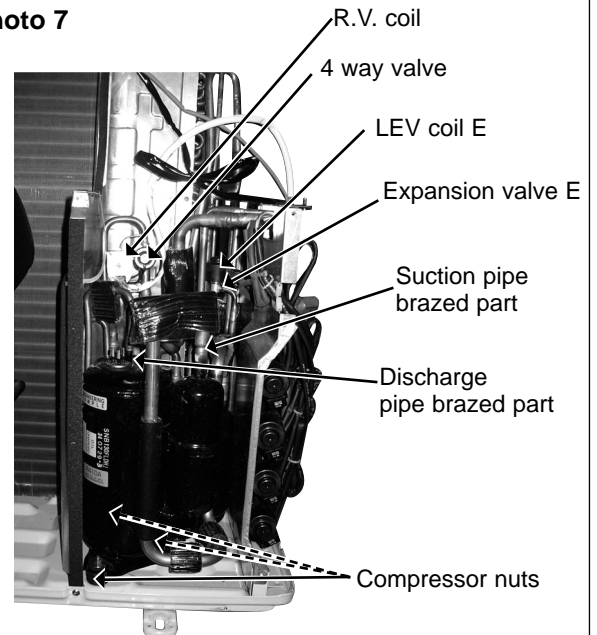

Photo 8

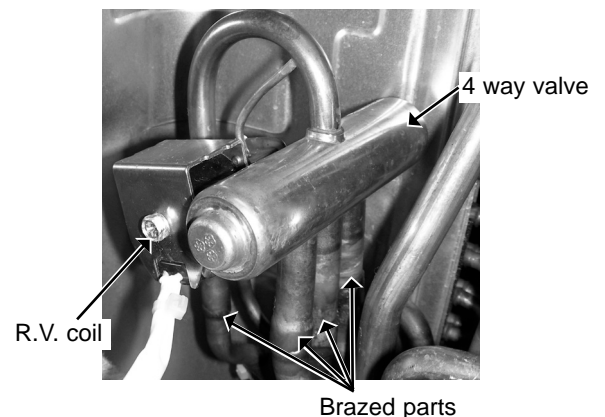
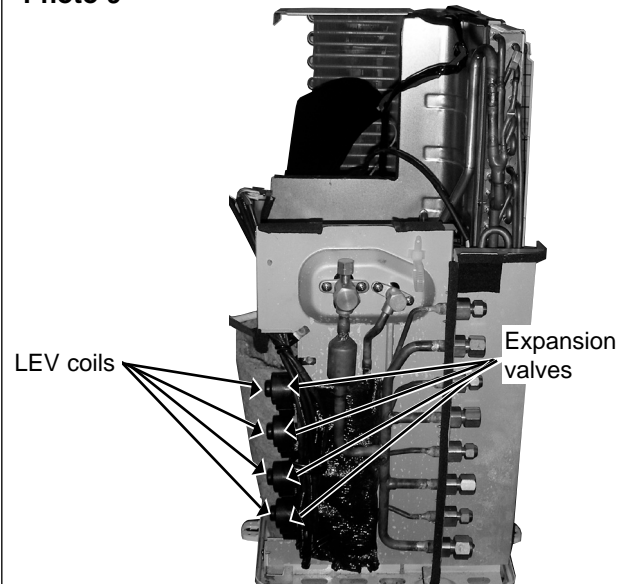

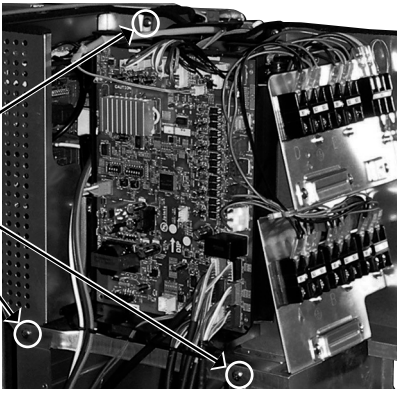

Photo 9



12-3. MXZ-4C80VA MXZ-4C80VA2 MXZ-5C100VA MXZ-5C100VA2

NOTE: Turn OFF power supply before disassembly.

OPERATING PROCEDURE	PHOTOS
<p>1. Removing the panels</p> <p>(1) Remove the screws of the service panel, and remove the service panel.</p> <p>(2) Remove the screws of the top panel, and remove the top panel.</p> <p>(3) Remove the screws of the front panel, and remove the front panel.</p> <p>(4) Remove the screws of the rear panel, and remove the rear panel.</p>	<p>Photo 1</p> <p>Screws of the top panel</p>  <p>Screws of the service panel</p> <p>Screws of the front panel</p> <p>Photo 2</p> <p>Screws of the top panel</p>  <p>Screws of the side panel</p> <p>Screws of the service panel</p> <p>Screws of the rear panel</p>
<p>2. Removing the electronic control P.C. board, power board and the noise filter P.C. board</p> <p>(1) Remove the screws of the top panel and the service panel (Photo 1 and 2).</p> <p>(2) Remove the top panel and the service panel (Photo 1 and 2).</p> <p>(3) Disconnect all connectors and lead wires on the electronic control P.C. board.</p> <p>(4) Remove the electronic control P.C. board.</p> <p>(5) Remove the screws fixing the power board.</p> <p>(6) Disconnect all connectors and lead wires on the power board.</p> <p>(7) Pull up the power P.C. board and remove it upward.</p> <p>(8) Disconnect all connectors and lead wires on the noise filter P.C. board.</p> <p>(9) Remove the noise filter P.C. board.</p>	<p>Photo 3</p>  <p>Screws of the electrical parts</p>

OPERATING PROCEDURE

3. Removing the reactor

- (1) Remove the top panel (Photo 1).
- (2) Disconnect the reactor lead wire.
- (3) Remove the screws of the reactor, and remove the reactor.

4. Removing the fan motor

- (1) Remove the top panel, the service panel, and the front panel (Photo 1).
- (2) Disconnect the connector CN931 and CN932 on the electronic control P.C. board.
- (3) Remove the propeller.
- (4) Remove the fan motor.

PHOTOS

Photo 4

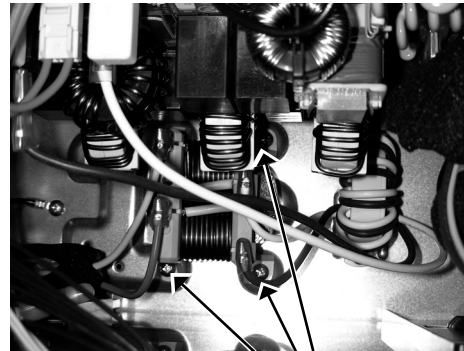

Screws of the reactor

Photo 5

Screws of the outdoor fan motor

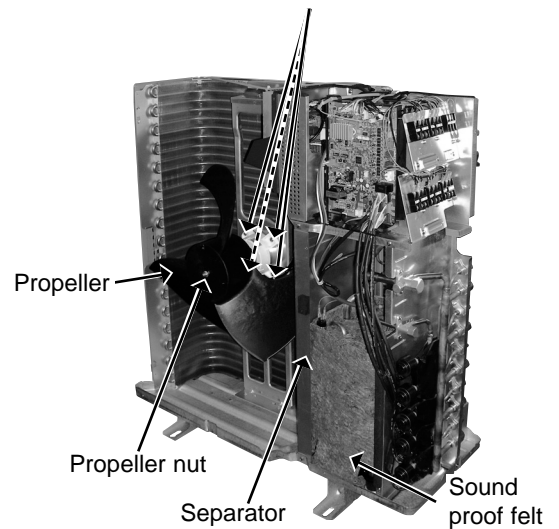

OPERATING PROCEDURE

5. Removing the compressor and the 4-way valve

- (1) Remove the top panel (Photo 1).
- (2) Remove the service panel, front panel, and rear panel.
- (3) Recover gas from the refrigerant circuit.
NOTE: Recover gas from the pipes until the pressure gauge shows 0 kg/cm² (0 MPa).
- (4) Disconnect the compressor lead wire from terminal of compressor (U, V, W).
- (5) Disconnect the electronic control P.C. board connectors: CN661, CN663, CN681, CN791, CN792, CN793, CN794, CN795 (**MXZ-5C100VA, MXZ-5C100VA2**), CN796, CN931, CN932
Disconnect the noise filter P.C. board connector: CN912
- (6) Remove the screws of the electrical parts, and remove the electrical parts.
- (7) Remove the propeller.
- (8) Remove the screws of the separator, and remove the separator.
- (9) Remove the sound proof felt.
- (10) Detach the brazed parts of the compressor suction and discharge pipes.
- (11) Remove the compressor nuts and remove the compressor.
- (12) Detach the brazed parts of 4-way valve and pipe.

6. Removing the expansion valve

- (1) Remove the top panel (Photo 1,2).
- (2) Remove the service panel (Photo 1).
(Gas recovery is not required if the unit is pumped down.)
- (3) Remove the front panel for removing LEV F (Photo 1).
- (4) Remove the electrical parts for removing LEV F (Photo 3).
- (5) Remove the LEV coils.
- (6) Detach the brazed parts of expansion valves and pipes.

PHOTOS

Photo 6

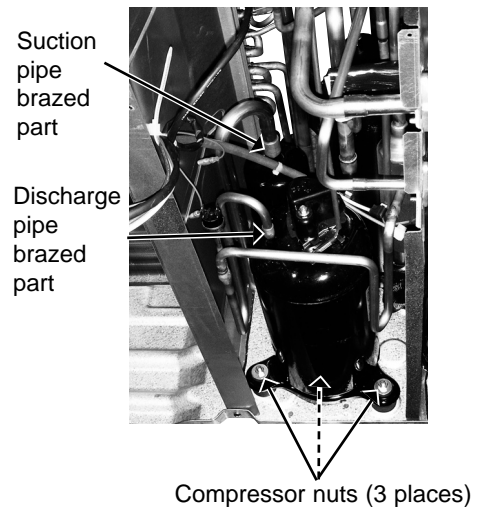

Photo 7

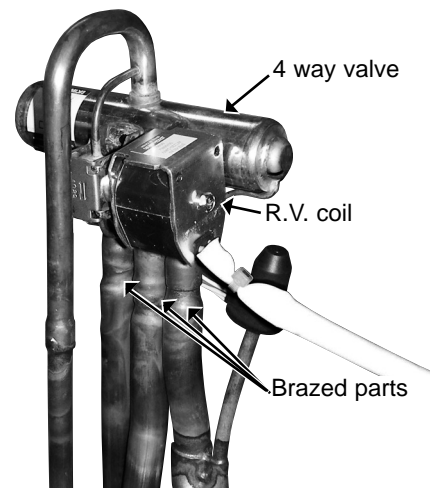
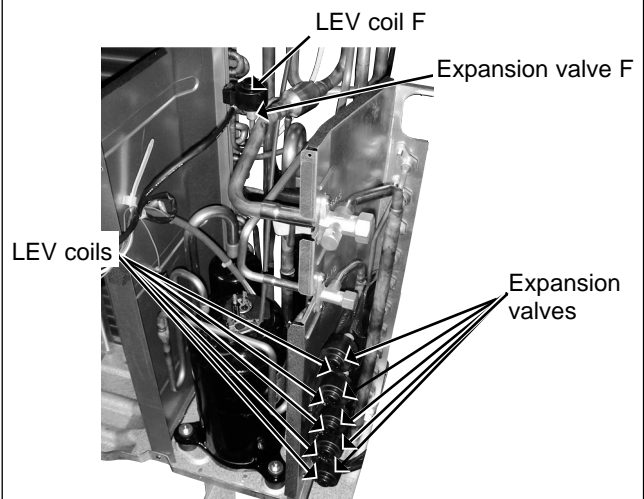

Photo 8



12-4. MXZ-6C120VA MXZ-6C122VA

NOTE: Turn OFF power supply before disassembly.

OPERATING PROCEDURE

1. Removing the panels

- (1) Remove the screws of the service panel, and remove the service panel.
- (2) Remove the screws of the top panel, and remove the top panel.
- (3) Remove the screws of the front panel, and remove the front panel.
- (4) Remove the screws of the back panel, and remove the back panel.

PHOTOS

Photo 1

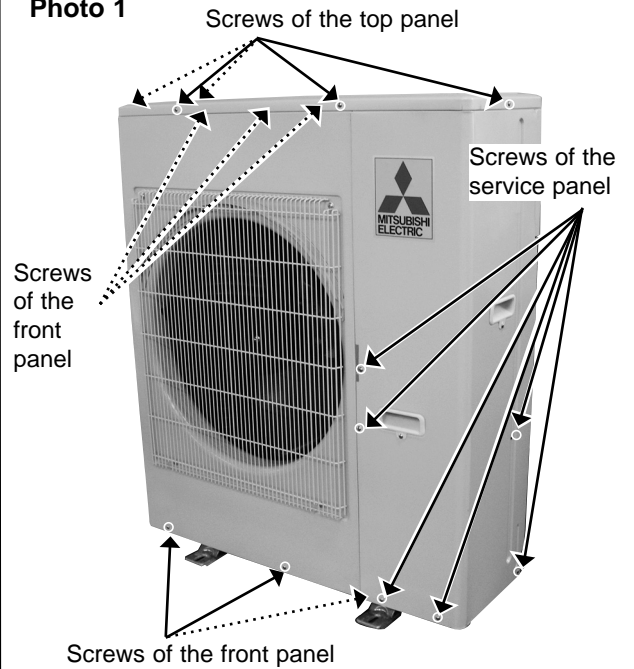

Photo 2



OPERATING PROCEDURE

2. Removing the control P.C. board/outdoor control P.C. board, the reactor and the power board/outdoor power P.C. board

- (1) Remove the service panel and the top panel (Photo 1).
- (2) Disconnect the connectors on the control P.C. board (MXZ-6C120VA)/outdoor control P.C. board (MXZ-6C122VA). Remove the screws of the the control P.C. board (MXZ-6C120VA)/outdoor control P.C. board (MXZ-6C122VA), and remove the control P.C. board (MXZ-6C120VA)/outdoor control P.C. board (MXZ-6C122VA).
- (3) Remove the screws of the reactor cover, and remove the reactor cover.
- (4) Remove the screws of the reactor, and remove the reactor.
- (5) Remove the screws of the power board (MXZ-6C120VA)/ outdoor power P.C. board (MXZ-6C122VA), and remove the power board (MXZ-6C120VA)/outdoor power P.C. board (MXZ-6C122VA).

Photo 6

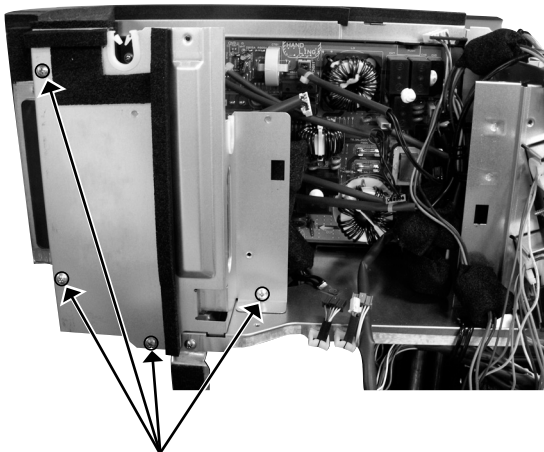

Screws of the reactor cover

Photo 7

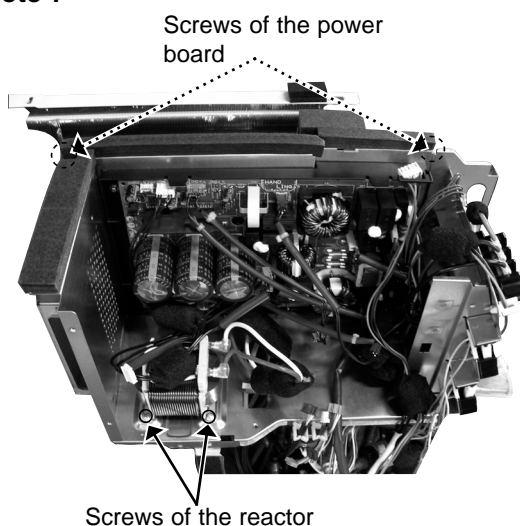

Screws of the power board

Screws of the reactor

PHOTOS

Photo 3

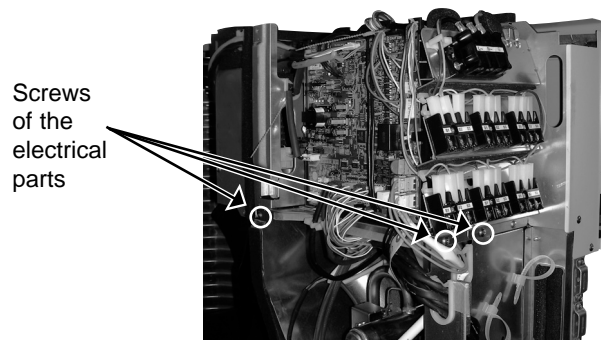

Screws of the electrical parts

Photo 4

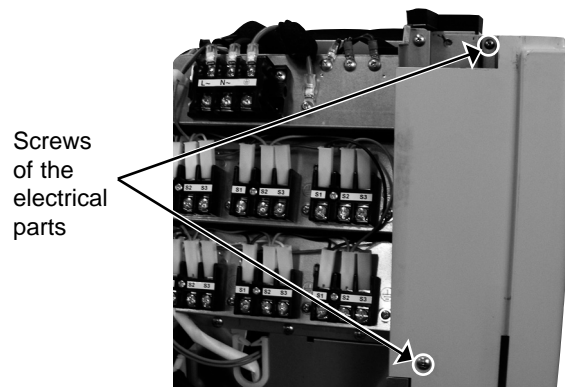

Screws of the electrical parts

Photo 5

Screws of the control P.C. board (MXZ-6C120VA)/outdoor control P.C. board (MXZ-6C122VA)

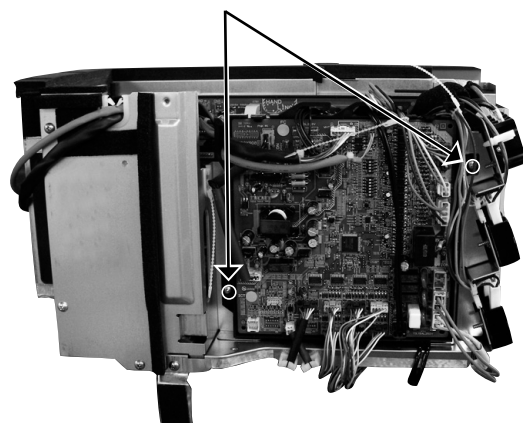

OPERATING PROCEDURE

3. Removing the fan motor

- (1) Remove the top panel, the service panel, and the front panel (Photo 1).
- (2) Disconnect the connector CN931 on the control P.C. board (**MXZ-6C120VA**)/outdoor control P.C. board (**MXZ-6C122VA**).
- (3) Remove the propeller.
- (4) Remove the fan motor.

PHOTOS

Photo 8

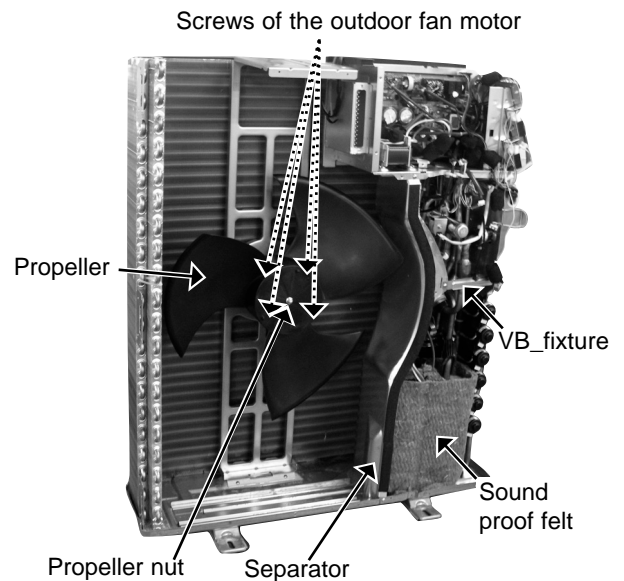

4. Removing the compressor and the 4-way valve

- (1) Remove the top panel (Photo 1).
- (2) Remove the service panel, front panel, and back panel. (Photo 1, 2).
- (3) Recover gas from the refrigerant circuit.
NOTE: Recover gas from the pipes until the pressure gauge shows 0 kg/cm² (0 MPa).
- (6) Disconnect the compressor lead wire from terminal of compressor (U, V, W).
- (7) Disconnect the control P.C. board (**MXZ-6C120VA**)/outdoor control P.C. board (**MXZ-6C122VA**) connectors: CN661, CN663, CN681, CN712, CN713, CN791, CN792, CN793, CN794, CN795, CN796, CN797, CN931
- (8) Remove the screws of the electrical parts, and remove the electrical parts (Photo 3, 4).
- (9) Remove the propeller (Photo 8).
- (10) Remove the VB_fixture (Photo 8).
- (11) Remove the screws of the separator, and remove the separator (Photo 8).
- (12) Remove the sound proof felt (Photo 8).
- (13) Detach the brazed parts of the compressor suction and discharge pipes (Photo 10).
- (14) Remove the compressor nuts and remove the compressor (Photo 10).
- (5) Detach the brazed parts of 4-way valve and pipe.

Photo 9

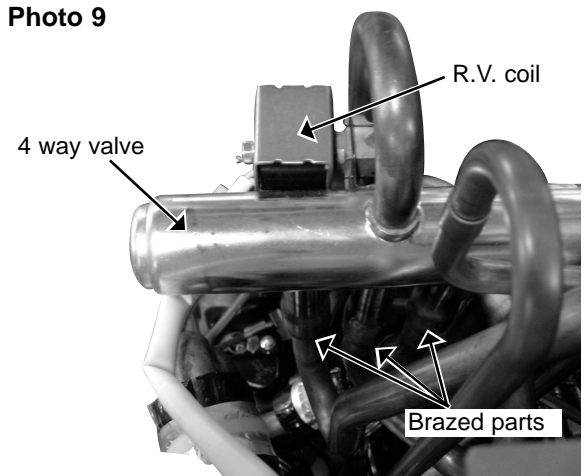

OPERATING PROCEDURE

5. Removing the expansion valve

- (1) Remove the top panel (Photo 1).
- (2) Remove the service panel (Photo 1).
(Gas recovery is not required if the unit is pumped down.)
- (3) Remove the front panel for removing LEV M (Photo 1).
- (4) Remove the electrical parts for removing LEV M (Photo 3, 4).
- (5) Remove the LEV coils.
- (6) Detach the brazed parts of expansion valves and pipes.

PHOTOS

Photo 10

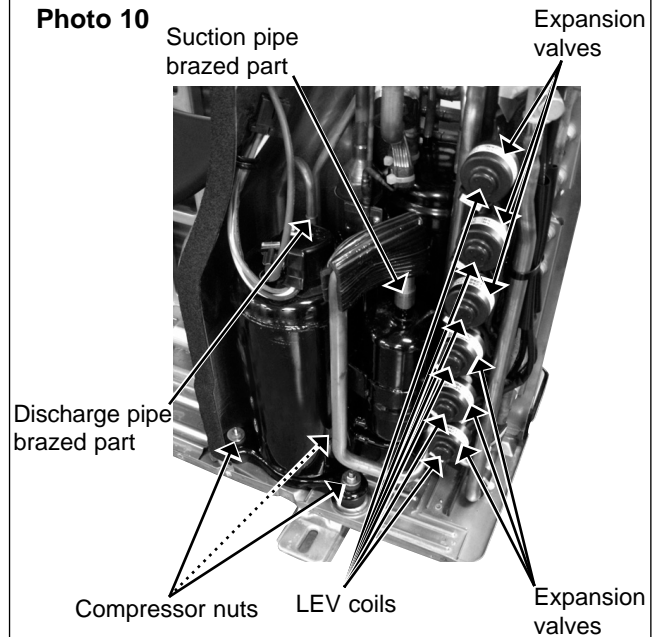
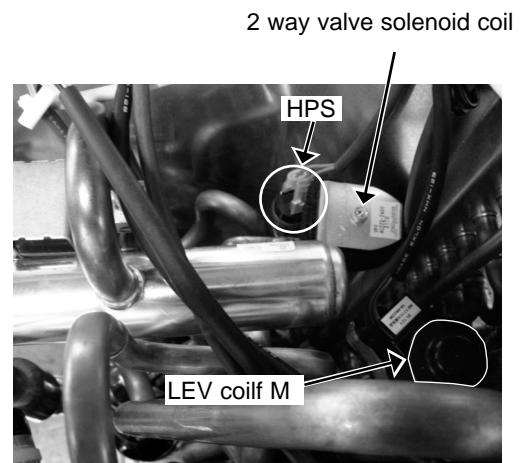

Photo 11



MITSUBISHI ELECTRIC CORPORATION

HEAD OFFICE: TOKYO BLDG., 2-7-3, MARUNOUCHI, CHIYODA-KU, TOKYO 100-8310, JAPAN

© Copyright 2010 MITSUBISHI ELECTRIC CORPORATION
Distributed in Jan. 2013. No.OBH584 REVISED EDITION-E
Distributed in Dec. 2012. No.OBH584 REVISED EDITION-D
Distributed in Jul. 2012. No.OBH584 REVISED EDITION-C
Distributed in Jun. 2012. No.OBH584 REVISED EDITION-B
Distributed in Apr. 2011. No.OBH584 REVISED EDITION-A
Distributed in Oct. 2010. No.OBH584
Made in Japan

New publication, effective Jan. 2013
Specifications are subject to change without notice.

MXZ-2C30VA COOLING

Indoor units combination	Cooling capacity (kW)			Outdoor unit power consumption(kW)	Current (A)	Power factor(%)
	Unit A	Unit B	Total			
15	1.50	-	1.50 (0.90 - 2.40)	0.330 (0.140 - 0.670)	1.59	90
20	2.00	-	2.00 (0.90 - 2.60)	0.440 (0.140 - 0.720)	2.13	90
22	2.20	-	2.20 (0.90 - 3.00)	0.410 (0.120 - 0.620)	1.98	90
25	2.50	-	2.50 (0.90 - 3.30)	0.490 (0.120 - 0.690)	2.37	90
15+15	1.20	1.20	2.40 (1.10 - 3.80)	0.540 (0.300 - 1.100)	2.61	90
15+20	1.07	1.43	2.50 (1.10 - 3.80)	0.610 (0.300 - 1.100)	2.95	90
15+22	1.01	1.49	2.50 (1.10 - 3.80)	0.520 (0.280 - 1.040)	2.51	90
15+25	0.98	1.63	2.60 (1.10 - 3.80)	0.670 (0.300 - 1.100)	3.24	90
20+20	1.30	1.30	2.60 (1.10 - 3.80)	0.670 (0.300 - 1.100)	3.24	90
20+22	1.29	1.41	2.70 (1.10 - 3.80)	0.590 (0.280 - 1.040)	2.85	90
20+25	1.24	1.56	2.80 (1.10 - 3.80)	0.620 (0.280 - 1.040)	3.00	90
22+22	1.40	1.40	2.80 (1.10 - 3.80)	0.500 (0.250 - 0.970)	2.42	90
22+25	1.36	1.54	2.90 (1.10 - 3.90)	0.530 (0.250 - 1.010)	2.56	90
25+25	1.50	1.50	3.00 (1.10 - 4.00)	0.560 (0.250 - 1.040)	2.71	90

MXZ-2C30VA HEATING

Indoor units combination	Heating capacity (kW)			Outdoor unit power consumption(kW)	Current (A)	Power factor(%)
	Unit A	Unit B	Total			
15	1.70	-	1.70 (0.90 - 3.10)	0.350 (0.140 - 0.820)	1.69	90
20	2.20	-	2.20 (0.90 - 3.10)	0.470 (0.140 - 0.850)	2.27	90
22	3.30	-	3.30 (0.90 - 4.00)	0.670 (0.110 - 1.100)	3.24	90
25	3.60	-	3.60 (0.90 - 4.40)	0.730 (0.110 - 1.250)	3.53	90
15+15	1.50	1.50	3.00 (1.00 - 3.90)	0.640 (0.250 - 0.990)	3.09	90
15+20	1.41	1.89	3.30 (1.00 - 3.90)	0.770 (0.250 - 1.010)	3.72	90
15+22	1.38	2.02	3.40 (1.00 - 4.10)	0.710 (0.230 - 0.980)	3.43	90
15+25	1.35	2.25	3.60 (1.00 - 3.90)	0.890 (0.250 - 1.020)	4.30	90
20+20	1.80	1.80	3.60 (1.00 - 3.90)	0.890 (0.250 - 1.020)	4.30	90
20+22	1.76	1.94	3.70 (1.00 - 4.10)	0.830 (0.230 - 1.000)	4.01	90
20+25	1.73	2.17	3.90 (1.00 - 4.10)	0.860 (0.230 - 1.020)	4.15	90
22+22	1.90	1.90	3.80 (1.00 - 4.30)	0.770 (0.200 - 0.970)	3.72	90
22+25	1.83	2.07	3.90 (1.00 - 4.30)	0.800 (0.200 - 0.990)	3.86	90
25+25	2.00	2.00	4.00 (1.00 - 4.40)	0.815 (0.200 - 1.010)	3.94	90

MXZ-2C40VA COOLING

Indoor units combination	Cooling capacity (kW)			Outdoor unit power consumption(kW)	Current (A)	Power factor(%)
	Unit A	Unit B	Total			
15	1.50	-	1.50 (0.90 - 2.70)	0.330 (0.260 - 0.890)	1.59	90
20	2.00	-	2.00 (0.90 - 2.70)	0.500 (0.260 - 0.890)	2.42	90
22	2.20	-	2.20 (0.90 - 3.00)	0.430 (0.120 - 0.620)	2.08	90
25	2.50	-	2.50 (0.90 - 3.30)	0.490 (0.120 - 0.690)	2.37	90
35	3.50	-	3.50 (0.90 - 4.00)	0.730 (0.120 - 0.900)	3.53	90
15+15	1.40	1.40	2.80 (1.10 - 4.30)	0.630 (0.450 - 1.350)	2.88	95
15+20	1.33	1.77	3.10 (1.10 - 4.30)	0.750 (0.450 - 1.350)	3.43	95
15+22	1.34	1.96	3.30 (1.10 - 4.30)	0.770 (0.350 - 1.230)	3.52	95
15+25	1.28	2.13	3.40 (1.10 - 4.30)	0.950 (0.550 - 1.470)	4.35	95
15+35	1.17	2.73	3.90 (1.10 - 4.40)	0.930 (0.350 - 1.250)	4.26	95
20+20	1.70	1.70	3.40 (1.10 - 4.30)	0.880 (0.450 - 1.350)	4.03	95
20+22	1.71	1.89	3.60 (1.10 - 4.30)	0.850 (0.350 - 1.230)	3.89	95
20+25	1.69	2.11	3.80 (1.10 - 4.30)	0.890 (0.350 - 1.230)	4.07	95
20+35	1.42	2.48	3.90 (1.10 - 4.40)	0.930 (0.350 - 1.250)	4.26	95
22+22	1.90	1.90	3.80 (1.10 - 4.30)	0.820 (0.250 - 1.110)	3.75	95
22+25	1.83	2.07	3.90 (1.10 - 4.40)	0.860 (0.250 - 1.130)	3.94	95
22+35	1.51	2.39	3.90 (1.10 - 4.40)	0.860 (0.250 - 1.130)	3.94	95
25+25	1.95	1.95	3.90 (1.10 - 4.40)	0.860 (0.250 - 1.130)	3.94	95
25+35	1.67	2.33	4.00 (1.10 - 4.50)	0.875 (0.250 - 1.170)	4.00	95

MXZ-2C40VA HEATING

Indoor units combination	Heating capacity (kW)			Outdoor unit power consumption(kW)	Current (A)	Power factor(%)
	Unit A	Unit B	Total			
15	1.70	-	1.70 (0.90 - 3.10)	0.380 (0.230 - 1.080)	1.84	90
20	2.20	-	2.20 (0.90 - 3.10)	0.550 (0.230 - 1.080)	2.66	90
22	3.30	-	3.30 (0.90 - 4.00)	0.670 (0.110 - 0.910)	3.24	90
25	3.60	-	3.60 (0.90 - 4.50)	0.730 (0.110 - 1.050)	3.53	90
35	4.00	-	4.00 (0.90 - 4.80)	0.870 (0.110 - 1.150)	4.20	90
15+15	1.60	1.60	3.20 (1.00 - 4.80)	0.670 (0.360 - 1.300)	3.07	95
15+20	1.54	2.06	3.60 (1.00 - 4.80)	0.830 (0.360 - 1.270)	3.80	95
15+22	1.54	2.26	3.80 (1.00 - 4.80)	0.810 (0.280 - 1.150)	3.71	95
15+25	1.50	2.50	4.00 (1.00 - 4.80)	0.970 (0.440 - 1.400)	4.44	95
15+35	1.32	3.08	4.40 (1.00 - 4.90)	0.920 (0.280 - 1.170)	4.21	95
20+20	2.00	2.00	4.00 (1.00 - 4.80)	0.910 (0.360 - 1.260)	4.16	95
20+22	2.00	2.20	4.20 (1.00 - 4.80)	0.890 (0.280 - 1.130)	4.07	95
20+25	1.96	2.44	4.40 (1.00 - 4.80)	0.920 (0.280 - 1.130)	4.21	95
20+35	1.60	2.80	4.40 (1.00 - 4.90)	0.920 (0.280 - 1.150)	4.21	95
22+22	2.20	2.20	4.40 (1.00 - 4.80)	0.860 (0.200 - 1.010)	3.94	95
22+25	2.06	2.34	4.40 (1.00 - 4.80)	0.860 (0.200 - 1.010)	3.94	95
22+35	1.70	2.70	4.40 (1.00 - 4.90)	0.860 (0.200 - 1.030)	3.94	95
25+25	2.20	2.20	4.40 (1.00 - 4.90)	0.860 (0.200 - 1.030)	3.94	95
25+35	1.88	2.63	4.50 (1.00 - 5.00)	0.870 (0.200 - 1.050)	3.98	95

MXZ-3C68VA COOLING

Indoor units combination	Cooling capacity (kW)				Outdoor unit power consumption (kW)	Current (A)	Power factor (%)
	Unit A	Unit B	Unit C	Total			
15+42+42	1.03	2.88	2.88	6.80 (2.9 - 8.4)	1.530 (0.700 - 2.430)	6.72	99
15+42+50	0.95	2.67	3.18	6.80 (2.9 - 8.4)	1.460 (0.700 - 2.420)	6.41	99
15+42+60	0.87	2.44	3.49	6.80 (2.9 - 8.4)	1.430 (0.700 - 2.410)	6.28	99
15+50+50	0.89	2.96	2.96	6.80 (2.9 - 8.4)	1.450 (0.700 - 2.410)	6.37	99
20+20+20	2.00	2.00	2.00	6.00 (2.9 - 7.4)	1.520 (0.780 - 2.320)	6.68	99
20+20+22	2.00	2.00	2.20	6.20 (2.9 - 7.6)	1.610 (0.730 - 2.420)	7.07	99
20+20+25	2.00	2.00	2.50	6.50 (2.9 - 8.0)	1.620 (0.730 - 2.460)	7.11	99
20+20+35	1.81	1.81	3.17	6.80 (2.9 - 8.4)	1.855 (0.730 - 2.500)	8.15	99
20+20+42	1.66	1.66	3.48	6.80 (2.9 - 8.4)	1.760 (0.730 - 2.490)	7.73	99
20+20+50	1.51	1.51	3.78	6.80 (2.9 - 8.4)	1.670 (0.730 - 2.480)	7.33	99
20+20+60	1.36	1.36	4.08	6.80 (2.9 - 8.4)	1.540 (0.730 - 2.460)	6.76	99
20+22+22	2.00	2.20	2.20	6.40 (2.9 - 7.9)	1.570 (0.700 - 2.410)	6.90	99
20+22+25	1.97	2.17	2.46	6.60 (2.9 - 8.1)	1.580 (0.700 - 2.430)	6.94	99
20+22+35	1.77	1.94	3.09	6.80 (2.9 - 8.4)	1.790 (0.700 - 2.460)	7.86	99
20+22+42	1.62	1.78	3.40	6.80 (2.9 - 8.4)	1.700 (0.700 - 2.450)	7.47	99
20+22+50	1.48	1.63	3.70	6.80 (2.9 - 8.4)	1.610 (0.700 - 2.430)	7.07	99
20+22+60	1.33	1.47	4.00	6.80 (2.9 - 8.4)	1.480 (0.700 - 2.420)	6.50	99
20+25+25	1.91	2.39	2.39	6.70 (2.9 - 8.2)	1.700 (0.700 - 2.440)	7.47	99
20+25+35	1.70	2.13	2.98	6.80 (2.9 - 8.4)	1.760 (0.700 - 2.460)	7.73	99
20+25+42	1.56	1.95	3.28	6.80 (2.9 - 8.4)	1.670 (0.700 - 2.450)	7.33	99
20+25+50	1.43	1.79	3.58	6.80 (2.9 - 8.4)	1.580 (0.700 - 2.430)	6.94	99
20+25+60	1.30	1.62	3.89	6.80 (2.9 - 8.4)	1.450 (0.700 - 2.420)	6.37	99
20+35+35	1.51	2.64	2.64	6.80 (2.9 - 8.4)	1.660 (0.700 - 2.460)	7.29	99
20+35+42	1.40	2.45	2.94	6.80 (2.9 - 8.4)	1.570 (0.700 - 2.440)	6.90	99
20+35+50	1.30	2.27	3.24	6.80 (2.9 - 8.4)	1.480 (0.700 - 2.430)	6.50	99
20+35+60	1.18	2.07	3.55	6.80 (2.9 - 8.4)	1.450 (0.700 - 2.420)	6.37	99
20+42+42	1.31	2.75	2.75	6.80 (2.9 - 8.4)	1.480 (0.700 - 2.430)	6.50	99
20+42+50	1.21	2.55	3.04	6.80 (2.9 - 8.4)	1.460 (0.700 - 2.420)	6.41	99
20+50+50	1.13	2.83	2.83	6.80 (2.9 - 8.4)	1.450 (0.700 - 2.410)	6.37	99
22+22+22	2.20	2.20	2.20	6.60 (2.9 - 8.1)	1.540 (0.670 - 2.390)	6.76	99
22+22+25	2.14	2.14	2.43	6.70 (2.9 - 8.2)	1.660 (0.670 - 2.400)	7.29	99
22+22+35	1.89	1.89	3.01	6.80 (2.9 - 8.4)	1.730 (0.670 - 2.420)	7.60	99
22+22+42	1.74	1.74	3.32	6.80 (2.9 - 8.4)	1.640 (0.670 - 2.410)	7.20	99
22+22+50	1.59	1.59	3.62	6.80 (2.9 - 8.4)	1.550 (0.670 - 2.390)	6.81	99
22+22+60	1.44	1.44	3.92	6.80 (2.9 - 8.4)	1.420 (0.670 - 2.380)	6.24	99
22+25+25	2.05	2.33	2.33	6.70 (2.9 - 8.3)	1.660 (0.670 - 2.410)	7.29	99
22+25+35	1.82	2.07	2.90	6.80 (2.9 - 8.4)	1.700 (0.670 - 2.420)	7.47	99

MXZ-3C68VA COOLING

Indoor units combination	Cooling capacity (kW)				Outdoor unit power consumption(kW)	Current (A)	Power factor (%)
	Unit A	Unit B	Unit C	Total			
22+25+42	1.68	1.91	3.21	6.80 (2.9 - 8.4)	1.610 (0.670 - 2.410)	7.07	99
22+25+50	1.54	1.75	3.51	6.80 (2.9 - 8.4)	1.520 (0.670 - 2.390)	6.68	99
22+25+60	1.40	1.59	3.81	6.80 (2.9 - 8.4)	1.410 (0.670 - 2.380)	6.19	99
22+35+35	1.63	2.59	2.59	6.80 (2.9 - 8.4)	1.600 (0.670 - 2.410)	7.03	99
22+35+42	1.51	2.40	2.88	6.80 (2.9 - 8.4)	1.510 (0.670 - 2.400)	6.63	99
22+35+50	1.40	2.22	3.18	6.80 (2.9 - 8.4)	1.440 (0.670 - 2.390)	6.32	99
22+35+60	1.28	2.03	3.49	6.80 (2.9 - 8.4)	1.410 (0.670 - 2.380)	6.19	99
22+42+42	1.41	2.69	2.69	6.80 (2.9 - 8.4)	1.430 (0.670 - 2.390)	6.28	99
22+42+50	1.31	2.51	2.98	6.80 (2.9 - 8.4)	1.420 (0.670 - 2.380)	6.24	99
25+25+25	2.27	2.27	2.27	6.80 (2.9 - 8.4)	1.775 (0.670 - 2.420)	7.80	99
25+25+35	2.00	2.00	2.80	6.80 (2.9 - 8.4)	1.670 (0.670 - 2.420)	7.33	99
25+25+42	1.85	1.85	3.10	6.80 (2.9 - 8.4)	1.580 (0.670 - 2.400)	6.94	99
25+25+50	1.70	1.70	3.40	6.80 (2.9 - 8.4)	1.490 (0.670 - 2.390)	6.54	99
25+25+60	1.55	1.55	3.71	6.80 (2.9 - 8.4)	1.410 (0.670 - 2.380)	6.19	99
25+35+35	1.79	2.51	2.51	6.80 (2.9 - 8.4)	1.570 (0.670 - 2.410)	6.90	99
25+35+42	1.67	2.33	2.80	6.80 (2.9 - 8.4)	1.480 (0.670 - 2.400)	6.50	99
25+35+50	1.55	2.16	3.09	6.80 (2.9 - 8.4)	1.440 (0.670 - 2.390)	6.32	99
25+35+60	1.42	1.98	3.40	6.80 (2.9 - 8.4)	1.410 (0.670 - 2.380)	6.19	99
25+42+42	1.56	2.62	2.62	6.80 (2.9 - 8.4)	1.430 (0.670 - 2.390)	6.28	99
25+42+50	1.45	2.44	2.91	6.80 (2.9 - 8.4)	1.420 (0.670 - 2.380)	6.24	99
35+35+35	2.27	2.27	2.27	6.80 (2.9 - 8.4)	1.470 (0.670 - 2.410)	6.46	99
35+35+42	2.13	2.13	2.55	6.80 (2.9 - 8.4)	1.450 (0.670 - 2.400)	6.37	99
35+35+50	1.98	1.98	2.83	6.80 (2.9 - 8.4)	1.440 (0.670 - 2.390)	6.32	99
35+42+42	2.00	2.40	2.40	6.80 (2.9 - 8.4)	1.430 (0.670 - 2.390)	6.28	99

MXZ-3C68VA HEATING

Indoor units combination	Heating capacity (kW)				Outdoor unit power consumption(kW)	Current (A)	Power factor (%)
	Unit A	Unit B	Unit C	Total			
15	1.70			1.70 (1.2 - 3.0)	0.500 (0.400 - 0.950)	2.20	99
20	2.20			2.20 (1.2 - 3.9)	0.610 (0.390 - 1.330)	2.68	99
22	3.30			3.30 (1.2 - 4.2)	0.760 (0.380 - 1.090)	3.34	99
25	3.60			3.60 (1.2 - 4.5)	0.860 (0.380 - 1.190)	3.78	99
35	4.00			4.00 (1.2 - 4.8)	1.000 (0.380 - 1.300)	4.39	99
42	5.40			5.40 (1.3 - 6.5)	1.460 (0.370 - 1.800)	6.41	99
50	7.20			7.20 (1.4 - 8.2)	1.880 (0.370 - 2.300)	8.26	99
60	7.90			7.90 (1.4 - 8.6)	2.120 (0.360 - 2.410)	9.31	99
15+15	1.70	1.70		3.40 (1.8 - 5.0)	0.850 (0.670 - 1.310)	3.73	99
15+20	1.67	2.23		3.90 (1.8 - 5.8)	1.020 (0.680 - 1.630)	4.48	99
15+22	1.66	2.44		4.10 (1.8 - 6.1)	1.080 (0.550 - 1.760)	4.74	99
15+25	1.65	2.75		4.40 (1.8 - 6.6)	1.180 (0.800 - 1.950)	5.18	99
15+35	2.16	5.04		7.20 (1.8 - 9.0)	1.680 (0.550 - 2.170)	7.38	99
15+42	2.03	5.67		7.70 (1.8 - 9.0)	1.780 (0.550 - 2.170)	7.82	99
15+50	1.92	6.38		8.30 (1.8 - 9.0)	1.910 (0.550 - 2.170)	8.39	99
15+60	1.72	6.88		8.60 (1.8 - 9.0)	2.050 (0.550 - 2.150)	9.00	99
20+20	2.20	2.20		4.40 (1.8 - 6.6)	1.180 (0.660 - 1.950)	5.18	99
20+22	2.62	2.88		5.50 (1.8 - 6.9)	1.330 (0.540 - 1.830)	5.84	99
20+25	2.98	3.72		6.70 (1.8 - 7.5)	1.510 (0.540 - 1.790)	6.63	99
20+35	2.76	4.84		7.60 (1.8 - 9.0)	1.770 (0.540 - 2.170)	7.77	99
20+42	2.58	5.42		8.00 (1.8 - 9.0)	1.870 (0.540 - 2.170)	8.21	99
20+50	2.46	6.14		8.60 (1.8 - 9.0)	2.000 (0.540 - 2.170)	8.78	99
20+60	2.15	6.45		8.60 (1.8 - 9.0)	2.070 (0.540 - 2.130)	9.09	99
22+22	3.30	3.30		6.60 (1.8 - 7.2)	1.470 (0.410 - 1.710)	6.46	99
22+25	3.23	3.67		6.90 (1.8 - 8.1)	1.580 (0.410 - 1.940)	6.94	99
22+35	2.97	4.73		7.70 (1.8 - 9.0)	1.800 (0.410 - 2.170)	7.91	99
22+42	2.82	5.38		8.20 (1.8 - 9.0)	1.910 (0.410 - 2.170)	8.39	99
22+50	2.63	5.97		8.60 (1.8 - 9.0)	2.010 (0.410 - 2.160)	8.83	99
22+60	2.31	6.29		8.60 (1.8 - 9.0)	2.080 (0.410 - 2.120)	9.13	99
25+25	3.60	3.60		7.20 (1.8 - 9.0)	1.680 (0.410 - 2.170)	7.38	99
25+35	3.29	4.61		7.90 (1.8 - 9.0)	1.860 (0.410 - 2.170)	8.17	99
25+42	3.13	5.27		8.40 (1.8 - 9.0)	1.960 (0.410 - 2.170)	8.61	99
25+50	2.87	5.73		8.60 (1.8 - 9.0)	2.020 (0.410 - 2.150)	8.87	99
25+60	2.53	6.07		8.60 (1.8 - 9.0)	2.070 (0.400 - 2.110)	9.09	99
35+35	4.30	4.30		8.60 (1.8 - 9.0)	2.030 (0.410 - 2.170)	8.92	99
35+42	3.91	4.69		8.60 (1.8 - 9.0)	2.040 (0.410 - 2.140)	8.96	99
35+50	3.54	5.06		8.60 (1.8 - 9.0)	2.040 (0.400 - 2.110)	8.96	99

MXZ-3C68VA HEATING

Indoor units combination	Heating capacity (kW)				Outdoor unit power consumption (kW)	Current (A)	Power factor (%)
	Unit A	Unit B	Unit C	Total			
35+60	3.17	5.43		8.60 (1.8 - 9.0)	1.900 (0.370 - 2.060)	8.34	99
42+42	4.30	4.30		8.60 (1.8 - 9.0)	2.090 (0.400 - 2.110)	9.18	99
42+50	3.93	4.67		8.60 (1.8 - 9.0)	1.910 (0.380 - 2.080)	8.39	99
42+60	3.54	5.06		8.60 (1.9 - 9.0)	1.780 (0.360 - 2.030)	7.82	99
50+50	4.30	4.30		8.60 (1.9 - 9.0)	1.820 (0.360 - 2.040)	7.99	99
50+60	3.91	4.69		8.60 (1.9 - 9.0)	1.780 (0.360 - 1.970)	7.82	99
60+60	4.30	4.30		8.60 (1.9 - 9.0)	1.800 (0.360 - 1.900)	7.91	99
15+15+15	1.70	1.70	1.70	5.10 (2.6 - 8.4)	1.110 (0.900 - 2.410)	4.87	99
15+15+20	1.68	1.68	2.24	5.60 (2.6 - 8.9)	1.250 (1.060 - 2.950)	5.49	99
15+15+22	1.67	1.67	2.45	5.80 (2.6 - 9.1)	1.310 (0.880 - 2.940)	5.75	99
15+15+25	1.66	1.66	2.77	6.10 (2.6 - 9.4)	1.400 (0.880 - 3.080)	6.15	99
15+15+35	1.92	1.92	4.47	8.30 (2.6 - 10.5)	1.970 (0.880 - 3.320)	8.65	99
15+15+42	1.79	1.79	5.02	8.60 (2.6 - 10.6)	2.030 (0.880 - 3.280)	8.92	99
15+15+50	1.61	1.61	5.38	8.60 (2.6 - 10.6)	2.020 (0.880 - 3.250)	8.87	99
15+15+60	1.43	1.43	5.73	8.60 (2.6 - 10.6)	2.050 (0.880 - 3.250)	9.00	99
15+20+20	1.66	2.22	2.22	6.10 (2.6 - 9.4)	1.400 (1.050 - 3.170)	6.15	99
15+20+22	1.66	2.21	2.43	6.30 (2.6 - 9.6)	1.450 (0.870 - 3.160)	6.37	99
15+20+25	1.65	2.20	2.75	6.60 (2.6 - 9.9)	1.540 (1.260 - 3.290)	6.76	99
15+20+35	1.84	2.46	4.30	8.60 (2.6 - 10.6)	2.050 (0.870 - 3.310)	9.00	99
15+20+42	1.68	2.23	4.69	8.60 (2.6 - 10.6)	2.030 (0.870 - 3.270)	8.92	99
15+20+50	1.52	2.02	5.06	8.60 (2.6 - 10.6)	2.020 (0.870 - 3.240)	8.87	99
15+20+60	1.36	1.81	5.43	8.60 (2.6 - 10.6)	2.050 (0.870 - 3.240)	9.00	99
15+22+22	1.65	2.42	2.42	6.50 (2.6 - 9.8)	1.510 (0.690 - 3.150)	6.63	99
15+22+25	1.77	2.59	2.94	7.30 (2.6 - 10.1)	1.710 (0.690 - 3.200)	7.51	99
15+22+35	1.79	2.63	4.18	8.60 (2.6 - 10.6)	2.050 (0.690 - 3.210)	9.00	99
15+22+42	1.63	2.39	4.57	8.60 (2.6 - 10.6)	2.030 (0.690 - 3.170)	8.92	99
15+22+50	1.48	2.17	4.94	8.60 (2.6 - 10.6)	2.020 (0.690 - 3.140)	8.87	99
15+22+60	1.33	1.95	5.32	8.60 (2.6 - 10.6)	2.050 (0.690 - 3.140)	9.00	99
15+25+25	1.92	3.19	3.19	8.30 (2.6 - 10.5)	1.970 (0.690 - 3.210)	8.65	99
15+25+35	1.72	2.87	4.01	8.60 (2.6 - 10.6)	2.050 (0.690 - 3.210)	9.00	99
15+25+42	1.57	2.62	4.40	8.60 (2.6 - 10.6)	2.030 (0.690 - 3.170)	8.92	99
15+25+50	1.43	2.39	4.78	8.60 (2.6 - 10.6)	2.020 (0.690 - 3.140)	8.87	99
15+25+60	1.29	2.15	5.16	8.60 (2.6 - 10.6)	2.050 (0.690 - 3.140)	9.00	99
15+35+35	1.52	3.54	3.54	8.60 (2.6 - 10.6)	2.050 (0.690 - 3.210)	9.00	99
15+35+42	1.40	3.27	3.93	8.60 (2.6 - 10.6)	2.030 (0.690 - 3.170)	8.92	99
15+35+50	1.29	3.01	4.30	8.60 (2.6 - 10.6)	2.020 (0.690 - 3.140)	8.87	99
15+35+60	1.17	2.74	4.69	8.60 (2.6 - 10.6)	2.050 (0.690 - 3.140)	9.00	99

MXZ-3C68VA HEATING

Indoor units combination	Heating capacity (kW)				Outdoor unit power consumption (kW)	Current (A)	Power factor (%)
	Unit A	Unit B	Unit C	Total			
35+60	3.17	5.43		8.60 (1.8 - 9.0)	1.900 (0.370 - 2.060)	8.34	99
42+42	4.30	4.30		8.60 (1.8 - 9.0)	2.090 (0.400 - 2.110)	9.18	99
42+50	3.93	4.67		8.60 (1.8 - 9.0)	1.910 (0.380 - 2.080)	8.39	99
42+60	3.54	5.06		8.60 (1.9 - 9.0)	1.780 (0.360 - 2.030)	7.82	99
50+50	4.30	4.30		8.60 (1.9 - 9.0)	1.820 (0.360 - 2.040)	7.99	99
50+60	3.91	4.69		8.60 (1.9 - 9.0)	1.780 (0.360 - 1.970)	7.82	99
60+60	4.30	4.30		8.60 (1.9 - 9.0)	1.800 (0.360 - 1.900)	7.91	99
15+15+15	1.70	1.70	1.70	5.10 (2.6 - 8.4)	1.110 (0.900 - 2.410)	4.87	99
15+15+20	1.68	1.68	2.24	5.60 (2.6 - 8.9)	1.250 (1.060 - 2.950)	5.49	99
15+15+22	1.67	1.67	2.45	5.80 (2.6 - 9.1)	1.310 (0.880 - 2.940)	5.75	99
15+15+25	1.66	1.66	2.77	6.10 (2.6 - 9.4)	1.400 (0.880 - 3.080)	6.15	99
15+15+35	1.92	1.92	4.47	8.30 (2.6 - 10.5)	1.970 (0.880 - 3.320)	8.65	99
15+15+42	1.79	1.79	5.02	8.60 (2.6 - 10.6)	2.030 (0.880 - 3.280)	8.92	99
15+15+50	1.61	1.61	5.38	8.60 (2.6 - 10.6)	2.020 (0.880 - 3.250)	8.87	99
15+15+60	1.43	1.43	5.73	8.60 (2.6 - 10.6)	2.050 (0.880 - 3.250)	9.00	99
15+20+20	1.66	2.22	2.22	6.10 (2.6 - 9.4)	1.400 (1.050 - 3.170)	6.15	99
15+20+22	1.66	2.21	2.43	6.30 (2.6 - 9.6)	1.450 (0.870 - 3.160)	6.37	99
15+20+25	1.65	2.20	2.75	6.60 (2.6 - 9.9)	1.540 (1.260 - 3.290)	6.76	99
15+20+35	1.84	2.46	4.30	8.60 (2.6 - 10.6)	2.050 (0.870 - 3.310)	9.00	99
15+20+42	1.68	2.23	4.69	8.60 (2.6 - 10.6)	2.030 (0.870 - 3.270)	8.92	99
15+20+50	1.52	2.02	5.06	8.60 (2.6 - 10.6)	2.020 (0.870 - 3.240)	8.87	99
15+20+60	1.36	1.81	5.43	8.60 (2.6 - 10.6)	2.050 (0.870 - 3.240)	9.00	99
15+22+22	1.65	2.42	2.42	6.50 (2.6 - 9.8)	1.510 (0.690 - 3.150)	6.63	99
15+22+25	1.77	2.59	2.94	7.30 (2.6 - 10.1)	1.710 (0.690 - 3.200)	7.51	99
15+22+35	1.79	2.63	4.18	8.60 (2.6 - 10.6)	2.050 (0.690 - 3.210)	9.00	99
15+22+42	1.63	2.39	4.57	8.60 (2.6 - 10.6)	2.030 (0.690 - 3.170)	8.92	99
15+22+50	1.48	2.17	4.94	8.60 (2.6 - 10.6)	2.020 (0.690 - 3.140)	8.87	99
15+22+60	1.33	1.95	5.32	8.60 (2.6 - 10.6)	2.050 (0.690 - 3.140)	9.00	99
15+25+25	1.92	3.19	3.19	8.30 (2.6 - 10.5)	1.970 (0.690 - 3.210)	8.65	99
15+25+35	1.72	2.87	4.01	8.60 (2.6 - 10.6)	2.050 (0.690 - 3.210)	9.00	99
15+25+42	1.57	2.62	4.40	8.60 (2.6 - 10.6)	2.030 (0.690 - 3.170)	8.92	99
15+25+50	1.43	2.39	4.78	8.60 (2.6 - 10.6)	2.020 (0.690 - 3.140)	8.87	99
15+25+60	1.29	2.15	5.16	8.60 (2.6 - 10.6)	2.050 (0.690 - 3.140)	9.00	99
15+35+35	1.52	3.54	3.54	8.60 (2.6 - 10.6)	2.050 (0.690 - 3.210)	9.00	99
15+35+42	1.40	3.27	3.93	8.60 (2.6 - 10.6)	2.030 (0.690 - 3.170)	8.92	99
15+35+50	1.29	3.01	4.30	8.60 (2.6 - 10.6)	2.020 (0.690 - 3.140)	8.87	99
15+35+60	1.17	2.74	4.69	8.60 (2.6 - 10.6)	2.050 (0.690 - 3.140)	9.00	99

MXZ-3C68VA HEATING

Indoor units combination	Heating capacity (kW)				Outdoor unit power consumption(kW)	Current (A)	Power factor (%)
	Unit A	Unit B	Unit C	Total			
22+25+42	2.13	2.42	4.06	8.60 (2.6 - 10.6)	2.030 (0.500 - 3.060)	8.92	99
22+25+50	1.95	2.22	4.43	8.60 (2.6 - 10.6)	2.020 (0.500 - 3.030)	8.87	99
22+25+60	1.77	2.01	4.82	8.60 (2.6 - 10.6)	2.050 (0.500 - 3.030)	9.00	99
22+35+35	2.06	3.27	3.27	8.60 (2.6 - 10.6)	2.050 (0.500 - 3.100)	9.00	99
22+35+42	1.91	3.04	3.65	8.60 (2.6 - 10.6)	2.030 (0.500 - 3.060)	8.92	99
22+35+50	1.77	2.81	4.02	8.60 (2.6 - 10.6)	2.020 (0.500 - 3.030)	8.87	99
22+35+60	1.62	2.57	4.41	8.60 (2.6 - 10.6)	2.050 (0.500 - 3.030)	9.00	99
22+42+42	1.78	3.41	3.41	8.60 (2.6 - 10.6)	2.010 (0.500 - 3.020)	8.83	99
22+42+50	1.66	3.17	3.77	8.60 (2.6 - 10.6)	2.000 (0.500 - 2.990)	8.78	99
25+25+25	2.87	2.87	2.87	8.60 (2.6 - 10.6)	2.050 (0.500 - 3.100)	9.00	99
25+25+35	2.53	2.53	3.54	8.60 (2.6 - 10.6)	2.050 (0.500 - 3.100)	9.00	99
25+25+42	2.34	2.34	3.93	8.60 (2.6 - 10.6)	2.030 (0.500 - 3.060)	8.92	99
25+25+50	2.15	2.15	4.30	8.60 (2.6 - 10.6)	2.020 (0.500 - 3.030)	8.87	99
25+25+60	1.95	1.95	4.69	8.60 (2.6 - 10.6)	2.050 (0.500 - 3.030)	9.00	99
25+35+35	2.26	3.17	3.17	8.60 (2.6 - 10.6)	2.050 (0.500 - 3.100)	9.00	99
25+35+42	2.11	2.95	3.54	8.60 (2.6 - 10.6)	2.030 (0.500 - 3.060)	8.92	99
25+35+50	1.95	2.74	3.91	8.60 (2.6 - 10.6)	2.020 (0.500 - 3.030)	8.87	99
25+35+60	1.79	2.51	4.30	8.60 (2.6 - 10.6)	2.050 (0.500 - 3.030)	9.00	99
25+42+42	1.97	3.31	3.31	8.60 (2.6 - 10.6)	2.010 (0.500 - 3.020)	8.83	99
25+42+50	1.84	3.09	3.68	8.60 (2.6 - 10.6)	2.000 (0.500 - 2.990)	8.78	99
35+35+35	2.87	2.87	2.87	8.60 (2.6 - 10.6)	2.050 (0.500 - 3.100)	9.00	99
35+35+42	2.69	2.69	3.23	8.60 (2.6 - 10.6)	2.030 (0.500 - 3.060)	8.92	99
35+35+50	2.51	2.51	3.58	8.60 (2.6 - 10.6)	2.020 (0.500 - 3.030)	8.87	99
35+42+42	2.53	3.04	3.04	8.60 (2.6 - 10.6)	2.010 (0.500 - 3.020)	8.83	99

MXZ-4C71VA COOLING

Indoor units combination	Cooling capacity (kW)				Total	Outdoor unit power consumption (kW)	Current (A)	Power factor (%)
	Unit A	Unit B	Unit C	Unit D				
15	1.50				1.50 (1.4 - 3.0)	0.490 (0.450 - 1.020)	2.15	99
20	2.00				2.00 (1.4 - 3.0)	0.520 (0.450 - 1.020)	2.28	99
22	2.20				2.20 (1.4 - 3.0)	0.510 (0.420 - 0.740)	2.24	99
25	2.50				2.50 (1.4 - 3.3)	0.580 (0.420 - 0.830)	2.55	99
35	3.50				3.50 (1.5 - 4.3)	0.800 (0.430 - 1.180)	3.51	99
42	4.20				4.20 (1.6 - 5.0)	1.060 (0.450 - 1.420)	4.66	99
50	5.00				5.00 (1.6 - 5.6)	1.400 (0.480 - 1.660)	6.15	99
60	6.00				6.00 (1.6 - 6.6)	1.700 (0.480 - 2.250)	7.47	99
15+15	1.50	1.50			3.00 (2.0 - 5.4)	0.790 (0.700 - 1.800)	3.47	99
15+20	1.50	2.00			3.50 (2.0 - 5.4)	0.850 (0.700 - 1.790)	3.73	99
15+22	1.50	2.20			3.70 (2.0 - 5.4)	0.980 (0.620 - 1.620)	4.30	99
15+25	1.50	2.50			4.00 (2.0 - 5.4)	1.130 (0.780 - 1.970)	4.96	99
15+35	1.50	3.50			5.00 (2.0 - 6.0)	1.110 (0.620 - 1.920)	4.87	99
15+42	1.50	4.20			5.70 (2.0 - 6.4)	1.370 (0.620 - 2.130)	6.02	99
15+50	1.50	5.00			6.50 (2.0 - 6.8)	1.670 (0.630 - 2.350)	7.33	99
15+60	1.36	5.44			6.80 (2.0 - 7.1)	1.850 (0.640 - 2.490)	8.12	99
20+20	2.00	2.00			4.00 (2.0 - 5.4)	1.100 (0.700 - 1.800)	4.83	99
20+22	2.00	2.20			4.20 (2.0 - 5.4)	1.030 (0.620 - 1.620)	4.52	99
20+25	2.00	2.50			4.50 (2.0 - 5.4)	0.960 (0.620 - 1.620)	4.22	99
20+35	2.00	3.50			5.50 (2.0 - 6.3)	1.300 (0.620 - 2.070)	5.71	99
20+42	2.00	4.20			6.20 (2.0 - 6.7)	1.550 (0.620 - 2.270)	6.81	99
20+50	1.94	4.86			6.80 (2.0 - 7.1)	1.850 (0.630 - 2.500)	8.12	99
20+60	1.70	5.10			6.80 (2.0 - 7.1)	1.850 (0.640 - 2.490)	8.12	99
22+22	2.20	2.20			4.40 (2.0 - 5.4)	0.900 (0.540 - 1.450)	3.95	99
22+25	2.20	2.50			4.70 (2.0 - 5.7)	0.990 (0.540 - 1.600)	4.35	99
22+35	2.20	3.50			5.70 (2.0 - 6.4)	1.340 (0.540 - 1.960)	5.88	99
22+42	2.20	4.20			6.40 (2.0 - 6.8)	1.600 (0.540 - 2.160)	7.03	99
22+50	2.08	4.72			6.80 (2.0 - 7.1)	1.820 (0.550 - 2.330)	7.99	99
22+60	1.82	4.98			6.80 (2.0 - 7.1)	1.820 (0.560 - 2.320)	7.99	99
25+25	2.50	2.50			5.00 (2.0 - 6.0)	1.080 (0.540 - 1.750)	4.74	99
25+35	2.50	3.50			6.00 (2.0 - 6.6)	1.450 (0.540 - 2.050)	6.37	99
25+42	2.50	4.20			6.70 (2.0 - 6.9)	1.710 (0.540 - 2.250)	7.51	99
25+50	2.27	4.53			6.80 (2.0 - 7.1)	1.820 (0.550 - 2.330)	7.99	99
25+60	2.00	4.80			6.80 (2.0 - 7.1)	1.810 (0.560 - 2.320)	7.95	99
35+35	3.40	3.40			6.80 (2.0 - 7.1)	1.820 (0.540 - 2.340)	7.99	99
35+42	3.09	3.71			6.80 (2.0 - 7.1)	1.820 (0.540 - 2.340)	7.99	99
35+50	2.80	4.00			6.80 (2.0 - 7.1)	1.810 (0.550 - 2.330)	7.95	99
35+60	2.51	4.29			6.80 (2.0 - 7.1)	1.750 (0.560 - 2.330)	7.69	99
42+42	3.40	3.40			6.80 (2.0 - 7.1)	1.820 (0.540 - 2.340)	7.99	99
42+50	3.10	3.70			6.80 (2.0 - 7.1)	1.770 (0.550 - 2.340)	7.77	99

MXZ-4C71VA COOLING

Indoor units combination	Cooling capacity (kW)				Total	Outdoor unit power consumption (kW)	Current (A)	Power factor (%)
	Unit A	Unit B	Unit C	Unit D				
42+60	2.80	4.00			6.80 (2.1 - 7.1)	1.710 (0.560 - 2.350)	7.51	99
50+50	3.40	3.40			6.80 (2.1 - 7.1)	1.720 (0.560 - 2.360)	7.55	99
50+60	3.09	3.71			6.80 (2.1 - 7.1)	1.650 (0.570 - 2.360)	7.25	99
60+60	3.40	3.40			6.80 (2.1 - 7.1)	1.580 (0.580 - 2.410)	6.94	99
15+15+15	1.50	1.50	1.50		4.50 (2.9 - 7.3)	0.970 (0.780 - 2.310)	4.26	99
15+15+20	1.50	1.50	2.00		5.00 (2.9 - 7.3)	1.270 (0.760 - 2.430)	5.58	99
15+15+22	1.50	1.50	2.20		5.20 (2.9 - 7.3)	1.310 (0.730 - 2.390)	5.75	99
15+15+25	1.50	1.50	2.50		5.50 (2.9 - 7.4)	1.420 (0.730 - 2.400)	6.24	99
15+15+35	1.50	1.50	3.50		6.50 (2.9 - 8.0)	1.620 (0.730 - 2.460)	7.11	99
15+15+42	1.48	1.48	4.14		7.10 (2.9 - 8.4)	1.950 (0.730 - 2.540)	8.56	99
15+15+50	1.33	1.33	4.44		7.10 (2.9 - 8.5)	1.910 (0.730 - 2.560)	8.39	99
15+15+60	1.18	1.18	4.73		7.10 (2.9 - 8.5)	1.810 (0.730 - 2.540)	7.95	99
15+20+20	1.50	2.00	2.00		5.50 (2.9 - 7.4)	1.460 (0.760 - 2.440)	6.41	99
15+20+22	1.50	2.00	2.20		5.70 (2.9 - 7.4)	1.490 (0.730 - 2.400)	6.54	99
15+20+25	1.50	2.00	2.50		6.00 (2.9 - 7.4)	1.600 (0.840 - 2.400)	7.03	99
15+20+35	1.50	2.00	3.50		7.00 (2.9 - 8.3)	1.900 (0.730 - 2.530)	8.34	99
15+20+42	1.38	1.84	3.87		7.10 (2.9 - 8.5)	1.940 (0.730 - 2.570)	8.52	99
15+20+50	1.25	1.67	4.18		7.10 (2.9 - 8.5)	1.870 (0.730 - 2.550)	8.21	99
15+20+60	1.12	1.49	4.48		7.10 (2.9 - 8.5)	1.780 (0.730 - 2.530)	7.82	99
15+22+22	1.50	2.20	2.20		5.90 (2.9 - 7.4)	1.520 (0.700 - 2.360)	6.68	99
15+22+25	1.50	2.20	2.50		6.20 (2.9 - 7.6)	1.570 (0.700 - 2.380)	6.90	99
15+22+35	1.48	2.17	3.45		7.10 (2.9 - 8.4)	1.930 (0.700 - 2.510)	8.48	99
15+22+42	1.35	1.98	3.77		7.10 (2.9 - 8.5)	1.880 (0.700 - 2.530)	8.26	99
15+22+50	1.22	1.80	4.08		7.10 (2.9 - 8.5)	1.820 (0.700 - 2.510)	7.99	99
15+22+60	1.10	1.61	4.39		7.10 (2.9 - 8.5)	1.720 (0.700 - 2.490)	7.55	99
15+25+25	1.50	2.50	2.50		6.50 (2.9 - 8.0)	1.580 (0.700 - 2.420)	6.94	99
15+25+35	1.42	2.37	3.31		7.10 (2.9 - 8.5)	1.930 (0.700 - 2.540)	8.48	99
15+25+42	1.30	2.16	3.64		7.10 (2.9 - 8.5)	1.860 (0.700 - 2.520)	8.17	99
15+25+50	1.18	1.97	3.94		7.10 (2.9 - 8.5)	1.800 (0.700 - 2.510)	7.91	99
15+25+60	1.07	1.78	4.26		7.10 (2.9 - 8.5)	1.700 (0.700 - 2.490)	7.47	99
15+35+35	1.25	2.92	2.92		7.10 (2.9 - 8.5)	1.860 (0.700 - 2.530)	8.17	99
15+35+42	1.16	2.70	3.24		7.10 (2.9 - 8.5)	1.800 (0.700 - 2.510)	7.91	99
15+35+50	1.07	2.49	3.55		7.10 (2.9 - 8.5)	1.730 (0.700 - 2.500)	7.60	99
15+35+60	0.97	2.26	3.87		7.10 (2.9 - 8.5)	1.670 (0.700 - 2.480)	7.33	99
15+42+42	1.08	3.01	3.01		7.10 (2.9 - 8.5)	1.730 (0.700 - 2.500)	7.60	99
15+42+50	1.00	2.79	3.32		7.10 (2.9 - 8.5)	1.680 (0.700 - 2.480)	7.38	99
15+42+60	0.91	2.55	3.64		7.10 (2.9 - 8.5)	1.650 (0.700 - 2.470)	7.25	99
15+50+50	0.93	3.09	3.09		7.10 (2.9 - 8.5)	1.670 (0.700 - 2.470)	7.33	99
15+50+60	0.85	2.84	3.41		7.10 (2.9 - 8.5)	1.640 (0.700 - 2.460)	7.20	99
20+20+20	2.00	2.00	2.00		6.00 (2.9 - 7.4)	1.520 (0.780 - 2.320)	6.68	99

MXZ-4C71VA COOLING

Indoor units combination	Cooling capacity (kW)				Total	Outdoor unit power consumption (kW)	Current (A)	Power factor (%)
	Unit A	Unit B	Unit C	Unit D				
20+20+22	2.00	2.00	2.20		6.20 (2.9 - 7.6)	1.610 (0.730 - 2.420)	7.07	99
20+20+25	2.00	2.00	2.50		6.50 (2.9 - 8.0)	1.620 (0.730 - 2.460)	7.11	99
20+20+35	1.89	1.89	3.31		7.10 (2.9 - 8.5)	1.970 (0.730 - 2.580)	8.65	99
20+20+42	1.73	1.73	3.64		7.10 (2.9 - 8.5)	1.900 (0.730 - 2.560)	8.34	99
20+20+50	1.58	1.58	3.94		7.10 (2.9 - 8.5)	1.840 (0.730 - 2.550)	8.08	99
20+20+60	1.42	1.42	4.26		7.10 (2.9 - 8.5)	1.740 (0.730 - 2.530)	7.64	99
20+22+22	2.00	2.20	2.20		6.40 (2.9 - 7.9)	1.570 (0.700 - 2.410)	6.90	99
20+22+25	2.00	2.20	2.50		6.70 (2.9 - 8.1)	1.650 (0.700 - 2.430)	7.25	99
20+22+35	1.84	2.03	3.23		7.10 (2.9 - 8.5)	1.920 (0.700 - 2.540)	8.43	99
20+22+42	1.69	1.86	3.55		7.10 (2.9 - 8.5)	1.850 (0.700 - 2.520)	8.12	99
20+22+50	1.54	1.70	3.86		7.10 (2.9 - 8.5)	1.790 (0.700 - 2.500)	7.86	99
20+22+60	1.39	1.53	4.18		7.10 (2.9 - 8.5)	1.690 (0.700 - 2.480)	7.42	99
20+25+25	2.00	2.50	2.50		7.00 (2.9 - 8.3)	1.860 (0.700 - 2.490)	8.17	99
20+25+35	1.78	2.22	3.11		7.10 (2.9 - 8.5)	1.900 (0.700 - 2.540)	8.34	99
20+25+42	1.63	2.04	3.43		7.10 (2.9 - 8.5)	1.830 (0.700 - 2.520)	8.04	99
20+25+50	1.49	1.87	3.74		7.10 (2.9 - 8.5)	1.770 (0.700 - 2.500)	7.77	99
20+25+60	1.35	1.69	4.06		7.10 (2.9 - 8.5)	1.670 (0.700 - 2.480)	7.33	99
20+35+35	1.58	2.76	2.76		7.10 (2.9 - 8.5)	1.830 (0.700 - 2.530)	8.04	99
20+35+42	1.46	2.56	3.07		7.10 (2.9 - 8.5)	1.760 (0.700 - 2.510)	7.73	99
20+35+50	1.35	2.37	3.38		7.10 (2.9 - 8.5)	1.700 (0.700 - 2.490)	7.47	99
20+35+60	1.23	2.16	3.70		7.10 (2.9 - 8.5)	1.670 (0.700 - 2.480)	7.33	99
20+42+42	1.37	2.87	2.87		7.10 (2.9 - 8.5)	1.700 (0.700 - 2.490)	7.47	99
20+42+50	1.27	2.66	3.17		7.10 (2.9 - 8.5)	1.680 (0.700 - 2.480)	7.38	99
20+42+60	1.16	2.44	3.49		7.10 (2.9 - 8.5)	1.650 (0.700 - 2.470)	7.25	99
20+50+50	1.18	2.96	2.96		7.10 (2.9 - 8.5)	1.670 (0.700 - 2.470)	7.33	99
22+22+22	2.20	2.20	2.20		6.60 (2.9 - 8.1)	1.540 (0.670 - 2.390)	6.76	99
22+22+25	2.20	2.20	2.50		6.90 (2.9 - 8.2)	1.750 (0.670 - 2.420)	7.69	99
22+22+35	1.98	1.98	3.15		7.10 (2.9 - 8.5)	1.860 (0.670 - 2.500)	8.17	99
22+22+42	1.82	1.82	3.47		7.10 (2.9 - 8.5)	1.800 (0.670 - 2.480)	7.91	99
22+22+50	1.66	1.66	3.78		7.10 (2.9 - 8.5)	1.730 (0.670 - 2.460)	7.60	99
22+22+60	1.50	1.50	4.10		7.10 (2.9 - 8.5)	1.640 (0.670 - 2.440)	7.20	99
22+25+25	2.17	2.47	2.47		7.10 (2.9 - 8.4)	1.890 (0.670 - 2.470)	8.30	99
22+25+35	1.90	2.16	3.03		7.10 (2.9 - 8.5)	1.840 (0.670 - 2.490)	8.08	99
22+25+42	1.76	1.99	3.35		7.10 (2.9 - 8.5)	1.780 (0.670 - 2.480)	7.82	99
22+25+50	1.61	1.83	3.66		7.10 (2.9 - 8.5)	1.710 (0.670 - 2.460)	7.51	99
22+25+60	1.46	1.66	3.98		7.10 (2.9 - 8.5)	1.630 (0.670 - 2.440)	7.16	99
22+35+35	1.70	2.70	2.70		7.10 (2.9 - 8.5)	1.780 (0.670 - 2.480)	7.82	99
22+35+42	1.58	2.51	3.01		7.10 (2.9 - 8.5)	1.710 (0.670 - 2.470)	7.51	99
22+35+50	1.46	2.32	3.32		7.10 (2.9 - 8.5)	1.660 (0.670 - 2.450)	7.29	99
22+35+60	1.34	2.12	3.64		7.10 (2.9 - 8.5)	1.630 (0.670 - 2.440)	7.16	99

MXZ-4C71VA COOLING

Indoor units combination	Cooling capacity (kW)				Total	Outdoor unit power consumption (kW)	Current (A)	Power factor (%)
	Unit A	Unit B	Unit C	Unit D				
22+42+42	1.47	2.81	2.81		7.10 (2.9 - 8.5)	1.650 (0.670 - 2.450)	7.25	99
22+42+50	1.37	2.62	3.11		7.10 (2.9 - 8.5)	1.640 (0.670 - 2.440)	7.20	99
22+42+60	1.26	2.40	3.44		7.10 (2.9 - 8.5)	1.610 (0.670 - 2.430)	7.07	99
22+50+50	1.28	2.91	2.91		7.10 (2.9 - 8.5)	1.630 (0.670 - 2.430)	7.16	99
25+25+25	2.37	2.37	2.37		7.10 (2.9 - 8.5)	1.890 (0.670 - 2.500)	8.30	99
25+25+35	2.09	2.09	2.92		7.10 (2.9 - 8.5)	1.820 (0.670 - 2.490)	7.99	99
25+25+42	1.93	1.93	3.24		7.10 (2.9 - 8.5)	1.760 (0.670 - 2.470)	7.73	99
25+25+50	1.78	1.78	3.55		7.10 (2.9 - 8.5)	1.690 (0.670 - 2.460)	7.42	99
25+25+60	1.61	1.61	3.87		7.10 (2.9 - 8.5)	1.630 (0.670 - 2.440)	7.16	99
25+35+35	1.87	2.62	2.62		7.10 (2.9 - 8.5)	1.760 (0.670 - 2.480)	7.73	99
25+35+42	1.74	2.44	2.92		7.10 (2.9 - 8.5)	1.690 (0.670 - 2.460)	7.42	99
25+35+50	1.61	2.26	3.23		7.10 (2.9 - 8.5)	1.660 (0.670 - 2.450)	7.29	99
25+35+60	1.48	2.07	3.55		7.10 (2.9 - 8.5)	1.630 (0.670 - 2.440)	7.16	99
25+42+42	1.63	2.74	2.74		7.10 (2.9 - 8.5)	1.650 (0.670 - 2.450)	7.25	99
25+42+50	1.52	2.55	3.03		7.10 (2.9 - 8.5)	1.640 (0.670 - 2.440)	7.20	99
25+50+50	1.42	2.84	2.84		7.10 (2.9 - 8.5)	1.630 (0.670 - 2.430)	7.16	99
35+35+35	2.37	2.37	2.37		7.10 (2.9 - 8.5)	1.690 (0.670 - 2.470)	7.42	99
35+35+42	2.22	2.22	2.66		7.10 (2.9 - 8.5)	1.670 (0.670 - 2.460)	7.33	99
35+35+50	2.07	2.07	2.96		7.10 (2.9 - 8.5)	1.660 (0.670 - 2.450)	7.29	99
35+42+42	2.09	2.51	2.51		7.10 (2.9 - 8.5)	1.650 (0.670 - 2.450)	7.25	99
15+15+15+15	1.50	1.50	1.50	1.50	6.00 (3.7 - 7.9)	1.390 (1.000 - 2.370)	6.10	99
15+15+15+20	1.50	1.50	1.50	2.00	6.50 (3.7 - 7.9)	1.660 (0.920 - 2.570)	7.29	99
15+15+15+22	1.50	1.50	1.50	2.20	6.70 (3.7 - 7.9)	1.670 (0.890 - 2.520)	7.33	99
15+15+15+25	1.50	1.50	1.50	2.50	7.00 (3.7 - 8.0)	1.740 (0.890 - 2.530)	7.64	99
15+15+15+35	1.33	1.33	1.33	3.11	7.10 (3.7 - 8.0)	1.960 (1.090 - 2.530)	8.61	99
15+15+15+42	1.22	1.22	1.22	3.43	7.10 (3.7 - 8.7)	1.800 (0.890 - 2.600)	7.91	99
15+15+15+50	1.12	1.12	1.12	3.74	7.10 (3.7 - 8.8)	1.770 (0.890 - 2.610)	7.77	99
15+15+15+60	1.01	1.01	1.01	4.06	7.10 (3.7 - 8.8)	1.740 (0.890 - 2.600)	7.64	99
15+15+20+20	1.50	1.50	2.00	2.00	7.00 (3.7 - 8.0)	1.780 (0.920 - 2.580)	7.82	99
15+15+20+22	1.48	1.48	1.97	2.17	7.10 (3.7 - 8.0)	1.780 (0.890 - 2.530)	7.82	99
15+15+20+25	1.42	1.42	1.89	2.37	7.10 (3.7 - 8.0)	1.850 (0.890 - 2.530)	8.12	99
15+15+20+35	1.25	1.25	1.67	2.92	7.10 (3.7 - 8.5)	1.860 (0.890 - 2.580)	8.17	99
15+15+20+42	1.16	1.16	1.54	3.24	7.10 (3.7 - 8.8)	1.780 (0.890 - 2.620)	7.82	99
15+15+20+50	1.07	1.07	1.42	3.55	7.10 (3.7 - 8.8)	1.770 (0.890 - 2.610)	7.77	99
15+15+20+60	0.97	0.97	1.29	3.87	7.10 (3.7 - 8.8)	1.740 (0.890 - 2.600)	7.64	99
15+15+22+22	1.44	1.44	2.11	2.11	7.10 (3.7 - 8.0)	1.790 (0.860 - 2.480)	7.86	99
15+15+22+25	1.38	1.38	2.03	2.31	7.10 (3.7 - 8.0)	1.850 (0.860 - 2.480)	8.12	99
15+15+22+35	1.22	1.22	1.80	2.86	7.10 (3.7 - 8.7)	1.780 (0.860 - 2.560)	7.82	99
15+15+22+42	1.13	1.13	1.66	3.17	7.10 (3.7 - 8.8)	1.740 (0.860 - 2.570)	7.64	99
15+15+22+50	1.04	1.04	1.53	3.48	7.10 (3.7 - 8.8)	1.730 (0.860 - 2.560)	7.60	99

MXZ-4C71VA HEATING

Indoor units combination	Heating capacity (kW)					Outdoor unit power consumption (kW)	Current (A)	Power factor (%)
	Unit A	Unit B	Unit C	Unit D	Total			
20+20+42+42	1.39	1.39	2.91	2.91	8.60 (3.4 - 10.7)	1.665 (0.620 - 3.090)	7.31	99
20+22+22+22	2.00	2.20	2.20	2.20	8.60 (3.4 - 10.7)	1.810 (0.640 - 3.070)	7.95	99
20+22+22+25	1.93	2.13	2.13	2.42	8.60 (3.4 - 10.7)	1.705 (0.640 - 3.070)	7.49	99
20+22+22+35	1.74	1.91	1.91	3.04	8.60 (3.4 - 10.7)	1.705 (0.640 - 3.070)	7.49	99
20+22+22+42	1.62	1.78	1.78	3.41	8.60 (3.4 - 10.7)	1.685 (0.610 - 3.030)	7.40	99
20+22+22+50	1.51	1.66	1.66	3.77	8.60 (3.4 - 10.7)	1.675 (0.600 - 3.040)	7.36	99
20+22+22+60	1.39	1.53	1.53	4.16	8.60 (3.4 - 10.7)	1.645 (0.640 - 3.040)	7.22	99
20+22+25+25	1.87	2.06	2.34	2.34	8.60 (3.4 - 10.7)	1.705 (0.640 - 3.070)	7.49	99
20+22+25+35	1.69	1.85	2.11	2.95	8.60 (3.4 - 10.7)	1.705 (0.640 - 3.070)	7.49	99
20+22+25+42	1.58	1.74	1.97	3.31	8.60 (3.4 - 10.7)	1.685 (0.610 - 3.030)	7.40	99
20+22+25+50	1.47	1.62	1.84	3.68	8.60 (3.4 - 10.7)	1.675 (0.600 - 3.040)	7.36	99
20+22+35+35	1.54	1.69	2.69	2.69	8.60 (3.4 - 10.7)	1.705 (0.640 - 3.070)	7.49	99
20+22+35+42	1.45	1.59	2.53	3.04	8.60 (3.4 - 10.7)	1.685 (0.610 - 3.030)	7.40	99
20+25+25+25	1.81	2.26	2.26	2.26	8.60 (3.4 - 10.7)	1.705 (0.640 - 3.070)	7.49	99
20+25+25+35	1.64	2.05	2.05	2.87	8.60 (3.4 - 10.7)	1.705 (0.640 - 3.070)	7.49	99
20+25+25+42	1.54	1.92	1.92	3.23	8.60 (3.4 - 10.7)	1.685 (0.610 - 3.030)	7.40	99
20+25+25+50	1.43	1.79	1.79	3.58	8.60 (3.4 - 10.7)	1.675 (0.600 - 3.040)	7.36	99
20+25+35+35	1.50	1.87	2.62	2.62	8.60 (3.4 - 10.7)	1.705 (0.640 - 3.070)	7.49	99
20+25+35+42	1.41	1.76	2.47	2.96	8.60 (3.4 - 10.7)	1.685 (0.610 - 3.030)	7.40	99
20+35+35+35	1.38	2.41	2.41	2.41	8.60 (3.4 - 10.7)	1.705 (0.640 - 3.070)	7.49	99
22+22+22+22	2.15	2.15	2.15	2.15	8.60 (3.4 - 10.7)	1.705 (0.600 - 2.970)	7.49	99
22+22+22+25	2.08	2.08	2.08	2.36	8.60 (3.4 - 10.7)	1.705 (0.600 - 2.970)	7.49	99
22+22+22+35	1.87	1.87	1.87	2.98	8.60 (3.4 - 10.7)	1.705 (0.600 - 2.970)	7.49	99
22+22+22+42	1.75	1.75	1.75	3.34	8.60 (3.4 - 10.7)	1.685 (0.570 - 2.930)	7.40	99
22+22+22+50	1.63	1.63	1.63	3.71	8.60 (3.4 - 10.7)	1.675 (0.560 - 2.940)	7.36	99
22+22+25+25	2.01	2.01	2.29	2.29	8.60 (3.4 - 10.7)	1.705 (0.600 - 2.970)	7.49	99
22+22+25+35	1.82	1.82	2.07	2.89	8.60 (3.4 - 10.7)	1.705 (0.600 - 2.970)	7.49	99
22+22+25+42	1.70	1.70	1.94	3.25	8.60 (3.4 - 10.7)	1.685 (0.570 - 2.930)	7.40	99
22+22+25+50	1.59	1.59	1.81	3.61	8.60 (3.4 - 10.7)	1.675 (0.560 - 2.940)	7.36	99
22+22+35+35	1.66	1.66	2.64	2.64	8.60 (3.4 - 10.7)	1.705 (0.600 - 2.970)	7.49	99
22+22+35+42	1.56	1.56	2.49	2.99	8.60 (3.4 - 10.7)	1.685 (0.570 - 2.930)	7.40	99
22+25+25+25	1.95	2.22	2.22	2.22	8.60 (3.4 - 10.7)	1.705 (0.600 - 2.970)	7.49	99
22+25+25+35	1.77	2.01	2.01	2.81	8.60 (3.4 - 10.7)	1.705 (0.600 - 2.970)	7.49	99
22+25+25+42	1.66	1.89	1.89	3.17	8.60 (3.4 - 10.7)	1.685 (0.570 - 2.930)	7.40	99
22+25+25+50	1.55	1.76	1.76	3.52	8.60 (3.4 - 10.7)	1.675 (0.560 - 2.940)	7.36	99
22+25+35+35	1.62	1.84	2.57	2.57	8.60 (3.4 - 10.7)	1.705 (0.600 - 2.970)	7.49	99
22+25+35+42	1.53	1.73	2.43	2.91	8.60 (3.4 - 10.7)	1.685 (0.570 - 2.930)	7.40	99
25+25+25+25	2.15	2.15	2.15	2.15	8.60 (3.4 - 10.7)	1.705 (0.600 - 2.970)	7.49	99
25+25+25+35	1.95	1.95	1.95	2.74	8.60 (3.4 - 10.7)	1.705 (0.600 - 2.970)	7.49	99
25+25+25+42	1.84	1.84	1.84	3.09	8.60 (3.4 - 10.7)	1.685 (0.570 - 2.930)	7.40	99

MXZ-4C71VA HEATING

Indoor units combination	Heating capacity (kW)					Outdoor unit power consumption (kW)	Current (A)	Power factor (%)
	Unit A	Unit B	Unit C	Unit D	Total			
25+25+25+50	1.72	1.72	1.72	3.44	8.60 (3.4 - 10.7)	1.675 (0.560 - 2.940)	7.36	99
25+25+35+35	1.79	1.79	2.51	2.51	8.60 (3.4 - 10.7)	1.705 (0.600 - 2.970)	7.49	99

MXZ-4C80VA(VA2) COOLING

Indoor units combination	Cooling capacity (kW)				Total	Outdoor unit power consumption(kW)	Current (A)	Power factor (%)
	Unit A	Unit B	Unit C	Unit D				
15	1.50				1.50 (1.4 - 2.1)	0.510 (0.470 - 1.000)	2.24	99
20	2.00				2.00 (1.4 - 2.8)	0.680 (0.470 - 1.330)	2.99	99
22	2.20				2.20 (1.4 - 3.0)	0.670 (0.400 - 0.920)	2.94	99
25	2.50				2.50 (1.4 - 3.3)	0.760 (0.400 - 1.010)	3.34	99
35	3.50				3.50 (1.5 - 4.3)	1.030 (0.400 - 1.290)	4.52	99
42	4.20				4.20 (1.6 - 5.0)	1.230 (0.410 - 1.460)	5.40	99
50	5.00				5.00 (1.6 - 5.6)	1.440 (0.420 - 1.630)	6.32	99
60	6.00				6.00 (1.6 - 6.6)	1.930 (0.400 - 2.130)	8.48	99
71	7.10				7.10 (1.7 - 7.4)	2.550 (0.410 - 2.710)	11.20	99
15+15	1.50	1.50			3.00 (2.0 - 4.0)	0.860 (0.660 - 2.130)	3.78	99
15+20	1.50	2.00			3.50 (2.0 - 4.6)	1.110 (0.660 - 2.530)	4.87	99
15+22	1.50	2.20			3.70 (2.0 - 4.8)	1.130 (0.630 - 2.590)	4.96	99
15+25	1.50	2.50			4.00 (2.0 - 5.2)	1.190 (0.660 - 2.760)	5.23	99
15+35	1.50	3.50			5.00 (2.0 - 6.2)	1.400 (0.610 - 1.990)	6.15	99
15+42	1.50	4.20			5.70 (2.0 - 6.8)	1.670 (0.610 - 2.370)	7.33	99
15+50	1.50	5.00			6.50 (2.0 - 7.1)	2.040 (0.610 - 2.570)	8.96	99
15+60	1.50	6.00			7.50 (2.0 - 7.8)	2.610 (0.610 - 2.780)	11.46	99
15+71	1.36	6.44			7.80 (2.0 - 8.2)	2.810 (0.620 - 2.890)	12.34	99
20+20	2.00	2.00			4.00 (2.0 - 5.2)	1.190 (0.660 - 2.760)	5.23	99
20+22	2.00	2.20			4.20 (2.0 - 5.4)	1.200 (0.630 - 2.220)	5.27	99
20+25	2.00	2.50			4.50 (2.0 - 5.7)	1.210 (0.630 - 1.700)	5.31	99
20+35	2.00	3.50			5.50 (2.0 - 6.7)	1.630 (0.610 - 2.320)	7.16	99
20+42	2.00	4.20			6.20 (2.0 - 7.1)	1.900 (0.610 - 2.570)	8.34	99
20+50	2.00	5.00			7.00 (2.0 - 7.1)	2.280 (0.610 - 2.570)	10.01	99
20+60	1.93	5.78			7.70 (2.0 - 8.1)	2.740 (0.610 - 2.870)	12.03	99
20+71	1.71	6.09			7.80 (2.0 - 8.2)	2.810 (0.620 - 2.890)	12.34	99
22+22	2.20	2.20			4.40 (2.0 - 5.6)	1.130 (0.600 - 1.600)	4.96	99
22+25	2.20	2.50			4.70 (2.0 - 5.9)	1.250 (0.600 - 1.780)	5.49	99
22+35	2.20	3.50			5.70 (2.0 - 6.8)	1.680 (0.580 - 2.340)	7.38	99
22+42	2.20	4.20			6.40 (2.0 - 7.1)	1.950 (0.580 - 2.530)	8.56	99
22+50	2.20	5.00			7.20 (2.0 - 7.4)	2.370 (0.580 - 2.620)	10.41	99
22+60	2.09	5.71			7.80 (2.0 - 8.2)	2.770 (0.580 - 2.860)	12.17	99
22+71	1.87	6.03			7.90 (2.0 - 8.8)	2.730 (0.590 - 3.150)	11.99	99
25+25	2.50	2.50			5.00 (2.0 - 6.2)	1.360 (0.580 - 1.950)	5.97	99
25+35	2.50	3.50			6.00 (2.0 - 7.1)	1.810 (0.580 - 2.540)	7.95	99
25+42	2.50	4.20			6.70 (2.0 - 7.1)	2.100 (0.580 - 2.540)	9.22	99
25+50	2.50	5.00			7.50 (2.0 - 7.8)	2.570 (0.580 - 2.750)	11.29	99
25+60	2.29	5.51			7.80 (2.0 - 8.2)	2.770 (0.590 - 2.860)	12.17	99
25+71	2.06	5.84			7.90 (2.0 - 8.8)	2.730 (0.590 - 3.150)	11.99	99
35+35	3.50	3.50			7.00 (2.0 - 7.1)	2.290 (0.580 - 2.550)	10.06	99

MXZ-4C80VA(VA2) COOLING

Indoor units combination	Cooling capacity (kW)				Total	Outdoor unit power consumption (kW)	Current (A)	Power factor (%)
	Unit A	Unit B	Unit C	Unit D				
35+42	3.50	4.20			7.70 (2.0 - 8.1)	2.700 (0.580 - 2.850)	11.86	99
35+50	3.21	4.59			7.80 (2.0 - 8.2)	2.770 (0.590 - 2.870)	12.17	99
35+60	2.91	4.99			7.90 (2.0 - 8.8)	2.730 (0.590 - 3.160)	11.99	99
35+71	2.61	5.29			7.90 (2.1 - 8.8)	2.730 (0.580 - 3.120)	11.99	99
42+42	3.90	3.90			7.80 (2.0 - 8.2)	2.820 (0.590 - 2.890)	12.38	99
42+50	3.61	4.29			7.90 (2.0 - 8.8)	2.680 (0.590 - 3.160)	11.77	99
42+60	3.25	4.65			7.90 (2.1 - 8.8)	2.680 (0.590 - 3.140)	11.77	99
42+71	2.97	5.03			8.00 (2.1 - 8.8)	2.470 (0.560 - 3.070)	10.85	99
50+50	3.95	3.95			7.90 (2.1 - 8.8)	2.780 (0.590 - 3.190)	12.21	99
50+60	3.64	4.36			8.00 (2.1 - 8.8)	2.470 (0.570 - 3.090)	10.85	99
50+71	3.31	4.69			8.00 (2.1 - 8.8)	2.470 (0.550 - 3.020)	10.85	99
60+60	4.00	4.00			8.00 (2.1 - 8.8)	2.470 (0.550 - 3.020)	10.85	99
60+71	3.66	4.34			8.00 (2.1 - 8.8)	2.470 (0.550 - 3.010)	10.85	99
15+15+15	1.50	1.50	1.50		4.50 (2.9 - 5.7)	1.120 (0.770 - 3.020)	4.92	99
15+15+20	1.50	1.50	2.00		5.00 (2.9 - 6.3)	1.430 (0.780 - 3.340)	6.28	99
15+15+22	1.50	1.50	2.20		5.20 (2.9 - 6.5)	1.470 (0.750 - 3.380)	6.46	99
15+15+25	1.50	1.50	2.50		5.50 (2.9 - 6.9)	1.590 (0.750 - 3.530)	6.98	99
15+15+35	1.50	1.50	3.50		6.50 (2.9 - 8.0)	1.810 (0.750 - 2.690)	7.95	99
15+15+42	1.50	1.50	4.20		7.20 (2.9 - 8.7)	2.070 (0.750 - 2.870)	9.09	99
15+15+50	1.44	1.44	4.81		7.70 (2.9 - 9.0)	2.250 (0.760 - 3.050)	9.88	99
15+15+60	1.30	1.30	5.20		7.80 (2.9 - 9.0)	2.250 (0.770 - 3.020)	9.88	99
15+15+71	1.17	1.17	5.55		7.90 (2.9 - 9.0)	2.260 (0.780 - 2.980)	9.93	99
15+20+20	1.50	2.00	2.00		5.50 (2.9 - 6.9)	1.630 (0.780 - 3.560)	7.16	99
15+20+22	1.50	2.00	2.20		5.70 (2.9 - 7.1)	1.660 (0.750 - 3.610)	7.29	99
15+20+25	1.50	2.00	2.50		6.00 (2.9 - 7.5)	1.780 (0.830 - 3.760)	7.82	99
15+20+35	1.50	2.00	3.50		7.00 (2.9 - 8.5)	2.000 (0.750 - 2.740)	8.78	99
15+20+42	1.48	1.97	4.15		7.60 (2.9 - 9.0)	2.230 (0.750 - 3.060)	9.79	99
15+20+50	1.38	1.84	4.59		7.80 (2.9 - 9.0)	2.280 (0.760 - 3.040)	10.01	99
15+20+60	1.25	1.66	4.99		7.90 (2.9 - 9.0)	2.280 (0.770 - 3.000)	10.01	99
15+20+71	1.13	1.51	5.36		8.00 (2.9 - 9.0)	2.280 (0.780 - 3.090)	10.01	99
15+22+22	1.50	2.20	2.20		5.90 (2.9 - 7.4)	1.700 (0.720 - 3.690)	7.47	99
15+22+25	1.50	2.20	2.50		6.20 (2.9 - 7.7)	1.750 (0.720 - 3.300)	7.69	99
15+22+35	1.50	2.20	3.50		7.20 (2.9 - 8.7)	2.050 (0.720 - 2.840)	9.00	99
15+22+42	1.46	2.14	4.09		7.70 (2.9 - 9.0)	2.220 (0.720 - 3.030)	9.75	99
15+22+50	1.34	1.97	4.48		7.80 (2.9 - 9.0)	2.240 (0.730 - 3.000)	9.84	99
15+22+60	1.22	1.79	4.89		7.90 (2.9 - 9.0)	2.240 (0.740 - 2.970)	9.84	99
15+22+71	1.11	1.63	5.26		8.00 (2.9 - 9.0)	2.240 (0.750 - 3.060)	9.84	99
15+25+25	1.50	2.50	2.50		6.50 (2.9 - 8.0)	1.770 (0.720 - 2.660)	7.77	99
15+25+35	1.50	2.50	3.50		7.50 (2.9 - 9.0)	2.180 (0.720 - 3.040)	9.57	99
15+25+42	1.41	2.35	3.94		7.70 (2.9 - 9.0)	2.220 (0.730 - 3.020)	9.75	99

MXZ-4C80VA(VA2) COOLING

Indoor units combination	Cooling capacity (kW)				Total	Outdoor unit power consumption (kW)	Current (A)	Power factor (%)
	Unit A	Unit B	Unit C	Unit D				
15+25+50	1.30	2.17	4.33		7.80 (2.9 - 9.0)	2.240 (0.740 - 2.990)	9.84	99
15+25+60	1.19	1.98	4.74		7.90 (2.9 - 9.0)	2.240 (0.750 - 2.960)	9.84	99
15+25+71	1.08	1.80	5.12		8.00 (2.9 - 9.0)	2.240 (0.750 - 3.060)	9.84	99
15+35+35	1.38	3.21	3.21		7.80 (2.9 - 9.0)	2.270 (0.730 - 3.010)	9.97	99
15+35+42	1.27	2.97	3.56		7.80 (2.9 - 9.0)	2.250 (0.740 - 2.980)	9.88	99
15+35+50	1.19	2.77	3.95		7.90 (2.9 - 9.0)	2.270 (0.750 - 2.960)	9.97	99
15+35+60	1.09	2.55	4.36		8.00 (2.9 - 9.0)	2.260 (0.750 - 3.060)	9.93	99
15+35+71	0.99	2.31	4.69		8.00 (2.9 - 9.0)	2.240 (0.750 - 3.060)	9.84	99
15+42+42	1.20	3.35	3.35		7.90 (2.9 - 9.0)	2.260 (0.740 - 2.960)	9.93	99
15+42+50	1.12	3.14	3.74		8.00 (2.9 - 9.0)	2.270 (0.750 - 3.060)	9.97	99
15+42+60	1.03	2.87	4.10		8.00 (2.9 - 9.0)	2.240 (0.750 - 3.060)	9.84	99
15+42+71	0.94	2.63	4.44		8.00 (2.9 - 9.0)	2.220 (0.750 - 3.060)	9.75	99
15+50+50	1.04	3.48	3.48		8.00 (2.9 - 9.0)	2.260 (0.750 - 3.060)	9.93	99
15+50+60	0.96	3.20	3.84		8.00 (2.9 - 9.0)	2.230 (0.750 - 3.060)	9.79	99
15+50+71	0.88	2.94	4.18		8.00 (2.9 - 9.0)	2.210 (0.750 - 3.060)	9.71	99
20+20+20	2.00	2.00	2.00		6.00 (2.9 - 7.5)	1.700 (0.770 - 3.700)	7.47	99
20+20+22	2.00	2.00	2.20		6.20 (2.9 - 7.7)	1.790 (0.750 - 3.330)	7.86	99
20+20+25	2.00	2.00	2.50		6.50 (2.9 - 8.0)	1.810 (0.750 - 2.690)	7.95	99
20+20+35	2.00	2.00	3.50		7.50 (2.9 - 9.0)	2.220 (0.750 - 3.070)	9.75	99
20+20+42	1.88	1.88	3.94		7.70 (2.9 - 9.0)	2.260 (0.760 - 3.050)	9.93	99
20+20+50	1.73	1.73	4.33		7.80 (2.9 - 9.0)	2.280 (0.770 - 3.020)	10.01	99
20+20+60	1.58	1.58	4.74		7.90 (2.9 - 9.0)	2.280 (0.780 - 2.990)	10.01	99
20+20+71	1.44	1.44	5.12		8.00 (2.9 - 9.0)	2.280 (0.780 - 3.090)	10.01	99
20+22+22	2.00	2.20	2.20		6.40 (2.9 - 7.9)	1.770 (0.720 - 2.870)	7.77	99
20+22+25	2.00	2.20	2.50		6.70 (2.9 - 8.2)	1.820 (0.720 - 2.510)	7.99	99
20+22+35	1.97	2.17	3.45		7.60 (2.9 - 9.0)	2.210 (0.720 - 3.030)	9.71	99
20+22+42	1.83	2.02	3.85		7.70 (2.9 - 9.0)	2.220 (0.730 - 3.010)	9.75	99
20+22+50	1.70	1.87	4.24		7.80 (2.9 - 9.0)	2.240 (0.740 - 2.980)	9.84	99
20+22+60	1.55	1.70	4.65		7.90 (2.9 - 9.0)	2.240 (0.750 - 2.950)	9.84	99
20+22+71	1.42	1.56	5.03		8.00 (2.9 - 9.0)	2.240 (0.750 - 3.060)	9.84	99
20+25+25	2.00	2.50	2.50		7.00 (2.9 - 8.5)	1.960 (0.720 - 2.710)	8.61	99
20+25+35	1.93	2.41	3.37		7.70 (2.9 - 9.0)	2.240 (0.730 - 3.020)	9.84	99
20+25+42	1.79	2.24	3.77		7.80 (2.9 - 9.0)	2.250 (0.730 - 3.000)	9.88	99
20+25+50	1.66	2.08	4.16		7.90 (2.9 - 9.0)	2.270 (0.740 - 2.970)	9.97	99
20+25+60	1.51	1.89	4.54		7.95 (2.9 - 9.0)	2.260 (0.750 - 2.940)	9.93	99
20+25+71	1.38	1.72	4.90		8.00 (2.9 - 9.0)	2.240 (0.750 - 3.060)	9.84	99
20+35+35	1.73	3.03	3.03		7.80 (2.9 - 9.0)	2.270 (0.740 - 2.990)	9.97	99
20+35+42	1.63	2.85	3.42		7.90 (2.9 - 9.0)	2.280 (0.740 - 2.970)	10.01	99
20+35+50	1.51	2.65	3.79		7.95 (2.9 - 9.0)	2.290 (0.750 - 2.940)	10.06	99
20+35+60	1.39	2.43	4.17		8.00 (2.9 - 9.0)	2.260 (0.750 - 3.060)	9.93	99

MXZ-4C80VA(VA2) COOLING

Indoor units combination	Cooling capacity (kW)					Outdoor unit power consumption (kW)	Current (A)	Power factor (%)
	Unit A	Unit B	Unit C	Unit D	Total			
20+35+71	1.27	2.22	4.51		8.00 (2.9 - 9.0)	2.240 (0.750 - 3.060)	9.84	99
20+42+42	1.52	3.19	3.19		7.90 (2.9 - 9.0)	2.260 (0.750 - 2.940)	9.93	99
20+42+50	1.43	3.00	3.57		8.00 (2.9 - 9.0)	2.270 (0.750 - 3.060)	9.97	99
20+42+60	1.31	2.75	3.93		8.00 (2.9 - 9.0)	2.240 (0.750 - 3.060)	9.84	99
20+42+71	1.20	2.53	4.27		8.00 (2.9 - 9.0)	2.220 (0.750 - 3.060)	9.75	99
20+50+50	1.33	3.33	3.33		8.00 (2.9 - 9.0)	2.260 (0.750 - 3.060)	9.93	99
20+50+60	1.23	3.08	3.69		8.00 (2.9 - 9.0)	2.230 (0.750 - 3.060)	9.79	99
20+50+71	1.13	2.84	4.03		8.00 (2.9 - 9.0)	2.210 (0.750 - 3.060)	9.71	99
22+22+22	2.20	2.20	2.20		6.60 (2.9 - 8.1)	1.740 (0.690 - 2.410)	7.64	99
22+22+25	2.20	2.20	2.50		6.90 (2.9 - 8.4)	1.870 (0.690 - 2.610)	8.21	99
22+22+35	2.14	2.14	3.41		7.70 (2.9 - 9.0)	2.200 (0.690 - 3.000)	9.66	99
22+22+42	2.00	2.00	3.81		7.80 (2.9 - 9.0)	2.210 (0.700 - 2.970)	9.71	99
22+22+50	1.83	1.83	4.15		7.80 (2.9 - 9.0)	2.200 (0.710 - 2.950)	9.66	99
22+22+60	1.67	1.67	4.56		7.90 (2.9 - 9.0)	2.200 (0.720 - 2.910)	9.66	99
22+22+71	1.53	1.53	4.94		8.00 (2.9 - 9.0)	2.200 (0.720 - 3.030)	9.66	99
22+25+25	2.20	2.50	2.50		7.20 (2.9 - 8.7)	2.010 (0.690 - 2.810)	8.83	99
22+25+35	2.07	2.35	3.29		7.70 (2.9 - 9.0)	2.200 (0.700 - 2.990)	9.66	99
22+25+42	1.93	2.19	3.68		7.80 (2.9 - 9.0)	2.210 (0.700 - 2.960)	9.71	99
22+25+50	1.79	2.04	4.07		7.90 (2.9 - 9.0)	2.230 (0.710 - 2.940)	9.79	99
22+25+60	1.64	1.87	4.49		8.00 (2.9 - 9.0)	2.220 (0.720 - 3.030)	9.75	99
22+25+71	1.49	1.69	4.81		8.00 (2.9 - 9.0)	2.200 (0.720 - 3.030)	9.66	99
22+35+35	1.87	2.97	2.97		7.80 (2.9 - 9.0)	2.230 (0.710 - 2.950)	9.79	99
22+35+42	1.76	2.79	3.35		7.90 (2.9 - 9.0)	2.240 (0.710 - 2.930)	9.84	99
22+35+50	1.64	2.62	3.74		8.00 (2.9 - 9.0)	2.250 (0.720 - 3.030)	9.88	99
22+35+60	1.50	2.39	4.10		8.00 (2.9 - 9.0)	2.220 (0.720 - 3.030)	9.75	99
22+35+71	1.38	2.19	4.44		8.00 (2.9 - 9.0)	2.200 (0.720 - 3.030)	9.66	99
22+42+42	1.66	3.17	3.17		8.00 (2.9 - 9.0)	2.240 (0.720 - 3.030)	9.84	99
22+42+50	1.54	2.95	3.51		8.00 (2.9 - 9.0)	2.230 (0.720 - 3.030)	9.79	99
22+42+60	1.42	2.71	3.87		8.00 (2.9 - 9.0)	2.200 (0.720 - 3.030)	9.66	99
22+42+71	1.30	2.49	4.21		8.00 (2.9 - 9.0)	2.180 (0.720 - 3.030)	9.57	99
22+50+50	1.44	3.28	3.28		8.00 (2.9 - 9.0)	2.220 (0.720 - 3.030)	9.75	99
22+50+60	1.33	3.03	3.64		8.00 (2.9 - 9.0)	2.190 (0.720 - 3.030)	9.62	99
22+50+71	1.23	2.80	3.97		8.00 (2.9 - 9.0)	2.170 (0.720 - 3.030)	9.53	99
25+25+25	2.50	2.50	2.50		7.50 (2.9 - 9.0)	2.140 (0.690 - 3.010)	9.40	99
25+25+35	2.29	2.29	3.21		7.80 (2.9 - 9.0)	2.230 (0.700 - 2.980)	9.79	99
25+25+42	2.12	2.12	3.56		7.80 (2.9 - 9.0)	2.210 (0.710 - 2.950)	9.71	99
25+25+50	1.98	1.98	3.95		7.90 (2.9 - 9.0)	2.230 (0.720 - 2.930)	9.79	99
25+25+60	1.82	1.82	4.36		8.00 (2.9 - 9.0)	2.220 (0.720 - 3.030)	9.75	99
25+25+71	1.65	1.65	4.69		8.00 (2.9 - 9.0)	2.200 (0.720 - 3.030)	9.66	99
25+35+35	2.08	2.91	2.91		7.90 (2.9 - 9.0)	2.260 (0.710 - 2.940)	9.93	99

MXZ-4C80VA(VA2) COOLING

Indoor units combination	Cooling capacity (kW)					Outdoor unit power consumption (kW)	Current (A)	Power factor (%)
	Unit A	Unit B	Unit C	Unit D	Total			
25+35+42	1.94	2.71	3.25		7.90 (2.9 - 9.0)	2.240 (0.720 - 2.920)	9.84	99
25+35+50	1.82	2.55	3.64		8.00 (2.9 - 9.0)	2.250 (0.720 - 3.030)	9.88	99
25+35+60	1.67	2.33	4.00		8.00 (2.9 - 9.0)	2.220 (0.720 - 3.030)	9.75	99
25+35+71	1.53	2.14	4.34		8.00 (2.9 - 9.0)	2.200 (0.720 - 3.030)	9.66	99
25+42+42	1.83	3.08	3.08		8.00 (2.9 - 9.0)	2.240 (0.720 - 3.030)	9.84	99
25+42+50	1.71	2.87	3.42		8.00 (2.9 - 9.0)	2.230 (0.720 - 3.030)	9.79	99
25+42+60	1.57	2.65	3.78		8.00 (2.9 - 9.0)	2.200 (0.720 - 3.030)	9.66	99
25+42+71	1.45	2.43	4.12		8.00 (2.9 - 9.0)	2.180 (0.720 - 3.030)	9.57	99
25+50+50	1.60	3.20	3.20		8.00 (2.9 - 9.0)	2.220 (0.720 - 3.030)	9.75	99
25+50+60	1.48	2.96	3.56		8.00 (2.9 - 9.0)	2.190 (0.720 - 3.030)	9.62	99
35+35+35	2.65	2.65	2.65		7.95 (2.9 - 9.0)	2.280 (0.720 - 2.910)	10.01	99
35+35+42	2.50	2.50	3.00		8.00 (2.9 - 9.0)	2.260 (0.720 - 3.030)	9.93	99
35+35+50	2.33	2.33	3.33		8.00 (2.9 - 9.0)	2.250 (0.720 - 3.030)	9.88	99
35+35+60	2.15	2.15	3.69		8.00 (2.9 - 9.0)	2.220 (0.720 - 3.030)	9.75	99
35+35+71	1.99	1.99	4.03		8.00 (2.9 - 9.0)	2.200 (0.720 - 3.030)	9.66	99
35+42+42	2.35	2.82	2.82		8.00 (2.9 - 9.0)	2.240 (0.720 - 3.030)	9.84	99
35+42+50	2.20	2.65	3.15		8.00 (2.9 - 9.0)	2.230 (0.720 - 3.030)	9.79	99
35+42+60	2.04	2.45	3.50		8.00 (2.9 - 9.0)	2.200 (0.720 - 3.030)	9.66	99
35+50+50	2.07	2.96	2.96		8.00 (2.9 - 9.0)	2.220 (0.720 - 3.030)	9.75	99
35+50+60	1.93	2.76	3.31		8.00 (2.9 - 9.0)	2.190 (0.720 - 3.030)	9.62	99
15+15+15+15	1.50	1.50	1.50	1.50	6.00 (3.7 - 6.4)	1.580 (0.910 - 3.360)	6.94	99
15+15+15+20	1.48	1.48	1.48	1.97	6.40 (3.7 - 6.9)	1.930 (0.930 - 3.610)	8.48	99
15+15+15+22	1.48	1.48	1.48	2.17	6.60 (3.7 - 7.2)	1.980 (0.900 - 3.620)	8.70	99
15+15+15+25	1.46	1.46	1.46	2.43	6.80 (3.7 - 7.4)	2.080 (0.900 - 3.650)	9.13	99
15+15+15+35	1.43	1.43	1.43	3.33	7.60 (3.7 - 8.4)	2.450 (1.000 - 3.820)	10.76	99
15+15+15+42	1.33	1.33	1.33	3.72	7.70 (3.7 - 8.8)	2.250 (0.900 - 3.300)	9.88	99
15+15+15+50	1.24	1.24	1.24	4.13	7.85 (3.7 - 9.2)	2.240 (0.900 - 2.770)	9.84	99
15+15+15+60	1.14	1.14	1.14	4.54	7.95 (3.7 - 9.2)	2.220 (0.900 - 2.750)	9.75	99
15+15+15+71	1.03	1.03	1.03	4.90	8.00 (3.7 - 9.2)	2.210 (0.900 - 2.710)	9.71	99
15+15+20+20	1.46	1.46	1.94	1.94	6.80 (3.7 - 7.4)	2.120 (0.930 - 3.690)	9.31	99
15+15+20+22	1.46	1.46	1.94	2.14	7.00 (3.7 - 7.7)	2.170 (0.900 - 3.700)	9.53	99
15+15+20+25	1.44	1.44	1.92	2.40	7.20 (3.7 - 7.9)	2.260 (0.900 - 3.740)	9.93	99
15+15+20+35	1.36	1.36	1.81	3.17	7.70 (3.7 - 8.8)	2.270 (0.900 - 3.310)	9.97	99
15+15+20+42	1.28	1.28	1.71	3.58	7.85 (3.7 - 9.2)	2.250 (0.900 - 2.780)	9.88	99
15+15+20+50	1.19	1.19	1.58	3.96	7.92 (3.7 - 9.2)	2.240 (0.900 - 2.770)	9.84	99
15+15+20+60	1.09	1.09	1.45	4.36	8.00 (3.7 - 9.2)	2.230 (0.900 - 2.740)	9.79	99
15+15+20+71	0.99	0.99	1.32	4.69	8.00 (3.7 - 9.2)	2.210 (0.900 - 2.700)	9.71	99
15+15+22+22	1.44	1.44	2.11	2.11	7.10 (3.7 - 7.8)	2.180 (0.870 - 3.680)	9.57	99
15+15+22+25	1.44	1.44	2.11	2.40	7.40 (3.7 - 8.2)	2.320 (0.870 - 3.750)	10.19	99
15+15+22+35	1.33	1.33	1.95	3.10	7.70 (3.7 - 8.8)	2.230 (0.870 - 3.270)	9.79	99

MXZ-4C80VA(VA2) COOLING

Indoor units combination	Cooling capacity (kW)					Outdoor unit power consumption (kW)	Current (A)	Power factor (%)
	Unit A	Unit B	Unit C	Unit D	Total			
15+15+22+42	1.25	1.25	1.84	3.51	7.85 (3.7 - 9.2)	2.210 (0.870 - 2.740)	9.71	99
15+15+22+50	1.17	1.17	1.71	3.90	7.95 (3.7 - 9.2)	2.210 (0.870 - 2.730)	9.71	99
15+15+22+60	1.07	1.07	1.57	4.29	8.00 (3.7 - 9.2)	2.190 (0.870 - 2.690)	9.62	99
15+15+22+71	0.98	0.98	1.43	4.62	8.00 (3.7 - 9.2)	2.170 (0.870 - 2.660)	9.53	99
15+15+25+25	1.43	1.43	2.38	2.38	7.60 (3.7 - 8.4)	2.410 (0.970 - 3.780)	10.58	99
15+15+25+35	1.30	1.30	2.17	3.03	7.80 (3.7 - 9.2)	2.230 (0.870 - 2.750)	9.79	99
15+15+25+42	1.22	1.22	2.04	3.42	7.90 (3.7 - 9.2)	2.210 (0.870 - 2.740)	9.71	99
15+15+25+50	1.14	1.14	1.89	3.79	7.95 (3.7 - 9.2)	2.210 (0.870 - 2.720)	9.71	99
15+15+25+60	1.04	1.04	1.74	4.17	8.00 (3.7 - 9.2)	2.190 (0.870 - 2.690)	9.62	99
15+15+25+71	0.95	0.95	1.59	4.51	8.00 (3.7 - 9.2)	2.170 (0.870 - 2.650)	9.53	99
15+15+35+35	1.19	1.19	2.77	2.77	7.92 (3.7 - 9.2)	2.230 (0.870 - 2.750)	9.79	99
15+15+35+42	1.11	1.11	2.60	3.12	7.95 (3.7 - 9.2)	2.220 (0.870 - 2.720)	9.75	99
15+15+35+50	1.04	1.04	2.43	3.48	8.00 (3.7 - 9.2)	2.220 (0.870 - 2.700)	9.75	99
15+15+35+60	0.96	0.96	2.24	3.84	8.00 (3.7 - 9.2)	2.190 (0.870 - 2.660)	9.62	99
15+15+35+71	0.88	0.88	2.06	4.18	8.00 (3.7 - 9.2)	2.170 (0.870 - 2.630)	9.53	99
15+15+42+42	1.05	1.05	2.95	2.95	8.00 (3.7 - 9.2)	2.210 (0.870 - 2.700)	9.71	99
15+15+42+50	0.98	0.98	2.75	3.28	8.00 (3.7 - 9.2)	2.200 (0.870 - 2.670)	9.66	99
15+15+42+60	0.91	0.91	2.55	3.64	8.00 (3.7 - 9.2)	2.170 (0.870 - 2.640)	9.53	99
15+15+42+71	0.84	0.84	2.35	3.97	8.00 (3.7 - 9.2)	2.150 (0.870 - 2.610)	9.44	99
15+15+50+50	0.92	0.92	3.08	3.08	8.00 (3.7 - 9.2)	2.190 (0.870 - 2.640)	9.62	99
15+15+50+60	0.86	0.86	2.86	3.43	8.00 (3.7 - 9.2)	2.160 (0.870 - 2.610)	9.49	99
15+20+20+20	1.44	1.92	1.92	1.92	7.20 (3.7 - 7.9)	2.300 (0.930 - 3.780)	10.10	99
15+20+20+22	1.44	1.92	1.92	2.11	7.40 (3.7 - 8.2)	2.360 (0.900 - 3.790)	10.36	99
15+20+20+25	1.43	1.90	1.90	2.38	7.60 (3.7 - 8.4)	2.450 (1.000 - 3.820)	10.76	99
15+20+20+35	1.30	1.73	1.73	3.03	7.80 (3.7 - 9.2)	2.270 (0.900 - 2.790)	9.97	99
15+20+20+42	1.22	1.63	1.63	3.42	7.90 (3.7 - 9.2)	2.250 (0.900 - 2.780)	9.88	99
15+20+20+50	1.14	1.51	1.51	3.79	7.95 (3.7 - 9.2)	2.250 (0.900 - 2.760)	9.88	99
15+20+20+60	1.04	1.39	1.39	4.17	8.00 (3.7 - 9.2)	2.230 (0.900 - 2.730)	9.79	99
15+20+20+71	0.95	1.27	1.27	4.51	8.00 (3.7 - 9.2)	2.210 (0.900 - 2.690)	9.71	99
15+20+22+22	1.42	1.90	2.09	2.09	7.50 (3.7 - 8.3)	2.360 (0.870 - 3.760)	10.36	99
15+20+22+25	1.39	1.85	2.04	2.32	7.60 (3.7 - 8.4)	2.230 (0.870 - 3.780)	9.79	99
15+20+22+35	1.28	1.71	1.88	2.99	7.85 (3.7 - 9.2)	2.230 (0.870 - 2.750)	9.79	99
15+20+22+42	1.20	1.60	1.76	3.35	7.90 (3.7 - 9.2)	2.210 (0.870 - 2.740)	9.71	99
15+20+22+50	1.11	1.49	1.63	3.71	7.95 (3.7 - 9.2)	2.210 (0.870 - 2.710)	9.71	99
15+20+22+60	1.03	1.37	1.50	4.10	8.00 (3.7 - 9.2)	2.190 (0.870 - 2.680)	9.62	99
15+20+22+71	0.94	1.25	1.38	4.44	8.00 (3.7 - 9.2)	2.170 (0.870 - 2.650)	9.53	99
15+20+25+25	1.36	1.81	2.26	2.26	7.70 (3.7 - 8.8)	2.230 (0.870 - 3.270)	9.79	99
15+20+25+35	1.24	1.65	2.07	2.89	7.85 (3.7 - 9.2)	2.230 (0.870 - 2.750)	9.79	99
15+20+25+42	1.17	1.56	1.95	3.27	7.95 (3.7 - 9.2)	2.220 (0.870 - 2.740)	9.75	99
15+20+25+50	1.09	1.45	1.82	3.64	8.00 (3.7 - 9.2)	2.220 (0.870 - 2.710)	9.75	99

MXZ-4C80VA(VA2) COOLING

Indoor units combination	Cooling capacity (kW)					Outdoor unit power consumption (kW)	Current (A)	Power factor (%)
	Unit A	Unit B	Unit C	Unit D	Total			
15+20+25+60	1.00	1.33	1.67	4.00	8.00 (3.7 - 9.2)	2.190 (0.870 - 2.680)	9.62	99
15+20+25+71	0.92	1.22	1.53	4.34	8.00 (3.7 - 9.2)	2.170 (0.870 - 2.640)	9.53	99
15+20+35+35	1.14	1.51	2.65	2.65	7.95 (3.7 - 9.2)	2.240 (0.870 - 2.740)	9.84	99
15+20+35+42	1.07	1.43	2.50	3.00	8.00 (3.7 - 9.2)	2.230 (0.870 - 2.710)	9.79	99
15+20+35+50	1.00	1.33	2.33	3.33	8.00 (3.7 - 9.2)	2.220 (0.870 - 2.690)	9.75	99
15+20+35+60	0.92	1.23	2.15	3.69	8.00 (3.7 - 9.2)	2.190 (0.870 - 2.650)	9.62	99
15+20+35+71	0.85	1.13	1.99	4.03	8.00 (3.7 - 9.2)	2.170 (0.870 - 2.620)	9.53	99
15+20+42+42	1.01	1.34	2.82	2.82	8.00 (3.7 - 9.2)	2.210 (0.870 - 2.690)	9.71	99
15+20+42+50	0.94	1.26	2.65	3.15	8.00 (3.7 - 9.2)	2.200 (0.870 - 2.660)	9.66	99
15+20+42+60	0.88	1.17	2.45	3.50	8.00 (3.7 - 9.2)	2.170 (0.870 - 2.630)	9.53	99
15+20+50+50	0.89	1.19	2.96	2.96	8.00 (3.7 - 9.2)	2.190 (0.870 - 2.630)	9.62	99
15+20+50+60	0.83	1.10	2.76	3.31	8.00 (3.7 - 9.2)	2.160 (0.870 - 2.610)	9.49	99
15+22+22+22	1.41	2.06	2.06	2.06	7.60 (3.7 - 8.4)	2.190 (0.840 - 3.740)	9.62	99
15+22+22+25	1.38	2.02	2.02	2.29	7.70 (3.7 - 8.8)	2.190 (0.840 - 3.230)	9.62	99
15+22+22+35	1.25	1.84	1.84	2.92	7.85 (3.7 - 9.2)	2.190 (0.840 - 2.710)	9.62	99
15+22+22+42	1.18	1.73	1.73	3.31	7.95 (3.7 - 9.2)	2.180 (0.840 - 2.700)	9.57	99
15+22+22+50	1.10	1.61	1.61	3.67	8.00 (3.7 - 9.2)	2.180 (0.840 - 2.670)	9.57	99
15+22+22+60	1.01	1.48	1.48	4.03	8.00 (3.7 - 9.2)	2.150 (0.840 - 2.640)	9.44	99
15+22+22+71	0.92	1.35	1.35	4.37	8.00 (3.7 - 9.2)	2.130 (0.840 - 2.600)	9.35	99
15+22+25+25	1.33	1.95	2.21	2.21	7.70 (3.7 - 8.8)	2.190 (0.840 - 3.230)	9.62	99
15+22+25+35	1.22	1.79	2.04	2.85	7.90 (3.7 - 9.2)	2.190 (0.840 - 2.710)	9.62	99
15+22+25+42	1.15	1.68	1.91	3.21	7.95 (3.7 - 9.2)	2.180 (0.840 - 2.690)	9.57	99
15+22+25+50	1.07	1.57	1.79	3.57	8.00 (3.7 - 9.2)	2.180 (0.840 - 2.660)	9.57	99
15+22+25+60	0.98	1.44	1.64	3.93	8.00 (3.7 - 9.2)	2.150 (0.840 - 2.630)	9.44	99
15+22+25+71	0.90	1.32	1.50	4.27	8.00 (3.7 - 9.2)	2.130 (0.840 - 2.600)	9.35	99
15+22+35+35	1.11	1.63	2.60	2.60	7.95 (3.7 - 9.2)	2.200 (0.840 - 2.690)	9.66	99
15+22+35+42	1.05	1.54	2.46	2.95	8.00 (3.7 - 9.2)	2.190 (0.840 - 2.670)	9.62	99
15+22+35+50	0.98	1.44	2.30	3.28	8.00 (3.7 - 9.2)	2.180 (0.840 - 2.640)	9.57	99
15+22+35+60	0.91	1.33	2.12	3.64	8.00 (3.7 - 9.2)	2.150 (0.840 - 2.610)	9.44	99
15+22+35+71	0.84	1.23	1.96	3.97	8.00 (3.7 - 9.2)	2.130 (0.840 - 2.580)	9.35	99
15+22+42+42	0.99	1.45	2.78	2.78	8.00 (3.7 - 9.2)	2.170 (0.840 - 2.640)	9.53	99
15+22+42+50	0.93	1.36	2.60	3.10	8.00 (3.7 - 9.2)	2.160 (0.840 - 2.610)	9.49	99
15+22+42+60	0.86	1.27	2.42	3.45	8.00 (3.7 - 9.2)	2.130 (0.840 - 2.580)	9.35	99
15+22+50+50	0.88	1.28	2.92	2.92	8.00 (3.7 - 9.2)	2.150 (0.840 - 2.590)	9.44	99
15+25+25+25	1.30	2.17	2.17	2.17	7.80 (3.7 - 9.2)	2.190 (0.840 - 2.710)	9.62	99
15+25+25+35	1.19	1.98	1.98	2.77	7.92 (3.7 - 9.2)	2.190 (0.840 - 2.710)	9.62	99
15+25+25+42	1.11	1.86	1.86	3.12	7.95 (3.7 - 9.2)	2.180 (0.840 - 2.680)	9.57	99
15+25+25+50	1.04	1.74	1.74	3.48	8.00 (3.7 - 9.2)	2.180 (0.840 - 2.660)	9.57	99
15+25+25+60	0.96	1.60	1.60	3.84	8.00 (3.7 - 9.2)	2.150 (0.840 - 2.620)	9.44	99
15+25+25+71	0.88	1.47	1.47	4.18	8.00 (3.7 - 9.2)	2.130 (0.840 - 2.590)	9.35	99

MXZ-4C80VA(VA2) COOLING

Indoor units combination	Cooling capacity (kW)					Outdoor unit power consumption (kW)	Current (A)	Power factor (%)
	Unit A	Unit B	Unit C	Unit D	Total			
15+25+35+35	1.09	1.82	2.55	2.55	8.00 (3.7 - 9.2)	2.210 (0.840 - 2.690)	9.71	99
15+25+35+42	1.03	1.71	2.39	2.87	8.00 (3.7 - 9.2)	2.190 (0.840 - 2.660)	9.62	99
15+25+35+50	0.96	1.60	2.24	3.20	8.00 (3.7 - 9.2)	2.180 (0.840 - 2.630)	9.57	99
15+25+35+60	0.89	1.48	2.07	3.56	8.00 (3.7 - 9.2)	2.150 (0.840 - 2.600)	9.44	99
15+25+42+42	0.97	1.61	2.71	2.71	8.00 (3.7 - 9.2)	2.170 (0.840 - 2.640)	9.53	99
15+25+42+50	0.91	1.52	2.55	3.03	8.00 (3.7 - 9.2)	2.160 (0.840 - 2.610)	9.49	99
15+25+42+60	0.85	1.41	2.37	3.38	8.00 (3.7 - 9.2)	2.130 (0.840 - 2.580)	9.35	99
15+25+50+50	0.86	1.43	2.86	2.86	8.00 (3.7 - 9.2)	2.150 (0.840 - 2.580)	9.44	99
15+35+35+35	1.00	2.33	2.33	2.33	8.00 (3.7 - 9.2)	2.210 (0.840 - 2.670)	9.71	99
15+35+35+42	0.94	2.20	2.20	2.65	8.00 (3.7 - 9.2)	2.190 (0.840 - 2.640)	9.62	99
15+35+35+50	0.89	2.07	2.07	2.96	8.00 (3.7 - 9.2)	2.180 (0.840 - 2.610)	9.57	99
15+35+35+60	0.83	1.93	1.93	3.31	8.00 (3.7 - 9.2)	2.150 (0.840 - 2.590)	9.44	99
15+35+42+42	0.90	2.09	2.51	2.51	8.00 (3.7 - 9.2)	2.170 (0.840 - 2.610)	9.53	99
15+35+42+50	0.85	1.97	2.37	2.82	8.00 (3.7 - 9.2)	2.160 (0.840 - 2.590)	9.49	99
15+42+42+42	0.85	2.38	2.38	2.38	8.00 (3.7 - 9.2)	2.150 (0.840 - 2.590)	9.44	99
20+20+20+20	1.90	1.90	1.90	1.90	7.60 (3.7 - 8.4)	2.330 (0.910 - 3.700)	10.23	99
20+20+20+22	1.85	1.85	1.85	2.04	7.60 (3.7 - 8.4)	2.270 (0.900 - 3.820)	9.97	99
20+20+20+25	1.81	1.81	1.81	2.26	7.70 (3.7 - 8.8)	2.270 (0.900 - 3.310)	9.97	99
20+20+20+35	1.65	1.65	1.65	2.89	7.85 (3.7 - 9.2)	2.270 (0.900 - 2.790)	9.97	99
20+20+20+42	1.56	1.56	1.56	3.27	7.95 (3.7 - 9.2)	2.260 (0.900 - 2.780)	9.93	99
20+20+20+50	1.45	1.45	1.45	3.64	8.00 (3.7 - 9.2)	2.260 (0.900 - 2.750)	9.93	99
20+20+20+60	1.33	1.33	1.33	4.00	8.00 (3.7 - 9.2)	2.230 (0.900 - 2.720)	9.79	99
20+20+20+71	1.22	1.22	1.22	4.34	8.00 (3.7 - 9.2)	2.210 (0.900 - 2.680)	9.71	99
20+20+22+22	1.83	1.83	2.02	2.02	7.70 (3.7 - 8.8)	2.230 (0.870 - 3.270)	9.79	99
20+20+22+25	1.77	1.77	1.95	2.21	7.70 (3.7 - 8.8)	2.230 (0.870 - 3.270)	9.79	99
20+20+22+35	1.63	1.63	1.79	2.85	7.90 (3.7 - 9.2)	2.230 (0.870 - 2.750)	9.79	99
20+20+22+42	1.53	1.53	1.68	3.21	7.95 (3.7 - 9.2)	2.220 (0.870 - 2.730)	9.75	99
20+20+22+50	1.43	1.43	1.57	3.57	8.00 (3.7 - 9.2)	2.220 (0.870 - 2.700)	9.75	99
20+20+22+60	1.31	1.31	1.44	3.93	8.00 (3.7 - 9.2)	2.190 (0.870 - 2.670)	9.62	99
20+20+22+71	1.20	1.20	1.32	4.27	8.00 (3.7 - 9.2)	2.170 (0.870 - 2.640)	9.53	99
20+20+25+25	1.73	1.73	2.17	2.17	7.80 (3.7 - 9.2)	2.230 (0.870 - 2.750)	9.79	99
20+20+25+35	1.58	1.58	1.98	2.77	7.92 (3.7 - 9.2)	2.230 (0.870 - 2.750)	9.79	99
20+20+25+42	1.49	1.49	1.86	3.12	7.95 (3.7 - 9.2)	2.220 (0.870 - 2.720)	9.75	99
20+20+25+50	1.39	1.39	1.74	3.48	8.00 (3.7 - 9.2)	2.220 (0.870 - 2.700)	9.75	99
20+20+25+60	1.28	1.28	1.60	3.84	8.00 (3.7 - 9.2)	2.190 (0.870 - 2.660)	9.62	99
20+20+25+71	1.18	1.18	1.47	4.18	8.00 (3.7 - 9.2)	2.170 (0.870 - 2.630)	9.53	99
20+20+35+35	1.45	1.45	2.55	2.55	8.00 (3.7 - 9.2)	2.250 (0.870 - 2.730)	9.88	99
20+20+35+42	1.37	1.37	2.39	2.87	8.00 (3.7 - 9.2)	2.230 (0.870 - 2.700)	9.79	99
20+20+35+50	1.28	1.28	2.24	3.20	8.00 (3.7 - 9.2)	2.220 (0.870 - 2.670)	9.75	99
20+20+35+60	1.19	1.19	2.07	3.56	8.00 (3.7 - 9.2)	2.190 (0.870 - 2.640)	9.62	99

MXZ-4C80VA(VA2) COOLING

Indoor units combination	Cooling capacity (kW)					Outdoor unit power consumption (kW)	Current (A)	Power factor (%)
	Unit A	Unit B	Unit C	Unit D	Total			
20+20+42+42	1.29	1.29	2.71	2.71	8.00 (3.7 - 9.2)	2.210 (0.870 - 2.680)	9.71	99
20+20+42+50	1.21	1.21	2.55	3.03	8.00 (3.7 - 9.2)	2.200 (0.870 - 2.650)	9.66	99
20+20+42+60	1.13	1.13	2.37	3.38	8.00 (3.7 - 9.2)	2.170 (0.870 - 2.620)	9.53	99
20+20+50+50	1.14	1.14	2.86	2.86	8.00 (3.7 - 9.2)	2.190 (0.870 - 2.620)	9.62	99
20+22+22+22	1.79	1.97	1.97	1.97	7.70 (3.7 - 8.8)	2.190 (0.840 - 3.230)	9.62	99
20+22+22+25	1.75	1.93	1.93	2.19	7.80 (3.7 - 9.2)	2.190 (0.840 - 2.710)	9.62	99
20+22+22+35	1.60	1.76	1.76	2.79	7.90 (3.7 - 9.2)	2.190 (0.840 - 2.710)	9.62	99
20+22+22+42	1.50	1.65	1.65	3.15	7.95 (3.7 - 9.2)	2.180 (0.840 - 2.690)	9.57	99
20+22+22+50	1.40	1.54	1.54	3.51	8.00 (3.7 - 9.2)	2.180 (0.840 - 2.660)	9.57	99
20+22+22+60	1.29	1.42	1.42	3.87	8.00 (3.7 - 9.2)	2.150 (0.840 - 2.630)	9.44	99
20+22+22+71	1.19	1.30	1.30	4.21	8.00 (3.7 - 9.2)	2.130 (0.840 - 2.590)	9.35	99
20+22+25+25	1.71	1.88	2.13	2.13	7.85 (3.7 - 9.2)	2.190 (0.840 - 2.710)	9.62	99
20+22+25+35	1.56	1.71	1.95	2.73	7.95 (3.7 - 9.2)	2.200 (0.840 - 2.710)	9.66	99
20+22+25+42	1.47	1.61	1.83	3.08	8.00 (3.7 - 9.2)	2.190 (0.840 - 2.680)	9.62	99
20+22+25+50	1.37	1.50	1.71	3.42	8.00 (3.7 - 9.2)	2.180 (0.840 - 2.650)	9.57	99
20+22+25+60	1.26	1.39	1.57	3.78	8.00 (3.7 - 9.2)	2.150 (0.840 - 2.620)	9.44	99
20+22+25+71	1.16	1.28	1.45	4.12	8.00 (3.7 - 9.2)	2.130 (0.840 - 2.580)	9.35	99
20+22+35+35	1.43	1.57	2.50	2.50	8.00 (3.7 - 9.2)	2.210 (0.840 - 2.680)	9.71	99
20+22+35+42	1.34	1.48	2.35	2.82	8.00 (3.7 - 9.2)	2.190 (0.840 - 2.660)	9.62	99
20+22+35+50	1.26	1.39	2.20	3.15	8.00 (3.7 - 9.2)	2.180 (0.840 - 2.630)	9.57	99
20+22+35+60	1.17	1.28	2.04	3.50	8.00 (3.7 - 9.2)	2.150 (0.840 - 2.600)	9.44	99
20+22+42+42	1.27	1.40	2.67	2.67	8.00 (3.7 - 9.2)	2.170 (0.840 - 2.630)	9.53	99
20+22+42+50	1.19	1.31	2.51	2.99	8.00 (3.7 - 9.2)	2.160 (0.840 - 2.600)	9.49	99
20+22+42+60	1.11	1.22	2.33	3.33	8.00 (3.7 - 9.2)	2.130 (0.840 - 2.580)	9.35	99
20+22+50+50	1.13	1.24	2.82	2.82	8.00 (3.7 - 9.2)	2.150 (0.840 - 2.580)	9.44	99
20+25+25+25	1.65	2.07	2.07	2.07	7.85 (3.7 - 9.2)	2.190 (0.840 - 2.710)	9.62	99
20+25+25+35	1.51	1.89	1.89	2.65	7.95 (3.7 - 9.2)	2.200 (0.840 - 2.700)	9.66	99
20+25+25+42	1.43	1.79	1.79	3.00	8.00 (3.7 - 9.2)	2.190 (0.840 - 2.670)	9.62	99
20+25+25+50	1.33	1.67	1.67	3.33	8.00 (3.7 - 9.2)	2.180 (0.840 - 2.650)	9.57	99
20+25+25+60	1.23	1.54	1.54	3.69	8.00 (3.7 - 9.2)	2.150 (0.840 - 2.610)	9.44	99
20+25+25+71	1.13	1.42	1.42	4.03	8.00 (3.7 - 9.2)	2.130 (0.840 - 2.580)	9.35	99
20+25+35+35	1.39	1.74	2.43	2.43	8.00 (3.7 - 9.2)	2.210 (0.840 - 2.680)	9.71	99
20+25+35+42	1.31	1.64	2.30	2.75	8.00 (3.7 - 9.2)	2.190 (0.840 - 2.650)	9.62	99
20+25+35+50	1.23	1.54	2.15	3.08	8.00 (3.7 - 9.2)	2.180 (0.840 - 2.620)	9.57	99
20+25+35+60	1.14	1.43	2.00	3.43	8.00 (3.7 - 9.2)	2.150 (0.840 - 2.590)	9.44	99
20+25+42+42	1.24	1.55	2.60	2.60	8.00 (3.7 - 9.2)	2.170 (0.840 - 2.620)	9.53	99
20+25+42+50	1.17	1.46	2.45	2.92	8.00 (3.7 - 9.2)	2.160 (0.840 - 2.600)	9.49	99
20+25+50+50	1.10	1.38	2.76	2.76	8.00 (3.7 - 9.2)	2.150 (0.840 - 2.580)	9.44	99
20+35+35+35	1.28	2.24	2.24	2.24	8.00 (3.7 - 9.2)	2.210 (0.840 - 2.650)	9.71	99
20+35+35+42	1.21	2.12	2.12	2.55	8.00 (3.7 - 9.2)	2.190 (0.840 - 2.630)	9.62	99

MXZ-4C80VA(VA2) COOLING

Indoor units combination	Cooling capacity (kW)					Outdoor unit power consumption (kW)	Current (A)	Power factor (%)
	Unit A	Unit B	Unit C	Unit D	Total			
20+35+35+50	1.14	2.00	2.00	2.86	8.00 (3.7 - 9.2)	2.180 (0.840 - 2.600)	9.57	99
20+35+42+42	1.15	2.01	2.42	2.42	8.00 (3.7 - 9.2)	2.170 (0.840 - 2.600)	9.53	99
22+22+22+22	1.95	1.95	1.95	1.95	7.80 (3.7 - 9.2)	2.150 (0.810 - 2.670)	9.44	99
22+22+22+25	1.90	1.90	1.90	2.16	7.85 (3.7 - 9.2)	2.150 (0.810 - 2.670)	9.44	99
22+22+22+35	1.73	1.73	1.73	2.75	7.95 (3.7 - 9.2)	2.160 (0.810 - 2.670)	9.49	99
22+22+22+42	1.63	1.63	1.63	3.11	8.00 (3.7 - 9.2)	2.150 (0.810 - 2.640)	9.44	99
22+22+22+50	1.52	1.52	1.52	3.45	8.00 (3.7 - 9.2)	2.140 (0.810 - 2.610)	9.40	99
22+22+22+60	1.40	1.40	1.40	3.81	8.00 (3.7 - 9.2)	2.110 (0.810 - 2.580)	9.27	99
22+22+22+71	1.28	1.28	1.28	4.15	8.00 (3.7 - 9.2)	2.090 (0.810 - 2.550)	9.18	99
22+22+25+25	1.84	1.84	2.09	2.09	7.85 (3.7 - 9.2)	2.150 (0.810 - 2.670)	9.44	99
22+22+25+35	1.68	1.68	1.91	2.68	7.95 (3.7 - 9.2)	2.160 (0.810 - 2.660)	9.49	99
22+22+25+42	1.59	1.59	1.80	3.03	8.00 (3.7 - 9.2)	2.150 (0.810 - 2.640)	9.44	99
22+22+25+50	1.48	1.48	1.68	3.36	8.00 (3.7 - 9.2)	2.140 (0.810 - 2.610)	9.40	99
22+22+25+60	1.36	1.36	1.55	3.72	8.00 (3.7 - 9.2)	2.110 (0.810 - 2.570)	9.27	99
22+22+25+71	1.26	1.26	1.43	4.06	8.00 (3.7 - 9.2)	2.090 (0.810 - 2.540)	9.18	99
22+22+35+35	1.54	1.54	2.46	2.46	8.00 (3.7 - 9.2)	2.170 (0.810 - 2.640)	9.53	99
22+22+35+42	1.45	1.45	2.31	2.78	8.00 (3.7 - 9.2)	2.150 (0.810 - 2.610)	9.44	99
22+22+35+50	1.36	1.36	2.17	3.10	8.00 (3.7 - 9.2)	2.140 (0.810 - 2.580)	9.40	99
22+22+35+60	1.27	1.27	2.01	3.45	8.00 (3.7 - 9.2)	2.110 (0.810 - 2.550)	9.27	99
22+22+42+42	1.38	1.38	2.63	2.63	8.00 (3.7 - 9.2)	2.130 (0.810 - 2.590)	9.35	99
22+22+42+50	1.29	1.29	2.47	2.94	8.00 (3.7 - 9.2)	2.120 (0.810 - 2.560)	9.31	99
22+22+50+50	1.22	1.22	2.78	2.78	8.00 (3.7 - 9.2)	2.110 (0.810 - 2.540)	9.27	99
22+25+25+25	1.79	2.04	2.04	2.04	7.90 (3.7 - 9.2)	2.150 (0.810 - 2.670)	9.44	99
22+25+25+35	1.63	1.86	1.86	2.60	7.95 (3.7 - 9.2)	2.160 (0.810 - 2.650)	9.49	99
22+25+25+42	1.54	1.75	1.75	2.95	8.00 (3.7 - 9.2)	2.150 (0.810 - 2.630)	9.44	99
22+25+25+50	1.44	1.64	1.64	3.28	8.00 (3.7 - 9.2)	2.140 (0.810 - 2.600)	9.40	99
22+25+25+60	1.33	1.52	1.52	3.64	8.00 (3.7 - 9.2)	2.110 (0.810 - 2.570)	9.27	99
22+25+35+35	1.50	1.71	2.39	2.39	8.00 (3.7 - 9.2)	2.170 (0.810 - 2.630)	9.53	99
22+25+35+42	1.42	1.61	2.26	2.71	8.00 (3.7 - 9.2)	2.150 (0.810 - 2.610)	9.44	99
22+25+35+50	1.33	1.52	2.12	3.03	8.00 (3.7 - 9.2)	2.140 (0.810 - 2.580)	9.40	99
22+25+35+60	1.24	1.41	1.97	3.38	8.00 (3.7 - 9.2)	2.110 (0.810 - 2.550)	9.27	99
22+35+35+35	1.39	2.20	2.20	2.20	8.00 (3.7 - 9.2)	2.170 (0.810 - 2.610)	9.53	99
22+35+35+42	1.31	2.09	2.09	2.51	8.00 (3.7 - 9.2)	2.150 (0.810 - 2.580)	9.44	99
22+35+35+50	1.24	1.97	1.97	2.82	8.00 (3.7 - 9.2)	2.140 (0.810 - 2.560)	9.40	99
22+35+42+42	1.25	1.99	2.38	2.38	8.00 (3.7 - 9.2)	2.130 (0.810 - 2.560)	9.35	99
25+25+25+25	1.98	1.98	1.98	1.98	7.92 (3.7 - 9.2)	2.150 (0.810 - 2.670)	9.44	99
25+25+25+35	1.82	1.82	1.82	2.55	8.00 (3.7 - 9.2)	2.170 (0.810 - 2.650)	9.53	99
25+25+25+42	1.71	1.71	1.71	2.87	8.00 (3.7 - 9.2)	2.150 (0.810 - 2.620)	9.44	99
25+25+25+50	1.60	1.60	1.60	3.20	8.00 (3.7 - 9.2)	2.140 (0.810 - 2.590)	9.40	99
25+25+25+60	1.48	1.48	1.48	3.56	8.00 (3.7 - 9.2)	2.110 (0.810 - 2.560)	9.27	99

MXZ-4C80VA(VA2) COOLING

Indoor units combination	Cooling capacity (kW)					Outdoor unit power consumption (kW)	Current (A)	Power factor (%)
	Unit A	Unit B	Unit C	Unit D	Total			
25+25+35+35	1.67	1.67	2.33	2.33	8.00 (3.7 - 9.2)	2.170 (0.810 - 2.630)	9.53	99
25+25+35+42	1.57	1.57	2.20	2.65	8.00 (3.7 - 9.2)	2.150 (0.810 - 2.600)	9.44	99
25+25+35+50	1.48	1.48	2.07	2.96	8.00 (3.7 - 9.2)	2.140 (0.810 - 2.570)	9.40	99
25+35+35+35	1.54	2.15	2.15	2.15	8.00 (3.7 - 9.2)	2.170 (0.810 - 2.600)	9.53	99
25+35+35+42	1.46	2.04	2.04	2.45	8.00 (3.7 - 9.2)	2.150 (0.810 - 2.580)	9.44	99
35+35+35+35	2.00	2.00	2.00	2.00	8.00 (3.7 - 9.2)	2.170 (0.810 - 2.580)	9.53	99

MXZ-4C80VA(VA2) HEATING

Indoor units combination	Heating capacity (kW)				Outdoor unit power consumption(kW)	Current (A)	Power factor (%)
	Unit A	Unit B	Unit C	Unit D			
15	1.70				1.70 (1.2 - 3.0)	0.59 (0.56 - 1.67)	2.59 99
20	2.20				2.20 (1.2 - 3.9)	0.76 (0.56 - 2.17)	3.34 99
22	3.30				3.30 (1.2 - 4.2)	0.86 (0.34 - 1.38)	3.78 99
25	3.60				3.60 (1.2 - 4.5)	0.96 (0.34 - 1.51)	4.22 99
35	4.00				4.00 (1.2 - 5.5)	1.11 (0.33 - 1.57)	4.87 99
42	5.40				5.40 (1.3 - 6.5)	1.58 (0.33 - 2.14)	6.94 99
50	7.20				7.20 (1.4 - 7.7)	2.27 (0.33 - 2.71)	9.97 99
60	7.90				7.90 (1.4 - 8.6)	2.27 (0.33 - 3.06)	9.97 99
71	8.60				8.60 (1.6 - 9.2)	2.43 (0.36 - 3.52)	10.67 99
15+15	1.70	1.70			3.40 (1.8 - 5.0)	0.86 (0.62 - 2.78)	3.78 99
15+20	1.67	2.23			3.90 (1.8 - 5.8)	1.01 (0.62 - 3.23)	4.44 99
15+22	1.66	2.44			4.10 (1.8 - 6.1)	1.07 (0.55 - 3.39)	4.70 99
15+25	1.65	2.75			4.40 (1.8 - 6.6)	1.16 (0.69 - 3.67)	5.09 99
15+35	2.16	5.04			7.20 (1.8 - 8.8)	1.76 (0.55 - 3.14)	7.73 99
15+42	1.97	5.53			7.50 (1.8 - 9.3)	1.89 (0.55 - 3.20)	8.30 99
15+50	1.80	6.00			7.80 (1.8 - 9.7)	2.00 (0.55 - 3.23)	8.78 99
15+60	1.72	6.88			8.60 (1.8 - 10.3)	2.27 (0.55 - 3.25)	9.97 99
15+71	1.64	7.76			9.40 (1.8 - 9.5)	2.53 (0.53 - 3.27)	11.11 99
20+20	2.20	2.20			4.40 (1.8 - 6.6)	1.16 (0.62 - 3.67)	5.09 99
20+22	2.62	2.88			5.50 (1.8 - 6.9)	1.37 (0.55 - 3.22)	6.02 99
20+25	2.98	3.72			6.70 (1.8 - 7.5)	1.60 (0.55 - 2.83)	7.03 99
20+35	2.69	4.71			7.40 (1.8 - 9.2)	1.85 (0.55 - 3.19)	8.12 99
20+42	2.48	5.22			7.70 (1.8 - 9.6)	1.96 (0.55 - 3.23)	8.61 99
20+50	2.29	5.71			8.00 (1.8 - 9.8)	2.06 (0.55 - 3.23)	9.05 99
20+60	2.30	6.90			9.20 (1.8 - 10.7)	2.48 (0.55 - 3.26)	10.89 99
20+71	2.07	7.33			9.40 (1.8 - 11.0)	2.47 (0.53 - 3.27)	10.85 99
22+22	3.30	3.30			6.60 (1.8 - 7.2)	1.57 (0.48 - 2.76)	6.90 99
22+25	3.23	3.67			6.90 (1.8 - 8.0)	1.67 (0.48 - 2.95)	7.33 99
22+35	2.89	4.61			7.50 (1.8 - 9.3)	1.89 (0.48 - 3.20)	8.30 99
22+42	2.68	5.12			7.80 (1.8 - 9.7)	2.00 (0.48 - 3.23)	8.78 99
22+50	2.51	5.69			8.20 (1.8 - 10.0)	2.13 (0.48 - 3.24)	9.35 99
22+60	2.52	6.88			9.40 (1.8 - 10.9)	2.55 (0.48 - 3.27)	11.20 99
22+71	2.22	7.18			9.40 (1.8 - 11.1)	2.45 (0.46 - 3.27)	10.76 99
25+25	3.60	3.60			7.20 (1.8 - 8.8)	1.76 (0.48 - 3.14)	7.73 99
25+35	3.17	4.43			7.60 (1.8 - 9.5)	1.93 (0.48 - 3.23)	8.48 99
25+42	2.95	4.95			7.90 (1.8 - 9.7)	2.03 (0.48 - 3.23)	8.92 99
25+50	2.87	5.73			8.60 (1.8 - 10.3)	2.27 (0.48 - 3.25)	9.97 99
25+60	2.76	6.64			9.40 (1.8 - 10.9)	2.54 (0.46 - 3.27)	11.16 99
25+71	2.45	6.95			9.40 (1.8 - 11.1)	2.42 (0.46 - 3.27)	10.63 99
35+35	4.00	4.00			8.00 (1.8 - 9.8)	2.06 (0.48 - 3.23)	9.05 99

MXZ-4C80VA(VA2) HEATING

Indoor units combination	Heating capacity (kW)				Outdoor unit power consumption (kW)	Current (A)	Power factor (%)
	Unit A	Unit B	Unit C	Unit D			
35+42	4.00	4.80			8.80 (1.8 - 10.4)	2.34 (0.48 - 3.25)	10.28 99
35+50	3.87	5.53			9.40 (1.8 - 10.9)	2.54 (0.46 - 3.27)	11.16 99
35+60	3.46	5.94			9.40 (1.8 - 11.1)	2.43 (0.46 - 3.27)	10.67 99
35+71	3.10	6.30			9.40 (1.9 - 11.2)	2.30 (0.44 - 3.32)	10.10 99
42+42	4.70	4.70			9.40 (1.8 - 10.9)	2.55 (0.46 - 3.27)	11.20 99
42+50	4.29	5.11			9.40 (1.8 - 11.1)	2.46 (0.46 - 3.27)	10.80 99
42+60	3.87	5.53			9.40 (1.9 - 11.2)	2.35 (0.44 - 3.32)	10.32 99
42+71	3.49	5.91			9.40 (1.9 - 11.2)	2.22 (0.44 - 3.32)	9.75 99
50+50	4.70	4.70			9.40 (1.9 - 11.2)	2.37 (0.44 - 3.32)	10.41 99
50+60	4.27	5.13			9.40 (1.9 - 11.2)	2.26 (0.44 - 3.32)	9.93 99
50+71	3.88	5.52			9.40 (1.9 - 11.2)	2.14 (0.44 - 3.32)	9.40 99
60+60	4.70	4.70			9.40 (1.9 - 11.2)	2.14 (0.44 - 3.32)	9.40 99
60+71	4.31	5.09			9.40 (1.9 - 11.2)	2.14 (0.44 - 3.32)	9.40 99
15+15+15	1.70	1.70	1.70		5.10 (2.6 - 8.4)	1.16 (0.66 - 3.90)	5.09 99
15+15+20	1.68	1.68	2.24		5.60 (2.6 - 8.9)	1.16 (0.65 - 3.90)	5.09 99
15+15+22	1.67	1.67	2.45		5.80 (2.6 - 9.1)	1.22 (0.61 - 3.90)	5.36 99
15+15+25	1.66	1.66	2.77		6.10 (2.6 - 9.4)	1.31 (0.61 - 3.90)	5.75 99
15+15+35	1.94	1.94	4.52		8.40 (2.6 - 10.5)	1.91 (0.61 - 3.18)	8.39 99
15+15+42	1.85	1.85	5.19		8.90 (2.6 - 11.3)	2.01 (0.61 - 3.26)	8.83 99
15+15+50	1.73	1.73	5.75		9.20 (2.6 - 11.6)	2.11 (0.61 - 3.34)	9.27 99
15+15+60	1.57	1.57	6.27		9.40 (2.6 - 11.6)	2.17 (0.61 - 3.33)	9.53 99
15+15+71	1.40	1.40	6.61		9.40 (2.6 - 11.6)	2.17 (0.61 - 3.32)	9.53 99
15+20+20	1.66	2.22	2.22		6.10 (2.6 - 9.4)	1.31 (0.65 - 3.90)	5.75 99
15+20+22	1.66	2.21	2.43		6.30 (2.6 - 9.6)	1.37 (0.61 - 3.90)	6.02 99
15+20+25	1.65	2.20	2.75		6.60 (2.6 - 9.9)	1.62 (0.74 - 3.90)	7.11 99
15+20+35	1.89	2.51	4.40		8.80 (2.6 - 10.9)	1.99 (0.61 - 3.20)	8.74 99
15+20+42	1.77	2.36	4.96		9.10 (2.6 - 11.6)	2.07 (0.61 - 3.38)	9.09 99
15+20+50	1.66	2.21	5.53		9.40 (2.6 - 11.6)	2.17 (0.61 - 3.34)	9.53 99
15+20+60	1.48	1.98	5.94		9.40 (2.6 - 11.6)	2.17 (0.61 - 3.32)	9.53 99
15+20+71	1.33	1.77	6.30		9.40 (2.6 - 11.6)	2.17 (0.61 - 3.31)	9.53 99
15+22+22	1.65	2.42	2.42		6.50 (2.6 - 9.8)	1.44 (0.57 - 3.90)	6.32 99
15+22+25	1.77	2.59	2.94		7.30 (2.6 - 10.1)	1.73 (0.57 - 3.66)	7.60 99
15+22+35	1.85	2.72	4.33		8.90 (2.6 - 11.3)	2.01 (0.57 - 3.30)	8.83 99
15+22+42	1.75	2.56	4.89		9.20 (2.6 - 11.6)	2.11 (0.57 - 3.37)	9.27 99
15+22+50	1.62	2.38	5.40		9.40 (2.6 - 11.6)	2.17 (0.57 - 3.33)	9.53 99
15+22+60	1.45	2.13	5.81		9.40 (2.6 - 11.6)	2.17 (0.57 - 3.32)	9.53 99
15+22+71	1.31	1.91	6.18		9.40 (2.6 - 11.6)	2.17 (0.57 - 3.31)	9.53 99
15+25+25	1.94	3.23	3.23		8.40 (2.6 - 10.5)	1.91 (0.57 - 3.18)	8.39 99
15+25+35	1.80	3.00	4.20		9.00 (2.6 - 11.6)	2.04 (0.57 - 3.42)	8.96 99
15+25+42	1.70	2.84	4.76		9.30 (2.6 - 11.6)	2.14 (0.57 - 3.37)	9.40 99

MXZ-4C80VA(VA2) HEATING

Indoor units combination	Heating capacity (kW)				Total	Outdoor unit power consumption (kW)	Current (A)	Power factor (%)
	Unit A	Unit B	Unit C	Unit D				
15+25+50	1.57	2.61	5.22		9.40 (2.6 - 11.6)	2.17 (0.57 - 3.33)	9.53	99
15+25+60	1.41	2.35	5.64		9.40 (2.6 - 11.6)	2.17 (0.57 - 3.32)	9.53	99
15+25+71	1.27	2.12	6.01		9.40 (2.6 - 11.6)	2.17 (0.57 - 3.31)	9.53	99
15+35+35	1.66	3.87	3.87		9.40 (2.6 - 11.6)	2.17 (0.57 - 3.41)	9.53	99
15+35+42	1.53	3.58	4.29		9.40 (2.6 - 11.6)	2.17 (0.57 - 3.36)	9.53	99
15+35+50	1.41	3.29	4.70		9.40 (2.6 - 11.6)	2.17 (0.57 - 3.32)	9.53	99
15+35+60	1.28	2.99	5.13		9.40 (2.6 - 11.6)	2.17 (0.57 - 3.31)	9.53	99
15+35+71	1.17	2.72	5.52		9.40 (2.6 - 11.6)	2.17 (0.57 - 3.31)	9.53	99
15+42+42	1.42	3.99	3.99		9.40 (2.6 - 11.6)	2.17 (0.57 - 3.31)	9.53	99
15+42+50	1.32	3.69	4.39		9.40 (2.6 - 11.6)	2.17 (0.57 - 3.27)	9.53	99
15+42+60	1.21	3.37	4.82		9.40 (2.6 - 11.6)	2.17 (0.57 - 3.27)	9.53	99
15+42+71	1.10	3.08	5.21		9.40 (2.6 - 11.6)	2.17 (0.57 - 3.27)	9.53	99
15+50+50	1.23	4.09	4.09		9.40 (2.6 - 11.6)	2.17 (0.57 - 3.24)	9.53	99
15+50+60	1.13	3.76	4.51		9.40 (2.6 - 11.6)	2.17 (0.57 - 3.24)	9.53	99
15+50+71	1.04	3.46	4.91		9.40 (2.6 - 11.6)	2.17 (0.57 - 3.24)	9.53	99
20+20+20	2.20	2.20	2.20		6.60 (2.6 - 9.9)	1.62 (0.66 - 3.90)	7.11	99
20+20+22	2.35	2.35	2.59		7.30 (2.6 - 10.1)	1.73 (0.61 - 3.66)	7.60	99
20+20+25	2.58	2.58	3.23		8.40 (2.6 - 10.5)	1.91 (0.61 - 3.18)	8.39	99
20+20+35	2.40	2.40	4.20		9.00 (2.6 - 11.6)	2.04 (0.61 - 3.42)	8.96	99
20+20+42	2.27	2.27	4.76		9.30 (2.6 - 11.6)	2.14 (0.61 - 3.37)	9.40	99
20+20+50	2.09	2.09	5.22		9.40 (2.6 - 11.6)	2.17 (0.61 - 3.33)	9.53	99
20+20+60	1.88	1.88	5.64		9.40 (2.6 - 11.6)	2.17 (0.61 - 3.32)	9.53	99
20+20+71	1.69	1.69	6.01		9.40 (2.6 - 11.6)	2.17 (0.61 - 3.31)	9.53	99
20+22+22	2.50	2.75	2.75		8.00 (2.6 - 10.4)	1.85 (0.57 - 3.30)	8.12	99
20+22+25	2.60	2.86	3.25		8.70 (2.6 - 10.6)	1.96 (0.57 - 3.10)	8.61	99
20+22+35	2.36	2.60	4.14		9.10 (2.6 - 11.6)	2.07 (0.57 - 3.42)	9.09	99
20+22+42	2.24	2.46	4.70		9.40 (2.6 - 11.6)	2.17 (0.57 - 3.37)	9.53	99
20+22+50	2.04	2.25	5.11		9.40 (2.6 - 11.6)	2.17 (0.57 - 3.33)	9.53	99
20+22+60	1.84	2.03	5.53		9.40 (2.6 - 11.6)	2.17 (0.57 - 3.31)	9.53	99
20+22+71	1.66	1.83	5.91		9.40 (2.6 - 11.6)	2.17 (0.57 - 3.31)	9.53	99
20+25+25	2.51	3.14	3.14		8.80 (2.6 - 10.9)	1.99 (0.57 - 3.20)	8.74	99
20+25+35	2.30	2.88	4.03		9.20 (2.6 - 11.6)	2.11 (0.57 - 3.41)	9.27	99
20+25+42	2.16	2.70	4.54		9.40 (2.6 - 11.6)	2.17 (0.57 - 3.36)	9.53	99
20+25+50	1.98	2.47	4.95		9.40 (2.6 - 11.6)	2.17 (0.57 - 3.32)	9.53	99
20+25+60	1.79	2.24	5.37		9.40 (2.6 - 11.6)	2.17 (0.57 - 3.31)	9.53	99
20+25+71	1.62	2.03	5.75		9.40 (2.6 - 11.6)	2.17 (0.57 - 3.31)	9.53	99
20+35+35	2.09	3.66	3.66		9.40 (2.6 - 11.6)	2.17 (0.57 - 3.40)	9.53	99
20+35+42	1.94	3.39	4.07		9.40 (2.6 - 11.6)	2.17 (0.57 - 3.35)	9.53	99
20+35+50	1.79	3.13	4.48		9.40 (2.6 - 11.6)	2.17 (0.57 - 3.31)	9.53	99
20+35+60	1.63	2.86	4.90		9.40 (2.6 - 11.6)	2.17 (0.57 - 3.31)	9.53	99

MXZ-4C80VA(VA2) HEATING

Indoor units combination	Heating capacity (kW)				Total	Outdoor unit power consumption (kW)	Current (A)	Power factor (%)
	Unit A	Unit B	Unit C	Unit D				
20+35+71	1.49	2.61	5.30		9.40 (2.6 - 11.6)	2.17 (0.57 - 3.31)	9.53	99
20+42+42	1.81	3.80	3.80		9.40 (2.6 - 11.6)	2.17 (0.57 - 3.30)	9.53	99
20+42+50	1.68	3.53	4.20		9.40 (2.6 - 11.6)	2.17 (0.57 - 3.27)	9.53	99
20+42+60	1.54	3.24	4.62		9.40 (2.6 - 11.6)	2.17 (0.57 - 3.27)	9.53	99
20+42+71	1.41	2.97	5.02		9.40 (2.6 - 11.6)	2.17 (0.57 - 3.27)	9.53	99
20+50+50	1.57	3.92	3.92		9.40 (2.6 - 11.6)	2.17 (0.57 - 3.24)	9.53	99
20+50+60	1.45	3.62	4.34		9.40 (2.6 - 11.6)	2.17 (0.57 - 3.24)	9.53	99
20+50+71	1.33	3.33	4.73		9.40 (2.6 - 11.6)	2.17 (0.57 - 3.24)	9.53	99
22+22+22	2.90	2.90	2.90		8.70 (2.6 - 10.6)	1.96 (0.53 - 3.06)	8.61	99
22+22+25	2.81	2.81	3.19		8.80 (2.6 - 10.9)	1.99 (0.53 - 3.20)	8.74	99
22+22+35	2.56	2.56	4.08		9.20 (2.6 - 11.6)	2.11 (0.53 - 3.41)	9.27	99
22+22+42	2.40	2.40	4.59		9.40 (2.6 - 11.6)	2.17 (0.53 - 3.37)	9.53	99
22+22+50	2.20	2.20	5.00		9.40 (2.6 - 11.6)	2.17 (0.53 - 3.32)	9.53	99
22+22+60	1.99	1.99	5.42		9.40 (2.6 - 11.6)	2.17 (0.53 - 3.31)	9.53	99
22+22+71	1.80	1.80	5.80		9.40 (2.6 - 11.6)	2.17 (0.53 - 3.31)	9.53	99
22+25+25	2.72	3.09	3.09		8.90 (2.6 - 11.3)	2.01 (0.53 - 3.30)	8.83	99
22+25+35	2.50	2.84	3.97		9.30 (2.6 - 11.6)	2.14 (0.53 - 3.41)	9.40	99
22+25+42	2.32	2.64	4.44		9.40 (2.6 - 11.6)	2.17 (0.53 - 3.36)	9.53	99
22+25+50	2.13	2.42	4.85		9.40 (2.6 - 11.6)	2.17 (0.53 - 3.32)	9.53	99
22+25+60	1.93	2.20	5.27		9.40 (2.6 - 11.6)	2.17 (0.53 - 3.31)	9.53	99
22+25+71	1.75	1.99	5.66		9.40 (2.6 - 11.6)	2.17 (0.53 - 3.31)	9.53	99
22+35+35	2.25	3.58	3.58		9.40 (2.6 - 11.6)	2.17 (0.53 - 3.40)	9.53	99
22+35+42	2.09	3.32	3.99		9.40 (2.6 - 11.6)	2.17 (0.53 - 3.35)	9.53	99
22+35+50	1.93	3.07	4.39		9.40 (2.6 - 11.6)	2.17 (0.53 - 3.31)	9.53	99
22+35+60	1.77	2.81	4.82		9.40 (2.6 - 11.6)	2.17 (0.53 - 3.31)	9.53	99
22+35+71	1.62	2.57	5.21		9.40 (2.6 - 11.6)	2.17 (0.53 - 3.31)	9.53	99
22+42+42	1.95	3.72	3.72		9.40 (2.6 - 11.6)	2.17 (0.53 - 3.30)	9.53	99
22+42+50	1.81	3.46	4.12		9.40 (2.6 - 11.6)	2.17 (0.53 - 3.27)	9.53	99
22+42+60	1.67	3.18	4.55		9.40 (2.6 - 11.6)	2.17 (0.53 - 3.27)	9.53	99
22+42+71	1.53	2.92	4.94		9.40 (2.6 - 11.6)	2.17 (0.53 - 3.27)	9.53	99
22+50+50	1.70	3.85	3.85		9.40 (2.6 - 11.6)	2.17 (0.53 - 3.24)	9.53	99
22+50+60	1.57	3.56	4.27		9.40 (2.6 - 11.6)	2.17 (0.53 - 3.24)	9.53	99
22+50+71	1.45	3.29	4.67		9.40 (2.6 - 11.6)	2.17 (0.53 - 3.24)	9.53	99
25+25+25	3.00	3.00	3.00		9.00 (2.6 - 11.6)	2.04 (0.53 - 3.42)	8.96	99
25+25+35	2.76	2.76	3.87		9.40 (2.6 - 11.6)	2.17 (0.53 - 3.41)	9.53	99
25+25+42	2.55	2.55	4.29		9.40 (2.6 - 11.6)	2.17 (0.53 - 3.36)	9.53	99
25+25+50	2.35	2.35	4.70		9.40 (2.6 - 11.6)	2.17 (0.53 - 3.32)	9.53	99
25+25+60	2.14	2.14	5.13		9.40 (2.6 - 11.6)	2.17 (0.53 - 3.31)	9.53	99
25+25+71	1.94	1.94	5.52		9.40 (2.6 - 11.6)	2.17 (0.53 - 3.31)	9.53	99
25+35+35	2.47	3.46	3.46		9.40 (2.6 - 11.6)	2.17 (0.53 - 3.39)	9.53	99

MXZ-4C80VA(VA2) HEATING

Indoor units combination	Heating capacity (kW)				Total	Outdoor unit power consumption (kW)	Current (A)	Power factor (%)
	Unit A	Unit B	Unit C	Unit D				
25+35+42	2.30	3.23	3.87		9.40 (2.6 - 11.6)	2.17 (0.53 - 3.34)	9.53	99
25+35+50	2.14	2.99	4.27		9.40 (2.6 - 11.6)	2.17 (0.53 - 3.31)	9.53	99
25+35+60	1.96	2.74	4.70		9.40 (2.6 - 11.6)	2.17 (0.53 - 3.31)	9.53	99
25+35+71	1.79	2.51	5.09		9.40 (2.6 - 11.6)	2.17 (0.53 - 3.31)	9.53	99
25+42+42	2.16	3.62	3.62		9.40 (2.6 - 11.6)	2.17 (0.53 - 3.30)	9.53	99
25+42+50	2.01	3.37	4.02		9.40 (2.6 - 11.6)	2.17 (0.53 - 3.27)	9.53	99
25+42+60	1.85	3.11	4.44		9.40 (2.6 - 11.6)	2.17 (0.53 - 3.27)	9.53	99
25+42+71	1.70	2.86	4.84		9.40 (2.6 - 11.6)	2.17 (0.53 - 3.27)	9.53	99
25+50+50	1.88	3.76	3.76		9.40 (2.6 - 11.6)	2.17 (0.53 - 3.24)	9.53	99
25+50+60	1.74	3.48	4.18		9.40 (2.6 - 11.6)	2.17 (0.53 - 3.24)	9.53	99
35+35+35	3.13	3.13	3.13		9.40 (2.6 - 11.6)	2.17 (0.53 - 3.38)	9.53	99
35+35+42	2.94	2.94	3.53		9.40 (2.6 - 11.6)	2.17 (0.53 - 3.34)	9.53	99
35+35+50	2.74	2.74	3.92		9.40 (2.6 - 11.6)	2.17 (0.53 - 3.31)	9.53	99
35+35+60	2.53	2.53	4.34		9.40 (2.6 - 11.6)	2.17 (0.53 - 3.31)	9.53	99
35+35+71	2.33	2.33	4.73		9.40 (2.6 - 11.6)	2.17 (0.53 - 3.31)	9.53	99
35+42+42	2.76	3.32	3.32		9.40 (2.6 - 11.6)	2.17 (0.53 - 3.30)	9.53	99
35+42+50	2.59	3.11	3.70		9.40 (2.6 - 11.6)	2.17 (0.53 - 3.27)	9.53	99
35+42+60	2.40	2.88	4.12		9.40 (2.6 - 11.6)	2.17 (0.53 - 3.27)	9.53	99
35+50+50	2.44	3.48	3.48		9.40 (2.6 - 11.6)	2.17 (0.53 - 3.24)	9.53	99
35+50+60	2.27	3.24	3.89		9.40 (2.6 - 11.6)	2.17 (0.53 - 3.24)	9.53	99
15+15+15+15	1.70	1.70	1.70	1.70	6.80 (3.4 - 9.3)	1.53 (0.79 - 3.90)	6.72	99
15+15+15+20	1.64	1.64	1.64	2.18	7.10 (3.4 - 9.7)	1.69 (0.79 - 3.90)	7.42	99
15+15+15+22	1.61	1.61	1.61	2.36	7.20 (3.4 - 9.8)	1.75 (0.74 - 3.90)	7.69	99
15+15+15+25	1.59	1.59	1.59	2.64	7.40 (3.4 - 10.1)	1.86 (0.74 - 3.90)	8.17	99
15+15+15+35	1.50	1.50	1.50	3.50	8.00 (3.4 - 10.8)	2.18 (0.94 - 3.90)	9.57	99
15+15+15+42	1.59	1.59	1.59	4.44	9.20 (3.4 - 11.5)	2.01 (0.74 - 3.44)	8.83	99
15+15+15+50	1.48	1.48	1.48	4.95	9.40 (3.4 - 11.6)	1.95 (0.74 - 3.37)	8.56	99
15+15+15+60	1.34	1.34	1.34	5.37	9.40 (3.4 - 11.6)	1.89 (0.74 - 3.34)	8.30	99
15+15+15+71	1.22	1.22	1.22	5.75	9.40 (3.4 - 11.6)	1.86 (0.74 - 3.30)	8.17	99
15+15+20+20	1.59	1.59	2.11	2.11	7.40 (3.4 - 10.1)	1.86 (0.79 - 3.90)	8.17	99
15+15+20+22	1.56	1.56	2.08	2.29	7.50 (3.4 - 10.2)	1.91 (0.74 - 3.90)	8.39	99
15+15+20+25	1.54	1.54	2.05	2.57	7.70 (3.4 - 10.4)	2.02 (0.74 - 3.90)	8.87	99
15+15+20+35	1.57	1.57	2.09	3.66	8.90 (3.4 - 11.3)	2.07 (0.74 - 3.60)	9.09	99
15+15+20+42	1.53	1.53	2.04	4.29	9.40 (3.4 - 11.6)	1.97 (0.74 - 3.37)	8.65	99
15+15+20+50	1.41	1.41	1.88	4.70	9.40 (3.4 - 11.6)	1.92 (0.74 - 3.36)	8.43	99
15+15+20+60	1.28	1.28	1.71	5.13	9.40 (3.4 - 11.6)	1.89 (0.74 - 3.32)	8.30	99
15+15+20+71	1.17	1.17	1.55	5.52	9.40 (3.4 - 11.6)	1.86 (0.74 - 3.28)	8.17	99
15+15+22+22	1.54	1.54	2.26	2.26	7.60 (3.4 - 10.3)	1.96 (0.69 - 3.90)	8.61	99
15+15+22+25	1.52	1.52	2.23	2.53	7.80 (3.4 - 10.6)	2.07 (0.69 - 3.90)	9.09	99
15+15+22+35	1.59	1.59	2.33	3.70	9.20 (3.4 - 11.5)	2.03 (0.69 - 3.48)	8.92	99

MXZ-4C80VA(VA2) HEATING

Indoor units combination	Heating capacity (kW)					Outdoor unit power consumption (kW)	Current (A)	Power factor (%)
	Unit A	Unit B	Unit C	Unit D	Total			
15+15+22+42	1.50	1.50	2.20	4.20	9.40 (3.4 - 11.6)	1.96 (0.69 - 3.37)	8.61	99
15+15+22+50	1.38	1.38	2.03	4.61	9.40 (3.4 - 11.6)	1.92 (0.69 - 3.35)	8.43	99
15+15+22+60	1.26	1.26	1.85	5.04	9.40 (3.4 - 11.6)	1.88 (0.69 - 3.31)	8.26	99
15+15+22+71	1.15	1.15	1.68	5.43	9.40 (3.4 - 11.6)	1.86 (0.69 - 3.27)	8.17	99
15+15+25+25	1.50	1.50	2.50	2.50	8.00 (3.4 - 10.8)	2.18 (0.89 - 3.90)	9.57	99
15+15+25+35	1.57	1.57	2.61	3.66	9.40 (3.4 - 11.6)	2.00 (0.69 - 3.42)	8.78	99
15+15+25+42	1.45	1.45	2.42	4.07	9.40 (3.4 - 11.6)	1.95 (0.69 - 3.36)	8.56	99
15+15+25+50	1.34	1.34	2.24	4.48	9.40 (3.4 - 11.6)	1.92 (0.69 - 3.34)	8.43	99
15+15+25+60	1.23	1.23	2.04	4.90	9.40 (3.4 - 11.6)	1.88 (0.69 - 3.30)	8.26	99
15+15+25+71	1.12	1.12	1.87	5.30	9.40 (3.4 - 11.6)	1.86 (0.69 - 3.26)	8.17	99
15+15+35+35	1.41	1.41	3.29	3.29	9.40 (3.4 - 11.6)	1.95 (0.69 - 3.39)	8.56	99
15+15+35+42	1.32	1.32	3.07	3.69	9.40 (3.4 - 11.6)	1.93 (0.69 - 3.32)	8.48	99
15+15+35+50	1.23	1.23	2.86	4.09	9.40 (3.4 - 11.6)	1.91 (0.69 - 3.30)	8.39	99
15+15+35+60	1.13	1.13	2.63	4.51	9.40 (3.4 - 11.6)	1.88 (0.69 - 3.26)	8.26	99
15+15+35+71	1.04	1.04	2.42	4.91	9.40 (3.4 - 11.6)	1.85 (0.69 - 3.22)	8.12	99
15+15+42+42	1.24	1.24	3.46	3.46	9.40 (3.4 - 11.6)	1.90 (0.69 - 3.25)	8.34	99
15+15+42+50	1.16	1.16	3.24	3.85	9.40 (3.4 - 11.6)	1.89 (0.69 - 3.23)	8.30	99
15+15+42+60	1.07	1.07	2.99	4.27	9.40 (3.4 - 11.6)	1.85 (0.69 - 3.19)	8.12	99
15+15+42+71	0.99	0.99	2.76	4.67	9.40 (3.4 - 11.6)	1.83 (0.69 - 3.16)	8.04	99
15+15+50+50	1.08	1.08	3.62	3.62	9.40 (3.4 - 11.6)	1.88 (0.69 - 3.21)	8.26	99
15+15+50+60	1.01	1.01	3.36	4.03	9.40 (3.4 - 11.6)	1.84 (0.69 - 3.17)	8.08	99
15+20+20+20	1.54	2.05	2.05	2.05	7.70 (3.4 - 10.4)	2.02 (0.79 - 3.90)	8.87	99
15+20+20+22	1.52	2.03	2.03	2.23	7.80 (3.4 - 10.6)	2.07 (0.74 - 3.90)	9.09	99
15+20+20+25	1.50	2.00	2.00	2.50	8.00 (3.4 - 10.8)	2.18 (0.94 - 3.90)	9.57	99
15+20+20+35	1.57	2.09	2.09	3.66	9.40 (3.4 - 11.6)	2.00 (0.74 - 3.42)	8.78	99
15+20+20+42	1.45	1.94	1.94	4.07	9.40 (3.4 - 11.6)	1.95 (0.74 - 3.36)	8.56	99
15+20+20+50	1.34	1.79	1.79	4.48	9.40 (3.4 - 11.6)	1.92 (0.74 - 3.34)	8.43	99
15+20+20+60	1.23	1.63	1.63	4.90	9.40 (3.4 - 11.6)	1.88 (0.74 - 3.30)	8.26	99
15+20+20+71	1.12	1.49	1.49	5.30	9.40 (3.4 - 11.6)	1.86 (0.74 - 3.26)	8.17	99
15+20+22+22	1.50	2.00	2.20	2.20	7.90 (3.4 - 10.7)	2.13 (0.69 - 3.90)	9.35	99
15+20+22+25	1.53	2.04	2.24	2.55	8.35 (3.4 - 11.0)	2.14 (0.69 - 3.78)	9.40	99
15+20+22+35	1.53	2.04	2.25	3.58	9.40 (3.4 - 11.6)	1.99 (0.69 - 3.41)	8.74	99
15+20+22+42	1.42	1.90	2.09	3.99	9.40 (3.4 - 11.6)	1.94 (0.69 - 3.35)	8.52	99
15+20+22+50	1.32	1.76	1.93	4.39	9.40 (3.4 - 11.6)	1.92 (0.69 - 3.33)	8.43	99
15+20+22+60	1.21	1.61	1.77	4.82	9.40 (3.4 - 11.6)	1.88 (0.69 - 3.29)	8.26	99
15+20+22+71	1.10	1.47	1.62	5.21	9.40 (3.4 - 11.6)	1.86 (0.69 - 3.25)	8.17	99
15+20+25+25	1.57	2.09	2.62	2.62	8.90 (3.4 - 11.3)	2.07 (0.69 - 3.60)	9.09	99
15+20+25+35	1.48	1.98	2.47	3.46	9.40 (3.4 - 11.6)	1.98 (0.69 - 3.40)	8.70	99
15+20+25+42	1.38	1.84	2.30	3.87	9.40 (3.4 - 11.6)	1.93 (0.69 - 3.34)	8.48	99
15+20+25+50	1.28	1.71	2.14	4.27	9.40 (3.4 - 11.6)	1.92 (0.69 - 3.32)	8.43	99

MXZ-4C80VA(VA2) HEATING

Indoor units combination	Heating capacity (kW)					Outdoor unit power consumption (kW)	Current (A)	Power factor (%)
	Unit A	Unit B	Unit C	Unit D	Total			
15+20+25+60	1.18	1.57	1.96	4.70	9.40 (3.4 - 11.6)	1.88 (0.69 - 3.28)	8.26	99
15+20+25+71	1.08	1.44	1.79	5.09	9.40 (3.4 - 11.6)	1.85 (0.69 - 3.24)	8.12	99
15+20+35+35	1.34	1.79	3.13	3.13	9.40 (3.4 - 11.6)	1.95 (0.69 - 3.37)	8.56	99
15+20+35+42	1.26	1.68	2.94	3.53	9.40 (3.4 - 11.6)	1.92 (0.69 - 3.30)	8.43	99
15+20+35+50	1.18	1.57	2.74	3.92	9.40 (3.4 - 11.6)	1.91 (0.69 - 3.28)	8.39	99
15+20+35+60	1.08	1.45	2.53	4.34	9.40 (3.4 - 11.6)	1.88 (0.69 - 3.24)	8.26	99
15+20+35+71	1.00	1.33	2.33	4.73	9.40 (3.4 - 11.6)	1.85 (0.69 - 3.20)	8.12	99
15+20+42+42	1.18	1.58	3.32	3.32	9.40 (3.4 - 11.6)	1.90 (0.69 - 3.23)	8.34	99
15+20+42+50	1.11	1.48	3.11	3.70	9.40 (3.4 - 11.6)	1.89 (0.69 - 3.21)	8.30	99
15+20+42+60	1.03	1.37	2.88	4.12	9.40 (3.4 - 11.6)	1.85 (0.69 - 3.17)	8.12	99
15+20+50+50	1.04	1.39	3.48	3.48	9.40 (3.4 - 11.6)	1.87 (0.69 - 3.19)	8.21	99
15+20+50+60	0.97	1.30	3.24	3.89	9.40 (3.4 - 11.6)	1.84 (0.69 - 3.17)	8.08	99
15+22+22+22	1.52	2.23	2.23	2.23	8.20 (3.4 - 10.9)	2.16 (0.64 - 3.84)	9.49	99
15+22+22+25	1.55	2.28	2.28	2.59	8.70 (3.4 - 11.2)	2.10 (0.64 - 3.66)	9.22	99
15+22+22+35	1.50	2.20	2.20	3.50	9.40 (3.4 - 11.6)	1.98 (0.64 - 3.41)	8.70	99
15+22+22+42	1.40	2.05	2.05	3.91	9.40 (3.4 - 11.6)	1.93 (0.64 - 3.35)	8.48	99
15+22+22+50	1.29	1.90	1.90	4.31	9.40 (3.4 - 11.6)	1.92 (0.64 - 3.32)	8.43	99
15+22+22+60	1.18	1.74	1.74	4.74	9.40 (3.4 - 11.6)	1.88 (0.64 - 3.28)	8.26	99
15+22+22+71	1.08	1.59	1.59	5.13	9.40 (3.4 - 11.6)	1.86 (0.64 - 3.24)	8.17	99
15+22+25+25	1.59	2.33	2.64	2.64	9.20 (3.4 - 11.5)	2.03 (0.64 - 3.48)	8.92	99
15+22+25+35	1.45	2.13	2.42	3.39	9.40 (3.4 - 11.6)	1.97 (0.64 - 3.40)	8.65	99
15+22+25+42	1.36	1.99	2.26	3.80	9.40 (3.4 - 11.6)	1.93 (0.64 - 3.33)	8.48	99
15+22+25+50	1.26	1.85	2.10	4.20	9.40 (3.4 - 11.6)	1.91 (0.64 - 3.31)	8.39	99
15+22+25+60	1.16	1.70	1.93	4.62	9.40 (3.4 - 11.6)	1.88 (0.64 - 3.27)	8.26	99
15+22+25+71	1.06	1.55	1.77	5.02	9.40 (3.4 - 11.6)	1.85 (0.64 - 3.23)	8.12	99
15+22+35+35	1.32	1.93	3.07	3.07	9.40 (3.4 - 11.6)	1.95 (0.64 - 3.36)	8.56	99
15+22+35+42	1.24	1.81	2.89	3.46	9.40 (3.4 - 11.6)	1.92 (0.64 - 3.29)	8.43	99
15+22+35+50	1.16	1.70	2.70	3.85	9.40 (3.4 - 11.6)	1.91 (0.64 - 3.27)	8.39	99
15+22+35+60	1.07	1.57	2.49	4.27	9.40 (3.4 - 11.6)	1.87 (0.64 - 3.23)	8.21	99
15+22+35+71	0.99	1.45	2.30	4.67	9.40 (3.4 - 11.6)	1.85 (0.64 - 3.20)	8.12	99
15+22+42+42	1.17	1.71	3.26	3.26	9.40 (3.4 - 11.6)	1.90 (0.64 - 3.23)	8.34	99
15+22+42+50	1.09	1.60	3.06	3.64	9.40 (3.4 - 11.6)	1.89 (0.64 - 3.20)	8.30	99
15+22+42+60	1.01	1.49	2.84	4.06	9.40 (3.4 - 11.6)	1.85 (0.64 - 3.16)	8.12	99
15+22+50+50	1.03	1.51	3.43	3.43	9.40 (3.4 - 11.6)	1.87 (0.64 - 3.18)	8.21	99
15+25+25+25	1.57	2.61	2.61	2.61	9.40 (3.4 - 11.6)	2.00 (0.64 - 3.42)	8.78	99
15+25+25+35	1.41	2.35	2.35	3.29	9.40 (3.4 - 11.6)	1.95 (0.64 - 3.39)	8.56	99
15+25+25+42	1.32	2.20	2.20	3.69	9.40 (3.4 - 11.6)	1.93 (0.64 - 3.32)	8.48	99
15+25+25+50	1.23	2.04	2.04	4.09	9.40 (3.4 - 11.6)	1.91 (0.64 - 3.30)	8.39	99
15+25+25+60	1.13	1.88	1.88	4.51	9.40 (3.4 - 11.6)	1.88 (0.64 - 3.26)	8.26	99
15+25+25+71	1.04	1.73	1.73	4.91	9.40 (3.4 - 11.6)	1.85 (0.64 - 3.22)	8.12	99

MXZ-4C80VA(VA2) HEATING

Indoor units combination	Heating capacity (kW)					Outdoor unit power consumption (kW)	Current (A)	Power factor (%)
	Unit A	Unit B	Unit C	Unit D	Total			
15+25+35+35	1.28	2.14	2.99	2.99	9.40 (3.4 - 11.6)	1.95 (0.64 - 3.35)	8.56	99
15+25+35+42	1.21	2.01	2.81	3.37	9.40 (3.4 - 11.6)	1.92 (0.64 - 3.28)	8.43	99
15+25+35+50	1.13	1.88	2.63	3.76	9.40 (3.4 - 11.6)	1.91 (0.64 - 3.26)	8.39	99
15+25+35+60	1.04	1.74	2.44	4.18	9.40 (3.4 - 11.6)	1.87 (0.64 - 3.22)	8.21	99
15+25+42+42	1.14	1.90	3.18	3.18	9.40 (3.4 - 11.6)	1.90 (0.64 - 3.21)	8.34	99
15+25+42+50	1.07	1.78	2.99	3.56	9.40 (3.4 - 11.6)	1.88 (0.64 - 3.19)	8.26	99
15+25+42+60	0.99	1.65	2.78	3.97	9.40 (3.4 - 11.6)	1.85 (0.64 - 3.16)	8.12	99
15+25+50+50	1.01	1.68	3.36	3.36	9.40 (3.4 - 11.6)	1.87 (0.64 - 3.17)	8.21	99
15+35+35+35	1.18	2.74	2.74	2.74	9.40 (3.4 - 11.6)	1.94 (0.64 - 3.31)	8.52	99
15+35+35+42	1.11	2.59	2.59	3.11	9.40 (3.4 - 11.6)	1.92 (0.64 - 3.24)	8.43	99
15+35+35+50	1.04	2.44	2.44	3.48	9.40 (3.4 - 11.6)	1.90 (0.64 - 3.22)	8.34	99
15+35+35+60	0.97	2.27	2.27	3.89	9.40 (3.4 - 11.6)	1.87 (0.64 - 3.20)	8.21	99
15+35+42+42	1.05	2.46	2.95	2.95	9.40 (3.4 - 11.6)	1.89 (0.64 - 3.17)	8.30	99
15+35+42+50	0.99	2.32	2.78	3.31	9.40 (3.4 - 11.6)	1.88 (0.64 - 3.16)	8.26	99
15+42+42+42	1.00	2.80	2.80	2.80	9.40 (3.4 - 11.6)	1.87 (0.64 - 3.11)	8.21	99
20+20+20+20	2.00	2.00	2.00	2.00	8.00 (3.4 - 10.8)	2.18 (0.79 - 3.90)	9.57	99
20+20+20+22	2.04	2.04	2.04	2.24	8.35 (3.4 - 11.0)	2.14 (0.74 - 3.78)	9.40	99
20+20+20+25	2.09	2.09	2.09	2.62	8.90 (3.4 - 11.3)	2.07 (0.74 - 3.60)	9.09	99
20+20+20+35	1.98	1.98	1.98	3.46	9.40 (3.4 - 11.6)	1.98 (0.74 - 3.40)	8.70	99
20+20+20+42	1.84	1.84	1.84	3.87	9.40 (3.4 - 11.6)	1.93 (0.74 - 3.34)	8.48	99
20+20+20+50	1.71	1.71	1.71	4.27	9.40 (3.4 - 11.6)	1.92 (0.74 - 3.32)	8.43	99
20+20+20+60	1.57	1.57	1.57	4.70	9.40 (3.4 - 11.6)	1.88 (0.74 - 3.28)	8.26	99
20+20+20+71	1.44	1.44	1.44	5.09	9.40 (3.4 - 11.6)	1.85 (0.74 - 3.24)	8.12	99
20+20+22+22	2.07	2.07	2.28	2.28	8.70 (3.4 - 11.2)	2.10 (0.69 - 3.66)	9.22	99
20+20+22+25	2.11	2.11	2.33	2.64	9.20 (3.4 - 11.5)	2.03 (0.69 - 3.48)	8.92	99
20+20+22+35	1.94	1.94	2.13	3.39	9.40 (3.4 - 11.6)	1.97 (0.69 - 3.40)	8.65	99
20+20+22+42	1.81	1.81	1.99	3.80	9.40 (3.4 - 11.6)	1.93 (0.69 - 3.33)	8.48	99
20+20+22+50	1.68	1.68	1.85	4.20	9.40 (3.4 - 11.6)	1.91 (0.69 - 3.31)	8.39	99
20+20+22+60	1.54	1.54	1.70	4.62	9.40 (3.4 - 11.6)	1.88 (0.69 - 3.27)	8.26	99
20+20+22+71	1.41	1.41	1.55	5.02	9.40 (3.4 - 11.6)	1.85 (0.69 - 3.23)	8.12	99
20+20+25+25	2.09	2.09	2.61	2.61	9.40 (3.4 - 11.6)	2.00 (0.69 - 3.42)	8.78	99
20+20+25+35	1.88	1.88	2.35	3.29	9.40 (3.4 - 11.6)	1.95 (0.69 - 3.39)	8.56	99
20+20+25+42	1.76	1.76	2.20	3.69	9.40 (3.4 - 11.6)	1.93 (0.69 - 3.32)	8.48	99
20+20+25+50	1.63	1.63	2.04	4.09	9.40 (3.4 - 11.6)	1.91 (0.69 - 3.30)	8.39	99
20+20+25+60	1.50	1.50	1.88	4.51	9.40 (3.4 - 11.6)	1.88 (0.69 - 3.26)	8.26	99
20+20+25+71	1.38	1.38	1.73	4.91	9.40 (3.4 - 11.6)	1.85 (0.69 - 3.22)	8.12	99
20+20+35+35	1.71	1.71	2.99	2.99	9.40 (3.4 - 11.6)	1.95 (0.69 - 3.35)	8.56	99
20+20+35+42	1.61	1.61	2.81	3.37	9.40 (3.4 - 11.6)	1.92 (0.69 - 3.28)	8.43	99
20+20+35+50	1.50	1.50	2.63	3.76	9.40 (3.4 - 11.6)	1.91 (0.69 - 3.26)	8.39	99
20+20+35+60	1.39	1.39	2.44	4.18	9.40 (3.4 - 11.6)	1.87 (0.69 - 3.22)	8.21	99

MXZ-4C80VA(VA2) HEATING

Indoor units combination	Heating capacity (kW)					Outdoor unit power consumption (kW)	Current (A)	Power factor (%)
	Unit A	Unit B	Unit C	Unit D	Total			
20+20+42+42	1.52	1.52	3.18	3.18	9.40 (3.4 - 11.6)	1.90 (0.69 - 3.21)	8.34	99
20+20+42+50	1.42	1.42	2.99	3.56	9.40 (3.4 - 11.6)	1.88 (0.69 - 3.19)	8.26	99
20+20+42+60	1.32	1.32	2.78	3.97	9.40 (3.4 - 11.6)	1.85 (0.69 - 3.16)	8.12	99
20+20+50+50	1.34	1.34	3.36	3.36	9.40 (3.4 - 11.6)	1.87 (0.69 - 3.17)	8.21	99
20+22+22+22	2.10	2.32	2.32	2.32	9.05 (3.4 - 11.4)	2.05 (0.64 - 3.54)	9.00	99
20+22+22+25	2.11	2.32	2.32	2.64	9.40 (3.4 - 11.6)	2.01 (0.64 - 3.42)	8.83	99
20+22+22+35	1.90	2.09	2.09	3.32	9.40 (3.4 - 11.6)	1.96 (0.64 - 3.39)	8.61	99
20+22+22+42	1.77	1.95	1.95	3.72	9.40 (3.4 - 11.6)	1.93 (0.64 - 3.33)	8.48	99
20+22+22+50	1.65	1.81	1.81	4.12	9.40 (3.4 - 11.6)	1.91 (0.64 - 3.30)	8.39	99
20+22+22+60	1.52	1.67	1.67	4.55	9.40 (3.4 - 11.6)	1.88 (0.64 - 3.26)	8.26	99
20+22+22+71	1.39	1.53	1.53	4.94	9.40 (3.4 - 11.6)	1.85 (0.64 - 3.22)	8.12	99
20+22+25+25	2.04	2.25	2.55	2.55	9.40 (3.4 - 11.6)	1.99 (0.64 - 3.41)	8.74	99
20+22+25+35	1.84	2.03	2.30	3.23	9.40 (3.4 - 11.6)	1.95 (0.64 - 3.38)	8.56	99
20+22+25+42	1.72	1.90	2.16	3.62	9.40 (3.4 - 11.6)	1.93 (0.64 - 3.31)	8.48	99
20+22+25+50	1.61	1.77	2.01	4.02	9.40 (3.4 - 11.6)	1.91 (0.64 - 3.29)	8.39	99
20+22+25+60	1.48	1.63	1.85	4.44	9.40 (3.4 - 11.6)	1.88 (0.64 - 3.25)	8.26	99
20+22+25+71	1.36	1.50	1.70	4.84	9.40 (3.4 - 11.6)	1.85 (0.64 - 3.21)	8.12	99
20+22+35+35	1.68	1.85	2.94	2.94	9.40 (3.4 - 11.6)	1.94 (0.64 - 3.34)	8.52	99
20+22+35+42	1.58	1.74	2.76	3.32	9.40 (3.4 - 11.6)	1.92 (0.64 - 3.27)	8.43	99
20+22+35+50	1.48	1.63	2.59	3.70	9.40 (3.4 - 11.6)	1.91 (0.64 - 3.25)	8.39	99
20+22+35+60	1.37	1.51	2.40	4.12	9.40 (3.4 - 11.6)	1.87 (0.64 - 3.21)	8.21	99
20+22+42+42	1.49	1.64	3.13	3.13	9.40 (3.4 - 11.6)	1.90 (0.64 - 3.21)	8.34	99
20+22+42+50	1.40	1.54	2.95	3.51	9.40 (3.4 - 11.6)	1.88 (0.64 - 3.18)	8.26	99
20+22+42+60	1.31	1.44	2.74	3.92	9.40 (3.4 - 11.6)	1.85 (0.64 - 3.16)	8.12	99
20+22+50+50	1.32	1.46	3.31	3.31	9.40 (3.4 - 11.6)	1.87 (0.64 - 3.17)	8.21	99
20+25+25+25	1.98	2.47	2.47	2.47	9.40 (3.4 - 11.6)	1.98 (0.64 - 3.40)	8.70	99
20+25+25+35	1.79	2.24	2.24	3.13	9.40 (3.4 - 11.6)	1.95 (0.64 - 3.37)	8.56	99
20+25+25+42	1.68	2.10	2.10	3.53	9.40 (3.4 - 11.6)	1.92 (0.64 - 3.30)	8.43	99
20+25+25+50	1.57	1.96	1.96	3.92	9.40 (3.4 - 11.6)	1.91 (0.64 - 3.28)	8.39	99
20+25+25+60	1.45	1.81	1.81	4.34	9.40 (3.4 - 11.6)	1.88 (0.64 - 3.24)	8.26	99
20+25+25+71	1.33	1.67	1.67	4.73	9.40 (3.4 - 11.6)	1.85 (0.64 - 3.20)	8.12	99
20+25+35+35	1.63	2.04	2.86	2.86	9.40 (3.4 - 11.6)	1.94 (0.64 - 3.33)	8.52	99
20+25+35+42	1.54	1.93	2.70	3.24	9.40 (3.4 - 11.6)	1.92 (0.64 - 3.26)	8.43	99
20+25+35+50	1.45	1.81	2.53	3.62	9.40 (3.4 - 11.6)	1.91 (0.64 - 3.24)	8.39	99
20+25+35+60	1.34	1.68	2.35	4.03	9.40 (3.4 - 11.6)	1.87 (0.64 - 3.20)	8.21	99
20+25+42+42	1.46	1.82	3.06	3.06	9.40 (3.4 - 11.6)	1.90 (0.64 - 3.19)	8.34	99
20+25+42+50	1.37	1.72	2.88	3.43	9.40 (3.4 - 11.6)	1.88 (0.64 - 3.17)	8.26	99
20+25+50+50	1.30	1.62	3.24	3.24	9.40 (3.4 - 11.6)	1.87 (0.64 - 3.17)	8.21	99
20+35+35+35	1.50	2.63	2.63	2.63	9.40 (3.4 - 11.6)	1.94 (0.64 - 3.29)	8.52	99
20+35+35+42	1.42	2.49	2.49	2.99	9.40 (3.4 - 11.6)	1.91 (0.64 - 3.22)	8.39	99

MXZ-4C80VA(VA2) HEATING

Indoor units combination	Heating capacity (kW)					Outdoor unit power consumption (kW)	Current (A)	Power factor (%)
	Unit A	Unit B	Unit C	Unit D	Total			
20+35+35+50	1.34	2.35	2.35	3.36	9.40 (3.4 - 11.6)	1.90 (0.64 - 3.20)	8.34	99
20+35+42+42	1.35	2.37	2.84	2.84	9.40 (3.4 - 11.6)	1.89 (0.64 - 3.15)	8.30	99
22+22+22+22	2.35	2.35	2.35	2.35	9.40 (3.4 - 11.6)	2.01 (0.59 - 3.42)	8.83	99
22+22+22+25	2.27	2.27	2.27	2.58	9.40 (3.4 - 11.6)	2.00 (0.59 - 3.41)	8.78	99
22+22+22+35	2.05	2.05	2.05	3.26	9.40 (3.4 - 11.6)	1.95 (0.59 - 3.39)	8.56	99
22+22+22+42	1.91	1.91	1.91	3.66	9.40 (3.4 - 11.6)	1.93 (0.59 - 3.32)	8.48	99
22+22+22+50	1.78	1.78	1.78	4.05	9.40 (3.4 - 11.6)	1.91 (0.59 - 3.30)	8.39	99
22+22+22+60	1.64	1.64	1.64	4.48	9.40 (3.4 - 11.6)	1.88 (0.59 - 3.26)	8.26	99
22+22+22+71	1.51	1.51	1.51	4.87	9.40 (3.4 - 11.6)	1.85 (0.59 - 3.21)	8.12	99
22+22+25+25	2.20	2.20	2.50	2.50	9.40 (3.4 - 11.6)	1.98 (0.59 - 3.41)	8.70	99
22+22+25+35	1.99	1.99	2.26	3.16	9.40 (3.4 - 11.6)	1.95 (0.59 - 3.37)	8.56	99
22+22+25+42	1.86	1.86	2.12	3.56	9.40 (3.4 - 11.6)	1.92 (0.59 - 3.31)	8.43	99
22+22+25+50	1.74	1.74	1.97	3.95	9.40 (3.4 - 11.6)	1.91 (0.59 - 3.28)	8.39	99
22+22+25+60	1.60	1.60	1.82	4.37	9.40 (3.4 - 11.6)	1.88 (0.59 - 3.24)	8.26	99
22+22+25+71	1.48	1.48	1.68	4.77	9.40 (3.4 - 11.6)	1.85 (0.59 - 3.20)	8.12	99
22+22+35+35	1.81	1.81	2.89	2.89	9.40 (3.4 - 11.6)	1.94 (0.59 - 3.33)	8.52	99
22+22+35+42	1.71	1.71	2.72	3.26	9.40 (3.4 - 11.6)	1.92 (0.59 - 3.27)	8.43	99
22+22+35+50	1.60	1.60	2.55	3.64	9.40 (3.4 - 11.6)	1.91 (0.59 - 3.24)	8.39	99
22+22+35+60	1.49	1.49	2.37	4.06	9.40 (3.4 - 11.6)	1.87 (0.59 - 3.20)	8.21	99
22+22+42+42	1.62	1.62	3.08	3.08	9.40 (3.4 - 11.6)	1.90 (0.59 - 3.20)	8.34	99
22+22+42+50	1.52	1.52	2.90	3.46	9.40 (3.4 - 11.6)	1.88 (0.59 - 3.18)	8.26	99
22+22+50+50	1.44	1.44	3.26	3.26	9.40 (3.4 - 11.6)	1.87 (0.59 - 3.17)	8.21	99
22+25+25+25	2.13	2.42	2.42	2.42	9.40 (3.4 - 11.6)	1.97 (0.59 - 3.40)	8.65	99
22+25+25+35	1.93	2.20	2.20	3.07	9.40 (3.4 - 11.6)	1.95 (0.59 - 3.36)	8.56	99
22+25+25+42	1.81	2.06	2.06	3.46	9.40 (3.4 - 11.6)	1.92 (0.59 - 3.29)	8.43	99
22+25+25+50	1.70	1.93	1.93	3.85	9.40 (3.4 - 11.6)	1.91 (0.59 - 3.27)	8.39	99
22+25+25+60	1.57	1.78	1.78	4.27	9.40 (3.4 - 11.6)	1.87 (0.59 - 3.23)	8.21	99
22+25+35+35	1.77	2.01	2.81	2.81	9.40 (3.4 - 11.6)	1.94 (0.59 - 3.32)	8.52	99
22+25+35+42	1.67	1.90	2.65	3.18	9.40 (3.4 - 11.6)	1.92 (0.59 - 3.25)	8.43	99
22+25+35+50	1.57	1.78	2.49	3.56	9.40 (3.4 - 11.6)	1.90 (0.59 - 3.23)	8.34	99
22+25+35+60	1.46	1.65	2.32	3.97	9.40 (3.4 - 11.6)	1.87 (0.59 - 3.20)	8.21	99
22+35+35+35	1.63	2.59	2.59	2.59	9.40 (3.4 - 11.6)	1.94 (0.59 - 3.28)	8.52	99
22+35+35+42	1.54	2.46	2.46	2.95	9.40 (3.4 - 11.6)	1.91 (0.59 - 3.21)	8.39	99
22+35+35+50	1.46	2.32	2.32	3.31	9.40 (3.4 - 11.6)	1.90 (0.59 - 3.20)	8.34	99
22+35+42+42	1.47	2.33	2.80	2.80	9.40 (3.4 - 11.6)	1.89 (0.59 - 3.15)	8.30	99
25+25+25+25	2.35	2.35	2.35	2.35	9.40 (3.4 - 11.6)	1.95 (0.59 - 3.39)	8.56	99
25+25+25+35	2.14	2.14	2.14	2.99	9.40 (3.4 - 11.6)	1.95 (0.59 - 3.35)	8.56	99
25+25+25+42	2.01	2.01	2.01	3.37	9.40 (3.4 - 11.6)	1.92 (0.59 - 3.28)	8.43	99
25+25+25+50	1.88	1.88	1.88	3.76	9.40 (3.4 - 11.6)	1.91 (0.59 - 3.26)	8.39	99
25+25+25+60	1.74	1.74	1.74	4.18	9.40 (3.4 - 11.6)	1.87 (0.59 - 3.22)	8.21	99

MXZ-4C80VA(VA2) HEATING

Indoor units combination	Heating capacity (kW)				Total	Outdoor unit power consumption (kW)	Current (A)	Power factor (%)
	Unit A	Unit B	Unit C	Unit D				
25+25+35+35	1.96	1.96	2.74	2.74	9.40 (3.4 - 11.6)	1.94 (0.59 - 3.31)	8.52	99
25+25+35+42	1.85	1.85	2.59	3.11	9.40 (3.4 - 11.6)	1.92 (0.59 - 3.24)	8.43	99
25+25+35+50	1.74	1.74	2.44	3.48	9.40 (3.4 - 11.6)	1.90 (0.59 - 3.22)	8.34	99
25+35+35+35	1.81	2.53	2.53	2.53	9.40 (3.4 - 11.6)	1.94 (0.59 - 3.27)	8.52	99
25+35+35+42	1.72	2.40	2.40	2.88	9.40 (3.4 - 11.6)	1.91 (0.59 - 3.20)	8.39	99
35+35+35+35	2.35	2.35	2.35	2.35	9.40 (3.4 - 11.6)	1.93 (0.59 - 3.23)	8.48	99

MXZ-5C100VA(VA2) COOLING

Indoor units combination	Cooling capacity (kW)					Total	Outdoor unit power consumption (kW)	Current (A)	Power factor (%)
	Unit A	Unit B	Unit C	Unit D	Unit E				
20+42+60	1.46	3.06	4.38			8.90 (2.9 - 9.8)	2.640 (0.730 - 3.110)	11.59	99
20+42+71	1.37	2.87	4.86			9.10 (2.9 - 10.1)	2.690 (0.710 - 3.190)	11.81	99
20+50+50	1.48	3.71	3.71			8.90 (2.9 - 9.8)	2.660 (0.730 - 3.110)	11.68	99
20+50+60	1.40	3.50	4.20			9.10 (2.9 - 10.1)	2.700 (0.720 - 3.190)	11.86	99
20+50+71	1.32	3.30	4.68			9.30 (2.9 - 10.6)	2.710 (0.700 - 3.340)	11.90	99
20+60+60	1.31	3.94	3.94			9.20 (2.9 - 10.4)	2.680 (0.700 - 3.280)	11.77	99
20+60+71	1.25	3.74	4.42			9.40 (2.9 - 10.8)	2.690 (0.690 - 3.400)	11.81	99
22+22+22	2.20	2.20	2.20			6.60 (2.9 - 8.1)	1.620 (0.690 - 2.410)	7.11	99
22+22+25	2.20	2.20	2.50			6.90 (2.9 - 8.4)	1.740 (0.690 - 2.610)	7.64	99
22+22+35	2.12	2.12	3.37			7.60 (2.9 - 9.0)	2.030 (0.690 - 3.010)	8.92	99
22+22+42	2.02	2.02	3.86			7.90 (2.9 - 9.1)	2.150 (0.700 - 3.010)	9.44	99
22+22+50	1.92	1.92	4.36			8.20 (2.9 - 9.3)	2.290 (0.710 - 3.010)	10.06	99
22+22+60	1.82	1.82	4.96			8.60 (2.9 - 9.4)	2.450 (0.720 - 3.000)	10.76	99
22+22+71	1.68	1.68	5.43			8.80 (2.9 - 9.7)	2.540 (0.710 - 3.050)	11.16	99
22+25+25	2.20	2.50	2.50			7.20 (2.9 - 8.7)	1.860 (0.690 - 2.810)	8.17	99
22+25+35	2.09	2.38	3.33			7.80 (2.9 - 9.1)	2.120 (0.700 - 3.020)	9.31	99
22+25+42	1.98	2.25	3.78			8.00 (2.9 - 9.2)	2.200 (0.700 - 3.010)	9.66	99
22+25+50	1.88	2.14	4.28			8.30 (2.9 - 9.3)	2.340 (0.710 - 3.010)	10.28	99
22+25+60	1.77	2.01	4.82			8.60 (2.9 - 9.4)	2.450 (0.720 - 3.000)	10.76	99
22+25+71	1.64	1.86	5.29			8.80 (2.9 - 9.7)	2.540 (0.700 - 3.050)	11.16	99
22+35+35	1.94	3.08	3.08			8.10 (2.9 - 9.2)	2.270 (0.710 - 3.020)	9.97	99
22+35+42	1.87	2.97	3.56			8.40 (2.9 - 9.3)	2.390 (0.710 - 3.020)	10.50	99
22+35+50	1.77	2.81	4.02			8.60 (2.9 - 9.4)	2.480 (0.720 - 3.010)	10.89	99
22+35+60	1.65	2.63	4.51			8.80 (2.9 - 9.7)	2.560 (0.700 - 3.060)	11.24	99
22+35+71	1.55	2.46	4.99			9.00 (2.9 - 9.9)	2.650 (0.690 - 3.090)	11.64	99
22+42+42	1.78	3.41	3.41			8.60 (2.9 - 9.4)	2.470 (0.720 - 3.010)	10.85	99
22+42+50	1.70	3.24	3.86			8.80 (2.9 - 9.7)	2.570 (0.710 - 3.060)	11.29	99
22+42+60	1.60	3.05	4.35			9.00 (2.9 - 9.9)	2.650 (0.690 - 3.090)	11.64	99
22+42+71	1.50	2.86	4.84			9.20 (2.9 - 10.4)	2.660 (0.680 - 3.250)	11.68	99
22+50+50	1.60	3.65	3.65			8.90 (2.9 - 9.8)	2.620 (0.700 - 3.070)	11.51	99
22+50+60	1.52	3.45	4.14			9.10 (2.9 - 10.1)	2.660 (0.680 - 3.150)	11.68	99
22+50+71	1.43	3.25	4.62			9.30 (2.9 - 10.6)	2.670 (0.670 - 3.300)	11.73	99
22+60+60	1.44	3.93	3.93			9.30 (2.9 - 10.6)	2.660 (0.670 - 3.300)	11.68	99
22+60+71	1.35	3.69	4.36			9.40 (2.9 - 10.8)	2.650 (0.660 - 3.360)	11.64	99
25+25+25	2.50	2.50	2.50			7.50 (2.9 - 9.0)	1.980 (0.690 - 3.010)	8.70	99
25+25+35	2.32	2.32	3.25			7.90 (2.9 - 9.1)	2.170 (0.700 - 3.020)	9.53	99
25+25+42	2.20	2.20	3.70			8.10 (2.9 - 9.2)	2.250 (0.710 - 3.010)	9.88	99
25+25+50	2.10	2.10	4.20			8.40 (2.9 - 9.3)	2.380 (0.720 - 3.010)	10.45	99
25+25+60	1.98	1.98	4.75			8.70 (2.9 - 9.5)	2.510 (0.710 - 3.020)	11.02	99
25+25+71	1.84	1.84	5.22			8.90 (2.9 - 9.8)	2.600 (0.700 - 3.070)	11.42	99
25+35+35	2.16	3.02	3.02			8.20 (2.9 - 9.3)	2.320 (0.710 - 3.030)	10.19	99
25+35+42	2.08	2.92	3.50			8.50 (2.9 - 9.4)	2.440 (0.720 - 3.020)	10.72	99

MXZ-5C100VA(VA2) COOLING

Indoor units combination	Cooling capacity (kW)					Total	Outdoor unit power consumption (kW)	Current (A)	Power factor (%)
	Unit A	Unit B	Unit C	Unit D	Unit E				
35+60	2.98	5.12				8.10 (2.0 - 9.0)	2.670 (0.590 - 3.380)	11.73	99
35+71	2.81	5.69				8.50 (2.1 - 9.2)	2.780 (0.580 - 3.500)	12.21	99
42+42	3.90	3.90				7.80 (2.0 - 8.8)	2.580 (0.590 - 3.280)	11.33	99
42+50	3.70	4.40				8.10 (2.0 - 9.0)	2.620 (0.590 - 3.380)	11.51	99
42+60	3.46	4.94				8.40 (2.1 - 9.1)	2.720 (0.590 - 3.440)	11.95	99
42+71	3.23	5.47				8.70 (2.1 - 9.2)	2.750 (0.560 - 3.490)	12.08	99
50+50	4.15	4.15				8.30 (2.1 - 9.1)	2.810 (0.590 - 3.480)	12.34	99
50+60	3.91	4.69				8.60 (2.1 - 9.2)	2.740 (0.570 - 3.490)	12.03	99
50+71	3.68	5.22				8.90 (2.1 - 9.3)	2.770 (0.550 - 3.540)	12.17	99
60+60	4.45	4.45				8.90 (2.1 - 9.3)	2.870 (0.550 - 3.600)	12.60	99
60+71	4.12	4.88				9.00 (2.1 - 9.4)	2.730 (0.550 - 3.580)	11.99	99
71+71	4.55	4.55				9.10 (2.1 - 9.5)	2.790 (0.550 - 3.700)	12.25	99
15+15+15	1.50	1.50	1.50			4.50 (2.9 - 5.7)	1.100 (0.770 - 3.020)	4.83	99
15+15+20	1.50	1.50	2.00			5.00 (2.9 - 6.4)	1.400 (0.780 - 3.420)	6.15	99
15+15+22	1.50	1.50	2.20			5.20 (2.9 - 6.7)	1.430 (0.750 - 3.500)	6.28	99
15+15+25	1.50	1.50	2.50			5.50 (2.9 - 7.2)	1.530 (0.750 - 3.700)	6.72	99
15+15+35	1.50	1.50	3.50			6.50 (2.9 - 8.1)	1.700 (0.750 - 2.490)	7.47	99
15+15+42	1.50	1.50	4.20			7.20 (2.9 - 8.7)	1.920 (0.750 - 2.880)	8.43	99
15+15+50	1.44	1.44	4.81			7.70 (2.9 - 9.1)	2.130 (0.760 - 3.080)	9.35	99
15+15+60	1.35	1.35	5.40			8.10 (2.9 - 9.2)	2.290 (0.770 - 3.070)	10.06	99
15+15+71	1.26	1.26	5.98			8.50 (2.9 - 9.4)	2.460 (0.780 - 3.070)	10.80	99
15+20+20	1.50	2.00	2.00			5.50 (2.9 - 7.2)	1.570 (0.780 - 3.740)	6.90	99
15+20+22	1.50	2.00	2.20			5.70 (2.9 - 7.5)	1.600 (0.750 - 3.820)	7.03	99
15+20+25	1.50	2.00	2.50			6.00 (2.9 - 7.9)	1.710 (0.830 - 3.980)	7.51	99
15+20+35	1.50	2.00	3.50			7.00 (2.9 - 8.5)	1.860 (0.750 - 2.760)	8.17	99
15+20+42	1.48	1.97	4.15			7.60 (2.9 - 9.0)	2.090 (0.750 - 3.080)	9.18	99
15+20+50	1.39	1.86	4.65			7.90 (2.9 - 9.1)	2.220 (0.760 - 3.080)	9.75	99
15+20+60	1.29	1.73	5.18			8.20 (2.9 - 9.3)	2.340 (0.770 - 3.080)	10.28	99
15+20+71	1.22	1.62	5.76			8.60 (2.9 - 9.4)	2.510 (0.780 - 3.070)	11.02	99
15+22+22	1.50	2.20	2.20			5.90 (2.9 - 7.8)	1.630 (0.720 - 3.900)	7.16	99
15+22+25	1.50	2.20	2.50			6.20 (2.9 - 8.0)	1.670 (0.720 - 3.200)	7.33	99
15+22+35	1.50	2.20	3.50			7.20 (2.9 - 8.7)	1.900 (0.720 - 2.850)	8.34	99
15+22+42	1.44	2.12	4.04			7.60 (2.9 - 9.0)	2.050 (0.720 - 3.040)	9.00	99
15+22+50	1.36	2.00	4.54			7.90 (2.9 - 9.1)	2.180 (0.730 - 3.040)	9.57	99
15+22+60	1.28	1.88	5.13			8.30 (2.9 - 9.3)	2.350 (0.740 - 3.040)	10.32	99
15+22+71	1.21	1.77	5.72			8.70 (2.9 - 9.5)	2.530 (0.750 - 3.050)	11.11	99
15+25+25	1.50	2.50	2.50			6.50 (2.9 - 8.1)	1.660 (0.720 - 2.450)	7.29	99
15+25+35	1.50	2.50	3.50			7.50 (2.9 - 9.0)	2.020 (0.720 - 3.050)	8.87	99
15+25+42	1.43	2.38	4.00			7.80 (2.9 - 9.1)	2.140 (0.730 - 3.050)	9.40	99
15+25+50	1.35	2.25	4.50			8.10 (2.9 - 9.2)	2.280 (0.740 - 3.040)	10.01	99
15+25+60	1.26	2.10	5.04			8.40 (2.9 - 9.3)	2.390 (0.750 - 3.040)	10.50	99
15+25+71	1.18	1.96	5.56			8.70 (2.9 - 9.5)	2.530 (0.740 - 3.050)	11.11	99

MXZ-5C100VA(VA2) COOLING

Indoor units combination	Cooling capacity (kW)					Outdoor unit power consumption (kW)	Current (A)	Power factor (%)	
	Unit A	Unit B	Unit C	Unit D	Unit E				
15+35+35	1.39	3.25	3.25			7.90 (2.9 - 9.1)	2.210 (0.730 - 3.060)	9.71	99
15+35+42	1.32	3.08	3.70			8.10 (2.9 - 9.2)	2.290 (0.740 - 3.050)	10.06	99
15+35+50	1.26	2.94	4.20			8.40 (2.9 - 9.3)	2.420 (0.750 - 3.050)	10.63	99
15+35+60	1.19	2.77	4.75			8.70 (2.9 - 9.5)	2.550 (0.740 - 3.060)	11.20	99
15+35+71	1.10	2.57	5.22			8.90 (2.9 - 9.8)	2.640 (0.730 - 3.110)	11.59	99
15+42+42	1.27	3.56	3.56			8.40 (2.9 - 9.3)	2.410 (0.740 - 3.050)	10.58	99
15+42+50	1.21	3.38	4.02			8.60 (2.9 - 9.4)	2.500 (0.750 - 3.040)	10.98	99
15+42+60	1.13	3.16	4.51			8.80 (2.9 - 9.7)	2.580 (0.730 - 3.090)	11.33	99
15+42+71	1.05	2.95	4.99			9.00 (2.9 - 9.9)	2.670 (0.720 - 3.120)	11.73	99
15+50+50	1.15	3.83	3.83			8.80 (2.9 - 9.7)	2.600 (0.740 - 3.090)	11.42	99
15+50+60	1.08	3.60	4.32			9.00 (2.9 - 9.9)	2.680 (0.720 - 3.120)	11.77	99
15+50+71	1.01	3.38	4.80			9.20 (2.9 - 10.4)	2.690 (0.710 - 3.280)	11.81	99
15+60+60	1.02	4.09	4.09			9.20 (2.9 - 10.4)	2.680 (0.710 - 3.280)	11.77	99
15+60+71	0.96	3.82	4.52			9.30 (2.9 - 10.6)	2.680 (0.700 - 3.330)	11.77	99
20+20+20	2.00	2.00	2.00			6.00 (2.9 - 7.9)	1.630 (0.770 - 3.900)	7.16	99
20+20+22	2.00	2.00	2.20			6.20 (2.9 - 8.0)	1.710 (0.750 - 3.240)	7.51	99
20+20+25	2.00	2.00	2.50			6.50 (2.9 - 8.1)	1.700 (0.750 - 2.490)	7.47	99
20+20+35	2.00	2.00	3.50			7.50 (2.9 - 9.0)	2.060 (0.750 - 3.090)	9.05	99
20+20+42	1.90	1.90	4.00			7.80 (2.9 - 9.1)	2.180 (0.760 - 3.090)	9.57	99
20+20+50	1.80	1.80	4.50			8.10 (2.9 - 9.2)	2.320 (0.770 - 3.080)	10.19	99
20+20+60	1.68	1.68	5.04			8.40 (2.9 - 9.3)	2.430 (0.780 - 3.080)	10.67	99
20+20+71	1.57	1.57	5.56			8.70 (2.9 - 9.5)	2.570 (0.770 - 3.090)	11.29	99
20+22+22	2.00	2.20	2.20			6.40 (2.9 - 8.0)	1.660 (0.720 - 3.200)	7.29	99
20+22+25	2.00	2.20	2.50			6.70 (2.9 - 8.2)	1.700 (0.720 - 2.520)	7.47	99
20+22+35	1.97	2.17	3.45			7.60 (2.9 - 9.0)	2.070 (0.720 - 3.050)	9.09	99
20+22+42	1.86	2.04	3.90			7.80 (2.9 - 9.1)	2.140 (0.730 - 3.050)	9.40	99
20+22+50	1.76	1.94	4.40			8.10 (2.9 - 9.2)	2.280 (0.740 - 3.040)	10.01	99
20+22+60	1.67	1.83	5.00			8.50 (2.9 - 9.4)	2.440 (0.750 - 3.040)	10.72	99
20+22+71	1.56	1.71	5.53			8.80 (2.9 - 9.7)	2.580 (0.740 - 3.090)	11.33	99
20+25+25	2.00	2.50	2.50			7.00 (2.9 - 8.5)	1.820 (0.720 - 2.720)	7.99	99
20+25+35	1.93	2.41	3.37			7.70 (2.9 - 9.1)	2.120 (0.730 - 3.060)	9.31	99
20+25+42	1.82	2.27	3.81			7.90 (2.9 - 9.1)	2.190 (0.730 - 3.050)	9.62	99
20+25+50	1.73	2.16	4.32			8.20 (2.9 - 9.3)	2.330 (0.740 - 3.050)	10.23	99
20+25+60	1.64	2.05	4.91			8.60 (2.9 - 9.4)	2.490 (0.750 - 3.040)	10.94	99
20+25+71	1.52	1.90	5.39			8.80 (2.9 - 9.7)	2.580 (0.730 - 3.090)	11.33	99
20+35+35	1.80	3.15	3.15			8.10 (2.9 - 9.2)	2.310 (0.740 - 3.060)	10.14	99
20+35+42	1.71	2.99	3.59			8.30 (2.9 - 9.3)	2.390 (0.740 - 3.060)	10.50	99
20+35+50	1.64	2.87	4.10			8.60 (2.9 - 9.4)	2.520 (0.750 - 3.050)	11.07	99
20+35+60	1.53	2.68	4.59			8.80 (2.9 - 9.7)	2.600 (0.740 - 3.100)	11.42	99
20+35+71	1.43	2.50	5.07			9.00 (2.9 - 9.9)	2.690 (0.720 - 3.130)	11.81	99
20+42+42	1.65	3.47	3.47			8.60 (2.9 - 9.4)	2.510 (0.750 - 3.050)	11.02	99
20+42+50	1.55	3.26	3.88			8.70 (2.9 - 9.5)	2.560 (0.740 - 3.060)	11.24	99

MXZ-5C100VA(VA2) COOLING

Indoor units combination	Cooling capacity (kW)					Total	Outdoor unit power consumption (kW)	Current (A)	Power factor (%)
	Unit A	Unit B	Unit C	Unit D	Unit E				
20+42+60	1.46	3.06	4.38			8.90 (2.9 - 9.8)	2.640 (0.730 - 3.110)	11.59	99
20+42+71	1.37	2.87	4.86			9.10 (2.9 - 10.1)	2.690 (0.710 - 3.190)	11.81	99
20+50+50	1.48	3.71	3.71			8.90 (2.9 - 9.8)	2.660 (0.730 - 3.110)	11.68	99
20+50+60	1.40	3.50	4.20			9.10 (2.9 - 10.1)	2.700 (0.720 - 3.190)	11.86	99
20+50+71	1.32	3.30	4.68			9.30 (2.9 - 10.6)	2.710 (0.700 - 3.340)	11.90	99
20+60+60	1.31	3.94	3.94			9.20 (2.9 - 10.4)	2.680 (0.700 - 3.280)	11.77	99
20+60+71	1.25	3.74	4.42			9.40 (2.9 - 10.8)	2.690 (0.690 - 3.400)	11.81	99
22+22+22	2.20	2.20	2.20			6.60 (2.9 - 8.1)	1.620 (0.690 - 2.410)	7.11	99
22+22+25	2.20	2.20	2.50			6.90 (2.9 - 8.4)	1.740 (0.690 - 2.610)	7.64	99
22+22+35	2.12	2.12	3.37			7.60 (2.9 - 9.0)	2.030 (0.690 - 3.010)	8.92	99
22+22+42	2.02	2.02	3.86			7.90 (2.9 - 9.1)	2.150 (0.700 - 3.010)	9.44	99
22+22+50	1.92	1.92	4.36			8.20 (2.9 - 9.3)	2.290 (0.710 - 3.010)	10.06	99
22+22+60	1.82	1.82	4.96			8.60 (2.9 - 9.4)	2.450 (0.720 - 3.000)	10.76	99
22+22+71	1.68	1.68	5.43			8.80 (2.9 - 9.7)	2.540 (0.710 - 3.050)	11.16	99
22+25+25	2.20	2.50	2.50			7.20 (2.9 - 8.7)	1.860 (0.690 - 2.810)	8.17	99
22+25+35	2.09	2.38	3.33			7.80 (2.9 - 9.1)	2.120 (0.700 - 3.020)	9.31	99
22+25+42	1.98	2.25	3.78			8.00 (2.9 - 9.2)	2.200 (0.700 - 3.010)	9.66	99
22+25+50	1.88	2.14	4.28			8.30 (2.9 - 9.3)	2.340 (0.710 - 3.010)	10.28	99
22+25+60	1.77	2.01	4.82			8.60 (2.9 - 9.4)	2.450 (0.720 - 3.000)	10.76	99
22+25+71	1.64	1.86	5.29			8.80 (2.9 - 9.7)	2.540 (0.700 - 3.050)	11.16	99
22+35+35	1.94	3.08	3.08			8.10 (2.9 - 9.2)	2.270 (0.710 - 3.020)	9.97	99
22+35+42	1.87	2.97	3.56			8.40 (2.9 - 9.3)	2.390 (0.710 - 3.020)	10.50	99
22+35+50	1.77	2.81	4.02			8.60 (2.9 - 9.4)	2.480 (0.720 - 3.010)	10.89	99
22+35+60	1.65	2.63	4.51			8.80 (2.9 - 9.7)	2.560 (0.700 - 3.060)	11.24	99
22+35+71	1.55	2.46	4.99			9.00 (2.9 - 9.9)	2.650 (0.690 - 3.090)	11.64	99
22+42+42	1.78	3.41	3.41			8.60 (2.9 - 9.4)	2.470 (0.720 - 3.010)	10.85	99
22+42+50	1.70	3.24	3.86			8.80 (2.9 - 9.7)	2.570 (0.710 - 3.060)	11.29	99
22+42+60	1.60	3.05	4.35			9.00 (2.9 - 9.9)	2.650 (0.690 - 3.090)	11.64	99
22+42+71	1.50	2.86	4.84			9.20 (2.9 - 10.4)	2.660 (0.680 - 3.250)	11.68	99
22+50+50	1.60	3.65	3.65			8.90 (2.9 - 9.8)	2.620 (0.700 - 3.070)	11.51	99
22+50+60	1.52	3.45	4.14			9.10 (2.9 - 10.1)	2.660 (0.680 - 3.150)	11.68	99
22+50+71	1.43	3.25	4.62			9.30 (2.9 - 10.6)	2.670 (0.670 - 3.300)	11.73	99
22+60+60	1.44	3.93	3.93			9.30 (2.9 - 10.6)	2.660 (0.670 - 3.300)	11.68	99
22+60+71	1.35	3.69	4.36			9.40 (2.9 - 10.8)	2.650 (0.660 - 3.360)	11.64	99
25+25+25	2.50	2.50	2.50			7.50 (2.9 - 9.0)	1.980 (0.690 - 3.010)	8.70	99
25+25+35	2.32	2.32	3.25			7.90 (2.9 - 9.1)	2.170 (0.700 - 3.020)	9.53	99
25+25+42	2.20	2.20	3.70			8.10 (2.9 - 9.2)	2.250 (0.710 - 3.010)	9.88	99
25+25+50	2.10	2.10	4.20			8.40 (2.9 - 9.3)	2.380 (0.720 - 3.010)	10.45	99
25+25+60	1.98	1.98	4.75			8.70 (2.9 - 9.5)	2.510 (0.710 - 3.020)	11.02	99
25+25+71	1.84	1.84	5.22			8.90 (2.9 - 9.8)	2.600 (0.700 - 3.070)	11.42	99
25+35+35	2.16	3.02	3.02			8.20 (2.9 - 9.3)	2.320 (0.710 - 3.030)	10.19	99
25+35+42	2.08	2.92	3.50			8.50 (2.9 - 9.4)	2.440 (0.720 - 3.020)	10.72	99

MXZ-5C100VA(VA2) COOLING

Indoor units combination	Cooling capacity (kW)					Total	Outdoor unit power consumption (kW)	Current (A)	Power factor (%)
	Unit A	Unit B	Unit C	Unit D	Unit E				
25+35+50	1.98	2.77	3.95			8.70 (2.9 - 9.5)	2.540 (0.710 - 3.030)	11.16	99
25+35+60	1.85	2.60	4.45			8.90 (2.9 - 9.8)	2.620 (0.700 - 3.080)	11.51	99
25+35+71	1.74	2.43	4.93			9.10 (2.9 - 10.1)	2.670 (0.680 - 3.160)	11.73	99
25+42+42	2.00	3.35	3.35			8.70 (2.9 - 9.5)	2.530 (0.710 - 3.030)	11.11	99
25+42+50	1.88	3.16	3.76			8.80 (2.9 - 9.7)	2.570 (0.700 - 3.060)	11.29	99
25+42+60	1.77	2.98	4.25			9.00 (2.9 - 9.9)	2.650 (0.690 - 3.090)	11.64	99
25+42+71	1.67	2.80	4.73			9.20 (2.9 - 10.4)	2.660 (0.680 - 3.250)	11.68	99
25+50+50	1.80	3.60	3.60			9.00 (2.9 - 9.9)	2.670 (0.690 - 3.090)	11.73	99
25+50+60	1.70	3.41	4.09			9.20 (2.9 - 10.4)	2.670 (0.680 - 3.250)	11.73	99
25+50+71	1.59	3.18	4.52			9.30 (2.9 - 10.6)	2.670 (0.670 - 3.300)	11.73	99
25+60+60	1.60	3.85	3.85			9.30 (2.9 - 10.6)	2.660 (0.670 - 3.300)	11.68	99
25+60+71	1.51	3.62	4.28			9.40 (2.9 - 10.8)	2.650 (0.660 - 3.360)	11.64	99
35+35+35	2.87	2.87	2.87			8.60 (2.9 - 9.4)	2.510 (0.720 - 3.030)	11.02	99
35+35+42	2.72	2.72	3.26			8.70 (2.9 - 9.5)	2.550 (0.710 - 3.040)	11.20	99
35+35+50	2.60	2.60	3.71			8.90 (2.9 - 9.8)	2.650 (0.700 - 3.090)	11.64	99
35+35+60	2.45	2.45	4.20			9.10 (2.9 - 10.1)	2.690 (0.690 - 3.170)	11.81	99
35+35+71	2.31	2.31	4.68			9.30 (2.9 - 10.6)	2.700 (0.670 - 3.320)	11.86	99
35+42+42	2.62	3.14	3.14			8.90 (2.9 - 9.8)	2.640 (0.700 - 3.090)	11.59	99
35+42+50	2.48	2.98	3.54			9.00 (2.9 - 9.9)	2.680 (0.690 - 3.100)	11.77	99
35+42+60	2.35	2.82	4.03			9.20 (2.9 - 10.4)	2.680 (0.680 - 3.260)	11.77	99
35+42+71	2.22	2.67	4.51			9.40 (2.9 - 10.8)	2.690 (0.660 - 3.380)	11.81	99
35+50+50	2.39	3.41	3.41			9.20 (2.9 - 10.4)	2.700 (0.680 - 3.260)	11.86	99
35+50+60	2.24	3.21	3.85			9.30 (2.9 - 10.6)	2.690 (0.670 - 3.310)	11.81	99
35+50+71	2.11	3.01	4.28			9.40 (2.9 - 10.8)	2.680 (0.660 - 3.370)	11.77	99
35+60+60	2.12	3.64	3.64			9.40 (2.9 - 10.8)	2.670 (0.660 - 3.370)	11.73	99
35+60+71	1.98	3.40	4.02			9.40 (2.9 - 10.8)	2.650 (0.660 - 3.360)	11.64	99
42+42+42	3.00	3.00	3.00			9.00 (2.9 - 9.9)	2.730 (0.690 - 3.130)	11.99	99
42+42+50	2.85	2.85	3.40			9.10 (2.9 - 10.1)	2.680 (0.680 - 3.160)	11.77	99
42+42+60	2.71	2.71	3.88			9.30 (2.9 - 10.6)	2.680 (0.670 - 3.310)	11.77	99
42+42+71	2.55	2.55	4.31			9.40 (2.9 - 10.8)	2.670 (0.660 - 3.370)	11.73	99
42+50+50	2.75	3.27	3.27			9.30 (2.9 - 10.6)	2.700 (0.670 - 3.310)	11.86	99
42+50+60	2.60	3.09	3.71			9.40 (2.9 - 10.8)	2.680 (0.660 - 3.370)	11.77	99
42+50+71	2.42	2.88	4.09			9.40 (2.9 - 10.8)	2.660 (0.660 - 3.360)	11.68	99
42+60+60	2.44	3.48	3.48			9.40 (2.9 - 10.8)	2.650 (0.660 - 3.360)	11.64	99
50+50+50	3.13	3.13	3.13			9.40 (2.9 - 10.8)	2.790 (0.660 - 3.430)	12.25	99
50+50+60	2.94	2.94	3.53			9.40 (2.9 - 10.8)	2.670 (0.660 - 3.360)	11.73	99
50+50+71	2.75	2.75	3.90			9.40 (2.9 - 10.8)	2.650 (0.660 - 3.350)	11.64	99
15+15+15+15	1.50	1.50	1.50	1.50		6.00 (3.7 - 6.4)	1.300 (0.910 - 3.190)	5.71	99
15+15+15+20	1.48	1.48	1.48	1.97		6.40 (3.7 - 7.0)	1.625 (0.930 - 3.465)	7.14	99
15+15+15+22	1.48	1.48	1.48	2.17		6.60 (3.7 - 7.3)	1.665 (0.900 - 3.480)	7.31	99
15+15+15+25	1.46	1.46	1.46	2.43		6.80 (3.7 - 7.7)	1.750 (0.900 - 3.555)	7.69	99
15+15+15+35	1.43	1.43	1.43	3.33		7.60 (3.7 - 8.9)	2.075 (1.000 - 3.780)	9.11	99

MXZ-5C100VA(VA2) COOLING

Indoor units combination	Cooling capacity (kW)					Total	Outdoor unit power consumption (kW)	Current (A)	Power factor (%)
	Unit A	Unit B	Unit C	Unit D	Unit E				
15+15+15+42	1.38	1.38	1.38	3.86		8.00 (3.7 - 9.2)	1.945 (0.900 - 2.535)	8.54	99
15+15+15+50	1.33	1.33	1.33	4.42		8.40 (3.7 - 9.7)	2.100 (0.900 - 2.740)	9.22	99
15+15+15+60	1.24	1.24	1.24	4.97		8.70 (3.7 - 10.0)	2.180 (0.900 - 2.830)	9.57	99
15+15+15+71	1.15	1.15	1.15	5.45		8.90 (3.7 - 10.1)	2.215 (0.900 - 2.835)	9.73	99
15+15+20+20	1.46	1.46	1.94	1.94		6.80 (3.7 - 7.7)	1.790 (0.930 - 3.595)	7.86	99
15+15+20+22	1.46	1.46	1.94	2.14		7.00 (3.7 - 8.0)	1.830 (0.900 - 3.610)	8.04	99
15+15+20+25	1.44	1.44	1.92	2.40		7.20 (3.7 - 8.3)	1.910 (0.900 - 3.665)	8.39	99
15+15+20+35	1.39	1.39	1.86	3.25		7.90 (3.7 - 9.1)	1.995 (0.900 - 2.955)	8.76	99
15+15+20+42	1.34	1.34	1.78	3.74		8.20 (3.7 - 9.4)	2.025 (0.900 - 2.620)	8.89	99
15+15+20+50	1.29	1.29	1.72	4.30		8.60 (3.7 - 9.9)	2.180 (0.900 - 2.825)	9.57	99
15+15+20+60	1.20	1.20	1.60	4.80		8.80 (3.7 - 10.1)	2.205 (0.900 - 2.845)	9.68	99
15+15+20+71	1.12	1.12	1.49	5.28		9.00 (3.7 - 10.2)	2.245 (0.900 - 2.855)	9.86	99
15+15+22+22	1.44	1.44	2.11	2.11		7.10 (3.7 - 8.1)	1.830 (0.870 - 3.590)	8.04	99
15+15+22+25	1.44	1.44	2.11	2.40		7.40 (3.7 - 8.6)	1.955 (0.870 - 3.685)	8.59	99
15+15+22+35	1.38	1.38	2.02	3.22		8.00 (3.7 - 9.2)	1.925 (0.870 - 2.505)	8.45	99
15+15+22+42	1.32	1.32	1.94	3.71		8.30 (3.7 - 9.6)	2.030 (0.870 - 2.665)	8.92	99
15+15+22+50	1.26	1.26	1.85	4.22		8.60 (3.7 - 9.9)	2.140 (0.870 - 2.785)	9.40	99
15+15+22+60	1.18	1.18	1.73	4.71		8.80 (3.7 - 10.1)	2.165 (0.870 - 2.805)	9.51	99
15+15+22+71	1.11	1.11	1.63	5.25		9.10 (3.7 - 10.3)	2.230 (0.870 - 2.830)	9.79	99
15+15+25+25	1.43	1.43	2.38	2.38		7.60 (3.7 - 8.9)	2.035 (0.970 - 3.740)	8.94	99
15+15+25+35	1.35	1.35	2.25	3.15		8.10 (3.7 - 9.3)	1.965 (0.870 - 2.550)	8.63	99
15+15+25+42	1.31	1.31	2.19	3.68		8.50 (3.7 - 9.8)	2.110 (0.870 - 2.750)	9.27	99
15+15+25+50	1.24	1.24	2.07	4.14		8.70 (3.7 - 10.0)	2.170 (0.870 - 2.800)	9.53	99
15+15+25+60	1.16	1.16	1.93	4.64		8.90 (3.7 - 10.1)	2.195 (0.870 - 2.805)	9.64	99
15+15+25+71	1.08	1.08	1.81	5.13		9.10 (3.7 - 10.3)	2.230 (0.870 - 2.830)	9.79	99
15+15+35+35	1.29	1.29	3.01	3.01		8.60 (3.7 - 9.9)	2.170 (0.870 - 2.805)	9.53	99
15+15+35+42	1.22	1.22	2.85	3.41		8.70 (3.7 - 10.0)	2.180 (0.870 - 2.810)	9.57	99
15+15+35+50	1.16	1.16	2.71	3.87		8.90 (3.7 - 10.1)	2.225 (0.870 - 2.815)	9.77	99
15+15+35+60	1.09	1.09	2.55	4.37		9.10 (3.7 - 10.3)	2.250 (0.870 - 2.840)	9.88	99
15+15+35+71	1.03	1.03	2.39	4.86		9.30 (3.7 - 10.4)	2.285 (0.870 - 2.845)	10.04	99
15+15+42+42	1.17	1.17	3.28	3.28		8.90 (3.7 - 10.1)	2.215 (0.870 - 2.815)	9.73	99
15+15+42+50	1.11	1.11	3.10	3.69		9.00 (3.7 - 10.2)	2.235 (0.870 - 2.825)	9.82	99
15+15+42+60	1.05	1.05	2.93	4.18		9.20 (3.7 - 10.4)	2.260 (0.870 - 2.845)	9.93	99
15+15+42+71	0.99	0.99	2.76	4.67		9.40 (3.7 - 10.5)	2.295 (0.870 - 2.850)	10.08	99
15+15+50+50	1.06	1.06	3.54	3.54		9.20 (3.7 - 10.4)	2.280 (0.870 - 2.845)	10.01	99
15+15+50+60	1.01	1.01	3.36	4.03		9.40 (3.7 - 10.5)	2.305 (0.870 - 2.850)	10.12	99
15+15+50+71	0.95	0.95	3.18	4.51		9.60 (3.7 - 10.8)	2.300 (0.850 - 2.875)	10.10	99
15+20+20+20	1.44	1.92	1.92	1.92		7.20 (3.7 - 8.3)	1.950 (0.930 - 3.705)	8.56	99
15+20+20+22	1.44	1.92	1.92	2.11		7.40 (3.7 - 8.6)	1.995 (0.900 - 3.725)	8.76	99
15+20+20+25	1.43	1.90	1.90	2.38		7.60 (3.7 - 8.9)	2.075 (1.000 - 3.780)	9.11	99
15+20+20+35	1.35	1.80	1.80	3.15		8.10 (3.7 - 9.3)	2.005 (0.900 - 2.590)	8.81	99
15+20+20+42	1.31	1.75	1.75	3.68		8.50 (3.7 - 9.8)	2.150 (0.900 - 2.790)	9.44	99

MXZ-5C100VA(VA2) COOLING

Indoor units combination	Cooling capacity (kW)					Total	Outdoor unit power consumption (kW)	Current (A)	Power factor (%)
	Unit A	Unit B	Unit C	Unit D	Unit E				
15+20+20+50	1.24	1.66	1.66	4.14		8.70 (3.7 - 10.0)	2.210 (0.900 - 2.840)	9.71	99
15+20+20+60	1.16	1.55	1.55	4.64		8.90 (3.7 - 10.1)	2.235 (0.900 - 2.845)	9.82	99
15+20+20+71	1.08	1.44	1.44	5.13		9.10 (3.7 - 10.3)	2.270 (0.900 - 2.870)	9.97	99
15+20+22+22	1.42	1.90	2.09	2.09		7.50 (3.7 - 8.7)	1.995 (0.870 - 3.700)	8.76	99
15+20+22+25	1.41	1.88	2.07	2.35		7.70 (3.7 - 9.0)	2.010 (0.870 - 3.330)	8.83	99
15+20+22+35	1.34	1.78	1.96	3.12		8.20 (3.7 - 9.4)	2.005 (0.870 - 2.590)	8.81	99
15+20+22+42	1.30	1.74	1.91	3.65		8.60 (3.7 - 9.9)	2.150 (0.870 - 2.795)	9.44	99
15+20+22+50	1.22	1.63	1.79	4.07		8.70 (3.7 - 10.0)	2.170 (0.870 - 2.800)	9.53	99
15+20+22+60	1.14	1.52	1.67	4.56		8.90 (3.7 - 10.1)	2.195 (0.870 - 2.805)	9.64	99
15+20+22+71	1.08	1.44	1.58	5.10		9.20 (3.7 - 10.4)	2.260 (0.870 - 2.845)	9.93	99
15+20+25+25	1.39	1.86	2.32	2.32		7.90 (3.7 - 9.1)	1.955 (0.870 - 2.915)	8.59	99
15+20+25+35	1.33	1.77	2.21	3.09		8.40 (3.7 - 9.7)	2.090 (0.870 - 2.720)	9.18	99
15+20+25+42	1.26	1.69	2.11	3.54		8.60 (3.7 - 9.9)	2.150 (0.870 - 2.795)	9.44	99
15+20+25+50	1.20	1.60	2.00	4.00		8.80 (3.7 - 10.1)	2.195 (0.870 - 2.815)	9.64	99
15+20+25+60	1.13	1.50	1.88	4.50		9.00 (3.7 - 10.2)	2.225 (0.870 - 2.825)	9.77	99
15+20+25+71	1.05	1.40	1.76	4.99		9.20 (3.7 - 10.4)	2.260 (0.870 - 2.845)	9.93	99
15+20+35+35	1.24	1.66	2.90	2.90		8.70 (3.7 - 10.0)	2.200 (0.870 - 2.820)	9.66	99
15+20+35+42	1.18	1.57	2.75	3.30		8.80 (3.7 - 10.1)	2.205 (0.870 - 2.825)	9.68	99
15+20+35+50	1.13	1.50	2.63	3.75		9.00 (3.7 - 10.2)	2.255 (0.870 - 2.835)	9.90	99
15+20+35+60	1.06	1.42	2.48	4.25		9.20 (3.7 - 10.4)	2.280 (0.870 - 2.855)	10.01	99
15+20+35+71	1.00	1.33	2.33	4.73		9.40 (3.7 - 10.5)	2.315 (0.870 - 2.860)	10.17	99
15+20+42+42	1.13	1.51	3.18	3.18		9.00 (3.7 - 10.2)	2.245 (0.870 - 2.835)	9.86	99
15+20+42+50	1.07	1.43	3.01	3.58		9.10 (3.7 - 10.3)	2.260 (0.870 - 2.840)	9.93	99
15+20+42+60	1.02	1.36	2.85	4.07		9.30 (3.7 - 10.4)	2.285 (0.870 - 2.845)	10.04	99
15+20+42+71	0.96	1.28	2.70	4.56		9.50 (3.7 - 10.6)	2.305 (0.860 - 2.860)	10.12	99
15+20+50+50	1.03	1.38	3.44	3.44		9.30 (3.7 - 10.4)	2.305 (0.870 - 2.845)	10.12	99
15+20+50+60	0.98	1.31	3.28	3.93		9.50 (3.7 - 10.6)	2.315 (0.860 - 2.860)	10.17	99
15+20+50+71	0.92	1.23	3.08	4.37		9.60 (3.7 - 10.8)	2.300 (0.850 - 2.875)	10.10	99
15+22+22+22	1.43	2.09	2.09	2.09		7.70 (3.7 - 9.0)	1.970 (0.840 - 3.290)	8.65	99
15+22+22+25	1.39	2.04	2.04	2.32		7.80 (3.7 - 9.1)	1.940 (0.840 - 2.875)	8.52	99
15+22+22+35	1.32	1.94	1.94	3.09		8.30 (3.7 - 9.6)	2.010 (0.840 - 2.635)	8.83	99
15+22+22+42	1.28	1.87	1.87	3.58		8.60 (3.7 - 9.9)	2.110 (0.840 - 2.755)	9.27	99
15+22+22+50	1.21	1.78	1.78	4.04		8.80 (3.7 - 10.1)	2.155 (0.840 - 2.775)	9.46	99
15+22+22+60	1.13	1.66	1.66	4.54		9.00 (3.7 - 10.2)	2.185 (0.840 - 2.785)	9.60	99
15+22+22+71	1.06	1.56	1.56	5.02		9.20 (3.7 - 10.4)	2.220 (0.840 - 2.805)	9.75	99
15+22+25+25	1.38	2.02	2.30	2.30		8.00 (3.7 - 9.2)	1.885 (0.840 - 2.465)	8.28	99
15+22+25+35	1.31	1.93	2.19	3.07		8.50 (3.7 - 9.8)	2.090 (0.840 - 2.720)	9.18	99
15+22+25+42	1.25	1.84	2.09	3.51		8.70 (3.7 - 10.0)	2.140 (0.840 - 2.770)	9.40	99
15+22+25+50	1.18	1.73	1.96	3.93		8.80 (3.7 - 10.1)	2.155 (0.840 - 2.775)	9.46	99
15+22+25+60	1.11	1.62	1.84	4.43		9.00 (3.7 - 10.2)	2.185 (0.840 - 2.785)	9.60	99
15+22+25+71	1.05	1.54	1.75	4.96		9.30 (3.7 - 10.4)	2.245 (0.840 - 2.805)	9.86	99
15+22+35+35	1.22	1.79	2.85	2.85		8.70 (3.7 - 10.0)	2.160 (0.840 - 2.780)	9.49	99

MXZ-5C100VA(VA2) COOLING

Indoor units combination	Cooling capacity (kW)					Total	Outdoor unit power consumption (kW)	Current (A)	Power factor (%)
	Unit A	Unit B	Unit C	Unit D	Unit E				
15+22+35+42	1.17	1.72	2.73	3.28		8.90 (3.7 - 10.1)	2.195 (0.840 - 2.785)	9.64	99
15+22+35+50	1.11	1.62	2.58	3.69		9.00 (3.7 - 10.2)	2.215 (0.840 - 2.795)	9.73	99
15+22+35+60	1.05	1.53	2.44	4.18		9.20 (3.7 - 10.4)	2.240 (0.840 - 2.815)	9.84	99
15+22+35+71	0.99	1.45	2.30	4.67		9.40 (3.7 - 10.5)	2.275 (0.840 - 2.820)	9.99	99
15+22+42+42	1.12	1.64	3.12	3.12		9.00 (3.7 - 10.2)	2.205 (0.840 - 2.795)	9.68	99
15+22+42+50	1.07	1.57	3.00	3.57		9.20 (3.7 - 10.4)	2.250 (0.840 - 2.815)	9.88	99
15+22+42+60	1.01	1.49	2.84	4.06		9.40 (3.7 - 10.5)	2.275 (0.840 - 2.820)	9.99	99
15+22+42+71	0.95	1.39	2.66	4.50		9.50 (3.7 - 10.6)	2.265 (0.830 - 2.820)	9.95	99
15+22+50+50	1.02	1.49	3.39	3.39		9.30 (3.7 - 10.4)	2.265 (0.840 - 2.805)	9.95	99
15+22+50+60	0.97	1.42	3.23	3.88		9.50 (3.7 - 10.6)	2.275 (0.830 - 2.820)	9.99	99
15+22+50+71	0.92	1.35	3.07	4.36		9.70 (3.7 - 10.9)	2.270 (0.810 - 2.845)	9.97	99
15+25+25+25	1.35	2.25	2.25	2.25		8.10 (3.7 - 9.3)	1.925 (0.840 - 2.510)	8.45	99
15+25+25+35	1.29	2.15	2.15	3.01		8.60 (3.7 - 9.9)	2.130 (0.840 - 2.765)	9.35	99
15+25+25+42	1.22	2.03	2.03	3.41		8.70 (3.7 - 10.0)	2.140 (0.840 - 2.770)	9.40	99
15+25+25+50	1.16	1.93	1.93	3.87		8.90 (3.7 - 10.1)	2.185 (0.840 - 2.775)	9.60	99
15+25+25+60	1.09	1.82	1.82	4.37		9.10 (3.7 - 10.3)	2.210 (0.840 - 2.800)	9.71	99
15+25+25+71	1.03	1.71	1.71	4.86		9.30 (3.7 - 10.4)	2.245 (0.840 - 2.805)	9.86	99
15+25+35+35	1.20	2.00	2.80	2.80		8.80 (3.7 - 10.1)	2.185 (0.840 - 2.795)	9.60	99
15+25+35+42	1.14	1.90	2.66	3.19		8.90 (3.7 - 10.1)	2.195 (0.840 - 2.785)	9.64	99
15+25+35+50	1.09	1.82	2.55	3.64		9.10 (3.7 - 10.3)	2.240 (0.840 - 2.810)	9.84	99
15+25+35+60	1.03	1.72	2.41	4.13		9.30 (3.7 - 10.4)	2.265 (0.840 - 2.815)	9.95	99
15+25+35+71	0.98	1.63	2.28	4.62		9.50 (3.7 - 10.6)	2.285 (0.830 - 2.830)	10.04	99
15+25+42+42	1.10	1.83	3.08	3.08		9.10 (3.7 - 10.3)	2.230 (0.840 - 2.810)	9.79	99
15+25+42+50	1.05	1.74	2.93	3.48		9.20 (3.7 - 10.4)	2.250 (0.840 - 2.815)	9.88	99
15+25+42+60	0.99	1.65	2.78	3.97		9.40 (3.7 - 10.5)	2.275 (0.840 - 2.820)	9.99	99
15+25+42+71	0.94	1.57	2.64	4.45		9.60 (3.7 - 10.8)	2.270 (0.820 - 2.845)	9.97	99
15+25+50+50	1.01	1.68	3.36	3.36		9.40 (3.7 - 10.5)	2.295 (0.840 - 2.820)	10.08	99
15+25+50+60	0.95	1.58	3.17	3.80		9.50 (3.7 - 10.6)	2.275 (0.830 - 2.820)	9.99	99
15+25+50+71	0.90	1.51	3.01	4.28		9.70 (3.7 - 10.9)	2.270 (0.810 - 2.845)	9.97	99
15+35+35+35	1.13	2.63	2.63	2.63		9.00 (3.7 - 10.2)	2.245 (0.840 - 2.815)	9.86	99
15+35+35+42	1.07	2.51	2.51	3.01		9.10 (3.7 - 10.3)	2.250 (0.840 - 2.820)	9.88	99
15+35+35+50	1.03	2.41	2.41	3.44		9.30 (3.7 - 10.4)	2.295 (0.840 - 2.825)	10.08	99
15+35+35+60	0.98	2.29	2.29	3.93		9.50 (3.7 - 10.6)	2.305 (0.830 - 2.840)	10.12	99
15+35+35+71	0.92	2.15	2.15	4.37		9.60 (3.7 - 10.8)	2.290 (0.820 - 2.855)	10.06	99
15+35+42+42	1.04	2.43	2.91	2.91		9.30 (3.7 - 10.4)	2.285 (0.840 - 2.825)	10.04	99
15+35+42+50	0.99	2.32	2.78	3.31		9.40 (3.7 - 10.5)	2.305 (0.840 - 2.830)	10.12	99
15+35+42+60	0.95	2.21	2.65	3.79		9.60 (3.7 - 10.8)	2.290 (0.820 - 2.855)	10.06	99
15+35+42+71	0.89	2.08	2.50	4.23		9.70 (3.7 - 10.9)	2.280 (0.810 - 2.855)	10.01	99
15+35+50+50	0.95	2.22	3.17	3.17		9.50 (3.7 - 10.6)	2.305 (0.830 - 2.830)	10.12	99
15+35+50+60	0.91	2.12	3.03	3.64		9.70 (3.7 - 10.9)	2.290 (0.810 - 2.855)	10.06	99
15+35+50+71	0.86	2.01	2.87	4.07		9.80 (3.7 - 11.0)	2.275 (0.800 - 2.855)	9.99	99
15+42+42+42	1.00	2.80	2.80	2.80		9.40 (3.7 - 10.5)	2.295 (0.840 - 2.830)	10.08	99

MXZ-5C100VA(VA2) COOLING

Indoor units combination	Cooling capacity (kW)					Total	Outdoor unit power consumption (kW)	Current (A)	Power factor (%)
	Unit A	Unit B	Unit C	Unit D	Unit E				
15+42+42+50	0.96	2.68	2.68	3.19		9.50 (3.7 - 10.6)	2.295 (0.830 - 2.830)	10.08	99
15+42+42+60	0.92	2.56	2.56	3.66		9.70 (3.7 - 10.9)	2.280 (0.810 - 2.855)	10.01	99
15+42+42+71	0.86	2.42	2.42	4.09		9.80 (3.7 - 11.0)	2.265 (0.800 - 2.855)	9.95	99
15+42+50+50	0.92	2.57	3.06	3.06		9.60 (3.7 - 10.8)	2.290 (0.820 - 2.845)	10.06	99
15+42+50+60	0.88	2.46	2.93	3.52		9.80 (3.7 - 11.0)	2.275 (0.800 - 2.855)	9.99	99
20+20+20+20	1.90	1.90	1.90	1.90		7.60 (3.7 - 8.9)	1.955 (0.910 - 3.660)	8.59	99
20+20+20+22	1.88	1.88	1.88	2.07		7.70 (3.7 - 9.0)	2.050 (0.900 - 3.370)	9.00	99
20+20+20+25	1.86	1.86	1.86	2.32		7.90 (3.7 - 9.1)	1.995 (0.900 - 2.955)	8.76	99
20+20+20+35	1.77	1.77	1.77	3.09		8.40 (3.7 - 9.7)	2.130 (0.900 - 2.760)	9.35	99
20+20+20+42	1.69	1.69	1.69	3.54		8.60 (3.7 - 9.9)	2.190 (0.900 - 2.835)	9.62	99
20+20+20+50	1.60	1.60	1.60	4.00		8.80 (3.7 - 10.1)	2.235 (0.900 - 2.855)	9.82	99
20+20+20+60	1.50	1.50	1.50	4.50		9.00 (3.7 - 10.2)	2.265 (0.900 - 2.865)	9.95	99
20+20+20+71	1.40	1.40	1.40	4.99		9.20 (3.7 - 10.4)	2.300 (0.900 - 2.885)	10.10	99
20+20+22+22	1.86	1.86	2.04	2.04		7.80 (3.7 - 9.1)	1.980 (0.870 - 2.915)	8.70	99
20+20+22+25	1.84	1.84	2.02	2.30		8.00 (3.7 - 9.2)	1.925 (0.870 - 2.505)	8.45	99
20+20+22+35	1.75	1.75	1.93	3.07		8.50 (3.7 - 9.8)	2.130 (0.870 - 2.760)	9.35	99
20+20+22+42	1.67	1.67	1.84	3.51		8.70 (3.7 - 10.0)	2.180 (0.870 - 2.810)	9.57	99
20+20+22+50	1.57	1.57	1.73	3.93		8.80 (3.7 - 10.1)	2.195 (0.870 - 2.815)	9.64	99
20+20+22+60	1.48	1.48	1.62	4.43		9.00 (3.7 - 10.2)	2.225 (0.870 - 2.825)	9.77	99
20+20+22+71	1.40	1.40	1.54	4.96		9.30 (3.7 - 10.4)	2.285 (0.870 - 2.845)	10.04	99
20+20+25+25	1.80	1.80	2.25	2.25		8.10 (3.7 - 9.3)	1.965 (0.870 - 2.550)	8.63	99
20+20+25+35	1.72	1.72	2.15	3.01		8.60 (3.7 - 9.9)	2.170 (0.870 - 2.805)	9.53	99
20+20+25+42	1.63	1.63	2.03	3.41		8.70 (3.7 - 10.0)	2.180 (0.870 - 2.810)	9.57	99
20+20+25+50	1.55	1.55	1.93	3.87		8.90 (3.7 - 10.1)	2.225 (0.870 - 2.815)	9.77	99
20+20+25+60	1.46	1.46	1.82	4.37		9.10 (3.7 - 10.3)	2.250 (0.870 - 2.840)	9.88	99
20+20+25+71	1.37	1.37	1.71	4.86		9.30 (3.7 - 10.4)	2.285 (0.870 - 2.845)	10.04	99
20+20+35+35	1.60	1.60	2.80	2.80		8.80 (3.7 - 10.1)	2.225 (0.870 - 2.835)	9.77	99
20+20+35+42	1.52	1.52	2.66	3.19		8.90 (3.7 - 10.1)	2.235 (0.870 - 2.825)	9.82	99
20+20+35+50	1.46	1.46	2.55	3.64		9.10 (3.7 - 10.3)	2.280 (0.870 - 2.850)	10.01	99
20+20+35+60	1.38	1.38	2.41	4.13		9.30 (3.7 - 10.4)	2.305 (0.870 - 2.855)	10.12	99
20+20+35+71	1.30	1.30	2.28	4.62		9.50 (3.7 - 10.6)	2.325 (0.860 - 2.870)	10.21	99
20+20+42+42	1.47	1.47	3.08	3.08		9.10 (3.7 - 10.3)	2.270 (0.870 - 2.850)	9.97	99
20+20+42+50	1.39	1.39	2.93	3.48		9.20 (3.7 - 10.4)	2.290 (0.870 - 2.855)	10.06	99
20+20+42+60	1.32	1.32	2.78	3.97		9.40 (3.7 - 10.5)	2.315 (0.870 - 2.860)	10.17	99
20+20+42+71	1.25	1.25	2.64	4.45		9.60 (3.7 - 10.8)	2.310 (0.850 - 2.885)	10.14	99
20+20+50+50	1.34	1.34	3.36	3.36		9.40 (3.7 - 10.5)	2.335 (0.870 - 2.860)	10.25	99
20+20+50+60	1.27	1.27	3.17	3.80		9.50 (3.7 - 10.6)	2.315 (0.860 - 2.860)	10.17	99
20+20+50+71	1.20	1.20	3.01	4.28		9.70 (3.7 - 10.9)	2.310 (0.840 - 2.885)	10.14	99
20+22+22+22	1.84	2.02	2.02	2.02		7.90 (3.7 - 9.1)	1.915 (0.840 - 2.875)	8.41	99
20+22+22+25	1.82	2.00	2.00	2.28		8.10 (3.7 - 9.3)	1.925 (0.840 - 2.510)	8.45	99
20+22+22+35	1.74	1.91	1.91	3.04		8.60 (3.7 - 9.9)	2.130 (0.840 - 2.765)	9.35	99
20+22+22+42	1.64	1.81	1.81	3.45		8.70 (3.7 - 10.0)	2.140 (0.840 - 2.770)	9.40	99

MXZ-5C100VA(VA2) COOLING

Indoor units combination	Cooling capacity (kW)					Total	Outdoor unit power consumption (kW)	Current (A)	Power factor (%)
	Unit A	Unit B	Unit C	Unit D	Unit E				
20+22+22+50	1.56	1.72	1.72	3.90		8.90 (3.7 - 10.1)	2.185 (0.840 - 2.775)	9.60	99
20+22+22+60	1.47	1.61	1.61	4.40		9.10 (3.7 - 10.3)	2.210 (0.840 - 2.800)	9.71	99
20+22+22+71	1.38	1.52	1.52	4.89		9.30 (3.7 - 10.4)	2.245 (0.840 - 2.805)	9.86	99
20+22+25+25	1.78	1.96	2.23	2.23		8.20 (3.7 - 9.4)	1.965 (0.840 - 2.550)	8.63	99
20+22+25+35	1.69	1.85	2.11	2.95		8.60 (3.7 - 9.9)	2.130 (0.840 - 2.765)	9.35	99
20+22+25+42	1.61	1.78	2.02	3.39		8.80 (3.7 - 10.1)	2.165 (0.840 - 2.785)	9.51	99
20+22+25+50	1.52	1.67	1.90	3.80		8.90 (3.7 - 10.1)	2.185 (0.840 - 2.775)	9.60	99
20+22+25+60	1.43	1.58	1.79	4.30		9.10 (3.7 - 10.3)	2.210 (0.840 - 2.800)	9.71	99
20+22+25+71	1.36	1.50	1.70	4.84		9.40 (3.7 - 10.5)	2.275 (0.840 - 2.820)	9.99	99
20+22+35+35	1.57	1.73	2.75	2.75		8.80 (3.7 - 10.1)	2.185 (0.840 - 2.795)	9.60	99
20+22+35+42	1.51	1.66	2.65	3.18		9.00 (3.7 - 10.2)	2.225 (0.840 - 2.805)	9.77	99
20+22+35+50	1.43	1.58	2.51	3.58		9.10 (3.7 - 10.3)	2.240 (0.840 - 2.810)	9.84	99
20+22+35+60	1.36	1.49	2.38	4.07		9.30 (3.7 - 10.4)	2.265 (0.840 - 2.815)	9.95	99
20+22+35+71	1.28	1.41	2.25	4.56		9.50 (3.7 - 10.6)	2.285 (0.830 - 2.830)	10.04	99
20+22+42+42	1.44	1.59	3.03	3.03		9.10 (3.7 - 10.3)	2.230 (0.840 - 2.810)	9.79	99
20+22+42+50	1.39	1.53	2.91	3.47		9.30 (3.7 - 10.4)	2.275 (0.840 - 2.815)	9.99	99
20+22+42+60	1.32	1.45	2.77	3.96		9.50 (3.7 - 10.6)	2.285 (0.830 - 2.830)	10.04	99
20+22+42+71	1.24	1.36	2.60	4.40		9.60 (3.7 - 10.8)	2.270 (0.820 - 2.845)	9.97	99
20+22+50+50	1.32	1.46	3.31	3.31		9.40 (3.7 - 10.5)	2.295 (0.840 - 2.820)	10.08	99
20+22+50+60	1.26	1.39	3.16	3.79		9.60 (3.7 - 10.8)	2.280 (0.820 - 2.845)	10.01	99
20+22+50+71	1.19	1.31	2.98	4.23		9.70 (3.7 - 10.9)	2.270 (0.810 - 2.845)	9.97	99
20+25+25+25	1.77	2.21	2.21	2.21		8.40 (3.7 - 9.7)	2.050 (0.840 - 2.680)	9.00	99
20+25+25+35	1.66	2.07	2.07	2.90		8.70 (3.7 - 10.0)	2.160 (0.840 - 2.780)	9.49	99
20+25+25+42	1.57	1.96	1.96	3.30		8.80 (3.7 - 10.1)	2.165 (0.840 - 2.785)	9.51	99
20+25+25+50	1.50	1.88	1.88	3.75		9.00 (3.7 - 10.2)	2.215 (0.840 - 2.795)	9.73	99
20+25+25+60	1.42	1.77	1.77	4.25		9.20 (3.7 - 10.4)	2.240 (0.840 - 2.815)	9.84	99
20+25+25+71	1.33	1.67	1.67	4.73		9.40 (3.7 - 10.5)	2.275 (0.840 - 2.820)	9.99	99
20+25+35+35	1.55	1.93	2.71	2.71		8.90 (3.7 - 10.1)	2.215 (0.840 - 2.795)	9.73	99
20+25+35+42	1.48	1.84	2.58	3.10		9.00 (3.7 - 10.2)	2.225 (0.840 - 2.805)	9.77	99
20+25+35+50	1.42	1.77	2.48	3.54		9.20 (3.7 - 10.4)	2.270 (0.840 - 2.825)	9.97	99
20+25+35+60	1.34	1.68	2.35	4.03		9.40 (3.7 - 10.5)	2.295 (0.840 - 2.830)	10.08	99
20+25+35+71	1.27	1.59	2.23	4.51		9.60 (3.7 - 10.8)	2.290 (0.820 - 2.855)	10.06	99
20+25+42+42	1.43	1.78	3.00	3.00		9.20 (3.7 - 10.4)	2.260 (0.840 - 2.825)	9.93	99
20+25+42+50	1.36	1.70	2.85	3.39		9.30 (3.7 - 10.4)	2.275 (0.840 - 2.815)	9.99	99
20+25+42+60	1.29	1.62	2.71	3.88		9.50 (3.7 - 10.6)	2.285 (0.830 - 2.830)	10.04	99
20+25+42+71	1.23	1.53	2.58	4.36		9.70 (3.7 - 10.9)	2.280 (0.810 - 2.855)	10.01	99
20+25+50+50	1.31	1.64	3.28	3.28		9.50 (3.7 - 10.6)	2.305 (0.830 - 2.830)	10.12	99
20+25+50+60	1.24	1.55	3.10	3.72		9.60 (3.7 - 10.8)	2.280 (0.820 - 2.845)	10.01	99
20+25+50+71	1.18	1.48	2.95	4.19		9.80 (3.7 - 11.0)	2.275 (0.800 - 2.855)	9.99	99
20+35+35+35	1.46	2.55	2.55	2.55		9.10 (3.7 - 10.3)	2.270 (0.840 - 2.830)	9.97	99
20+35+35+42	1.39	2.44	2.44	2.93		9.20 (3.7 - 10.4)	2.280 (0.840 - 2.835)	10.01	99
20+35+35+50	1.34	2.35	2.35	3.36		9.40 (3.7 - 10.5)	2.325 (0.840 - 2.840)	10.21	99

MXZ-5C100VA(VA2) COOLING

Indoor units combination	Cooling capacity (kW)					Total	Outdoor unit power consumption (kW)	Current (A)	Power factor (%)
	Unit A	Unit B	Unit C	Unit D	Unit E				
20+35+35+60	1.27	2.22	2.22	3.80		9.50 (3.7 - 10.6)	2.305 (0.830 - 2.840)	10.12	99
20+35+35+71	1.20	2.11	2.11	4.28		9.70 (3.7 - 10.9)	2.300 (0.810 - 2.865)	10.10	99
20+35+42+42	1.35	2.37	2.84	2.84		9.40 (3.7 - 10.5)	2.315 (0.840 - 2.840)	10.17	99
20+35+42+50	1.29	2.26	2.71	3.23		9.50 (3.7 - 10.6)	2.315 (0.830 - 2.840)	10.17	99
20+35+42+60	1.22	2.14	2.57	3.67		9.60 (3.7 - 10.8)	2.290 (0.820 - 2.855)	10.06	99
20+35+42+71	1.17	2.04	2.45	4.14		9.80 (3.7 - 11.0)	2.285 (0.800 - 2.865)	10.04	99
20+35+50+50	1.24	2.17	3.10	3.10		9.60 (3.7 - 10.8)	2.310 (0.820 - 2.855)	10.14	99
20+35+50+60	1.19	2.08	2.97	3.56		9.80 (3.7 - 11.0)	2.295 (0.800 - 2.865)	10.08	99
20+42+42+42	1.30	2.73	2.73	2.73		9.50 (3.7 - 10.6)	2.305 (0.830 - 2.840)	10.12	99
20+42+42+50	1.25	2.62	2.62	3.12		9.60 (3.7 - 10.8)	2.300 (0.820 - 2.855)	10.10	99
20+42+42+60	1.18	2.48	2.48	3.55		9.70 (3.7 - 10.9)	2.280 (0.810 - 2.855)	10.01	99
20+42+50+50	1.20	2.51	2.99	2.99		9.70 (3.7 - 10.9)	2.300 (0.810 - 2.855)	10.10	99
20+42+50+60	1.14	2.39	2.85	3.42		9.80 (3.7 - 11.0)	2.275 (0.800 - 2.855)	9.99	99
22+22+22+22	2.00	2.00	2.00	2.00		8.00 (3.7 - 9.2)	1.845 (0.810 - 2.425)	8.10	99
22+22+22+25	1.98	1.98	1.98	2.25		8.20 (3.7 - 9.4)	1.925 (0.810 - 2.510)	8.45	99
22+22+22+35	1.87	1.87	1.87	2.98		8.60 (3.7 - 9.9)	2.090 (0.810 - 2.725)	9.18	99
22+22+22+42	1.79	1.79	1.79	3.42		8.80 (3.7 - 10.1)	2.125 (0.810 - 2.745)	9.33	99
22+22+22+50	1.69	1.69	1.69	3.84		8.90 (3.7 - 10.1)	2.145 (0.810 - 2.735)	9.42	99
22+22+22+60	1.59	1.59	1.59	4.33		9.10 (3.7 - 10.3)	2.170 (0.810 - 2.760)	9.53	99
22+22+22+71	1.49	1.49	1.49	4.82		9.30 (3.7 - 10.4)	2.205 (0.810 - 2.765)	9.68	99
22+22+25+25	1.94	1.94	2.21	2.21		8.30 (3.7 - 9.6)	1.970 (0.810 - 2.595)	8.65	99
22+22+25+35	1.84	1.84	2.09	2.93		8.70 (3.7 - 10.0)	2.120 (0.810 - 2.740)	9.31	99
22+22+25+42	1.74	1.74	1.98	3.33		8.80 (3.7 - 10.1)	2.125 (0.810 - 2.745)	9.33	99
22+22+25+50	1.66	1.66	1.89	3.78		9.00 (3.7 - 10.2)	2.175 (0.810 - 2.755)	9.55	99
22+22+25+60	1.57	1.57	1.78	4.28		9.20 (3.7 - 10.4)	2.200 (0.810 - 2.775)	9.66	99
22+22+25+71	1.48	1.48	1.68	4.77		9.40 (3.7 - 10.5)	2.235 (0.810 - 2.780)	9.82	99
22+22+35+35	1.72	1.72	2.73	2.73		8.90 (3.7 - 10.1)	2.175 (0.810 - 2.755)	9.55	99
22+22+35+42	1.64	1.64	2.60	3.12		9.00 (3.7 - 10.2)	2.185 (0.810 - 2.765)	9.60	99
22+22+35+50	1.57	1.57	2.50	3.57		9.20 (3.7 - 10.4)	2.230 (0.810 - 2.785)	9.79	99
22+22+35+60	1.49	1.49	2.37	4.06		9.40 (3.7 - 10.5)	2.255 (0.810 - 2.790)	9.90	99
22+22+35+71	1.39	1.39	2.22	4.50		9.50 (3.7 - 10.6)	2.245 (0.800 - 2.790)	9.86	99
22+22+42+42	1.58	1.58	3.02	3.02		9.20 (3.7 - 10.4)	2.220 (0.810 - 2.785)	9.75	99
22+22+42+50	1.50	1.50	2.87	3.42		9.30 (3.7 - 10.4)	2.235 (0.810 - 2.775)	9.82	99
22+22+42+60	1.43	1.43	2.73	3.90		9.50 (3.7 - 10.6)	2.245 (0.800 - 2.790)	9.86	99
22+22+42+71	1.35	1.35	2.57	4.34		9.60 (3.7 - 10.8)	2.230 (0.790 - 2.805)	9.79	99
22+22+50+50	1.45	1.45	3.30	3.30		9.50 (3.7 - 10.6)	2.265 (0.800 - 2.790)	9.95	99
22+22+50+60	1.37	1.37	3.12	3.74		9.60 (3.7 - 10.8)	2.240 (0.790 - 2.805)	9.84	99
22+22+50+71	1.31	1.31	2.97	4.22		9.80 (3.7 - 11.0)	2.235 (0.770 - 2.815)	9.82	99
22+25+25+25	1.93	2.19	2.19	2.19		8.50 (3.7 - 9.8)	2.050 (0.810 - 2.680)	9.00	99
22+25+25+35	1.79	2.03	2.03	2.85		8.70 (3.7 - 10.0)	2.120 (0.810 - 2.740)	9.31	99
22+25+25+42	1.72	1.95	1.95	3.28		8.90 (3.7 - 10.1)	2.155 (0.810 - 2.745)	9.46	99
22+25+25+50	1.62	1.84	1.84	3.69		9.00 (3.7 - 10.2)	2.175 (0.810 - 2.755)	9.55	99

MXZ-5C100VA(VA2) COOLING

Indoor units combination	Cooling capacity (kW)					Total	Outdoor unit power consumption (kW)	Current (A)	Power factor (%)
	Unit A	Unit B	Unit C	Unit D	Unit E				
22+25+25+60	1.53	1.74	1.74	4.18		9.20 (3.7 - 10.4)	2.200 (0.810 - 2.775)	9.66	99
22+25+25+71	1.45	1.64	1.64	4.67		9.40 (3.7 - 10.5)	2.235 (0.810 - 2.780)	9.82	99
22+25+35+35	1.67	1.90	2.66	2.66		8.90 (3.7 - 10.1)	2.175 (0.810 - 2.755)	9.55	99
22+25+35+42	1.61	1.83	2.57	3.08		9.10 (3.7 - 10.3)	2.210 (0.810 - 2.780)	9.71	99
22+25+35+50	1.53	1.74	2.44	3.48		9.20 (3.7 - 10.4)	2.230 (0.810 - 2.785)	9.79	99
22+25+35+60	1.46	1.65	2.32	3.97		9.40 (3.7 - 10.5)	2.255 (0.810 - 2.790)	9.90	99
22+25+35+71	1.38	1.57	2.20	4.45		9.60 (3.7 - 10.8)	2.250 (0.790 - 2.815)	9.88	99
22+25+42+42	1.55	1.76	2.95	2.95		9.20 (3.7 - 10.4)	2.220 (0.810 - 2.785)	9.75	99
22+25+42+50	1.49	1.69	2.84	3.38		9.40 (3.7 - 10.5)	2.265 (0.810 - 2.790)	9.95	99
22+25+42+60	1.40	1.59	2.68	3.83		9.50 (3.7 - 10.6)	2.245 (0.800 - 2.790)	9.86	99
22+25+42+71	1.33	1.52	2.55	4.30		9.70 (3.7 - 10.9)	2.240 (0.780 - 2.815)	9.84	99
22+25+50+50	1.42	1.62	3.23	3.23		9.50 (3.7 - 10.6)	2.265 (0.800 - 2.790)	9.95	99
22+25+50+60	1.35	1.53	3.06	3.67		9.60 (3.7 - 10.8)	2.240 (0.790 - 2.805)	9.84	99
22+25+50+71	1.28	1.46	2.92	4.14		9.80 (3.7 - 11.0)	2.235 (0.770 - 2.815)	9.82	99
22+35+35+35	1.58	2.51	2.51	2.51		9.10 (3.7 - 10.3)	2.230 (0.810 - 2.790)	9.79	99
22+35+35+42	1.53	2.43	2.43	2.91		9.30 (3.7 - 10.4)	2.265 (0.810 - 2.795)	9.95	99
22+35+35+50	1.46	2.32	2.32	3.31		9.40 (3.7 - 10.5)	2.285 (0.810 - 2.800)	10.04	99
22+35+35+60	1.39	2.21	2.21	3.79		9.60 (3.7 - 10.8)	2.270 (0.790 - 2.825)	9.97	99
22+35+35+71	1.31	2.08	2.08	4.23		9.70 (3.7 - 10.9)	2.260 (0.780 - 2.825)	9.93	99
22+35+42+42	1.47	2.33	2.80	2.80		9.40 (3.7 - 10.5)	2.275 (0.810 - 2.800)	9.99	99
22+35+42+50	1.40	2.23	2.68	3.19		9.50 (3.7 - 10.6)	2.275 (0.800 - 2.800)	9.99	99
22+35+42+60	1.34	2.14	2.56	3.66		9.70 (3.7 - 10.9)	2.260 (0.780 - 2.825)	9.93	99
22+35+42+71	1.27	2.02	2.42	4.09		9.80 (3.7 - 11.0)	2.245 (0.770 - 2.825)	9.86	99
22+35+50+50	1.35	2.14	3.06	3.06		9.60 (3.7 - 10.8)	2.270 (0.790 - 2.815)	9.97	99
22+35+50+60	1.29	2.05	2.93	3.52		9.80 (3.7 - 11.0)	2.255 (0.770 - 2.825)	9.90	99
22+42+42+42	1.41	2.70	2.70	2.70		9.50 (3.7 - 10.6)	2.265 (0.800 - 2.800)	9.95	99
22+42+42+50	1.35	2.58	2.58	3.08		9.60 (3.7 - 10.8)	2.260 (0.790 - 2.815)	9.93	99
22+42+42+60	1.30	2.48	2.48	3.54		9.80 (3.7 - 11.0)	2.245 (0.770 - 2.825)	9.86	99
22+42+50+50	1.30	2.48	2.96	2.96		9.70 (3.7 - 10.9)	2.260 (0.780 - 2.815)	9.93	99
25+25+25+25	2.15	2.15	2.15	2.15		8.60 (3.7 - 9.9)	2.090 (0.810 - 2.725)	9.18	99
25+25+25+35	2.00	2.00	2.00	2.80		8.80 (3.7 - 10.1)	2.145 (0.810 - 2.755)	9.42	99
25+25+25+42	1.90	1.90	1.90	3.19		8.90 (3.7 - 10.1)	2.155 (0.810 - 2.745)	9.46	99
25+25+25+50	1.82	1.82	1.82	3.64		9.10 (3.7 - 10.3)	2.200 (0.810 - 2.770)	9.66	99
25+25+25+60	1.72	1.72	1.72	4.13		9.30 (3.7 - 10.4)	2.225 (0.810 - 2.775)	9.77	99
25+25+25+71	1.63	1.63	1.63	4.62		9.50 (3.7 - 10.6)	2.245 (0.800 - 2.790)	9.86	99
25+25+35+35	1.88	1.88	2.63	2.63		9.00 (3.7 - 10.2)	2.205 (0.810 - 2.775)	9.68	99
25+25+35+42	1.79	1.79	2.51	3.01		9.10 (3.7 - 10.3)	2.210 (0.810 - 2.780)	9.71	99
25+25+35+50	1.72	1.72	2.41	3.44		9.30 (3.7 - 10.4)	2.255 (0.810 - 2.785)	9.90	99
25+25+35+60	1.64	1.64	2.29	3.93		9.50 (3.7 - 10.6)	2.265 (0.800 - 2.800)	9.95	99
25+25+35+71	1.54	1.54	2.15	4.37		9.60 (3.7 - 10.8)	2.250 (0.790 - 2.815)	9.88	99
25+25+42+42	1.74	1.74	2.91	2.91		9.30 (3.7 - 10.4)	2.245 (0.810 - 2.785)	9.86	99
25+25+42+50	1.65	1.65	2.78	3.31		9.40 (3.7 - 10.5)	2.265 (0.810 - 2.790)	9.95	99

MXZ-5C100VA(VA2) COOLING

Indoor units combination	Cooling capacity (kW)					Total	Outdoor unit power consumption (kW)	Current (A)	Power factor (%)
	Unit A	Unit B	Unit C	Unit D	Unit E				
25+25+42+60	1.58	1.58	2.65	3.79		9.60 (3.7 - 10.8)	2.250 (0.790 - 2.815)	9.88	99
25+25+42+71	1.49	1.49	2.50	4.23		9.70 (3.7 - 10.9)	2.240 (0.780 - 2.815)	9.84	99
25+25+50+50	1.58	1.58	3.17	3.17		9.50 (3.7 - 10.6)	2.265 (0.800 - 2.790)	9.95	99
25+25+50+60	1.52	1.52	3.03	3.64		9.70 (3.7 - 10.9)	2.250 (0.780 - 2.815)	9.88	99
25+25+50+71	1.43	1.43	2.87	4.07		9.80 (3.7 - 11.0)	2.235 (0.770 - 2.815)	9.82	99
25+35+35+35	1.77	2.48	2.48	2.48		9.20 (3.7 - 10.4)	2.260 (0.810 - 2.805)	9.93	99
25+35+35+42	1.70	2.38	2.38	2.85		9.30 (3.7 - 10.4)	2.265 (0.810 - 2.795)	9.95	99
25+35+35+50	1.64	2.29	2.29	3.28		9.50 (3.7 - 10.6)	2.295 (0.800 - 2.810)	10.08	99
25+35+35+60	1.55	2.17	2.17	3.72		9.60 (3.7 - 10.8)	2.270 (0.790 - 2.825)	9.97	99
25+35+35+71	1.48	2.07	2.07	4.19		9.80 (3.7 - 11.0)	2.265 (0.770 - 2.835)	9.95	99
25+35+42+42	1.65	2.31	2.77	2.77		9.50 (3.7 - 10.6)	2.285 (0.800 - 2.810)	10.04	99
25+35+42+50	1.58	2.21	2.65	3.16		9.60 (3.7 - 10.8)	2.280 (0.790 - 2.825)	10.01	99
25+35+42+60	1.50	2.10	2.51	3.59		9.70 (3.7 - 10.9)	2.260 (0.780 - 2.825)	9.93	99
25+42+42+42	1.59	2.67	2.67	2.67		9.60 (3.7 - 10.8)	2.270 (0.790 - 2.825)	9.97	99
25+42+42+50	1.53	2.56	2.56	3.05		9.70 (3.7 - 10.9)	2.270 (0.780 - 2.825)	9.97	99
25+42+42+60	1.45	2.44	2.44	3.48		9.80 (3.7 - 11.0)	2.245 (0.770 - 2.825)	9.86	99
25+42+50+50	1.47	2.46	2.93	2.93		9.80 (3.7 - 11.0)	2.265 (0.770 - 2.825)	9.95	99
35+35+35+35	2.35	2.35	2.35	2.35		9.40 (3.7 - 10.5)	2.315 (0.810 - 2.820)	10.17	99
35+35+35+42	2.26	2.26	2.26	2.71		9.50 (3.7 - 10.6)	2.305 (0.800 - 2.820)	10.12	99
35+35+35+50	2.17	2.17	2.17	3.10		9.60 (3.7 - 10.8)	2.300 (0.790 - 2.835)	10.10	99
35+35+35+60	2.08	2.08	2.08	3.56		9.80 (3.7 - 11.0)	2.285 (0.770 - 2.845)	10.04	99
35+35+42+42	2.18	2.18	2.62	2.62		9.60 (3.7 - 10.8)	2.290 (0.790 - 2.835)	10.06	99
35+35+42+50	2.10	2.10	2.51	2.99		9.70 (3.7 - 10.9)	2.290 (0.780 - 2.835)	10.06	99
35+42+42+42	2.11	2.53	2.53	2.53		9.70 (3.7 - 10.9)	2.280 (0.780 - 2.835)	10.01	99
35+42+42+50	2.03	2.44	2.44	2.90		9.80 (3.7 - 11.0)	2.275 (0.770 - 2.835)	9.99	99
42+42+42+42	2.45	2.45	2.45	2.45		9.80 (3.7 - 11.0)	2.345 (0.770 - 2.875)	10.30	99
15+15+15+15+15	1.50	1.50	1.50	1.50	1.50	7.50 (3.9 - 8.4)	1.980 (1.090 - 3.435)	8.70	99
15+15+15+15+20	1.48	1.48	1.48	1.48	1.98	7.90 (3.9 - 8.8)	2.390 (1.080 - 3.710)	10.50	99
15+15+15+15+22	1.48	1.48	1.48	1.48	2.17	8.10 (3.9 - 9.0)	2.455 (1.020 - 3.705)	10.78	99
15+15+15+15+25	1.46	1.46	1.46	1.46	2.44	8.30 (3.9 - 9.2)	2.560 (1.020 - 3.745)	11.24	99
15+15+15+15+35	1.44	1.44	1.44	1.44	3.35	9.10 (3.9 - 10.1)	2.975 (1.020 - 3.910)	13.07	99
15+15+15+15+42	1.41	1.41	1.41	1.41	3.95	9.60 (3.9 - 10.6)	3.120 (1.020 - 3.895)	13.70	99
15+15+15+15+50	1.36	1.36	1.36	1.36	4.55	10.00 (3.9 - 11.0)	2.930 (1.020 - 3.565)	12.87	99
15+15+15+15+60	1.25	1.25	1.25	1.25	5.00	10.00 (3.9 - 11.0)	2.900 (1.020 - 3.555)	12.74	99
15+15+15+15+71	1.15	1.15	1.15	1.15	5.42	10.00 (3.9 - 11.0)	2.880 (1.020 - 3.545)	12.65	99
15+15+15+20+20	1.46	1.46	1.46	1.95	1.95	8.30 (3.9 - 9.2)	2.600 (1.080 - 3.785)	11.42	99
15+15+15+20+22	1.47	1.47	1.47	1.95	2.15	8.50 (3.9 - 9.5)	2.665 (1.020 - 3.800)	11.70	99
15+15+15+20+25	1.45	1.45	1.45	1.93	2.42	8.70 (3.9 - 9.7)	2.765 (1.020 - 3.835)	12.14	99
15+15+15+20+35	1.43	1.43	1.43	1.90	3.33	9.50 (3.9 - 10.5)	3.185 (1.330 - 3.985)	13.99	99
15+15+15+20+42	1.39	1.39	1.39	1.85	3.89	9.90 (3.9 - 10.9)	2.985 (1.020 - 3.655)	13.11	99
15+15+15+20+50	1.30	1.30	1.30	1.74	4.35	10.00 (3.9 - 11.0)	2.930 (1.020 - 3.565)	12.87	99
15+15+15+20+60	1.20	1.20	1.20	1.60	4.80	10.00 (3.9 - 11.0)	2.900 (1.020 - 3.555)	12.74	99

MXZ-5C100VA(VA2) COOLING

Indoor units combination	Cooling capacity (kW)					Total	Outdoor unit power consumption (kW)	Current (A)	Power factor (%)
	Unit A	Unit B	Unit C	Unit D	Unit E				
15+15+15+20+71	1.10	1.10	1.10	1.47	5.22	10.00 (3.9 - 11.0)	2.880 (1.020 - 3.545)	12.65	99
15+15+15+22+22	1.45	1.45	1.45	2.13	2.13	8.60 (3.9 - 9.6)	2.675 (0.960 - 3.780)	11.75	99
15+15+15+22+25	1.45	1.45	1.45	2.13	2.42	8.90 (3.9 - 9.9)	2.830 (0.960 - 3.835)	12.43	99
15+15+15+22+35	1.41	1.41	1.41	2.07	3.29	9.60 (3.9 - 10.6)	3.100 (0.960 - 3.865)	13.61	99
15+15+15+22+42	1.38	1.38	1.38	2.02	3.85	10.00 (3.9 - 11.0)	2.900 (0.960 - 3.535)	12.74	99
15+15+15+22+50	1.28	1.28	1.28	1.88	4.27	10.00 (3.9 - 11.0)	2.890 (0.960 - 3.525)	12.69	99
15+15+15+22+60	1.18	1.18	1.18	1.73	4.72	10.00 (3.9 - 11.0)	2.860 (0.960 - 3.515)	12.56	99
15+15+15+22+71	1.09	1.09	1.09	1.59	5.14	10.00 (3.9 - 11.0)	2.840 (0.960 - 3.505)	12.47	99
15+15+15+25+25	1.44	1.44	1.44	2.39	2.39	9.10 (3.9 - 10.1)	2.935 (0.960 - 3.870)	12.89	99
15+15+15+25+35	1.40	1.40	1.40	2.33	3.27	9.80 (3.9 - 10.8)	3.010 (0.960 - 3.705)	13.22	99
15+15+15+25+42	1.34	1.34	1.34	2.23	3.75	10.00 (3.9 - 11.0)	2.900 (0.960 - 3.535)	12.74	99
15+15+15+25+50	1.25	1.25	1.25	2.08	4.17	10.00 (3.9 - 11.0)	2.890 (0.960 - 3.525)	12.69	99
15+15+15+25+60	1.15	1.15	1.15	1.92	4.62	10.00 (3.9 - 11.0)	2.860 (0.960 - 3.515)	12.56	99
15+15+15+25+71	1.06	1.06	1.06	1.77	5.04	10.00 (3.9 - 11.0)	2.840 (0.960 - 3.505)	12.47	99
15+15+15+35+35	1.30	1.30	1.30	3.04	3.04	10.00 (3.9 - 11.0)	2.920 (0.960 - 3.545)	12.82	99
15+15+15+35+42	1.23	1.23	1.23	2.87	3.44	10.00 (3.9 - 11.0)	2.900 (0.960 - 3.535)	12.74	99
15+15+15+35+50	1.15	1.15	1.15	2.69	3.85	10.00 (3.9 - 11.0)	2.890 (0.960 - 3.525)	12.69	99
15+15+15+35+60	1.07	1.07	1.07	2.50	4.29	10.00 (3.9 - 11.0)	2.860 (0.960 - 3.515)	12.56	99
15+15+15+35+71	0.99	0.99	0.99	2.32	4.70	10.00 (3.9 - 11.0)	2.840 (0.960 - 3.505)	12.47	99
15+15+15+42+42	1.16	1.16	1.16	3.26	3.26	10.00 (3.9 - 11.0)	2.880 (0.960 - 3.525)	12.65	99
15+15+15+42+50	1.09	1.09	1.09	3.07	3.65	10.00 (3.9 - 11.0)	2.870 (0.960 - 3.515)	12.60	99
15+15+15+42+60	1.02	1.02	1.02	2.86	4.08	10.00 (3.9 - 11.0)	2.840 (0.960 - 3.505)	12.47	99
15+15+15+42+71	0.95	0.95	0.95	2.66	4.49	10.00 (3.9 - 11.0)	2.820 (0.960 - 3.495)	12.38	99
15+15+20+20+20	1.45	1.45	1.93	1.93	1.93	8.70 (3.9 - 9.7)	2.805 (1.080 - 3.875)	12.32	99
15+15+20+20+22	1.45	1.45	1.93	1.93	2.13	8.90 (3.9 - 9.9)	2.870 (1.020 - 3.875)	12.60	99
15+15+20+20+25	1.44	1.44	1.92	1.92	2.39	9.10 (3.9 - 10.1)	2.975 (1.020 - 3.910)	13.07	99
15+15+20+20+35	1.40	1.40	1.87	1.87	3.27	9.80 (3.9 - 10.8)	3.050 (1.020 - 3.745)	13.39	99
15+15+20+20+42	1.34	1.34	1.79	1.79	3.75	10.00 (3.9 - 11.0)	2.940 (1.020 - 3.575)	12.91	99
15+15+20+20+50	1.25	1.25	1.67	1.67	4.17	10.00 (3.9 - 11.0)	2.930 (1.020 - 3.565)	12.87	99
15+15+20+20+60	1.15	1.15	1.54	1.54	4.62	10.00 (3.9 - 11.0)	2.900 (1.020 - 3.555)	12.74	99
15+15+20+20+71	1.06	1.06	1.42	1.42	5.04	10.00 (3.9 - 11.0)	2.880 (1.020 - 3.545)	12.65	99
15+15+20+22+22	1.44	1.44	1.91	2.11	2.11	9.00 (3.9 - 10.0)	2.885 (0.960 - 3.850)	12.67	99
15+15+20+22+25	1.44	1.44	1.92	2.11	2.40	9.30 (3.9 - 10.3)	3.040 (0.960 - 3.910)	13.35	99
15+15+20+22+35	1.39	1.39	1.85	2.04	3.24	9.90 (3.9 - 10.9)	2.965 (0.960 - 3.625)	13.02	99
15+15+20+22+42	1.32	1.32	1.75	1.93	3.68	10.00 (3.9 - 11.0)	2.900 (0.960 - 3.535)	12.74	99
15+15+20+22+50	1.23	1.23	1.64	1.80	4.10	10.00 (3.9 - 11.0)	2.890 (0.960 - 3.525)	12.69	99
15+15+20+22+60	1.14	1.14	1.52	1.67	4.55	10.00 (3.9 - 11.0)	2.860 (0.960 - 3.515)	12.56	99
15+15+20+22+71	1.05	1.05	1.40	1.54	4.97	10.00 (3.9 - 11.0)	2.840 (0.960 - 3.505)	12.47	99
15+15+20+25+25	1.43	1.43	1.90	2.38	2.38	9.50 (3.9 - 10.5)	3.145 (1.270 - 3.945)	13.81	99
15+15+20+25+35	1.36	1.36	1.82	2.27	3.18	10.00 (3.9 - 11.0)	2.920 (0.960 - 3.545)	12.82	99
15+15+20+25+42	1.28	1.28	1.71	2.14	3.59	10.00 (3.9 - 11.0)	2.900 (0.960 - 3.535)	12.74	99
15+15+20+25+50	1.20	1.20	1.60	2.00	4.00	10.00 (3.9 - 11.0)	2.890 (0.960 - 3.525)	12.69	99

MXZ-5C100VA(VA2) COOLING

Indoor units combination	Cooling capacity (kW)					Total	Outdoor unit power consumption (kW)	Current (A)	Power factor (%)
	Unit A	Unit B	Unit C	Unit D	Unit E				
15+15+20+25+60	1.11	1.11	1.48	1.85	4.44	10.00 (3.9 - 11.0)	2.860 (0.960 - 3.515)	12.56	99
15+15+20+25+71	1.03	1.03	1.37	1.71	4.86	10.00 (3.9 - 11.0)	2.840 (0.960 - 3.505)	12.47	99
15+15+20+35+35	1.25	1.25	1.67	2.92	2.92	10.00 (3.9 - 11.0)	2.920 (0.960 - 3.545)	12.82	99
15+15+20+35+42	1.18	1.18	1.57	2.76	3.31	10.00 (3.9 - 11.0)	2.900 (0.960 - 3.535)	12.74	99
15+15+20+35+50	1.11	1.11	1.48	2.59	3.70	10.00 (3.9 - 11.0)	2.890 (0.960 - 3.525)	12.69	99
15+15+20+35+60	1.03	1.03	1.38	2.41	4.14	10.00 (3.9 - 11.0)	2.860 (0.960 - 3.515)	12.56	99
15+15+20+35+71	0.96	0.96	1.28	2.24	4.55	10.00 (3.9 - 11.0)	2.840 (0.960 - 3.505)	12.47	99
15+15+20+42+42	1.12	1.12	1.49	3.13	3.13	10.00 (3.9 - 11.0)	2.880 (0.960 - 3.525)	12.65	99
15+15+20+42+50	1.06	1.06	1.41	2.96	3.52	10.00 (3.9 - 11.0)	2.870 (0.960 - 3.515)	12.60	99
15+15+20+42+60	0.99	0.99	1.32	2.76	3.95	10.00 (3.9 - 11.0)	2.840 (0.960 - 3.505)	12.47	99
15+15+20+42+71	0.92	0.92	1.23	2.58	4.36	10.00 (3.9 - 11.0)	2.820 (0.960 - 3.495)	12.38	99
15+15+22+22+22	1.44	1.44	2.11	2.11	2.11	9.20 (3.9 - 10.2)	2.950 (0.900 - 3.850)	12.96	99
15+15+22+22+25	1.42	1.42	2.09	2.09	2.37	9.40 (3.9 - 10.4)	3.055 (0.900 - 3.885)	13.42	99
15+15+22+22+35	1.38	1.38	2.02	2.02	3.21	10.00 (3.9 - 11.0)	2.880 (0.900 - 3.505)	12.65	99
15+15+22+22+42	1.29	1.29	1.90	1.90	3.62	10.00 (3.9 - 11.0)	2.860 (0.900 - 3.495)	12.56	99
15+15+22+22+50	1.21	1.21	1.77	1.77	4.03	10.00 (3.9 - 11.0)	2.850 (0.900 - 3.485)	12.52	99
15+15+22+22+60	1.12	1.12	1.64	1.64	4.48	10.00 (3.9 - 11.0)	2.820 (0.900 - 3.475)	12.38	99
15+15+22+22+71	1.03	1.03	1.52	1.52	4.90	10.00 (3.9 - 11.0)	2.800 (0.900 - 3.465)	12.30	99
15+15+22+25+25	1.41	1.41	2.07	2.35	2.35	9.60 (3.9 - 10.6)	3.060 (0.900 - 3.825)	13.44	99
15+15+22+25+35	1.34	1.34	1.96	2.23	3.13	10.00 (3.9 - 11.0)	2.880 (0.900 - 3.505)	12.65	99
15+15+22+25+42	1.26	1.26	1.85	2.10	3.53	10.00 (3.9 - 11.0)	2.860 (0.900 - 3.495)	12.56	99
15+15+22+25+50	1.18	1.18	1.73	1.97	3.94	10.00 (3.9 - 11.0)	2.850 (0.900 - 3.485)	12.52	99
15+15+22+25+60	1.09	1.09	1.61	1.82	4.38	10.00 (3.9 - 11.0)	2.820 (0.900 - 3.475)	12.38	99
15+15+22+25+71	1.01	1.01	1.49	1.69	4.80	10.00 (3.9 - 11.0)	2.800 (0.900 - 3.465)	12.30	99
15+15+22+35+35	1.23	1.23	1.80	2.87	2.87	10.00 (3.9 - 11.0)	2.880 (0.900 - 3.505)	12.65	99
15+15+22+35+42	1.16	1.16	1.71	2.71	3.26	10.00 (3.9 - 11.0)	2.860 (0.900 - 3.495)	12.56	99
15+15+22+35+50	1.09	1.09	1.61	2.55	3.65	10.00 (3.9 - 11.0)	2.850 (0.900 - 3.485)	12.52	99
15+15+22+35+60	1.02	1.02	1.50	2.38	4.08	10.00 (3.9 - 11.0)	2.820 (0.900 - 3.475)	12.38	99
15+15+22+35+71	0.95	0.95	1.39	2.22	4.49	10.00 (3.9 - 11.0)	2.800 (0.900 - 3.465)	12.30	99
15+15+22+42+42	1.10	1.10	1.62	3.09	3.09	10.00 (3.9 - 11.0)	2.840 (0.900 - 3.485)	12.47	99
15+15+22+42+50	1.04	1.04	1.53	2.92	3.47	10.00 (3.9 - 11.0)	2.830 (0.900 - 3.475)	12.43	99
15+15+22+42+60	0.97	0.97	1.43	2.73	3.90	10.00 (3.9 - 11.0)	2.800 (0.900 - 3.465)	12.30	99
15+15+22+42+71	0.91	0.91	1.33	2.55	4.30	10.00 (3.9 - 11.0)	2.780 (0.900 - 3.455)	12.21	99
15+15+25+25+25	1.40	1.40	2.33	2.33	2.33	9.80 (3.9 - 10.8)	2.970 (0.900 - 3.665)	13.04	99
15+15+25+25+35	1.30	1.30	2.17	2.17	3.04	10.00 (3.9 - 11.0)	2.880 (0.900 - 3.505)	12.65	99
15+15+25+25+42	1.23	1.23	2.05	2.05	3.44	10.00 (3.9 - 11.0)	2.860 (0.900 - 3.495)	12.56	99
15+15+25+25+50	1.15	1.15	1.92	1.92	3.85	10.00 (3.9 - 11.0)	2.850 (0.900 - 3.485)	12.52	99
15+15+25+25+60	1.07	1.07	1.79	1.79	4.29	10.00 (3.9 - 11.0)	2.820 (0.900 - 3.475)	12.38	99
15+15+25+25+71	0.99	0.99	1.66	1.66	4.70	10.00 (3.9 - 11.0)	2.800 (0.900 - 3.465)	12.30	99
15+15+25+35+35	1.20	1.20	2.00	2.80	2.80	10.00 (3.9 - 11.0)	2.880 (0.900 - 3.505)	12.65	99
15+15+25+35+42	1.14	1.14	1.89	2.65	3.18	10.00 (3.9 - 11.0)	2.860 (0.900 - 3.495)	12.56	99
15+15+25+35+50	1.07	1.07	1.79	2.50	3.57	10.00 (3.9 - 11.0)	2.850 (0.900 - 3.485)	12.52	99

MXZ-5C100VA(VA2) COOLING

Indoor units combination	Cooling capacity (kW)						Outdoor unit power consumption (kW)	Current (A)	Power factor (%)
	Unit A	Unit B	Unit C	Unit D	Unit E	Total			
15+15+25+35+60	1.00	1.00	1.67	2.33	4.00	10.00 (3.9 - 11.0)	2.820 (0.900 - 3.475)	12.38	99
15+15+25+35+71	0.93	0.93	1.55	2.17	4.41	10.00 (3.9 - 11.0)	2.800 (0.900 - 3.465)	12.30	99
15+15+25+42+42	1.08	1.08	1.80	3.02	3.02	10.00 (3.9 - 11.0)	2.840 (0.900 - 3.485)	12.47	99
15+15+25+42+50	1.02	1.02	1.70	2.86	3.40	10.00 (3.9 - 11.0)	2.830 (0.900 - 3.475)	12.43	99
15+15+25+42+60	0.96	0.96	1.59	2.68	3.82	10.00 (3.9 - 11.0)	2.800 (0.900 - 3.465)	12.30	99
15+15+25+42+71	0.89	0.89	1.49	2.50	4.23	10.00 (3.9 - 11.0)	2.780 (0.900 - 3.455)	12.21	99
15+15+35+35+35	1.11	1.11	2.59	2.59	2.59	10.00 (3.9 - 11.0)	2.880 (0.900 - 3.505)	12.65	99
15+15+35+35+42	1.06	1.06	2.46	2.46	2.96	10.00 (3.9 - 11.0)	2.860 (0.900 - 3.495)	12.56	99
15+15+35+35+50	1.00	1.00	2.33	2.33	3.33	10.00 (3.9 - 11.0)	2.850 (0.900 - 3.485)	12.52	99
15+15+35+35+60	0.94	0.94	2.19	2.19	3.75	10.00 (3.9 - 11.0)	2.820 (0.900 - 3.475)	12.38	99
15+15+35+35+71	0.88	0.88	2.05	2.05	4.15	10.00 (3.9 - 11.0)	2.800 (0.900 - 3.465)	12.30	99
15+15+35+42+42	1.01	1.01	2.35	2.82	2.82	10.00 (3.9 - 11.0)	2.840 (0.900 - 3.485)	12.47	99
15+15+35+42+50	0.96	0.96	2.23	2.68	3.18	10.00 (3.9 - 11.0)	2.830 (0.900 - 3.475)	12.43	99
15+15+35+42+60	0.90	0.90	2.10	2.51	3.59	10.00 (3.9 - 11.0)	2.800 (0.900 - 3.465)	12.30	99
15+15+42+42+42	0.96	0.96	2.69	2.69	2.69	10.00 (3.9 - 11.0)	2.820 (0.900 - 3.475)	12.38	99
15+15+42+42+50	0.91	0.91	2.56	2.56	3.05	10.00 (3.9 - 11.0)	2.810 (0.900 - 3.465)	12.34	99
15+20+20+20+20	1.44	1.92	1.92	1.92	1.92	9.10 (3.9 - 10.1)	3.015 (1.080 - 3.950)	13.24	99
15+20+20+20+22	1.44	1.92	1.92	1.92	2.11	9.30 (3.9 - 10.3)	3.080 (1.020 - 3.950)	13.53	99
15+20+20+20+25	1.43	1.90	1.90	1.90	2.38	9.50 (3.9 - 10.5)	3.185 (1.330 - 3.985)	13.99	99
15+20+20+20+35	1.36	1.82	1.82	1.82	3.18	10.00 (3.9 - 11.0)	2.960 (1.020 - 3.585)	13.00	99
15+20+20+20+42	1.28	1.71	1.71	1.71	3.59	10.00 (3.9 - 11.0)	2.940 (1.020 - 3.575)	12.91	99
15+20+20+20+50	1.20	1.60	1.60	1.60	4.00	10.00 (3.9 - 11.0)	2.930 (1.020 - 3.565)	12.87	99
15+20+20+20+60	1.11	1.48	1.48	1.48	4.44	10.00 (3.9 - 11.0)	2.900 (1.020 - 3.555)	12.74	99
15+20+20+20+71	1.03	1.37	1.37	1.37	4.86	10.00 (3.9 - 11.0)	2.880 (1.020 - 3.545)	12.65	99
15+20+20+22+22	1.42	1.90	1.90	2.09	2.09	9.40 (3.9 - 10.4)	3.095 (0.960 - 3.925)	13.59	99
15+20+20+22+25	1.41	1.88	1.88	2.07	2.35	9.60 (3.9 - 10.6)	3.100 (0.960 - 3.865)	13.61	99
15+20+20+22+35	1.34	1.79	1.79	1.96	3.13	10.00 (3.9 - 11.0)	2.920 (0.960 - 3.545)	12.82	99
15+20+20+22+42	1.26	1.68	1.68	1.85	3.53	10.00 (3.9 - 11.0)	2.900 (0.960 - 3.535)	12.74	99
15+20+20+22+50	1.18	1.57	1.57	1.73	3.94	10.00 (3.9 - 11.0)	2.890 (0.960 - 3.525)	12.69	99
15+20+20+22+60	1.09	1.46	1.46	1.61	4.38	10.00 (3.9 - 11.0)	2.860 (0.960 - 3.515)	12.56	99
15+20+20+22+71	1.01	1.35	1.35	1.49	4.80	10.00 (3.9 - 11.0)	2.840 (0.960 - 3.505)	12.47	99
15+20+20+25+25	1.40	1.87	1.87	2.33	2.33	9.80 (3.9 - 10.8)	3.010 (0.960 - 3.705)	13.22	99
15+20+20+25+35	1.30	1.74	1.74	2.17	3.04	10.00 (3.9 - 11.0)	2.920 (0.960 - 3.545)	12.82	99
15+20+20+25+42	1.23	1.64	1.64	2.05	3.44	10.00 (3.9 - 11.0)	2.900 (0.960 - 3.535)	12.74	99
15+20+20+25+50	1.15	1.54	1.54	1.92	3.85	10.00 (3.9 - 11.0)	2.890 (0.960 - 3.525)	12.69	99
15+20+20+25+60	1.07	1.43	1.43	1.79	4.29	10.00 (3.9 - 11.0)	2.860 (0.960 - 3.515)	12.56	99
15+20+20+25+71	0.99	1.32	1.32	1.66	4.70	10.00 (3.9 - 11.0)	2.840 (0.960 - 3.505)	12.47	99
15+20+20+35+35	1.20	1.60	1.60	2.80	2.80	10.00 (3.9 - 11.0)	2.920 (0.960 - 3.545)	12.82	99
15+20+20+35+42	1.14	1.52	1.52	2.65	3.18	10.00 (3.9 - 11.0)	2.900 (0.960 - 3.535)	12.74	99
15+20+20+35+50	1.07	1.43	1.43	2.50	3.57	10.00 (3.9 - 11.0)	2.890 (0.960 - 3.525)	12.69	99
15+20+20+35+60	1.00	1.33	1.33	2.33	4.00	10.00 (3.9 - 11.0)	2.860 (0.960 - 3.515)	12.56	99
15+20+20+35+71	0.93	1.24	1.24	2.17	4.41	10.00 (3.9 - 11.0)	2.840 (0.960 - 3.505)	12.47	99

MXZ-5C100VA(VA2) COOLING

Indoor units combination	Cooling capacity (kW)					Total	Outdoor unit power consumption (kW)	Current (A)	Power factor (%)
	Unit A	Unit B	Unit C	Unit D	Unit E				
15+20+20+42+42	1.08	1.44	1.44	3.02	3.02	10.00 (3.9 - 11.0)	2.880 (0.960 - 3.525)	12.65	99
15+20+20+42+50	1.02	1.36	1.36	2.86	3.40	10.00 (3.9 - 11.0)	2.870 (0.960 - 3.515)	12.60	99
15+20+20+42+60	0.96	1.27	1.27	2.68	3.82	10.00 (3.9 - 11.0)	2.840 (0.960 - 3.505)	12.47	99
15+20+20+42+71	0.89	1.19	1.19	2.50	4.23	10.00 (3.9 - 11.0)	2.820 (0.960 - 3.495)	12.38	99
15+20+22+22+22	1.43	1.90	2.09	2.09	2.09	9.60 (3.9 - 10.6)	3.060 (0.900 - 3.825)	13.44	99
15+20+22+22+25	1.40	1.87	2.05	2.05	2.33	9.70 (3.9 - 10.7)	3.015 (0.900 - 3.745)	13.24	99
15+20+22+22+35	1.32	1.75	1.93	1.93	3.07	10.00 (3.9 - 11.0)	2.880 (0.900 - 3.505)	12.65	99
15+20+22+22+42	1.24	1.65	1.82	1.82	3.47	10.00 (3.9 - 11.0)	2.860 (0.900 - 3.495)	12.56	99
15+20+22+22+50	1.16	1.55	1.71	1.71	3.88	10.00 (3.9 - 11.0)	2.850 (0.900 - 3.485)	12.52	99
15+20+22+22+60	1.08	1.44	1.58	1.58	4.32	10.00 (3.9 - 11.0)	2.820 (0.900 - 3.475)	12.38	99
15+20+22+22+71	1.00	1.33	1.47	1.47	4.73	10.00 (3.9 - 11.0)	2.800 (0.900 - 3.465)	12.30	99
15+20+22+25+25	1.39	1.85	2.04	2.31	2.31	9.90 (3.9 - 10.9)	2.925 (0.900 - 3.585)	12.85	99
15+20+22+25+35	1.28	1.71	1.88	2.14	2.99	10.00 (3.9 - 11.0)	2.880 (0.900 - 3.505)	12.65	99
15+20+22+25+42	1.21	1.61	1.77	2.02	3.39	10.00 (3.9 - 11.0)	2.860 (0.900 - 3.495)	12.56	99
15+20+22+25+50	1.14	1.52	1.67	1.89	3.79	10.00 (3.9 - 11.0)	2.850 (0.900 - 3.485)	12.52	99
15+20+22+25+60	1.06	1.41	1.55	1.76	4.23	10.00 (3.9 - 11.0)	2.820 (0.900 - 3.475)	12.38	99
15+20+22+25+71	0.98	1.31	1.44	1.63	4.64	10.00 (3.9 - 11.0)	2.800 (0.900 - 3.465)	12.30	99
15+20+22+35+35	1.18	1.57	1.73	2.76	2.76	10.00 (3.9 - 11.0)	2.880 (0.900 - 3.505)	12.65	99
15+20+22+35+42	1.12	1.49	1.64	2.61	3.13	10.00 (3.9 - 11.0)	2.860 (0.900 - 3.495)	12.56	99
15+20+22+35+50	1.06	1.41	1.55	2.46	3.52	10.00 (3.9 - 11.0)	2.850 (0.900 - 3.485)	12.52	99
15+20+22+35+60	0.99	1.32	1.45	2.30	3.95	10.00 (3.9 - 11.0)	2.820 (0.900 - 3.475)	12.38	99
15+20+22+35+71	0.92	1.23	1.35	2.15	4.36	10.00 (3.9 - 11.0)	2.800 (0.900 - 3.465)	12.30	99
15+20+22+42+42	1.06	1.42	1.56	2.98	2.98	10.00 (3.9 - 11.0)	2.840 (0.900 - 3.485)	12.47	99
15+20+22+42+50	1.01	1.34	1.48	2.82	3.36	10.00 (3.9 - 11.0)	2.830 (0.900 - 3.475)	12.43	99
15+20+22+42+60	0.94	1.26	1.38	2.64	3.77	10.00 (3.9 - 11.0)	2.800 (0.900 - 3.465)	12.30	99
15+20+22+42+71	0.88	1.18	1.29	2.47	4.18	10.00 (3.9 - 11.0)	2.780 (0.900 - 3.455)	12.21	99
15+20+25+25+25	1.36	1.82	2.27	2.27	2.27	10.00 (3.9 - 11.0)	2.880 (0.900 - 3.505)	12.65	99
15+20+25+25+35	1.25	1.67	2.08	2.08	2.92	10.00 (3.9 - 11.0)	2.880 (0.900 - 3.505)	12.65	99
15+20+25+25+42	1.18	1.57	1.97	1.97	3.31	10.00 (3.9 - 11.0)	2.860 (0.900 - 3.495)	12.56	99
15+20+25+25+50	1.11	1.48	1.85	1.85	3.70	10.00 (3.9 - 11.0)	2.850 (0.900 - 3.485)	12.52	99
15+20+25+25+60	1.03	1.38	1.72	1.72	4.14	10.00 (3.9 - 11.0)	2.820 (0.900 - 3.475)	12.38	99
15+20+25+25+71	0.96	1.28	1.60	1.60	4.55	10.00 (3.9 - 11.0)	2.800 (0.900 - 3.465)	12.30	99
15+20+25+35+35	1.15	1.54	1.92	2.69	2.69	10.00 (3.9 - 11.0)	2.880 (0.900 - 3.505)	12.65	99
15+20+25+35+42	1.09	1.46	1.82	2.55	3.07	10.00 (3.9 - 11.0)	2.860 (0.900 - 3.495)	12.56	99
15+20+25+35+50	1.03	1.38	1.72	2.41	3.45	10.00 (3.9 - 11.0)	2.850 (0.900 - 3.485)	12.52	99
15+20+25+35+60	0.97	1.29	1.61	2.26	3.87	10.00 (3.9 - 11.0)	2.820 (0.900 - 3.475)	12.38	99
15+20+25+35+71	0.90	1.20	1.51	2.11	4.28	10.00 (3.9 - 11.0)	2.800 (0.900 - 3.465)	12.30	99
15+20+25+42+42	1.04	1.39	1.74	2.92	2.92	10.00 (3.9 - 11.0)	2.840 (0.900 - 3.485)	12.47	99
15+20+25+42+50	0.99	1.32	1.64	2.76	3.29	10.00 (3.9 - 11.0)	2.830 (0.900 - 3.475)	12.43	99
15+20+25+42+60	0.93	1.23	1.54	2.59	3.70	10.00 (3.9 - 11.0)	2.800 (0.900 - 3.465)	12.30	99
15+20+35+35+35	1.07	1.43	2.50	2.50	2.50	10.00 (3.9 - 11.0)	2.880 (0.900 - 3.505)	12.65	99
15+20+35+35+42	1.02	1.36	2.38	2.38	2.86	10.00 (3.9 - 11.0)	2.860 (0.900 - 3.495)	12.56	99

MXZ-5C100VA(VA2) COOLING

Indoor units combination	Cooling capacity (kW)					Total	Outdoor unit power consumption (kW)	Current (A)	Power factor (%)
	Unit A	Unit B	Unit C	Unit D	Unit E				
15+20+35+35+50	0.97	1.29	2.26	2.26	3.23	10.00 (3.9 - 11.0)	2.850 (0.900 - 3.485)	12.52	99
15+20+35+35+60	0.91	1.21	2.12	2.12	3.64	10.00 (3.9 - 11.0)	2.820 (0.900 - 3.475)	12.38	99
15+20+35+42+42	0.97	1.30	2.27	2.73	2.73	10.00 (3.9 - 11.0)	2.840 (0.900 - 3.485)	12.47	99
15+20+35+42+50	0.93	1.23	2.16	2.59	3.09	10.00 (3.9 - 11.0)	2.830 (0.900 - 3.475)	12.43	99
15+20+35+42+60	0.87	1.16	2.03	2.44	3.49	10.00 (3.9 - 11.0)	2.800 (0.900 - 3.465)	12.30	99
15+20+42+42+42	0.93	1.24	2.61	2.61	2.61	10.00 (3.9 - 11.0)	2.820 (0.900 - 3.475)	12.38	99
15+20+42+42+50	0.89	1.18	2.49	2.49	2.96	10.00 (3.9 - 11.0)	2.810 (0.900 - 3.465)	12.34	99
15+22+22+22+22	1.41	2.07	2.07	2.07	2.07	9.70 (3.9 - 10.7)	2.975 (0.840 - 3.705)	13.07	99
15+22+22+22+25	1.39	2.03	2.03	2.03	2.31	9.80 (3.9 - 10.8)	2.930 (0.840 - 3.625)	12.87	99
15+22+22+22+35	1.29	1.90	1.90	1.90	3.02	10.00 (3.9 - 11.0)	2.840 (0.840 - 3.465)	12.47	99
15+22+22+22+42	1.22	1.79	1.79	1.79	3.41	10.00 (3.9 - 11.0)	2.820 (0.840 - 3.455)	12.38	99
15+22+22+22+50	1.15	1.68	1.68	1.68	3.82	10.00 (3.9 - 11.0)	2.810 (0.840 - 3.445)	12.34	99
15+22+22+22+60	1.06	1.56	1.56	1.56	4.26	10.00 (3.9 - 11.0)	2.780 (0.840 - 3.435)	12.21	99
15+22+22+22+71	0.99	1.45	1.45	1.45	4.67	10.00 (3.9 - 11.0)	2.760 (0.840 - 3.425)	12.12	99
15+22+22+25+25	1.38	2.02	2.02	2.29	2.29	10.00 (3.9 - 11.0)	2.840 (0.840 - 3.465)	12.47	99
15+22+22+25+35	1.26	1.85	1.85	2.10	2.94	10.00 (3.9 - 11.0)	2.840 (0.840 - 3.465)	12.47	99
15+22+22+25+42	1.19	1.75	1.75	1.98	3.33	10.00 (3.9 - 11.0)	2.820 (0.840 - 3.455)	12.38	99
15+22+22+25+50	1.12	1.64	1.64	1.87	3.73	10.00 (3.9 - 11.0)	2.810 (0.840 - 3.445)	12.34	99
15+22+22+25+60	1.04	1.53	1.53	1.74	4.17	10.00 (3.9 - 11.0)	2.780 (0.840 - 3.435)	12.21	99
15+22+22+25+71	0.97	1.42	1.42	1.61	4.58	10.00 (3.9 - 11.0)	2.760 (0.840 - 3.425)	12.12	99
15+22+22+35+35	1.16	1.71	1.71	2.71	2.71	10.00 (3.9 - 11.0)	2.840 (0.840 - 3.465)	12.47	99
15+22+22+35+42	1.10	1.62	1.62	2.57	3.09	10.00 (3.9 - 11.0)	2.820 (0.840 - 3.455)	12.38	99
15+22+22+35+50	1.04	1.53	1.53	2.43	3.47	10.00 (3.9 - 11.0)	2.810 (0.840 - 3.445)	12.34	99
15+22+22+35+60	0.97	1.43	1.43	2.27	3.90	10.00 (3.9 - 11.0)	2.780 (0.840 - 3.435)	12.21	99
15+22+22+35+71	0.91	1.33	1.33	2.12	4.30	10.00 (3.9 - 11.0)	2.760 (0.840 - 3.425)	12.12	99
15+22+22+42+42	1.05	1.54	1.54	2.94	2.94	10.00 (3.9 - 11.0)	2.800 (0.840 - 3.445)	12.30	99
15+22+22+42+50	0.99	1.46	1.46	2.78	3.31	10.00 (3.9 - 11.0)	2.790 (0.840 - 3.435)	12.25	99
15+22+22+42+60	0.93	1.37	1.37	2.61	3.73	10.00 (3.9 - 11.0)	2.760 (0.840 - 3.425)	12.12	99
15+22+22+42+71	0.87	1.28	1.28	2.44	4.13	10.00 (3.9 - 11.0)	2.740 (0.840 - 3.415)	12.03	99
15+22+25+25+25	1.34	1.96	2.23	2.23	2.23	10.00 (3.9 - 11.0)	2.840 (0.840 - 3.465)	12.47	99
15+22+25+25+35	1.23	1.80	2.05	2.05	2.87	10.00 (3.9 - 11.0)	2.840 (0.840 - 3.465)	12.47	99
15+22+25+25+42	1.16	1.71	1.94	1.94	3.26	10.00 (3.9 - 11.0)	2.820 (0.840 - 3.455)	12.38	99
15+22+25+25+50	1.09	1.61	1.82	1.82	3.65	10.00 (3.9 - 11.0)	2.810 (0.840 - 3.445)	12.34	99
15+22+25+25+60	1.02	1.50	1.70	1.70	4.08	10.00 (3.9 - 11.0)	2.780 (0.840 - 3.435)	12.21	99
15+22+25+25+71	0.95	1.39	1.58	1.58	4.49	10.00 (3.9 - 11.0)	2.760 (0.840 - 3.425)	12.12	99
15+22+25+35+35	1.14	1.67	1.89	2.65	2.65	10.00 (3.9 - 11.0)	2.840 (0.840 - 3.465)	12.47	99
15+22+25+35+42	1.08	1.58	1.80	2.52	3.02	10.00 (3.9 - 11.0)	2.820 (0.840 - 3.455)	12.38	99
15+22+25+35+50	1.02	1.50	1.70	2.38	3.40	10.00 (3.9 - 11.0)	2.810 (0.840 - 3.445)	12.34	99
15+22+25+35+60	0.96	1.40	1.59	2.23	3.82	10.00 (3.9 - 11.0)	2.780 (0.840 - 3.435)	12.21	99
15+22+25+35+71	0.89	1.31	1.49	2.08	4.23	10.00 (3.9 - 11.0)	2.760 (0.840 - 3.425)	12.12	99
15+22+25+42+42	1.03	1.51	1.71	2.88	2.88	10.00 (3.9 - 11.0)	2.800 (0.840 - 3.445)	12.30	99
15+22+25+42+50	0.97	1.43	1.62	2.73	3.25	10.00 (3.9 - 11.0)	2.790 (0.840 - 3.435)	12.25	99

MXZ-5C100VA(VA2) COOLING

Indoor units combination	Cooling capacity (kW)					Total	Outdoor unit power consumption (kW)	Current (A)	Power factor (%)
	Unit A	Unit B	Unit C	Unit D	Unit E				
15+22+25+42+60	0.91	1.34	1.52	2.56	3.66	10.00 (3.9 - 11.0)	2.760 (0.840 - 3.425)	12.12	99
15+22+35+35+35	1.06	1.55	2.46	2.46	2.46	10.00 (3.9 - 11.0)	2.840 (0.840 - 3.465)	12.47	99
15+22+35+35+42	1.01	1.48	2.35	2.35	2.82	10.00 (3.9 - 11.0)	2.820 (0.840 - 3.455)	12.38	99
15+22+35+35+50	0.96	1.40	2.23	2.23	3.18	10.00 (3.9 - 11.0)	2.810 (0.840 - 3.445)	12.34	99
15+22+35+35+60	0.90	1.32	2.10	2.10	3.59	10.00 (3.9 - 11.0)	2.780 (0.840 - 3.435)	12.21	99
15+22+35+42+42	0.96	1.41	2.24	2.69	2.69	10.00 (3.9 - 11.0)	2.800 (0.840 - 3.445)	12.30	99
15+22+35+42+50	0.91	1.34	2.13	2.56	3.05	10.00 (3.9 - 11.0)	2.790 (0.840 - 3.435)	12.25	99
15+22+42+42+42	0.92	1.35	2.58	2.58	2.58	10.00 (3.9 - 11.0)	2.780 (0.840 - 3.435)	12.21	99
15+22+42+42+50	0.88	1.29	2.46	2.46	2.92	10.00 (3.9 - 11.0)	2.770 (0.840 - 3.425)	12.17	99
15+25+25+25+25	1.30	2.17	2.17	2.17	2.17	10.00 (3.9 - 11.0)	2.840 (0.840 - 3.465)	12.47	99
15+25+25+25+35	1.20	2.00	2.00	2.00	2.80	10.00 (3.9 - 11.0)	2.840 (0.840 - 3.465)	12.47	99
15+25+25+25+42	1.14	1.89	1.89	1.89	3.18	10.00 (3.9 - 11.0)	2.820 (0.840 - 3.455)	12.38	99
15+25+25+25+50	1.07	1.79	1.79	1.79	3.57	10.00 (3.9 - 11.0)	2.810 (0.840 - 3.445)	12.34	99
15+25+25+25+60	1.00	1.67	1.67	1.67	4.00	10.00 (3.9 - 11.0)	2.780 (0.840 - 3.435)	12.21	99
15+25+25+25+71	0.93	1.55	1.55	1.55	4.41	10.00 (3.9 - 11.0)	2.760 (0.840 - 3.425)	12.12	99
15+25+25+35+35	1.11	1.85	1.85	2.59	2.59	10.00 (3.9 - 11.0)	2.840 (0.840 - 3.465)	12.47	99
15+25+25+35+42	1.06	1.76	1.76	2.46	2.96	10.00 (3.9 - 11.0)	2.820 (0.840 - 3.455)	12.38	99
15+25+25+35+50	1.00	1.67	1.67	2.33	3.33	10.00 (3.9 - 11.0)	2.810 (0.840 - 3.445)	12.34	99
15+25+25+35+60	0.94	1.56	1.56	2.19	3.75	10.00 (3.9 - 11.0)	2.780 (0.840 - 3.435)	12.21	99
15+25+25+35+71	0.88	1.46	1.46	2.05	4.15	10.00 (3.9 - 11.0)	2.760 (0.840 - 3.425)	12.12	99
15+25+25+42+42	1.01	1.68	1.68	2.82	2.82	10.00 (3.9 - 11.0)	2.800 (0.840 - 3.445)	12.30	99
15+25+25+42+50	0.96	1.59	1.59	2.68	3.18	10.00 (3.9 - 11.0)	2.790 (0.840 - 3.435)	12.25	99
15+25+25+42+60	0.90	1.50	1.50	2.51	3.59	10.00 (3.9 - 11.0)	2.760 (0.840 - 3.425)	12.12	99
15+25+35+35+35	1.03	1.72	2.41	2.41	2.41	10.00 (3.9 - 11.0)	2.840 (0.840 - 3.465)	12.47	99
15+25+35+35+42	0.99	1.64	2.30	2.30	2.76	10.00 (3.9 - 11.0)	2.820 (0.840 - 3.455)	12.38	99
15+25+35+35+50	0.94	1.56	2.19	2.19	3.13	10.00 (3.9 - 11.0)	2.810 (0.840 - 3.445)	12.34	99
15+25+35+35+60	0.88	1.47	2.06	2.06	3.53	10.00 (3.9 - 11.0)	2.780 (0.840 - 3.435)	12.21	99
15+25+35+42+42	0.94	1.57	2.20	2.64	2.64	10.00 (3.9 - 11.0)	2.800 (0.840 - 3.445)	12.30	99
15+25+35+42+50	0.90	1.50	2.10	2.51	2.99	10.00 (3.9 - 11.0)	2.790 (0.840 - 3.435)	12.25	99
15+25+42+42+42	0.90	1.51	2.53	2.53	2.53	10.00 (3.9 - 11.0)	2.780 (0.840 - 3.435)	12.21	99
15+35+35+35+35	0.97	2.26	2.26	2.26	2.26	10.00 (3.9 - 11.0)	2.840 (0.840 - 3.465)	12.47	99
15+35+35+35+42	0.93	2.16	2.16	2.16	2.59	10.00 (3.9 - 11.0)	2.820 (0.840 - 3.455)	12.38	99
15+35+35+35+50	0.88	2.06	2.06	2.06	2.94	10.00 (3.9 - 11.0)	2.810 (0.840 - 3.445)	12.34	99
15+35+35+42+42	0.89	2.07	2.07	2.49	2.49	10.00 (3.9 - 11.0)	2.800 (0.840 - 3.445)	12.30	99
20+20+20+20+20	1.90	1.90	1.90	1.90	1.90	9.50 (3.9 - 10.5)	3.025 (1.090 - 3.825)	13.29	99
20+20+20+20+22	1.88	1.88	1.88	1.88	2.07	9.60 (3.9 - 10.6)	3.140 (1.020 - 3.905)	13.79	99
20+20+20+20+25	1.87	1.87	1.87	1.87	2.33	9.80 (3.9 - 10.8)	3.050 (1.020 - 3.745)	13.39	99
20+20+20+20+35	1.74	1.74	1.74	1.74	3.04	10.00 (3.9 - 11.0)	2.960 (1.020 - 3.585)	13.00	99
20+20+20+20+42	1.64	1.64	1.64	1.64	3.44	10.00 (3.9 - 11.0)	2.940 (1.020 - 3.575)	12.91	99
20+20+20+20+50	1.54	1.54	1.54	1.54	3.85	10.00 (3.9 - 11.0)	2.930 (1.020 - 3.565)	12.87	99
20+20+20+20+60	1.43	1.43	1.43	1.43	4.29	10.00 (3.9 - 11.0)	2.900 (1.020 - 3.555)	12.74	99
20+20+20+20+71	1.32	1.32	1.32	1.32	4.70	10.00 (3.9 - 11.0)	2.880 (1.020 - 3.545)	12.65	99

MXZ-5C100VA(VA2) COOLING

Indoor units combination	Cooling capacity (kW)					Total	Outdoor unit power consumption (kW)	Current (A)	Power factor (%)
	Unit A	Unit B	Unit C	Unit D	Unit E				
20+20+20+22+22	1.87	1.87	1.87	2.05	2.05	9.70 (3.9 - 10.7)	3.055 (0.960 - 3.785)	13.42	99
20+20+20+22+25	1.85	1.85	1.85	2.04	2.31	9.90 (3.9 - 10.9)	2.965 (0.960 - 3.625)	13.02	99
20+20+20+22+35	1.71	1.71	1.71	1.88	2.99	10.00 (3.9 - 11.0)	2.920 (0.960 - 3.545)	12.82	99
20+20+20+22+42	1.61	1.61	1.61	1.77	3.39	10.00 (3.9 - 11.0)	2.900 (0.960 - 3.535)	12.74	99
20+20+20+22+50	1.52	1.52	1.52	1.67	3.79	10.00 (3.9 - 11.0)	2.890 (0.960 - 3.525)	12.69	99
20+20+20+22+60	1.41	1.41	1.41	1.55	4.23	10.00 (3.9 - 11.0)	2.860 (0.960 - 3.515)	12.56	99
20+20+20+22+71	1.31	1.31	1.31	1.44	4.64	10.00 (3.9 - 11.0)	2.840 (0.960 - 3.505)	12.47	99
20+20+20+25+25	1.82	1.82	1.82	2.27	2.27	10.00 (3.9 - 11.0)	2.920 (0.960 - 3.545)	12.82	99
20+20+20+25+35	1.67	1.67	1.67	2.08	2.92	10.00 (3.9 - 11.0)	2.920 (0.960 - 3.545)	12.82	99
20+20+20+25+42	1.57	1.57	1.57	1.97	3.31	10.00 (3.9 - 11.0)	2.900 (0.960 - 3.535)	12.74	99
20+20+20+25+50	1.48	1.48	1.48	1.85	3.70	10.00 (3.9 - 11.0)	2.890 (0.960 - 3.525)	12.69	99
20+20+20+25+60	1.38	1.38	1.38	1.72	4.14	10.00 (3.9 - 11.0)	2.860 (0.960 - 3.515)	12.56	99
20+20+20+25+71	1.28	1.28	1.28	1.60	4.55	10.00 (3.9 - 11.0)	2.840 (0.960 - 3.505)	12.47	99
20+20+20+35+35	1.54	1.54	1.54	2.69	2.69	10.00 (3.9 - 11.0)	2.920 (0.960 - 3.545)	12.82	99
20+20+20+35+42	1.46	1.46	1.46	2.55	3.07	10.00 (3.9 - 11.0)	2.900 (0.960 - 3.535)	12.74	99
20+20+20+35+50	1.38	1.38	1.38	2.41	3.45	10.00 (3.9 - 11.0)	2.890 (0.960 - 3.525)	12.69	99
20+20+20+35+60	1.29	1.29	1.29	2.26	3.87	10.00 (3.9 - 11.0)	2.860 (0.960 - 3.515)	12.56	99
20+20+20+35+71	1.20	1.20	1.20	2.11	4.28	10.00 (3.9 - 11.0)	2.840 (0.960 - 3.505)	12.47	99
20+20+20+42+42	1.39	1.39	1.39	2.92	2.92	10.00 (3.9 - 11.0)	2.880 (0.960 - 3.525)	12.65	99
20+20+20+42+50	1.32	1.32	1.32	2.76	3.29	10.00 (3.9 - 11.0)	2.870 (0.960 - 3.515)	12.60	99
20+20+20+42+60	1.23	1.23	1.23	2.59	3.70	10.00 (3.9 - 11.0)	2.840 (0.960 - 3.505)	12.47	99
20+20+22+22+22	1.85	1.85	2.03	2.03	2.03	9.80 (3.9 - 10.8)	2.970 (0.900 - 3.665)	13.04	99
20+20+22+22+25	1.83	1.83	2.02	2.02	2.29	10.00 (3.9 - 11.0)	2.880 (0.900 - 3.505)	12.65	99
20+20+22+22+35	1.68	1.68	1.85	1.85	2.94	10.00 (3.9 - 11.0)	2.880 (0.900 - 3.505)	12.65	99
20+20+22+22+42	1.59	1.59	1.75	1.75	3.33	10.00 (3.9 - 11.0)	2.860 (0.900 - 3.495)	12.56	99
20+20+22+22+50	1.49	1.49	1.64	1.64	3.73	10.00 (3.9 - 11.0)	2.850 (0.900 - 3.485)	12.52	99
20+20+22+22+60	1.39	1.39	1.53	1.53	4.17	10.00 (3.9 - 11.0)	2.820 (0.900 - 3.475)	12.38	99
20+20+22+22+71	1.29	1.29	1.42	1.42	4.58	10.00 (3.9 - 11.0)	2.800 (0.900 - 3.465)	12.30	99
20+20+22+25+25	1.79	1.79	1.96	2.23	2.23	10.00 (3.9 - 11.0)	2.880 (0.900 - 3.505)	12.65	99
20+20+22+25+35	1.64	1.64	1.80	2.05	2.87	10.00 (3.9 - 11.0)	2.880 (0.900 - 3.505)	12.65	99
20+20+22+25+42	1.55	1.55	1.71	1.94	3.26	10.00 (3.9 - 11.0)	2.860 (0.900 - 3.495)	12.56	99
20+20+22+25+50	1.46	1.46	1.61	1.82	3.65	10.00 (3.9 - 11.0)	2.850 (0.900 - 3.485)	12.52	99
20+20+22+25+60	1.36	1.36	1.50	1.70	4.08	10.00 (3.9 - 11.0)	2.820 (0.900 - 3.475)	12.38	99
20+20+22+25+71	1.27	1.27	1.39	1.58	4.49	10.00 (3.9 - 11.0)	2.800 (0.900 - 3.465)	12.30	99
20+20+22+35+35	1.52	1.52	1.67	2.65	2.65	10.00 (3.9 - 11.0)	2.880 (0.900 - 3.505)	12.65	99
20+20+22+35+42	1.44	1.44	1.58	2.52	3.02	10.00 (3.9 - 11.0)	2.860 (0.900 - 3.495)	12.56	99
20+20+22+35+50	1.36	1.36	1.50	2.38	3.40	10.00 (3.9 - 11.0)	2.850 (0.900 - 3.485)	12.52	99
20+20+22+35+60	1.27	1.27	1.40	2.23	3.82	10.00 (3.9 - 11.0)	2.820 (0.900 - 3.475)	12.38	99
20+20+22+35+71	1.19	1.19	1.31	2.08	4.23	10.00 (3.9 - 11.0)	2.800 (0.900 - 3.465)	12.30	99
20+20+22+42+42	1.37	1.37	1.51	2.88	2.88	10.00 (3.9 - 11.0)	2.840 (0.900 - 3.485)	12.47	99
20+20+22+42+50	1.30	1.30	1.43	2.73	3.25	10.00 (3.9 - 11.0)	2.830 (0.900 - 3.475)	12.43	99
20+20+22+42+60	1.22	1.22	1.34	2.56	3.66	10.00 (3.9 - 11.0)	2.800 (0.900 - 3.465)	12.30	99

MXZ-5C100VA(VA2) COOLING

Indoor units combination	Cooling capacity (kW)					Total	Outdoor unit power consumption (kW)	Current (A)	Power factor (%)
	Unit A	Unit B	Unit C	Unit D	Unit E				
20+20+25+25+25	1.74	1.74	2.17	2.17	2.17	10.00 (3.9 - 11.0)	2.880 (0.900 - 3.505)	12.65	99
20+20+25+25+35	1.60	1.60	2.00	2.00	2.80	10.00 (3.9 - 11.0)	2.880 (0.900 - 3.505)	12.65	99
20+20+25+25+42	1.52	1.52	1.89	1.89	3.18	10.00 (3.9 - 11.0)	2.860 (0.900 - 3.495)	12.56	99
20+20+25+25+50	1.43	1.43	1.79	1.79	3.57	10.00 (3.9 - 11.0)	2.850 (0.900 - 3.485)	12.52	99
20+20+25+25+60	1.33	1.33	1.67	1.67	4.00	10.00 (3.9 - 11.0)	2.820 (0.900 - 3.475)	12.38	99
20+20+25+25+71	1.24	1.24	1.55	1.55	4.41	10.00 (3.9 - 11.0)	2.800 (0.900 - 3.465)	12.30	99
20+20+25+35+35	1.48	1.48	1.85	2.59	2.59	10.00 (3.9 - 11.0)	2.880 (0.900 - 3.505)	12.65	99
20+20+25+35+42	1.41	1.41	1.76	2.46	2.96	10.00 (3.9 - 11.0)	2.860 (0.900 - 3.495)	12.56	99
20+20+25+35+50	1.33	1.33	1.67	2.33	3.33	10.00 (3.9 - 11.0)	2.850 (0.900 - 3.485)	12.52	99
20+20+25+35+60	1.25	1.25	1.56	2.19	3.75	10.00 (3.9 - 11.0)	2.820 (0.900 - 3.475)	12.38	99
20+20+25+35+71	1.17	1.17	1.46	2.05	4.15	10.00 (3.9 - 11.0)	2.800 (0.900 - 3.465)	12.30	99
20+20+25+42+42	1.34	1.34	1.68	2.82	2.82	10.00 (3.9 - 11.0)	2.840 (0.900 - 3.485)	12.47	99
20+20+25+42+50	1.27	1.27	1.59	2.68	3.18	10.00 (3.9 - 11.0)	2.830 (0.900 - 3.475)	12.43	99
20+20+25+42+60	1.20	1.20	1.50	2.51	3.59	10.00 (3.9 - 11.0)	2.800 (0.900 - 3.465)	12.30	99
20+20+35+35+35	1.38	1.38	2.41	2.41	2.41	10.00 (3.9 - 11.0)	2.880 (0.900 - 3.505)	12.65	99
20+20+35+35+42	1.32	1.32	2.30	2.30	2.76	10.00 (3.9 - 11.0)	2.860 (0.900 - 3.495)	12.56	99
20+20+35+35+50	1.25	1.25	2.19	2.19	3.13	10.00 (3.9 - 11.0)	2.850 (0.900 - 3.485)	12.52	99
20+20+35+35+60	1.18	1.18	2.06	2.06	3.53	10.00 (3.9 - 11.0)	2.820 (0.900 - 3.475)	12.38	99
20+20+35+42+42	1.26	1.26	2.20	2.64	2.64	10.00 (3.9 - 11.0)	2.840 (0.900 - 3.485)	12.47	99
20+20+35+42+50	1.20	1.20	2.10	2.51	2.99	10.00 (3.9 - 11.0)	2.830 (0.900 - 3.475)	12.43	99
20+20+42+42+42	1.20	1.20	2.53	2.53	2.53	10.00 (3.9 - 11.0)	2.820 (0.900 - 3.475)	12.38	99
20+22+22+22+22	1.83	2.02	2.02	2.02	2.02	9.90 (3.9 - 10.9)	2.885 (0.840 - 3.545)	12.67	99
20+22+22+22+25	1.80	1.98	1.98	1.98	2.25	10.00 (3.9 - 11.0)	2.840 (0.840 - 3.465)	12.47	99
20+22+22+22+35	1.65	1.82	1.82	1.82	2.89	10.00 (3.9 - 11.0)	2.840 (0.840 - 3.465)	12.47	99
20+22+22+22+42	1.56	1.72	1.72	1.72	3.28	10.00 (3.9 - 11.0)	2.820 (0.840 - 3.455)	12.38	99
20+22+22+22+50	1.47	1.62	1.62	1.62	3.68	10.00 (3.9 - 11.0)	2.810 (0.840 - 3.445)	12.34	99
20+22+22+22+60	1.37	1.51	1.51	1.51	4.11	10.00 (3.9 - 11.0)	2.780 (0.840 - 3.435)	12.21	99
20+22+22+22+71	1.27	1.40	1.40	1.40	4.52	10.00 (3.9 - 11.0)	2.760 (0.840 - 3.425)	12.12	99
20+22+22+25+25	1.75	1.93	1.93	2.19	2.19	10.00 (3.9 - 11.0)	2.840 (0.840 - 3.465)	12.47	99
20+22+22+25+35	1.61	1.77	1.77	2.02	2.82	10.00 (3.9 - 11.0)	2.840 (0.840 - 3.465)	12.47	99
20+22+22+25+42	1.53	1.68	1.68	1.91	3.21	10.00 (3.9 - 11.0)	2.820 (0.840 - 3.455)	12.38	99
20+22+22+25+50	1.44	1.58	1.58	1.80	3.60	10.00 (3.9 - 11.0)	2.810 (0.840 - 3.445)	12.34	99
20+22+22+25+60	1.34	1.48	1.48	1.68	4.03	10.00 (3.9 - 11.0)	2.780 (0.840 - 3.435)	12.21	99
20+22+22+25+71	1.25	1.38	1.38	1.56	4.44	10.00 (3.9 - 11.0)	2.760 (0.840 - 3.425)	12.12	99
20+22+22+35+35	1.49	1.64	1.64	2.61	2.61	10.00 (3.9 - 11.0)	2.840 (0.840 - 3.465)	12.47	99
20+22+22+35+42	1.42	1.56	1.56	2.48	2.98	10.00 (3.9 - 11.0)	2.820 (0.840 - 3.455)	12.38	99
20+22+22+35+50	1.34	1.48	1.48	2.35	3.36	10.00 (3.9 - 11.0)	2.810 (0.840 - 3.445)	12.34	99
20+22+22+35+60	1.26	1.38	1.38	2.20	3.77	10.00 (3.9 - 11.0)	2.780 (0.840 - 3.435)	12.21	99
20+22+22+35+71	1.18	1.29	1.29	2.06	4.18	10.00 (3.9 - 11.0)	2.760 (0.840 - 3.425)	12.12	99
20+22+22+42+42	1.35	1.49	1.49	2.84	2.84	10.00 (3.9 - 11.0)	2.800 (0.840 - 3.445)	12.30	99
20+22+22+42+50	1.28	1.41	1.41	2.69	3.21	10.00 (3.9 - 11.0)	2.790 (0.840 - 3.435)	12.25	99
20+22+22+42+60	1.20	1.33	1.33	2.53	3.61	10.00 (3.9 - 11.0)	2.760 (0.840 - 3.425)	12.12	99

MXZ-5C100VA(VA2) COOLING

Indoor units combination	Cooling capacity (kW)					Total	Outdoor unit power consumption (kW)	Current (A)	Power factor (%)
	Unit A	Unit B	Unit C	Unit D	Unit E				
20+22+25+25+25	1.71	1.88	2.14	2.14	2.14	10.00 (3.9 - 11.0)	2.840 (0.840 - 3.465)	12.47	99
20+22+25+25+35	1.57	1.73	1.97	1.97	2.76	10.00 (3.9 - 11.0)	2.840 (0.840 - 3.465)	12.47	99
20+22+25+25+42	1.49	1.64	1.87	1.87	3.13	10.00 (3.9 - 11.0)	2.820 (0.840 - 3.455)	12.38	99
20+22+25+25+50	1.41	1.55	1.76	1.76	3.52	10.00 (3.9 - 11.0)	2.810 (0.840 - 3.445)	12.34	99
20+22+25+25+60	1.32	1.45	1.64	1.64	3.95	10.00 (3.9 - 11.0)	2.780 (0.840 - 3.435)	12.21	99
20+22+25+25+71	1.23	1.35	1.53	1.53	4.36	10.00 (3.9 - 11.0)	2.760 (0.840 - 3.425)	12.12	99
20+22+25+35+35	1.46	1.61	1.82	2.55	2.55	10.00 (3.9 - 11.0)	2.840 (0.840 - 3.465)	12.47	99
20+22+25+35+42	1.39	1.53	1.74	2.43	2.92	10.00 (3.9 - 11.0)	2.820 (0.840 - 3.455)	12.38	99
20+22+25+35+50	1.32	1.45	1.64	2.30	3.29	10.00 (3.9 - 11.0)	2.810 (0.840 - 3.445)	12.34	99
20+22+25+35+60	1.23	1.36	1.54	2.16	3.70	10.00 (3.9 - 11.0)	2.780 (0.840 - 3.435)	12.21	99
20+22+25+42+42	1.32	1.46	1.66	2.78	2.78	10.00 (3.9 - 11.0)	2.800 (0.840 - 3.445)	12.30	99
20+22+25+42+50	1.26	1.38	1.57	2.64	3.14	10.00 (3.9 - 11.0)	2.790 (0.840 - 3.435)	12.25	99
20+22+25+42+60	1.18	1.30	1.48	2.49	3.55	10.00 (3.9 - 11.0)	2.760 (0.840 - 3.425)	12.12	99
20+22+35+35+35	1.36	1.50	2.38	2.38	2.38	10.00 (3.9 - 11.0)	2.840 (0.840 - 3.465)	12.47	99
20+22+35+35+42	1.30	1.43	2.27	2.27	2.73	10.00 (3.9 - 11.0)	2.820 (0.840 - 3.455)	12.38	99
20+22+35+35+50	1.23	1.36	2.16	2.16	3.09	10.00 (3.9 - 11.0)	2.810 (0.840 - 3.445)	12.34	99
20+22+35+35+60	1.16	1.28	2.03	2.03	3.49	10.00 (3.9 - 11.0)	2.780 (0.840 - 3.435)	12.21	99
20+22+35+42+42	1.24	1.37	2.17	2.61	2.61	10.00 (3.9 - 11.0)	2.800 (0.840 - 3.445)	12.30	99
20+22+35+42+50	1.18	1.30	2.07	2.49	2.96	10.00 (3.9 - 11.0)	2.790 (0.840 - 3.435)	12.25	99
20+22+42+42+42	1.19	1.31	2.50	2.50	2.50	10.00 (3.9 - 11.0)	2.780 (0.840 - 3.435)	12.21	99
20+25+25+25+25	1.67	2.08	2.08	2.08	2.08	10.00 (3.9 - 11.0)	2.840 (0.840 - 3.465)	12.47	99
20+25+25+25+35	1.54	1.92	1.92	1.92	2.69	10.00 (3.9 - 11.0)	2.840 (0.840 - 3.465)	12.47	99
20+25+25+25+42	1.46	1.82	1.82	1.82	3.07	10.00 (3.9 - 11.0)	2.820 (0.840 - 3.455)	12.38	99
20+25+25+25+50	1.38	1.72	1.72	1.72	3.45	10.00 (3.9 - 11.0)	2.810 (0.840 - 3.445)	12.34	99
20+25+25+25+60	1.29	1.61	1.61	1.61	3.87	10.00 (3.9 - 11.0)	2.780 (0.840 - 3.435)	12.21	99
20+25+25+25+71	1.20	1.51	1.51	1.51	4.28	10.00 (3.9 - 11.0)	2.760 (0.840 - 3.425)	12.12	99
20+25+25+35+35	1.43	1.79	1.79	2.50	2.50	10.00 (3.9 - 11.0)	2.840 (0.840 - 3.465)	12.47	99
20+25+25+35+42	1.36	1.70	1.70	2.38	2.86	10.00 (3.9 - 11.0)	2.820 (0.840 - 3.455)	12.38	99
20+25+25+35+50	1.29	1.61	1.61	2.26	3.23	10.00 (3.9 - 11.0)	2.810 (0.840 - 3.445)	12.34	99
20+25+25+35+60	1.21	1.52	1.52	2.12	3.64	10.00 (3.9 - 11.0)	2.780 (0.840 - 3.435)	12.21	99
20+25+25+42+42	1.30	1.62	1.62	2.73	2.73	10.00 (3.9 - 11.0)	2.800 (0.840 - 3.445)	12.30	99
20+25+25+42+50	1.23	1.54	1.54	2.59	3.09	10.00 (3.9 - 11.0)	2.790 (0.840 - 3.435)	12.25	99
20+25+25+42+60	1.16	1.45	1.45	2.44	3.49	10.00 (3.9 - 11.0)	2.760 (0.840 - 3.425)	12.12	99
20+25+35+35+35	1.33	1.67	2.33	2.33	2.33	10.00 (3.9 - 11.0)	2.840 (0.840 - 3.465)	12.47	99
20+25+35+35+42	1.27	1.59	2.23	2.23	2.68	10.00 (3.9 - 11.0)	2.820 (0.840 - 3.455)	12.38	99
20+25+35+35+50	1.21	1.52	2.12	2.12	3.03	10.00 (3.9 - 11.0)	2.810 (0.840 - 3.445)	12.34	99
20+25+35+42+42	1.22	1.52	2.13	2.56	2.56	10.00 (3.9 - 11.0)	2.800 (0.840 - 3.445)	12.30	99
20+25+35+42+50	1.16	1.45	2.03	2.44	2.91	10.00 (3.9 - 11.0)	2.790 (0.840 - 3.435)	12.25	99
20+25+42+42+42	1.17	1.46	2.46	2.46	2.46	10.00 (3.9 - 11.0)	2.780 (0.840 - 3.435)	12.21	99
20+35+35+35+35	1.25	2.19	2.19	2.19	2.19	10.00 (3.9 - 11.0)	2.840 (0.840 - 3.465)	12.47	99
20+35+35+35+42	1.20	2.10	2.10	2.10	2.51	10.00 (3.9 - 11.0)	2.820 (0.840 - 3.455)	12.38	99
22+22+22+22+22	2.00	2.00	2.00	2.00	2.00	10.00 (3.9 - 11.0)	2.800 (0.780 - 3.425)	12.30	99

MXZ-5C100VA(VA2) COOLING

Indoor units combination	Cooling capacity (kW)					Total	Outdoor unit power consumption (kW)	Current (A)	Power factor (%)
	Unit A	Unit B	Unit C	Unit D	Unit E				
22+22+22+22+25	1.95	1.95	1.95	1.95	2.21	10.00 (3.9 - 11.0)	2.800 (0.780 - 3.425)	12.30	99
22+22+22+22+35	1.79	1.79	1.79	1.79	2.85	10.00 (3.9 - 11.0)	2.800 (0.780 - 3.425)	12.30	99
22+22+22+22+42	1.69	1.69	1.69	1.69	3.23	10.00 (3.9 - 11.0)	2.780 (0.780 - 3.415)	12.21	99
22+22+22+22+50	1.59	1.59	1.59	1.59	3.62	10.00 (3.9 - 11.0)	2.770 (0.780 - 3.405)	12.17	99
22+22+22+22+60	1.49	1.49	1.49	1.49	4.05	10.00 (3.9 - 11.0)	2.740 (0.780 - 3.395)	12.03	99
22+22+22+22+71	1.38	1.38	1.38	1.38	4.47	10.00 (3.9 - 11.0)	2.720 (0.780 - 3.385)	11.95	99
22+22+22+25+25	1.90	1.90	1.90	2.16	2.16	10.00 (3.9 - 11.0)	2.800 (0.780 - 3.425)	12.30	99
22+22+22+25+35	1.75	1.75	1.75	1.98	2.78	10.00 (3.9 - 11.0)	2.800 (0.780 - 3.425)	12.30	99
22+22+22+25+42	1.65	1.65	1.65	1.88	3.16	10.00 (3.9 - 11.0)	2.780 (0.780 - 3.415)	12.21	99
22+22+22+25+50	1.56	1.56	1.56	1.77	3.55	10.00 (3.9 - 11.0)	2.770 (0.780 - 3.405)	12.17	99
22+22+22+25+60	1.46	1.46	1.46	1.66	3.97	10.00 (3.9 - 11.0)	2.740 (0.780 - 3.395)	12.03	99
22+22+22+25+71	1.36	1.36	1.36	1.54	4.38	10.00 (3.9 - 11.0)	2.720 (0.780 - 3.385)	11.95	99
22+22+22+35+35	1.62	1.62	1.62	2.57	2.57	10.00 (3.9 - 11.0)	2.800 (0.780 - 3.425)	12.30	99
22+22+22+35+42	1.54	1.54	1.54	2.45	2.94	10.00 (3.9 - 11.0)	2.780 (0.780 - 3.415)	12.21	99
22+22+22+35+50	1.46	1.46	1.46	2.32	3.31	10.00 (3.9 - 11.0)	2.770 (0.780 - 3.405)	12.17	99
22+22+22+35+60	1.37	1.37	1.37	2.17	3.73	10.00 (3.9 - 11.0)	2.740 (0.780 - 3.395)	12.03	99
22+22+22+35+71	1.28	1.28	1.28	2.03	4.13	10.00 (3.9 - 11.0)	2.720 (0.780 - 3.385)	11.95	99
22+22+22+42+42	1.47	1.47	1.47	2.80	2.80	10.00 (3.9 - 11.0)	2.760 (0.780 - 3.405)	12.12	99
22+22+22+42+50	1.39	1.39	1.39	2.66	3.16	10.00 (3.9 - 11.0)	2.750 (0.780 - 3.395)	12.08	99
22+22+22+42+60	1.31	1.31	1.31	2.50	3.57	10.00 (3.9 - 11.0)	2.720 (0.780 - 3.385)	11.95	99
22+22+25+25+25	1.85	1.85	2.10	2.10	2.10	10.00 (3.9 - 11.0)	2.800 (0.780 - 3.425)	12.30	99
22+22+25+25+35	1.71	1.71	1.94	1.94	2.71	10.00 (3.9 - 11.0)	2.800 (0.780 - 3.425)	12.30	99
22+22+25+25+42	1.62	1.62	1.84	1.84	3.09	10.00 (3.9 - 11.0)	2.780 (0.780 - 3.415)	12.21	99
22+22+25+25+50	1.53	1.53	1.74	1.74	3.47	10.00 (3.9 - 11.0)	2.770 (0.780 - 3.405)	12.17	99
22+22+25+25+60	1.43	1.43	1.62	1.62	3.90	10.00 (3.9 - 11.0)	2.740 (0.780 - 3.395)	12.03	99
22+22+25+25+71	1.33	1.33	1.52	1.52	4.30	10.00 (3.9 - 11.0)	2.720 (0.780 - 3.385)	11.95	99
22+22+25+35+35	1.58	1.58	1.80	2.52	2.52	10.00 (3.9 - 11.0)	2.800 (0.780 - 3.425)	12.30	99
22+22+25+35+42	1.51	1.51	1.71	2.40	2.88	10.00 (3.9 - 11.0)	2.780 (0.780 - 3.415)	12.21	99
22+22+25+35+50	1.43	1.43	1.62	2.27	3.25	10.00 (3.9 - 11.0)	2.770 (0.780 - 3.405)	12.17	99
22+22+25+35+60	1.34	1.34	1.52	2.13	3.66	10.00 (3.9 - 11.0)	2.740 (0.780 - 3.395)	12.03	99
22+22+25+42+42	1.44	1.44	1.63	2.75	2.75	10.00 (3.9 - 11.0)	2.760 (0.780 - 3.405)	12.12	99
22+22+25+42+50	1.37	1.37	1.55	2.61	3.11	10.00 (3.9 - 11.0)	2.750 (0.780 - 3.395)	12.08	99
22+22+25+42+60	1.29	1.29	1.46	2.46	3.51	10.00 (3.9 - 11.0)	2.720 (0.780 - 3.385)	11.95	99
22+22+35+35+35	1.48	1.48	2.35	2.35	2.35	10.00 (3.9 - 11.0)	2.800 (0.780 - 3.425)	12.30	99
22+22+35+35+42	1.41	1.41	2.24	2.24	2.69	10.00 (3.9 - 11.0)	2.780 (0.780 - 3.415)	12.21	99
22+22+35+35+50	1.34	1.34	2.13	2.13	3.05	10.00 (3.9 - 11.0)	2.770 (0.780 - 3.405)	12.17	99
22+22+35+42+42	1.35	1.35	2.15	2.58	2.58	10.00 (3.9 - 11.0)	2.760 (0.780 - 3.405)	12.12	99
22+22+35+42+50	1.29	1.29	2.05	2.46	2.92	10.00 (3.9 - 11.0)	2.750 (0.780 - 3.395)	12.08	99
22+22+42+42+42	1.29	1.29	2.47	2.47	2.47	10.00 (3.9 - 11.0)	2.740 (0.780 - 3.395)	12.03	99
22+25+25+25+25	1.80	2.05	2.05	2.05	2.05	10.00 (3.9 - 11.0)	2.800 (0.780 - 3.425)	12.30	99
22+25+25+25+35	1.67	1.89	1.89	1.89	2.65	10.00 (3.9 - 11.0)	2.800 (0.780 - 3.425)	12.30	99
22+25+25+25+42	1.58	1.80	1.80	1.80	3.02	10.00 (3.9 - 11.0)	2.780 (0.780 - 3.415)	12.21	99

MXZ-5C100VA(VA2) COOLING

Indoor units combination	Cooling capacity (kW)						Outdoor unit power consumption (kW)	Current (A)	Power factor (%)
	Unit A	Unit B	Unit C	Unit D	Unit E	Total			
22+25+25+25+50	1.50	1.70	1.70	1.70	3.40	10.00 (3.9 - 11.0)	2.770 (0.780 - 3.405)	12.17	99
22+25+25+25+60	1.40	1.59	1.59	1.59	3.82	10.00 (3.9 - 11.0)	2.740 (0.780 - 3.395)	12.03	99
22+25+25+25+71	1.31	1.49	1.49	1.49	4.23	10.00 (3.9 - 11.0)	2.720 (0.780 - 3.385)	11.95	99
22+25+25+35+35	1.55	1.76	1.76	2.46	2.46	10.00 (3.9 - 11.0)	2.800 (0.780 - 3.425)	12.30	99
22+25+25+35+42	1.48	1.68	1.68	2.35	2.82	10.00 (3.9 - 11.0)	2.780 (0.780 - 3.415)	12.21	99
22+25+25+35+50	1.40	1.59	1.59	2.23	3.18	10.00 (3.9 - 11.0)	2.770 (0.780 - 3.405)	12.17	99
22+25+25+35+60	1.32	1.50	1.50	2.10	3.59	10.00 (3.9 - 11.0)	2.740 (0.780 - 3.395)	12.03	99
22+25+25+42+42	1.41	1.60	1.60	2.69	2.69	10.00 (3.9 - 11.0)	2.760 (0.780 - 3.405)	12.12	99
22+25+25+42+50	1.34	1.52	1.52	2.56	3.05	10.00 (3.9 - 11.0)	2.750 (0.780 - 3.395)	12.08	99
22+25+35+35+35	1.45	1.64	2.30	2.30	2.30	10.00 (3.9 - 11.0)	2.800 (0.780 - 3.425)	12.30	99
22+25+35+35+42	1.38	1.57	2.20	2.20	2.64	10.00 (3.9 - 11.0)	2.780 (0.780 - 3.415)	12.21	99
22+25+35+35+50	1.32	1.50	2.10	2.10	2.99	10.00 (3.9 - 11.0)	2.770 (0.780 - 3.405)	12.17	99
22+25+35+42+42	1.33	1.51	2.11	2.53	2.53	10.00 (3.9 - 11.0)	2.760 (0.780 - 3.405)	12.12	99
22+35+35+35+35	1.36	2.16	2.16	2.16	2.16	10.00 (3.9 - 11.0)	2.800 (0.780 - 3.425)	12.30	99
22+35+35+35+42	1.30	2.07	2.07	2.07	2.49	10.00 (3.9 - 11.0)	2.780 (0.780 - 3.415)	12.21	99
25+25+25+25+25	2.00	2.00	2.00	2.00	2.00	10.00 (3.9 - 11.0)	2.800 (0.780 - 3.425)	12.30	99
25+25+25+25+35	1.85	1.85	1.85	1.85	2.59	10.00 (3.9 - 11.0)	2.800 (0.780 - 3.425)	12.30	99
25+25+25+25+42	1.76	1.76	1.76	1.76	2.96	10.00 (3.9 - 11.0)	2.780 (0.780 - 3.415)	12.21	99
25+25+25+25+50	1.67	1.67	1.67	1.67	3.33	10.00 (3.9 - 11.0)	2.770 (0.780 - 3.405)	12.17	99
25+25+25+25+60	1.56	1.56	1.56	1.56	3.75	10.00 (3.9 - 11.0)	2.740 (0.780 - 3.395)	12.03	99
25+25+25+25+71	1.46	1.46	1.46	1.46	4.15	10.00 (3.9 - 11.0)	2.720 (0.780 - 3.385)	11.95	99
25+25+25+35+35	1.72	1.72	1.72	2.41	2.41	10.00 (3.9 - 11.0)	2.800 (0.780 - 3.425)	12.30	99
25+25+25+35+42	1.64	1.64	1.64	2.30	2.76	10.00 (3.9 - 11.0)	2.780 (0.780 - 3.415)	12.21	99
25+25+25+35+50	1.56	1.56	1.56	2.19	3.13	10.00 (3.9 - 11.0)	2.770 (0.780 - 3.405)	12.17	99
25+25+25+35+60	1.47	1.47	1.47	2.06	3.53	10.00 (3.9 - 11.0)	2.740 (0.780 - 3.395)	12.03	99
25+25+25+42+42	1.57	1.57	1.57	2.64	2.64	10.00 (3.9 - 11.0)	2.760 (0.780 - 3.405)	12.12	99
25+25+25+42+50	1.50	1.50	1.50	2.51	2.99	10.00 (3.9 - 11.0)	2.750 (0.780 - 3.395)	12.08	99
25+25+35+35+35	1.61	1.61	2.26	2.26	2.26	10.00 (3.9 - 11.0)	2.800 (0.780 - 3.425)	12.30	99
25+25+35+35+42	1.54	1.54	2.16	2.16	2.59	10.00 (3.9 - 11.0)	2.780 (0.780 - 3.415)	12.21	99
25+25+35+35+50	1.47	1.47	2.06	2.06	2.94	10.00 (3.9 - 11.0)	2.770 (0.780 - 3.405)	12.17	99
25+25+35+42+42	1.48	1.48	2.07	2.49	2.49	10.00 (3.9 - 11.0)	2.760 (0.780 - 3.405)	12.12	99

MXZ-5C100VA(VA2) HEATING

Indoor units combination	Heating capacity (kW)					Outdoor unit power consumption (kW)	Current (A)	Power factor (%)	
	Unit A	Unit B	Unit C	Unit D	Unit E				Total
15	1.70					1.70 (1.2 - 3.0)	0.650 (0.540 - 1.670)	2.85	99
20	2.20					2.20 (1.2 - 3.9)	0.830 (0.540 - 2.170)	3.65	99
22	3.30					3.30 (1.2 - 4.2)	0.890 (0.340 - 1.590)	3.91	99
25	3.60					3.60 (1.2 - 4.5)	0.990 (0.340 - 1.740)	4.35	99
35	4.00					4.00 (1.2 - 5.5)	1.140 (0.330 - 1.810)	5.01	99
42	5.40					5.40 (1.3 - 6.5)	1.610 (0.330 - 2.260)	7.07	99
50	7.20					7.20 (1.4 - 7.7)	2.270 (0.330 - 2.710)	9.97	99
60	7.90					7.90 (1.4 - 8.6)	2.270 (0.330 - 3.060)	9.97	99
71	8.60					8.60 (1.6 - 9.2)	2.410 (0.360 - 3.520)	10.58	99
15+15	1.70	1.70				3.40 (1.8 - 5.0)	0.810 (0.590 - 2.780)	3.56	99
15+20	1.67	2.23				3.90 (1.8 - 5.8)	0.960 (0.580 - 3.230)	4.22	99
15+22	1.66	2.44				4.10 (1.8 - 6.1)	1.020 (0.530 - 3.390)	4.48	99
15+25	1.65	2.75				4.40 (1.8 - 6.6)	1.110 (0.640 - 3.670)	4.87	99
15+35	2.16	5.04				7.20 (1.8 - 8.8)	1.760 (0.530 - 3.140)	7.73	99
15+42	1.97	5.53				7.50 (1.8 - 9.3)	1.880 (0.530 - 3.200)	8.26	99
15+50	1.80	6.00				7.80 (1.8 - 9.7)	1.990 (0.530 - 3.230)	8.74	99
15+60	1.78	7.12				8.90 (1.8 - 10.2)	2.420 (0.530 - 3.350)	10.63	99
15+71	1.83	8.67				10.50 (1.8 - 11.0)	3.070 (0.510 - 3.580)	13.48	99
20+20	2.20	2.20				4.40 (1.8 - 6.6)	1.110 (0.590 - 3.670)	4.87	99
20+22	2.62	2.88				5.50 (1.8 - 6.9)	1.340 (0.530 - 3.220)	5.88	99
20+25	2.98	3.72				6.70 (1.8 - 7.5)	1.600 (0.530 - 2.830)	7.03	99
20+35	2.69	4.71				7.40 (1.8 - 9.2)	1.840 (0.530 - 3.190)	8.08	99
20+42	2.48	5.22				7.70 (1.8 - 9.6)	1.950 (0.530 - 3.230)	8.56	99
20+50	2.29	5.71				8.00 (1.8 - 9.8)	2.050 (0.530 - 3.230)	9.00	99
20+60	2.45	7.35				9.80 (1.8 - 10.7)	2.780 (0.530 - 3.490)	12.21	99
20+71	2.31	8.19				10.50 (1.8 - 11.0)	3.070 (0.510 - 3.580)	13.48	99
22+22	3.30	3.30				6.60 (1.8 - 7.2)	1.570 (0.480 - 2.760)	6.90	99
22+25	3.23	3.67				6.90 (1.8 - 8.0)	1.670 (0.480 - 2.950)	7.33	99
22+35	2.89	4.61				7.50 (1.8 - 9.3)	1.880 (0.480 - 3.200)	8.26	99
22+42	2.68	5.12				7.80 (1.8 - 9.7)	1.990 (0.480 - 3.230)	8.74	99
22+50	2.57	5.83				8.40 (1.8 - 10.0)	2.210 (0.480 - 3.290)	9.71	99
22+60	2.71	7.39				10.10 (1.8 - 10.8)	2.910 (0.480 - 3.520)	12.78	99
22+71	2.51	8.09				10.60 (1.8 - 11.9)	2.980 (0.460 - 3.770)	13.09	99
25+25	3.60	3.60				7.20 (1.8 - 8.8)	1.760 (0.480 - 3.140)	7.73	99
25+35	3.17	4.43				7.60 (1.8 - 9.5)	1.920 (0.480 - 3.230)	8.43	99
25+42	2.95	4.95				7.90 (1.8 - 9.7)	2.020 (0.480 - 3.230)	8.87	99
25+50	2.97	5.93				8.90 (1.8 - 10.2)	2.420 (0.480 - 3.350)	10.63	99
25+60	3.09	7.41				10.50 (1.8 - 11.0)	3.070 (0.460 - 3.580)	13.48	99
25+71	2.76	7.84				10.60 (1.8 - 11.9)	2.980 (0.460 - 3.770)	13.09	99
35+35	4.00	4.00				8.00 (1.8 - 9.8)	2.050 (0.480 - 3.230)	9.00	99
35+42	4.23	5.07				9.30 (1.8 - 10.4)	2.580 (0.480 - 3.410)	11.33	99
35+50	4.32	6.18				10.50 (1.8 - 11.0)	3.070 (0.460 - 3.580)	13.48	99

MXZ-5C100VA(VA2) HEATING

Indoor units combination	Heating capacity (kW)					Outdoor unit power consumption (kW)	Current (A)	Power factor (%)	
	Unit A	Unit B	Unit C	Unit D	Unit E				Total
35+60	3.91	6.69				10.60 (1.8 - 11.9)	2.980 (0.460 - 3.770)	13.09	99
35+71	3.50	7.10				10.60 (1.9 - 11.9)	2.850 (0.440 - 3.770)	12.52	99
42+42	5.25	5.25				10.50 (1.8 - 11.0)	3.070 (0.460 - 3.580)	13.48	99
42+50	4.84	5.76				10.60 (1.8 - 11.9)	2.980 (0.460 - 3.770)	13.09	99
42+60	4.36	6.24				10.60 (1.9 - 11.9)	2.940 (0.440 - 3.770)	12.91	99
42+71	3.94	6.66				10.60 (1.9 - 12.0)	2.700 (0.440 - 3.870)	11.86	99
50+50	5.30	5.30				10.60 (1.9 - 11.9)	2.980 (0.440 - 3.770)	13.09	99
50+60	4.82	5.78				10.60 (1.9 - 12.0)	2.770 (0.440 - 3.870)	12.17	99
50+71	4.38	6.22				10.60 (1.9 - 12.0)	2.550 (0.440 - 3.870)	11.20	99
60+60	5.30	5.30				10.60 (1.9 - 12.0)	2.550 (0.440 - 3.870)	11.20	99
60+71	4.85	5.75				10.60 (1.9 - 12.1)	2.510 (0.440 - 3.920)	11.02	99
71+71	5.30	5.30				10.60 (1.9 - 12.2)	2.460 (0.440 - 3.960)	10.80	99
15+15+15	1.70	1.70	1.70			5.10 (2.6 - 8.4)	1.130 (0.620 - 4.100)	4.96	99
15+15+20	1.68	1.68	2.24			5.60 (2.6 - 8.9)	1.270 (0.620 - 4.100)	5.58	99
15+15+22	1.67	1.67	2.45			5.80 (2.6 - 9.1)	1.330 (0.590 - 4.100)	5.84	99
15+15+25	1.66	1.66	2.77			6.10 (2.6 - 9.4)	1.410 (0.590 - 4.100)	6.19	99
15+15+35	1.94	1.94	4.52			8.40 (2.6 - 10.5)	1.890 (0.590 - 3.210)	8.30	99
15+15+42	1.85	1.85	5.19			8.90 (2.6 - 11.9)	2.000 (0.590 - 3.470)	8.78	99
15+15+50	1.73	1.73	5.75			9.20 (2.6 - 12.6)	2.110 (0.590 - 3.670)	9.27	99
15+15+60	1.58	1.58	6.33			9.50 (2.6 - 12.6)	2.220 (0.590 - 3.660)	9.75	99
15+15+71	1.47	1.47	6.96			9.90 (2.6 - 12.6)	2.370 (0.590 - 3.640)	10.41	99
15+20+20	1.66	2.22	2.22			6.10 (2.6 - 9.4)	1.410 (0.620 - 4.100)	6.19	99
15+20+22	1.66	2.21	2.43			6.30 (2.6 - 9.6)	1.470 (0.590 - 4.100)	6.46	99
15+20+25	1.65	2.20	2.75			6.60 (2.6 - 9.9)	1.550 (0.680 - 4.100)	6.81	99
15+20+35	1.89	2.51	4.40			8.80 (2.6 - 11.3)	1.980 (0.590 - 3.300)	8.70	99
15+20+42	1.77	2.36	4.96			9.10 (2.6 - 12.6)	2.070 (0.590 - 3.710)	9.09	99
15+20+50	1.64	2.19	5.47			9.30 (2.6 - 12.6)	2.140 (0.590 - 3.660)	9.40	99
15+20+60	1.53	2.04	6.13			9.70 (2.6 - 12.6)	2.300 (0.590 - 3.650)	10.10	99
15+20+71	1.42	1.89	6.70			10.00 (2.6 - 12.6)	2.410 (0.590 - 3.620)	10.58	99
15+22+22	1.65	2.42	2.42			6.50 (2.6 - 9.8)	1.520 (0.560 - 4.100)	6.68	99
15+22+25	1.77	2.59	2.94			7.30 (2.6 - 10.1)	1.680 (0.560 - 3.800)	7.38	99
15+22+35	1.85	2.72	4.33			8.90 (2.6 - 11.9)	2.000 (0.560 - 3.510)	8.78	99
15+22+42	1.73	2.53	4.84			9.10 (2.6 - 12.6)	2.070 (0.560 - 3.700)	9.09	99
15+22+50	1.62	2.38	5.40			9.40 (2.6 - 12.6)	2.180 (0.560 - 3.660)	9.57	99
15+22+60	1.50	2.20	6.00			9.70 (2.6 - 12.6)	2.300 (0.560 - 3.640)	10.10	99
15+22+71	1.40	2.06	6.64			10.10 (2.6 - 12.6)	2.440 (0.560 - 3.590)	10.72	99
15+25+25	1.94	3.23	3.23			8.40 (2.6 - 10.5)	1.890 (0.560 - 3.210)	8.30	99
15+25+35	1.80	3.00	4.20			9.00 (2.6 - 12.6)	2.030 (0.560 - 3.750)	8.92	99
15+25+42	1.68	2.80	4.71			9.20 (2.6 - 12.6)	2.110 (0.560 - 3.700)	9.27	99
15+25+50	1.58	2.64	5.28			9.50 (2.6 - 12.6)	2.220 (0.560 - 3.660)	9.75	99
15+25+60	1.47	2.45	5.88			9.80 (2.6 - 12.6)	2.330 (0.560 - 3.640)	10.23	99
15+25+71	1.38	2.30	6.52			10.20 (2.6 - 12.6)	2.460 (0.560 - 3.550)	10.80	99

MXZ-5C100VA(VA2) HEATING

Indoor units combination	Heating capacity (kW)						Outdoor unit power consumption (kW)	Current (A)	Power factor (%)
	Unit A	Unit B	Unit C	Unit D	Unit E	Total			
15+35+35	1.64	3.83	3.83			9.30 (2.6 - 12.6)	2.140 (0.560 - 3.730)	9.40	99
15+35+42	1.57	3.65	4.38			9.60 (2.6 - 12.6)	2.260 (0.560 - 3.680)	9.93	99
15+35+50	1.47	3.43	4.90			9.80 (2.6 - 12.6)	2.330 (0.560 - 3.640)	10.23	99
15+35+60	1.39	3.25	5.56			10.20 (2.6 - 12.6)	2.460 (0.560 - 3.570)	10.80	99
15+35+71	1.31	3.07	6.22			10.60 (2.6 - 12.6)	2.570 (0.560 - 3.420)	11.29	99
15+42+42	1.48	4.16	4.16			9.80 (2.6 - 12.6)	2.330 (0.560 - 3.630)	10.23	99
15+42+50	1.42	3.96	4.72			10.10 (2.6 - 12.6)	2.440 (0.560 - 3.560)	10.72	99
15+42+60	1.35	3.77	5.38			10.50 (2.6 - 12.6)	2.540 (0.560 - 3.440)	11.16	99
15+42+71	1.27	3.54	5.99			10.80 (2.7 - 12.6)	2.620 (0.540 - 3.310)	11.51	99
15+50+50	1.36	4.52	4.52			10.40 (2.6 - 12.6)	2.520 (0.560 - 3.430)	11.07	99
15+50+60	1.30	4.32	5.18			10.80 (2.6 - 12.6)	2.620 (0.560 - 3.300)	11.51	99
15+50+71	1.20	4.01	5.69			10.90 (2.7 - 12.6)	2.620 (0.540 - 3.220)	11.51	99
15+60+60	1.21	4.84	4.84			10.90 (2.7 - 12.6)	2.620 (0.540 - 3.220)	11.51	99
15+60+71	1.13	4.52	5.35			11.00 (2.7 - 12.6)	2.620 (0.540 - 3.140)	11.51	99
20+20+20	2.20	2.20	2.20			6.60 (2.6 - 9.9)	1.550 (0.620 - 4.100)	6.81	99
20+20+22	2.35	2.35	2.59			7.30 (2.6 - 10.1)	1.680 (0.590 - 3.800)	7.38	99
20+20+25	2.58	2.58	3.23			8.40 (2.6 - 10.5)	1.890 (0.590 - 3.210)	8.30	99
20+20+35	2.40	2.40	4.20			9.00 (2.6 - 12.6)	2.030 (0.590 - 3.750)	8.92	99
20+20+42	2.24	2.24	4.71			9.20 (2.6 - 12.6)	2.110 (0.590 - 3.700)	9.27	99
20+20+50	2.11	2.11	5.28			9.50 (2.6 - 12.6)	2.220 (0.590 - 3.660)	9.75	99
20+20+60	1.96	1.96	5.88			9.80 (2.6 - 12.6)	2.330 (0.590 - 3.640)	10.23	99
20+20+71	1.84	1.84	6.52			10.20 (2.6 - 12.6)	2.460 (0.590 - 3.550)	10.80	99
20+22+22	2.50	2.75	2.75			8.00 (2.6 - 10.4)	1.820 (0.560 - 3.360)	7.99	99
20+22+25	2.60	2.86	3.25			8.70 (2.6 - 10.6)	1.950 (0.560 - 3.060)	8.56	99
20+22+35	2.36	2.60	4.14			9.10 (2.6 - 12.6)	2.070 (0.560 - 3.750)	9.09	99
20+22+42	2.21	2.44	4.65			9.30 (2.6 - 12.6)	2.140 (0.560 - 3.700)	9.40	99
20+22+50	2.09	2.30	5.22			9.60 (2.6 - 12.6)	2.260 (0.560 - 3.650)	9.93	99
20+22+60	1.94	2.14	5.82			9.90 (2.6 - 12.6)	2.370 (0.560 - 3.640)	10.41	99
20+22+71	1.82	2.01	6.47			10.30 (2.6 - 12.6)	2.490 (0.560 - 3.530)	10.94	99
20+25+25	2.51	3.14	3.14			8.80 (2.6 - 11.3)	1.980 (0.560 - 3.300)	8.70	99
20+25+35	2.30	2.88	4.03			9.20 (2.6 - 12.6)	2.110 (0.560 - 3.740)	9.27	99
20+25+42	2.16	2.70	4.54			9.40 (2.6 - 12.6)	2.180 (0.560 - 3.690)	9.57	99
20+25+50	2.04	2.55	5.11			9.70 (2.6 - 12.6)	2.300 (0.560 - 3.650)	10.10	99
20+25+60	1.90	2.38	5.71			10.00 (2.6 - 12.6)	2.410 (0.560 - 3.630)	10.58	99
20+25+71	1.79	2.24	6.37			10.40 (2.6 - 12.6)	2.520 (0.560 - 3.490)	11.07	99
20+35+35	2.11	3.69	3.69			9.50 (2.6 - 12.6)	2.220 (0.560 - 3.730)	9.75	99
20+35+42	2.00	3.50	4.20			9.70 (2.6 - 12.6)	2.300 (0.560 - 3.670)	10.10	99
20+35+50	1.90	3.33	4.76			10.00 (2.6 - 12.6)	2.410 (0.560 - 3.630)	10.58	99
20+35+60	1.81	3.17	5.43			10.40 (2.6 - 12.6)	2.520 (0.560 - 3.500)	11.07	99
20+35+71	1.71	3.00	6.09			10.80 (2.7 - 12.6)	2.620 (0.540 - 3.360)	11.51	99
20+42+42	1.92	4.04	4.04			10.00 (2.6 - 12.6)	2.410 (0.560 - 3.620)	10.58	99
20+42+50	1.84	3.86	4.60			10.30 (2.6 - 12.6)	2.490 (0.560 - 3.500)	10.94	99

MXZ-5C100VA(VA2) HEATING

Indoor units combination	Heating capacity (kW)					Outdoor unit power consumption (kW)	Current (A)	Power factor (%)	
	Unit A	Unit B	Unit C	Unit D	Unit E				Total
20+42+60	1.74	3.65	5.21			10.60 (2.6 - 12.6)	2.570 (0.560 - 3.370)	11.29	99
20+42+71	1.64	3.44	5.82			10.90 (2.7 - 12.6)	2.620 (0.540 - 3.270)	11.51	99
20+50+50	1.77	4.42	4.42			10.60 (2.6 - 12.6)	2.570 (0.560 - 3.370)	11.29	99
20+50+60	1.66	4.15	4.98			10.80 (2.7 - 12.6)	2.620 (0.540 - 3.260)	11.51	99
20+50+71	1.55	3.87	5.49			10.90 (2.7 - 12.6)	2.620 (0.540 - 3.180)	11.51	99
20+60+60	1.56	4.67	4.67			10.90 (2.7 - 12.6)	2.620 (0.540 - 3.190)	11.51	99
20+60+71	1.46	4.37	5.17			11.00 (2.7 - 12.6)	2.620 (0.520 - 3.110)	11.51	99
22+22+22	2.90	2.90	2.90			8.70 (2.6 - 10.6)	1.950 (0.530 - 3.060)	8.56	99
22+22+25	2.81	2.81	3.19			8.80 (2.6 - 11.3)	1.980 (0.530 - 3.300)	8.70	99
22+22+35	2.53	2.53	4.03			9.10 (2.6 - 12.6)	2.070 (0.530 - 3.740)	9.09	99
22+22+42	2.40	2.40	4.59			9.40 (2.6 - 12.6)	2.180 (0.530 - 3.690)	9.57	99
22+22+50	2.25	2.25	5.11			9.60 (2.6 - 12.6)	2.260 (0.530 - 3.650)	9.93	99
22+22+60	2.12	2.12	5.77			10.00 (2.6 - 12.6)	2.410 (0.530 - 3.630)	10.58	99
22+22+71	1.99	1.99	6.42			10.40 (2.6 - 12.6)	2.520 (0.530 - 3.500)	11.07	99
22+25+25	2.72	3.09	3.09			8.90 (2.6 - 11.9)	2.000 (0.530 - 3.510)	8.78	99
22+25+35	2.47	2.80	3.93			9.20 (2.6 - 12.6)	2.110 (0.530 - 3.740)	9.27	99
22+25+42	2.35	2.67	4.48			9.50 (2.6 - 12.6)	2.220 (0.530 - 3.690)	9.75	99
22+25+50	2.20	2.50	5.00			9.70 (2.6 - 12.6)	2.300 (0.530 - 3.640)	10.10	99
22+25+60	2.08	2.36	5.66			10.10 (2.6 - 12.6)	2.440 (0.530 - 3.600)	10.72	99
22+25+71	1.96	2.22	6.32			10.50 (2.6 - 12.6)	2.540 (0.530 - 3.460)	11.16	99
22+35+35	2.30	3.65	3.65			9.60 (2.6 - 12.6)	2.260 (0.530 - 3.720)	9.93	99
22+35+42	2.18	3.46	4.16			9.80 (2.6 - 12.6)	2.330 (0.530 - 3.670)	10.23	99
22+35+50	2.08	3.30	4.72			10.10 (2.6 - 12.6)	2.440 (0.530 - 3.600)	10.72	99
22+35+60	1.97	3.14	5.38			10.50 (2.6 - 12.6)	2.540 (0.530 - 3.480)	11.16	99
22+35+71	1.86	2.95	5.99			10.80 (2.7 - 12.6)	2.620 (0.510 - 3.350)	11.51	99
22+42+42	2.08	3.96	3.96			10.00 (2.6 - 12.6)	2.410 (0.530 - 3.610)	10.58	99
22+42+50	1.99	3.79	4.52			10.30 (2.6 - 12.6)	2.490 (0.530 - 3.470)	10.94	99
22+42+60	1.90	3.62	5.18			10.70 (2.6 - 12.6)	2.590 (0.530 - 3.350)	11.37	99
22+42+71	1.78	3.39	5.73			10.90 (2.7 - 12.6)	2.620 (0.510 - 3.250)	11.51	99
22+50+50	1.91	4.34	4.34			10.60 (2.6 - 12.6)	2.570 (0.530 - 3.340)	11.29	99
22+50+60	1.82	4.13	4.95			10.90 (2.7 - 12.6)	2.620 (0.510 - 3.250)	11.51	99
22+50+71	1.68	3.81	5.41			10.90 (2.7 - 12.6)	2.620 (0.510 - 3.160)	11.51	99
22+60+60	1.69	4.61	4.61			10.90 (2.7 - 12.6)	2.620 (0.510 - 3.170)	11.51	99
22+60+71	1.58	4.31	5.10			11.00 (2.7 - 12.6)	2.620 (0.490 - 3.110)	11.51	99
25+25+25	3.00	3.00	3.00			9.00 (2.6 - 12.6)	2.030 (0.530 - 3.750)	8.92	99
25+25+35	2.74	2.74	3.83			9.30 (2.6 - 12.6)	2.140 (0.530 - 3.730)	9.40	99
25+25+42	2.61	2.61	4.38			9.60 (2.6 - 12.6)	2.260 (0.530 - 3.680)	9.93	99
25+25+50	2.45	2.45	4.90			9.80 (2.6 - 12.6)	2.330 (0.530 - 3.640)	10.23	99
25+25+60	2.32	2.32	5.56			10.20 (2.6 - 12.6)	2.460 (0.530 - 3.570)	10.80	99
25+25+71	2.19	2.19	6.22			10.60 (2.6 - 12.6)	2.570 (0.530 - 3.420)	11.29	99
25+35+35	2.55	3.57	3.57			9.70 (2.6 - 12.6)	2.300 (0.530 - 3.720)	10.10	99
25+35+42	2.43	3.40	4.08			9.90 (2.6 - 12.6)	2.370 (0.530 - 3.670)	10.41	99

MXZ-5C100VA(VA2) HEATING

Indoor units combination	Heating capacity (kW)					Outdoor unit power consumption (kW)	Current (A)	Power factor (%)	
	Unit A	Unit B	Unit C	Unit D	Unit E				Total
25+35+50	2.32	3.25	4.64			10.20 (2.6 - 12.6)	2.460 (0.530 - 3.570)	10.80	99
25+35+60	2.21	3.09	5.30			10.60 (2.6 - 12.6)	2.570 (0.530 - 3.440)	11.29	99
25+35+71	2.06	2.89	5.85			10.80 (2.7 - 12.6)	2.620 (0.510 - 3.320)	11.51	99
25+42+42	2.34	3.93	3.93			10.20 (2.6 - 12.6)	2.460 (0.530 - 3.570)	10.80	99
25+42+50	2.24	3.77	4.49			10.50 (2.6 - 12.6)	2.540 (0.530 - 3.440)	11.16	99
25+42+60	2.13	3.57	5.10			10.80 (2.7 - 12.6)	2.620 (0.510 - 3.310)	11.51	99
25+42+71	1.97	3.32	5.61			10.90 (2.7 - 12.6)	2.620 (0.510 - 3.230)	11.51	99
25+50+50	2.16	4.32	4.32			10.80 (2.6 - 12.6)	2.620 (0.530 - 3.300)	11.51	99
25+50+60	2.02	4.04	4.84			10.90 (2.7 - 12.6)	2.620 (0.510 - 3.220)	11.51	99
25+50+71	1.88	3.77	5.35			11.00 (2.7 - 12.6)	2.620 (0.510 - 3.140)	11.51	99
25+60+60	1.90	4.55	4.55			11.00 (2.7 - 12.6)	2.620 (0.510 - 3.150)	11.51	99
25+60+71	1.76	4.23	5.01			11.00 (2.7 - 12.6)	2.620 (0.490 - 3.110)	11.51	99
35+35+35	3.33	3.33	3.33			10.00 (2.6 - 12.6)	2.410 (0.530 - 3.700)	10.58	99
35+35+42	3.22	3.22	3.86			10.30 (2.6 - 12.6)	2.490 (0.530 - 3.570)	10.94	99
35+35+50	3.09	3.09	4.42			10.60 (2.6 - 12.6)	2.570 (0.530 - 3.440)	11.29	99
35+35+60	2.91	2.91	4.98			10.80 (2.7 - 12.6)	2.620 (0.510 - 3.330)	11.51	99
35+35+71	2.71	2.71	5.49			10.90 (2.7 - 12.6)	2.620 (0.510 - 3.250)	11.51	99
35+42+42	3.09	3.71	3.71			10.50 (2.6 - 12.6)	2.540 (0.530 - 3.440)	11.16	99
35+42+50	2.98	3.57	4.25			10.80 (2.7 - 12.6)	2.620 (0.510 - 3.310)	11.51	99
35+42+60	2.78	3.34	4.77			10.90 (2.7 - 12.6)	2.620 (0.510 - 3.240)	11.51	99
35+42+71	2.60	3.12	5.28			11.00 (2.7 - 12.6)	2.620 (0.510 - 3.160)	11.51	99
35+50+50	2.83	4.04	4.04			10.90 (2.7 - 12.6)	2.620 (0.510 - 3.220)	11.51	99
35+50+60	2.66	3.79	4.55			11.00 (2.7 - 12.6)	2.620 (0.510 - 3.150)	11.51	99
35+50+71	2.47	3.53	5.01			11.00 (2.7 - 12.6)	2.620 (0.490 - 3.110)	11.51	99
35+60+60	2.48	4.26	4.26			11.00 (2.7 - 12.6)	2.620 (0.490 - 3.110)	11.51	99
35+60+71	2.32	3.98	4.70			11.00 (2.7 - 12.6)	2.620 (0.490 - 3.110)	11.51	99
42+42+42	3.60	3.60	3.60			10.80 (2.7 - 12.6)	2.620 (0.510 - 3.430)	11.51	99
42+42+50	3.42	3.42	4.07			10.90 (2.7 - 12.6)	2.620 (0.510 - 3.220)	11.51	99
42+42+60	3.21	3.21	4.58			11.00 (2.7 - 12.6)	2.620 (0.510 - 3.150)	11.51	99
42+42+71	2.98	2.98	5.04			11.00 (2.7 - 12.6)	2.620 (0.490 - 3.100)	11.51	99
42+50+50	3.22	3.84	3.84			10.90 (2.7 - 12.6)	2.620 (0.510 - 3.130)	11.51	99
42+50+60	3.04	3.62	4.34			11.00 (2.7 - 12.6)	2.620 (0.490 - 3.070)	11.51	99
42+50+71	2.83	3.37	4.79			11.00 (2.7 - 12.6)	2.620 (0.490 - 3.070)	11.51	99
42+60+60	2.85	4.07	4.07			11.00 (2.7 - 12.6)	2.620 (0.490 - 3.070)	11.51	99
50+50+50	3.67	3.67	3.67			11.00 (2.7 - 12.6)	2.620 (0.490 - 3.250)	11.51	99
50+50+60	3.44	3.44	4.13			11.00 (2.7 - 12.6)	2.620 (0.490 - 3.040)	11.51	99
50+50+71	3.22	3.22	4.57			11.00 (2.7 - 12.6)	2.620 (0.490 - 3.040)	11.51	99
15+15+15+15	1.70	1.70	1.70	1.70		6.80 (3.4 - 9.3)	1.500 (0.750 - 4.100)	6.59	99
15+15+15+20	1.68	1.68	1.68	2.25		7.30 (3.4 - 10.1)	1.650 (0.750 - 4.100)	7.25	99
15+15+15+22	1.68	1.68	1.68	2.46		7.50 (3.4 - 10.4)	1.710 (0.710 - 4.100)	7.51	99
15+15+15+25	1.67	1.67	1.67	2.79		7.80 (3.4 - 10.9)	1.810 (0.710 - 4.100)	7.95	99
15+15+15+35	1.65	1.65	1.65	3.85		8.80 (3.4 - 12.4)	2.110 (0.870 - 4.100)	9.27	99

MXZ-5C100VA(VA2) HEATING

Indoor units combination	Heating capacity (kW)					Total	Outdoor unit power consumption (kW)	Current (A)	Power factor (%)
	Unit A	Unit B	Unit C	Unit D	Unit E				
15+15+15+42	1.71	1.71	1.71	4.78		9.90 (3.4 - 13.2)	2.150 (0.710 - 3.880)	9.44	99
15+15+15+50	1.58	1.58	1.58	5.26		10.00 (3.4 - 13.3)	2.140 (0.710 - 3.870)	9.40	99
15+15+15+60	1.44	1.44	1.44	5.77		10.10 (3.4 - 13.3)	2.130 (0.710 - 3.870)	9.35	99
15+15+15+71	1.34	1.34	1.34	6.37		10.40 (3.4 - 13.3)	2.210 (0.710 - 3.870)	9.71	99
15+15+20+20	1.67	1.67	2.23	2.23		7.80 (3.4 - 10.9)	1.810 (0.750 - 4.100)	7.95	99
15+15+20+22	1.67	1.67	2.22	2.44		8.00 (3.4 - 11.2)	1.870 (0.710 - 4.100)	8.21	99
15+15+20+25	1.66	1.66	2.21	2.77		8.30 (3.4 - 11.6)	1.960 (0.710 - 4.100)	8.61	99
15+15+20+35	1.69	1.69	2.26	3.95		9.60 (3.4 - 13.0)	2.160 (0.710 - 3.970)	9.49	99
15+15+20+42	1.63	1.63	2.17	4.57		10.00 (3.4 - 13.3)	2.150 (0.710 - 3.860)	9.44	99
15+15+20+50	1.50	1.50	2.00	5.00		10.00 (3.4 - 13.3)	2.130 (0.710 - 3.870)	9.35	99
15+15+20+60	1.40	1.40	1.87	5.62		10.30 (3.4 - 13.3)	2.200 (0.710 - 3.870)	9.66	99
15+15+20+71	1.30	1.30	1.74	6.16		10.50 (3.4 - 13.3)	2.240 (0.710 - 3.870)	9.84	99
15+15+22+22	1.66	1.66	2.44	2.44		8.20 (3.4 - 11.5)	1.930 (0.670 - 4.100)	8.48	99
15+15+22+25	1.66	1.66	2.43	2.76		8.50 (3.4 - 11.9)	2.020 (0.670 - 4.100)	8.87	99
15+15+22+35	1.71	1.71	2.50	3.98		9.90 (3.4 - 13.2)	2.170 (0.670 - 3.920)	9.53	99
15+15+22+42	1.60	1.60	2.34	4.47		10.00 (3.4 - 13.3)	2.150 (0.670 - 3.860)	9.44	99
15+15+22+50	1.49	1.49	2.18	4.95		10.10 (3.4 - 13.3)	2.160 (0.670 - 3.870)	9.49	99
15+15+22+60	1.38	1.38	2.02	5.52		10.30 (3.4 - 13.3)	2.200 (0.670 - 3.870)	9.66	99
15+15+22+71	1.29	1.29	1.90	6.12		10.60 (3.4 - 13.3)	2.270 (0.670 - 3.870)	9.97	99
15+15+25+25	1.65	1.65	2.75	2.75		8.80 (3.4 - 12.4)	2.110 (0.830 - 4.100)	9.27	99
15+15+25+35	1.67	1.67	2.78	3.89		10.00 (3.4 - 13.3)	2.180 (0.670 - 3.900)	9.57	99
15+15+25+42	1.55	1.55	2.58	4.33		10.00 (3.4 - 13.3)	2.150 (0.670 - 3.860)	9.44	99
15+15+25+50	1.44	1.44	2.40	4.81		10.10 (3.4 - 13.3)	2.160 (0.670 - 3.870)	9.49	99
15+15+25+60	1.36	1.36	2.26	5.43		10.40 (3.4 - 13.3)	2.230 (0.670 - 3.870)	9.79	99
15+15+25+71	1.27	1.27	2.12	6.03		10.70 (3.4 - 13.3)	2.300 (0.670 - 3.870)	10.10	99
15+15+35+35	1.50	1.50	3.50	3.50		10.00 (3.4 - 13.3)	2.160 (0.670 - 3.900)	9.49	99
15+15+35+42	1.43	1.43	3.34	4.00		10.20 (3.4 - 13.3)	2.200 (0.670 - 3.860)	9.66	99
15+15+35+50	1.36	1.36	3.17	4.52		10.40 (3.4 - 13.3)	2.260 (0.670 - 3.870)	9.93	99
15+15+35+60	1.27	1.27	2.97	5.09		10.60 (3.4 - 13.3)	2.290 (0.670 - 3.870)	10.06	99
15+15+35+71	1.20	1.20	2.81	5.69		10.90 (3.4 - 13.3)	2.370 (0.670 - 3.870)	10.41	99
15+15+42+42	1.37	1.37	3.83	3.83		10.40 (3.4 - 13.3)	2.250 (0.670 - 3.820)	9.88	99
15+15+42+50	1.30	1.30	3.65	4.34		10.60 (3.4 - 13.3)	2.300 (0.670 - 3.830)	10.10	99
15+15+42+60	1.23	1.23	3.44	4.91		10.80 (3.4 - 13.3)	2.340 (0.670 - 3.830)	10.28	99
15+15+42+71	1.15	1.15	3.23	5.46		11.00 (3.4 - 13.3)	2.350 (0.670 - 3.830)	10.32	99
15+15+50+50	1.25	1.25	4.15	4.15		10.80 (3.4 - 13.3)	2.360 (0.670 - 3.840)	10.36	99
15+15+50+60	1.18	1.18	3.93	4.71		11.00 (3.4 - 13.3)	2.390 (0.670 - 3.840)	10.50	99
15+15+50+71	1.09	1.09	3.64	5.17		11.00 (3.4 - 13.3)	2.280 (0.670 - 3.830)	10.01	99
15+20+20+20	1.66	2.21	2.21	2.21		8.30 (3.4 - 11.6)	1.960 (0.750 - 4.100)	8.61	99
15+20+20+22	1.66	2.21	2.21	2.43		8.50 (3.4 - 11.9)	2.020 (0.710 - 4.100)	8.87	99
15+20+20+25	1.65	2.20	2.20	2.75		8.80 (3.4 - 12.4)	2.110 (0.870 - 4.100)	9.27	99
15+20+20+35	1.67	2.22	2.22	3.89		10.00 (3.4 - 13.3)	2.180 (0.710 - 3.900)	9.57	99
15+20+20+42	1.55	2.06	2.06	4.33		10.00 (3.4 - 13.3)	2.150 (0.710 - 3.860)	9.44	99

MXZ-5C100VA(VA2) HEATING

Indoor units combination	Heating capacity (kW)					Total	Outdoor unit power consumption (kW)	Current (A)	Power factor (%)
	Unit A	Unit B	Unit C	Unit D	Unit E				
15+20+20+50	1.44	1.92	1.92	4.81		10.10 (3.4 - 13.3)	2.160 (0.710 - 3.870)	9.49	99
15+20+20+60	1.36	1.81	1.81	5.43		10.40 (3.4 - 13.3)	2.230 (0.710 - 3.870)	9.79	99
15+20+20+71	1.27	1.70	1.70	6.03		10.70 (3.4 - 13.3)	2.300 (0.710 - 3.870)	10.10	99
15+20+22+22	1.65	2.20	2.42	2.42		8.70 (3.4 - 12.2)	2.080 (0.670 - 4.100)	9.13	99
15+20+22+25	1.66	2.22	2.44	2.77		9.10 (3.4 - 12.6)	2.130 (0.670 - 4.060)	9.35	99
15+20+22+35	1.63	2.17	2.39	3.80		10.00 (3.4 - 13.3)	2.170 (0.670 - 3.900)	9.53	99
15+20+22+42	1.52	2.02	2.22	4.24		10.00 (3.4 - 13.3)	2.140 (0.670 - 3.860)	9.40	99
15+20+22+50	1.43	1.91	2.10	4.77		10.20 (3.4 - 13.3)	2.190 (0.670 - 3.870)	9.62	99
15+20+22+60	1.33	1.78	1.96	5.33		10.40 (3.4 - 13.3)	2.230 (0.670 - 3.870)	9.79	99
15+20+22+71	1.25	1.67	1.84	5.94		10.70 (3.4 - 13.3)	2.300 (0.670 - 3.870)	10.10	99
15+20+25+25	1.69	2.26	2.82	2.82		9.60 (3.4 - 13.0)	2.160 (0.670 - 3.970)	9.49	99
15+20+25+35	1.58	2.11	2.63	3.68		10.00 (3.4 - 13.3)	2.170 (0.670 - 3.900)	9.53	99
15+20+25+42	1.49	1.98	2.48	4.16		10.10 (3.4 - 13.3)	2.170 (0.670 - 3.860)	9.53	99
15+20+25+50	1.40	1.87	2.34	4.68		10.30 (3.4 - 13.3)	2.230 (0.670 - 3.870)	9.79	99
15+20+25+60	1.31	1.75	2.19	5.25		10.50 (3.4 - 13.3)	2.260 (0.670 - 3.870)	9.93	99
15+20+25+71	1.24	1.65	2.06	5.85		10.80 (3.4 - 13.3)	2.340 (0.670 - 3.870)	10.28	99
15+20+35+35	1.44	1.92	3.37	3.37		10.10 (3.4 - 13.3)	2.190 (0.670 - 3.900)	9.62	99
15+20+35+42	1.38	1.84	3.22	3.86		10.30 (3.4 - 13.3)	2.240 (0.670 - 3.860)	9.84	99
15+20+35+50	1.31	1.75	3.06	4.38		10.50 (3.4 - 13.3)	2.290 (0.670 - 3.870)	10.06	99
15+20+35+60	1.25	1.66	2.91	4.98		10.80 (3.4 - 13.3)	2.360 (0.670 - 3.870)	10.36	99
15+20+35+71	1.17	1.56	2.73	5.54		11.00 (3.4 - 13.3)	2.390 (0.670 - 3.870)	10.50	99
15+20+42+42	1.32	1.76	3.71	3.71		10.50 (3.4 - 13.3)	2.280 (0.670 - 3.820)	10.01	99
15+20+42+50	1.26	1.69	3.54	4.21		10.70 (3.4 - 13.3)	2.330 (0.670 - 3.830)	10.23	99
15+20+42+60	1.19	1.59	3.34	4.77		10.90 (3.4 - 13.3)	2.370 (0.670 - 3.830)	10.41	99
15+20+42+71	1.11	1.49	3.12	5.28		11.00 (3.4 - 13.3)	2.310 (0.670 - 3.820)	10.14	99
15+20+50+50	1.21	1.61	4.04	4.04		10.90 (3.4 - 13.3)	2.390 (0.670 - 3.840)	10.50	99
15+20+50+60	1.14	1.52	3.79	4.55		11.00 (3.4 - 13.3)	2.350 (0.670 - 3.840)	10.32	99
15+20+50+71	1.06	1.41	3.53	5.01		11.00 (3.4 - 13.3)	2.230 (0.670 - 3.830)	9.79	99
15+22+22+22	1.67	2.44	2.44	2.44		9.00 (3.4 - 12.6)	2.120 (0.630 - 4.060)	9.31	99
15+22+22+25	1.68	2.46	2.46	2.80		9.40 (3.4 - 12.9)	2.150 (0.630 - 3.990)	9.44	99
15+22+22+35	1.60	2.34	2.34	3.72		10.00 (3.4 - 13.3)	2.170 (0.630 - 3.900)	9.53	99
15+22+22+42	1.49	2.18	2.18	4.16		10.00 (3.4 - 13.3)	2.140 (0.630 - 3.860)	9.40	99
15+22+22+50	1.40	2.06	2.06	4.68		10.20 (3.4 - 13.3)	2.190 (0.630 - 3.870)	9.62	99
15+22+22+60	1.32	1.94	1.94	5.29		10.50 (3.4 - 13.3)	2.260 (0.630 - 3.870)	9.93	99
15+22+22+71	1.25	1.83	1.83	5.90		10.80 (3.4 - 13.3)	2.340 (0.630 - 3.870)	10.28	99
15+22+25+25	1.71	2.50	2.84	2.84		9.90 (3.4 - 13.2)	2.170 (0.630 - 3.920)	9.53	99
15+22+25+35	1.55	2.27	2.58	3.61		10.00 (3.4 - 13.3)	2.170 (0.630 - 3.900)	9.53	99
15+22+25+42	1.46	2.14	2.43	4.08		10.10 (3.4 - 13.3)	2.170 (0.630 - 3.860)	9.53	99
15+22+25+50	1.38	2.02	2.30	4.60		10.30 (3.4 - 13.3)	2.230 (0.630 - 3.870)	9.79	99
15+22+25+60	1.30	1.91	2.17	5.21		10.60 (3.4 - 13.3)	2.290 (0.630 - 3.870)	10.06	99
15+22+25+71	1.22	1.79	2.03	5.77		10.80 (3.4 - 13.3)	2.340 (0.630 - 3.870)	10.28	99
15+22+35+35	1.43	2.10	3.34	3.34		10.20 (3.4 - 13.3)	2.220 (0.630 - 3.900)	9.75	99

MXZ-5C100VA(VA2) HEATING

Indoor units combination	Heating capacity (kW)					Outdoor unit power consumption (kW)	Current (A)	Power factor (%)	
	Unit A	Unit B	Unit C	Unit D	Unit E				Total
15+22+35+42	1.37	2.01	3.19	3.83		10.40 (3.4 - 13.3)	2.270 (0.630 - 3.860)	9.97	99
15+22+35+50	1.30	1.91	3.04	4.34		10.60 (3.4 - 13.3)	2.320 (0.630 - 3.870)	10.19	99
15+22+35+60	1.23	1.80	2.86	4.91		10.80 (3.4 - 13.3)	2.360 (0.630 - 3.870)	10.36	99
15+22+35+71	1.15	1.69	2.69	5.46		11.00 (3.4 - 13.3)	2.370 (0.630 - 3.870)	10.41	99
15+22+42+42	1.30	1.91	3.64	3.64		10.50 (3.4 - 13.3)	2.280 (0.630 - 3.820)	10.01	99
15+22+42+50	1.24	1.82	3.48	4.15		10.70 (3.4 - 13.3)	2.330 (0.630 - 3.830)	10.23	99
15+22+42+60	1.19	1.74	3.32	4.75		11.00 (3.4 - 13.3)	2.400 (0.630 - 3.830)	10.54	99
15+22+42+71	1.10	1.61	3.08	5.21		11.00 (3.4 - 13.3)	2.290 (0.630 - 3.820)	10.06	99
15+22+50+50	1.19	1.75	3.98	3.98		10.90 (3.4 - 13.3)	2.390 (0.630 - 3.840)	10.50	99
15+22+50+60	1.12	1.65	3.74	4.49		11.00 (3.4 - 13.3)	2.330 (0.630 - 3.840)	10.23	99
15+22+50+71	1.04	1.53	3.48	4.94		11.00 (3.4 - 13.3)	2.220 (0.630 - 3.830)	9.75	99
15+25+25+25	1.67	2.78	2.78	2.78		10.00 (3.4 - 13.3)	2.180 (0.630 - 3.900)	9.57	99
15+25+25+35	1.50	2.50	2.50	3.50		10.00 (3.4 - 13.3)	2.160 (0.630 - 3.900)	9.49	99
15+25+25+42	1.43	2.38	2.38	4.00		10.20 (3.4 - 13.3)	2.200 (0.630 - 3.860)	9.66	99
15+25+25+50	1.36	2.26	2.26	4.52		10.40 (3.4 - 13.3)	2.260 (0.630 - 3.870)	9.93	99
15+25+25+60	1.27	2.12	2.12	5.09		10.60 (3.4 - 13.3)	2.290 (0.630 - 3.870)	10.06	99
15+25+25+71	1.20	2.00	2.00	5.69		10.90 (3.4 - 13.3)	2.370 (0.630 - 3.870)	10.41	99
15+25+35+35	1.40	2.34	3.28	3.28		10.30 (3.4 - 13.3)	2.260 (0.630 - 3.900)	9.93	99
15+25+35+42	1.33	2.22	3.11	3.73		10.40 (3.4 - 13.3)	2.270 (0.630 - 3.860)	9.97	99
15+25+35+50	1.27	2.12	2.97	4.24		10.60 (3.4 - 13.3)	2.320 (0.630 - 3.870)	10.19	99
15+25+35+60	1.21	2.02	2.83	4.84		10.90 (3.4 - 13.3)	2.390 (0.630 - 3.870)	10.50	99
15+25+35+71	1.13	1.88	2.64	5.35		11.00 (3.4 - 13.3)	2.350 (0.630 - 3.870)	10.32	99
15+25+42+42	1.28	2.14	3.59	3.59		10.60 (3.4 - 13.3)	2.310 (0.630 - 3.820)	10.14	99
15+25+42+50	1.23	2.05	3.44	4.09		10.80 (3.4 - 13.3)	2.370 (0.630 - 3.830)	10.41	99
15+25+42+60	1.16	1.94	3.25	4.65		11.00 (3.4 - 13.3)	2.380 (0.630 - 3.830)	10.45	99
15+25+42+71	1.08	1.80	3.02	5.10		11.00 (3.4 - 13.3)	2.270 (0.630 - 3.820)	9.97	99
15+25+50+50	1.18	1.96	3.93	3.93		11.00 (3.4 - 13.3)	2.420 (0.630 - 3.840)	10.63	99
15+25+50+60	1.10	1.83	3.67	4.40		11.00 (3.4 - 13.3)	2.300 (0.630 - 3.830)	10.10	99
15+25+50+71	1.02	1.71	3.42	4.85		11.00 (3.4 - 13.3)	2.190 (0.630 - 3.830)	9.62	99
15+35+35+35	1.31	3.06	3.06	3.06		10.50 (3.4 - 13.3)	2.320 (0.630 - 3.900)	10.19	99
15+35+35+42	1.26	2.95	2.95	3.54		10.70 (3.4 - 13.3)	2.360 (0.630 - 3.860)	10.36	99
15+35+35+50	1.21	2.83	2.83	4.04		10.90 (3.4 - 13.3)	2.420 (0.630 - 3.870)	10.63	99
15+35+35+60	1.14	2.66	2.66	4.55		11.00 (3.4 - 13.3)	2.380 (0.630 - 3.870)	10.45	99
15+35+35+71	1.06	2.47	2.47	5.01		11.00 (3.4 - 13.3)	2.260 (0.630 - 3.860)	9.93	99
15+35+42+42	1.22	2.85	3.42	3.42		10.90 (3.4 - 13.3)	2.410 (0.630 - 3.820)	10.58	99
15+35+42+50	1.16	2.71	3.25	3.87		11.00 (3.4 - 13.3)	2.410 (0.630 - 3.830)	10.58	99
15+35+42+60	1.09	2.53	3.04	4.34		11.00 (3.4 - 13.3)	2.300 (0.630 - 3.820)	10.10	99
15+35+42+71	1.01	2.36	2.83	4.79		11.00 (3.4 - 13.3)	2.180 (0.630 - 3.810)	9.57	99
15+35+50+50	1.10	2.57	3.67	3.67		11.00 (3.4 - 13.3)	2.330 (0.630 - 3.830)	10.23	99
15+35+50+60	1.03	2.41	3.44	4.13		11.00 (3.4 - 13.3)	2.220 (0.630 - 3.830)	9.75	99
15+35+50+71	0.96	2.25	3.22	4.57		11.00 (3.5 - 13.3)	2.130 (0.620 - 3.820)	9.35	99
15+42+42+42	1.17	3.28	3.28	3.28		11.00 (3.4 - 13.3)	2.410 (0.630 - 3.780)	10.58	99

MXZ-5C100VA(VA2) HEATING

Indoor units combination	Heating capacity (kW)					Total	Outdoor unit power consumption (kW)	Current (A)	Power factor (%)
	Unit A	Unit B	Unit C	Unit D	Unit E				
15+42+42+50	1.11	3.10	3.10	3.69		11.00 (3.4 - 13.3)	2.330 (0.630 - 3.780)	10.23	99
15+42+42+60	1.04	2.91	2.91	4.15		11.00 (3.4 - 13.3)	2.220 (0.630 - 3.780)	9.75	99
15+42+42+71	0.97	2.72	2.72	4.59		11.00 (3.5 - 13.3)	2.120 (0.620 - 3.770)	9.31	99
15+42+50+50	1.05	2.94	3.50	3.50		11.00 (3.4 - 13.3)	2.250 (0.630 - 3.790)	9.88	99
15+42+50+60	0.99	2.77	3.29	3.95		11.00 (3.4 - 13.3)	2.140 (0.630 - 3.780)	9.40	99
20+20+20+20	2.20	2.20	2.20	2.20		8.80 (3.4 - 12.4)	2.110 (0.750 - 4.100)	9.27	99
20+20+20+22	2.22	2.22	2.22	2.44		9.10 (3.4 - 12.6)	2.130 (0.710 - 4.060)	9.35	99
20+20+20+25	2.26	2.26	2.26	2.82		9.60 (3.4 - 13.0)	2.160 (0.710 - 3.970)	9.49	99
20+20+20+35	2.11	2.11	2.11	3.68		10.00 (3.4 - 13.3)	2.170 (0.710 - 3.900)	9.53	99
20+20+20+42	1.98	1.98	1.98	4.16		10.10 (3.4 - 13.3)	2.170 (0.710 - 3.860)	9.53	99
20+20+20+50	1.87	1.87	1.87	4.68		10.30 (3.4 - 13.3)	2.230 (0.710 - 3.870)	9.79	99
20+20+20+60	1.75	1.75	1.75	5.25		10.50 (3.4 - 13.3)	2.260 (0.710 - 3.870)	9.93	99
20+20+20+71	1.65	1.65	1.65	5.85		10.80 (3.4 - 13.3)	2.340 (0.710 - 3.870)	10.28	99
20+20+22+22	2.24	2.24	2.46	2.46		9.40 (3.4 - 12.9)	2.150 (0.670 - 3.990)	9.44	99
20+20+22+25	2.28	2.28	2.50	2.84		9.90 (3.4 - 13.2)	2.170 (0.670 - 3.920)	9.53	99
20+20+22+35	2.06	2.06	2.27	3.61		10.00 (3.4 - 13.3)	2.170 (0.670 - 3.900)	9.53	99
20+20+22+42	1.94	1.94	2.14	4.08		10.10 (3.4 - 13.3)	2.170 (0.670 - 3.860)	9.53	99
20+20+22+50	1.84	1.84	2.02	4.60		10.30 (3.4 - 13.3)	2.230 (0.670 - 3.870)	9.79	99
20+20+22+60	1.74	1.74	1.91	5.21		10.60 (3.4 - 13.3)	2.290 (0.670 - 3.870)	10.06	99
20+20+22+71	1.62	1.62	1.79	5.77		10.80 (3.4 - 13.3)	2.340 (0.670 - 3.870)	10.28	99
20+20+25+25	2.22	2.22	2.78	2.78		10.00 (3.4 - 13.3)	2.180 (0.670 - 3.900)	9.57	99
20+20+25+35	2.00	2.00	2.50	3.50		10.00 (3.4 - 13.3)	2.160 (0.670 - 3.900)	9.49	99
20+20+25+42	1.91	1.91	2.38	4.00		10.20 (3.4 - 13.3)	2.200 (0.670 - 3.860)	9.66	99
20+20+25+50	1.81	1.81	2.26	4.52		10.40 (3.4 - 13.3)	2.260 (0.670 - 3.870)	9.93	99
20+20+25+60	1.70	1.70	2.12	5.09		10.60 (3.4 - 13.3)	2.290 (0.670 - 3.870)	10.06	99
20+20+25+71	1.60	1.60	2.00	5.69		10.90 (3.4 - 13.3)	2.370 (0.670 - 3.870)	10.41	99
20+20+35+35	1.87	1.87	3.28	3.28		10.30 (3.4 - 13.3)	2.260 (0.670 - 3.900)	9.93	99
20+20+35+42	1.78	1.78	3.11	3.73		10.40 (3.4 - 13.3)	2.270 (0.670 - 3.860)	9.97	99
20+20+35+50	1.70	1.70	2.97	4.24		10.60 (3.4 - 13.3)	2.320 (0.670 - 3.870)	10.19	99
20+20+35+60	1.61	1.61	2.83	4.84		10.90 (3.4 - 13.3)	2.390 (0.670 - 3.870)	10.50	99
20+20+35+71	1.51	1.51	2.64	5.35		11.00 (3.4 - 13.3)	2.350 (0.670 - 3.870)	10.32	99
20+20+42+42	1.71	1.71	3.59	3.59		10.60 (3.4 - 13.3)	2.310 (0.670 - 3.820)	10.14	99
20+20+42+50	1.64	1.64	3.44	4.09		10.80 (3.4 - 13.3)	2.370 (0.670 - 3.830)	10.41	99
20+20+42+60	1.55	1.55	3.25	4.65		11.00 (3.4 - 13.3)	2.380 (0.670 - 3.830)	10.45	99
20+20+42+71	1.44	1.44	3.02	5.10		11.00 (3.4 - 13.3)	2.270 (0.670 - 3.820)	9.97	99
20+20+50+50	1.57	1.57	3.93	3.93		11.00 (3.4 - 13.3)	2.420 (0.670 - 3.840)	10.63	99
20+20+50+60	1.47	1.47	3.67	4.40		11.00 (3.4 - 13.3)	2.300 (0.670 - 3.830)	10.10	99
20+20+50+71	1.37	1.37	3.42	4.85		11.00 (3.4 - 13.3)	2.190 (0.670 - 3.830)	9.62	99
20+22+22+22	2.26	2.48	2.48	2.48		9.70 (3.4 - 13.1)	2.160 (0.630 - 3.940)	9.49	99
20+22+22+25	2.25	2.47	2.47	2.81		10.00 (3.4 - 13.3)	2.180 (0.630 - 3.900)	9.57	99
20+22+22+35	2.02	2.22	2.22	3.54		10.00 (3.4 - 13.3)	2.160 (0.630 - 3.900)	9.49	99
20+22+22+42	1.92	2.12	2.12	4.04		10.20 (3.4 - 13.3)	2.200 (0.630 - 3.860)	9.66	99

MXZ-5C100VA(VA2) HEATING

Indoor units combination	Heating capacity (kW)					Total	Outdoor unit power consumption (kW)	Current (A)	Power factor (%)
	Unit A	Unit B	Unit C	Unit D	Unit E				
20+22+22+50	1.82	2.01	2.01	4.56		10.40 (3.4 - 13.3)	2.260 (0.630 - 3.870)	9.93	99
20+22+22+60	1.71	1.88	1.88	5.13		10.60 (3.4 - 13.3)	2.290 (0.630 - 3.870)	10.06	99
20+22+22+71	1.61	1.78	1.78	5.73		10.90 (3.4 - 13.3)	2.370 (0.630 - 3.870)	10.41	99
20+22+25+25	2.17	2.39	2.72	2.72		10.00 (3.4 - 13.3)	2.170 (0.630 - 3.900)	9.53	99
20+22+25+35	1.98	2.18	2.48	3.47		10.10 (3.4 - 13.3)	2.190 (0.630 - 3.900)	9.62	99
20+22+25+42	1.87	2.06	2.34	3.93		10.20 (3.4 - 13.3)	2.200 (0.630 - 3.860)	9.66	99
20+22+25+50	1.78	1.96	2.22	4.44		10.40 (3.4 - 13.3)	2.260 (0.630 - 3.870)	9.93	99
20+22+25+60	1.69	1.85	2.11	5.06		10.70 (3.4 - 13.3)	2.320 (0.630 - 3.870)	10.19	99
20+22+25+71	1.59	1.75	1.99	5.66		11.00 (3.4 - 13.3)	2.400 (0.630 - 3.870)	10.54	99
20+22+35+35	1.84	2.02	3.22	3.22		10.30 (3.4 - 13.3)	2.260 (0.630 - 3.900)	9.93	99
20+22+35+42	1.76	1.94	3.09	3.71		10.50 (3.4 - 13.3)	2.300 (0.630 - 3.860)	10.10	99
20+22+35+50	1.69	1.85	2.95	4.21		10.70 (3.4 - 13.3)	2.350 (0.630 - 3.870)	10.32	99
20+22+35+60	1.59	1.75	2.78	4.77		10.90 (3.4 - 13.3)	2.390 (0.630 - 3.870)	10.50	99
20+22+35+71	1.49	1.64	2.60	5.28		11.00 (3.4 - 13.3)	2.330 (0.630 - 3.860)	10.23	99
20+22+42+42	1.70	1.87	3.57	3.57		10.70 (3.4 - 13.3)	2.340 (0.630 - 3.820)	10.28	99
20+22+42+50	1.63	1.79	3.42	4.07		10.90 (3.4 - 13.3)	2.400 (0.630 - 3.830)	10.54	99
20+22+42+60	1.53	1.68	3.21	4.58		11.00 (3.4 - 13.3)	2.370 (0.630 - 3.830)	10.41	99
20+22+42+71	1.42	1.56	2.98	5.04		11.00 (3.4 - 13.3)	2.250 (0.630 - 3.820)	9.88	99
20+22+50+50	1.55	1.70	3.87	3.87		11.00 (3.4 - 13.3)	2.400 (0.630 - 3.840)	10.54	99
20+22+50+60	1.45	1.59	3.62	4.34		11.00 (3.4 - 13.3)	2.290 (0.630 - 3.830)	10.06	99
20+22+50+71	1.35	1.48	3.37	4.79		11.00 (3.4 - 13.3)	2.170 (0.630 - 3.820)	9.53	99
20+25+25+25	2.11	2.63	2.63	2.63		10.00 (3.4 - 13.3)	2.170 (0.630 - 3.900)	9.53	99
20+25+25+35	1.92	2.40	2.40	3.37		10.10 (3.4 - 13.3)	2.190 (0.630 - 3.900)	9.62	99
20+25+25+42	1.84	2.30	2.30	3.86		10.30 (3.4 - 13.3)	2.240 (0.630 - 3.860)	9.84	99
20+25+25+50	1.75	2.19	2.19	4.38		10.50 (3.4 - 13.3)	2.290 (0.630 - 3.870)	10.06	99
20+25+25+60	1.66	2.08	2.08	4.98		10.80 (3.4 - 13.3)	2.360 (0.630 - 3.870)	10.36	99
20+25+25+71	1.56	1.95	1.95	5.54		11.00 (3.4 - 13.3)	2.390 (0.630 - 3.870)	10.50	99
20+25+35+35	1.81	2.26	3.17	3.17		10.40 (3.4 - 13.3)	2.290 (0.630 - 3.900)	10.06	99
20+25+35+42	1.74	2.17	3.04	3.65		10.60 (3.4 - 13.3)	2.330 (0.630 - 3.860)	10.23	99
20+25+35+50	1.66	2.08	2.91	4.15		10.80 (3.4 - 13.3)	2.390 (0.630 - 3.870)	10.50	99
20+25+35+60	1.57	1.96	2.75	4.71		11.00 (3.4 - 13.3)	2.420 (0.630 - 3.870)	10.63	99
20+25+35+71	1.46	1.82	2.55	5.17		11.00 (3.4 - 13.3)	2.310 (0.630 - 3.860)	10.14	99
20+25+42+42	1.66	2.07	3.48	3.48		10.70 (3.4 - 13.3)	2.340 (0.630 - 3.820)	10.28	99
20+25+42+50	1.59	1.99	3.34	3.98		10.90 (3.4 - 13.3)	2.400 (0.630 - 3.830)	10.54	99
20+25+42+60	1.50	1.87	3.14	4.49		11.00 (3.4 - 13.3)	2.340 (0.630 - 3.830)	10.28	99
20+25+42+71	1.39	1.74	2.92	4.94		11.00 (3.4 - 13.3)	2.230 (0.630 - 3.820)	9.79	99
20+25+50+50	1.52	1.90	3.79	3.79		11.00 (3.4 - 13.3)	2.380 (0.630 - 3.840)	10.45	99
20+25+50+60	1.42	1.77	3.55	4.26		11.00 (3.4 - 13.3)	2.260 (0.630 - 3.830)	9.93	99
20+25+50+71	1.33	1.66	3.31	4.70		11.00 (3.4 - 13.3)	2.150 (0.630 - 3.820)	9.44	99
20+35+35+35	1.70	2.97	2.97	2.97		10.60 (3.4 - 13.3)	2.350 (0.630 - 3.900)	10.32	99
20+35+35+42	1.64	2.86	2.86	3.44		10.80 (3.4 - 13.3)	2.400 (0.630 - 3.860)	10.54	99
20+35+35+50	1.57	2.75	2.75	3.93		11.00 (3.4 - 13.3)	2.450 (0.630 - 3.870)	10.76	99

MXZ-5C100VA(VA2) HEATING

Indoor units combination	Heating capacity (kW)					Total	Outdoor unit power consumption (kW)	Current (A)	Power factor (%)
	Unit A	Unit B	Unit C	Unit D	Unit E				
20+35+35+60	1.47	2.57	2.57	4.40		11.00 (3.4 - 13.3)	2.330 (0.630 - 3.860)	10.23	99
20+35+35+71	1.37	2.39	2.39	4.85		11.00 (3.4 - 13.3)	2.220 (0.630 - 3.860)	9.75	99
20+35+42+42	1.58	2.77	3.32	3.32		11.00 (3.4 - 13.3)	2.440 (0.630 - 3.820)	10.72	99
20+35+42+50	1.50	2.62	3.14	3.74		11.00 (3.4 - 13.3)	2.370 (0.630 - 3.830)	10.41	99
20+35+42+60	1.40	2.45	2.94	4.20		11.00 (3.4 - 13.3)	2.250 (0.630 - 3.820)	9.88	99
20+35+42+71	1.31	2.29	2.75	4.65		11.00 (3.5 - 13.3)	2.140 (0.620 - 3.810)	9.40	99
20+35+50+50	1.42	2.48	3.55	3.55		11.00 (3.4 - 13.3)	2.290 (0.630 - 3.830)	10.06	99
20+35+50+60	1.33	2.33	3.33	4.00		11.00 (3.4 - 13.3)	2.180 (0.630 - 3.820)	9.57	99
20+42+42+42	1.51	3.16	3.16	3.16		11.00 (3.4 - 13.3)	2.370 (0.630 - 3.780)	10.41	99
20+42+42+50	1.43	3.00	3.00	3.57		11.00 (3.4 - 13.3)	2.290 (0.630 - 3.780)	10.06	99
20+42+42+60	1.34	2.82	2.82	4.02		11.00 (3.4 - 13.3)	2.170 (0.630 - 3.770)	9.53	99
20+42+50+50	1.36	2.85	3.40	3.40		11.00 (3.4 - 13.3)	2.210 (0.630 - 3.780)	9.71	99
20+42+50+60	1.28	2.69	3.20	3.84		11.00 (3.5 - 13.3)	2.130 (0.620 - 3.780)	9.35	99
22+22+22+22	2.50	2.50	2.50	2.50		10.00 (3.4 - 13.3)	2.180 (0.590 - 3.900)	9.57	99
22+22+22+25	2.42	2.42	2.42	2.75		10.00 (3.4 - 13.3)	2.180 (0.590 - 3.900)	9.57	99
22+22+22+35	2.18	2.18	2.18	3.47		10.00 (3.4 - 13.3)	2.160 (0.590 - 3.900)	9.49	99
22+22+22+42	2.08	2.08	2.08	3.97		10.20 (3.4 - 13.3)	2.200 (0.590 - 3.860)	9.66	99
22+22+22+50	1.97	1.97	1.97	4.48		10.40 (3.4 - 13.3)	2.260 (0.590 - 3.870)	9.93	99
22+22+22+60	1.87	1.87	1.87	5.10		10.70 (3.4 - 13.3)	2.320 (0.590 - 3.870)	10.19	99
22+22+22+71	1.75	1.75	1.75	5.65		10.90 (3.4 - 13.3)	2.370 (0.590 - 3.870)	10.41	99
22+22+25+25	2.34	2.34	2.66	2.66		10.00 (3.4 - 13.3)	2.170 (0.590 - 3.900)	9.53	99
22+22+25+35	2.14	2.14	2.43	3.40		10.10 (3.4 - 13.3)	2.190 (0.590 - 3.900)	9.62	99
22+22+25+42	2.04	2.04	2.32	3.90		10.30 (3.4 - 13.3)	2.240 (0.590 - 3.860)	9.84	99
22+22+25+50	1.94	1.94	2.21	4.41		10.50 (3.4 - 13.3)	2.290 (0.590 - 3.870)	10.06	99
22+22+25+60	1.82	1.82	2.07	4.98		10.70 (3.4 - 13.3)	2.320 (0.590 - 3.870)	10.19	99
22+22+25+71	1.73	1.73	1.96	5.58		11.00 (3.4 - 13.3)	2.400 (0.590 - 3.870)	10.54	99
22+22+35+35	2.01	2.01	3.19	3.19		10.40 (3.4 - 13.3)	2.290 (0.590 - 3.900)	10.06	99
22+22+35+42	1.91	1.91	3.04	3.64		10.50 (3.4 - 13.3)	2.300 (0.590 - 3.860)	10.10	99
22+22+35+50	1.82	1.82	2.90	4.15		10.70 (3.4 - 13.3)	2.350 (0.590 - 3.870)	10.32	99
22+22+35+60	1.74	1.74	2.77	4.75		11.00 (3.4 - 13.3)	2.420 (0.590 - 3.870)	10.63	99
22+22+35+71	1.61	1.61	2.57	5.21		11.00 (3.4 - 13.3)	2.310 (0.590 - 3.860)	10.14	99
22+22+42+42	1.84	1.84	3.51	3.51		10.70 (3.4 - 13.3)	2.340 (0.590 - 3.820)	10.28	99
22+22+42+50	1.76	1.76	3.37	4.01		10.90 (3.4 - 13.3)	2.400 (0.590 - 3.830)	10.54	99
22+22+42+60	1.66	1.66	3.16	4.52		11.00 (3.4 - 13.3)	2.350 (0.590 - 3.830)	10.32	99
22+22+42+71	1.54	1.54	2.94	4.97		11.00 (3.4 - 13.3)	2.230 (0.590 - 3.820)	9.79	99
22+22+50+50	1.68	1.68	3.82	3.82		11.00 (3.4 - 13.3)	2.390 (0.590 - 3.840)	10.50	99
22+22+50+60	1.57	1.57	3.57	4.29		11.00 (3.4 - 13.3)	2.270 (0.590 - 3.830)	9.97	99
22+22+50+71	1.47	1.47	3.33	4.73		11.00 (3.4 - 13.3)	2.160 (0.590 - 3.820)	9.49	99
22+25+25+25	2.27	2.58	2.58	2.58		10.00 (3.4 - 13.3)	2.170 (0.590 - 3.900)	9.53	99
22+25+25+35	2.10	2.38	2.38	3.34		10.20 (3.4 - 13.3)	2.220 (0.590 - 3.900)	9.75	99
22+25+25+42	2.01	2.28	2.28	3.83		10.40 (3.4 - 13.3)	2.270 (0.590 - 3.860)	9.97	99
22+25+25+50	1.91	2.17	2.17	4.34		10.60 (3.4 - 13.3)	2.320 (0.590 - 3.870)	10.19	99

MXZ-5C100VA(VA2) HEATING

Indoor units combination	Heating capacity (kW)					Outdoor unit power consumption (kW)	Current (A)	Power factor (%)	
	Unit A	Unit B	Unit C	Unit D	Unit E				Total
22+25+25+60	1.80	2.05	2.05	4.91		10.80 (3.4 - 13.3)	2.360 (0.590 - 3.870)	10.36	99
22+25+25+71	1.69	1.92	1.92	5.46		11.00 (3.4 - 13.3)	2.370 (0.590 - 3.870)	10.41	99
22+25+35+35	1.96	2.22	3.11	3.11		10.40 (3.4 - 13.3)	2.290 (0.590 - 3.900)	10.06	99
22+25+35+42	1.88	2.14	2.99	3.59		10.60 (3.4 - 13.3)	2.330 (0.590 - 3.860)	10.23	99
22+25+35+50	1.80	2.05	2.86	4.09		10.80 (3.4 - 13.3)	2.390 (0.590 - 3.870)	10.50	99
22+25+35+60	1.70	1.94	2.71	4.65		11.00 (3.4 - 13.3)	2.400 (0.590 - 3.870)	10.54	99
22+25+35+71	1.58	1.80	2.52	5.10		11.00 (3.4 - 13.3)	2.290 (0.590 - 3.860)	10.06	99
22+25+42+42	1.81	2.06	3.46	3.46		10.80 (3.4 - 13.3)	2.380 (0.590 - 3.820)	10.45	99
22+25+42+50	1.74	1.98	3.32	3.96		11.00 (3.4 - 13.3)	2.430 (0.590 - 3.830)	10.67	99
22+25+42+60	1.62	1.85	3.10	4.43		11.00 (3.4 - 13.3)	2.320 (0.590 - 3.820)	10.19	99
22+25+42+71	1.51	1.72	2.89	4.88		11.00 (3.4 - 13.3)	2.210 (0.590 - 3.820)	9.71	99
22+25+50+50	1.65	1.87	3.74	3.74		11.00 (3.4 - 13.3)	2.360 (0.590 - 3.840)	10.36	99
22+25+50+60	1.54	1.75	3.50	4.20		11.00 (3.4 - 13.3)	2.240 (0.590 - 3.830)	9.84	99
22+25+50+71	1.44	1.64	3.27	4.65		11.00 (3.5 - 13.3)	2.130 (0.580 - 3.820)	9.35	99
22+35+35+35	1.85	2.95	2.95	2.95		10.70 (3.4 - 13.3)	2.380 (0.590 - 3.900)	10.45	99
22+35+35+42	1.79	2.85	2.85	3.42		10.90 (3.4 - 13.3)	2.430 (0.590 - 3.860)	10.67	99
22+35+35+50	1.70	2.71	2.71	3.87		11.00 (3.4 - 13.3)	2.430 (0.590 - 3.870)	10.67	99
22+35+35+60	1.59	2.53	2.53	4.34		11.00 (3.4 - 13.3)	2.320 (0.590 - 3.860)	10.19	99
22+35+35+71	1.48	2.36	2.36	4.79		11.00 (3.4 - 13.3)	2.200 (0.590 - 3.850)	9.66	99
22+35+42+42	1.72	2.73	3.28	3.28		11.00 (3.4 - 13.3)	2.430 (0.590 - 3.820)	10.67	99
22+35+42+50	1.62	2.58	3.10	3.69		11.00 (3.4 - 13.3)	2.350 (0.590 - 3.820)	10.32	99
22+35+42+60	1.52	2.42	2.91	4.15		11.00 (3.4 - 13.3)	2.240 (0.590 - 3.820)	9.84	99
22+35+42+71	1.42	2.26	2.72	4.59		11.00 (3.5 - 13.3)	2.140 (0.580 - 3.810)	9.40	99
22+35+50+50	1.54	2.45	3.50	3.50		11.00 (3.4 - 13.3)	2.270 (0.590 - 3.830)	9.97	99
22+35+50+60	1.45	2.31	3.29	3.95		11.00 (3.4 - 13.3)	2.160 (0.590 - 3.820)	9.49	99
22+42+42+42	1.64	3.12	3.12	3.12		11.00 (3.4 - 13.3)	2.350 (0.590 - 3.770)	10.32	99
22+42+42+50	1.55	2.96	2.96	3.53		11.00 (3.4 - 13.3)	2.270 (0.590 - 3.780)	9.97	99
22+42+42+60	1.46	2.78	2.78	3.98		11.00 (3.4 - 13.3)	2.160 (0.590 - 3.770)	9.49	99
22+42+50+50	1.48	2.82	3.35	3.35		11.00 (3.4 - 13.3)	2.190 (0.590 - 3.780)	9.62	99
25+25+25+25	2.50	2.50	2.50	2.50		10.00 (3.4 - 13.3)	2.160 (0.590 - 3.900)	9.49	99
25+25+25+35	2.34	2.34	2.34	3.28		10.30 (3.4 - 13.3)	2.260 (0.590 - 3.900)	9.93	99
25+25+25+42	2.22	2.22	2.22	3.73		10.40 (3.4 - 13.3)	2.270 (0.590 - 3.860)	9.97	99
25+25+25+50	2.12	2.12	2.12	4.24		10.60 (3.4 - 13.3)	2.320 (0.590 - 3.870)	10.19	99
25+25+25+60	2.02	2.02	2.02	4.84		10.90 (3.4 - 13.3)	2.390 (0.590 - 3.870)	10.50	99
25+25+25+71	1.88	1.88	1.88	5.35		11.00 (3.4 - 13.3)	2.350 (0.590 - 3.870)	10.32	99
25+25+35+35	2.19	2.19	3.06	3.06		10.50 (3.4 - 13.3)	2.320 (0.590 - 3.900)	10.19	99
25+25+35+42	2.11	2.11	2.95	3.54		10.70 (3.4 - 13.3)	2.360 (0.590 - 3.860)	10.36	99
25+25+35+50	2.02	2.02	2.83	4.04		10.90 (3.4 - 13.3)	2.420 (0.590 - 3.870)	10.63	99
25+25+35+60	1.90	1.90	2.66	4.55		11.00 (3.4 - 13.3)	2.380 (0.590 - 3.870)	10.45	99
25+25+35+71	1.76	1.76	2.47	5.01		11.00 (3.4 - 13.3)	2.260 (0.590 - 3.860)	9.93	99
25+25+42+42	2.03	2.03	3.42	3.42		10.90 (3.4 - 13.3)	2.410 (0.590 - 3.820)	10.58	99
25+25+42+50	1.94	1.94	3.25	3.87		11.00 (3.4 - 13.3)	2.410 (0.590 - 3.830)	10.58	99

MXZ-5C100VA(VA2) HEATING

Indoor units combination	Heating capacity (kW)					Total	Outdoor unit power consumption (kW)	Current (A)	Power factor (%)
	Unit A	Unit B	Unit C	Unit D	Unit E				
25+25+42+60	1.81	1.81	3.04	4.34		11.00 (3.4 - 13.3)	2.300 (0.590 - 3.820)	10.10	99
25+25+42+71	1.69	1.69	2.83	4.79		11.00 (3.4 - 13.3)	2.180 (0.590 - 3.810)	9.57	99
25+25+50+50	1.83	1.83	3.67	3.67		11.00 (3.4 - 13.3)	2.330 (0.590 - 3.830)	10.23	99
25+25+50+60	1.72	1.72	3.44	4.13		11.00 (3.4 - 13.3)	2.220 (0.590 - 3.830)	9.75	99
25+25+50+71	1.61	1.61	3.22	4.57		11.00 (3.5 - 13.3)	2.130 (0.580 - 3.820)	9.35	99
25+35+35+35	2.08	2.91	2.91	2.91		10.80 (3.4 - 13.3)	2.420 (0.590 - 3.900)	10.63	99
25+35+35+42	1.99	2.78	2.78	3.34		10.90 (3.4 - 13.3)	2.430 (0.590 - 3.860)	10.67	99
25+35+35+50	1.90	2.66	2.66	3.79		11.00 (3.4 - 13.3)	2.410 (0.590 - 3.870)	10.58	99
25+35+35+60	1.77	2.48	2.48	4.26		11.00 (3.4 - 13.3)	2.290 (0.590 - 3.860)	10.06	99
25+35+35+71	1.66	2.32	2.32	4.70		11.00 (3.4 - 13.3)	2.180 (0.590 - 3.850)	9.57	99
25+35+42+42	1.91	2.67	3.21	3.21		11.00 (3.4 - 13.3)	2.410 (0.590 - 3.820)	10.58	99
25+35+42+50	1.81	2.53	3.04	3.62		11.00 (3.4 - 13.3)	2.330 (0.590 - 3.820)	10.23	99
25+35+42+60	1.70	2.38	2.85	4.07		11.00 (3.4 - 13.3)	2.210 (0.590 - 3.810)	9.71	99
25+42+42+42	1.82	3.06	3.06	3.06		11.00 (3.4 - 13.3)	2.330 (0.590 - 3.770)	10.23	99
25+42+42+50	1.73	2.91	2.91	3.46		11.00 (3.4 - 13.3)	2.250 (0.590 - 3.780)	9.88	99
25+42+42+60	1.63	2.73	2.73	3.91		11.00 (3.5 - 13.3)	2.140 (0.580 - 3.770)	9.40	99
25+42+50+50	1.65	2.77	3.29	3.29		11.00 (3.4 - 13.3)	2.170 (0.590 - 3.780)	9.53	99
35+35+35+35	2.75	2.75	2.75	2.75		11.00 (3.4 - 13.3)	2.480 (0.590 - 3.900)	10.89	99
35+35+35+42	2.62	2.62	2.62	3.14		11.00 (3.4 - 13.3)	2.400 (0.590 - 3.860)	10.54	99
35+35+35+50	2.48	2.48	2.48	3.55		11.00 (3.4 - 13.3)	2.320 (0.590 - 3.860)	10.19	99
35+35+35+60	2.33	2.33	2.33	4.00		11.00 (3.4 - 13.3)	2.210 (0.590 - 3.850)	9.71	99
35+35+42+42	2.50	2.50	3.00	3.00		11.00 (3.4 - 13.3)	2.320 (0.590 - 3.810)	10.19	99
35+35+42+50	2.38	2.38	2.85	3.40		11.00 (3.4 - 13.3)	2.240 (0.590 - 3.810)	9.84	99
35+42+42+42	2.39	2.87	2.87	2.87		11.00 (3.4 - 13.3)	2.240 (0.590 - 3.770)	9.84	99
35+42+42+50	2.28	2.73	2.73	3.25		11.00 (3.5 - 13.3)	2.170 (0.580 - 3.770)	9.53	99
42+42+42+42	2.75	2.75	2.75	2.75		11.00 (3.5 - 13.3)	2.240 (0.580 - 3.880)	9.84	99
15+15+15+15+15	1.70	1.70	1.70	1.70	1.70	8.50 (4.1 - 11.5)	1.910 (0.880 - 4.100)	8.39	99
15+15+15+15+20	1.69	1.69	1.69	1.69	2.25	9.00 (4.1 - 11.8)	2.250 (0.860 - 4.100)	9.88	99
15+15+15+15+22	1.68	1.68	1.68	1.68	2.47	9.20 (4.1 - 11.9)	2.320 (0.860 - 4.100)	10.19	99
15+15+15+15+25	1.68	1.68	1.68	1.68	2.79	9.50 (4.1 - 12.1)	2.420 (0.860 - 4.100)	10.63	99
15+15+15+15+35	1.66	1.66	1.66	1.66	3.87	10.50 (4.1 - 12.7)	2.770 (0.860 - 4.100)	12.17	99
15+15+15+15+42	1.65	1.65	1.65	1.65	4.61	11.20 (4.1 - 13.2)	2.960 (0.860 - 4.100)	13.00	99
15+15+15+15+50	1.64	1.64	1.64	1.64	5.45	12.00 (4.1 - 14.0)	2.995 (0.860 - 4.100)	13.15	99
15+15+15+15+60	1.50	1.50	1.50	1.50	6.00	12.00 (4.1 - 14.0)	2.995 (0.860 - 4.100)	13.15	99
15+15+15+15+71	1.37	1.37	1.37	1.37	6.50	12.00 (4.1 - 14.0)	2.995 (0.860 - 4.100)	13.15	99
15+15+15+20+20	1.68	1.68	1.68	2.24	2.24	9.50 (4.1 - 12.1)	2.420 (0.860 - 4.100)	10.63	99
15+15+15+20+22	1.67	1.67	1.67	2.23	2.45	9.70 (4.1 - 12.2)	2.490 (0.860 - 4.100)	10.94	99
15+15+15+20+25	1.67	1.67	1.67	2.22	2.78	10.00 (4.1 - 12.4)	2.600 (0.860 - 4.100)	11.42	99
15+15+15+20+35	1.65	1.65	1.65	2.20	3.85	11.00 (4.1 - 13.0)	2.950 (0.960 - 4.100)	12.96	99
15+15+15+20+42	1.64	1.64	1.64	2.19	4.59	11.70 (4.1 - 13.7)	2.980 (0.860 - 4.100)	13.09	99
15+15+15+20+50	1.57	1.57	1.57	2.09	5.22	12.00 (4.1 - 14.0)	2.995 (0.860 - 4.100)	13.15	99
15+15+15+20+60	1.44	1.44	1.44	1.92	5.76	12.00 (4.1 - 14.0)	2.995 (0.860 - 4.100)	13.15	99

MXZ-5C100VA(VA2) HEATING

Indoor units combination	Heating capacity (kW)						Outdoor unit power consumption (kW)	Current (A)	Power factor (%)
	Unit A	Unit B	Unit C	Unit D	Unit E	Total			
15+15+15+20+71	1.32	1.32	1.32	1.76	6.26	12.00 (4.1 - 14.0)	2.995 (0.860 - 4.100)	13.15	99
15+15+15+22+22	1.67	1.67	1.67	2.45	2.45	9.90 (4.1 - 12.3)	2.520 (0.840 - 4.100)	11.07	99
15+15+15+22+25	1.66	1.66	1.66	2.44	2.77	10.20 (4.1 - 12.5)	2.630 (0.840 - 4.100)	11.55	99
15+15+15+22+35	1.65	1.65	1.65	2.42	3.84	11.20 (4.1 - 13.2)	2.920 (0.840 - 4.100)	12.82	99
15+15+15+22+42	1.64	1.64	1.64	2.40	4.59	11.90 (4.1 - 13.9)	2.950 (0.840 - 4.100)	12.96	99
15+15+15+22+50	1.54	1.54	1.54	2.26	5.13	12.00 (4.1 - 14.0)	2.955 (0.840 - 4.100)	12.98	99
15+15+15+22+60	1.42	1.42	1.42	2.08	5.67	12.00 (4.1 - 14.0)	2.955 (0.840 - 4.100)	12.98	99
15+15+15+22+71	1.30	1.30	1.30	1.91	6.17	12.00 (4.1 - 14.0)	2.955 (0.840 - 4.100)	12.98	99
15+15+15+25+25	1.66	1.66	1.66	2.76	2.76	10.50 (4.1 - 12.7)	2.730 (0.840 - 4.100)	11.99	99
15+15+15+25+35	1.64	1.64	1.64	2.74	3.83	11.50 (4.1 - 13.5)	2.930 (0.840 - 4.100)	12.87	99
15+15+15+25+42	1.61	1.61	1.61	2.68	4.50	12.00 (4.1 - 14.0)	2.955 (0.840 - 4.100)	12.98	99
15+15+15+25+50	1.50	1.50	1.50	2.50	5.00	12.00 (4.1 - 14.0)	2.955 (0.840 - 4.100)	12.98	99
15+15+15+25+60	1.38	1.38	1.38	2.31	5.54	12.00 (4.1 - 14.0)	2.955 (0.840 - 4.100)	12.98	99
15+15+15+25+71	1.28	1.28	1.28	2.13	6.04	12.00 (4.1 - 14.0)	2.955 (0.840 - 4.100)	12.98	99
15+15+15+35+35	1.57	1.57	1.57	3.65	3.65	12.00 (4.1 - 14.0)	2.955 (0.840 - 4.100)	12.98	99
15+15+15+35+42	1.48	1.48	1.48	3.44	4.13	12.00 (4.1 - 14.0)	2.955 (0.840 - 4.100)	12.98	99
15+15+15+35+50	1.38	1.38	1.38	3.23	4.62	12.00 (4.1 - 14.0)	2.955 (0.840 - 4.100)	12.98	99
15+15+15+35+60	1.29	1.29	1.29	3.00	5.14	12.00 (4.1 - 14.0)	2.955 (0.840 - 4.100)	12.98	99
15+15+15+35+71	1.19	1.19	1.19	2.78	5.64	12.00 (4.1 - 14.0)	2.955 (0.840 - 4.100)	12.98	99
15+15+15+42+42	1.40	1.40	1.40	3.91	3.91	12.00 (4.1 - 14.0)	2.935 (0.840 - 4.100)	12.89	99
15+15+15+42+50	1.31	1.31	1.31	3.68	4.38	12.00 (4.1 - 14.0)	2.935 (0.840 - 4.100)	12.89	99
15+15+15+42+60	1.22	1.22	1.22	3.43	4.90	12.00 (4.1 - 14.0)	2.935 (0.840 - 4.100)	12.89	99
15+15+15+42+71	1.14	1.14	1.14	3.19	5.39	12.00 (4.1 - 14.0)	2.935 (0.840 - 4.100)	12.89	99
15+15+20+20+20	1.67	1.67	2.22	2.22	2.22	10.00 (4.1 - 12.4)	2.600 (0.860 - 4.100)	11.42	99
15+15+20+20+22	1.66	1.66	2.22	2.22	2.44	10.20 (4.1 - 12.5)	2.670 (0.860 - 4.100)	11.73	99
15+15+20+20+25	1.66	1.66	2.21	2.21	2.76	10.50 (4.1 - 12.7)	2.770 (0.860 - 4.100)	12.17	99
15+15+20+20+35	1.64	1.64	2.19	2.19	3.83	11.50 (4.1 - 13.5)	2.970 (0.860 - 4.100)	13.04	99
15+15+20+20+42	1.61	1.61	2.14	2.14	4.50	12.00 (4.1 - 14.0)	2.995 (0.860 - 4.100)	13.15	99
15+15+20+20+50	1.50	1.50	2.00	2.00	5.00	12.00 (4.1 - 14.0)	2.995 (0.860 - 4.100)	13.15	99
15+15+20+20+60	1.38	1.38	1.85	1.85	5.54	12.00 (4.1 - 14.0)	2.995 (0.860 - 4.100)	13.15	99
15+15+20+20+71	1.28	1.28	1.70	1.70	6.04	12.00 (4.1 - 14.0)	2.995 (0.860 - 4.100)	13.15	99
15+15+20+22+22	1.66	1.66	2.21	2.43	2.43	10.40 (4.1 - 12.6)	2.700 (0.840 - 4.100)	11.86	99
15+15+20+22+25	1.65	1.65	2.21	2.43	2.76	10.70 (4.1 - 12.8)	2.800 (0.840 - 4.100)	12.30	99
15+15+20+22+35	1.64	1.64	2.19	2.41	3.83	11.70 (4.1 - 13.7)	2.940 (0.840 - 4.100)	12.91	99
15+15+20+22+42	1.58	1.58	2.11	2.32	4.42	12.00 (4.1 - 14.0)	2.955 (0.840 - 4.100)	12.98	99
15+15+20+22+50	1.48	1.48	1.97	2.16	4.92	12.00 (4.1 - 14.0)	2.955 (0.840 - 4.100)	12.98	99
15+15+20+22+60	1.36	1.36	1.82	2.00	5.45	12.00 (4.1 - 14.0)	2.955 (0.840 - 4.100)	12.98	99
15+15+20+22+71	1.26	1.26	1.68	1.85	5.96	12.00 (4.1 - 14.0)	2.955 (0.840 - 4.100)	12.98	99
15+15+20+25+25	1.65	1.65	2.20	2.75	2.75	11.00 (4.1 - 13.0)	2.910 (0.940 - 4.100)	12.78	99
15+15+20+25+35	1.64	1.64	2.18	2.73	3.82	12.00 (4.1 - 14.0)	2.955 (0.840 - 4.100)	12.98	99
15+15+20+25+42	1.54	1.54	2.05	2.56	4.31	12.00 (4.1 - 14.0)	2.955 (0.840 - 4.100)	12.98	99
15+15+20+25+50	1.44	1.44	1.92	2.40	4.80	12.00 (4.1 - 14.0)	2.955 (0.840 - 4.100)	12.98	99

MXZ-5C100VA(VA2) HEATING

Indoor units combination	Heating capacity (kW)						Outdoor unit power consumption (kW)	Current (A)	Power factor (%)
	Unit A	Unit B	Unit C	Unit D	Unit E	Total			
15+15+20+25+60	1.33	1.33	1.78	2.22	5.33	12.00 (4.1 - 14.0)	2.955 (0.840 - 4.100)	12.98	99
15+15+20+25+71	1.23	1.23	1.64	2.05	5.84	12.00 (4.1 - 14.0)	2.955 (0.840 - 4.100)	12.98	99
15+15+20+35+35	1.50	1.50	2.00	3.50	3.50	12.00 (4.1 - 14.0)	2.955 (0.840 - 4.100)	12.98	99
15+15+20+35+42	1.42	1.42	1.89	3.31	3.97	12.00 (4.1 - 14.0)	2.955 (0.840 - 4.100)	12.98	99
15+15+20+35+50	1.33	1.33	1.78	3.11	4.44	12.00 (4.1 - 14.0)	2.955 (0.840 - 4.100)	12.98	99
15+15+20+35+60	1.24	1.24	1.66	2.90	4.97	12.00 (4.1 - 14.0)	2.955 (0.840 - 4.100)	12.98	99
15+15+20+35+71	1.15	1.15	1.54	2.69	5.46	12.00 (4.1 - 14.0)	2.955 (0.840 - 4.100)	12.98	99
15+15+20+42+42	1.34	1.34	1.79	3.76	3.76	12.00 (4.1 - 14.0)	2.935 (0.840 - 4.100)	12.89	99
15+15+20+42+50	1.27	1.27	1.69	3.55	4.23	12.00 (4.1 - 14.0)	2.935 (0.840 - 4.100)	12.89	99
15+15+20+42+60	1.18	1.18	1.58	3.32	4.74	12.00 (4.1 - 14.0)	2.935 (0.840 - 4.100)	12.89	99
15+15+20+42+71	1.10	1.10	1.47	3.09	5.23	12.00 (4.1 - 14.0)	2.935 (0.840 - 4.100)	12.89	99
15+15+22+22+22	1.66	1.66	2.43	2.43	2.43	10.60 (4.1 - 12.8)	2.730 (0.820 - 4.100)	11.99	99
15+15+22+22+25	1.65	1.65	2.42	2.42	2.75	10.90 (4.1 - 12.9)	2.830 (0.820 - 4.100)	12.43	99
15+15+22+22+35	1.64	1.64	2.40	2.40	3.82	11.90 (4.1 - 13.9)	2.910 (0.820 - 4.100)	12.78	99
15+15+22+22+42	1.55	1.55	2.28	2.28	4.34	12.00 (4.1 - 14.0)	2.915 (0.820 - 4.100)	12.80	99
15+15+22+22+50	1.45	1.45	2.13	2.13	4.84	12.00 (4.1 - 14.0)	2.915 (0.820 - 4.100)	12.80	99
15+15+22+22+60	1.34	1.34	1.97	1.97	5.37	12.00 (4.1 - 14.0)	2.915 (0.820 - 4.100)	12.80	99
15+15+22+22+71	1.24	1.24	1.82	1.82	5.88	12.00 (4.1 - 14.0)	2.915 (0.820 - 4.100)	12.80	99
15+15+22+25+25	1.65	1.65	2.42	2.75	2.75	11.20 (4.1 - 13.2)	2.880 (0.820 - 4.100)	12.65	99
15+15+22+25+35	1.61	1.61	2.36	2.68	3.75	12.00 (4.1 - 14.0)	2.915 (0.820 - 4.100)	12.80	99
15+15+22+25+42	1.51	1.51	2.22	2.52	4.24	12.00 (4.1 - 14.0)	2.915 (0.820 - 4.100)	12.80	99
15+15+22+25+50	1.42	1.42	2.08	2.36	4.72	12.00 (4.1 - 14.0)	2.915 (0.820 - 4.100)	12.80	99
15+15+22+25+60	1.31	1.31	1.93	2.19	5.26	12.00 (4.1 - 14.0)	2.915 (0.820 - 4.100)	12.80	99
15+15+22+25+71	1.22	1.22	1.78	2.03	5.76	12.00 (4.1 - 14.0)	2.915 (0.820 - 4.100)	12.80	99
15+15+22+35+35	1.48	1.48	2.16	3.44	3.44	12.00 (4.1 - 14.0)	2.915 (0.820 - 4.100)	12.80	99
15+15+22+35+42	1.40	1.40	2.05	3.26	3.91	12.00 (4.1 - 14.0)	2.915 (0.820 - 4.100)	12.80	99
15+15+22+35+50	1.31	1.31	1.93	3.07	4.38	12.00 (4.1 - 14.0)	2.915 (0.820 - 4.100)	12.80	99
15+15+22+35+60	1.22	1.22	1.80	2.86	4.90	12.00 (4.1 - 14.0)	2.915 (0.820 - 4.100)	12.80	99
15+15+22+35+71	1.14	1.14	1.67	2.66	5.39	12.00 (4.1 - 14.0)	2.915 (0.820 - 4.100)	12.80	99
15+15+22+42+42	1.32	1.32	1.94	3.71	3.71	12.00 (4.1 - 14.0)	2.895 (0.820 - 4.100)	12.71	99
15+15+22+42+50	1.25	1.25	1.83	3.50	4.17	12.00 (4.1 - 14.0)	2.895 (0.820 - 4.100)	12.71	99
15+15+22+42+60	1.17	1.17	1.71	3.27	4.68	12.00 (4.1 - 14.0)	2.895 (0.820 - 4.100)	12.71	99
15+15+22+42+71	1.09	1.09	1.60	3.05	5.16	12.00 (4.1 - 14.0)	2.895 (0.820 - 4.100)	12.71	99
15+15+25+25+25	1.64	1.64	2.74	2.74	2.74	11.50 (4.1 - 13.5)	2.890 (0.820 - 4.100)	12.69	99
15+15+25+25+35	1.57	1.57	2.61	2.61	3.65	12.00 (4.1 - 14.0)	2.915 (0.820 - 4.100)	12.80	99
15+15+25+25+42	1.48	1.48	2.46	2.46	4.13	12.00 (4.1 - 14.0)	2.915 (0.820 - 4.100)	12.80	99
15+15+25+25+50	1.38	1.38	2.31	2.31	4.62	12.00 (4.1 - 14.0)	2.915 (0.820 - 4.100)	12.80	99
15+15+25+25+60	1.29	1.29	2.14	2.14	5.14	12.00 (4.1 - 14.0)	2.915 (0.820 - 4.100)	12.80	99
15+15+25+25+71	1.19	1.19	1.99	1.99	5.64	12.00 (4.1 - 14.0)	2.915 (0.820 - 4.100)	12.80	99
15+15+25+35+35	1.44	1.44	2.40	3.36	3.36	12.00 (4.1 - 14.0)	2.915 (0.820 - 4.100)	12.80	99
15+15+25+35+42	1.36	1.36	2.27	3.18	3.82	12.00 (4.1 - 14.0)	2.915 (0.820 - 4.100)	12.80	99
15+15+25+35+50	1.29	1.29	2.14	3.00	4.29	12.00 (4.1 - 14.0)	2.915 (0.820 - 4.100)	12.80	99

MXZ-5C100VA(VA2) HEATING

Indoor units combination	Heating capacity (kW)						Outdoor unit power consumption (kW)	Current (A)	Power factor (%)
	Unit A	Unit B	Unit C	Unit D	Unit E	Total			
15+15+25+35+60	1.20	1.20	2.00	2.80	4.80	12.00 (4.1 - 14.0)	2.915 (0.820 - 4.100)	12.80	99
15+15+25+35+71	1.12	1.12	1.86	2.61	5.29	12.00 (4.1 - 14.0)	2.915 (0.820 - 4.100)	12.80	99
15+15+25+42+42	1.29	1.29	2.16	3.63	3.63	12.00 (4.1 - 14.0)	2.895 (0.820 - 4.100)	12.71	99
15+15+25+42+50	1.22	1.22	2.04	3.43	4.08	12.00 (4.1 - 14.0)	2.895 (0.820 - 4.100)	12.71	99
15+15+25+42+60	1.15	1.15	1.91	3.21	4.59	12.00 (4.1 - 14.0)	2.895 (0.820 - 4.100)	12.71	99
15+15+25+42+71	1.07	1.07	1.79	3.00	5.07	12.00 (4.1 - 14.0)	2.895 (0.820 - 4.100)	12.71	99
15+15+35+35+35	1.33	1.33	3.11	3.11	3.11	12.00 (4.1 - 14.0)	2.915 (0.820 - 4.100)	12.80	99
15+15+35+35+42	1.27	1.27	2.96	2.96	3.55	12.00 (4.1 - 14.0)	2.915 (0.820 - 4.100)	12.80	99
15+15+35+35+50	1.20	1.20	2.80	2.80	4.00	12.00 (4.1 - 14.0)	2.915 (0.820 - 4.100)	12.80	99
15+15+35+35+60	1.13	1.13	2.63	2.63	4.50	12.00 (4.1 - 14.0)	2.915 (0.820 - 4.100)	12.80	99
15+15+35+35+71	1.05	1.05	2.46	2.46	4.98	12.00 (4.1 - 14.0)	2.915 (0.820 - 4.100)	12.80	99
15+15+35+42+42	1.21	1.21	2.82	3.38	3.38	12.00 (4.1 - 14.0)	2.895 (0.820 - 4.100)	12.71	99
15+15+35+42+50	1.15	1.15	2.68	3.21	3.82	12.00 (4.1 - 14.0)	2.895 (0.820 - 4.100)	12.71	99
15+15+35+42+60	1.08	1.08	2.51	3.02	4.31	12.00 (4.1 - 14.0)	2.895 (0.820 - 4.100)	12.71	99
15+15+42+42+42	1.15	1.15	3.23	3.23	3.23	12.00 (4.1 - 14.0)	2.875 (0.820 - 4.100)	12.63	99
15+15+42+42+50	1.10	1.10	3.07	3.07	3.66	12.00 (4.1 - 14.0)	2.875 (0.820 - 4.100)	12.63	99
15+20+20+20+20	1.66	2.21	2.21	2.21	2.21	10.50 (4.1 - 12.7)	2.770 (0.860 - 4.100)	12.17	99
15+20+20+20+22	1.65	2.21	2.21	2.21	2.43	10.70 (4.1 - 12.8)	2.840 (0.860 - 4.100)	12.47	99
15+20+20+20+25	1.65	2.20	2.20	2.20	2.75	11.00 (4.1 - 13.0)	2.950 (0.960 - 4.100)	12.96	99
15+20+20+20+35	1.64	2.18	2.18	2.18	3.82	12.00 (4.1 - 14.0)	2.995 (0.860 - 4.100)	13.15	99
15+20+20+20+42	1.54	2.05	2.05	2.05	4.31	12.00 (4.1 - 14.0)	2.995 (0.860 - 4.100)	13.15	99
15+20+20+20+50	1.44	1.92	1.92	1.92	4.80	12.00 (4.1 - 14.0)	2.995 (0.860 - 4.100)	13.15	99
15+20+20+20+60	1.33	1.78	1.78	1.78	5.33	12.00 (4.1 - 14.0)	2.995 (0.860 - 4.100)	13.15	99
15+20+20+20+71	1.23	1.64	1.64	1.64	5.84	12.00 (4.1 - 14.0)	2.995 (0.860 - 4.100)	13.15	99
15+20+20+22+22	1.65	2.20	2.20	2.42	2.42	10.90 (4.1 - 12.9)	2.870 (0.840 - 4.100)	12.60	99
15+20+20+22+25	1.65	2.20	2.20	2.42	2.75	11.20 (4.1 - 13.2)	2.920 (0.840 - 4.100)	12.82	99
15+20+20+22+35	1.61	2.14	2.14	2.36	3.75	12.00 (4.1 - 14.0)	2.955 (0.840 - 4.100)	12.98	99
15+20+20+22+42	1.51	2.02	2.02	2.22	4.24	12.00 (4.1 - 14.0)	2.955 (0.840 - 4.100)	12.98	99
15+20+20+22+50	1.42	1.89	1.89	2.08	4.72	12.00 (4.1 - 14.0)	2.955 (0.840 - 4.100)	12.98	99
15+20+20+22+60	1.31	1.75	1.75	1.93	5.26	12.00 (4.1 - 14.0)	2.955 (0.840 - 4.100)	12.98	99
15+20+20+22+71	1.22	1.62	1.62	1.78	5.76	12.00 (4.1 - 14.0)	2.955 (0.840 - 4.100)	12.98	99
15+20+20+25+25	1.64	2.19	2.19	2.74	2.74	11.50 (4.1 - 13.5)	2.930 (0.840 - 4.100)	12.87	99
15+20+20+25+35	1.57	2.09	2.09	2.61	3.65	12.00 (4.1 - 14.0)	2.955 (0.840 - 4.100)	12.98	99
15+20+20+25+42	1.48	1.97	1.97	2.46	4.13	12.00 (4.1 - 14.0)	2.955 (0.840 - 4.100)	12.98	99
15+20+20+25+50	1.38	1.85	1.85	2.31	4.62	12.00 (4.1 - 14.0)	2.955 (0.840 - 4.100)	12.98	99
15+20+20+25+60	1.29	1.71	1.71	2.14	5.14	12.00 (4.1 - 14.0)	2.955 (0.840 - 4.100)	12.98	99
15+20+20+25+71	1.19	1.59	1.59	1.99	5.64	12.00 (4.1 - 14.0)	2.955 (0.840 - 4.100)	12.98	99
15+20+20+35+35	1.44	1.92	1.92	3.36	3.36	12.00 (4.1 - 14.0)	2.955 (0.840 - 4.100)	12.98	99
15+20+20+35+42	1.36	1.82	1.82	3.18	3.82	12.00 (4.1 - 14.0)	2.955 (0.840 - 4.100)	12.98	99
15+20+20+35+50	1.29	1.71	1.71	3.00	4.29	12.00 (4.1 - 14.0)	2.955 (0.840 - 4.100)	12.98	99
15+20+20+35+60	1.20	1.60	1.60	2.80	4.80	12.00 (4.1 - 14.0)	2.955 (0.840 - 4.100)	12.98	99
15+20+20+35+71	1.12	1.49	1.49	2.61	5.29	12.00 (4.1 - 14.0)	2.955 (0.840 - 4.100)	12.98	99

MXZ-5C100VA(VA2) HEATING

Indoor units combination	Heating capacity (kW)						Outdoor unit power consumption (kW)	Current (A)	Power factor (%)
	Unit A	Unit B	Unit C	Unit D	Unit E	Total			
15+20+20+42+42	1.29	1.73	1.73	3.63	3.63	12.00 (4.1 - 14.0)	2.935 (0.840 - 4.100)	12.89	99
15+20+20+42+50	1.22	1.63	1.63	3.43	4.08	12.00 (4.1 - 14.0)	2.935 (0.840 - 4.100)	12.89	99
15+20+20+42+60	1.15	1.53	1.53	3.21	4.59	12.00 (4.1 - 14.0)	2.935 (0.840 - 4.100)	12.89	99
15+20+20+42+71	1.07	1.43	1.43	3.00	5.07	12.00 (4.1 - 14.0)	2.935 (0.840 - 4.100)	12.89	99
15+20+22+22+22	1.65	2.20	2.42	2.42	2.42	11.10 (4.1 - 13.1)	2.870 (0.820 - 4.100)	12.60	99
15+20+22+22+25	1.64	2.19	2.41	2.41	2.74	11.40 (4.1 - 13.4)	2.890 (0.820 - 4.100)	12.69	99
15+20+22+22+35	1.58	2.11	2.32	2.32	3.68	12.00 (4.1 - 14.0)	2.915 (0.820 - 4.100)	12.80	99
15+20+22+22+42	1.49	1.98	2.18	2.18	4.17	12.00 (4.1 - 14.0)	2.915 (0.820 - 4.100)	12.80	99
15+20+22+22+50	1.40	1.86	2.05	2.05	4.65	12.00 (4.1 - 14.0)	2.915 (0.820 - 4.100)	12.80	99
15+20+22+22+60	1.29	1.73	1.90	1.90	5.18	12.00 (4.1 - 14.0)	2.915 (0.820 - 4.100)	12.80	99
15+20+22+22+71	1.20	1.60	1.76	1.76	5.68	12.00 (4.1 - 14.0)	2.915 (0.820 - 4.100)	12.80	99
15+20+22+25+25	1.64	2.19	2.41	2.73	2.73	11.70 (4.1 - 13.7)	2.900 (0.820 - 4.100)	12.74	99
15+20+22+25+35	1.54	2.05	2.26	2.56	3.59	12.00 (4.1 - 14.0)	2.915 (0.820 - 4.100)	12.80	99
15+20+22+25+42	1.45	1.94	2.13	2.42	4.06	12.00 (4.1 - 14.0)	2.915 (0.820 - 4.100)	12.80	99
15+20+22+25+50	1.36	1.82	2.00	2.27	4.55	12.00 (4.1 - 14.0)	2.915 (0.820 - 4.100)	12.80	99
15+20+22+25+60	1.27	1.69	1.86	2.11	5.07	12.00 (4.1 - 14.0)	2.915 (0.820 - 4.100)	12.80	99
15+20+22+25+71	1.18	1.57	1.73	1.96	5.57	12.00 (4.1 - 14.0)	2.915 (0.820 - 4.100)	12.80	99
15+20+22+35+35	1.42	1.89	2.08	3.31	3.31	12.00 (4.1 - 14.0)	2.915 (0.820 - 4.100)	12.80	99
15+20+22+35+42	1.34	1.79	1.97	3.13	3.76	12.00 (4.1 - 14.0)	2.915 (0.820 - 4.100)	12.80	99
15+20+22+35+50	1.27	1.69	1.86	2.96	4.23	12.00 (4.1 - 14.0)	2.915 (0.820 - 4.100)	12.80	99
15+20+22+35+60	1.18	1.58	1.74	2.76	4.74	12.00 (4.1 - 14.0)	2.915 (0.820 - 4.100)	12.80	99
15+20+22+35+71	1.10	1.47	1.62	2.58	5.23	12.00 (4.1 - 14.0)	2.915 (0.820 - 4.100)	12.80	99
15+20+22+42+42	1.28	1.70	1.87	3.57	3.57	12.00 (4.1 - 14.0)	2.895 (0.820 - 4.100)	12.71	99
15+20+22+42+50	1.21	1.61	1.77	3.38	4.03	12.00 (4.1 - 14.0)	2.895 (0.820 - 4.100)	12.71	99
15+20+22+42+60	1.13	1.51	1.66	3.17	4.53	12.00 (4.1 - 14.0)	2.895 (0.820 - 4.100)	12.71	99
15+20+22+42+71	1.06	1.41	1.55	2.96	5.01	12.00 (4.1 - 14.0)	2.895 (0.820 - 4.100)	12.71	99
15+20+25+25+25	1.64	2.18	2.73	2.73	2.73	12.00 (4.1 - 14.0)	2.915 (0.820 - 4.100)	12.80	99
15+20+25+25+35	1.50	2.00	2.50	2.50	3.50	12.00 (4.1 - 14.0)	2.915 (0.820 - 4.100)	12.80	99
15+20+25+25+42	1.42	1.89	2.36	2.36	3.97	12.00 (4.1 - 14.0)	2.915 (0.820 - 4.100)	12.80	99
15+20+25+25+50	1.33	1.78	2.22	2.22	4.44	12.00 (4.1 - 14.0)	2.915 (0.820 - 4.100)	12.80	99
15+20+25+25+60	1.24	1.66	2.07	2.07	4.97	12.00 (4.1 - 14.0)	2.915 (0.820 - 4.100)	12.80	99
15+20+25+25+71	1.15	1.54	1.92	1.92	5.46	12.00 (4.1 - 14.0)	2.915 (0.820 - 4.100)	12.80	99
15+20+25+35+35	1.38	1.85	2.31	3.23	3.23	12.00 (4.1 - 14.0)	2.915 (0.820 - 4.100)	12.80	99
15+20+25+35+42	1.31	1.75	2.19	3.07	3.68	12.00 (4.1 - 14.0)	2.915 (0.820 - 4.100)	12.80	99
15+20+25+35+50	1.24	1.66	2.07	2.90	4.14	12.00 (4.1 - 14.0)	2.915 (0.820 - 4.100)	12.80	99
15+20+25+35+60	1.16	1.55	1.94	2.71	4.65	12.00 (4.1 - 14.0)	2.915 (0.820 - 4.100)	12.80	99
15+20+25+35+71	1.08	1.45	1.81	2.53	5.13	12.00 (4.1 - 14.0)	2.915 (0.820 - 4.100)	12.80	99
15+20+25+42+42	1.25	1.67	2.08	3.50	3.50	12.00 (4.1 - 14.0)	2.895 (0.820 - 4.100)	12.71	99
15+20+25+42+50	1.18	1.58	1.97	3.32	3.95	12.00 (4.1 - 14.0)	2.895 (0.820 - 4.100)	12.71	99
15+20+25+42+60	1.11	1.48	1.85	3.11	4.44	12.00 (4.1 - 14.0)	2.895 (0.820 - 4.100)	12.71	99
15+20+35+35+35	1.29	1.71	3.00	3.00	3.00	12.00 (4.1 - 14.0)	2.915 (0.820 - 4.100)	12.80	99
15+20+35+35+42	1.22	1.63	2.86	2.86	3.43	12.00 (4.1 - 14.0)	2.915 (0.820 - 4.100)	12.80	99

MXZ-5C100VA(VA2) HEATING

Indoor units combination	Heating capacity (kW)						Outdoor unit power consumption (kW)	Current (A)	Power factor (%)
	Unit A	Unit B	Unit C	Unit D	Unit E	Total			
15+20+35+35+50	1.16	1.55	2.71	2.71	3.87	12.00 (4.1 - 14.0)	2.915 (0.820 - 4.100)	12.80	99
15+20+35+35+60	1.09	1.45	2.55	2.55	4.36	12.00 (4.1 - 14.0)	2.915 (0.820 - 4.100)	12.80	99
15+20+35+42+42	1.17	1.56	2.73	3.27	3.27	12.00 (4.1 - 14.0)	2.895 (0.820 - 4.100)	12.71	99
15+20+35+42+50	1.11	1.48	2.59	3.11	3.70	12.00 (4.1 - 14.0)	2.895 (0.820 - 4.100)	12.71	99
15+20+35+42+60	1.05	1.40	2.44	2.93	4.19	12.00 (4.1 - 14.0)	2.895 (0.820 - 4.100)	12.71	99
15+20+42+42+42	1.12	1.49	3.13	3.13	3.13	12.00 (4.1 - 14.0)	2.875 (0.820 - 4.100)	12.63	99
15+20+42+42+50	1.07	1.42	2.98	2.98	3.55	12.00 (4.1 - 14.0)	2.875 (0.820 - 4.100)	12.63	99
15+22+22+22+22	1.65	2.41	2.41	2.41	2.41	11.30 (4.1 - 13.3)	2.840 (0.800 - 4.100)	12.47	99
15+22+22+22+25	1.64	2.41	2.41	2.41	2.74	11.60 (4.1 - 13.6)	2.860 (0.800 - 4.100)	12.56	99
15+22+22+22+35	1.55	2.28	2.28	2.28	3.62	12.00 (4.1 - 14.0)	2.875 (0.800 - 4.100)	12.63	99
15+22+22+22+42	1.46	2.15	2.15	2.15	4.10	12.00 (4.1 - 14.0)	2.875 (0.800 - 4.100)	12.63	99
15+22+22+22+50	1.37	2.02	2.02	2.02	4.58	12.00 (4.1 - 14.0)	2.875 (0.800 - 4.100)	12.63	99
15+22+22+22+60	1.28	1.87	1.87	1.87	5.11	12.00 (4.1 - 14.0)	2.875 (0.800 - 4.100)	12.63	99
15+22+22+22+71	1.18	1.74	1.74	1.74	5.61	12.00 (4.1 - 14.0)	2.875 (0.800 - 4.100)	12.63	99
15+22+22+25+25	1.64	2.40	2.40	2.73	2.73	11.90 (4.1 - 13.9)	2.870 (0.800 - 4.100)	12.60	99
15+22+22+25+35	1.51	2.22	2.22	2.52	3.53	12.00 (4.1 - 14.0)	2.875 (0.800 - 4.100)	12.63	99
15+22+22+25+42	1.43	2.10	2.10	2.38	4.00	12.00 (4.1 - 14.0)	2.875 (0.800 - 4.100)	12.63	99
15+22+22+25+50	1.34	1.97	1.97	2.24	4.48	12.00 (4.1 - 14.0)	2.875 (0.800 - 4.100)	12.63	99
15+22+22+25+60	1.25	1.83	1.83	2.08	5.00	12.00 (4.1 - 14.0)	2.875 (0.800 - 4.100)	12.63	99
15+22+22+25+71	1.16	1.70	1.70	1.94	5.50	12.00 (4.1 - 14.0)	2.875 (0.800 - 4.100)	12.63	99
15+22+22+35+35	1.40	2.05	2.05	3.26	3.26	12.00 (4.1 - 14.0)	2.875 (0.800 - 4.100)	12.63	99
15+22+22+35+42	1.32	1.94	1.94	3.09	3.71	12.00 (4.1 - 14.0)	2.875 (0.800 - 4.100)	12.63	99
15+22+22+35+50	1.25	1.83	1.83	2.92	4.17	12.00 (4.1 - 14.0)	2.875 (0.800 - 4.100)	12.63	99
15+22+22+35+60	1.17	1.71	1.71	2.73	4.68	12.00 (4.1 - 14.0)	2.875 (0.800 - 4.100)	12.63	99
15+22+22+35+71	1.09	1.60	1.60	2.55	5.16	12.00 (4.1 - 14.0)	2.875 (0.800 - 4.100)	12.63	99
15+22+22+42+42	1.26	1.85	1.85	3.52	3.52	12.00 (4.1 - 14.0)	2.855 (0.800 - 4.100)	12.54	99
15+22+22+42+50	1.19	1.75	1.75	3.34	3.97	12.00 (4.1 - 14.0)	2.855 (0.800 - 4.100)	12.54	99
15+22+22+42+60	1.12	1.64	1.64	3.13	4.47	12.00 (4.1 - 14.0)	2.855 (0.800 - 4.100)	12.54	99
15+22+22+42+71	1.05	1.53	1.53	2.93	4.95	12.00 (4.1 - 14.0)	2.855 (0.800 - 4.100)	12.54	99
15+22+25+25+25	1.61	2.36	2.68	2.68	2.68	12.00 (4.1 - 14.0)	2.875 (0.800 - 4.100)	12.63	99
15+22+25+25+35	1.48	2.16	2.46	2.46	3.44	12.00 (4.1 - 14.0)	2.875 (0.800 - 4.100)	12.63	99
15+22+25+25+42	1.40	2.05	2.33	2.33	3.91	12.00 (4.1 - 14.0)	2.875 (0.800 - 4.100)	12.63	99
15+22+25+25+50	1.31	1.93	2.19	2.19	4.38	12.00 (4.1 - 14.0)	2.875 (0.800 - 4.100)	12.63	99
15+22+25+25+60	1.22	1.80	2.04	2.04	4.90	12.00 (4.1 - 14.0)	2.875 (0.800 - 4.100)	12.63	99
15+22+25+25+71	1.14	1.67	1.90	1.90	5.39	12.00 (4.1 - 14.0)	2.875 (0.800 - 4.100)	12.63	99
15+22+25+35+35	1.36	2.00	2.27	3.18	3.18	12.00 (4.1 - 14.0)	2.875 (0.800 - 4.100)	12.63	99
15+22+25+35+42	1.29	1.90	2.16	3.02	3.63	12.00 (4.1 - 14.0)	2.875 (0.800 - 4.100)	12.63	99
15+22+25+35+50	1.22	1.80	2.04	2.86	4.08	12.00 (4.1 - 14.0)	2.875 (0.800 - 4.100)	12.63	99
15+22+25+35+60	1.15	1.68	1.91	2.68	4.59	12.00 (4.1 - 14.0)	2.875 (0.800 - 4.100)	12.63	99
15+22+25+35+71	1.07	1.57	1.79	2.50	5.07	12.00 (4.1 - 14.0)	2.875 (0.800 - 4.100)	12.63	99
15+22+25+42+42	1.23	1.81	2.05	3.45	3.45	12.00 (4.1 - 14.0)	2.855 (0.800 - 4.100)	12.54	99
15+22+25+42+50	1.17	1.71	1.95	3.27	3.90	12.00 (4.1 - 14.0)	2.855 (0.800 - 4.100)	12.54	99

MXZ-5C100VA(VA2) HEATING

Indoor units combination	Heating capacity (kW)						Outdoor unit power consumption (kW)	Current (A)	Power factor (%)
	Unit A	Unit B	Unit C	Unit D	Unit E	Total			
15+22+25+42+60	1.10	1.61	1.83	3.07	4.39	12.00 (4.1 - 14.0)	2.855 (0.800 - 4.100)	12.54	99
15+22+35+35+35	1.27	1.86	2.96	2.96	2.96	12.00 (4.1 - 14.0)	2.875 (0.800 - 4.100)	12.63	99
15+22+35+35+42	1.21	1.77	2.82	2.82	3.38	12.00 (4.1 - 14.0)	2.875 (0.800 - 4.100)	12.63	99
15+22+35+35+50	1.15	1.68	2.68	2.68	3.82	12.00 (4.1 - 14.0)	2.875 (0.800 - 4.100)	12.63	99
15+22+35+35+60	1.08	1.58	2.51	2.51	4.31	12.00 (4.1 - 14.0)	2.875 (0.800 - 4.100)	12.63	99
15+22+35+42+42	1.15	1.69	2.69	3.23	3.23	12.00 (4.1 - 14.0)	2.855 (0.800 - 4.100)	12.54	99
15+22+35+42+50	1.10	1.61	2.56	3.07	3.66	12.00 (4.1 - 14.0)	2.855 (0.800 - 4.100)	12.54	99
15+22+42+42+42	1.10	1.62	3.09	3.09	3.09	12.00 (4.1 - 14.0)	2.835 (0.800 - 4.100)	12.45	99
15+22+42+42+50	1.05	1.54	2.95	2.95	3.51	12.00 (4.1 - 14.0)	2.835 (0.800 - 4.100)	12.45	99
15+25+25+25+25	1.57	2.61	2.61	2.61	2.61	12.00 (4.1 - 14.0)	2.875 (0.800 - 4.100)	12.63	99
15+25+25+25+35	1.44	2.40	2.40	2.40	3.36	12.00 (4.1 - 14.0)	2.875 (0.800 - 4.100)	12.63	99
15+25+25+25+42	1.36	2.27	2.27	2.27	3.82	12.00 (4.1 - 14.0)	2.875 (0.800 - 4.100)	12.63	99
15+25+25+25+50	1.29	2.14	2.14	2.14	4.29	12.00 (4.1 - 14.0)	2.875 (0.800 - 4.100)	12.63	99
15+25+25+25+60	1.20	2.00	2.00	2.00	4.80	12.00 (4.1 - 14.0)	2.875 (0.800 - 4.100)	12.63	99
15+25+25+25+71	1.12	1.86	1.86	1.86	5.29	12.00 (4.1 - 14.0)	2.875 (0.800 - 4.100)	12.63	99
15+25+25+35+35	1.33	2.22	2.22	3.11	3.11	12.00 (4.1 - 14.0)	2.875 (0.800 - 4.100)	12.63	99
15+25+25+35+42	1.27	2.11	2.11	2.96	3.55	12.00 (4.1 - 14.0)	2.875 (0.800 - 4.100)	12.63	99
15+25+25+35+50	1.20	2.00	2.00	2.80	4.00	12.00 (4.1 - 14.0)	2.875 (0.800 - 4.100)	12.63	99
15+25+25+35+60	1.13	1.88	1.88	2.63	4.50	12.00 (4.1 - 14.0)	2.875 (0.800 - 4.100)	12.63	99
15+25+25+35+71	1.05	1.75	1.75	2.46	4.98	12.00 (4.1 - 14.0)	2.875 (0.800 - 4.100)	12.63	99
15+25+25+42+42	1.21	2.01	2.01	3.38	3.38	12.00 (4.1 - 14.0)	2.855 (0.800 - 4.100)	12.54	99
15+25+25+42+50	1.15	1.91	1.91	3.21	3.82	12.00 (4.1 - 14.0)	2.855 (0.800 - 4.100)	12.54	99
15+25+25+42+60	1.08	1.80	1.80	3.02	4.31	12.00 (4.1 - 14.0)	2.855 (0.800 - 4.100)	12.54	99
15+25+35+35+35	1.24	2.07	2.90	2.90	2.90	12.00 (4.1 - 14.0)	2.875 (0.800 - 4.100)	12.63	99
15+25+35+35+42	1.18	1.97	2.76	2.76	3.32	12.00 (4.1 - 14.0)	2.875 (0.800 - 4.100)	12.63	99
15+25+35+35+50	1.13	1.88	2.63	2.63	3.75	12.00 (4.1 - 14.0)	2.875 (0.800 - 4.100)	12.63	99
15+25+35+35+60	1.06	1.76	2.47	2.47	4.24	12.00 (4.1 - 14.0)	2.875 (0.800 - 4.100)	12.63	99
15+25+35+42+42	1.13	1.89	2.64	3.17	3.17	12.00 (4.1 - 14.0)	2.855 (0.800 - 4.100)	12.54	99
15+25+35+42+50	1.08	1.80	2.51	3.02	3.59	12.00 (4.1 - 14.0)	2.855 (0.800 - 4.100)	12.54	99
15+25+42+42+42	1.08	1.81	3.04	3.04	3.04	12.00 (4.1 - 14.0)	2.835 (0.800 - 4.100)	12.45	99
15+35+35+35+35	1.16	2.71	2.71	2.71	2.71	12.00 (4.1 - 14.0)	2.875 (0.800 - 4.100)	12.63	99
15+35+35+35+42	1.11	2.59	2.59	2.59	3.11	12.00 (4.1 - 14.0)	2.875 (0.800 - 4.100)	12.63	99
15+35+35+35+50	1.06	2.47	2.47	2.47	3.53	12.00 (4.1 - 14.0)	2.875 (0.800 - 4.100)	12.63	99
15+35+35+42+42	1.07	2.49	2.49	2.98	2.98	12.00 (4.1 - 14.0)	2.855 (0.800 - 4.100)	12.54	99
20+20+20+20+20	2.20	2.20	2.20	2.20	2.20	11.00 (4.1 - 13.0)	2.790 (0.880 - 4.100)	12.25	99
20+20+20+20+22	2.20	2.20	2.20	2.20	2.42	11.20 (4.1 - 13.2)	2.960 (0.860 - 4.100)	13.00	99
20+20+20+20+25	2.19	2.19	2.19	2.19	2.74	11.50 (4.1 - 13.5)	2.970 (0.860 - 4.100)	13.04	99
20+20+20+20+35	2.09	2.09	2.09	2.09	3.65	12.00 (4.1 - 14.0)	2.995 (0.860 - 4.100)	13.15	99
20+20+20+20+42	1.97	1.97	1.97	1.97	4.13	12.00 (4.1 - 14.0)	2.995 (0.860 - 4.100)	13.15	99
20+20+20+20+50	1.85	1.85	1.85	1.85	4.62	12.00 (4.1 - 14.0)	2.995 (0.860 - 4.100)	13.15	99
20+20+20+20+60	1.71	1.71	1.71	1.71	5.14	12.00 (4.1 - 14.0)	2.995 (0.860 - 4.100)	13.15	99
20+20+20+20+71	1.59	1.59	1.59	1.59	5.64	12.00 (4.1 - 14.0)	2.995 (0.860 - 4.100)	13.15	99

MXZ-5C100VA(VA2) HEATING

Indoor units combination	Heating capacity (kW)						Outdoor unit power consumption (kW)	Current (A)	Power factor (%)
	Unit A	Unit B	Unit C	Unit D	Unit E	Total			
20+20+20+22+22	2.19	2.19	2.19	2.41	2.41	11.40 (4.1 - 13.4)	2.930 (0.840 - 4.100)	12.87	99
20+20+20+22+25	2.19	2.19	2.19	2.41	2.73	11.70 (4.1 - 13.7)	2.940 (0.840 - 4.100)	12.91	99
20+20+20+22+35	2.05	2.05	2.05	2.26	3.59	12.00 (4.1 - 14.0)	2.955 (0.840 - 4.100)	12.98	99
20+20+20+22+42	1.94	1.94	1.94	2.13	4.06	12.00 (4.1 - 14.0)	2.955 (0.840 - 4.100)	12.98	99
20+20+20+22+50	1.82	1.82	1.82	2.00	4.55	12.00 (4.1 - 14.0)	2.955 (0.840 - 4.100)	12.98	99
20+20+20+22+60	1.69	1.69	1.69	1.86	5.07	12.00 (4.1 - 14.0)	2.955 (0.840 - 4.100)	12.98	99
20+20+20+22+71	1.57	1.57	1.57	1.73	5.57	12.00 (4.1 - 14.0)	2.955 (0.840 - 4.100)	12.98	99
20+20+20+25+25	2.18	2.18	2.18	2.73	2.73	12.00 (4.1 - 14.0)	2.955 (0.840 - 4.100)	12.98	99
20+20+20+25+35	2.00	2.00	2.00	2.50	3.50	12.00 (4.1 - 14.0)	2.955 (0.840 - 4.100)	12.98	99
20+20+20+25+42	1.89	1.89	1.89	2.36	3.97	12.00 (4.1 - 14.0)	2.955 (0.840 - 4.100)	12.98	99
20+20+20+25+50	1.78	1.78	1.78	2.22	4.44	12.00 (4.1 - 14.0)	2.955 (0.840 - 4.100)	12.98	99
20+20+20+25+60	1.66	1.66	1.66	2.07	4.97	12.00 (4.1 - 14.0)	2.955 (0.840 - 4.100)	12.98	99
20+20+20+25+71	1.54	1.54	1.54	1.92	5.46	12.00 (4.1 - 14.0)	2.955 (0.840 - 4.100)	12.98	99
20+20+20+35+35	1.85	1.85	1.85	3.23	3.23	12.00 (4.1 - 14.0)	2.955 (0.840 - 4.100)	12.98	99
20+20+20+35+42	1.75	1.75	1.75	3.07	3.68	12.00 (4.1 - 14.0)	2.955 (0.840 - 4.100)	12.98	99
20+20+20+35+50	1.66	1.66	1.66	2.90	4.14	12.00 (4.1 - 14.0)	2.955 (0.840 - 4.100)	12.98	99
20+20+20+35+60	1.55	1.55	1.55	2.71	4.65	12.00 (4.1 - 14.0)	2.955 (0.840 - 4.100)	12.98	99
20+20+20+35+71	1.45	1.45	1.45	2.53	5.13	12.00 (4.1 - 14.0)	2.955 (0.840 - 4.100)	12.98	99
20+20+20+42+42	1.67	1.67	1.67	3.50	3.50	12.00 (4.1 - 14.0)	2.935 (0.840 - 4.100)	12.89	99
20+20+20+42+50	1.58	1.58	1.58	3.32	3.95	12.00 (4.1 - 14.0)	2.935 (0.840 - 4.100)	12.89	99
20+20+20+42+60	1.48	1.48	1.48	3.11	4.44	12.00 (4.1 - 14.0)	2.935 (0.840 - 4.100)	12.89	99
20+20+22+22+22	2.19	2.19	2.41	2.41	2.41	11.60 (4.1 - 13.6)	2.900 (0.820 - 4.100)	12.74	99
20+20+22+22+25	2.18	2.18	2.40	2.40	2.73	11.90 (4.1 - 13.9)	2.910 (0.820 - 4.100)	12.78	99
20+20+22+22+35	2.02	2.02	2.22	2.22	3.53	12.00 (4.1 - 14.0)	2.915 (0.820 - 4.100)	12.80	99
20+20+22+22+42	1.90	1.90	2.10	2.10	4.00	12.00 (4.1 - 14.0)	2.915 (0.820 - 4.100)	12.80	99
20+20+22+22+50	1.79	1.79	1.97	1.97	4.48	12.00 (4.1 - 14.0)	2.915 (0.820 - 4.100)	12.80	99
20+20+22+22+60	1.67	1.67	1.83	1.83	5.00	12.00 (4.1 - 14.0)	2.915 (0.820 - 4.100)	12.80	99
20+20+22+22+71	1.55	1.55	1.70	1.70	5.50	12.00 (4.1 - 14.0)	2.915 (0.820 - 4.100)	12.80	99
20+20+22+25+25	2.14	2.14	2.36	2.68	2.68	12.00 (4.1 - 14.0)	2.915 (0.820 - 4.100)	12.80	99
20+20+22+25+35	1.97	1.97	2.16	2.46	3.44	12.00 (4.1 - 14.0)	2.915 (0.820 - 4.100)	12.80	99
20+20+22+25+42	1.86	1.86	2.05	2.33	3.91	12.00 (4.1 - 14.0)	2.915 (0.820 - 4.100)	12.80	99
20+20+22+25+50	1.75	1.75	1.93	2.19	4.38	12.00 (4.1 - 14.0)	2.915 (0.820 - 4.100)	12.80	99
20+20+22+25+60	1.63	1.63	1.80	2.04	4.90	12.00 (4.1 - 14.0)	2.915 (0.820 - 4.100)	12.80	99
20+20+22+25+71	1.52	1.52	1.67	1.90	5.39	12.00 (4.1 - 14.0)	2.915 (0.820 - 4.100)	12.80	99
20+20+22+35+35	1.82	1.82	2.00	3.18	3.18	12.00 (4.1 - 14.0)	2.915 (0.820 - 4.100)	12.80	99
20+20+22+35+42	1.73	1.73	1.90	3.02	3.63	12.00 (4.1 - 14.0)	2.915 (0.820 - 4.100)	12.80	99
20+20+22+35+50	1.63	1.63	1.80	2.86	4.08	12.00 (4.1 - 14.0)	2.915 (0.820 - 4.100)	12.80	99
20+20+22+35+60	1.53	1.53	1.68	2.68	4.59	12.00 (4.1 - 14.0)	2.915 (0.820 - 4.100)	12.80	99
20+20+22+35+71	1.43	1.43	1.57	2.50	5.07	12.00 (4.1 - 14.0)	2.915 (0.820 - 4.100)	12.80	99
20+20+22+42+42	1.64	1.64	1.81	3.45	3.45	12.00 (4.1 - 14.0)	2.895 (0.820 - 4.100)	12.71	99
20+20+22+42+50	1.56	1.56	1.71	3.27	3.90	12.00 (4.1 - 14.0)	2.895 (0.820 - 4.100)	12.71	99
20+20+22+42+60	1.46	1.46	1.61	3.07	4.39	12.00 (4.1 - 14.0)	2.895 (0.820 - 4.100)	12.71	99

MXZ-5C100VA(VA2) HEATING

Indoor units combination	Heating capacity (kW)						Outdoor unit power consumption (kW)	Current (A)	Power factor (%)
	Unit A	Unit B	Unit C	Unit D	Unit E	Total			
20+20+25+25+25	2.09	2.09	2.61	2.61	2.61	12.00 (4.1 - 14.0)	2.915 (0.820 - 4.100)	12.80	99
20+20+25+25+35	1.92	1.92	2.40	2.40	3.36	12.00 (4.1 - 14.0)	2.915 (0.820 - 4.100)	12.80	99
20+20+25+25+42	1.82	1.82	2.27	2.27	3.82	12.00 (4.1 - 14.0)	2.915 (0.820 - 4.100)	12.80	99
20+20+25+25+50	1.71	1.71	2.14	2.14	4.29	12.00 (4.1 - 14.0)	2.915 (0.820 - 4.100)	12.80	99
20+20+25+25+60	1.60	1.60	2.00	2.00	4.80	12.00 (4.1 - 14.0)	2.915 (0.820 - 4.100)	12.80	99
20+20+25+25+71	1.49	1.49	1.86	1.86	5.29	12.00 (4.1 - 14.0)	2.915 (0.820 - 4.100)	12.80	99
20+20+25+35+35	1.78	1.78	2.22	3.11	3.11	12.00 (4.1 - 14.0)	2.915 (0.820 - 4.100)	12.80	99
20+20+25+35+42	1.69	1.69	2.11	2.96	3.55	12.00 (4.1 - 14.0)	2.915 (0.820 - 4.100)	12.80	99
20+20+25+35+50	1.60	1.60	2.00	2.80	4.00	12.00 (4.1 - 14.0)	2.915 (0.820 - 4.100)	12.80	99
20+20+25+35+60	1.50	1.50	1.88	2.63	4.50	12.00 (4.1 - 14.0)	2.915 (0.820 - 4.100)	12.80	99
20+20+25+35+71	1.40	1.40	1.75	2.46	4.98	12.00 (4.1 - 14.0)	2.915 (0.820 - 4.100)	12.80	99
20+20+25+42+42	1.61	1.61	2.01	3.38	3.38	12.00 (4.1 - 14.0)	2.895 (0.820 - 4.100)	12.71	99
20+20+25+42+50	1.53	1.53	1.91	3.21	3.82	12.00 (4.1 - 14.0)	2.895 (0.820 - 4.100)	12.71	99
20+20+25+42+60	1.44	1.44	1.80	3.02	4.31	12.00 (4.1 - 14.0)	2.895 (0.820 - 4.100)	12.71	99
20+20+35+35+35	1.66	1.66	2.90	2.90	2.90	12.00 (4.1 - 14.0)	2.915 (0.820 - 4.100)	12.80	99
20+20+35+35+42	1.58	1.58	2.76	2.76	3.32	12.00 (4.1 - 14.0)	2.915 (0.820 - 4.100)	12.80	99
20+20+35+35+50	1.50	1.50	2.63	2.63	3.75	12.00 (4.1 - 14.0)	2.915 (0.820 - 4.100)	12.80	99
20+20+35+35+60	1.41	1.41	2.47	2.47	4.24	12.00 (4.1 - 14.0)	2.915 (0.820 - 4.100)	12.80	99
20+20+35+42+42	1.51	1.51	2.64	3.17	3.17	12.00 (4.1 - 14.0)	2.895 (0.820 - 4.100)	12.71	99
20+20+35+42+50	1.44	1.44	2.51	3.02	3.59	12.00 (4.1 - 14.0)	2.895 (0.820 - 4.100)	12.71	99
20+20+42+42+42	1.45	1.45	3.04	3.04	3.04	12.00 (4.1 - 14.0)	2.875 (0.820 - 4.100)	12.63	99
20+22+22+22+22	2.19	2.40	2.40	2.40	2.40	11.80 (4.1 - 13.8)	2.870 (0.800 - 4.100)	12.60	99
20+22+22+22+25	2.16	2.38	2.38	2.38	2.70	12.00 (4.1 - 14.0)	2.875 (0.800 - 4.100)	12.63	99
20+22+22+22+35	1.98	2.18	2.18	2.18	3.47	12.00 (4.1 - 14.0)	2.875 (0.800 - 4.100)	12.63	99
20+22+22+22+42	1.88	2.06	2.06	2.06	3.94	12.00 (4.1 - 14.0)	2.875 (0.800 - 4.100)	12.63	99
20+22+22+22+50	1.76	1.94	1.94	1.94	4.41	12.00 (4.1 - 14.0)	2.875 (0.800 - 4.100)	12.63	99
20+22+22+22+60	1.64	1.81	1.81	1.81	4.93	12.00 (4.1 - 14.0)	2.875 (0.800 - 4.100)	12.63	99
20+22+22+22+71	1.53	1.68	1.68	1.68	5.43	12.00 (4.1 - 14.0)	2.875 (0.800 - 4.100)	12.63	99
20+22+22+25+25	2.11	2.32	2.32	2.63	2.63	12.00 (4.1 - 14.0)	2.875 (0.800 - 4.100)	12.63	99
20+22+22+25+35	1.94	2.13	2.13	2.42	3.39	12.00 (4.1 - 14.0)	2.875 (0.800 - 4.100)	12.63	99
20+22+22+25+42	1.83	2.02	2.02	2.29	3.85	12.00 (4.1 - 14.0)	2.875 (0.800 - 4.100)	12.63	99
20+22+22+25+50	1.73	1.90	1.90	2.16	4.32	12.00 (4.1 - 14.0)	2.875 (0.800 - 4.100)	12.63	99
20+22+22+25+60	1.61	1.77	1.77	2.01	4.83	12.00 (4.1 - 14.0)	2.875 (0.800 - 4.100)	12.63	99
20+22+22+25+71	1.50	1.65	1.65	1.88	5.33	12.00 (4.1 - 14.0)	2.875 (0.800 - 4.100)	12.63	99
20+22+22+35+35	1.79	1.97	1.97	3.13	3.13	12.00 (4.1 - 14.0)	2.875 (0.800 - 4.100)	12.63	99
20+22+22+35+42	1.70	1.87	1.87	2.98	3.57	12.00 (4.1 - 14.0)	2.875 (0.800 - 4.100)	12.63	99
20+22+22+35+50	1.61	1.77	1.77	2.82	4.03	12.00 (4.1 - 14.0)	2.875 (0.800 - 4.100)	12.63	99
20+22+22+35+60	1.51	1.66	1.66	2.64	4.53	12.00 (4.1 - 14.0)	2.875 (0.800 - 4.100)	12.63	99
20+22+22+35+71	1.41	1.55	1.55	2.47	5.01	12.00 (4.1 - 14.0)	2.875 (0.800 - 4.100)	12.63	99
20+22+22+42+42	1.62	1.78	1.78	3.41	3.41	12.00 (4.1 - 14.0)	2.855 (0.800 - 4.100)	12.54	99
20+22+22+42+50	1.54	1.69	1.69	3.23	3.85	12.00 (4.1 - 14.0)	2.855 (0.800 - 4.100)	12.54	99
20+22+22+42+60	1.45	1.59	1.59	3.04	4.34	12.00 (4.1 - 14.0)	2.855 (0.800 - 4.100)	12.54	99

MXZ-5C100VA(VA2) HEATING

Indoor units combination	Heating capacity (kW)						Outdoor unit power consumption (kW)	Current (A)	Power factor (%)
	Unit A	Unit B	Unit C	Unit D	Unit E	Total			
20+22+25+25+25	2.05	2.26	2.56	2.56	2.56	12.00 (4.1 - 14.0)	2.875 (0.800 - 4.100)	12.63	99
20+22+25+25+35	1.89	2.08	2.36	2.36	3.31	12.00 (4.1 - 14.0)	2.875 (0.800 - 4.100)	12.63	99
20+22+25+25+42	1.79	1.97	2.24	2.24	3.76	12.00 (4.1 - 14.0)	2.875 (0.800 - 4.100)	12.63	99
20+22+25+25+50	1.69	1.86	2.11	2.11	4.23	12.00 (4.1 - 14.0)	2.875 (0.800 - 4.100)	12.63	99
20+22+25+25+60	1.58	1.74	1.97	1.97	4.74	12.00 (4.1 - 14.0)	2.875 (0.800 - 4.100)	12.63	99
20+22+25+25+71	1.47	1.62	1.84	1.84	5.23	12.00 (4.1 - 14.0)	2.875 (0.800 - 4.100)	12.63	99
20+22+25+35+35	1.75	1.93	2.19	3.07	3.07	12.00 (4.1 - 14.0)	2.875 (0.800 - 4.100)	12.63	99
20+22+25+35+42	1.67	1.83	2.08	2.92	3.50	12.00 (4.1 - 14.0)	2.875 (0.800 - 4.100)	12.63	99
20+22+25+35+50	1.58	1.74	1.97	2.76	3.95	12.00 (4.1 - 14.0)	2.875 (0.800 - 4.100)	12.63	99
20+22+25+35+60	1.48	1.63	1.85	2.59	4.44	12.00 (4.1 - 14.0)	2.875 (0.800 - 4.100)	12.63	99
20+22+25+42+42	1.59	1.75	1.99	3.34	3.34	12.00 (4.1 - 14.0)	2.855 (0.800 - 4.100)	12.54	99
20+22+25+42+50	1.51	1.66	1.89	3.17	3.77	12.00 (4.1 - 14.0)	2.855 (0.800 - 4.100)	12.54	99
20+22+25+42+60	1.42	1.56	1.78	2.98	4.26	12.00 (4.1 - 14.0)	2.855 (0.800 - 4.100)	12.54	99
20+22+35+35+35	1.63	1.80	2.86	2.86	2.86	12.00 (4.1 - 14.0)	2.875 (0.800 - 4.100)	12.63	99
20+22+35+35+42	1.56	1.71	2.73	2.73	3.27	12.00 (4.1 - 14.0)	2.875 (0.800 - 4.100)	12.63	99
20+22+35+35+50	1.48	1.63	2.59	2.59	3.70	12.00 (4.1 - 14.0)	2.875 (0.800 - 4.100)	12.63	99
20+22+35+35+60	1.40	1.53	2.44	2.44	4.19	12.00 (4.1 - 14.0)	2.875 (0.800 - 4.100)	12.63	99
20+22+35+42+42	1.49	1.64	2.61	3.13	3.13	12.00 (4.1 - 14.0)	2.855 (0.800 - 4.100)	12.54	99
20+22+35+42+50	1.42	1.56	2.49	2.98	3.55	12.00 (4.1 - 14.0)	2.855 (0.800 - 4.100)	12.54	99
20+22+42+42+42	1.43	1.57	3.00	3.00	3.00	12.00 (4.1 - 14.0)	2.835 (0.800 - 4.100)	12.45	99
20+25+25+25+25	2.00	2.50	2.50	2.50	2.50	12.00 (4.1 - 14.0)	2.875 (0.800 - 4.100)	12.63	99
20+25+25+25+35	1.85	2.31	2.31	2.31	3.23	12.00 (4.1 - 14.0)	2.875 (0.800 - 4.100)	12.63	99
20+25+25+25+42	1.75	2.19	2.19	2.19	3.68	12.00 (4.1 - 14.0)	2.875 (0.800 - 4.100)	12.63	99
20+25+25+25+50	1.66	2.07	2.07	2.07	4.14	12.00 (4.1 - 14.0)	2.875 (0.800 - 4.100)	12.63	99
20+25+25+25+60	1.55	1.94	1.94	1.94	4.65	12.00 (4.1 - 14.0)	2.875 (0.800 - 4.100)	12.63	99
20+25+25+25+71	1.45	1.81	1.81	1.81	5.13	12.00 (4.1 - 14.0)	2.875 (0.800 - 4.100)	12.63	99
20+25+25+35+35	1.71	2.14	2.14	3.00	3.00	12.00 (4.1 - 14.0)	2.875 (0.800 - 4.100)	12.63	99
20+25+25+35+42	1.63	2.04	2.04	2.86	3.43	12.00 (4.1 - 14.0)	2.875 (0.800 - 4.100)	12.63	99
20+25+25+35+50	1.55	1.94	1.94	2.71	3.87	12.00 (4.1 - 14.0)	2.875 (0.800 - 4.100)	12.63	99
20+25+25+35+60	1.45	1.82	1.82	2.55	4.36	12.00 (4.1 - 14.0)	2.875 (0.800 - 4.100)	12.63	99
20+25+25+42+42	1.56	1.95	1.95	3.27	3.27	12.00 (4.1 - 14.0)	2.855 (0.800 - 4.100)	12.54	99
20+25+25+42+50	1.48	1.85	1.85	3.11	3.70	12.00 (4.1 - 14.0)	2.855 (0.800 - 4.100)	12.54	99
20+25+25+42+60	1.40	1.74	1.74	2.93	4.19	12.00 (4.1 - 14.0)	2.855 (0.800 - 4.100)	12.54	99
20+25+35+35+35	1.60	2.00	2.80	2.80	2.80	12.00 (4.1 - 14.0)	2.875 (0.800 - 4.100)	12.63	99
20+25+35+35+42	1.53	1.91	2.68	2.68	3.21	12.00 (4.1 - 14.0)	2.875 (0.800 - 4.100)	12.63	99
20+25+35+35+50	1.45	1.82	2.55	2.55	3.64	12.00 (4.1 - 14.0)	2.875 (0.800 - 4.100)	12.63	99
20+25+35+42+42	1.46	1.83	2.56	3.07	3.07	12.00 (4.1 - 14.0)	2.855 (0.800 - 4.100)	12.54	99
20+25+35+42+50	1.40	1.74	2.44	2.93	3.49	12.00 (4.1 - 14.0)	2.855 (0.800 - 4.100)	12.54	99
20+25+42+42+42	1.40	1.75	2.95	2.95	2.95	12.00 (4.1 - 14.0)	2.835 (0.800 - 4.100)	12.45	99
20+35+35+35+35	1.50	2.63	2.63	2.63	2.63	12.00 (4.1 - 14.0)	2.875 (0.800 - 4.100)	12.63	99
20+35+35+35+42	1.44	2.51	2.51	2.51	3.02	12.00 (4.1 - 14.0)	2.875 (0.800 - 4.100)	12.63	99
22+22+22+22+22	2.40	2.40	2.40	2.40	2.40	12.00 (4.1 - 14.0)	2.835 (0.780 - 4.100)	12.45	99

MXZ-6C120VA COOLING

Indoor units combination	Cooling capacity (kW)						Outdoor unit power consumption (kW)	Current (A)	Power factor (%)	
	Unit A	Unit B	Unit C	Unit D	Unit E	Unit F				
20+20+20+35	2.00	2.00	2.00	3.50			9.50 (3.30 - 11.50)	2.75 (0.87 - 3.98)	12.08	99
20+20+20+42	1.96	1.96	1.96	4.12			10.00 (3.30 - 11.80)	3.07 (0.87 - 4.05)	13.48	99
20+20+20+50	1.85	1.85	1.85	4.64			10.20 (3.30 - 12.00)	3.15 (0.87 - 4.14)	13.83	99
20+20+20+60	1.73	1.73	1.73	5.20			10.40 (3.40 - 12.10)	3.23 (0.87 - 4.19)	14.19	99
20+20+20+71	1.60	1.60	1.60	5.69			10.50 (3.40 - 12.30)	3.27 (0.87 - 4.28)	14.36	99
20+20+22+22	2.00	2.00	2.20	2.20			8.40 (3.20 - 10.80)	2.29 (0.89 - 4.10)	10.06	99
20+20+22+25	2.00	2.00	2.20	2.50			8.70 (3.30 - 11.00)	2.30 (0.88 - 3.85)	10.10	99
20+20+22+35	2.00	2.00	2.20	3.50			9.70 (3.30 - 11.60)	2.88 (0.87 - 4.00)	12.65	99
20+20+22+42	1.94	1.94	2.14	4.08			10.10 (3.30 - 11.90)	3.11 (0.87 - 4.10)	13.66	99
20+20+22+50	1.82	1.82	2.00	4.55			10.20 (3.30 - 12.00)	3.15 (0.87 - 4.14)	13.83	99
20+20+22+60	1.70	1.70	1.88	5.11			10.40 (3.40 - 12.10)	3.23 (0.87 - 4.19)	14.19	99
20+20+22+71	1.59	1.59	1.75	5.66			10.60 (3.40 - 12.30)	3.31 (0.87 - 4.28)	14.54	99
20+20+25+25	2.00	2.00	2.50	2.50			9.00 (3.30 - 11.10)	2.44 (0.87 - 3.88)	10.72	99
20+20+25+35	2.00	2.00	2.50	3.50			10.00 (3.30 - 11.80)	3.07 (0.87 - 4.05)	13.48	99
20+20+25+42	1.89	1.89	2.36	3.96			10.10 (3.30 - 11.90)	3.11 (0.87 - 4.10)	13.66	99
20+20+25+50	1.79	1.79	2.24	4.48			10.30 (3.30 - 12.00)	3.19 (0.87 - 4.14)	14.01	99
20+20+25+60	1.66	1.66	2.08	4.99			10.40 (3.40 - 12.20)	3.23 (0.87 - 4.24)	14.19	99
20+20+25+71	1.56	1.56	1.95	5.53			10.60 (3.40 - 12.30)	3.31 (0.87 - 4.28)	14.54	99
20+20+35+35	1.85	1.85	3.25	3.25			10.20 (3.30 - 12.00)	3.15 (0.87 - 4.14)	13.83	99
20+20+35+42	1.76	1.76	3.08	3.70			10.30 (3.30 - 12.10)	3.19 (0.87 - 4.19)	14.01	99
20+20+35+50	1.66	1.66	2.91	4.16			10.40 (3.40 - 12.20)	3.23 (0.87 - 4.24)	14.19	99
20+20+35+60	1.57	1.57	2.75	4.71			10.60 (3.40 - 12.30)	3.31 (0.87 - 4.28)	14.54	99
20+20+35+71	1.47	1.47	2.57	5.20			10.70 (3.40 - 12.40)	3.35 (0.87 - 4.33)	14.71	99
20+20+42+42	1.68	1.68	3.52	3.52			10.40 (3.40 - 12.20)	3.23 (0.87 - 4.24)	14.19	99
20+20+42+50	1.61	1.61	3.37	4.02			10.60 (3.40 - 12.30)	3.31 (0.87 - 4.28)	14.54	99
20+20+42+60	1.51	1.51	3.16	4.52			10.70 (3.40 - 12.40)	3.35 (0.87 - 4.33)	14.71	99
20+20+42+71	1.40	1.40	2.94	4.97			10.70 (3.40 - 12.40)	3.35 (0.87 - 4.33)	14.71	99
20+20+50+50	1.53	1.53	3.82	3.82			10.70 (3.40 - 12.40)	3.35 (0.87 - 4.33)	14.71	99
20+20+50+60	1.43	1.43	3.57	4.28			10.70 (3.40 - 12.40)	3.35 (0.87 - 4.33)	14.71	99
20+20+50+71	1.34	1.34	3.35	4.76			10.80 (3.40 - 12.50)	3.38 (0.87 - 4.40)	14.84	99
20+20+60+60	1.35	1.35	4.05	4.05			10.80 (3.40 - 12.50)	3.38 (0.87 - 4.40)	14.84	99
20+20+60+71	1.26	1.26	3.79	4.48			10.80 (3.40 - 12.50)	3.38 (0.87 - 4.40)	14.84	99
20+22+22+22	2.00	2.20	2.20	2.20			8.60 (3.30 - 10.90)	2.30 (0.88 - 3.97)	10.10	99
20+22+22+25	2.00	2.20	2.20	2.50			8.90 (3.30 - 11.10)	2.37 (0.87 - 3.88)	10.41	99
20+22+22+35	2.00	2.20	2.20	3.50			9.90 (3.30 - 11.70)	3.01 (0.87 - 4.03)	13.22	99
20+22+22+42	1.91	2.10	2.10	4.00			10.10 (3.30 - 11.90)	3.11 (0.87 - 4.10)	13.66	99
20+22+22+50	1.79	1.97	1.97	4.47			10.20 (3.30 - 12.00)	3.15 (0.87 - 4.14)	13.83	99
20+22+22+60	1.68	1.85	1.85	5.03			10.40 (3.40 - 12.20)	3.23 (0.87 - 4.24)	14.19	99
20+22+22+71	1.57	1.73	1.73	5.57			10.60 (3.40 - 12.30)	3.31 (0.87 - 4.28)	14.54	99
20+22+25+25	2.00	2.20	2.50	2.50			9.20 (3.30 - 11.30)	2.56 (0.87 - 3.93)	11.24	99
20+22+25+35	1.96	2.16	2.45	3.43			10.00 (3.30 - 11.80)	3.07 (0.87 - 4.05)	13.48	99
20+22+25+42	1.87	2.06	2.34	3.93			10.20 (3.30 - 11.90)	3.15 (0.87 - 4.10)	13.83	99
20+22+25+50	1.76	1.94	2.20	4.40			10.30 (3.30 - 12.10)	3.19 (0.87 - 4.19)	14.01	99
20+22+25+60	1.65	1.82	2.07	4.96			10.50 (3.40 - 12.20)	3.27 (0.87 - 4.24)	14.36	99
20+22+25+71	1.55	1.71	1.94	5.51			10.70 (3.40 - 12.40)	3.35 (0.87 - 4.33)	14.71	99
20+22+35+35	1.82	2.00	3.19	3.19			10.20 (3.30 - 12.00)	3.15 (0.87 - 4.14)	13.83	99

MXZ-6C120VA COOLING

Indoor units combination	Cooling capacity (kW)						Outdoor unit power consumption (kW)	Current (A)	Power factor (%)
	Unit A	Unit B	Unit C	Unit D	Unit E	Unit F			
20+22+35+42	1.73	1.90	3.03	3.64			10.30 (3.30 - 12.10)	3.19 (0.87 - 4.19)	14.01 99
20+22+35+50	1.65	1.82	2.89	4.13			10.50 (3.40 - 12.20)	3.27 (0.87 - 4.24)	14.36 99
20+22+35+60	1.55	1.70	2.71	4.64			10.60 (3.40 - 12.40)	3.31 (0.87 - 4.33)	14.54 99
20+22+35+71	1.45	1.59	2.53	5.13			10.70 (3.40 - 12.40)	3.35 (0.87 - 4.33)	14.71 99
20+22+42+42	1.67	1.83	3.50	3.50			10.50 (3.40 - 12.20)	3.27 (0.87 - 4.24)	14.36 99
20+22+42+50	1.58	1.74	3.32	3.96			10.60 (3.40 - 12.30)	3.31 (0.87 - 4.28)	14.54 99
20+22+42+60	1.49	1.63	3.12	4.46			10.70 (3.40 - 12.40)	3.35 (0.87 - 4.33)	14.71 99
20+22+42+71	1.39	1.53	2.93	4.95			10.80 (3.40 - 12.50)	3.38 (0.87 - 4.40)	14.84 99
20+22+50+50	1.51	1.66	3.77	3.77			10.70 (3.40 - 12.40)	3.35 (0.87 - 4.33)	14.71 99
20+22+50+60	1.41	1.55	3.52	4.22			10.70 (3.40 - 12.40)	3.35 (0.87 - 4.33)	14.71 99
20+22+50+71	1.33	1.46	3.31	4.70			10.80 (3.40 - 12.50)	3.38 (0.87 - 4.40)	14.84 99
20+22+60+60	1.33	1.47	4.00	4.00			10.80 (3.40 - 12.50)	3.38 (0.87 - 4.40)	14.84 99
20+22+60+71	1.25	1.37	3.75	4.43			10.80 (3.40 - 12.50)	3.38 (0.87 - 4.40)	14.84 99
20+25+25+25	2.00	2.50	2.50	2.50			9.50 (3.30 - 11.50)	2.75 (0.87 - 3.98)	12.08 99
20+25+25+35	1.92	2.40	2.40	3.37			10.10 (3.30 - 11.90)	3.11 (0.87 - 4.10)	13.66 99
20+25+25+42	1.82	2.28	2.28	3.83			10.20 (3.30 - 12.00)	3.15 (0.87 - 4.14)	13.83 99
20+25+25+50	1.73	2.17	2.17	4.33			10.40 (3.40 - 12.10)	3.23 (0.87 - 4.19)	14.19 99
20+25+25+60	1.62	2.02	2.02	4.85			10.50 (3.40 - 12.30)	3.27 (0.87 - 4.28)	14.36 99
20+25+25+71	1.52	1.90	1.90	5.39			10.70 (3.40 - 12.40)	3.35 (0.87 - 4.33)	14.71 99
20+25+35+35	1.79	2.24	3.13	3.13			10.30 (3.30 - 12.00)	3.19 (0.87 - 4.14)	14.01 99
20+25+35+42	1.70	2.13	2.98	3.58			10.40 (3.40 - 12.10)	3.23 (0.87 - 4.19)	14.19 99
20+25+35+50	1.62	2.02	2.83	4.04			10.50 (3.40 - 12.30)	3.27 (0.87 - 4.28)	14.36 99
20+25+35+60	1.53	1.91	2.68	4.59			10.70 (3.40 - 12.40)	3.35 (0.87 - 4.33)	14.71 99
20+25+35+71	1.42	1.77	2.48	5.03			10.70 (3.40 - 12.40)	3.35 (0.87 - 4.33)	14.71 99
20+25+42+42	1.63	2.03	3.42	3.42			10.50 (3.40 - 12.20)	3.27 (0.87 - 4.24)	14.36 99
20+25+42+50	1.55	1.93	3.25	3.87			10.60 (3.40 - 12.40)	3.31 (0.87 - 4.33)	14.54 99
20+25+42+60	1.46	1.82	3.06	4.37			10.70 (3.40 - 12.40)	3.35 (0.87 - 4.33)	14.71 99
20+25+42+71	1.37	1.71	2.87	4.85			10.80 (3.40 - 12.50)	3.38 (0.87 - 4.40)	14.84 99
20+25+50+50	1.48	1.84	3.69	3.69			10.70 (3.40 - 12.40)	3.35 (0.87 - 4.33)	14.71 99
20+25+50+60	1.39	1.74	3.48	4.18			10.80 (3.40 - 12.50)	3.38 (0.87 - 4.40)	14.84 99
20+25+50+71	1.30	1.63	3.25	4.62			10.80 (3.40 - 12.50)	3.38 (0.87 - 4.40)	14.84 99
20+25+60+60	1.31	1.64	3.93	3.93			10.80 (3.40 - 12.50)	3.38 (0.87 - 4.40)	14.84 99
20+25+60+71	1.23	1.53	3.68	4.36			10.80 (3.40 - 12.50)	3.38 (0.87 - 4.40)	14.84 99
20+35+35+35	1.66	2.91	2.91	2.91			10.40 (3.40 - 12.20)	3.23 (0.87 - 4.24)	14.19 99
20+35+35+42	1.61	2.81	2.81	3.37			10.60 (3.40 - 12.30)	3.31 (0.87 - 4.28)	14.54 99
20+35+35+50	1.53	2.68	2.68	3.82			10.70 (3.40 - 12.40)	3.35 (0.87 - 4.33)	14.71 99
20+35+35+60	1.43	2.50	2.50	4.28			10.70 (3.40 - 12.40)	3.35 (0.87 - 4.33)	14.71 99
20+35+35+71	1.34	2.35	2.35	4.76			10.80 (3.40 - 12.50)	3.38 (0.87 - 4.40)	14.84 99
20+35+42+42	1.54	2.69	3.23	3.23			10.70 (3.40 - 12.40)	3.35 (0.87 - 4.33)	14.71 99
20+35+42+50	1.46	2.55	3.06	3.64			10.70 (3.40 - 12.40)	3.35 (0.87 - 4.33)	14.71 99
20+35+42+60	1.38	2.41	2.89	4.13			10.80 (3.40 - 12.50)	3.38 (0.87 - 4.40)	14.84 99
20+35+42+71	1.29	2.25	2.70	4.56			10.80 (3.40 - 12.50)	3.38 (0.87 - 4.40)	14.84 99
20+35+50+50	1.39	2.44	3.48	3.48			10.80 (3.40 - 12.50)	3.38 (0.87 - 4.40)	14.84 99
20+35+50+60	1.31	2.29	3.27	3.93			10.80 (3.40 - 12.50)	3.38 (0.87 - 4.40)	14.84 99
20+35+50+71	1.23	2.15	3.07	4.36			10.80 (3.40 - 12.50)	3.38 (0.87 - 4.40)	14.84 99
20+35+60+60	1.23	2.16	3.70	3.70			10.80 (3.40 - 12.50)	3.38 (0.87 - 4.40)	14.84 99

MXZ-6C120VA COOLING

Indoor units combination	Cooling capacity (kW)						Outdoor unit power consumption (kW)	Current (A)	Power factor (%)	
	Unit A	Unit B	Unit C	Unit D	Unit E	Unit F				
20+42+42+42	1.47	3.08	3.08	3.08			10.70 (3.40 - 12.40)	3.35 (0.87 - 4.33)	14.71	99
20+42+42+50	1.40	2.95	2.95	3.51			10.80 (3.40 - 12.50)	3.38 (0.87 - 4.40)	14.84	99
20+42+42+60	1.32	2.77	2.77	3.95			10.80 (3.40 - 12.50)	3.38 (0.87 - 4.40)	14.84	99
20+42+42+71	1.23	2.59	2.59	4.38			10.80 (3.40 - 12.50)	3.38 (0.87 - 4.40)	14.84	99
20+42+50+50	1.33	2.80	3.33	3.33			10.80 (3.40 - 12.50)	3.38 (0.87 - 4.40)	14.84	99
20+42+50+60	1.26	2.64	3.14	3.77			10.80 (3.40 - 12.50)	3.38 (0.87 - 4.40)	14.84	99
20+50+50+50	1.27	3.18	3.18	3.18			10.80 (3.40 - 12.50)	3.38 (0.87 - 4.40)	14.84	99
20+50+50+60	1.20	3.00	3.00	3.60			10.80 (3.40 - 12.50)	3.38 (0.87 - 4.40)	14.84	99
22+22+22+22	2.20	2.20	2.20	2.20			8.80 (3.30 - 11.00)	2.31 (0.87 - 3.85)	10.14	99
22+22+22+25	2.20	2.20	2.20	2.50			9.10 (3.30 - 11.20)	2.50 (0.87 - 3.90)	10.98	99
22+22+22+35	2.18	2.18	2.18	3.47			10.00 (3.30 - 11.80)	3.07 (0.87 - 4.05)	13.48	99
22+22+22+42	2.06	2.06	2.06	3.93			10.10 (3.30 - 11.90)	3.11 (0.87 - 4.10)	13.66	99
22+22+22+50	1.95	1.95	1.95	4.44			10.30 (3.30 - 12.00)	3.19 (0.87 - 4.14)	14.01	99
22+22+22+60	1.83	1.83	1.83	5.00			10.50 (3.40 - 12.20)	3.27 (0.87 - 4.24)	14.36	99
22+22+22+71	1.70	1.70	1.70	5.49			10.60 (3.40 - 12.40)	3.31 (0.87 - 4.33)	14.54	99
22+22+25+25	2.20	2.20	2.50	2.50			9.40 (3.30 - 11.40)	2.69 (0.87 - 3.95)	11.81	99
22+22+25+35	2.14	2.14	2.43	3.40			10.10 (3.30 - 11.90)	3.11 (0.87 - 4.10)	13.66	99
22+22+25+42	2.02	2.02	2.30	3.86			10.20 (3.30 - 12.00)	3.15 (0.87 - 4.14)	13.83	99
22+22+25+50	1.90	1.90	2.16	4.33			10.30 (3.30 - 12.10)	3.19 (0.87 - 4.19)	14.01	99
22+22+25+60	1.79	1.79	2.03	4.88			10.50 (3.40 - 12.20)	3.27 (0.87 - 4.24)	14.36	99
22+22+25+71	1.68	1.68	1.91	5.43			10.70 (3.40 - 12.40)	3.35 (0.87 - 4.33)	14.71	99
22+22+35+35	1.97	1.97	3.13	3.13			10.20 (3.30 - 12.00)	3.15 (0.87 - 4.14)	13.83	99
22+22+35+42	1.89	1.89	3.01	3.61			10.40 (3.40 - 12.10)	3.23 (0.87 - 4.19)	14.19	99
22+22+35+50	1.79	1.79	2.85	4.07			10.50 (3.40 - 12.20)	3.27 (0.87 - 4.24)	14.36	99
22+22+35+60	1.69	1.69	2.69	4.62			10.70 (3.40 - 12.40)	3.35 (0.87 - 4.33)	14.71	99
22+22+35+71	1.57	1.57	2.50	5.06			10.70 (3.40 - 12.40)	3.35 (0.87 - 4.33)	14.71	99
22+22+42+42	1.80	1.80	3.45	3.45			10.50 (3.40 - 12.20)	3.27 (0.87 - 4.24)	14.36	99
22+22+42+50	1.71	1.71	3.27	3.90			10.60 (3.40 - 12.30)	3.31 (0.87 - 4.28)	14.54	99
22+22+42+60	1.61	1.61	3.08	4.40			10.70 (3.40 - 12.40)	3.35 (0.87 - 4.33)	14.71	99
22+22+42+71	1.51	1.51	2.89	4.88			10.80 (3.40 - 12.50)	3.38 (0.87 - 4.40)	14.84	99
22+22+50+50	1.63	1.63	3.72	3.72			10.70 (3.40 - 12.40)	3.35 (0.87 - 4.33)	14.71	99
22+22+50+60	1.54	1.54	3.51	4.21			10.80 (3.40 - 12.50)	3.38 (0.87 - 4.40)	14.84	99
22+22+50+71	1.44	1.44	3.27	4.65			10.80 (3.40 - 12.50)	3.38 (0.87 - 4.40)	14.84	99
22+22+60+60	1.45	1.45	3.95	3.95			10.80 (3.40 - 12.50)	3.38 (0.87 - 4.40)	14.84	99
22+22+60+71	1.36	1.36	3.70	4.38			10.80 (3.40 - 12.50)	3.38 (0.87 - 4.40)	14.84	99
22+25+25+25	2.20	2.50	2.50	2.50			9.70 (3.30 - 11.60)	2.88 (0.87 - 4.00)	12.65	99
22+25+25+35	2.08	2.36	2.36	3.30			10.10 (3.30 - 11.90)	3.11 (0.87 - 4.10)	13.66	99
22+25+25+42	1.97	2.24	2.24	3.76			10.20 (3.30 - 12.00)	3.15 (0.87 - 4.14)	13.83	99
22+25+25+50	1.88	2.13	2.13	4.26			10.40 (3.40 - 12.10)	3.23 (0.87 - 4.19)	14.19	99
22+25+25+60	1.77	2.01	2.01	4.82			10.60 (3.40 - 12.30)	3.31 (0.87 - 4.28)	14.54	99
22+25+25+71	1.65	1.87	1.87	5.31			10.70 (3.40 - 12.40)	3.35 (0.87 - 4.33)	14.71	99
22+25+35+35	1.94	2.20	3.08	3.08			10.30 (3.30 - 12.10)	3.19 (0.87 - 4.19)	14.01	99
22+25+35+42	1.85	2.10	2.94	3.52			10.40 (3.40 - 12.20)	3.23 (0.87 - 4.24)	14.19	99
22+25+35+50	1.77	2.01	2.81	4.02			10.60 (3.40 - 12.30)	3.31 (0.87 - 4.28)	14.54	99
22+25+35+60	1.66	1.88	2.64	4.52			10.70 (3.40 - 12.40)	3.35 (0.87 - 4.33)	14.71	99
22+25+35+71	1.54	1.75	2.45	4.97			10.70 (3.40 - 12.40)	3.35 (0.87 - 4.33)	14.71	99

MXZ-6C120VA COOLING

Indoor units combination	Cooling capacity (kW)						Outdoor unit power consumption (kW)	Current (A)	Power factor (%)	
	Unit A	Unit B	Unit C	Unit D	Unit E	Unit F				
22+25+42+42	1.76	2.00	3.37	3.37			10.50 (3.40 - 12.30)	3.27 (0.87 - 4.28)	14.36	99
22+25+42+50	1.69	1.92	3.23	3.85			10.70 (3.40 - 12.40)	3.35 (0.87 - 4.33)	14.71	99
22+25+42+60	1.58	1.80	3.02	4.31			10.70 (3.40 - 12.40)	3.35 (0.87 - 4.33)	14.71	99
22+25+42+71	1.49	1.69	2.84	4.79			10.80 (3.40 - 12.50)	3.38 (0.87 - 4.40)	14.84	99
22+25+50+50	1.60	1.82	3.64	3.64			10.70 (3.40 - 12.40)	3.35 (0.87 - 4.33)	14.71	99
22+25+50+60	1.51	1.72	3.44	4.13			10.80 (3.40 - 12.50)	3.38 (0.87 - 4.40)	14.84	99
22+25+50+71	1.41	1.61	3.21	4.56			10.80 (3.40 - 12.50)	3.38 (0.87 - 4.40)	14.84	99
22+25+60+60	1.42	1.62	3.88	3.88			10.80 (3.40 - 12.50)	3.38 (0.87 - 4.40)	14.84	99
22+25+60+71	1.33	1.52	3.64	4.31			10.80 (3.40 - 12.50)	3.38 (0.87 - 4.40)	14.84	99
22+35+35+35	1.82	2.89	2.89	2.89			10.50 (3.40 - 12.20)	3.27 (0.87 - 4.24)	14.36	99
22+35+35+42	1.74	2.77	2.77	3.32			10.60 (3.40 - 12.30)	3.31 (0.87 - 4.28)	14.54	99
22+35+35+50	1.66	2.64	2.64	3.77			10.70 (3.40 - 12.40)	3.35 (0.87 - 4.33)	14.71	99
22+35+35+60	1.55	2.46	2.46	4.22			10.70 (3.40 - 12.40)	3.35 (0.87 - 4.33)	14.71	99
22+35+35+71	1.46	2.32	2.32	4.70			10.80 (3.40 - 12.50)	3.38 (0.87 - 4.40)	14.84	99
22+35+42+42	1.67	2.66	3.19	3.19			10.70 (3.40 - 12.40)	3.35 (0.87 - 4.33)	14.71	99
22+35+42+50	1.58	2.51	3.02	3.59			10.70 (3.40 - 12.40)	3.35 (0.87 - 4.33)	14.71	99
22+35+42+60	1.49	2.38	2.85	4.08			10.80 (3.40 - 12.50)	3.38 (0.87 - 4.40)	14.84	99
22+35+42+71	1.40	2.22	2.67	4.51			10.80 (3.40 - 12.50)	3.38 (0.87 - 4.40)	14.84	99
22+35+50+50	1.51	2.41	3.44	3.44			10.80 (3.40 - 12.50)	3.38 (0.87 - 4.40)	14.84	99
22+35+50+60	1.42	2.26	3.23	3.88			10.80 (3.40 - 12.50)	3.38 (0.87 - 4.40)	14.84	99
22+35+50+71	1.33	2.12	3.03	4.31			10.80 (3.40 - 12.50)	3.38 (0.87 - 4.40)	14.84	99
22+35+60+60	1.34	2.14	3.66	3.66			10.80 (3.40 - 12.50)	3.38 (0.87 - 4.40)	14.84	99
22+42+42+42	1.59	3.04	3.04	3.04			10.70 (3.40 - 12.40)	3.35 (0.87 - 4.33)	14.71	99
22+42+42+50	1.52	2.91	2.91	3.46			10.80 (3.40 - 12.50)	3.38 (0.87 - 4.40)	14.84	99
22+42+42+60	1.43	2.73	2.73	3.90			10.80 (3.40 - 12.50)	3.38 (0.87 - 4.40)	14.84	99
22+42+42+71	1.34	2.56	2.56	4.33			10.80 (3.40 - 12.50)	3.38 (0.87 - 4.40)	14.84	99
22+42+50+50	1.45	2.77	3.29	3.29			10.80 (3.40 - 12.50)	3.38 (0.87 - 4.40)	14.84	99
22+42+50+60	1.37	2.61	3.10	3.72			10.80 (3.40 - 12.50)	3.38 (0.87 - 4.40)	14.84	99
22+50+50+50	1.38	3.14	3.14	3.14			10.80 (3.40 - 12.50)	3.38 (0.87 - 4.40)	14.84	99
25+25+25+25	2.50	2.50	2.50	2.50			10.00 (3.30 - 11.80)	3.07 (0.87 - 4.05)	13.48	99
25+25+25+35	2.32	2.32	2.32	3.25			10.20 (3.30 - 12.00)	3.15 (0.87 - 4.14)	13.83	99
25+25+25+42	2.20	2.20	2.20	3.70			10.30 (3.30 - 12.10)	3.19 (0.87 - 4.19)	14.01	99
25+25+25+50	2.08	2.08	2.08	4.16			10.40 (3.40 - 12.20)	3.23 (0.87 - 4.24)	14.19	99
25+25+25+60	1.96	1.96	1.96	4.71			10.60 (3.40 - 12.30)	3.31 (0.87 - 4.28)	14.54	99
25+25+25+71	1.83	1.83	1.83	5.20			10.70 (3.40 - 12.40)	3.35 (0.87 - 4.33)	14.71	99
25+25+35+35	2.17	2.17	3.03	3.03			10.40 (3.40 - 12.10)	3.23 (0.87 - 4.19)	14.19	99
25+25+35+42	2.07	2.07	2.89	3.47			10.50 (3.40 - 12.20)	3.27 (0.87 - 4.24)	14.36	99
25+25+35+50	1.96	1.96	2.75	3.93			10.60 (3.40 - 12.30)	3.31 (0.87 - 4.28)	14.54	99
25+25+35+60	1.84	1.84	2.58	4.43			10.70 (3.40 - 12.40)	3.35 (0.87 - 4.33)	14.71	99
25+25+35+71	1.73	1.73	2.42	4.92			10.80 (3.40 - 12.50)	3.38 (0.87 - 4.40)	14.84	99
25+25+42+42	1.98	1.98	3.32	3.32			10.60 (3.40 - 12.30)	3.31 (0.87 - 4.28)	14.54	99
25+25+42+50	1.88	1.88	3.16	3.77			10.70 (3.40 - 12.40)	3.35 (0.87 - 4.33)	14.71	99
25+25+42+60	1.76	1.76	2.96	4.22			10.70 (3.40 - 12.40)	3.35 (0.87 - 4.33)	14.71	99
25+25+42+71	1.66	1.66	2.78	4.70			10.80 (3.40 - 12.50)	3.38 (0.87 - 4.40)	14.84	99
25+25+50+50	1.78	1.78	3.57	3.57			10.70 (3.40 - 12.40)	3.35 (0.87 - 4.33)	14.71	99
25+25+50+60	1.69	1.69	3.38	4.05			10.80 (3.40 - 12.50)	3.38 (0.87 - 4.40)	14.84	99

MXZ-6C120VA COOLING

Indoor units combination	Cooling capacity (kW)						Outdoor unit power consumption (kW)	Current (A)	Power factor (%)	
	Unit A	Unit B	Unit C	Unit D	Unit E	Unit F				
22+25+42+42	1.76	2.00	3.37	3.37			10.50 (3.40 - 12.30)	3.27 (0.87 - 4.28)	14.36	99
22+25+42+50	1.69	1.92	3.23	3.85			10.70 (3.40 - 12.40)	3.35 (0.87 - 4.33)	14.71	99
22+25+42+60	1.58	1.80	3.02	4.31			10.70 (3.40 - 12.40)	3.35 (0.87 - 4.33)	14.71	99
22+25+42+71	1.49	1.69	2.84	4.79			10.80 (3.40 - 12.50)	3.38 (0.87 - 4.40)	14.84	99
22+25+50+50	1.60	1.82	3.64	3.64			10.70 (3.40 - 12.40)	3.35 (0.87 - 4.33)	14.71	99
22+25+50+60	1.51	1.72	3.44	4.13			10.80 (3.40 - 12.50)	3.38 (0.87 - 4.40)	14.84	99
22+25+50+71	1.41	1.61	3.21	4.56			10.80 (3.40 - 12.50)	3.38 (0.87 - 4.40)	14.84	99
22+25+60+60	1.42	1.62	3.88	3.88			10.80 (3.40 - 12.50)	3.38 (0.87 - 4.40)	14.84	99
22+25+60+71	1.33	1.52	3.64	4.31			10.80 (3.40 - 12.50)	3.38 (0.87 - 4.40)	14.84	99
22+35+35+35	1.82	2.89	2.89	2.89			10.50 (3.40 - 12.20)	3.27 (0.87 - 4.24)	14.36	99
22+35+35+42	1.74	2.77	2.77	3.32			10.60 (3.40 - 12.30)	3.31 (0.87 - 4.28)	14.54	99
22+35+35+50	1.66	2.64	2.64	3.77			10.70 (3.40 - 12.40)	3.35 (0.87 - 4.33)	14.71	99
22+35+35+60	1.55	2.46	2.46	4.22			10.70 (3.40 - 12.40)	3.35 (0.87 - 4.33)	14.71	99
22+35+35+71	1.46	2.32	2.32	4.70			10.80 (3.40 - 12.50)	3.38 (0.87 - 4.40)	14.84	99
22+35+42+42	1.67	2.66	3.19	3.19			10.70 (3.40 - 12.40)	3.35 (0.87 - 4.33)	14.71	99
22+35+42+50	1.58	2.51	3.02	3.59			10.70 (3.40 - 12.40)	3.35 (0.87 - 4.33)	14.71	99
22+35+42+60	1.49	2.38	2.85	4.08			10.80 (3.40 - 12.50)	3.38 (0.87 - 4.40)	14.84	99
22+35+42+71	1.40	2.22	2.67	4.51			10.80 (3.40 - 12.50)	3.38 (0.87 - 4.40)	14.84	99
22+35+50+50	1.51	2.41	3.44	3.44			10.80 (3.40 - 12.50)	3.38 (0.87 - 4.40)	14.84	99
22+35+50+60	1.42	2.26	3.23	3.88			10.80 (3.40 - 12.50)	3.38 (0.87 - 4.40)	14.84	99
22+35+50+71	1.33	2.12	3.03	4.31			10.80 (3.40 - 12.50)	3.38 (0.87 - 4.40)	14.84	99
22+35+60+60	1.34	2.14	3.66	3.66			10.80 (3.40 - 12.50)	3.38 (0.87 - 4.40)	14.84	99
22+42+42+42	1.59	3.04	3.04	3.04			10.70 (3.40 - 12.40)	3.35 (0.87 - 4.33)	14.71	99
22+42+42+50	1.52	2.91	2.91	3.46			10.80 (3.40 - 12.50)	3.38 (0.87 - 4.40)	14.84	99
22+42+42+60	1.43	2.73	2.73	3.90			10.80 (3.40 - 12.50)	3.38 (0.87 - 4.40)	14.84	99
22+42+42+71	1.34	2.56	2.56	4.33			10.80 (3.40 - 12.50)	3.38 (0.87 - 4.40)	14.84	99
22+42+50+50	1.45	2.77	3.29	3.29			10.80 (3.40 - 12.50)	3.38 (0.87 - 4.40)	14.84	99
22+42+50+60	1.37	2.61	3.10	3.72			10.80 (3.40 - 12.50)	3.38 (0.87 - 4.40)	14.84	99
22+50+50+50	1.38	3.14	3.14	3.14			10.80 (3.40 - 12.50)	3.38 (0.87 - 4.40)	14.84	99
25+25+25+25	2.50	2.50	2.50	2.50			10.00 (3.30 - 11.80)	3.07 (0.87 - 4.05)	13.48	99
25+25+25+35	2.32	2.32	2.32	3.25			10.20 (3.30 - 12.00)	3.15 (0.87 - 4.14)	13.83	99
25+25+25+42	2.20	2.20	2.20	3.70			10.30 (3.30 - 12.10)	3.19 (0.87 - 4.19)	14.01	99
25+25+25+50	2.08	2.08	2.08	4.16			10.40 (3.40 - 12.20)	3.23 (0.87 - 4.24)	14.19	99
25+25+25+60	1.96	1.96	1.96	4.71			10.60 (3.40 - 12.30)	3.31 (0.87 - 4.28)	14.54	99
25+25+25+71	1.83	1.83	1.83	5.20			10.70 (3.40 - 12.40)	3.35 (0.87 - 4.33)	14.71	99
25+25+35+35	2.17	2.17	3.03	3.03			10.40 (3.40 - 12.10)	3.23 (0.87 - 4.19)	14.19	99
25+25+35+42	2.07	2.07	2.89	3.47			10.50 (3.40 - 12.20)	3.27 (0.87 - 4.24)	14.36	99
25+25+35+50	1.96	1.96	2.75	3.93			10.60 (3.40 - 12.30)	3.31 (0.87 - 4.28)	14.54	99
25+25+35+60	1.84	1.84	2.58	4.43			10.70 (3.40 - 12.40)	3.35 (0.87 - 4.33)	14.71	99
25+25+35+71	1.73	1.73	2.42	4.92			10.80 (3.40 - 12.50)	3.38 (0.87 - 4.40)	14.84	99
25+25+42+42	1.98	1.98	3.32	3.32			10.60 (3.40 - 12.30)	3.31 (0.87 - 4.28)	14.54	99
25+25+42+50	1.88	1.88	3.16	3.77			10.70 (3.40 - 12.40)	3.35 (0.87 - 4.33)	14.71	99
25+25+42+60	1.76	1.76	2.96	4.22			10.70 (3.40 - 12.40)	3.35 (0.87 - 4.33)	14.71	99
25+25+42+71	1.66	1.66	2.78	4.70			10.80 (3.40 - 12.50)	3.38 (0.87 - 4.40)	14.84	99
25+25+50+50	1.78	1.78	3.57	3.57			10.70 (3.40 - 12.40)	3.35 (0.87 - 4.33)	14.71	99
25+25+50+60	1.69	1.69	3.38	4.05			10.80 (3.40 - 12.50)	3.38 (0.87 - 4.40)	14.84	99

MXZ-6C120VA COOLING

Indoor units combination	Cooling capacity (kW)						Outdoor unit power consumption (kW)	Current (A)	Power factor (%)	
	Unit A	Unit B	Unit C	Unit D	Unit E	Unit F				
15+15+15+20+20	1.50	1.50	1.50	2.00	2.00		8.50 (3.30 - 11.00)	2.34 (0.93 - 5.13)	10.28	99
15+15+15+20+22	1.50	1.50	1.50	2.00	2.20		8.70 (3.30 - 11.10)	2.44 (0.93 - 5.17)	10.72	99
15+15+15+20+25	1.50	1.50	1.50	2.00	2.50		9.00 (3.30 - 11.30)	2.60 (0.93 - 5.26)	11.42	99
15+15+15+20+35	1.50	1.50	1.50	2.00	3.50		10.00 (3.30 - 11.80)	3.14 (0.93 - 5.48)	13.79	99
15+15+15+20+42	1.50	1.50	1.50	2.00	4.20		10.70 (3.40 - 12.80)	3.29 (0.90 - 5.72)	14.45	99
15+15+15+20+50	1.47	1.47	1.47	1.97	4.91		11.30 (3.50 - 13.20)	3.53 (0.89 - 5.79)	15.50	99
15+15+15+20+60	1.43	1.43	1.43	1.90	5.71		11.90 (3.50 - 13.20)	3.89 (0.89 - 5.76)	17.08	99
15+15+15+20+71	1.32	1.32	1.32	1.76	6.26		12.00 (3.50 - 13.30)	3.94 (0.89 - 5.78)	17.30	99
15+15+15+22+22	1.50	1.50	1.50	2.20	2.20		8.90 (3.30 - 11.20)	2.55 (0.93 - 5.22)	11.20	99
15+15+15+22+25	1.50	1.50	1.50	2.20	2.50		9.20 (3.30 - 11.40)	2.71 (0.93 - 5.30)	11.90	99
15+15+15+22+35	1.50	1.50	1.50	2.20	3.50		10.20 (3.30 - 12.10)	3.18 (0.92 - 5.55)	13.97	99
15+15+15+22+42	1.50	1.50	1.50	2.20	4.20		10.90 (3.50 - 13.10)	3.33 (0.89 - 5.79)	14.62	99
15+15+15+22+50	1.46	1.46	1.46	2.14	4.87		11.40 (3.50 - 13.20)	3.59 (0.89 - 5.79)	15.77	99
15+15+15+22+60	1.41	1.41	1.41	2.06	5.62		11.90 (3.50 - 13.20)	3.89 (0.89 - 5.76)	17.08	99
15+15+15+22+71	1.30	1.30	1.30	1.91	6.17		12.00 (3.50 - 13.30)	3.94 (0.89 - 5.78)	17.30	99
15+15+15+25+25	1.50	1.50	1.50	2.50	2.50		9.50 (3.30 - 11.50)	2.87 (0.93 - 5.35)	12.60	99
15+15+15+25+35	1.50	1.50	1.50	2.50	3.50		10.50 (3.40 - 12.50)	3.25 (0.91 - 5.65)	14.27	99
15+15+15+25+42	1.49	1.49	1.49	2.48	4.16		11.10 (3.50 - 13.20)	3.41 (0.89 - 5.80)	14.98	99
15+15+15+25+50	1.45	1.45	1.45	2.42	4.83		11.60 (3.50 - 13.20)	3.71 (0.89 - 5.78)	16.29	99
15+15+15+25+60	1.37	1.37	1.37	2.29	5.49		11.90 (3.50 - 13.20)	3.89 (0.89 - 5.76)	17.08	99
15+15+15+25+71	1.28	1.28	1.28	2.13	6.04		12.00 (3.50 - 13.30)	3.94 (0.89 - 5.78)	17.30	99
15+15+15+35+35	1.47	1.47	1.47	3.44	3.44		11.30 (3.50 - 13.20)	3.53 (0.89 - 5.79)	15.50	99
15+15+15+35+42	1.44	1.44	1.44	3.36	4.03		11.70 (3.50 - 13.20)	3.77 (0.89 - 5.77)	16.56	99
15+15+15+35+50	1.37	1.37	1.37	3.20	4.58		11.90 (3.50 - 13.20)	3.89 (0.89 - 5.76)	17.08	99
15+15+15+35+60	1.29	1.29	1.29	3.00	5.14		12.00 (3.50 - 13.30)	3.94 (0.89 - 5.78)	17.30	99
15+15+15+35+71	1.20	1.20	1.20	2.80	5.69		12.10 (3.50 - 13.30)	3.98 (0.89 - 5.78)	17.48	99
15+15+15+42+42	1.38	1.38	1.38	3.87	3.87		11.90 (3.50 - 13.20)	3.89 (0.89 - 5.76)	17.08	99
15+15+15+42+50	1.31	1.31	1.31	3.68	4.38		12.00 (3.50 - 13.30)	3.94 (0.89 - 5.78)	17.30	99
15+15+15+42+60	1.22	1.22	1.22	3.43	4.90		12.00 (3.50 - 13.30)	3.94 (0.89 - 5.78)	17.30	99
15+15+15+42+71	1.15	1.15	1.15	3.22	5.44		12.10 (3.50 - 13.30)	3.98 (0.89 - 5.78)	17.48	99
15+15+15+50+50	1.24	1.24	1.24	4.14	4.14		12.00 (3.50 - 13.30)	3.94 (0.89 - 5.78)	17.30	99
15+15+15+50+60	1.17	1.17	1.17	3.90	4.68		12.10 (3.50 - 13.30)	3.98 (0.89 - 5.78)	17.48	99
15+15+15+50+71	1.09	1.09	1.09	3.64	5.18		12.10 (3.50 - 13.30)	3.98 (0.89 - 5.78)	17.48	99
15+15+15+60+60	1.10	1.10	1.10	4.40	4.40		12.10 (3.50 - 13.30)	3.98 (0.89 - 5.78)	17.48	99
15+15+15+60+71	1.04	1.04	1.04	4.16	4.92		12.20 (3.50 - 13.40)	4.03 (0.89 - 5.79)	17.70	99
15+15+20+20+20	1.50	1.50	2.00	2.00	2.00		9.00 (3.30 - 11.30)	2.60 (0.93 - 5.26)	11.42	99
15+15+20+20+22	1.50	1.50	2.00	2.00	2.20		9.20 (3.30 - 11.40)	2.71 (0.93 - 5.30)	11.90	99
15+15+20+20+25	1.50	1.50	2.00	2.00	2.50		9.50 (3.30 - 11.50)	2.87 (0.93 - 5.35)	12.60	99
15+15+20+20+35	1.50	1.50	2.00	2.00	3.50		10.50 (3.40 - 12.50)	3.25 (0.91 - 5.65)	14.27	99
15+15+20+20+42	1.49	1.49	1.98	1.98	4.16		11.10 (3.50 - 13.20)	3.41 (0.89 - 5.80)	14.98	99
15+15+20+20+50	1.45	1.45	1.93	1.93	4.83		11.60 (3.50 - 13.20)	3.71 (0.89 - 5.78)	16.29	99
15+15+20+20+60	1.37	1.37	1.83	1.83	5.49		11.90 (3.50 - 13.20)	3.89 (0.89 - 5.76)	17.08	99
15+15+20+20+71	1.28	1.28	1.70	1.70	6.04		12.00 (3.50 - 13.30)	3.94 (0.89 - 5.78)	17.30	99
15+15+20+22+22	1.50	1.50	2.00	2.20	2.20		9.40 (3.30 - 11.50)	2.82 (0.93 - 5.35)	12.38	99
15+15+20+22+25	1.50	1.50	2.00	2.20	2.50		9.70 (3.30 - 11.60)	2.98 (0.93 - 5.39)	13.09	99
15+15+20+22+35	1.50	1.50	2.00	2.20	3.50		10.70 (3.40 - 12.80)	3.29 (0.90 - 5.72)	14.45	99

MXZ-6C120VA COOLING

Indoor units combination	Cooling capacity (kW)						Outdoor unit power consumption (kW)	Current (A)	Power factor (%)	
	Unit A	Unit B	Unit C	Unit D	Unit E	Unit F				
15+15+20+22+42	1.47	1.47	1.96	2.16	4.13		11.20 (3.50 - 13.20)	3.47 (0.89 - 5.80)	15.24	99
15+15+20+22+50	1.44	1.44	1.92	2.11	4.80		11.70 (3.50 - 13.20)	3.77 (0.89 - 5.77)	16.56	99
15+15+20+22+60	1.35	1.35	1.80	1.98	5.41		11.90 (3.50 - 13.20)	3.89 (0.89 - 5.76)	17.08	99
15+15+20+22+71	1.26	1.26	1.68	1.85	5.96		12.00 (3.50 - 13.30)	3.94 (0.89 - 5.78)	17.30	99
15+15+20+25+25	1.50	1.50	2.00	2.50	2.50		10.00 (3.30 - 11.80)	3.14 (0.93 - 5.48)	13.79	99
15+15+20+25+35	1.50	1.50	2.00	2.50	3.50		11.00 (3.50 - 13.20)	3.35 (0.89 - 5.81)	14.71	99
15+15+20+25+42	1.46	1.46	1.95	2.44	4.09		11.40 (3.50 - 13.20)	3.59 (0.89 - 5.79)	15.77	99
15+15+20+25+50	1.43	1.43	1.90	2.38	4.76		11.90 (3.50 - 13.20)	3.89 (0.89 - 5.76)	17.08	99
15+15+20+25+60	1.33	1.33	1.78	2.22	5.33		12.00 (3.50 - 13.30)	3.94 (0.89 - 5.78)	17.30	99
15+15+20+25+71	1.23	1.23	1.64	2.05	5.84		12.00 (3.50 - 13.30)	3.94 (0.89 - 5.78)	17.30	99
15+15+20+35+35	1.45	1.45	1.93	3.38	3.38		11.60 (3.50 - 13.20)	3.71 (0.89 - 5.78)	16.29	99
15+15+20+35+42	1.41	1.41	1.87	3.28	3.94		11.90 (3.50 - 13.20)	3.89 (0.89 - 5.76)	17.08	99
15+15+20+35+50	1.33	1.33	1.78	3.11	4.44		12.00 (3.50 - 13.30)	3.94 (0.89 - 5.78)	17.30	99
15+15+20+35+60	1.24	1.24	1.66	2.90	4.97		12.00 (3.50 - 13.30)	3.94 (0.89 - 5.78)	17.30	99
15+15+20+35+71	1.16	1.16	1.55	2.71	5.51		12.10 (3.50 - 13.30)	3.98 (0.89 - 5.78)	17.48	99
15+15+20+42+42	1.34	1.34	1.79	3.76	3.76		12.00 (3.50 - 13.30)	3.94 (0.89 - 5.78)	17.30	99
15+15+20+42+50	1.27	1.27	1.69	3.55	4.23		12.00 (3.50 - 13.30)	3.94 (0.89 - 5.78)	17.30	99
15+15+20+42+60	1.19	1.19	1.59	3.34	4.78		12.10 (3.50 - 13.30)	3.98 (0.89 - 5.78)	17.48	99
15+15+20+42+71	1.11	1.11	1.48	3.12	5.27		12.10 (3.50 - 13.30)	3.98 (0.89 - 5.78)	17.48	99
15+15+20+50+50	1.21	1.21	1.61	4.03	4.03		12.10 (3.50 - 13.30)	3.98 (0.89 - 5.78)	17.48	99
15+15+20+50+60	1.13	1.13	1.51	3.78	4.54		12.10 (3.50 - 13.30)	3.98 (0.89 - 5.78)	17.48	99
15+15+20+50+71	1.07	1.07	1.43	3.57	5.07		12.20 (3.50 - 13.40)	4.03 (0.89 - 5.79)	17.70	99
15+15+20+60+60	1.08	1.08	1.44	4.31	4.31		12.20 (3.50 - 13.40)	4.03 (0.89 - 5.79)	17.70	99
15+15+22+22+22	1.50	1.50	2.20	2.20	2.20		9.60 (3.30 - 11.60)	2.93 (0.93 - 5.39)	12.87	99
15+15+22+22+25	1.50	1.50	2.20	2.20	2.50		9.90 (3.30 - 11.70)	3.09 (0.93 - 5.44)	13.57	99
15+15+22+22+35	1.50	1.50	2.20	2.20	3.50		10.90 (3.50 - 13.10)	3.33 (0.89 - 5.79)	14.62	99
15+15+22+22+42	1.47	1.47	2.16	2.16	4.13		11.40 (3.50 - 13.20)	3.59 (0.89 - 5.79)	15.77	99
15+15+22+22+50	1.43	1.43	2.09	2.09	4.76		11.80 (3.50 - 13.20)	3.83 (0.89 - 5.76)	16.82	99
15+15+22+22+60	1.34	1.34	1.97	1.97	5.37		12.00 (3.50 - 13.30)	3.94 (0.89 - 5.78)	17.30	99
15+15+22+22+71	1.24	1.24	1.82	1.82	5.88		12.00 (3.50 - 13.30)	3.94 (0.89 - 5.78)	17.30	99
15+15+22+25+25	1.50	1.50	2.20	2.50	2.50		10.20 (3.30 - 12.10)	3.18 (0.92 - 5.55)	13.97	99
15+15+22+25+35	1.49	1.49	2.18	2.48	3.47		11.10 (3.50 - 13.20)	3.41 (0.89 - 5.80)	14.98	99
15+15+22+25+42	1.45	1.45	2.13	2.42	4.06		11.50 (3.50 - 13.20)	3.65 (0.89 - 5.78)	16.03	99
15+15+22+25+50	1.41	1.41	2.06	2.34	4.69		11.90 (3.50 - 13.20)	3.89 (0.89 - 5.76)	17.08	99
15+15+22+25+60	1.31	1.31	1.93	2.19	5.26		12.00 (3.50 - 13.30)	3.94 (0.89 - 5.78)	17.30	99
15+15+22+25+71	1.22	1.22	1.78	2.03	5.76		12.00 (3.50 - 13.30)	3.94 (0.89 - 5.78)	17.30	99
15+15+22+35+35	1.44	1.44	2.11	3.36	3.36		11.70 (3.50 - 13.20)	3.77 (0.89 - 5.77)	16.56	99
15+15+22+35+42	1.38	1.38	2.03	3.23	3.87		11.90 (3.50 - 13.20)	3.89 (0.89 - 5.76)	17.08	99
15+15+22+35+50	1.31	1.31	1.93	3.07	4.38		12.00 (3.50 - 13.30)	3.94 (0.89 - 5.78)	17.30	99
15+15+22+35+60	1.22	1.22	1.80	2.86	4.90		12.00 (3.50 - 13.30)	3.94 (0.89 - 5.78)	17.30	99
15+15+22+35+71	1.15	1.15	1.68	2.68	5.44		12.10 (3.50 - 13.30)	3.98 (0.89 - 5.78)	17.48	99
15+15+22+42+42	1.32	1.32	1.94	3.71	3.71		12.00 (3.50 - 13.30)	3.94 (0.89 - 5.78)	17.30	99
15+15+22+42+50	1.25	1.25	1.83	3.50	4.17		12.00 (3.50 - 13.30)	3.94 (0.89 - 5.78)	17.30	99
15+15+22+42+60	1.18	1.18	1.73	3.30	4.71		12.10 (3.50 - 13.30)	3.98 (0.89 - 5.78)	17.48	99
15+15+22+42+71	1.10	1.10	1.61	3.08	5.21		12.10 (3.50 - 13.30)	3.98 (0.89 - 5.78)	17.48	99
15+15+22+50+50	1.19	1.19	1.75	3.98	3.98		12.10 (3.50 - 13.30)	3.98 (0.89 - 5.78)	17.48	99

MXZ-6C120VA COOLING

Indoor units combination	Cooling capacity (kW)						Outdoor unit power consumption (kW)	Current (A)	Power factor (%)
	Unit A	Unit B	Unit C	Unit D	Unit E	Unit F			
15+15+22+50+60	1.12	1.12	1.64	3.73	4.48		12.10 (3.50 - 13.30)	3.98 (0.89 - 5.78)	17.48 99
15+15+22+50+71	1.06	1.06	1.55	3.53	5.01		12.20 (3.50 - 13.40)	4.03 (0.89 - 5.79)	17.70 99
15+15+22+60+60	1.06	1.06	1.56	4.26	4.26		12.20 (3.50 - 13.40)	4.03 (0.89 - 5.79)	17.70 99
15+15+25+25+25	1.50	1.50	2.50	2.50	2.50		10.50 (3.40 - 12.50)	3.25 (0.91 - 5.65)	14.27 99
15+15+25+25+35	1.47	1.47	2.46	2.46	3.44		11.30 (3.50 - 13.20)	3.53 (0.89 - 5.79)	15.50 99
15+15+25+25+42	1.44	1.44	2.40	2.40	4.03		11.70 (3.50 - 13.20)	3.77 (0.89 - 5.77)	16.56 99
15+15+25+25+50	1.37	1.37	2.29	2.29	4.58		11.90 (3.50 - 13.20)	3.89 (0.89 - 5.76)	17.08 99
15+15+25+25+60	1.29	1.29	2.14	2.14	5.14		12.00 (3.50 - 13.30)	3.94 (0.89 - 5.78)	17.30 99
15+15+25+25+71	1.20	1.20	2.00	2.00	5.69		12.10 (3.50 - 13.30)	3.98 (0.89 - 5.78)	17.48 99
15+15+25+35+35	1.43	1.43	2.38	3.33	3.33		11.90 (3.50 - 13.20)	3.89 (0.89 - 5.76)	17.08 99
15+15+25+35+42	1.35	1.35	2.25	3.16	3.79		11.90 (3.50 - 13.20)	3.89 (0.89 - 5.76)	17.08 99
15+15+25+35+50	1.29	1.29	2.14	3.00	4.29		12.00 (3.50 - 13.30)	3.94 (0.89 - 5.78)	17.30 99
15+15+25+35+60	1.21	1.21	2.02	2.82	4.84		12.10 (3.50 - 13.30)	3.98 (0.89 - 5.78)	17.48 99
15+15+25+35+71	1.13	1.13	1.88	2.63	5.34		12.10 (3.50 - 13.30)	3.98 (0.89 - 5.78)	17.48 99
15+15+25+42+42	1.29	1.29	2.16	3.63	3.63		12.00 (3.50 - 13.30)	3.94 (0.89 - 5.78)	17.30 99
15+15+25+42+50	1.22	1.22	2.04	3.43	4.08		12.00 (3.50 - 13.30)	3.94 (0.89 - 5.78)	17.30 99
15+15+25+42+60	1.16	1.16	1.93	3.24	4.62		12.10 (3.50 - 13.30)	3.98 (0.89 - 5.78)	17.48 99
15+15+25+42+71	1.09	1.09	1.82	3.05	5.16		12.20 (3.50 - 13.40)	4.03 (0.89 - 5.79)	17.70 99
15+15+25+50+50	1.17	1.17	1.95	3.90	3.90		12.10 (3.50 - 13.30)	3.98 (0.89 - 5.78)	17.48 99
15+15+25+50+60	1.10	1.10	1.83	3.67	4.40		12.10 (3.50 - 13.30)	3.98 (0.89 - 5.78)	17.48 99
15+15+25+50+71	1.04	1.04	1.73	3.47	4.92		12.20 (3.50 - 13.40)	4.03 (0.89 - 5.79)	17.70 99
15+15+25+60+60	1.05	1.05	1.74	4.18	4.18		12.20 (3.50 - 13.40)	4.03 (0.89 - 5.79)	17.70 99
15+15+35+35+35	1.33	1.33	3.11	3.11	3.11		12.00 (3.50 - 13.30)	3.94 (0.89 - 5.78)	17.30 99
15+15+35+35+42	1.27	1.27	2.96	2.96	3.55		12.00 (3.50 - 13.30)	3.94 (0.89 - 5.78)	17.30 99
15+15+35+35+50	1.21	1.21	2.82	2.82	4.03		12.10 (3.50 - 13.30)	3.98 (0.89 - 5.78)	17.48 99
15+15+35+35+60	1.13	1.13	2.65	2.65	4.54		12.10 (3.50 - 13.30)	3.98 (0.89 - 5.78)	17.48 99
15+15+35+35+71	1.07	1.07	2.50	2.50	5.07		12.20 (3.50 - 13.40)	4.03 (0.89 - 5.79)	17.70 99
15+15+35+42+42	1.21	1.21	2.82	3.38	3.38		12.00 (3.50 - 13.30)	3.94 (0.89 - 5.78)	17.30 99
15+15+35+42+50	1.16	1.16	2.70	3.24	3.85		12.10 (3.50 - 13.30)	3.98 (0.89 - 5.78)	17.48 99
15+15+35+42+60	1.10	1.10	2.56	3.07	4.38		12.20 (3.50 - 13.40)	4.03 (0.89 - 5.79)	17.70 99
15+15+35+42+71	1.03	1.03	2.40	2.88	4.87		12.20 (3.50 - 13.40)	4.03 (0.89 - 5.79)	17.70 99
15+15+35+50+50	1.10	1.10	2.57	3.67	3.67		12.10 (3.50 - 13.30)	3.98 (0.89 - 5.78)	17.48 99
15+15+35+50+60	1.05	1.05	2.44	3.49	4.18		12.20 (3.50 - 13.40)	4.03 (0.89 - 5.79)	17.70 99
15+15+42+42+42	1.16	1.16	3.26	3.26	3.26		12.10 (3.50 - 13.30)	3.98 (0.89 - 5.78)	17.48 99
15+15+42+42+50	1.11	1.11	3.10	3.10	3.69		12.10 (3.50 - 13.30)	3.98 (0.89 - 5.78)	17.48 99
15+15+42+42+60	1.05	1.05	2.94	2.94	4.21		12.20 (3.50 - 13.40)	4.03 (0.89 - 5.79)	17.70 99
15+15+42+50+50	1.06	1.06	2.98	3.55	3.55		12.20 (3.50 - 13.40)	4.03 (0.89 - 5.79)	17.70 99
15+15+50+50+50	1.02	1.02	3.39	3.39	3.39		12.20 (3.50 - 13.40)	4.03 (0.89 - 5.79)	17.70 99
15+20+20+20+20	1.50	2.00	2.00	2.00	2.00		9.50 (3.30 - 11.50)	2.87 (0.93 - 5.35)	12.60 99
15+20+20+20+22	1.50	2.00	2.00	2.00	2.20		9.70 (3.30 - 11.60)	2.98 (0.93 - 5.39)	13.09 99
15+20+20+20+25	1.50	2.00	2.00	2.00	2.50		10.00 (3.30 - 11.80)	3.14 (0.93 - 5.48)	13.79 99
15+20+20+20+35	1.50	2.00	2.00	2.00	3.50		11.00 (3.50 - 13.20)	3.35 (0.89 - 5.81)	14.71 99
15+20+20+20+42	1.46	1.95	1.95	1.95	4.09		11.40 (3.50 - 13.20)	3.59 (0.89 - 5.79)	15.77 99
15+20+20+20+50	1.43	1.90	1.90	1.90	4.76		11.90 (3.50 - 13.20)	3.89 (0.89 - 5.76)	17.08 99
15+20+20+20+60	1.33	1.78	1.78	1.78	5.33		12.00 (3.50 - 13.30)	3.94 (0.89 - 5.78)	17.30 99
15+20+20+20+71	1.23	1.64	1.64	1.64	5.84		12.00 (3.50 - 13.30)	3.94 (0.89 - 5.78)	17.30 99

MXZ-6C120VA COOLING

Indoor units combination	Cooling capacity (kW)						Outdoor unit power consumption (kW)	Current (A)	Power factor (%)	
	Unit A	Unit B	Unit C	Unit D	Unit E	Unit F				
15+20+20+22+22	1.50	2.00	2.00	2.20	2.20		9.90 (3.30 - 11.70)	3.09 (0.93 - 5.44)	13.57	99
15+20+20+22+25	1.50	2.00	2.00	2.20	2.50		10.20 (3.30 - 12.10)	3.18 (0.92 - 5.55)	13.97	99
15+20+20+22+35	1.49	1.98	1.98	2.18	3.47		11.10 (3.50 - 13.20)	3.41 (0.89 - 5.80)	14.98	99
15+20+20+22+42	1.45	1.93	1.93	2.13	4.06		11.50 (3.50 - 13.20)	3.65 (0.89 - 5.78)	16.03	99
15+20+20+22+50	1.41	1.87	1.87	2.06	4.69		11.90 (3.50 - 13.20)	3.89 (0.89 - 5.76)	17.08	99
15+20+20+22+60	1.31	1.75	1.75	1.93	5.26		12.00 (3.50 - 13.30)	3.94 (0.89 - 5.78)	17.30	99
15+20+20+22+71	1.22	1.62	1.62	1.78	5.76		12.00 (3.50 - 13.30)	3.94 (0.89 - 5.78)	17.30	99
15+20+20+25+25	1.50	2.00	2.00	2.50	2.50		10.50 (3.40 - 12.50)	3.25 (0.91 - 5.65)	14.27	99
15+20+20+25+35	1.47	1.97	1.97	2.46	3.44		11.30 (3.50 - 13.20)	3.53 (0.89 - 5.79)	15.50	99
15+20+20+25+42	1.44	1.92	1.92	2.40	4.03		11.70 (3.50 - 13.20)	3.77 (0.89 - 5.77)	16.56	99
15+20+20+25+50	1.37	1.83	1.83	2.29	4.58		11.90 (3.50 - 13.20)	3.89 (0.89 - 5.76)	17.08	99
15+20+20+25+60	1.29	1.71	1.71	2.14	5.14		12.00 (3.50 - 13.30)	3.94 (0.89 - 5.78)	17.30	99
15+20+20+25+71	1.20	1.60	1.60	2.00	5.69		12.10 (3.50 - 13.30)	3.98 (0.89 - 5.78)	17.48	99
15+20+20+35+35	1.43	1.90	1.90	3.33	3.33		11.90 (3.50 - 13.20)	3.89 (0.89 - 5.76)	17.08	99
15+20+20+35+42	1.35	1.80	1.80	3.16	3.79		11.90 (3.50 - 13.20)	3.89 (0.89 - 5.76)	17.08	99
15+20+20+35+50	1.29	1.71	1.71	3.00	4.29		12.00 (3.50 - 13.30)	3.94 (0.89 - 5.78)	17.30	99
15+20+20+35+60	1.21	1.61	1.61	2.82	4.84		12.10 (3.50 - 13.30)	3.98 (0.89 - 5.78)	17.48	99
15+20+20+35+71	1.13	1.50	1.50	2.63	5.34		12.10 (3.50 - 13.30)	3.98 (0.89 - 5.78)	17.48	99
15+20+20+42+42	1.29	1.73	1.73	3.63	3.63		12.00 (3.50 - 13.30)	3.94 (0.89 - 5.78)	17.30	99
15+20+20+42+50	1.22	1.63	1.63	3.43	4.08		12.00 (3.50 - 13.30)	3.94 (0.89 - 5.78)	17.30	99
15+20+20+42+60	1.16	1.54	1.54	3.24	4.62		12.10 (3.50 - 13.30)	3.98 (0.89 - 5.78)	17.48	99
15+20+20+42+71	1.09	1.45	1.45	3.05	5.16		12.20 (3.50 - 13.40)	4.03 (0.89 - 5.79)	17.70	99
15+20+20+50+50	1.17	1.56	1.56	3.90	3.90		12.10 (3.50 - 13.30)	3.98 (0.89 - 5.78)	17.48	99
15+20+20+50+60	1.10	1.47	1.47	3.67	4.40		12.10 (3.50 - 13.30)	3.98 (0.89 - 5.78)	17.48	99
15+20+20+50+71	1.04	1.39	1.39	3.47	4.92		12.20 (3.50 - 13.40)	4.03 (0.89 - 5.79)	17.70	99
15+20+20+60+60	1.05	1.39	1.39	4.18	4.18		12.20 (3.50 - 13.40)	4.03 (0.89 - 5.79)	17.70	99
15+20+22+22+22	1.50	2.00	2.20	2.20	2.20		10.10 (3.30 - 11.90)	3.16 (0.93 - 5.50)	13.88	99
15+20+22+22+25	1.50	2.00	2.20	2.20	2.50		10.40 (3.40 - 12.40)	3.22 (0.91 - 5.62)	14.14	99
15+20+22+22+35	1.47	1.96	2.16	2.16	3.44		11.20 (3.50 - 13.20)	3.47 (0.89 - 5.80)	15.24	99
15+20+22+22+42	1.45	1.93	2.13	2.13	4.06		11.70 (3.50 - 13.20)	3.77 (0.89 - 5.77)	16.56	99
15+20+22+22+50	1.38	1.84	2.03	2.03	4.61		11.90 (3.50 - 13.20)	3.89 (0.89 - 5.76)	17.08	99
15+20+22+22+60	1.29	1.73	1.90	1.90	5.18		12.00 (3.50 - 13.30)	3.94 (0.89 - 5.78)	17.30	99
15+20+22+22+71	1.21	1.61	1.77	1.77	5.73		12.10 (3.50 - 13.30)	3.98 (0.89 - 5.78)	17.48	99
15+20+22+25+25	1.50	2.00	2.20	2.50	2.50		10.70 (3.40 - 12.80)	3.29 (0.90 - 5.72)	14.45	99
15+20+22+25+35	1.46	1.95	2.14	2.44	3.41		11.40 (3.50 - 13.20)	3.59 (0.89 - 5.79)	15.77	99
15+20+22+25+42	1.43	1.90	2.09	2.38	4.00		11.80 (3.50 - 13.20)	3.83 (0.89 - 5.76)	16.82	99
15+20+22+25+50	1.35	1.80	1.98	2.25	4.51		11.90 (3.50 - 13.20)	3.89 (0.89 - 5.76)	17.08	99
15+20+22+25+60	1.27	1.69	1.86	2.11	5.07		12.00 (3.50 - 13.30)	3.94 (0.89 - 5.78)	17.30	99
15+20+22+25+71	1.19	1.58	1.74	1.98	5.62		12.10 (3.50 - 13.30)	3.98 (0.89 - 5.78)	17.48	99
15+20+22+35+35	1.41	1.87	2.06	3.28	3.28		11.90 (3.50 - 13.20)	3.89 (0.89 - 5.76)	17.08	99
15+20+22+35+42	1.34	1.79	1.97	3.13	3.76		12.00 (3.50 - 13.30)	3.94 (0.89 - 5.78)	17.30	99
15+20+22+35+50	1.27	1.69	1.86	2.96	4.23		12.00 (3.50 - 13.30)	3.94 (0.89 - 5.78)	17.30	99
15+20+22+35+60	1.19	1.59	1.75	2.79	4.78		12.10 (3.50 - 13.30)	3.98 (0.89 - 5.78)	17.48	99
15+20+22+35+71	1.11	1.48	1.63	2.60	5.27		12.10 (3.50 - 13.30)	3.98 (0.89 - 5.78)	17.48	99
15+20+22+42+42	1.28	1.70	1.87	3.57	3.57		12.00 (3.50 - 13.30)	3.94 (0.89 - 5.78)	17.30	99
15+20+22+42+50	1.21	1.61	1.77	3.38	4.03		12.00 (3.50 - 13.30)	3.94 (0.89 - 5.78)	17.30	99

MXZ-6C120VA COOLING

Indoor units combination	Cooling capacity (kW)						Outdoor unit power consumption (kW)	Current (A)	Power factor (%)
	Unit A	Unit B	Unit C	Unit D	Unit E	Unit F			
15+20+22+42+60	1.14	1.52	1.67	3.20	4.57		12.10 (3.50 - 13.30)	3.98 (0.89 - 5.78)	17.48 99
15+20+22+42+71	1.08	1.44	1.58	3.01	5.10		12.20 (3.50 - 13.40)	4.03 (0.89 - 5.79)	17.70 99
15+20+22+50+50	1.16	1.54	1.70	3.85	3.85		12.10 (3.50 - 13.30)	3.98 (0.89 - 5.78)	17.48 99
15+20+22+50+60	1.10	1.46	1.61	3.65	4.38		12.20 (3.50 - 13.40)	4.03 (0.89 - 5.79)	17.70 99
15+20+22+50+71	1.03	1.37	1.51	3.43	4.87		12.20 (3.50 - 13.40)	4.03 (0.89 - 5.79)	17.70 99
15+20+22+60+60	1.03	1.38	1.52	4.14	4.14		12.20 (3.50 - 13.40)	4.03 (0.89 - 5.79)	17.70 99
15+20+25+25+25	1.50	2.00	2.50	2.50	2.50		11.00 (3.50 - 13.20)	3.35 (0.89 - 5.81)	14.71 99
15+20+25+25+35	1.45	1.93	2.42	2.42	3.38		11.60 (3.50 - 13.20)	3.71 (0.89 - 5.78)	16.29 99
15+20+25+25+42	1.41	1.87	2.34	2.34	3.94		11.90 (3.50 - 13.20)	3.89 (0.89 - 5.76)	17.08 99
15+20+25+25+50	1.33	1.78	2.22	2.22	4.44		12.00 (3.50 - 13.30)	3.94 (0.89 - 5.78)	17.30 99
15+20+25+25+60	1.24	1.66	2.07	2.07	4.97		12.00 (3.50 - 13.30)	3.94 (0.89 - 5.78)	17.30 99
15+20+25+25+71	1.16	1.55	1.94	1.94	5.51		12.10 (3.50 - 13.30)	3.98 (0.89 - 5.78)	17.48 99
15+20+25+35+35	1.37	1.83	2.29	3.20	3.20		11.90 (3.50 - 13.20)	3.89 (0.89 - 5.76)	17.08 99
15+20+25+35+42	1.31	1.75	2.19	3.07	3.68		12.00 (3.50 - 13.30)	3.94 (0.89 - 5.78)	17.30 99
15+20+25+35+50	1.24	1.66	2.07	2.90	4.14		12.00 (3.50 - 13.30)	3.94 (0.89 - 5.78)	17.30 99
15+20+25+35+60	1.17	1.56	1.95	2.73	4.68		12.10 (3.50 - 13.30)	3.98 (0.89 - 5.78)	17.48 99
15+20+25+35+71	1.09	1.46	1.82	2.55	5.18		12.10 (3.50 - 13.30)	3.98 (0.89 - 5.78)	17.48 99
15+20+25+42+42	1.25	1.67	2.08	3.50	3.50		12.00 (3.50 - 13.30)	3.94 (0.89 - 5.78)	17.30 99
15+20+25+42+50	1.19	1.59	1.99	3.34	3.98		12.10 (3.50 - 13.30)	3.98 (0.89 - 5.78)	17.48 99
15+20+25+42+60	1.12	1.49	1.87	3.14	4.48		12.10 (3.50 - 13.30)	3.98 (0.89 - 5.78)	17.48 99
15+20+25+42+71	1.06	1.41	1.76	2.96	5.01		12.20 (3.50 - 13.40)	4.03 (0.89 - 5.79)	17.70 99
15+20+25+50+50	1.13	1.51	1.89	3.78	3.78		12.10 (3.50 - 13.30)	3.98 (0.89 - 5.78)	17.48 99
15+20+25+50+60	1.08	1.44	1.79	3.59	4.31		12.20 (3.50 - 13.40)	4.03 (0.89 - 5.79)	17.70 99
15+20+25+60+60	1.02	1.36	1.69	4.07	4.07		12.20 (3.50 - 13.40)	4.03 (0.89 - 5.79)	17.70 99
15+20+35+35+35	1.29	1.71	3.00	3.00	3.00		12.00 (3.50 - 13.30)	3.94 (0.89 - 5.78)	17.30 99
15+20+35+35+42	1.22	1.63	2.86	2.86	3.43		12.00 (3.50 - 13.30)	3.94 (0.89 - 5.78)	17.30 99
15+20+35+35+50	1.17	1.56	2.73	2.73	3.90		12.10 (3.50 - 13.30)	3.98 (0.89 - 5.78)	17.48 99
15+20+35+35+60	1.10	1.47	2.57	2.57	4.40		12.10 (3.50 - 13.30)	3.98 (0.89 - 5.78)	17.48 99
15+20+35+35+71	1.04	1.39	2.43	2.43	4.92		12.20 (3.50 - 13.40)	4.03 (0.89 - 5.79)	17.70 99
15+20+35+42+42	1.18	1.57	2.75	3.30	3.30		12.10 (3.50 - 13.30)	3.98 (0.89 - 5.78)	17.48 99
15+20+35+42+50	1.12	1.49	2.61	3.14	3.73		12.10 (3.50 - 13.30)	3.98 (0.89 - 5.78)	17.48 99
15+20+35+42+60	1.06	1.42	2.48	2.98	4.26		12.20 (3.50 - 13.40)	4.03 (0.89 - 5.79)	17.70 99
15+20+35+50+50	1.08	1.44	2.51	3.59	3.59		12.20 (3.50 - 13.40)	4.03 (0.89 - 5.79)	17.70 99
15+20+35+50+60	1.02	1.36	2.37	3.39	4.07		12.20 (3.50 - 13.40)	4.03 (0.89 - 5.79)	17.70 99
15+20+42+42+42	1.13	1.50	3.16	3.16	3.16		12.10 (3.50 - 13.30)	3.98 (0.89 - 5.78)	17.48 99
15+20+42+42+50	1.08	1.44	3.03	3.03	3.61		12.20 (3.50 - 13.40)	4.03 (0.89 - 5.79)	17.70 99
15+20+42+42+60	1.02	1.36	2.86	2.86	4.09		12.20 (3.50 - 13.40)	4.03 (0.89 - 5.79)	17.70 99
15+20+42+50+50	1.03	1.38	2.89	3.45	3.45		12.20 (3.50 - 13.40)	4.03 (0.89 - 5.79)	17.70 99
15+22+22+22+22	1.50	2.20	2.20	2.20	2.20		10.30 (3.40 - 12.20)	3.20 (0.92 - 5.57)	14.05 99
15+22+22+22+25	1.50	2.20	2.20	2.20	2.50		10.60 (3.40 - 12.60)	3.27 (0.91 - 5.67)	14.36 99
15+22+22+22+35	1.47	2.16	2.16	2.16	3.44		11.40 (3.50 - 13.20)	3.59 (0.89 - 5.79)	15.77 99
15+22+22+22+42	1.44	2.11	2.11	2.11	4.03		11.80 (3.50 - 13.20)	3.83 (0.89 - 5.77)	16.82 99
15+22+22+22+50	1.36	2.00	2.00	2.00	4.54		11.90 (3.50 - 13.20)	3.89 (0.89 - 5.76)	17.08 99
15+22+22+22+60	1.28	1.87	1.87	1.87	5.11		12.00 (3.50 - 13.30)	3.94 (0.89 - 5.78)	17.30 99
15+22+22+22+71	1.19	1.75	1.75	1.75	5.65		12.10 (3.50 - 13.30)	3.98 (0.89 - 5.78)	17.48 99
15+22+22+25+25	1.50	2.20	2.20	2.50	2.50		10.90 (3.50 - 13.10)	3.33 (0.89 - 5.79)	14.62 99

MXZ-6C120VA COOLING

Indoor units combination	Cooling capacity (kW)						Outdoor unit power consumption (kW)	Current (A)	Power factor (%)	
	Unit A	Unit B	Unit C	Unit D	Unit E	Unit F				
15+15+15+35+35+35	1.20	1.20	1.20	2.80	2.80	2.80	12.00 (3.50 - 13.50)	3.61 (0.88 - 5.32)	15.85	99
15+15+15+35+35+42	1.15	1.15	1.15	2.68	2.68	3.21	12.00 (3.50 - 13.50)	3.61 (0.88 - 5.32)	15.85	99
15+15+15+35+35+50	1.09	1.09	1.09	2.55	2.55	3.64	12.00 (3.50 - 13.50)	3.61 (0.88 - 5.32)	15.85	99
15+15+15+35+35+60	1.03	1.03	1.03	2.40	2.40	4.11	12.00 (3.50 - 13.50)	3.61 (0.88 - 5.32)	15.85	99
15+15+15+35+42+42	1.10	1.10	1.10	2.56	3.07	3.07	12.00 (3.50 - 13.50)	3.61 (0.88 - 5.32)	15.85	99
15+15+15+35+42+50	1.05	1.05	1.05	2.44	2.93	3.49	12.00 (3.50 - 13.50)	3.61 (0.88 - 5.32)	15.85	99
15+15+15+35+50+50	1.00	1.00	1.00	2.33	3.33	3.33	12.00 (3.50 - 13.50)	3.61 (0.88 - 5.32)	15.85	99
15+15+15+42+42+42	1.05	1.05	1.05	2.95	2.95	2.95	12.00 (3.50 - 13.50)	3.61 (0.88 - 5.32)	15.85	99
15+15+15+42+42+50	1.01	1.01	1.01	2.82	2.82	3.35	12.00 (3.50 - 13.50)	3.61 (0.88 - 5.32)	15.85	99
15+15+20+20+20+20	1.45	1.45	1.93	1.93	1.93	1.93	10.60 (3.30 - 12.50)	3.41 (0.91 - 5.63)	14.98	99
15+15+20+20+20+22	1.45	1.45	1.93	1.93	1.93	2.12	10.80 (3.30 - 12.60)	3.54 (0.91 - 5.65)	15.55	99
15+15+20+20+20+25	1.43	1.43	1.91	1.91	1.91	2.39	11.00 (3.30 - 12.60)	3.67 (0.91 - 5.65)	16.12	99
15+15+20+20+20+35	1.40	1.40	1.87	1.87	1.87	3.28	11.70 (3.40 - 13.10)	3.79 (0.90 - 5.49)	16.64	99
15+15+20+20+20+42	1.36	1.36	1.82	1.82	1.82	3.82	12.00 (3.50 - 13.50)	3.66 (0.88 - 5.37)	16.07	99
15+15+20+20+20+50	1.29	1.29	1.71	1.71	1.71	4.29	12.00 (3.50 - 13.50)	3.64 (0.88 - 5.35)	15.99	99
15+15+20+20+20+60	1.20	1.20	1.60	1.60	1.60	4.80	12.00 (3.50 - 13.50)	3.61 (0.88 - 5.32)	15.85	99
15+15+20+20+20+71	1.12	1.12	1.49	1.49	1.49	5.29	12.00 (3.50 - 13.50)	3.61 (0.88 - 5.32)	15.85	99
15+15+20+20+22+22	1.43	1.43	1.91	1.91	2.10	2.10	10.90 (3.30 - 12.60)	3.60 (0.91 - 5.65)	15.81	99
15+15+20+20+22+25	1.44	1.44	1.91	1.91	2.11	2.39	11.20 (3.30 - 12.60)	3.79 (0.91 - 5.65)	16.64	99
15+15+20+20+22+35	1.39	1.39	1.86	1.86	2.04	3.25	11.80 (3.40 - 13.20)	3.75 (0.89 - 5.46)	16.47	99
15+15+20+20+22+42	1.34	1.34	1.79	1.79	1.97	3.76	12.00 (3.50 - 13.50)	3.65 (0.88 - 5.36)	16.03	99
15+15+20+20+22+50	1.27	1.27	1.69	1.69	1.86	4.23	12.00 (3.50 - 13.50)	3.63 (0.88 - 5.34)	15.94	99
15+15+20+20+22+60	1.18	1.18	1.58	1.58	1.74	4.74	12.00 (3.50 - 13.50)	3.61 (0.88 - 5.32)	15.85	99
15+15+20+20+22+71	1.10	1.10	1.47	1.47	1.62	5.23	12.00 (3.50 - 13.50)	3.61 (0.88 - 5.32)	15.85	99
15+15+20+20+25+25	1.43	1.43	1.90	1.90	2.38	2.38	11.40 (3.30 - 12.60)	3.92 (0.91 - 5.65)	17.22	99
15+15+20+20+25+35	1.37	1.37	1.83	1.83	2.29	3.20	11.90 (3.50 - 13.40)	3.70 (0.89 - 5.40)	16.25	99
15+15+20+20+25+42	1.31	1.31	1.75	1.75	2.19	3.68	12.00 (3.50 - 13.50)	3.65 (0.88 - 5.36)	16.03	99
15+15+20+20+25+50	1.24	1.24	1.66	1.66	2.07	4.14	12.00 (3.50 - 13.50)	3.62 (0.88 - 5.33)	15.90	99
15+15+20+20+25+60	1.16	1.16	1.55	1.55	1.94	4.65	12.00 (3.50 - 13.50)	3.61 (0.88 - 5.32)	15.85	99
15+15+20+20+25+71	1.08	1.08	1.45	1.45	1.81	5.13	12.00 (3.50 - 13.50)	3.61 (0.88 - 5.32)	15.85	99
15+15+20+20+35+35	1.29	1.29	1.71	1.71	3.00	3.00	12.00 (3.50 - 13.50)	3.64 (0.88 - 5.35)	15.99	99
15+15+20+20+35+42	1.22	1.22	1.63	1.63	2.86	3.43	12.00 (3.50 - 13.50)	3.62 (0.88 - 5.33)	15.90	99
15+15+20+20+35+50	1.16	1.16	1.55	1.55	2.71	3.87	12.00 (3.50 - 13.50)	3.61 (0.88 - 5.32)	15.85	99
15+15+20+20+35+60	1.09	1.09	1.45	1.45	2.55	4.36	12.00 (3.50 - 13.50)	3.61 (0.88 - 5.32)	15.85	99
15+15+20+20+35+71	1.02	1.02	1.36	1.36	2.39	4.84	12.00 (3.50 - 13.50)	3.61 (0.88 - 5.32)	15.85	99
15+15+20+20+42+42	1.17	1.17	1.56	1.56	3.27	3.27	12.00 (3.50 - 13.50)	3.61 (0.88 - 5.32)	15.85	99
15+15+20+20+42+50	1.11	1.11	1.48	1.48	3.11	3.70	12.00 (3.50 - 13.50)	3.61 (0.88 - 5.32)	15.85	99
15+15+20+20+42+60	1.05	1.05	1.40	1.40	2.93	4.19	12.00 (3.50 - 13.50)	3.61 (0.88 - 5.32)	15.85	99
15+15+20+20+50+50	1.06	1.06	1.41	1.41	3.53	3.53	12.00 (3.50 - 13.50)	3.61 (0.88 - 5.32)	15.85	99
15+15+20+20+50+60	1.00	1.00	1.33	1.33	3.33	4.00	12.00 (3.50 - 13.50)	3.61 (0.88 - 5.32)	15.85	99
15+15+20+22+22+22	1.44	1.44	1.91	2.11	2.11	2.11	11.10 (3.30 - 12.60)	3.73 (0.91 - 5.65)	16.38	99
15+15+20+22+22+25	1.42	1.42	1.90	2.09	2.09	2.37	11.30 (3.30 - 12.60)	3.86 (0.91 - 5.65)	16.95	99
15+15+20+22+22+35	1.38	1.38	1.84	2.03	2.03	3.23	11.90 (3.50 - 13.40)	3.70 (0.89 - 5.40)	16.25	99
15+15+20+22+22+42	1.32	1.32	1.76	1.94	1.94	3.71	12.00 (3.50 - 13.50)	3.65 (0.88 - 5.36)	16.03	99
15+15+20+22+22+50	1.25	1.25	1.67	1.83	1.83	4.17	12.00 (3.50 - 13.50)	3.63 (0.88 - 5.34)	15.94	99
15+15+20+22+22+60	1.17	1.17	1.56	1.71	1.71	4.68	12.00 (3.50 - 13.50)	3.61 (0.88 - 5.32)	15.85	99

MXZ-6C120VA COOLING

Indoor units combination	Cooling capacity (kW)						Outdoor unit power consumption (kW)	Current (A)	Power factor (%)	
	Unit A	Unit B	Unit C	Unit D	Unit E	Unit F				
15+15+20+22+22+71	1.09	1.09	1.45	1.60	1.60	5.16	12.00 (3.50 - 13.50)	3.61 (0.88 - 5.32)	15.85	99
15+15+20+22+25+25	1.41	1.41	1.89	2.07	2.36	2.36	11.50 (3.30 - 12.80)	3.88 (0.91 - 5.59)	17.04	99
15+15+20+22+25+35	1.36	1.36	1.82	2.00	2.27	3.18	12.00 (3.50 - 13.50)	3.66 (0.88 - 5.37)	16.07	99
15+15+20+22+25+42	1.29	1.29	1.73	1.90	2.16	3.63	12.00 (3.50 - 13.50)	3.64 (0.88 - 5.35)	15.99	99
15+15+20+22+25+50	1.22	1.22	1.63	1.80	2.04	4.08	12.00 (3.50 - 13.50)	3.62 (0.88 - 5.33)	15.90	99
15+15+20+22+25+60	1.15	1.15	1.53	1.68	1.91	4.59	12.00 (3.50 - 13.50)	3.61 (0.88 - 5.32)	15.85	99
15+15+20+22+25+71	1.07	1.07	1.43	1.57	1.79	5.07	12.00 (3.50 - 13.50)	3.61 (0.88 - 5.32)	15.85	99
15+15+20+22+35+35	1.27	1.27	1.69	1.86	2.96	2.96	12.00 (3.50 - 13.50)	3.63 (0.88 - 5.34)	15.94	99
15+15+20+22+35+42	1.21	1.21	1.61	1.77	2.82	3.38	12.00 (3.50 - 13.50)	3.61 (0.88 - 5.32)	15.85	99
15+15+20+22+35+50	1.15	1.15	1.53	1.68	2.68	3.82	12.00 (3.50 - 13.50)	3.61 (0.88 - 5.32)	15.85	99
15+15+20+22+35+60	1.08	1.08	1.44	1.58	2.51	4.31	12.00 (3.50 - 13.50)	3.61 (0.88 - 5.32)	15.85	99
15+15+20+22+35+71	1.01	1.01	1.35	1.48	2.36	4.79	12.00 (3.50 - 13.50)	3.61 (0.88 - 5.32)	15.85	99
15+15+20+22+42+42	1.15	1.15	1.54	1.69	3.23	3.23	12.00 (3.50 - 13.50)	3.61 (0.88 - 5.32)	15.85	99
15+15+20+22+42+50	1.10	1.10	1.46	1.61	3.07	3.66	12.00 (3.50 - 13.50)	3.61 (0.88 - 5.32)	15.85	99
15+15+20+22+42+60	1.03	1.03	1.38	1.52	2.90	4.14	12.00 (3.50 - 13.50)	3.61 (0.88 - 5.32)	15.85	99
15+15+20+22+50+50	1.05	1.05	1.40	1.53	3.49	3.49	12.00 (3.50 - 13.50)	3.61 (0.88 - 5.32)	15.85	99
15+15+20+25+25+25	1.40	1.40	1.87	2.34	2.34	2.34	11.70 (3.40 - 13.10)	3.79 (0.90 - 5.49)	16.64	99
15+15+20+25+25+35	1.33	1.33	1.78	2.22	2.22	3.11	12.00 (3.50 - 13.50)	3.65 (0.88 - 5.36)	16.03	99
15+15+20+25+25+42	1.27	1.27	1.69	2.11	2.11	3.55	12.00 (3.50 - 13.50)	3.63 (0.88 - 5.34)	15.94	99
15+15+20+25+25+50	1.20	1.20	1.60	2.00	2.00	4.00	12.00 (3.50 - 13.50)	3.61 (0.88 - 5.32)	15.85	99
15+15+20+25+25+60	1.13	1.13	1.50	1.88	1.88	4.50	12.00 (3.50 - 13.50)	3.61 (0.88 - 5.32)	15.85	99
15+15+20+25+25+71	1.05	1.05	1.40	1.75	1.75	4.98	12.00 (3.50 - 13.50)	3.61 (0.88 - 5.32)	15.85	99
15+15+20+25+35+35	1.24	1.24	1.66	2.07	2.90	2.90	12.00 (3.50 - 13.50)	3.62 (0.88 - 5.33)	15.90	99
15+15+20+25+35+42	1.18	1.18	1.58	1.97	2.76	3.32	12.00 (3.50 - 13.50)	3.61 (0.88 - 5.32)	15.85	99
15+15+20+25+35+50	1.13	1.13	1.50	1.88	2.63	3.75	12.00 (3.50 - 13.50)	3.61 (0.88 - 5.32)	15.85	99
15+15+20+25+35+60	1.06	1.06	1.41	1.76	2.47	4.24	12.00 (3.50 - 13.50)	3.61 (0.88 - 5.32)	15.85	99
15+15+20+25+42+42	1.13	1.13	1.51	1.89	3.17	3.17	12.00 (3.50 - 13.50)	3.61 (0.88 - 5.32)	15.85	99
15+15+20+25+42+50	1.08	1.08	1.44	1.80	3.02	3.59	12.00 (3.50 - 13.50)	3.61 (0.88 - 5.32)	15.85	99
15+15+20+25+42+60	1.02	1.02	1.36	1.69	2.85	4.07	12.00 (3.50 - 13.50)	3.61 (0.88 - 5.32)	15.85	99
15+15+20+25+50+50	1.03	1.03	1.37	1.71	3.43	3.43	12.00 (3.50 - 13.50)	3.61 (0.88 - 5.32)	15.85	99
15+15+20+35+35+35	1.16	1.16	1.55	2.71	2.71	2.71	12.00 (3.50 - 13.50)	3.61 (0.88 - 5.32)	15.85	99
15+15+20+35+35+42	1.11	1.11	1.48	2.59	2.59	3.11	12.00 (3.50 - 13.50)	3.61 (0.88 - 5.32)	15.85	99
15+15+20+35+35+50	1.06	1.06	1.41	2.47	2.47	3.53	12.00 (3.50 - 13.50)	3.61 (0.88 - 5.32)	15.85	99
15+15+20+35+35+60	1.00	1.00	1.33	2.33	2.33	4.00	12.00 (3.50 - 13.50)	3.61 (0.88 - 5.32)	15.85	99
15+15+20+35+42+42	1.07	1.07	1.42	2.49	2.98	2.98	12.00 (3.50 - 13.50)	3.61 (0.88 - 5.32)	15.85	99
15+15+20+35+42+50	1.02	1.02	1.36	2.37	2.85	3.39	12.00 (3.50 - 13.50)	3.61 (0.88 - 5.32)	15.85	99
15+15+20+42+42+42	1.02	1.02	1.36	2.86	2.86	2.86	12.00 (3.50 - 13.50)	3.61 (0.88 - 5.32)	15.85	99
15+15+22+22+22+22	1.42	1.42	2.09	2.09	2.09	2.09	11.20 (3.30 - 12.60)	3.79 (0.91 - 5.65)	16.64	99
15+15+22+22+22+25	1.43	1.43	2.09	2.09	2.09	2.38	11.50 (3.30 - 12.80)	3.88 (0.91 - 5.59)	17.04	99
15+15+22+22+22+35	1.37	1.37	2.02	2.02	2.02	3.21	12.00 (3.50 - 13.50)	3.66 (0.88 - 5.37)	16.07	99
15+15+22+22+22+42	1.30	1.30	1.91	1.91	1.91	3.65	12.00 (3.50 - 13.50)	3.64 (0.88 - 5.35)	15.99	99
15+15+22+22+22+50	1.23	1.23	1.81	1.81	1.81	4.11	12.00 (3.50 - 13.50)	3.62 (0.88 - 5.33)	15.90	99
15+15+22+22+22+60	1.15	1.15	1.69	1.69	1.69	4.62	12.00 (3.50 - 13.50)	3.61 (0.88 - 5.32)	15.85	99
15+15+22+22+22+71	1.08	1.08	1.58	1.58	1.58	5.10	12.00 (3.50 - 13.50)	3.61 (0.88 - 5.32)	15.85	99
15+15+22+22+25+25	1.40	1.40	2.06	2.06	2.34	2.34	11.60 (3.40 - 12.90)	3.83 (0.90 - 5.56)	16.82	99
15+15+22+22+25+35	1.34	1.34	1.97	1.97	2.24	3.13	12.00 (3.50 - 13.50)	3.65 (0.88 - 5.36)	16.03	99

MXZ-6C120VA COOLING

Indoor units combination	Cooling capacity (kW)						Outdoor unit power consumption (kW)	Current (A)	Power factor (%)	
	Unit A	Unit B	Unit C	Unit D	Unit E	Unit F				
15+15+22+22+25+42	1.28	1.28	1.87	1.87	2.13	3.57	12.00 (3.50 - 13.50)	3.64 (0.88 - 5.35)	15.99	99
15+15+22+22+25+50	1.21	1.21	1.77	1.77	2.01	4.03	12.00 (3.50 - 13.50)	3.61 (0.88 - 5.32)	15.85	99
15+15+22+22+25+60	1.13	1.13	1.66	1.66	1.89	4.53	12.00 (3.50 - 13.50)	3.61 (0.88 - 5.32)	15.85	99
15+15+22+22+25+71	1.06	1.06	1.55	1.55	1.76	5.01	12.00 (3.50 - 13.50)	3.61 (0.88 - 5.32)	15.85	99
15+15+22+22+35+35	1.25	1.25	1.83	1.83	2.92	2.92	12.00 (3.50 - 13.50)	3.63 (0.88 - 5.34)	15.94	99
15+15+22+22+35+42	1.19	1.19	1.75	1.75	2.78	3.34	12.00 (3.50 - 13.50)	3.61 (0.88 - 5.32)	15.85	99
15+15+22+22+35+50	1.13	1.13	1.66	1.66	2.64	3.77	12.00 (3.50 - 13.50)	3.61 (0.88 - 5.32)	15.85	99
15+15+22+22+35+60	1.07	1.07	1.56	1.56	2.49	4.26	12.00 (3.50 - 13.50)	3.61 (0.88 - 5.32)	15.85	99
15+15+22+22+35+71	1.00	1.00	1.47	1.47	2.33	4.73	12.00 (3.50 - 13.50)	3.61 (0.88 - 5.32)	15.85	99
15+15+22+22+42+42	1.14	1.14	1.67	1.67	3.19	3.19	12.00 (3.50 - 13.50)	3.61 (0.88 - 5.32)	15.85	99
15+15+22+22+42+50	1.08	1.08	1.59	1.59	3.04	3.61	12.00 (3.50 - 13.50)	3.61 (0.88 - 5.32)	15.85	99
15+15+22+22+42+60	1.02	1.02	1.50	1.50	2.86	4.09	12.00 (3.50 - 13.50)	3.61 (0.88 - 5.32)	15.85	99
15+15+22+22+50+50	1.03	1.03	1.52	1.52	3.45	3.45	12.00 (3.50 - 13.50)	3.61 (0.88 - 5.32)	15.85	99
15+15+22+25+25+25	1.39	1.39	2.04	2.32	2.32	2.32	11.80 (3.40 - 13.20)	3.75 (0.89 - 5.46)	16.47	99
15+15+22+25+25+35	1.31	1.31	1.93	2.19	2.19	3.07	12.00 (3.50 - 13.50)	3.65 (0.88 - 5.36)	16.03	99
15+15+22+25+25+42	1.25	1.25	1.83	2.08	2.08	3.50	12.00 (3.50 - 13.50)	3.63 (0.88 - 5.34)	15.94	99
15+15+22+25+25+50	1.18	1.18	1.74	1.97	1.97	3.95	12.00 (3.50 - 13.50)	3.61 (0.88 - 5.32)	15.85	99
15+15+22+25+25+60	1.11	1.11	1.63	1.85	1.85	4.44	12.00 (3.50 - 13.50)	3.61 (0.88 - 5.32)	15.85	99
15+15+22+25+25+71	1.04	1.04	1.53	1.73	1.73	4.92	12.00 (3.50 - 13.50)	3.61 (0.88 - 5.32)	15.85	99
15+15+22+25+35+35	1.22	1.22	1.80	2.04	2.86	2.86	12.00 (3.50 - 13.50)	3.62 (0.88 - 5.33)	15.90	99
15+15+22+25+35+42	1.17	1.17	1.71	1.95	2.73	3.27	12.00 (3.50 - 13.50)	3.61 (0.88 - 5.32)	15.85	99
15+15+22+25+35+50	1.11	1.11	1.63	1.85	2.59	3.70	12.00 (3.50 - 13.50)	3.61 (0.88 - 5.32)	15.85	99
15+15+22+25+35+60	1.05	1.05	1.53	1.74	2.44	4.19	12.00 (3.50 - 13.50)	3.61 (0.88 - 5.32)	15.85	99
15+15+22+25+42+42	1.12	1.12	1.64	1.86	3.13	3.13	12.00 (3.50 - 13.50)	3.61 (0.88 - 5.32)	15.85	99
15+15+22+25+42+50	1.07	1.07	1.56	1.78	2.98	3.55	12.00 (3.50 - 13.50)	3.61 (0.88 - 5.32)	15.85	99
15+15+22+25+42+60	1.01	1.01	1.47	1.68	2.82	4.02	12.00 (3.50 - 13.50)	3.61 (0.88 - 5.32)	15.85	99
15+15+22+25+50+50	1.02	1.02	1.49	1.69	3.39	3.39	12.00 (3.50 - 13.50)	3.61 (0.88 - 5.32)	15.85	99
15+15+22+35+35+35	1.15	1.15	1.68	2.68	2.68	2.68	12.00 (3.50 - 13.50)	3.61 (0.88 - 5.32)	15.85	99
15+15+22+35+35+42	1.10	1.10	1.61	2.56	2.56	3.07	12.00 (3.50 - 13.50)	3.61 (0.88 - 5.32)	15.85	99
15+15+22+35+35+50	1.05	1.05	1.53	2.44	2.44	3.49	12.00 (3.50 - 13.50)	3.61 (0.88 - 5.32)	15.85	99
15+15+22+35+42+42	1.05	1.05	1.54	2.46	2.95	2.95	12.00 (3.50 - 13.50)	3.61 (0.88 - 5.32)	15.85	99
15+15+22+35+42+50	1.01	1.01	1.47	2.35	2.82	3.35	12.00 (3.50 - 13.50)	3.61 (0.88 - 5.32)	15.85	99
15+15+22+42+42+42	1.01	1.01	1.48	2.83	2.83	2.83	12.00 (3.50 - 13.50)	3.61 (0.88 - 5.32)	15.85	99
15+15+25+25+25+25	1.37	1.37	2.29	2.29	2.29	2.29	11.90 (3.50 - 13.40)	3.70 (0.89 - 5.40)	16.25	99
15+15+25+25+25+35	1.29	1.29	2.14	2.14	2.14	3.00	12.00 (3.50 - 13.50)	3.64 (0.88 - 5.35)	15.99	99
15+15+25+25+25+42	1.22	1.22	2.04	2.04	2.04	3.43	12.00 (3.50 - 13.50)	3.62 (0.88 - 5.33)	15.90	99
15+15+25+25+25+50	1.16	1.16	1.94	1.94	1.94	3.87	12.00 (3.50 - 13.50)	3.61 (0.88 - 5.32)	15.85	99
15+15+25+25+25+60	1.09	1.09	1.82	1.82	1.82	4.36	12.00 (3.50 - 13.50)	3.61 (0.88 - 5.32)	15.85	99
15+15+25+25+25+71	1.02	1.02	1.70	1.70	1.70	4.84	12.00 (3.50 - 13.50)	3.61 (0.88 - 5.32)	15.85	99
15+15+25+25+35+35	1.20	1.20	2.00	2.00	2.80	2.80	12.00 (3.50 - 13.50)	3.61 (0.88 - 5.32)	15.85	99
15+15+25+25+35+42	1.15	1.15	1.91	1.91	2.68	3.21	12.00 (3.50 - 13.50)	3.61 (0.88 - 5.32)	15.85	99
15+15+25+25+35+50	1.09	1.09	1.82	1.82	2.55	3.64	12.00 (3.50 - 13.50)	3.61 (0.88 - 5.32)	15.85	99
15+15+25+25+35+60	1.03	1.03	1.71	1.71	2.40	4.11	12.00 (3.50 - 13.50)	3.61 (0.88 - 5.32)	15.85	99
15+15+25+25+42+42	1.10	1.10	1.83	1.83	3.07	3.07	12.00 (3.50 - 13.50)	3.61 (0.88 - 5.32)	15.85	99
15+15+25+25+42+50	1.05	1.05	1.74	1.74	2.93	3.49	12.00 (3.50 - 13.50)	3.61 (0.88 - 5.32)	15.85	99
15+15+25+25+50+50	1.00	1.00	1.67	1.67	3.33	3.33	12.00 (3.50 - 13.50)	3.61 (0.88 - 5.32)	15.85	99

MXZ-6C120VA COOLING

Indoor units combination	Cooling capacity (kW)						Outdoor unit power consumption (kW)	Current (A)	Power factor (%)	
	Unit A	Unit B	Unit C	Unit D	Unit E	Unit F				
15+15+25+35+35+35	1.13	1.13	1.88	2.63	2.63	2.63	12.00 (3.50 - 13.50)	3.61 (0.88 - 5.32)	15.85	99
15+15+25+35+35+42	1.08	1.08	1.80	2.51	2.51	3.02	12.00 (3.50 - 13.50)	3.61 (0.88 - 5.32)	15.85	99
15+15+25+35+35+50	1.03	1.03	1.71	2.40	2.40	3.43	12.00 (3.50 - 13.50)	3.61 (0.88 - 5.32)	15.85	99
15+15+25+35+42+42	1.03	1.03	1.72	2.41	2.90	2.90	12.00 (3.50 - 13.50)	3.61 (0.88 - 5.32)	15.85	99
15+15+35+35+35+35	1.06	1.06	2.47	2.47	2.47	2.47	12.00 (3.50 - 13.50)	3.61 (0.88 - 5.32)	15.85	99
15+15+35+35+35+42	1.02	1.02	2.37	2.37	2.37	2.85	12.00 (3.50 - 13.50)	3.61 (0.88 - 5.32)	15.85	99
15+20+20+20+20+20	1.43	1.91	1.91	1.91	1.91	1.91	11.00 (3.30 - 12.60)	3.67 (0.91 - 5.65)	16.12	99
15+20+20+20+20+22	1.44	1.91	1.91	1.91	1.91	2.11	11.20 (3.30 - 12.60)	3.79 (0.91 - 5.65)	16.64	99
15+20+20+20+20+25	1.43	1.90	1.90	1.90	1.90	2.38	11.40 (3.30 - 12.60)	3.92 (0.91 - 5.65)	17.22	99
15+20+20+20+20+35	1.37	1.83	1.83	1.83	1.83	3.20	11.90 (3.50 - 13.40)	3.70 (0.89 - 5.40)	16.25	99
15+20+20+20+20+42	1.31	1.75	1.75	1.75	1.75	3.68	12.00 (3.50 - 13.50)	3.65 (0.88 - 5.36)	16.03	99
15+20+20+20+20+50	1.24	1.66	1.66	1.66	1.66	4.14	12.00 (3.50 - 13.50)	3.62 (0.88 - 5.33)	15.90	99
15+20+20+20+20+60	1.16	1.55	1.55	1.55	1.55	4.65	12.00 (3.50 - 13.50)	3.61 (0.88 - 5.32)	15.85	99
15+20+20+20+20+71	1.08	1.45	1.45	1.45	1.45	5.13	12.00 (3.50 - 13.50)	3.61 (0.88 - 5.32)	15.85	99
15+20+20+20+22+22	1.42	1.90	1.90	1.90	2.09	2.09	11.30 (3.30 - 12.60)	3.86 (0.91 - 5.65)	16.95	99
15+20+20+20+22+25	1.41	1.89	1.89	1.89	2.07	2.36	11.50 (3.30 - 12.80)	3.88 (0.91 - 5.59)	17.04	99
15+20+20+20+22+35	1.36	1.82	1.82	1.82	2.00	3.18	12.00 (3.50 - 13.50)	3.66 (0.88 - 5.37)	16.07	99
15+20+20+20+22+42	1.29	1.73	1.73	1.73	1.90	3.63	12.00 (3.50 - 13.50)	3.64 (0.88 - 5.35)	15.99	99
15+20+20+20+22+50	1.22	1.63	1.63	1.63	1.80	4.08	12.00 (3.50 - 13.50)	3.62 (0.88 - 5.33)	15.90	99
15+20+20+20+22+60	1.15	1.53	1.53	1.53	1.68	4.59	12.00 (3.50 - 13.50)	3.61 (0.88 - 5.32)	15.85	99
15+20+20+20+22+71	1.07	1.43	1.43	1.43	1.57	5.07	12.00 (3.50 - 13.50)	3.61 (0.88 - 5.32)	15.85	99
15+20+20+20+25+25	1.40	1.87	1.87	1.87	2.34	2.34	11.70 (3.40 - 13.10)	3.79 (0.90 - 5.49)	16.64	99
15+20+20+20+25+35	1.33	1.78	1.78	1.78	2.22	3.11	12.00 (3.50 - 13.50)	3.65 (0.88 - 5.36)	16.03	99
15+20+20+20+25+42	1.27	1.69	1.69	1.69	2.11	3.55	12.00 (3.50 - 13.50)	3.63 (0.88 - 5.34)	15.94	99
15+20+20+20+25+50	1.20	1.60	1.60	1.60	2.00	4.00	12.00 (3.50 - 13.50)	3.61 (0.88 - 5.32)	15.85	99
15+20+20+20+25+60	1.13	1.50	1.50	1.50	1.88	4.50	12.00 (3.50 - 13.50)	3.61 (0.88 - 5.32)	15.85	99
15+20+20+20+25+71	1.05	1.40	1.40	1.40	1.75	4.98	12.00 (3.50 - 13.50)	3.61 (0.88 - 5.32)	15.85	99
15+20+20+20+35+35	1.24	1.66	1.66	1.66	2.90	2.90	12.00 (3.50 - 13.50)	3.62 (0.88 - 5.33)	15.90	99
15+20+20+20+35+42	1.18	1.58	1.58	1.58	2.76	3.32	12.00 (3.50 - 13.50)	3.61 (0.88 - 5.32)	15.85	99
15+20+20+20+35+50	1.13	1.50	1.50	1.50	2.63	3.75	12.00 (3.50 - 13.50)	3.61 (0.88 - 5.32)	15.85	99
15+20+20+20+35+60	1.06	1.41	1.41	1.41	2.47	4.24	12.00 (3.50 - 13.50)	3.61 (0.88 - 5.32)	15.85	99
15+20+20+20+42+42	1.13	1.51	1.51	1.51	3.17	3.17	12.00 (3.50 - 13.50)	3.61 (0.88 - 5.32)	15.85	99
15+20+20+20+42+50	1.08	1.44	1.44	1.44	3.02	3.59	12.00 (3.50 - 13.50)	3.61 (0.88 - 5.32)	15.85	99
15+20+20+20+42+60	1.02	1.36	1.36	1.36	2.85	4.07	12.00 (3.50 - 13.50)	3.61 (0.88 - 5.32)	15.85	99
15+20+20+20+50+50	1.03	1.37	1.37	1.37	3.43	3.43	12.00 (3.50 - 13.50)	3.61 (0.88 - 5.32)	15.85	99
15+20+20+22+22+22	1.43	1.90	1.90	2.09	2.09	2.09	11.50 (3.30 - 12.80)	3.88 (0.91 - 5.59)	17.04	99
15+20+20+22+22+25	1.40	1.87	1.87	2.06	2.06	2.34	11.60 (3.40 - 12.90)	3.83 (0.90 - 5.56)	16.82	99
15+20+20+22+22+35	1.34	1.79	1.79	1.97	1.97	3.13	12.00 (3.50 - 13.50)	3.65 (0.88 - 5.36)	16.03	99
15+20+20+22+22+42	1.28	1.70	1.70	1.87	1.87	3.57	12.00 (3.50 - 13.50)	3.64 (0.88 - 5.35)	15.99	99
15+20+20+22+22+50	1.21	1.61	1.61	1.77	1.77	4.03	12.00 (3.50 - 13.50)	3.61 (0.88 - 5.32)	15.85	99
15+20+20+22+22+60	1.13	1.51	1.51	1.66	1.66	4.53	12.00 (3.50 - 13.50)	3.61 (0.88 - 5.32)	15.85	99
15+20+20+22+22+71	1.06	1.41	1.41	1.55	1.55	5.01	12.00 (3.50 - 13.50)	3.61 (0.88 - 5.32)	15.85	99
15+20+20+22+25+25	1.39	1.86	1.86	2.04	2.32	2.32	11.80 (3.40 - 13.20)	3.75 (0.89 - 5.46)	16.47	99
15+20+20+22+25+35	1.31	1.75	1.75	1.93	2.19	3.07	12.00 (3.50 - 13.50)	3.65 (0.88 - 5.36)	16.03	99
15+20+20+22+25+42	1.25	1.67	1.67	1.83	2.08	3.50	12.00 (3.50 - 13.50)	3.63 (0.88 - 5.34)	15.94	99
15+20+20+22+25+50	1.18	1.58	1.58	1.74	1.97	3.95	12.00 (3.50 - 13.50)	3.61 (0.88 - 5.32)	15.85	99

MXZ-6C120VA COOLING

Indoor units combination	Cooling capacity (kW)						Outdoor unit power consumption (kW)	Current (A)	Power factor (%)	
	Unit A	Unit B	Unit C	Unit D	Unit E	Unit F				
15+20+20+22+25+60	1.11	1.48	1.48	1.63	1.85	4.44	12.00 (3.50 - 13.50)	3.61 (0.88 - 5.32)	15.85	99
15+20+20+22+25+71	1.04	1.39	1.39	1.53	1.73	4.92	12.00 (3.50 - 13.50)	3.61 (0.88 - 5.32)	15.85	99
15+20+20+22+35+35	1.22	1.63	1.63	1.80	2.86	2.86	12.00 (3.50 - 13.50)	3.62 (0.88 - 5.33)	15.90	99
15+20+20+22+35+42	1.17	1.56	1.56	1.71	2.73	3.27	12.00 (3.50 - 13.50)	3.61 (0.88 - 5.32)	15.85	99
15+20+20+22+35+50	1.11	1.48	1.48	1.63	2.59	3.70	12.00 (3.50 - 13.50)	3.61 (0.88 - 5.32)	15.85	99
15+20+20+22+35+60	1.05	1.40	1.40	1.53	2.44	4.19	12.00 (3.50 - 13.50)	3.61 (0.88 - 5.32)	15.85	99
15+20+20+22+42+42	1.12	1.49	1.49	1.64	3.13	3.13	12.00 (3.50 - 13.50)	3.61 (0.88 - 5.32)	15.85	99
15+20+20+22+42+50	1.07	1.42	1.42	1.56	2.98	3.55	12.00 (3.50 - 13.50)	3.61 (0.88 - 5.32)	15.85	99
15+20+20+22+42+60	1.01	1.34	1.34	1.47	2.82	4.02	12.00 (3.50 - 13.50)	3.61 (0.88 - 5.32)	15.85	99
15+20+20+22+50+50	1.02	1.36	1.36	1.49	3.39	3.39	12.00 (3.50 - 13.50)	3.61 (0.88 - 5.32)	15.85	99
15+20+20+25+25+25	1.37	1.83	1.83	2.29	2.29	2.29	11.90 (3.50 - 13.40)	3.70 (0.89 - 5.40)	16.25	99
15+20+20+25+25+35	1.29	1.71	1.71	2.14	2.14	3.00	12.00 (3.50 - 13.50)	3.64 (0.88 - 5.35)	15.99	99
15+20+20+25+25+42	1.22	1.63	1.63	2.04	2.04	3.43	12.00 (3.50 - 13.50)	3.62 (0.88 - 5.33)	15.90	99
15+20+20+25+25+50	1.16	1.55	1.55	1.94	1.94	3.87	12.00 (3.50 - 13.50)	3.61 (0.88 - 5.32)	15.85	99
15+20+20+25+25+60	1.09	1.45	1.45	1.82	1.82	4.36	12.00 (3.50 - 13.50)	3.61 (0.88 - 5.32)	15.85	99
15+20+20+25+25+71	1.02	1.36	1.36	1.70	1.70	4.84	12.00 (3.50 - 13.50)	3.61 (0.88 - 5.32)	15.85	99
15+20+20+25+35+35	1.20	1.60	1.60	2.00	2.80	2.80	12.00 (3.50 - 13.50)	3.61 (0.88 - 5.32)	15.85	99
15+20+20+25+35+42	1.15	1.53	1.53	1.91	2.68	3.21	12.00 (3.50 - 13.50)	3.61 (0.88 - 5.32)	15.85	99
15+20+20+25+35+50	1.09	1.45	1.45	1.82	2.55	3.64	12.00 (3.50 - 13.50)	3.61 (0.88 - 5.32)	15.85	99
15+20+20+25+35+60	1.03	1.37	1.37	1.71	2.40	4.11	12.00 (3.50 - 13.50)	3.61 (0.88 - 5.32)	15.85	99
15+20+20+25+42+42	1.10	1.46	1.46	1.83	3.07	3.07	12.00 (3.50 - 13.50)	3.61 (0.88 - 5.32)	15.85	99
15+20+20+25+42+50	1.05	1.40	1.40	1.74	2.93	3.49	12.00 (3.50 - 13.50)	3.61 (0.88 - 5.32)	15.85	99
15+20+20+25+50+50	1.00	1.33	1.33	1.67	3.33	3.33	12.00 (3.50 - 13.50)	3.61 (0.88 - 5.32)	15.85	99
15+20+20+35+35+35	1.13	1.50	1.50	2.63	2.63	2.63	12.00 (3.50 - 13.50)	3.61 (0.88 - 5.32)	15.85	99
15+20+20+35+35+42	1.08	1.44	1.44	2.51	2.51	3.02	12.00 (3.50 - 13.50)	3.61 (0.88 - 5.32)	15.85	99
15+20+20+35+35+50	1.03	1.37	1.37	2.40	2.40	3.43	12.00 (3.50 - 13.50)	3.61 (0.88 - 5.32)	15.85	99
15+20+20+35+42+42	1.03	1.38	1.38	2.41	2.90	2.90	12.00 (3.50 - 13.50)	3.61 (0.88 - 5.32)	15.85	99
15+20+22+22+22+22	1.41	1.89	2.07	2.07	2.07	2.07	11.60 (3.40 - 12.90)	3.83 (0.90 - 5.56)	16.82	99
15+20+22+22+22+25	1.39	1.86	2.04	2.04	2.04	2.32	11.70 (3.40 - 13.10)	3.79 (0.90 - 5.49)	16.64	99
15+20+22+22+22+35	1.32	1.76	1.94	1.94	1.94	3.09	12.00 (3.50 - 13.50)	3.65 (0.88 - 5.36)	16.03	99
15+20+22+22+22+42	1.26	1.68	1.85	1.85	1.85	3.52	12.00 (3.50 - 13.50)	3.63 (0.88 - 5.34)	15.94	99
15+20+22+22+22+50	1.19	1.59	1.75	1.75	1.75	3.97	12.00 (3.50 - 13.50)	3.61 (0.88 - 5.32)	15.85	99
15+20+22+22+22+60	1.12	1.49	1.64	1.64	1.64	4.47	12.00 (3.50 - 13.50)	3.61 (0.88 - 5.32)	15.85	99
15+20+22+22+22+71	1.05	1.40	1.53	1.53	1.53	4.95	12.00 (3.50 - 13.50)	3.61 (0.88 - 5.32)	15.85	99
15+20+22+22+25+25	1.38	1.84	2.03	2.03	2.31	2.31	11.90 (3.50 - 13.40)	3.70 (0.89 - 5.40)	16.25	99
15+20+22+22+25+35	1.29	1.73	1.90	1.90	2.16	3.02	12.00 (3.50 - 13.50)	3.64 (0.88 - 5.35)	15.99	99
15+20+22+22+25+42	1.23	1.64	1.81	1.81	2.05	3.45	12.00 (3.50 - 13.50)	3.62 (0.88 - 5.33)	15.90	99
15+20+22+22+25+50	1.17	1.56	1.71	1.71	1.95	3.90	12.00 (3.50 - 13.50)	3.61 (0.88 - 5.32)	15.85	99
15+20+22+22+25+60	1.10	1.46	1.61	1.61	1.83	4.39	12.00 (3.50 - 13.50)	3.61 (0.88 - 5.32)	15.85	99
15+20+22+22+25+71	1.03	1.37	1.51	1.51	1.71	4.87	12.00 (3.50 - 13.50)	3.61 (0.88 - 5.32)	15.85	99
15+20+22+22+35+35	1.21	1.61	1.77	1.77	2.82	2.82	12.00 (3.50 - 13.50)	3.61 (0.88 - 5.32)	15.85	99
15+20+22+22+35+42	1.15	1.54	1.69	1.69	2.69	3.23	12.00 (3.50 - 13.50)	3.61 (0.88 - 5.32)	15.85	99
15+20+22+22+35+50	1.10	1.46	1.61	1.61	2.56	3.66	12.00 (3.50 - 13.50)	3.61 (0.88 - 5.32)	15.85	99
15+20+22+22+35+60	1.03	1.38	1.52	1.52	2.41	4.14	12.00 (3.50 - 13.50)	3.61 (0.88 - 5.32)	15.85	99
15+20+22+22+42+42	1.10	1.47	1.62	1.62	3.09	3.09	12.00 (3.50 - 13.50)	3.61 (0.88 - 5.32)	15.85	99
15+20+22+22+42+50	1.05	1.40	1.54	1.54	2.95	3.51	12.00 (3.50 - 13.50)	3.61 (0.88 - 5.32)	15.85	99

MXZ-6C120VA COOLING

Indoor units combination	Cooling capacity (kW)						Outdoor unit power consumption (kW)	Current (A)	Power factor (%)	
	Unit A	Unit B	Unit C	Unit D	Unit E	Unit F				
15+20+22+22+50+50	1.01	1.34	1.47	1.47	3.35	3.35	12.00 (3.50 - 13.50)	3.61 (0.88 - 5.32)	15.85	99
15+20+22+25+25+25	1.36	1.82	2.00	2.27	2.27	2.27	12.00 (3.50 - 13.50)	3.66 (0.88 - 5.37)	16.07	99
15+20+22+25+25+35	1.27	1.69	1.86	2.11	2.11	2.96	12.00 (3.50 - 13.50)	3.63 (0.88 - 5.34)	15.94	99
15+20+22+25+25+42	1.21	1.61	1.77	2.01	2.01	3.38	12.00 (3.50 - 13.50)	3.61 (0.88 - 5.32)	15.85	99
15+20+22+25+25+50	1.15	1.53	1.68	1.91	1.91	3.82	12.00 (3.50 - 13.50)	3.61 (0.88 - 5.32)	15.85	99
15+20+22+25+25+60	1.08	1.44	1.58	1.80	1.80	4.31	12.00 (3.50 - 13.50)	3.61 (0.88 - 5.32)	15.85	99
15+20+22+25+25+71	1.01	1.35	1.48	1.69	1.69	4.79	12.00 (3.50 - 13.50)	3.61 (0.88 - 5.32)	15.85	99
15+20+22+25+35+35	1.18	1.58	1.74	1.97	2.76	2.76	12.00 (3.50 - 13.50)	3.61 (0.88 - 5.32)	15.85	99
15+20+22+25+35+42	1.13	1.51	1.66	1.89	2.64	3.17	12.00 (3.50 - 13.50)	3.61 (0.88 - 5.32)	15.85	99
15+20+22+25+35+50	1.08	1.44	1.58	1.80	2.51	3.59	12.00 (3.50 - 13.50)	3.61 (0.88 - 5.32)	15.85	99
15+20+22+25+35+60	1.02	1.36	1.49	1.69	2.37	4.07	12.00 (3.50 - 13.50)	3.61 (0.88 - 5.32)	15.85	99
15+20+22+25+42+42	1.08	1.45	1.59	1.81	3.04	3.04	12.00 (3.50 - 13.50)	3.61 (0.88 - 5.32)	15.85	99
15+20+22+25+42+50	1.03	1.38	1.52	1.72	2.90	3.45	12.00 (3.50 - 13.50)	3.61 (0.88 - 5.32)	15.85	99
15+20+22+35+35+35	1.11	1.48	1.63	2.59	2.59	2.59	12.00 (3.50 - 13.50)	3.61 (0.88 - 5.32)	15.85	99
15+20+22+35+35+42	1.07	1.42	1.56	2.49	2.49	2.98	12.00 (3.50 - 13.50)	3.61 (0.88 - 5.32)	15.85	99
15+20+22+35+35+50	1.02	1.36	1.49	2.37	2.37	3.39	12.00 (3.50 - 13.50)	3.61 (0.88 - 5.32)	15.85	99
15+20+22+35+42+42	1.02	1.36	1.50	2.39	2.86	2.86	12.00 (3.50 - 13.50)	3.61 (0.88 - 5.32)	15.85	99
15+20+25+25+25+25	1.33	1.78	2.22	2.22	2.22	2.22	12.00 (3.50 - 13.50)	3.65 (0.88 - 5.36)	16.03	99
15+20+25+25+25+35	1.24	1.66	2.07	2.07	2.07	2.90	12.00 (3.50 - 13.50)	3.62 (0.88 - 5.33)	15.90	99
15+20+25+25+25+42	1.18	1.58	1.97	1.97	1.97	3.32	12.00 (3.50 - 13.50)	3.61 (0.88 - 5.32)	15.85	99
15+20+25+25+25+50	1.13	1.50	1.88	1.88	1.88	3.75	12.00 (3.50 - 13.50)	3.61 (0.88 - 5.32)	15.85	99
15+20+25+25+25+60	1.06	1.41	1.76	1.76	1.76	4.24	12.00 (3.50 - 13.50)	3.61 (0.88 - 5.32)	15.85	99
15+20+25+25+35+35	1.16	1.55	1.94	1.94	2.71	2.71	12.00 (3.50 - 13.50)	3.61 (0.88 - 5.32)	15.85	99
15+20+25+25+35+42	1.11	1.48	1.85	1.85	2.59	3.11	12.00 (3.50 - 13.50)	3.61 (0.88 - 5.32)	15.85	99
15+20+25+25+35+50	1.06	1.41	1.76	1.76	2.47	3.53	12.00 (3.50 - 13.50)	3.61 (0.88 - 5.32)	15.85	99
15+20+25+25+35+60	1.00	1.33	1.67	1.67	2.33	4.00	12.00 (3.50 - 13.50)	3.61 (0.88 - 5.32)	15.85	99
15+20+25+25+42+42	1.07	1.42	1.78	1.78	2.98	2.98	12.00 (3.50 - 13.50)	3.61 (0.88 - 5.32)	15.85	99
15+20+25+25+42+50	1.02	1.36	1.69	1.69	2.85	3.39	12.00 (3.50 - 13.50)	3.61 (0.88 - 5.32)	15.85	99
15+20+25+35+35+35	1.09	1.45	1.82	2.55	2.55	2.55	12.00 (3.50 - 13.50)	3.61 (0.88 - 5.32)	15.85	99
15+20+25+35+35+42	1.05	1.40	1.74	2.44	2.44	2.93	12.00 (3.50 - 13.50)	3.61 (0.88 - 5.32)	15.85	99
15+20+25+35+35+50	1.00	1.33	1.67	2.33	2.33	3.33	12.00 (3.50 - 13.50)	3.61 (0.88 - 5.32)	15.85	99
15+20+25+35+42+42	1.01	1.34	1.68	2.35	2.82	2.82	12.00 (3.50 - 13.50)	3.61 (0.88 - 5.32)	15.85	99
15+20+35+35+35+35	1.03	1.37	2.40	2.40	2.40	2.40	12.00 (3.50 - 13.50)	3.61 (0.88 - 5.32)	15.85	99
15+22+22+22+22+22	1.40	2.06	2.06	2.06	2.06	2.06	11.70 (3.40 - 13.10)	3.79 (0.90 - 5.49)	16.64	99
15+22+22+22+22+25	1.38	2.03	2.03	2.03	2.03	2.30	11.80 (3.40 - 13.20)	3.75 (0.89 - 5.46)	16.47	99
15+22+22+22+22+35	1.30	1.91	1.91	1.91	1.91	3.04	12.00 (3.50 - 13.50)	3.64 (0.88 - 5.35)	15.99	99
15+22+22+22+22+42	1.24	1.82	1.82	1.82	1.82	3.48	12.00 (3.50 - 13.50)	3.62 (0.88 - 5.33)	15.90	99
15+22+22+22+22+50	1.18	1.73	1.73	1.73	1.73	3.92	12.00 (3.50 - 13.50)	3.61 (0.88 - 5.32)	15.85	99
15+22+22+22+22+60	1.10	1.62	1.62	1.62	1.62	4.42	12.00 (3.50 - 13.50)	3.61 (0.88 - 5.32)	15.85	99
15+22+22+22+22+71	1.03	1.52	1.52	1.52	1.52	4.90	12.00 (3.50 - 13.50)	3.61 (0.88 - 5.32)	15.85	99
15+22+22+22+25+25	1.37	2.02	2.02	2.02	2.29	2.29	12.00 (3.50 - 13.50)	3.66 (0.88 - 5.37)	16.07	99
15+22+22+22+25+35	1.28	1.87	1.87	1.87	2.13	2.98	12.00 (3.50 - 13.50)	3.64 (0.88 - 5.35)	15.99	99
15+22+22+22+25+42	1.22	1.78	1.78	1.78	2.03	3.41	12.00 (3.50 - 13.50)	3.62 (0.88 - 5.33)	15.90	99
15+22+22+22+25+50	1.15	1.69	1.69	1.69	1.92	3.85	12.00 (3.50 - 13.50)	3.61 (0.88 - 5.32)	15.85	99
15+22+22+22+25+60	1.08	1.59	1.59	1.59	1.81	4.34	12.00 (3.50 - 13.50)	3.61 (0.88 - 5.32)	15.85	99
15+22+22+22+25+71	1.02	1.49	1.49	1.49	1.69	4.81	12.00 (3.50 - 13.50)	3.61 (0.88 - 5.32)	15.85	99

MXZ-6C120VA COOLING

Indoor units combination	Cooling capacity (kW)						Outdoor unit power consumption (kW)	Current (A)	Power factor (%)	
	Unit A	Unit B	Unit C	Unit D	Unit E	Unit F				
15+22+22+22+35+35	1.19	1.75	1.75	1.75	2.78	2.78	12.00 (3.50 - 13.50)	3.61 (0.88 - 5.32)	15.85	99
15+22+22+22+35+42	1.14	1.67	1.67	1.67	2.66	3.19	12.00 (3.50 - 13.50)	3.61 (0.88 - 5.32)	15.85	99
15+22+22+22+35+50	1.08	1.59	1.59	1.59	2.53	3.61	12.00 (3.50 - 13.50)	3.61 (0.88 - 5.32)	15.85	99
15+22+22+22+35+60	1.02	1.50	1.50	1.50	2.39	4.09	12.00 (3.50 - 13.50)	3.61 (0.88 - 5.32)	15.85	99
15+22+22+22+42+42	1.09	1.60	1.60	1.60	3.05	3.05	12.00 (3.50 - 13.50)	3.61 (0.88 - 5.32)	15.85	99
15+22+22+22+42+50	1.04	1.53	1.53	1.53	2.91	3.47	12.00 (3.50 - 13.50)	3.61 (0.88 - 5.32)	15.85	99
15+22+22+25+25+25	1.34	1.97	1.97	2.24	2.24	2.24	12.00 (3.50 - 13.50)	3.65 (0.88 - 5.36)	16.03	99
15+22+22+25+25+35	1.25	1.83	1.83	2.08	2.08	2.92	12.00 (3.50 - 13.50)	3.63 (0.88 - 5.34)	15.94	99
15+22+22+25+25+42	1.19	1.75	1.75	1.99	1.99	3.34	12.00 (3.50 - 13.50)	3.61 (0.88 - 5.32)	15.85	99
15+22+22+25+25+50	1.13	1.66	1.66	1.89	1.89	3.77	12.00 (3.50 - 13.50)	3.61 (0.88 - 5.32)	15.85	99
15+22+22+25+25+60	1.07	1.56	1.56	1.78	1.78	4.26	12.00 (3.50 - 13.50)	3.61 (0.88 - 5.32)	15.85	99
15+22+22+25+25+71	1.00	1.47	1.47	1.67	1.67	4.73	12.00 (3.50 - 13.50)	3.61 (0.88 - 5.32)	15.85	99
15+22+22+25+35+35	1.17	1.71	1.71	1.95	2.73	2.73	12.00 (3.50 - 13.50)	3.61 (0.88 - 5.32)	15.85	99
15+22+22+25+35+42	1.12	1.64	1.64	1.86	2.61	3.13	12.00 (3.50 - 13.50)	3.61 (0.88 - 5.32)	15.85	99
15+22+22+25+35+50	1.07	1.56	1.56	1.78	2.49	3.55	12.00 (3.50 - 13.50)	3.61 (0.88 - 5.32)	15.85	99
15+22+22+25+35+60	1.01	1.47	1.47	1.68	2.35	4.02	12.00 (3.50 - 13.50)	3.61 (0.88 - 5.32)	15.85	99
15+22+22+25+42+42	1.07	1.57	1.57	1.79	3.00	3.00	12.00 (3.50 - 13.50)	3.61 (0.88 - 5.32)	15.85	99
15+22+22+25+42+50	1.02	1.50	1.50	1.70	2.86	3.41	12.00 (3.50 - 13.50)	3.61 (0.88 - 5.32)	15.85	99
15+22+22+35+35+35	1.10	1.61	1.61	2.56	2.56	2.56	12.00 (3.50 - 13.50)	3.61 (0.88 - 5.32)	15.85	99
15+22+22+35+35+42	1.05	1.54	1.54	2.46	2.46	2.95	12.00 (3.50 - 13.50)	3.61 (0.88 - 5.32)	15.85	99
15+22+22+35+35+50	1.01	1.47	1.47	2.35	2.35	3.35	12.00 (3.50 - 13.50)	3.61 (0.88 - 5.32)	15.85	99
15+22+22+35+42+42	1.01	1.48	1.48	2.36	2.83	2.83	12.00 (3.50 - 13.50)	3.61 (0.88 - 5.32)	15.85	99
15+22+25+35+35+42	1.03	1.52	1.72	2.41	2.41	2.90	12.00 (3.50 - 13.50)	3.61 (0.88 - 5.32)	15.85	99
15+22+35+35+35+35	1.02	1.49	2.37	2.37	2.37	2.37	12.00 (3.50 - 13.50)	3.61 (0.88 - 5.32)	15.85	99
15+25+25+25+25+25	1.29	2.14	2.14	2.14	2.14	2.14	12.00 (3.50 - 13.50)	3.64 (0.88 - 5.35)	15.99	99
15+25+25+25+25+35	1.20	2.00	2.00	2.00	2.00	2.80	12.00 (3.50 - 13.50)	3.61 (0.88 - 5.32)	15.85	99
15+25+25+25+25+42	1.15	1.91	1.91	1.91	1.91	3.21	12.00 (3.50 - 13.50)	3.61 (0.88 - 5.32)	15.85	99
15+25+25+25+25+50	1.09	1.82	1.82	1.82	1.82	3.64	12.00 (3.50 - 13.50)	3.61 (0.88 - 5.32)	15.85	99
15+25+25+25+25+60	1.03	1.71	1.71	1.71	1.71	4.11	12.00 (3.50 - 13.50)	3.61 (0.88 - 5.32)	15.85	99
15+25+25+25+35+35	1.13	1.88	1.88	1.88	2.63	2.63	12.00 (3.50 - 13.50)	3.61 (0.88 - 5.32)	15.85	99
15+25+25+25+35+42	1.08	1.80	1.80	1.80	2.51	3.02	12.00 (3.50 - 13.50)	3.61 (0.88 - 5.32)	15.85	99
15+25+25+25+35+50	1.03	1.71	1.71	1.71	2.40	3.43	12.00 (3.50 - 13.50)	3.61 (0.88 - 5.32)	15.85	99
15+25+25+25+42+42	1.03	1.72	1.72	1.72	2.90	2.90	12.00 (3.50 - 13.50)	3.61 (0.88 - 5.32)	15.85	99
15+25+25+35+35+35	1.06	1.76	1.76	2.47	2.47	2.47	12.00 (3.50 - 13.50)	3.61 (0.88 - 5.32)	15.85	99
15+25+25+35+35+42	1.02	1.69	1.69	2.37	2.37	2.85	12.00 (3.50 - 13.50)	3.61 (0.88 - 5.32)	15.85	99
15+25+35+35+35+35	1.00	1.67	2.33	2.33	2.33	2.33	12.00 (3.50 - 13.50)	3.61 (0.88 - 5.32)	15.85	99
20+20+20+20+20+20	1.90	1.90	1.90	1.90	1.90	1.90	11.40 (3.30 - 12.60)	3.92 (0.91 - 5.65)	17.22	99
20+20+20+20+20+22	1.89	1.89	1.89	1.89	1.89	2.07	11.50 (3.30 - 12.80)	3.88 (0.91 - 5.59)	17.04	99
20+20+20+20+20+25	1.87	1.87	1.87	1.87	1.87	2.34	11.70 (3.40 - 13.10)	3.79 (0.90 - 5.49)	16.64	99
20+20+20+20+20+35	1.78	1.78	1.78	1.78	1.78	3.11	12.00 (3.50 - 13.50)	3.65 (0.88 - 5.36)	16.03	99
20+20+20+20+20+42	1.69	1.69	1.69	1.69	1.69	3.55	12.00 (3.50 - 13.50)	3.63 (0.88 - 5.34)	15.94	99
20+20+20+20+20+50	1.60	1.60	1.60	1.60	1.60	4.00	12.00 (3.50 - 13.50)	3.61 (0.88 - 5.32)	15.85	99
20+20+20+20+20+60	1.50	1.50	1.50	1.50	1.50	4.50	12.00 (3.50 - 13.50)	3.61 (0.88 - 5.32)	15.85	99
20+20+20+20+20+71	1.40	1.40	1.40	1.40	1.40	4.98	12.00 (3.50 - 13.50)	3.61 (0.88 - 5.32)	15.85	99
20+20+20+20+22+22	1.87	1.87	1.87	1.87	2.06	2.06	11.60 (3.40 - 12.90)	3.83 (0.90 - 5.56)	16.82	99
20+20+20+20+22+25	1.86	1.86	1.86	1.86	2.04	2.32	11.80 (3.40 - 13.20)	3.75 (0.89 - 5.46)	16.47	99

MXZ-6C120VA COOLING

Indoor units combination	Cooling capacity (kW)						Outdoor unit power consumption (kW)	Current (A)	Power factor (%)	
	Unit A	Unit B	Unit C	Unit D	Unit E	Unit F				
20+20+20+20+22+35	1.75	1.75	1.75	1.75	1.93	3.07	12.00 (3.50 - 13.50)	3.65 (0.88 - 5.36)	16.03	99
20+20+20+20+22+42	1.67	1.67	1.67	1.67	1.83	3.50	12.00 (3.50 - 13.50)	3.63 (0.88 - 5.34)	15.94	99
20+20+20+20+22+50	1.58	1.58	1.58	1.58	1.74	3.95	12.00 (3.50 - 13.50)	3.61 (0.88 - 5.32)	15.85	99
20+20+20+20+22+60	1.48	1.48	1.48	1.48	1.63	4.44	12.00 (3.50 - 13.50)	3.61 (0.88 - 5.32)	15.85	99
20+20+20+20+22+71	1.39	1.39	1.39	1.39	1.53	4.92	12.00 (3.50 - 13.50)	3.61 (0.88 - 5.32)	15.85	99
20+20+20+20+25+25	1.83	1.83	1.83	1.83	2.29	2.29	11.90 (3.50 - 13.40)	3.70 (0.89 - 5.40)	16.25	99
20+20+20+20+25+35	1.71	1.71	1.71	1.71	2.14	3.00	12.00 (3.50 - 13.50)	3.64 (0.88 - 5.35)	15.99	99
20+20+20+20+25+42	1.63	1.63	1.63	1.63	2.04	3.43	12.00 (3.50 - 13.50)	3.62 (0.88 - 5.33)	15.90	99
20+20+20+20+25+50	1.55	1.55	1.55	1.55	1.94	3.87	12.00 (3.50 - 13.50)	3.61 (0.88 - 5.32)	15.85	99
20+20+20+20+25+60	1.45	1.45	1.45	1.45	1.82	4.36	12.00 (3.50 - 13.50)	3.61 (0.88 - 5.32)	15.85	99
20+20+20+20+25+71	1.36	1.36	1.36	1.36	1.70	4.84	12.00 (3.50 - 13.50)	3.61 (0.88 - 5.32)	15.85	99
20+20+20+20+35+35	1.60	1.60	1.60	1.60	2.80	2.80	12.00 (3.50 - 13.50)	3.61 (0.88 - 5.32)	15.85	99
20+20+20+20+35+42	1.53	1.53	1.53	1.53	2.68	3.21	12.00 (3.50 - 13.50)	3.61 (0.88 - 5.32)	15.85	99
20+20+20+20+35+50	1.45	1.45	1.45	1.45	2.55	3.64	12.00 (3.50 - 13.50)	3.61 (0.88 - 5.32)	15.85	99
20+20+20+20+35+60	1.37	1.37	1.37	1.37	2.40	4.11	12.00 (3.50 - 13.50)	3.61 (0.88 - 5.32)	15.85	99
20+20+20+20+42+42	1.46	1.46	1.46	1.46	3.07	3.07	12.00 (3.50 - 13.50)	3.61 (0.88 - 5.32)	15.85	99
20+20+20+20+42+50	1.40	1.40	1.40	1.40	2.93	3.49	12.00 (3.50 - 13.50)	3.61 (0.88 - 5.32)	15.85	99
20+20+20+20+50+50	1.33	1.33	1.33	1.33	3.33	3.33	12.00 (3.50 - 13.50)	3.61 (0.88 - 5.32)	15.85	99
20+20+20+22+22+22	1.86	1.86	1.86	2.04	2.04	2.04	11.70 (3.40 - 13.10)	3.79 (0.90 - 5.49)	16.64	99
20+20+20+22+22+25	1.84	1.84	1.84	2.03	2.03	2.31	11.90 (3.50 - 13.40)	3.70 (0.89 - 5.40)	16.25	99
20+20+20+22+22+35	1.73	1.73	1.73	1.90	1.90	3.02	12.00 (3.50 - 13.50)	3.64 (0.88 - 5.35)	15.99	99
20+20+20+22+22+42	1.64	1.64	1.64	1.81	1.81	3.45	12.00 (3.50 - 13.50)	3.62 (0.88 - 5.33)	15.90	99
20+20+20+22+22+50	1.56	1.56	1.56	1.71	1.71	3.90	12.00 (3.50 - 13.50)	3.61 (0.88 - 5.32)	15.85	99
20+20+20+22+22+60	1.46	1.46	1.46	1.61	1.61	4.39	12.00 (3.50 - 13.50)	3.61 (0.88 - 5.32)	15.85	99
20+20+20+22+22+71	1.37	1.37	1.37	1.51	1.51	4.87	12.00 (3.50 - 13.50)	3.61 (0.88 - 5.32)	15.85	99
20+20+20+22+25+25	1.82	1.82	1.82	2.00	2.27	2.27	12.00 (3.50 - 13.50)	3.66 (0.88 - 5.37)	16.07	99
20+20+20+22+25+35	1.69	1.69	1.69	1.86	2.11	2.96	12.00 (3.50 - 13.50)	3.63 (0.88 - 5.34)	15.94	99
20+20+20+22+25+42	1.61	1.61	1.61	1.77	2.01	3.38	12.00 (3.50 - 13.50)	3.61 (0.88 - 5.32)	15.85	99
20+20+20+22+25+50	1.53	1.53	1.53	1.68	1.91	3.82	12.00 (3.50 - 13.50)	3.61 (0.88 - 5.32)	15.85	99
20+20+20+22+25+60	1.44	1.44	1.44	1.58	1.80	4.31	12.00 (3.50 - 13.50)	3.61 (0.88 - 5.32)	15.85	99
20+20+20+22+25+71	1.35	1.35	1.35	1.48	1.69	4.79	12.00 (3.50 - 13.50)	3.61 (0.88 - 5.32)	15.85	99
20+20+20+22+35+35	1.58	1.58	1.58	1.74	2.76	2.76	12.00 (3.50 - 13.50)	3.61 (0.88 - 5.32)	15.85	99
20+20+20+22+35+42	1.51	1.51	1.51	1.66	2.64	3.17	12.00 (3.50 - 13.50)	3.61 (0.88 - 5.32)	15.85	99
20+20+20+22+35+50	1.44	1.44	1.44	1.58	2.51	3.59	12.00 (3.50 - 13.50)	3.61 (0.88 - 5.32)	15.85	99
20+20+20+22+35+60	1.36	1.36	1.36	1.49	2.37	4.07	12.00 (3.50 - 13.50)	3.61 (0.88 - 5.32)	15.85	99
20+20+20+22+42+42	1.45	1.45	1.45	1.59	3.04	3.04	12.00 (3.50 - 13.50)	3.61 (0.88 - 5.32)	15.85	99
20+20+20+22+42+50	1.38	1.38	1.38	1.52	2.90	3.45	12.00 (3.50 - 13.50)	3.61 (0.88 - 5.32)	15.85	99
20+20+20+25+25+25	1.78	1.78	1.78	2.22	2.22	2.22	12.00 (3.50 - 13.50)	3.65 (0.88 - 5.36)	16.03	99
20+20+20+25+25+35	1.66	1.66	1.66	2.07	2.07	2.90	12.00 (3.50 - 13.50)	3.62 (0.88 - 5.33)	15.90	99
20+20+20+25+25+42	1.58	1.58	1.58	1.97	1.97	3.32	12.00 (3.50 - 13.50)	3.61 (0.88 - 5.32)	15.85	99
20+20+20+25+25+50	1.50	1.50	1.50	1.88	1.88	3.75	12.00 (3.50 - 13.50)	3.61 (0.88 - 5.32)	15.85	99
20+20+20+25+25+60	1.41	1.41	1.41	1.76	1.76	4.24	12.00 (3.50 - 13.50)	3.61 (0.88 - 5.32)	15.85	99
20+20+20+25+35+35	1.55	1.55	1.55	1.94	2.71	2.71	12.00 (3.50 - 13.50)	3.61 (0.88 - 5.32)	15.85	99
20+20+20+25+35+42	1.48	1.48	1.48	1.85	2.59	3.11	12.00 (3.50 - 13.50)	3.61 (0.88 - 5.32)	15.85	99
20+20+20+25+35+50	1.41	1.41	1.41	1.76	2.47	3.53	12.00 (3.50 - 13.50)	3.61 (0.88 - 5.32)	15.85	99
20+20+20+25+35+60	1.33	1.33	1.33	1.67	2.33	4.00	12.00 (3.50 - 13.50)	3.61 (0.88 - 5.32)	15.85	99

MXZ-6C120VA COOLING

Indoor units combination	Cooling capacity (kW)						Outdoor unit power consumption (kW)	Current (A)	Power factor (%)
	Unit A	Unit B	Unit C	Unit D	Unit E	Unit F			
20+20+20+25+42+42	1.42	1.42	1.42	1.78	2.98	2.98	12.00 (3.50 - 13.50)	3.61 (0.88 - 5.32)	15.85 99
20+20+20+25+42+50	1.36	1.36	1.36	1.69	2.85	3.39	12.00 (3.50 - 13.50)	3.61 (0.88 - 5.32)	15.85 99
20+20+20+35+35+35	1.45	1.45	1.45	2.55	2.55	2.55	12.00 (3.50 - 13.50)	3.61 (0.88 - 5.32)	15.85 99
20+20+20+35+35+42	1.40	1.40	1.40	2.44	2.44	2.93	12.00 (3.50 - 13.50)	3.61 (0.88 - 5.32)	15.85 99
20+20+20+35+35+50	1.33	1.33	1.33	2.33	2.33	3.33	12.00 (3.50 - 13.50)	3.61 (0.88 - 5.32)	15.85 99
20+20+20+35+42+42	1.34	1.34	1.34	2.35	2.82	2.82	12.00 (3.50 - 13.50)	3.61 (0.88 - 5.32)	15.85 99
20+20+22+22+22+22	1.84	1.84	2.03	2.03	2.03	2.03	11.80 (3.40 - 13.20)	3.75 (0.89 - 5.46)	16.47 99
20+20+22+22+22+25	1.83	1.83	2.02	2.02	2.02	2.29	12.00 (3.50 - 13.50)	3.66 (0.88 - 5.37)	16.07 99
20+20+22+22+22+35	1.70	1.70	1.87	1.87	1.87	2.98	12.00 (3.50 - 13.50)	3.64 (0.88 - 5.35)	15.99 99
20+20+22+22+22+42	1.62	1.62	1.78	1.78	1.78	3.41	12.00 (3.50 - 13.50)	3.62 (0.88 - 5.33)	15.90 99
20+20+22+22+22+50	1.54	1.54	1.69	1.69	1.69	3.85	12.00 (3.50 - 13.50)	3.61 (0.88 - 5.32)	15.85 99
20+20+22+22+22+60	1.45	1.45	1.59	1.59	1.59	4.34	12.00 (3.50 - 13.50)	3.61 (0.88 - 5.32)	15.85 99
20+20+22+22+22+71	1.36	1.36	1.49	1.49	1.49	4.81	12.00 (3.50 - 13.50)	3.61 (0.88 - 5.32)	15.85 99
20+20+22+22+25+25	1.79	1.79	1.97	1.97	2.24	2.24	12.00 (3.50 - 13.50)	3.65 (0.88 - 5.36)	16.03 99
20+20+22+22+25+35	1.67	1.67	1.83	1.83	2.08	2.92	12.00 (3.50 - 13.50)	3.63 (0.88 - 5.34)	15.94 99
20+20+22+22+25+42	1.59	1.59	1.75	1.75	1.99	3.34	12.00 (3.50 - 13.50)	3.61 (0.88 - 5.32)	15.85 99
20+20+22+22+25+50	1.51	1.51	1.66	1.66	1.89	3.77	12.00 (3.50 - 13.50)	3.61 (0.88 - 5.32)	15.85 99
20+20+22+22+25+60	1.42	1.42	1.56	1.56	1.78	4.26	12.00 (3.50 - 13.50)	3.61 (0.88 - 5.32)	15.85 99
20+20+22+22+25+71	1.33	1.33	1.47	1.47	1.67	4.73	12.00 (3.50 - 13.50)	3.61 (0.88 - 5.32)	15.85 99
20+20+22+22+35+35	1.56	1.56	1.71	1.71	2.73	2.73	12.00 (3.50 - 13.50)	3.61 (0.88 - 5.32)	15.85 99
20+20+22+22+35+42	1.49	1.49	1.64	1.64	2.61	3.13	12.00 (3.50 - 13.50)	3.61 (0.88 - 5.32)	15.85 99
20+20+22+22+35+50	1.42	1.42	1.56	1.56	2.49	3.55	12.00 (3.50 - 13.50)	3.61 (0.88 - 5.32)	15.85 99
20+20+22+22+35+60	1.34	1.34	1.47	1.47	2.35	4.02	12.00 (3.50 - 13.50)	3.61 (0.88 - 5.32)	15.85 99
20+20+22+22+42+42	1.43	1.43	1.57	1.57	3.00	3.00	12.00 (3.50 - 13.50)	3.61 (0.88 - 5.32)	15.85 99
20+20+22+22+42+50	1.36	1.36	1.50	1.50	2.86	3.41	12.00 (3.50 - 13.50)	3.61 (0.88 - 5.32)	15.85 99
20+20+22+25+25+25	1.75	1.75	1.93	2.19	2.19	2.19	12.00 (3.50 - 13.50)	3.65 (0.88 - 5.36)	16.03 99
20+20+22+25+25+35	1.63	1.63	1.80	2.04	2.04	2.86	12.00 (3.50 - 13.50)	3.62 (0.88 - 5.33)	15.90 99
20+20+22+25+25+42	1.56	1.56	1.71	1.95	1.95	3.27	12.00 (3.50 - 13.50)	3.61 (0.88 - 5.32)	15.85 99
20+20+22+25+25+50	1.48	1.48	1.63	1.85	1.85	3.70	12.00 (3.50 - 13.50)	3.61 (0.88 - 5.32)	15.85 99
20+20+22+25+25+60	1.40	1.40	1.53	1.74	1.74	4.19	12.00 (3.50 - 13.50)	3.61 (0.88 - 5.32)	15.85 99
20+20+22+25+35+35	1.53	1.53	1.68	1.91	2.68	2.68	12.00 (3.50 - 13.50)	3.61 (0.88 - 5.32)	15.85 99
20+20+22+25+35+42	1.46	1.46	1.61	1.83	2.56	3.07	12.00 (3.50 - 13.50)	3.61 (0.88 - 5.32)	15.85 99
20+20+22+25+35+50	1.40	1.40	1.53	1.74	2.44	3.49	12.00 (3.50 - 13.50)	3.61 (0.88 - 5.32)	15.85 99
20+20+22+25+42+42	1.40	1.40	1.54	1.75	2.95	2.95	12.00 (3.50 - 13.50)	3.61 (0.88 - 5.32)	15.85 99
20+20+22+25+42+50	1.34	1.34	1.47	1.68	2.82	3.35	12.00 (3.50 - 13.50)	3.61 (0.88 - 5.32)	15.85 99
20+20+22+35+35+35	1.44	1.44	1.58	2.51	2.51	2.51	12.00 (3.50 - 13.50)	3.61 (0.88 - 5.32)	15.85 99
20+20+22+35+35+42	1.38	1.38	1.52	2.41	2.41	2.90	12.00 (3.50 - 13.50)	3.61 (0.88 - 5.32)	15.85 99
20+20+25+25+25+25	1.71	1.71	2.14	2.14	2.14	2.14	12.00 (3.50 - 13.50)	3.64 (0.88 - 5.35)	15.99 99
20+20+25+25+25+35	1.60	1.60	2.00	2.00	2.00	2.80	12.00 (3.50 - 13.50)	3.61 (0.88 - 5.32)	15.85 99
20+20+25+25+25+42	1.53	1.53	1.91	1.91	1.91	3.21	12.00 (3.50 - 13.50)	3.61 (0.88 - 5.32)	15.85 99
20+20+25+25+25+50	1.45	1.45	1.82	1.82	1.82	3.64	12.00 (3.50 - 13.50)	3.61 (0.88 - 5.32)	15.85 99
20+20+25+25+25+60	1.37	1.37	1.71	1.71	1.71	4.11	12.00 (3.50 - 13.50)	3.61 (0.88 - 5.32)	15.85 99
20+20+25+25+35+35	1.50	1.50	1.88	1.88	2.63	2.63	12.00 (3.50 - 13.50)	3.61 (0.88 - 5.32)	15.85 99
20+20+25+25+35+42	1.44	1.44	1.80	1.80	2.51	3.02	12.00 (3.50 - 13.50)	3.61 (0.88 - 5.32)	15.85 99
20+20+25+25+35+50	1.37	1.37	1.71	1.71	2.40	3.43	12.00 (3.50 - 13.50)	3.61 (0.88 - 5.32)	15.85 99
20+20+25+25+42+42	1.38	1.38	1.72	1.72	2.90	2.90	12.00 (3.50 - 13.50)	3.61 (0.88 - 5.32)	15.85 99

MXZ-6C120VA COOLING

Indoor units combination	Cooling capacity (kW)						Outdoor unit power consumption (kW)	Current (A)	Power factor (%)	
	Unit A	Unit B	Unit C	Unit D	Unit E	Unit F				
20+20+25+35+35+35	1.41	1.41	1.76	2.47	2.47	2.47	12.00 (3.50 - 13.50)	3.61 (0.88 - 5.32)	15.85	99
20+20+25+35+35+42	1.36	1.36	1.69	2.37	2.37	2.85	12.00 (3.50 - 13.50)	3.61 (0.88 - 5.32)	15.85	99
20+20+35+35+35+35	1.33	1.33	2.33	2.33	2.33	2.33	12.00 (3.50 - 13.50)	3.61 (0.88 - 5.32)	15.85	99
20+22+22+22+22+22	1.83	2.01	2.01	2.01	2.01	2.01	11.90 (3.50 - 13.40)	3.70 (0.89 - 5.40)	16.25	99
20+22+22+22+22+25	1.80	1.98	1.98	1.98	1.98	2.26	12.00 (3.50 - 13.50)	3.66 (0.88 - 5.37)	16.07	99
20+22+22+22+22+35	1.68	1.85	1.85	1.85	1.85	2.94	12.00 (3.50 - 13.50)	3.63 (0.88 - 5.34)	15.94	99
20+22+22+22+22+42	1.60	1.76	1.76	1.76	1.76	3.36	12.00 (3.50 - 13.50)	3.61 (0.88 - 5.32)	15.85	99
20+22+22+22+22+50	1.52	1.67	1.67	1.67	1.67	3.80	12.00 (3.50 - 13.50)	3.61 (0.88 - 5.32)	15.85	99
20+22+22+22+22+60	1.43	1.57	1.57	1.57	1.57	4.29	12.00 (3.50 - 13.50)	3.61 (0.88 - 5.32)	15.85	99
20+22+22+22+22+71	1.34	1.47	1.47	1.47	1.47	4.76	12.00 (3.50 - 13.50)	3.61 (0.88 - 5.32)	15.85	99
20+22+22+22+25+25	1.76	1.94	1.94	1.94	2.21	2.21	12.00 (3.50 - 13.50)	3.65 (0.88 - 5.36)	16.03	99
20+22+22+22+25+35	1.64	1.81	1.81	1.81	2.05	2.88	12.00 (3.50 - 13.50)	3.62 (0.88 - 5.33)	15.90	99
20+22+22+22+25+42	1.57	1.73	1.73	1.73	1.96	3.29	12.00 (3.50 - 13.50)	3.61 (0.88 - 5.32)	15.85	99
20+22+22+22+25+50	1.49	1.64	1.64	1.64	1.86	3.73	12.00 (3.50 - 13.50)	3.61 (0.88 - 5.32)	15.85	99
20+22+22+22+25+60	1.40	1.54	1.54	1.54	1.75	4.21	12.00 (3.50 - 13.50)	3.61 (0.88 - 5.32)	15.85	99
20+22+22+22+35+35	1.54	1.69	1.69	1.69	2.69	2.69	12.00 (3.50 - 13.50)	3.61 (0.88 - 5.32)	15.85	99
20+22+22+22+35+42	1.47	1.62	1.62	1.62	2.58	3.09	12.00 (3.50 - 13.50)	3.61 (0.88 - 5.32)	15.85	99
20+22+22+22+35+50	1.40	1.54	1.54	1.54	2.46	3.51	12.00 (3.50 - 13.50)	3.61 (0.88 - 5.32)	15.85	99
20+22+22+22+42+42	1.41	1.55	1.55	1.55	2.96	2.96	12.00 (3.50 - 13.50)	3.61 (0.88 - 5.32)	15.85	99
20+22+22+22+42+50	1.35	1.48	1.48	1.48	2.83	3.37	12.00 (3.50 - 13.50)	3.61 (0.88 - 5.32)	15.85	99
20+22+22+25+25+25	1.73	1.90	1.90	2.16	2.16	2.16	12.00 (3.50 - 13.50)	3.64 (0.88 - 5.35)	15.99	99
20+22+22+25+25+35	1.61	1.77	1.77	2.01	2.01	2.82	12.00 (3.50 - 13.50)	3.61 (0.88 - 5.32)	15.85	99
20+22+22+25+25+42	1.54	1.69	1.69	1.92	1.92	3.23	12.00 (3.50 - 13.50)	3.61 (0.88 - 5.32)	15.85	99
20+22+22+25+25+50	1.46	1.61	1.61	1.83	1.83	3.66	12.00 (3.50 - 13.50)	3.61 (0.88 - 5.32)	15.85	99
20+22+22+25+25+60	1.38	1.52	1.52	1.72	1.72	4.14	12.00 (3.50 - 13.50)	3.61 (0.88 - 5.32)	15.85	99
20+22+22+25+35+35	1.51	1.66	1.66	1.89	2.64	2.64	12.00 (3.50 - 13.50)	3.61 (0.88 - 5.32)	15.85	99
20+22+22+25+35+42	1.45	1.59	1.59	1.81	2.53	3.04	12.00 (3.50 - 13.50)	3.61 (0.88 - 5.32)	15.85	99
20+22+22+25+35+50	1.38	1.52	1.52	1.72	2.41	3.45	12.00 (3.50 - 13.50)	3.61 (0.88 - 5.32)	15.85	99
20+22+22+25+42+42	1.39	1.53	1.53	1.73	2.91	2.91	12.00 (3.50 - 13.50)	3.61 (0.88 - 5.32)	15.85	99
20+22+22+35+35+35	1.42	1.56	1.56	2.49	2.49	2.49	12.00 (3.50 - 13.50)	3.61 (0.88 - 5.32)	15.85	99
20+22+22+35+35+42	1.36	1.50	1.50	2.39	2.39	2.86	12.00 (3.50 - 13.50)	3.61 (0.88 - 5.32)	15.85	99
20+22+25+25+25+25	1.69	1.86	2.11	2.11	2.11	2.11	12.00 (3.50 - 13.50)	3.63 (0.88 - 5.34)	15.94	99
20+22+25+25+25+35	1.58	1.74	1.97	1.97	1.97	2.76	12.00 (3.50 - 13.50)	3.61 (0.88 - 5.32)	15.85	99
20+22+25+25+25+42	1.51	1.66	1.89	1.89	1.89	3.17	12.00 (3.50 - 13.50)	3.61 (0.88 - 5.32)	15.85	99
20+22+25+25+25+50	1.44	1.58	1.80	1.80	1.80	3.59	12.00 (3.50 - 13.50)	3.61 (0.88 - 5.32)	15.85	99
20+22+25+25+25+60	1.36	1.49	1.69	1.69	1.69	4.07	12.00 (3.50 - 13.50)	3.61 (0.88 - 5.32)	15.85	99
20+22+25+25+35+35	1.48	1.63	1.85	1.85	2.59	2.59	12.00 (3.50 - 13.50)	3.61 (0.88 - 5.32)	15.85	99
20+22+25+25+35+42	1.42	1.56	1.78	1.78	2.49	2.98	12.00 (3.50 - 13.50)	3.61 (0.88 - 5.32)	15.85	99
20+22+25+25+35+50	1.36	1.49	1.69	1.69	2.37	3.39	12.00 (3.50 - 13.50)	3.61 (0.88 - 5.32)	15.85	99
20+22+25+25+42+42	1.36	1.50	1.70	1.70	2.86	2.86	12.00 (3.50 - 13.50)	3.61 (0.88 - 5.32)	15.85	99
20+22+25+35+35+35	1.40	1.53	1.74	2.44	2.44	2.44	12.00 (3.50 - 13.50)	3.61 (0.88 - 5.32)	15.85	99
20+22+25+35+35+42	1.34	1.47	1.68	2.35	2.35	2.82	12.00 (3.50 - 13.50)	3.61 (0.88 - 5.32)	15.85	99
20+25+25+25+25+25	1.66	2.07	2.07	2.07	2.07	2.07	12.00 (3.50 - 13.50)	3.62 (0.88 - 5.33)	15.90	99
20+25+25+25+25+35	1.55	1.94	1.94	1.94	1.94	2.71	12.00 (3.50 - 13.50)	3.61 (0.88 - 5.32)	15.85	99
20+25+25+25+25+42	1.48	1.85	1.85	1.85	1.85	3.11	12.00 (3.50 - 13.50)	3.61 (0.88 - 5.32)	15.85	99
20+25+25+25+25+50	1.41	1.76	1.76	1.76	1.76	3.53	12.00 (3.50 - 13.50)	3.61 (0.88 - 5.32)	15.85	99

MXZ-6C120VA COOLING

Indoor units combination	Cooling capacity (kW)						Outdoor unit power consumption (kW)	Current (A)	Power factor (%)	
	Unit A	Unit B	Unit C	Unit D	Unit E	Unit F				
20+25+25+25+25+60	1.33	1.67	1.67	1.67	1.67	4.00	12.00 (3.50 - 13.50)	3.61 (0.88 - 5.32)	15.85	99
20+25+25+25+35+35	1.45	1.82	1.82	1.82	2.55	2.55	12.00 (3.50 - 13.50)	3.61 (0.88 - 5.32)	15.85	99
20+25+25+25+35+42	1.40	1.74	1.74	1.74	2.44	2.93	12.00 (3.50 - 13.50)	3.61 (0.88 - 5.32)	15.85	99
20+25+25+25+35+50	1.33	1.67	1.67	1.67	2.33	3.33	12.00 (3.50 - 13.50)	3.61 (0.88 - 5.32)	15.85	99
20+25+25+25+42+42	1.34	1.68	1.68	1.68	2.82	2.82	12.00 (3.50 - 13.50)	3.61 (0.88 - 5.32)	15.85	99
20+25+25+35+35+35	1.37	1.71	1.71	2.40	2.40	2.40	12.00 (3.50 - 13.50)	3.61 (0.88 - 5.32)	15.85	99
22+22+22+22+22+22	2.00	2.00	2.00	2.00	2.00	2.00	12.00 (3.50 - 13.50)	3.66 (0.88 - 5.37)	16.07	99
22+22+22+22+22+25	1.96	1.96	1.96	1.96	1.96	2.22	12.00 (3.50 - 13.50)	3.65 (0.88 - 5.36)	16.03	99
22+22+22+22+22+35	1.82	1.82	1.82	1.82	1.82	2.90	12.00 (3.50 - 13.50)	3.62 (0.88 - 5.33)	15.90	99
22+22+22+22+22+42	1.74	1.74	1.74	1.74	1.74	3.32	12.00 (3.50 - 13.50)	3.61 (0.88 - 5.32)	15.85	99
22+22+22+22+22+50	1.65	1.65	1.65	1.65	1.65	3.75	12.00 (3.50 - 13.50)	3.61 (0.88 - 5.32)	15.85	99
22+22+22+22+22+60	1.55	1.55	1.55	1.55	1.55	4.24	12.00 (3.50 - 13.50)	3.61 (0.88 - 5.32)	15.85	99
22+22+22+22+25+25	1.91	1.91	1.91	1.91	2.17	2.17	12.00 (3.50 - 13.50)	3.64 (0.88 - 5.35)	15.99	99
22+22+22+22+25+35	1.78	1.78	1.78	1.78	2.03	2.84	12.00 (3.50 - 13.50)	3.62 (0.88 - 5.33)	15.90	99
22+22+22+22+25+42	1.70	1.70	1.70	1.70	1.94	3.25	12.00 (3.50 - 13.50)	3.61 (0.88 - 5.32)	15.85	99
22+22+22+22+25+50	1.62	1.62	1.62	1.62	1.84	3.68	12.00 (3.50 - 13.50)	3.61 (0.88 - 5.32)	15.85	99
22+22+22+22+25+60	1.53	1.53	1.53	1.53	1.73	4.16	12.00 (3.50 - 13.50)	3.61 (0.88 - 5.32)	15.85	99
22+22+22+22+35+35	1.67	1.67	1.67	1.67	2.66	2.66	12.00 (3.50 - 13.50)	3.61 (0.88 - 5.32)	15.85	99
22+22+22+22+35+42	1.60	1.60	1.60	1.60	2.55	3.05	12.00 (3.50 - 13.50)	3.61 (0.88 - 5.32)	15.85	99
22+22+22+22+35+50	1.53	1.53	1.53	1.53	2.43	3.47	12.00 (3.50 - 13.50)	3.61 (0.88 - 5.32)	15.85	99
22+22+22+22+42+42	1.53	1.53	1.53	1.53	2.93	2.93	12.00 (3.50 - 13.50)	3.61 (0.88 - 5.32)	15.85	99
22+22+22+22+42+50	1.47	1.47	1.47	1.47	2.80	3.33	12.00 (3.50 - 13.50)	3.61 (0.88 - 5.32)	15.85	99
22+22+22+25+25+25	1.87	1.87	1.87	2.13	2.13	2.13	12.00 (3.50 - 13.50)	3.64 (0.88 - 5.35)	15.99	99
22+22+22+25+25+35	1.75	1.75	1.75	1.99	1.99	2.78	12.00 (3.50 - 13.50)	3.61 (0.88 - 5.32)	15.85	99
22+22+22+25+25+42	1.67	1.67	1.67	1.90	1.90	3.19	12.00 (3.50 - 13.50)	3.61 (0.88 - 5.32)	15.85	99
22+22+22+25+25+50	1.59	1.59	1.59	1.81	1.81	3.61	12.00 (3.50 - 13.50)	3.61 (0.88 - 5.32)	15.85	99
22+22+22+25+25+60	1.50	1.50	1.50	1.70	1.70	4.09	12.00 (3.50 - 13.50)	3.61 (0.88 - 5.32)	15.85	99
22+22+22+25+35+35	1.64	1.64	1.64	1.86	2.61	2.61	12.00 (3.50 - 13.50)	3.61 (0.88 - 5.32)	15.85	99
22+22+22+25+35+42	1.57	1.57	1.57	1.79	2.50	3.00	12.00 (3.50 - 13.50)	3.61 (0.88 - 5.32)	15.85	99
22+22+22+25+35+50	1.50	1.50	1.50	1.70	2.39	3.41	12.00 (3.50 - 13.50)	3.61 (0.88 - 5.32)	15.85	99
22+22+22+25+42+42	1.51	1.51	1.51	1.71	2.88	2.88	12.00 (3.50 - 13.50)	3.61 (0.88 - 5.32)	15.85	99
22+22+22+35+35+35	1.54	1.54	1.54	2.46	2.46	2.46	12.00 (3.50 - 13.50)	3.61 (0.88 - 5.32)	15.85	99
22+22+22+35+35+42	1.48	1.48	1.48	2.36	2.36	2.83	12.00 (3.50 - 13.50)	3.61 (0.88 - 5.32)	15.85	99
22+22+25+25+25+25	1.83	1.83	2.08	2.08	2.08	2.08	12.00 (3.50 - 13.50)	3.63 (0.88 - 5.34)	15.94	99
22+22+25+25+25+35	1.71	1.71	1.95	1.95	1.95	2.73	12.00 (3.50 - 13.50)	3.61 (0.88 - 5.32)	15.85	99
22+22+25+25+25+42	1.64	1.64	1.86	1.86	1.86	3.13	12.00 (3.50 - 13.50)	3.61 (0.88 - 5.32)	15.85	99
22+22+25+25+25+50	1.56	1.56	1.78	1.78	1.78	3.55	12.00 (3.50 - 13.50)	3.61 (0.88 - 5.32)	15.85	99
22+22+25+25+25+60	1.47	1.47	1.68	1.68	1.68	4.02	12.00 (3.50 - 13.50)	3.61 (0.88 - 5.32)	15.85	99
22+22+25+25+35+35	1.61	1.61	1.83	1.83	2.56	2.56	12.00 (3.50 - 13.50)	3.61 (0.88 - 5.32)	15.85	99
22+22+25+25+35+42	1.54	1.54	1.75	1.75	2.46	2.95	12.00 (3.50 - 13.50)	3.61 (0.88 - 5.32)	15.85	99
22+22+25+25+35+50	1.47	1.47	1.68	1.68	2.35	3.35	12.00 (3.50 - 13.50)	3.61 (0.88 - 5.32)	15.85	99
22+22+25+25+42+42	1.48	1.48	1.69	1.69	2.83	2.83	12.00 (3.50 - 13.50)	3.61 (0.88 - 5.32)	15.85	99
22+22+25+35+35+35	1.52	1.52	1.72	2.41	2.41	2.41	12.00 (3.50 - 13.50)	3.61 (0.88 - 5.32)	15.85	99
22+25+25+25+25+25	1.80	2.04	2.04	2.04	2.04	2.04	12.00 (3.50 - 13.50)	3.62 (0.88 - 5.33)	15.90	99
22+25+25+25+25+35	1.68	1.91	1.91	1.91	1.91	2.68	12.00 (3.50 - 13.50)	3.61 (0.88 - 5.32)	15.85	99
22+25+25+25+25+42	1.61	1.83	1.83	1.83	1.83	3.07	12.00 (3.50 - 13.50)	3.61 (0.88 - 5.32)	15.85	99

MXZ-6C120VA COOLING

Indoor units combination	Cooling capacity (kW)						Outdoor unit power consumption (kW)	Current (A)	Power factor (%)	
	Unit A	Unit B	Unit C	Unit D	Unit E	Unit F				Total
22+25+25+25+25+50	1.53	1.74	1.74	1.74	1.74	3.49	12.00 (3.50 - 13.50)	3.61 (0.88 - 5.32)	15.85	99
22+25+25+25+35+35	1.58	1.80	1.80	1.80	2.51	2.51	12.00 (3.50 - 13.50)	3.61 (0.88 - 5.32)	15.85	99
22+25+25+25+35+42	1.52	1.72	1.72	1.72	2.41	2.90	12.00 (3.50 - 13.50)	3.61 (0.88 - 5.32)	15.85	99
22+25+25+35+35+35	1.49	1.69	1.69	2.37	2.37	2.37	12.00 (3.50 - 13.50)	3.61 (0.88 - 5.32)	15.85	99
25+25+25+25+25+25	2.00	2.00	2.00	2.00	2.00	2.00	12.00 (3.50 - 13.50)	3.61 (0.88 - 5.32)	15.85	99
25+25+25+25+25+35	1.88	1.88	1.88	1.88	1.88	2.63	12.00 (3.50 - 13.50)	3.61 (0.88 - 5.32)	15.85	99
25+25+25+25+25+42	1.80	1.80	1.80	1.80	1.80	3.02	12.00 (3.50 - 13.50)	3.61 (0.88 - 5.32)	15.85	99
25+25+25+25+25+50	1.71	1.71	1.71	1.71	1.71	3.43	12.00 (3.50 - 13.50)	3.61 (0.88 - 5.32)	15.85	99
25+25+25+25+35+35	1.76	1.76	1.76	1.76	2.47	2.47	12.00 (3.50 - 13.50)	3.61 (0.88 - 5.32)	15.85	99
25+25+25+25+35+42	1.69	1.69	1.69	1.69	2.37	2.85	12.00 (3.50 - 13.50)	3.61 (0.88 - 5.32)	15.85	99
25+25+25+35+35+35	1.67	1.67	1.67	2.33	2.33	2.33	12.00 (3.50 - 13.50)	3.61 (0.88 - 5.32)	15.85	99

MXZ-6C120VA HEATING

Indoor units combination	Heating capacity (kW)						Total	Outdoor unit power consumption(kW)	Current (A)	Power factor (%)
	Unit A	Unit B	Unit C	Unit D	Unit E	Unit F				
15	1.70						1.70 (1.50 - 3.00)	1.03 (0.91 - 1.92)	4.71	95
20	2.20						2.20 (2.00 - 3.90)	1.07 (0.98 - 2.51)	4.90	95
22	3.30						3.30 (2.70 - 4.20)	1.11 (0.96 - 1.36)	5.08	95
25	3.60						3.60 (2.70 - 4.50)	1.17 (0.96 - 1.45)	5.35	95
35	4.00						4.00 (2.70 - 5.50)	1.14 (0.96 - 1.81)	5.22	95
42	5.40						5.40 (2.70 - 6.50)	1.61 (0.96 - 2.26)	7.37	95
50	7.20						7.20 (2.70 - 7.70)	2.27 (0.96 - 2.71)	10.39	95
60	7.90						7.90 (2.70 - 9.30)	2.27 (0.85 - 3.31)	10.39	95
71	8.60						8.60 (2.70 - 9.90)	2.41 (0.85 - 3.79)	11.03	95
15+15	1.70	1.70					3.40 (2.70 - 5.30)	0.94 (0.91 - 3.35)	4.21	97
15+20	1.67	2.23					3.90 (2.70 - 6.20)	1.09 (0.91 - 3.27)	4.89	97
15+22	1.66	2.44					4.10 (2.70 - 6.50)	1.14 (0.91 - 3.24)	5.11	97
15+25	1.65	2.75					4.40 (2.70 - 7.00)	1.23 (0.91 - 3.19)	5.51	97
15+35	2.16	5.04					7.20 (2.80 - 9.00)	1.95 (0.83 - 2.70)	8.74	97
15+42	1.97	5.53					7.50 (2.80 - 9.50)	2.09 (0.83 - 2.97)	9.37	97
15+50	1.80	6.00					7.80 (2.80 - 10.10)	2.22 (0.83 - 3.30)	9.95	97
15+60	1.80	7.20					9.00 (2.80 - 10.90)	2.63 (0.83 - 3.45)	11.79	97
15+71	1.90	9.00					10.90 (2.80 - 11.80)	3.46 (0.83 - 3.76)	15.51	97
20+20	2.20	2.20					4.40 (2.70 - 7.00)	1.23 (0.91 - 3.19)	5.51	97
20+22	2.62	2.88					5.50 (2.80 - 7.30)	1.49 (0.87 - 2.70)	6.68	97
20+25	2.98	3.72					6.70 (2.80 - 7.80)	1.78 (0.83 - 2.27)	7.98	97
20+35	2.69	4.71					7.40 (2.80 - 9.40)	2.04 (0.83 - 2.92)	9.14	97
20+42	2.48	5.22					7.70 (2.80 - 9.80)	2.18 (0.83 - 3.13)	9.77	97
20+50	2.29	5.71					8.00 (2.80 - 10.40)	2.31 (0.83 - 3.46)	10.35	97
20+60	2.50	7.50					10.00 (2.80 - 11.30)	3.09 (0.83 - 3.59)	13.85	97
20+71	2.42	8.58					11.00 (2.80 - 12.10)	3.46 (0.83 - 3.81)	15.51	97
22+22	3.30	3.30					6.60 (2.80 - 7.60)	1.74 (0.83 - 2.20)	7.80	97
22+25	3.23	3.67					6.90 (2.80 - 8.30)	1.85 (0.83 - 2.45)	8.29	97
22+35	2.89	4.61					7.50 (2.80 - 9.50)	2.09 (0.83 - 2.97)	9.37	97
22+42	2.68	5.12					7.80 (2.80 - 10.00)	2.22 (0.83 - 3.24)	9.95	97
22+50	2.57	5.83					8.40 (2.80 - 10.60)	2.36 (0.83 - 3.34)	10.58	97
22+60	2.79	7.61					10.40 (2.80 - 11.50)	3.27 (0.83 - 3.67)	14.66	97
22+71	2.63	8.47					11.10 (2.80 - 12.30)	3.47 (0.83 - 3.85)	15.55	97
25+25	3.60	3.60					7.20 (2.80 - 9.00)	1.95 (0.83 - 2.70)	8.74	97
25+35	3.17	4.43					7.60 (2.80 - 9.70)	2.13 (0.83 - 3.08)	9.55	97
25+42	2.95	4.95					7.90 (2.80 - 10.20)	2.27 (0.83 - 3.35)	10.17	97
25+50	3.00	6.00					9.00 (2.80 - 10.90)	2.63 (0.83 - 3.45)	11.79	97
25+60	3.18	7.62					10.80 (2.80 - 11.80)	3.45 (0.83 - 3.76)	15.46	97
25+71	2.92	8.28					11.20 (2.80 - 12.50)	3.47 (0.83 - 3.88)	15.55	97
35+35	4.00	4.00					8.00 (2.80 - 10.40)	2.31 (0.83 - 3.46)	10.35	97
35+42	4.27	5.13					9.40 (2.80 - 11.10)	2.81 (0.83 - 3.52)	12.60	97
35+50	4.45	6.35					10.80 (2.80 - 11.80)	3.45 (0.83 - 3.76)	15.46	97
35+60	4.09	7.01					11.10 (2.80 - 12.40)	3.47 (0.83 - 3.87)	15.55	97
35+71	3.73	7.57					11.30 (2.80 - 12.70)	3.38 (0.82 - 3.92)	15.15	97
42+42	5.40	5.40					10.80 (2.80 - 11.70)	3.45 (0.83 - 3.74)	15.46	97
42+50	5.07	6.03					11.10 (2.80 - 12.20)	3.47 (0.83 - 3.83)	15.55	97

MXZ-6C120VA HEATING

Indoor units combination	Heating capacity (kW)						Outdoor unit power consumption (kW)	Current (A)	Power factor (%)	
	Unit A	Unit B	Unit C	Unit D	Unit E	Unit F				
42+60	4.65	6.65					11.30 (2.80 - 12.70)	3.45 (0.83 - 3.92)	15.46	97
42+71	4.20	7.10					11.30 (2.80 - 12.80)	3.27 (0.81 - 3.59)	14.66	97
50+50	5.65	5.65					11.30 (2.80 - 12.70)	3.48 (0.83 - 3.92)	15.60	97
50+60	5.14	6.16					11.30 (2.80 - 12.80)	3.32 (0.82 - 3.59)	14.88	97
50+71	4.67	6.63					11.30 (2.80 - 12.80)	3.15 (0.80 - 3.59)	14.12	97
60+60	5.65	5.65					11.30 (2.80 - 12.80)	3.15 (0.80 - 3.59)	14.12	97
60+71	5.18	6.12					11.30 (2.80 - 12.90)	3.12 (0.80 - 3.57)	13.98	97
71+71	5.65	5.65					11.30 (2.80 - 13.00)	3.08 (0.80 - 3.55)	13.81	97
15+15+15	1.70	1.70	1.70				5.10 (3.10 - 8.90)	1.13 (0.82 - 3.99)	5.06	97
15+15+20	1.68	1.68	2.24				5.60 (3.10 - 9.40)	1.28 (0.82 - 4.22)	5.74	97
15+15+22	1.67	1.67	2.45				5.80 (3.10 - 9.60)	1.34 (0.82 - 4.31)	6.01	97
15+15+25	1.66	1.66	2.77				6.10 (3.10 - 10.00)	1.43 (0.82 - 4.49)	6.41	97
15+15+35	2.17	2.17	5.06				9.40 (3.20 - 12.30)	2.35 (0.78 - 4.27)	10.53	97
15+15+42	2.19	2.19	6.13				10.50 (3.20 - 13.20)	2.82 (0.77 - 4.28)	12.64	97
15+15+50	2.06	2.06	6.88				11.00 (3.20 - 13.70)	3.12 (0.77 - 4.44)	13.98	97
15+15+60	1.90	1.90	7.60				11.40 (3.20 - 14.00)	3.37 (0.77 - 4.63)	15.11	97
15+15+71	1.75	1.75	8.30				11.80 (3.20 - 14.40)	3.62 (0.77 - 4.88)	16.23	97
15+20+20	1.66	2.22	2.22				6.10 (3.10 - 10.00)	1.43 (0.82 - 4.49)	6.41	97
15+20+22	1.66	2.21	2.43				6.30 (3.10 - 10.20)	1.49 (0.82 - 4.58)	6.68	97
15+20+25	1.65	2.20	2.75				6.60 (3.10 - 10.50)	1.58 (0.82 - 4.72)	7.08	97
15+20+35	2.21	2.94	5.15				10.30 (3.20 - 13.00)	2.71 (0.77 - 4.25)	12.15	97
15+20+42	2.12	2.83	5.95				10.90 (3.20 - 13.60)	3.05 (0.77 - 4.38)	13.67	97
15+20+50	1.98	2.64	6.59				11.20 (3.20 - 13.80)	3.24 (0.77 - 4.51)	14.52	97
15+20+60	1.83	2.44	7.33				11.60 (3.20 - 14.20)	3.50 (0.77 - 4.75)	15.69	97
15+20+71	1.70	2.26	8.04				12.00 (3.20 - 14.50)	3.75 (0.77 - 4.94)	16.81	97
15+22+22	1.65	2.42	2.42				6.50 (3.10 - 10.40)	1.55 (0.82 - 4.67)	6.95	97
15+22+25	1.86	2.73	3.10				7.70 (3.10 - 11.20)	1.88 (0.80 - 4.54)	8.43	97
15+22+35	2.19	3.21	5.10				10.50 (3.20 - 13.20)	2.82 (0.77 - 4.28)	12.64	97
15+22+42	2.09	3.06	5.85				11.00 (3.20 - 13.60)	3.12 (0.77 - 4.38)	13.98	97
15+22+50	1.95	2.86	6.49				11.30 (3.20 - 13.90)	3.31 (0.77 - 4.57)	14.84	97
15+22+60	1.81	2.65	7.24				11.70 (3.20 - 14.20)	3.56 (0.77 - 4.75)	15.96	97
15+22+71	1.68	2.46	7.95				12.10 (3.20 - 14.50)	3.79 (0.77 - 4.94)	16.99	97
15+25+25	2.17	3.62	3.62				9.40 (3.20 - 12.30)	2.35 (0.78 - 4.27)	10.53	97
15+25+35	2.16	3.60	5.04				10.80 (3.20 - 13.50)	2.99 (0.77 - 4.32)	13.40	97
15+25+42	2.03	3.38	5.69				11.10 (3.20 - 13.70)	3.18 (0.77 - 4.44)	14.25	97
15+25+50	1.90	3.17	6.33				11.40 (3.20 - 14.00)	3.37 (0.77 - 4.63)	15.11	97
15+25+60	1.77	2.95	7.08				11.80 (3.20 - 14.30)	3.62 (0.77 - 4.82)	16.23	97
15+25+71	1.65	2.75	7.80				12.20 (3.20 - 14.60)	3.83 (0.77 - 4.85)	17.17	97
15+35+35	1.98	4.61	4.61				11.20 (3.20 - 13.80)	3.24 (0.77 - 4.51)	14.52	97
15+35+42	1.88	4.38	5.25				11.50 (3.20 - 14.10)	3.43 (0.77 - 4.69)	15.37	97
15+35+50	1.77	4.13	5.90				11.80 (3.20 - 14.30)	3.62 (0.77 - 4.82)	16.23	97
15+35+60	1.65	3.85	6.60				12.10 (3.20 - 14.50)	3.79 (0.77 - 4.94)	16.99	97
15+35+71	1.55	3.62	7.33				12.50 (3.20 - 14.70)	3.96 (0.77 - 4.75)	17.75	97
15+42+42	1.79	5.01	5.01				11.80 (3.20 - 14.30)	3.62 (0.77 - 4.82)	16.23	97
15+42+50	1.70	4.75	5.65				12.10 (3.20 - 14.50)	3.79 (0.77 - 4.94)	16.99	97
15+42+60	1.58	4.42	6.31				12.30 (3.20 - 14.60)	3.88 (0.77 - 4.85)	17.39	97

MXZ-6C120VA HEATING

Indoor units combination	Heating capacity (kW)						Outdoor unit power consumption (kW)	Current (A)	Power factor (%)
	Unit A	Unit B	Unit C	Unit D	Unit E	Unit F			
15+42+71	1.48	4.13	6.99				12.60 (3.20 - 14.70)	4.00 (0.77 - 4.75)	17.93 97
15+50+50	1.60	5.35	5.35				12.30 (3.20 - 14.60)	3.88 (0.77 - 4.85)	17.39 97
15+50+60	1.51	5.04	6.05				12.60 (3.20 - 14.70)	4.00 (0.77 - 4.75)	17.93 97
15+50+71	1.41	4.71	6.68				12.80 (3.20 - 14.70)	4.02 (0.77 - 4.75)	18.02 97
15+60+60	1.42	5.69	5.69				12.80 (3.20 - 14.70)	4.02 (0.77 - 4.75)	18.02 97
15+60+71	1.34	5.34	6.32				13.00 (3.20 - 14.80)	4.04 (0.77 - 4.56)	18.11 97
15+71+71	1.26	5.97	5.97				13.20 (3.20 - 14.90)	4.00 (0.77 - 4.57)	17.93 97
20+20+20	2.20	2.20	2.20				6.60 (3.10 - 10.50)	1.58 (0.82 - 4.72)	7.08 97
20+20+22	2.48	2.48	2.73				7.70 (3.10 - 11.20)	1.88 (0.80 - 4.54)	8.43 97
20+20+25	2.89	2.89	3.62				9.40 (3.20 - 12.30)	2.35 (0.78 - 4.27)	10.53 97
20+20+35	2.88	2.88	5.04				10.80 (3.20 - 13.50)	2.99 (0.77 - 4.32)	13.40 97
20+20+42	2.71	2.71	5.69				11.10 (3.20 - 13.70)	3.18 (0.77 - 4.44)	14.25 97
20+20+50	2.53	2.53	6.33				11.40 (3.20 - 14.00)	3.37 (0.77 - 4.63)	15.11 97
20+20+60	2.36	2.36	7.08				11.80 (3.20 - 14.30)	3.62 (0.77 - 4.82)	16.23 97
20+20+71	2.20	2.20	7.80				12.20 (3.20 - 14.60)	3.83 (0.77 - 4.85)	17.17 97
20+22+22	2.75	3.03	3.03				8.80 (3.20 - 11.90)	2.19 (0.79 - 4.37)	9.82 97
20+22+25	2.99	3.28	3.73				10.00 (3.20 - 12.70)	2.55 (0.77 - 4.20)	11.43 97
20+22+35	2.83	3.11	4.95				10.90 (3.20 - 13.60)	3.05 (0.77 - 4.38)	13.67 97
20+22+42	2.67	2.93	5.60				11.20 (3.20 - 13.80)	3.24 (0.77 - 4.51)	14.52 97
20+22+50	2.50	2.75	6.25				11.50 (3.20 - 14.10)	3.43 (0.77 - 4.69)	15.37 97
20+22+60	2.33	2.57	7.00				11.90 (3.20 - 14.40)	3.69 (0.77 - 4.88)	16.54 97
20+22+71	2.16	2.38	7.67				12.20 (3.20 - 14.60)	3.83 (0.77 - 4.85)	17.17 97
20+25+25	2.94	3.68	3.68				10.30 (3.20 - 13.00)	2.71 (0.77 - 4.25)	12.15 97
20+25+35	2.75	3.44	4.81				11.00 (3.20 - 13.70)	3.12 (0.77 - 4.44)	13.98 97
20+25+42	2.60	3.25	5.46				11.30 (3.20 - 13.90)	3.31 (0.77 - 4.57)	14.84 97
20+25+50	2.44	3.05	6.11				11.60 (3.20 - 14.20)	3.50 (0.77 - 4.75)	15.69 97
20+25+60	2.29	2.86	6.86				12.00 (3.20 - 14.50)	3.75 (0.77 - 4.94)	16.81 97
20+25+71	2.12	2.65	7.53				12.30 (3.20 - 14.60)	3.88 (0.77 - 4.85)	17.39 97
20+35+35	2.53	4.43	4.43				11.40 (3.20 - 14.00)	3.37 (0.77 - 4.63)	15.11 97
20+35+42	2.41	4.22	5.07				11.70 (3.20 - 14.20)	3.56 (0.77 - 4.75)	15.96 97
20+35+50	2.29	4.00	5.71				12.00 (3.20 - 14.50)	3.75 (0.77 - 4.94)	16.81 97
20+35+60	2.14	3.74	6.42				12.30 (3.20 - 14.60)	3.88 (0.77 - 4.85)	17.39 97
20+35+71	2.00	3.50	7.10				12.60 (3.20 - 14.70)	4.00 (0.77 - 4.75)	17.93 97
20+42+42	2.31	4.85	4.85				12.00 (3.20 - 14.50)	3.75 (0.77 - 4.94)	16.81 97
20+42+50	2.18	4.58	5.45				12.20 (3.20 - 14.60)	3.83 (0.77 - 4.85)	17.17 97
20+42+60	2.05	4.30	6.15				12.50 (3.20 - 14.70)	3.96 (0.77 - 4.75)	17.75 97
20+42+71	1.91	4.01	6.78				12.70 (3.20 - 14.70)	4.01 (0.77 - 4.75)	17.97 97
20+50+50	2.07	5.17	5.17				12.40 (3.20 - 14.60)	3.92 (0.77 - 4.85)	17.57 97
20+50+60	1.95	4.88	5.86				12.70 (3.20 - 14.70)	4.01 (0.77 - 4.75)	17.97 97
20+50+71	1.83	4.57	6.50				12.90 (3.20 - 14.80)	4.03 (0.77 - 4.56)	18.06 97
20+60+60	1.84	5.53	5.53				12.90 (3.20 - 14.80)	4.03 (0.77 - 4.56)	18.06 97
20+60+71	1.74	5.21	6.16				13.10 (3.20 - 14.80)	4.05 (0.77 - 4.56)	18.15 97
20+71+71	1.64	5.83	5.83				13.30 (3.20 - 15.00)	3.94 (0.77 - 4.58)	17.66 97
22+22+22	3.30	3.30	3.30				9.90 (3.20 - 12.60)	2.49 (0.77 - 4.19)	11.16 97
22+22+25	3.25	3.25	3.70				10.20 (3.20 - 12.90)	2.66 (0.77 - 4.23)	11.92 97
22+22+35	3.06	3.06	4.87				11.00 (3.20 - 13.60)	3.12 (0.77 - 4.38)	13.98 97

MXZ-6C120VA HEATING

Indoor units combination	Heating capacity (kW)						Outdoor unit power consumption (kW)	Current (A)	Power factor (%)	
	Unit A	Unit B	Unit C	Unit D	Unit E	Unit F				
22+22+42	2.87	2.87	5.47				11.20 (3.20 - 13.90)	3.24 (0.77 - 4.57)	14.52	97
22+22+50	2.71	2.71	6.17				11.60 (3.20 - 14.10)	3.50 (0.77 - 4.69)	15.69	97
22+22+60	2.54	2.54	6.92				12.00 (3.20 - 14.50)	3.75 (0.77 - 4.94)	16.81	97
22+22+71	2.35	2.35	7.59				12.30 (3.20 - 14.60)	3.88 (0.77 - 4.85)	17.39	97
22+25+25	3.21	3.65	3.65				10.50 (3.20 - 13.20)	2.82 (0.77 - 4.28)	12.64	97
22+25+35	2.98	3.38	4.74				11.10 (3.20 - 13.70)	3.18 (0.77 - 4.44)	14.25	97
22+25+42	2.82	3.20	5.38				11.40 (3.20 - 14.00)	3.37 (0.77 - 4.63)	15.11	97
22+25+50	2.65	3.02	6.03				11.70 (3.20 - 14.20)	3.56 (0.77 - 4.75)	15.96	97
22+25+60	2.49	2.83	6.79				12.10 (3.20 - 14.50)	3.79 (0.77 - 4.94)	16.99	97
22+25+71	2.31	2.63	7.46				12.40 (3.20 - 14.60)	3.92 (0.77 - 4.85)	17.57	97
22+35+35	2.75	4.38	4.38				11.50 (3.20 - 14.10)	3.43 (0.77 - 4.69)	15.37	97
22+35+42	2.62	4.17	5.01				11.80 (3.20 - 14.30)	3.62 (0.77 - 4.82)	16.23	97
22+35+50	2.49	3.96	5.65				12.10 (3.20 - 14.50)	3.79 (0.77 - 4.94)	16.99	97
22+35+60	2.31	3.68	6.31				12.30 (3.20 - 14.60)	3.88 (0.77 - 4.85)	17.39	97
22+35+71	2.17	3.45	6.99				12.60 (3.20 - 14.70)	4.00 (0.77 - 4.75)	17.93	97
22+42+42	2.49	4.75	4.75				12.00 (3.20 - 14.50)	3.75 (0.77 - 4.94)	16.81	97
22+42+50	2.37	4.53	5.39				12.30 (3.20 - 14.60)	3.88 (0.77 - 4.85)	17.39	97
22+42+60	2.22	4.23	6.05				12.50 (3.20 - 14.70)	3.96 (0.77 - 4.75)	17.75	97
22+42+71	2.09	3.98	6.73				12.80 (3.20 - 14.70)	4.02 (0.77 - 4.75)	18.02	97
22+50+50	2.25	5.12	5.12				12.50 (3.20 - 14.70)	3.96 (0.77 - 4.75)	17.75	97
22+50+60	2.12	4.81	5.77				12.70 (3.20 - 14.70)	4.01 (0.77 - 4.75)	17.97	97
22+50+71	2.00	4.55	6.45				13.00 (3.20 - 14.80)	4.04 (0.77 - 4.56)	18.11	97
22+60+60	2.00	5.45	5.45				12.90 (3.20 - 14.80)	4.03 (0.77 - 4.56)	18.06	97
22+60+71	1.90	5.18	6.13				13.20 (3.20 - 14.90)	4.00 (0.77 - 4.57)	17.93	97
22+71+71	1.78	5.76	5.76				13.30 (3.20 - 15.00)	3.94 (0.77 - 4.58)	17.66	97
25+25+25	3.60	3.60	3.60				10.80 (3.20 - 13.50)	2.99 (0.77 - 4.32)	13.40	97
25+25+35	3.29	3.29	4.61				11.20 (3.20 - 13.80)	3.24 (0.77 - 4.51)	14.52	97
25+25+42	3.13	3.13	5.25				11.50 (3.20 - 14.10)	3.43 (0.77 - 4.69)	15.37	97
25+25+50	2.95	2.95	5.90				11.80 (3.20 - 14.30)	3.62 (0.77 - 4.82)	16.23	97
25+25+60	2.75	2.75	6.60				12.10 (3.20 - 14.50)	3.79 (0.77 - 4.94)	16.99	97
25+25+71	2.58	2.58	7.33				12.50 (3.20 - 14.70)	3.96 (0.77 - 4.75)	17.75	97
25+35+35	3.05	4.27	4.27				11.60 (3.20 - 14.20)	3.50 (0.77 - 4.75)	15.69	97
25+35+42	2.92	4.08	4.90				11.90 (3.20 - 14.40)	3.69 (0.77 - 4.88)	16.54	97
25+35+50	2.75	3.85	5.50				12.10 (3.20 - 14.50)	3.79 (0.77 - 4.94)	16.99	97
25+35+60	2.58	3.62	6.20				12.40 (3.20 - 14.60)	3.92 (0.77 - 4.85)	17.57	97
25+35+71	2.42	3.39	6.88				12.70 (3.20 - 14.70)	4.01 (0.77 - 4.75)	17.97	97
25+42+42	2.78	4.66	4.66				12.10 (3.20 - 14.50)	3.79 (0.77 - 4.94)	16.99	97
25+42+50	2.63	4.42	5.26				12.30 (3.20 - 14.60)	3.88 (0.77 - 4.85)	17.39	97
25+42+60	2.48	4.17	5.95				12.60 (3.20 - 14.70)	4.00 (0.77 - 4.75)	17.93	97
25+42+71	2.34	3.93	6.64				12.90 (3.20 - 14.80)	4.03 (0.77 - 4.56)	18.06	97
25+50+50	2.52	5.04	5.04				12.60 (3.20 - 14.70)	4.00 (0.77 - 4.75)	17.93	97
25+50+60	2.37	4.74	5.69				12.80 (3.20 - 14.70)	4.02 (0.77 - 4.75)	18.02	97
25+50+71	2.23	4.45	6.32				13.00 (3.20 - 14.80)	4.04 (0.77 - 4.56)	18.11	97
25+60+60	2.24	5.38	5.38				13.00 (3.20 - 14.80)	4.04 (0.77 - 4.56)	18.11	97
25+60+71	2.12	5.08	6.01				13.20 (3.20 - 14.90)	4.00 (0.77 - 4.57)	17.93	97
25+71+71	2.01	5.70	5.70				13.40 (3.20 - 15.10)	3.89 (0.76 - 4.60)	17.44	97

MXZ-6C120VA HEATING

Indoor units combination	Heating capacity (kW)						Outdoor unit power consumption (kW)	Current (A)	Power factor (%)
	Unit A	Unit B	Unit C	Unit D	Unit E	Unit F			
35+35+35	4.00	4.00	4.00				12.00 (3.20 - 14.50)	3.75 (0.77 - 4.94)	16.81 97
35+35+42	3.81	3.81	4.58				12.20 (3.20 - 14.60)	3.83 (0.77 - 4.85)	17.17 97
35+35+50	3.62	3.62	5.17				12.40 (3.20 - 14.60)	3.92 (0.77 - 4.85)	17.57 97
35+35+60	3.42	3.42	5.86				12.70 (3.20 - 14.70)	4.01 (0.77 - 4.75)	17.97 97
35+35+71	3.20	3.20	6.50				12.90 (3.20 - 14.80)	4.03 (0.77 - 4.56)	18.06 97
35+42+42	3.65	4.38	4.38				12.40 (3.20 - 14.60)	3.92 (0.77 - 4.85)	17.57 97
35+42+50	3.47	4.17	4.96				12.60 (3.20 - 14.70)	4.00 (0.77 - 4.75)	17.93 97
35+42+60	3.27	3.92	5.61				12.80 (3.20 - 14.70)	4.02 (0.77 - 4.75)	18.02 97
35+42+71	3.10	3.72	6.28				13.10 (3.20 - 14.80)	4.05 (0.77 - 4.56)	18.15 97
35+50+50	3.32	4.74	4.74				12.80 (3.20 - 14.70)	4.02 (0.77 - 4.75)	18.02 97
35+50+60	3.14	4.48	5.38				13.00 (3.20 - 14.80)	4.04 (0.77 - 4.56)	18.11 97
35+50+71	2.96	4.23	6.01				13.20 (3.20 - 14.90)	4.00 (0.77 - 4.57)	17.93 97
35+60+60	2.98	5.11	5.11				13.20 (3.20 - 14.90)	4.00 (0.77 - 4.57)	17.93 97
35+60+71	2.83	4.84	5.73				13.40 (3.20 - 15.10)	3.89 (0.76 - 4.60)	17.44 97
35+71+71	2.69	5.46	5.46				13.60 (3.20 - 15.30)	3.78 (0.76 - 4.62)	16.94 97
42+42+42	4.20	4.20	4.20				12.60 (3.20 - 14.70)	4.00 (0.77 - 4.75)	17.93 97
42+42+50	4.01	4.01	4.78				12.80 (3.20 - 14.70)	4.02 (0.77 - 4.75)	18.02 97
42+42+60	3.79	3.79	5.42				13.00 (3.20 - 14.80)	4.04 (0.77 - 4.56)	18.11 97
42+42+71	3.58	3.58	6.05				13.20 (3.20 - 14.90)	4.00 (0.77 - 4.57)	17.93 97
42+50+50	3.82	4.54	4.54				12.90 (3.20 - 14.80)	4.03 (0.77 - 4.56)	18.06 97
42+50+60	3.62	4.31	5.17				13.10 (3.20 - 14.80)	4.05 (0.77 - 4.56)	18.15 97
42+50+71	3.43	4.08	5.79				13.30 (3.20 - 15.00)	3.94 (0.77 - 4.58)	17.66 97
42+60+60	3.45	4.93	4.93				13.30 (3.20 - 15.00)	3.94 (0.77 - 4.58)	17.66 97
42+60+71	3.28	4.68	5.54				13.50 (3.20 - 15.20)	3.83 (0.76 - 4.61)	17.17 97
50+50+50	4.37	4.37	4.37				13.10 (3.20 - 14.80)	4.05 (0.77 - 4.56)	18.15 97
50+50+60	4.16	4.16	4.99				13.30 (3.20 - 15.00)	3.94 (0.77 - 4.58)	17.66 97
50+50+71	3.95	3.95	5.61				13.50 (3.20 - 15.20)	3.83 (0.76 - 4.61)	17.17 97
50+60+60	3.94	4.73	4.73				13.40 (3.20 - 15.10)	3.89 (0.76 - 4.60)	17.44 97
60+60+60	4.53	4.53	4.53				13.60 (3.20 - 15.30)	3.78 (0.76 - 4.62)	16.94 97
15+15+15+15	1.70	1.70	1.70	1.70			6.80 (3.10 - 9.90)	1.50 (0.79 - 3.23)	6.59 99
15+15+15+20	1.68	1.68	1.68	2.25			7.30 (3.10 - 9.90)	1.69 (0.79 - 3.23)	7.42 99
15+15+15+22	1.68	1.68	1.68	2.46			7.50 (3.10 - 10.20)	1.76 (0.79 - 3.33)	7.73 99
15+15+15+25	1.67	1.67	1.67	2.79			7.80 (3.10 - 10.70)	1.87 (0.79 - 3.50)	8.21 99
15+15+15+35	1.65	1.65	1.65	3.85			8.80 (3.10 - 13.20)	2.24 (0.79 - 4.33)	9.84 99
15+15+15+42	1.91	1.91	1.91	5.36			11.10 (3.20 - 14.40)	2.74 (0.76 - 4.09)	12.03 99
15+15+15+50	1.86	1.86	1.86	6.21			11.80 (3.20 - 14.80)	2.98 (0.76 - 4.18)	13.09 99
15+15+15+60	1.74	1.74	1.74	6.97			12.20 (3.20 - 14.90)	3.19 (0.76 - 4.25)	14.01 99
15+15+15+71	1.62	1.62	1.62	7.65			12.50 (3.20 - 14.90)	3.37 (0.76 - 4.25)	14.80 99
15+15+20+20	1.67	1.67	2.23	2.23			7.80 (3.10 - 10.70)	1.87 (0.79 - 3.50)	8.21 99
15+15+20+22	1.67	1.67	2.22	2.44			8.00 (3.10 - 11.10)	1.94 (0.79 - 3.63)	8.52 99
15+15+20+25	1.66	1.66	2.21	2.77			8.30 (3.10 - 11.60)	2.06 (0.79 - 3.80)	9.05 99
15+15+20+35	1.84	1.84	2.45	4.28			10.40 (3.20 - 14.10)	2.58 (0.77 - 4.15)	11.33 99
15+15+20+42	1.89	1.89	2.52	5.30			11.60 (3.20 - 14.70)	2.89 (0.76 - 4.12)	12.69 99
15+15+20+50	1.80	1.80	2.40	6.00			12.00 (3.20 - 14.90)	3.07 (0.76 - 4.25)	13.48 99
15+15+20+60	1.68	1.68	2.24	6.71			12.30 (3.20 - 14.90)	3.25 (0.76 - 4.25)	14.27 99
15+15+20+71	1.56	1.56	2.08	7.39			12.60 (3.20 - 15.00)	3.43 (0.76 - 4.72)	15.06 99

MXZ-6C120VA HEATING

Indoor units combination	Heating capacity (kW)						Outdoor unit power consumption (kW)	Current (A)	Power factor (%)
	Unit A	Unit B	Unit C	Unit D	Unit E	Unit F			
15+15+22+22	1.66	1.66	2.44	2.44			8.20 (3.10 - 11.40)	2.02 (0.79 - 3.73)	8.87 99
15+15+22+25	1.66	1.66	2.43	2.76			8.50 (3.10 - 11.90)	2.13 (0.79 - 3.90)	9.35 99
15+15+22+35	1.91	1.91	2.81	4.47			11.10 (3.20 - 14.40)	2.74 (0.76 - 4.09)	12.03 99
15+15+22+42	1.87	1.87	2.74	5.23			11.70 (3.20 - 14.80)	2.94 (0.76 - 4.18)	12.91 99
15+15+22+50	1.78	1.78	2.61	5.93			12.10 (3.20 - 14.90)	3.13 (0.76 - 4.25)	13.75 99
15+15+22+60	1.66	1.66	2.44	6.64			12.40 (3.20 - 14.90)	3.31 (0.76 - 4.25)	14.54 99
15+15+22+71	1.55	1.55	2.27	7.33			12.70 (3.20 - 15.00)	3.49 (0.76 - 4.72)	15.33 99
15+15+25+25	1.65	1.65	2.75	2.75			8.80 (3.10 - 13.20)	2.24 (0.79 - 4.33)	9.84 99
15+15+25+35	1.92	1.92	3.19	4.47			11.50 (3.20 - 14.70)	2.85 (0.76 - 4.12)	12.52 99
15+15+25+42	1.84	1.84	3.07	5.15			11.90 (3.20 - 14.80)	3.03 (0.76 - 4.18)	13.31 99
15+15+25+50	1.74	1.74	2.90	5.81			12.20 (3.20 - 14.90)	3.19 (0.76 - 4.25)	14.01 99
15+15+25+60	1.63	1.63	2.72	6.52			12.50 (3.20 - 14.90)	3.37 (0.76 - 4.25)	14.80 99
15+15+25+71	1.52	1.52	2.54	7.21			12.80 (3.20 - 15.00)	3.55 (0.76 - 4.72)	15.59 99
15+15+35+35	1.80	1.80	4.20	4.20			12.00 (3.20 - 14.90)	3.07 (0.76 - 4.25)	13.48 99
15+15+35+42	1.71	1.71	3.99	4.79			12.20 (3.20 - 14.90)	3.19 (0.76 - 4.25)	14.01 99
15+15+35+50	1.63	1.63	3.80	5.43			12.50 (3.20 - 14.90)	3.37 (0.76 - 4.25)	14.80 99
15+15+35+60	1.54	1.54	3.58	6.14			12.80 (3.20 - 15.00)	3.55 (0.76 - 4.72)	15.59 99
15+15+35+71	1.44	1.44	3.37	6.84			13.10 (3.20 - 15.00)	3.73 (0.76 - 4.72)	16.38 99
15+15+42+42	1.63	1.63	4.57	4.57			12.40 (3.20 - 14.90)	3.31 (0.76 - 4.25)	14.54 99
15+15+42+50	1.56	1.56	4.37	5.20			12.70 (3.20 - 15.00)	3.49 (0.76 - 4.72)	15.33 99
15+15+42+60	1.48	1.48	4.14	5.91			13.00 (3.20 - 15.00)	3.67 (0.76 - 4.72)	16.12 99
15+15+42+71	1.38	1.38	3.88	6.55			13.20 (3.20 - 15.00)	3.77 (0.76 - 4.72)	16.56 99
15+15+50+50	1.49	1.49	4.96	4.96			12.90 (3.20 - 15.00)	3.61 (0.76 - 4.72)	15.85 99
15+15+50+60	1.41	1.41	4.71	5.66			13.20 (3.20 - 15.00)	3.79 (0.76 - 4.72)	16.64 99
15+15+50+71	1.31	1.31	4.37	6.21			13.20 (3.20 - 15.00)	3.72 (0.76 - 4.72)	16.34 99
15+15+60+60	1.32	1.32	5.28	5.28			13.20 (3.20 - 15.00)	3.72 (0.76 - 4.72)	16.34 99
15+15+60+71	1.23	1.23	4.92	5.82			13.20 (3.20 - 15.10)	3.65 (0.76 - 4.50)	16.03 99
15+15+71+71	1.10	1.10	5.20	5.20			12.60 (3.20 - 14.20)	3.60 (0.76 - 4.50)	15.81 99
15+20+20+20	1.66	2.21	2.21	2.21			8.30 (3.10 - 11.60)	2.06 (0.79 - 3.80)	9.05 99
15+20+20+22	1.66	2.21	2.21	2.43			8.50 (3.10 - 11.90)	2.13 (0.79 - 3.90)	9.35 99
15+20+20+25	1.65	2.20	2.20	2.75			8.80 (3.10 - 13.20)	2.24 (0.79 - 4.33)	9.84 99
15+20+20+35	1.92	2.56	2.56	4.47			11.50 (3.20 - 14.70)	2.85 (0.76 - 4.12)	12.52 99
15+20+20+42	1.84	2.45	2.45	5.15			11.90 (3.20 - 14.80)	3.03 (0.76 - 4.18)	13.31 99
15+20+20+50	1.74	2.32	2.32	5.81			12.20 (3.20 - 14.90)	3.19 (0.76 - 4.25)	14.01 99
15+20+20+60	1.63	2.17	2.17	6.52			12.50 (3.20 - 14.90)	3.37 (0.76 - 4.25)	14.80 99
15+20+20+71	1.52	2.03	2.03	7.21			12.80 (3.20 - 15.00)	3.55 (0.76 - 4.72)	15.59 99
15+20+22+22	1.65	2.20	2.42	2.42			8.70 (3.10 - 12.20)	2.20 (0.79 - 4.00)	9.66 99
15+20+22+25	1.74	2.32	2.55	2.90			9.50 (3.10 - 13.60)	2.39 (0.78 - 4.25)	10.50 99
15+20+22+35	1.89	2.52	2.77	4.41			11.60 (3.20 - 14.70)	2.89 (0.76 - 4.12)	12.69 99
15+20+22+42	1.82	2.42	2.67	5.09			12.00 (3.20 - 14.90)	3.07 (0.76 - 4.25)	13.48 99
15+20+22+50	1.71	2.28	2.51	5.70			12.20 (3.20 - 14.90)	3.19 (0.76 - 4.25)	14.01 99
15+20+22+60	1.60	2.14	2.35	6.41			12.50 (3.20 - 14.90)	3.37 (0.76 - 4.25)	14.80 99
15+20+22+71	1.50	2.00	2.20	7.10			12.80 (3.20 - 15.00)	3.55 (0.76 - 4.72)	15.59 99
15+20+25+25	1.84	2.45	3.06	3.06			10.40 (3.20 - 14.10)	2.58 (0.77 - 4.15)	11.33 99
15+20+25+35	1.86	2.48	3.11	4.35			11.80 (3.20 - 14.80)	2.98 (0.76 - 4.18)	13.09 99
15+20+25+42	1.78	2.37	2.97	4.98			12.10 (3.20 - 14.90)	3.13 (0.76 - 4.25)	13.75 99

MXZ-6C120VA HEATING

Indoor units combination	Heating capacity (kW)						Outdoor unit power consumption (kW)	Current (A)	Power factor (%)
	Unit A	Unit B	Unit C	Unit D	Unit E	Unit F			
15+20+25+50	1.68	2.24	2.80	5.59			12.30 (3.20 - 14.90)	3.25 (0.76 - 4.25)	14.27 99
15+20+25+60	1.58	2.10	2.63	6.30			12.60 (3.20 - 15.00)	3.43 (0.76 - 4.72)	15.06 99
15+20+25+71	1.48	1.97	2.46	6.99			12.90 (3.20 - 15.00)	3.61 (0.76 - 4.72)	15.85 99
15+20+35+35	1.74	2.32	4.07	4.07			12.20 (3.20 - 14.90)	3.19 (0.76 - 4.25)	14.01 99
15+20+35+42	1.66	2.21	3.88	4.65			12.40 (3.20 - 14.90)	3.31 (0.76 - 4.25)	14.54 99
15+20+35+50	1.58	2.10	3.68	5.25			12.60 (3.20 - 15.00)	3.43 (0.76 - 4.72)	15.06 99
15+20+35+60	1.49	1.98	3.47	5.95			12.90 (3.20 - 15.00)	3.61 (0.76 - 4.72)	15.85 99
15+20+35+71	1.40	1.87	3.28	6.65			13.20 (3.20 - 15.00)	3.78 (0.76 - 4.72)	16.60 99
15+20+42+42	1.59	2.12	4.45	4.45			12.60 (3.20 - 14.90)	3.43 (0.76 - 4.25)	15.06 99
15+20+42+50	1.51	2.02	4.23	5.04			12.80 (3.20 - 15.00)	3.55 (0.76 - 4.72)	15.59 99
15+20+42+60	1.43	1.91	4.02	5.74			13.10 (3.20 - 15.00)	3.73 (0.76 - 4.72)	16.38 99
15+20+42+71	1.34	1.78	3.75	6.33			13.20 (3.20 - 15.00)	3.74 (0.76 - 4.72)	16.43 99
15+20+50+50	1.46	1.94	4.85	4.85			13.10 (3.20 - 15.00)	3.73 (0.76 - 4.72)	16.38 99
15+20+50+60	1.37	1.82	4.55	5.46			13.20 (3.20 - 15.00)	3.76 (0.76 - 4.72)	16.51 99
15+20+50+71	1.27	1.69	4.23	6.01			13.20 (3.20 - 15.10)	3.68 (0.76 - 4.50)	16.16 99
15+20+60+60	1.28	1.70	5.11	5.11			13.20 (3.20 - 15.10)	3.69 (0.76 - 4.50)	16.21 99
15+20+60+71	1.19	1.59	4.77	5.65			13.20 (3.20 - 15.10)	3.61 (0.76 - 4.50)	15.85 99
15+20+71+71	1.07	1.42	5.05	5.05			12.60 (3.20 - 14.20)	3.60 (0.76 - 4.50)	15.81 99
15+22+22+22	1.69	2.47	2.47	2.47			9.10 (3.10 - 13.40)	2.30 (0.79 - 4.29)	10.10 99
15+22+22+25	1.80	2.65	2.65	3.01			10.10 (3.20 - 13.90)	2.52 (0.78 - 4.19)	11.07 99
15+22+22+35	1.87	2.74	2.74	4.36			11.70 (3.20 - 14.80)	2.94 (0.76 - 4.18)	12.91 99
15+22+22+42	1.78	2.61	2.61	4.99			12.00 (3.20 - 14.90)	3.07 (0.76 - 4.25)	13.48 99
15+22+22+50	1.69	2.48	2.48	5.64			12.30 (3.20 - 14.90)	3.25 (0.76 - 4.25)	14.27 99
15+22+22+60	1.59	2.33	2.33	6.35			12.60 (3.20 - 14.90)	3.43 (0.76 - 4.25)	15.06 99
15+22+22+71	1.49	2.18	2.18	7.05			12.90 (3.20 - 15.00)	3.61 (0.76 - 4.72)	15.85 99
15+22+25+25	1.91	2.81	3.19	3.19			11.10 (3.20 - 14.40)	2.74 (0.76 - 4.09)	12.03 99
15+22+25+35	1.84	2.70	3.07	4.29			11.90 (3.20 - 14.80)	3.03 (0.76 - 4.18)	13.31 99
15+22+25+42	1.75	2.56	2.91	4.89			12.10 (3.20 - 14.90)	3.13 (0.76 - 4.25)	13.75 99
15+22+25+50	1.66	2.44	2.77	5.54			12.40 (3.20 - 14.90)	3.31 (0.76 - 4.25)	14.54 99
15+22+25+60	1.56	2.29	2.60	6.25			12.70 (3.20 - 15.00)	3.49 (0.76 - 4.72)	15.33 99
15+22+25+71	1.47	2.15	2.44	6.94			13.00 (3.20 - 15.00)	3.67 (0.76 - 4.72)	16.12 99
15+22+35+35	1.71	2.51	3.99	3.99			12.20 (3.20 - 14.90)	3.19 (0.76 - 4.25)	14.01 99
15+22+35+42	1.63	2.39	3.81	4.57			12.40 (3.20 - 14.90)	3.31 (0.76 - 4.25)	14.54 99
15+22+35+50	1.56	2.29	3.64	5.20			12.70 (3.20 - 15.00)	3.49 (0.76 - 4.72)	15.33 99
15+22+35+60	1.48	2.17	3.45	5.91			13.00 (3.20 - 15.00)	3.67 (0.76 - 4.72)	16.12 99
15+22+35+71	1.38	2.03	3.23	6.55			13.20 (3.20 - 15.00)	3.77 (0.76 - 4.72)	16.56 99
15+22+42+42	1.56	2.29	4.37	4.37			12.60 (3.20 - 15.00)	3.43 (0.76 - 4.72)	15.06 99
15+22+42+50	1.50	2.20	4.20	5.00			12.90 (3.20 - 15.00)	3.61 (0.76 - 4.72)	15.85 99
15+22+42+60	1.42	2.09	3.99	5.70			13.20 (3.20 - 15.00)	3.79 (0.76 - 4.72)	16.64 99
15+22+42+71	1.32	1.94	3.70	6.25			13.20 (3.20 - 15.00)	3.72 (0.76 - 4.72)	16.34 99
15+22+50+50	1.43	2.10	4.78	4.78			13.10 (3.20 - 15.00)	3.73 (0.76 - 4.72)	16.38 99
15+22+50+60	1.35	1.98	4.49	5.39			13.20 (3.20 - 15.00)	3.74 (0.76 - 4.72)	16.43 99
15+22+50+71	1.25	1.84	4.18	5.93			13.20 (3.20 - 15.10)	3.67 (0.76 - 4.50)	16.12 99
15+22+60+60	1.26	1.85	5.04	5.04			13.20 (3.20 - 15.10)	3.67 (0.76 - 4.50)	16.12 99
15+22+60+71	1.18	1.73	4.71	5.58			13.20 (3.20 - 15.10)	3.60 (0.76 - 4.50)	15.81 99
15+22+71+71	1.06	1.55	5.00	5.00			12.60 (3.20 - 14.20)	3.60 (0.76 - 4.50)	15.81 99

MXZ-6C120VA HEATING

Indoor units combination	Heating capacity (kW)						Outdoor unit power consumption (kW)	Current (A)	Power factor (%)	
	Unit A	Unit B	Unit C	Unit D	Unit E	Unit F				
15+25+25+25	1.92	3.19	3.19	3.19			11.50 (3.20 - 14.70)	2.85 (0.76 - 4.12)	12.52	99
15+25+25+35	1.80	3.00	3.00	4.20			12.00 (3.20 - 14.90)	3.07 (0.76 - 4.25)	13.48	99
15+25+25+42	1.71	2.85	2.85	4.79			12.20 (3.20 - 14.90)	3.19 (0.76 - 4.25)	14.01	99
15+25+25+50	1.63	2.72	2.72	5.43			12.50 (3.20 - 14.90)	3.37 (0.76 - 4.25)	14.80	99
15+25+25+60	1.54	2.56	2.56	6.14			12.80 (3.20 - 15.00)	3.55 (0.76 - 4.72)	15.59	99
15+25+25+71	1.44	2.41	2.41	6.84			13.10 (3.20 - 15.00)	3.73 (0.76 - 4.72)	16.38	99
15+25+35+35	1.68	2.80	3.91	3.91			12.30 (3.20 - 14.90)	3.25 (0.76 - 4.25)	14.27	99
15+25+35+42	1.60	2.67	3.74	4.49			12.50 (3.20 - 14.90)	3.37 (0.76 - 4.25)	14.80	99
15+25+35+50	1.54	2.56	3.58	5.12			12.80 (3.20 - 15.00)	3.55 (0.76 - 4.72)	15.59	99
15+25+35+60	1.46	2.43	3.40	5.82			13.10 (3.20 - 15.00)	3.73 (0.76 - 4.72)	16.38	99
15+25+35+71	1.36	2.26	3.16	6.42			13.20 (3.20 - 15.00)	3.75 (0.76 - 4.72)	16.47	99
15+25+42+42	1.54	2.56	4.30	4.30			12.70 (3.20 - 15.00)	3.49 (0.76 - 4.72)	15.33	99
15+25+42+50	1.48	2.46	4.14	4.92			13.00 (3.20 - 15.00)	3.67 (0.76 - 4.72)	16.12	99
15+25+42+60	1.39	2.32	3.90	5.58			13.20 (3.20 - 15.00)	3.78 (0.76 - 4.72)	16.60	99
15+25+42+71	1.29	2.16	3.62	6.13			13.20 (3.20 - 15.00)	3.70 (0.76 - 4.72)	16.25	99
15+25+50+50	1.41	2.36	4.71	4.71			13.20 (3.20 - 15.00)	3.79 (0.76 - 4.72)	16.64	99
15+25+50+60	1.32	2.20	4.40	5.28			13.20 (3.20 - 15.00)	3.72 (0.76 - 4.72)	16.34	99
15+25+50+71	1.23	2.05	4.10	5.82			13.20 (3.20 - 15.10)	3.65 (0.76 - 4.50)	16.03	99
15+25+60+60	1.24	2.06	4.95	4.95			13.20 (3.20 - 15.10)	3.65 (0.76 - 4.50)	16.03	99
15+25+60+71	1.11	1.84	4.42	5.23			12.60 (3.20 - 14.20)	3.60 (0.76 - 4.50)	15.81	99
15+35+35+35	1.58	3.68	3.68	3.68			12.60 (3.20 - 15.00)	3.43 (0.76 - 4.72)	15.06	99
15+35+35+42	1.51	3.53	3.53	4.23			12.80 (3.20 - 15.00)	3.55 (0.76 - 4.72)	15.59	99
15+35+35+50	1.46	3.40	3.40	4.85			13.10 (3.20 - 15.00)	3.73 (0.76 - 4.72)	16.38	99
15+35+35+60	1.37	3.19	3.19	5.46			13.20 (3.20 - 15.00)	3.76 (0.76 - 4.72)	16.51	99
15+35+35+71	1.27	2.96	2.96	6.01			13.20 (3.20 - 15.10)	3.68 (0.76 - 4.50)	16.16	99
15+35+42+42	1.46	3.40	4.07	4.07			13.00 (3.20 - 15.00)	3.67 (0.76 - 4.72)	16.12	99
15+35+42+50	1.39	3.25	3.90	4.65			13.20 (3.20 - 15.00)	3.78 (0.76 - 4.72)	16.60	99
15+35+42+60	1.30	3.04	3.65	5.21			13.20 (3.20 - 15.00)	3.71 (0.76 - 4.72)	16.29	99
15+35+42+71	1.21	2.83	3.40	5.75			13.20 (3.20 - 15.10)	3.63 (0.76 - 4.50)	15.94	99
15+35+50+50	1.32	3.08	4.40	4.40			13.20 (3.20 - 15.00)	3.72 (0.76 - 4.72)	16.34	99
15+35+50+60	1.24	2.89	4.13	4.95			13.20 (3.20 - 15.10)	3.65 (0.76 - 4.50)	16.03	99
15+35+50+71	1.11	2.58	3.68	5.23			12.60 (3.20 - 14.20)	3.60 (0.76 - 4.50)	15.81	99
15+35+60+60	1.11	2.59	4.45	4.45			12.60 (3.20 - 14.20)	3.60 (0.76 - 4.50)	15.81	99
15+42+42+42	1.40	3.93	3.93	3.93			13.20 (3.20 - 15.00)	3.78 (0.76 - 4.72)	16.60	99
15+42+42+50	1.33	3.72	3.72	4.43			13.20 (3.20 - 15.00)	3.73 (0.76 - 4.72)	16.38	99
15+42+42+60	1.25	3.49	3.49	4.98			13.20 (3.20 - 15.10)	3.66 (0.76 - 4.50)	16.07	99
15+42+42+71	1.11	3.11	3.11	5.26			12.60 (3.20 - 14.20)	3.60 (0.76 - 4.50)	15.81	99
15+42+50+50	1.26	3.53	4.20	4.20			13.20 (3.20 - 15.10)	3.67 (0.76 - 4.50)	16.12	99
15+42+50+60	1.19	3.32	3.95	4.74			13.20 (3.20 - 15.10)	3.61 (0.76 - 4.50)	15.85	99
15+42+50+71	1.06	2.97	3.54	5.03			12.60 (3.20 - 14.20)	3.60 (0.76 - 4.50)	15.81	99
15+42+60+60	1.07	2.99	4.27	4.27			12.60 (3.20 - 14.20)	3.60 (0.76 - 4.50)	15.81	99
15+50+50+50	1.20	4.00	4.00	4.00			13.20 (3.20 - 15.10)	3.62 (0.76 - 4.50)	15.90	99
15+50+50+60	1.08	3.60	3.60	4.32			12.60 (3.20 - 14.20)	3.60 (0.76 - 4.50)	15.81	99
20+20+20+20	2.20	2.20	2.20	2.20			8.80 (3.10 - 13.20)	2.24 (0.79 - 4.33)	9.84	99
20+20+20+22	2.32	2.32	2.32	2.55			9.50 (3.10 - 13.60)	2.39 (0.78 - 4.25)	10.50	99
20+20+20+25	2.45	2.45	2.45	3.06			10.40 (3.20 - 14.10)	2.58 (0.77 - 4.15)	11.33	99

MXZ-6C120VA HEATING

Indoor units combination	Heating capacity (kW)						Outdoor unit power consumption (kW)	Current (A)	Power factor (%)
	Unit A	Unit B	Unit C	Unit D	Unit E	Unit F			
20+20+20+35	2.48	2.48	2.48	4.35			11.80 (3.20 - 14.80)	2.98 (0.76 - 4.18)	13.09 99
20+20+20+42	2.37	2.37	2.37	4.98			12.10 (3.20 - 14.90)	3.13 (0.76 - 4.25)	13.75 99
20+20+20+50	2.24	2.24	2.24	5.59			12.30 (3.20 - 14.90)	3.25 (0.76 - 4.25)	14.27 99
20+20+20+60	2.10	2.10	2.10	6.30			12.60 (3.20 - 15.00)	3.43 (0.76 - 4.72)	15.06 99
20+20+20+71	1.97	1.97	1.97	6.99			12.90 (3.20 - 15.00)	3.61 (0.76 - 4.72)	15.85 99
20+20+22+22	2.40	2.40	2.65	2.65			10.10 (3.20 - 13.90)	2.52 (0.78 - 4.19)	11.07 99
20+20+22+25	2.55	2.55	2.81	3.19			11.10 (3.20 - 14.40)	2.74 (0.76 - 4.09)	12.03 99
20+20+22+35	2.45	2.45	2.70	4.29			11.90 (3.20 - 14.80)	3.03 (0.76 - 4.18)	13.31 99
20+20+22+42	2.33	2.33	2.56	4.89			12.10 (3.20 - 14.90)	3.13 (0.76 - 4.25)	13.75 99
20+20+22+50	2.21	2.21	2.44	5.54			12.40 (3.20 - 14.90)	3.31 (0.76 - 4.25)	14.54 99
20+20+22+60	2.08	2.08	2.29	6.25			12.70 (3.20 - 15.00)	3.49 (0.76 - 4.72)	15.33 99
20+20+22+71	1.95	1.95	2.15	6.94			13.00 (3.20 - 15.00)	3.67 (0.76 - 4.72)	16.12 99
20+20+25+25	2.56	2.56	3.19	3.19			11.50 (3.20 - 14.70)	2.85 (0.76 - 4.12)	12.52 99
20+20+25+35	2.40	2.40	3.00	4.20			12.00 (3.20 - 14.90)	3.07 (0.76 - 4.25)	13.48 99
20+20+25+42	2.28	2.28	2.85	4.79			12.20 (3.20 - 14.90)	3.19 (0.76 - 4.25)	14.01 99
20+20+25+50	2.17	2.17	2.72	5.43			12.50 (3.20 - 14.90)	3.37 (0.76 - 4.25)	14.80 99
20+20+25+60	2.05	2.05	2.56	6.14			12.80 (3.20 - 15.00)	3.55 (0.76 - 4.72)	15.59 99
20+20+25+71	1.93	1.93	2.41	6.84			13.10 (3.20 - 15.00)	3.73 (0.76 - 4.72)	16.38 99
20+20+35+35	2.24	2.24	3.91	3.91			12.30 (3.20 - 14.90)	3.25 (0.76 - 4.25)	14.27 99
20+20+35+42	2.14	2.14	3.74	4.49			12.50 (3.20 - 14.90)	3.37 (0.76 - 4.25)	14.80 99
20+20+35+50	2.05	2.05	3.58	5.12			12.80 (3.20 - 15.00)	3.55 (0.76 - 4.72)	15.59 99
20+20+35+60	1.94	1.94	3.40	5.82			13.10 (3.20 - 15.00)	3.73 (0.76 - 4.72)	16.38 99
20+20+35+71	1.81	1.81	3.16	6.42			13.20 (3.20 - 15.00)	3.75 (0.76 - 4.72)	16.47 99
20+20+42+42	2.05	2.05	4.30	4.30			12.70 (3.20 - 15.00)	3.49 (0.76 - 4.72)	15.33 99
20+20+42+50	1.97	1.97	4.14	4.92			13.00 (3.20 - 15.00)	3.67 (0.76 - 4.72)	16.12 99
20+20+42+60	1.86	1.86	3.90	5.58			13.20 (3.20 - 15.00)	3.78 (0.76 - 4.72)	16.60 99
20+20+42+71	1.73	1.73	3.62	6.13			13.20 (3.20 - 15.00)	3.70 (0.76 - 4.72)	16.25 99
20+20+50+50	1.89	1.89	4.71	4.71			13.20 (3.20 - 15.00)	3.79 (0.76 - 4.72)	16.64 99
20+20+50+60	1.76	1.76	4.40	5.28			13.20 (3.20 - 15.00)	3.72 (0.76 - 4.72)	16.34 99
20+20+50+71	1.64	1.64	4.10	5.82			13.20 (3.20 - 15.10)	3.65 (0.76 - 4.50)	16.03 99
20+20+60+60	1.65	1.65	4.95	4.95			13.20 (3.20 - 15.10)	3.65 (0.76 - 4.50)	16.03 99
20+20+60+71	1.47	1.47	4.42	5.23			12.60 (3.20 - 14.20)	3.60 (0.76 - 4.50)	15.81 99
20+22+22+22	2.51	2.76	2.76	2.76			10.80 (3.20 - 14.30)	2.67 (0.77 - 4.11)	11.73 99
20+22+22+25	2.58	2.84	2.84	3.23			11.50 (3.20 - 14.60)	2.85 (0.76 - 4.05)	12.52 99
20+22+22+35	2.42	2.67	2.67	4.24			12.00 (3.20 - 14.90)	3.07 (0.76 - 4.25)	13.48 99
20+22+22+42	2.30	2.53	2.53	4.83			12.20 (3.20 - 14.90)	3.19 (0.76 - 4.25)	14.01 99
20+22+22+50	2.18	2.39	2.39	5.44			12.40 (3.20 - 14.90)	3.31 (0.76 - 4.25)	14.54 99
20+22+22+60	2.05	2.25	2.25	6.15			12.70 (3.20 - 15.00)	3.49 (0.76 - 4.72)	15.33 99
20+22+22+71	1.94	2.13	2.13	6.89			13.10 (3.20 - 15.00)	3.73 (0.76 - 4.72)	16.38 99
20+22+25+25	2.52	2.77	3.15	3.15			11.60 (3.20 - 14.70)	2.89 (0.76 - 4.12)	12.69 99
20+22+25+35	2.37	2.61	2.97	4.15			12.10 (3.20 - 14.90)	3.13 (0.76 - 4.25)	13.75 99
20+22+25+42	2.26	2.48	2.82	4.74			12.30 (3.20 - 14.90)	3.25 (0.76 - 4.25)	14.27 99
20+22+25+50	2.14	2.35	2.67	5.34			12.50 (3.20 - 14.90)	3.37 (0.76 - 4.25)	14.80 99
20+22+25+60	2.02	2.22	2.52	6.05			12.80 (3.20 - 15.00)	3.55 (0.76 - 4.72)	15.59 99
20+22+25+71	1.90	2.09	2.37	6.74			13.10 (3.20 - 15.00)	3.73 (0.76 - 4.72)	16.38 99
20+22+35+35	2.21	2.44	3.88	3.88			12.40 (3.20 - 14.90)	3.31 (0.76 - 4.25)	14.54 99

MXZ-6C120VA HEATING

Indoor units combination	Heating capacity (kW)						Outdoor unit power consumption (kW)	Current (A)	Power factor (%)
	Unit A	Unit B	Unit C	Unit D	Unit E	Unit F			
20+22+35+42	2.12	2.33	3.71	4.45			12.60 (3.20 - 14.90)	3.43 (0.76 - 4.25)	15.06 99
20+22+35+50	2.02	2.22	3.53	5.04			12.80 (3.20 - 15.00)	3.55 (0.76 - 4.72)	15.59 99
20+22+35+60	1.91	2.10	3.35	5.74			13.10 (3.20 - 15.00)	3.73 (0.76 - 4.72)	16.38 99
20+22+35+71	1.78	1.96	3.12	6.33			13.20 (3.20 - 15.00)	3.74 (0.76 - 4.72)	16.43 99
20+22+42+42	2.03	2.23	4.27	4.27			12.80 (3.20 - 15.00)	3.55 (0.76 - 4.72)	15.59 99
20+22+42+50	1.94	2.13	4.07	4.85			13.00 (3.20 - 15.00)	3.67 (0.76 - 4.72)	16.12 99
20+22+42+60	1.83	2.02	3.85	5.50			13.20 (3.20 - 15.00)	3.76 (0.76 - 4.72)	16.51 99
20+22+42+71	1.70	1.87	3.58	6.05			13.20 (3.20 - 15.10)	3.69 (0.76 - 4.50)	16.21 99
20+22+50+50	1.86	2.05	4.65	4.65			13.20 (3.20 - 15.00)	3.78 (0.76 - 4.72)	16.60 99
20+22+50+60	1.74	1.91	4.34	5.21			13.20 (3.20 - 15.00)	3.71 (0.76 - 4.72)	16.29 99
20+22+50+71	1.62	1.78	4.05	5.75			13.20 (3.20 - 15.10)	3.63 (0.76 - 4.50)	15.94 99
20+22+60+60	1.63	1.79	4.89	4.89			13.20 (3.20 - 15.10)	3.64 (0.76 - 4.50)	15.99 99
20+22+60+71	1.46	1.60	4.37	5.17			12.60 (3.20 - 14.20)	3.60 (0.76 - 4.50)	15.81 99
20+25+25+25	2.48	3.11	3.11	3.11			11.80 (3.20 - 14.80)	2.98 (0.76 - 4.18)	13.09 99
20+25+25+35	2.32	2.90	2.90	4.07			12.20 (3.20 - 14.90)	3.19 (0.76 - 4.25)	14.01 99
20+25+25+42	2.21	2.77	2.77	4.65			12.40 (3.20 - 14.90)	3.31 (0.76 - 4.25)	14.54 99
20+25+25+50	2.10	2.63	2.63	5.25			12.60 (3.20 - 15.00)	3.43 (0.76 - 4.72)	15.06 99
20+25+25+60	1.98	2.48	2.48	5.95			12.90 (3.20 - 15.00)	3.61 (0.76 - 4.72)	15.85 99
20+25+25+71	1.87	2.34	2.34	6.65			13.20 (3.20 - 15.00)	3.78 (0.76 - 4.72)	16.60 99
20+25+35+35	2.17	2.72	3.80	3.80			12.50 (3.20 - 14.90)	3.37 (0.76 - 4.25)	14.80 99
20+25+35+42	2.08	2.60	3.64	4.37			12.70 (3.20 - 15.00)	3.49 (0.76 - 4.72)	15.33 99
20+25+35+50	1.98	2.48	3.47	4.96			12.90 (3.20 - 15.00)	3.61 (0.76 - 4.72)	15.85 99
20+25+35+60	1.89	2.36	3.30	5.66			13.20 (3.20 - 15.00)	3.79 (0.76 - 4.72)	16.64 99
20+25+35+71	1.75	2.19	3.06	6.21			13.20 (3.20 - 15.00)	3.72 (0.76 - 4.72)	16.34 99
20+25+42+42	2.00	2.50	4.20	4.20			12.90 (3.20 - 15.00)	3.61 (0.76 - 4.72)	15.85 99
20+25+42+50	1.91	2.39	4.02	4.78			13.10 (3.20 - 15.00)	3.73 (0.76 - 4.72)	16.38 99
20+25+42+60	1.80	2.24	3.77	5.39			13.20 (3.20 - 15.00)	3.74 (0.76 - 4.72)	16.43 99
20+25+42+71	1.67	2.09	3.51	5.93			13.20 (3.20 - 15.10)	3.67 (0.76 - 4.50)	16.12 99
20+25+50+50	1.82	2.28	4.55	4.55			13.20 (3.20 - 15.00)	3.76 (0.76 - 4.72)	16.51 99
20+25+50+60	1.70	2.13	4.26	5.11			13.20 (3.20 - 15.10)	3.69 (0.76 - 4.50)	16.21 99
20+25+50+71	1.59	1.99	3.98	5.65			13.20 (3.20 - 15.10)	3.61 (0.76 - 4.50)	15.85 99
20+25+60+60	1.60	2.00	4.80	4.80			13.20 (3.20 - 15.10)	3.62 (0.76 - 4.50)	15.90 99
20+25+60+71	1.43	1.79	4.30	5.08			12.60 (3.20 - 14.20)	3.60 (0.76 - 4.50)	15.81 99
20+35+35+35	2.05	3.58	3.58	3.58			12.80 (3.20 - 15.00)	3.55 (0.76 - 4.72)	15.59 99
20+35+35+42	1.97	3.45	3.45	4.14			13.00 (3.20 - 15.00)	3.67 (0.76 - 4.72)	16.12 99
20+35+35+50	1.89	3.30	3.30	4.71			13.20 (3.20 - 15.00)	3.79 (0.76 - 4.72)	16.64 99
20+35+35+60	1.76	3.08	3.08	5.28			13.20 (3.20 - 15.00)	3.72 (0.76 - 4.72)	16.34 99
20+35+35+71	1.64	2.87	2.87	5.82			13.20 (3.20 - 15.10)	3.65 (0.76 - 4.50)	16.03 99
20+35+42+42	1.90	3.32	3.99	3.99			13.20 (3.20 - 15.00)	3.79 (0.76 - 4.72)	16.64 99
20+35+42+50	1.80	3.14	3.77	4.49			13.20 (3.20 - 15.00)	3.74 (0.76 - 4.72)	16.43 99
20+35+42+60	1.68	2.94	3.53	5.04			13.20 (3.20 - 15.10)	3.67 (0.76 - 4.50)	16.12 99
20+35+42+71	1.57	2.75	3.30	5.58			13.20 (3.20 - 15.10)	3.60 (0.76 - 4.50)	15.81 99
20+35+50+50	1.70	2.98	4.26	4.26			13.20 (3.20 - 15.10)	3.69 (0.76 - 4.50)	16.21 99
20+35+50+60	1.60	2.80	4.00	4.80			13.20 (3.20 - 15.10)	3.62 (0.76 - 4.50)	15.90 99
20+35+50+71	1.43	2.51	3.58	5.08			12.60 (3.20 - 14.20)	3.60 (0.76 - 4.50)	15.81 99
20+35+60+60	1.44	2.52	4.32	4.32			12.60 (3.20 - 14.20)	3.60 (0.76 - 4.50)	15.81 99

MXZ-6C120VA HEATING

Indoor units combination	Heating capacity (kW)						Outdoor unit power consumption (kW)	Current (A)	Power factor (%)
	Unit A	Unit B	Unit C	Unit D	Unit E	Unit F			
20+42+42+42	1.81	3.80	3.80	3.80			13.20 (3.20 - 15.00)	3.75 (0.76 - 4.72)	16.47 99
20+42+42+50	1.71	3.60	3.60	4.29			13.20 (3.20 - 15.10)	3.70 (0.76 - 4.50)	16.25 99
20+42+42+60	1.61	3.38	3.38	4.83			13.20 (3.20 - 15.10)	3.63 (0.76 - 4.50)	15.94 99
20+42+42+71	1.44	3.02	3.02	5.11			12.60 (3.20 - 14.20)	3.60 (0.76 - 4.50)	15.81 99
20+42+50+50	1.63	3.42	4.07	4.07			13.20 (3.20 - 15.10)	3.64 (0.76 - 4.50)	15.99 99
20+42+50+60	1.47	3.08	3.66	4.40			12.60 (3.20 - 14.20)	3.60 (0.76 - 4.50)	15.81 99
20+50+50+50	1.48	3.71	3.71	3.71			12.60 (3.20 - 14.20)	3.60 (0.76 - 4.50)	15.81 99
20+50+50+60	1.40	3.50	3.50	4.20			12.60 (3.20 - 14.20)	3.60 (0.76 - 4.50)	15.81 99
22+22+22+22	2.85	2.85	2.85	2.85			11.40 (3.20 - 14.60)	2.80 (0.76 - 4.05)	12.30 99
22+22+22+25	2.80	2.80	2.80	3.19			11.60 (3.20 - 14.70)	2.89 (0.76 - 4.12)	12.69 99
22+22+22+35	2.61	2.61	2.61	4.16			12.00 (3.20 - 14.90)	3.07 (0.76 - 4.25)	13.48 99
22+22+22+42	2.49	2.49	2.49	4.74			12.20 (3.20 - 14.90)	3.19 (0.76 - 4.25)	14.01 99
22+22+22+50	2.37	2.37	2.37	5.39			12.50 (3.20 - 14.90)	3.37 (0.76 - 4.25)	14.80 99
22+22+22+60	2.23	2.23	2.23	6.10			12.80 (3.20 - 15.00)	3.55 (0.76 - 4.72)	15.59 99
22+22+22+71	2.10	2.10	2.10	6.79			13.10 (3.20 - 15.00)	3.73 (0.76 - 4.72)	16.38 99
22+22+25+25	2.74	2.74	3.11	3.11			11.70 (3.20 - 14.80)	2.94 (0.76 - 4.18)	12.91 99
22+22+25+35	2.56	2.56	2.91	4.07			12.10 (3.20 - 14.90)	3.13 (0.76 - 4.25)	13.75 99
22+22+25+42	2.44	2.44	2.77	4.65			12.30 (3.20 - 14.90)	3.25 (0.76 - 4.25)	14.27 99
22+22+25+50	2.33	2.33	2.65	5.29			12.60 (3.20 - 14.90)	3.43 (0.76 - 4.25)	15.06 99
22+22+25+60	2.20	2.20	2.50	6.00			12.90 (3.20 - 15.00)	3.61 (0.76 - 4.72)	15.85 99
22+22+25+71	2.07	2.07	2.36	6.69			13.20 (3.20 - 15.00)	3.79 (0.76 - 4.72)	16.64 99
22+22+35+35	2.39	2.39	3.81	3.81			12.40 (3.20 - 14.90)	3.31 (0.76 - 4.25)	14.54 99
22+22+35+42	2.29	2.29	3.64	4.37			12.60 (3.20 - 15.00)	3.43 (0.76 - 4.72)	15.06 99
22+22+35+50	2.20	2.20	3.50	5.00			12.90 (3.20 - 15.00)	3.61 (0.76 - 4.72)	15.85 99
22+22+35+60	2.09	2.09	3.32	5.70			13.20 (3.20 - 15.00)	3.79 (0.76 - 4.72)	16.64 99
22+22+35+71	1.94	1.94	3.08	6.25			13.20 (3.20 - 15.00)	3.72 (0.76 - 4.72)	16.34 99
22+22+42+42	2.20	2.20	4.20	4.20			12.80 (3.20 - 15.00)	3.55 (0.76 - 4.72)	15.59 99
22+22+42+50	2.12	2.12	4.05	4.82			13.10 (3.20 - 15.00)	3.73 (0.76 - 4.72)	16.38 99
22+22+42+60	1.99	1.99	3.80	5.42			13.20 (3.20 - 15.00)	3.75 (0.76 - 4.72)	16.47 99
22+22+42+71	1.85	1.85	3.53	5.97			13.20 (3.20 - 15.10)	3.67 (0.76 - 4.50)	16.12 99
22+22+50+50	2.02	2.02	4.58	4.58			13.20 (3.20 - 15.00)	3.76 (0.76 - 4.72)	16.51 99
22+22+50+60	1.89	1.89	4.29	5.14			13.20 (3.20 - 15.10)	3.70 (0.76 - 4.50)	16.25 99
22+22+50+71	1.76	1.76	4.00	5.68			13.20 (3.20 - 15.10)	3.62 (0.76 - 4.50)	15.90 99
22+22+60+60	1.77	1.77	4.83	4.83			13.20 (3.20 - 15.10)	3.63 (0.76 - 4.50)	15.94 99
22+22+60+71	1.58	1.58	4.32	5.11			12.60 (3.20 - 14.20)	3.60 (0.76 - 4.50)	15.81 99
22+25+25+25	2.70	3.07	3.07	3.07			11.90 (3.20 - 14.80)	3.03 (0.76 - 4.18)	13.31 99
22+25+25+35	2.51	2.85	2.85	3.99			12.20 (3.20 - 14.90)	3.19 (0.76 - 4.25)	14.01 99
22+25+25+42	2.39	2.72	2.72	4.57			12.40 (3.20 - 14.90)	3.31 (0.76 - 4.25)	14.54 99
22+25+25+50	2.29	2.60	2.60	5.20			12.70 (3.20 - 15.00)	3.49 (0.76 - 4.72)	15.33 99
22+25+25+60	2.17	2.46	2.46	5.91			13.00 (3.20 - 15.00)	3.67 (0.76 - 4.72)	16.12 99
22+25+25+71	2.03	2.31	2.31	6.55			13.20 (3.20 - 15.00)	3.77 (0.76 - 4.72)	16.56 99
22+25+35+35	2.35	2.67	3.74	3.74			12.50 (3.20 - 14.90)	3.37 (0.76 - 4.25)	14.80 99
22+25+35+42	2.25	2.56	3.58	4.30			12.70 (3.20 - 15.00)	3.49 (0.76 - 4.72)	15.33 99
22+25+35+50	2.17	2.46	3.45	4.92			13.00 (3.20 - 15.00)	3.67 (0.76 - 4.72)	16.12 99
22+25+35+60	2.05	2.32	3.25	5.58			13.20 (3.20 - 15.00)	3.78 (0.76 - 4.72)	16.60 99
22+25+35+71	1.90	2.16	3.02	6.13			13.20 (3.20 - 15.00)	3.70 (0.76 - 4.72)	16.25 99

MXZ-6C120VA HEATING

Indoor units combination	Heating capacity (kW)						Outdoor unit power consumption (kW)	Current (A)	Power factor (%)
	Unit A	Unit B	Unit C	Unit D	Unit E	Unit F			
22+25+42+42	2.17	2.46	4.14	4.14			12.90 (3.20 - 15.00)	3.61 (0.76 - 4.72)	15.85 99
22+25+42+50	2.09	2.37	3.99	4.75			13.20 (3.20 - 15.00)	3.79 (0.76 - 4.72)	16.64 99
22+25+42+60	1.95	2.21	3.72	5.32			13.20 (3.20 - 15.00)	3.73 (0.76 - 4.72)	16.38 99
22+25+42+71	1.82	2.06	3.47	5.86			13.20 (3.20 - 15.10)	3.65 (0.76 - 4.50)	16.03 99
22+25+50+50	1.98	2.24	4.49	4.49			13.20 (3.20 - 15.00)	3.74 (0.76 - 4.72)	16.43 99
22+25+50+60	1.85	2.10	4.20	5.04			13.20 (3.20 - 15.10)	3.67 (0.76 - 4.50)	16.12 99
22+25+50+71	1.73	1.96	3.93	5.58			13.20 (3.20 - 15.10)	3.60 (0.76 - 4.50)	15.81 99
22+25+60+60	1.74	1.98	4.74	4.74			13.20 (3.20 - 15.10)	3.61 (0.76 - 4.50)	15.85 99
22+25+60+71	1.56	1.77	4.25	5.03			12.60 (3.20 - 14.20)	3.60 (0.76 - 4.50)	15.81 99
22+35+35+35	2.22	3.53	3.53	3.53			12.80 (3.20 - 15.00)	3.55 (0.76 - 4.72)	15.59 99
22+35+35+42	2.13	3.40	3.40	4.07			13.00 (3.20 - 15.00)	3.67 (0.76 - 4.72)	16.12 99
22+35+35+50	2.05	3.25	3.25	4.65			13.20 (3.20 - 15.00)	3.78 (0.76 - 4.72)	16.60 99
22+35+35+60	1.91	3.04	3.04	5.21			13.20 (3.20 - 15.00)	3.71 (0.76 - 4.72)	16.29 99
22+35+35+71	1.78	2.83	2.83	5.75			13.20 (3.20 - 15.10)	3.63 (0.76 - 4.50)	15.94 99
22+35+42+42	2.06	3.28	3.93	3.93			13.20 (3.20 - 15.00)	3.78 (0.76 - 4.72)	16.60 99
22+35+42+50	1.95	3.10	3.72	4.43			13.20 (3.20 - 15.00)	3.73 (0.76 - 4.72)	16.38 99
22+35+42+60	1.83	2.91	3.49	4.98			13.20 (3.20 - 15.10)	3.66 (0.76 - 4.50)	16.07 99
22+35+42+71	1.63	2.59	3.11	5.26			12.60 (3.20 - 14.20)	3.60 (0.76 - 4.50)	15.81 99
22+35+50+50	1.85	2.94	4.20	4.20			13.20 (3.20 - 15.10)	3.67 (0.76 - 4.50)	16.12 99
22+35+50+60	1.74	2.77	3.95	4.74			13.20 (3.20 - 15.10)	3.61 (0.76 - 4.50)	15.85 99
22+35+50+71	1.56	2.48	3.54	5.03			12.60 (3.20 - 14.20)	3.60 (0.76 - 4.50)	15.81 99
22+35+60+60	1.57	2.49	4.27	4.27			12.60 (3.20 - 14.20)	3.60 (0.76 - 4.50)	15.81 99
22+42+42+42	1.96	3.75	3.75	3.75			13.20 (3.20 - 15.00)	3.74 (0.76 - 4.72)	16.43 99
22+42+42+50	1.86	3.55	3.55	4.23			13.20 (3.20 - 15.10)	3.68 (0.76 - 4.50)	16.16 99
22+42+42+60	1.75	3.34	3.34	4.77			13.20 (3.20 - 15.10)	3.61 (0.76 - 4.50)	15.85 99
22+42+42+71	1.57	2.99	2.99	5.05			12.60 (3.20 - 14.20)	3.60 (0.76 - 4.50)	15.81 99
22+42+50+50	1.77	3.38	4.02	4.02			13.20 (3.20 - 15.10)	3.63 (0.76 - 4.50)	15.94 99
22+42+50+60	1.59	3.04	3.62	4.34			12.60 (3.20 - 14.20)	3.60 (0.76 - 4.50)	15.81 99
22+50+50+50	1.61	3.66	3.66	3.66			12.60 (3.20 - 14.20)	3.60 (0.76 - 4.50)	15.81 99
25+25+25+25	3.00	3.00	3.00	3.00			12.00 (3.20 - 14.90)	3.07 (0.76 - 4.25)	13.48 99
25+25+25+35	2.80	2.80	2.80	3.91			12.30 (3.20 - 14.90)	3.25 (0.76 - 4.25)	14.27 99
25+25+25+42	2.67	2.67	2.67	4.49			12.50 (3.20 - 14.90)	3.37 (0.76 - 4.25)	14.80 99
25+25+25+50	2.56	2.56	2.56	5.12			12.80 (3.20 - 15.00)	3.55 (0.76 - 4.72)	15.59 99
25+25+25+60	2.43	2.43	2.43	5.82			13.10 (3.20 - 15.00)	3.73 (0.76 - 4.72)	16.38 99
25+25+25+71	2.26	2.26	2.26	6.42			13.20 (3.20 - 15.00)	3.75 (0.76 - 4.72)	16.47 99
25+25+35+35	2.63	2.63	3.68	3.68			12.60 (3.20 - 15.00)	3.43 (0.76 - 4.72)	15.06 99
25+25+35+42	2.52	2.52	3.53	4.23			12.80 (3.20 - 15.00)	3.55 (0.76 - 4.72)	15.59 99
25+25+35+50	2.43	2.43	3.40	4.85			13.10 (3.20 - 15.00)	3.73 (0.76 - 4.72)	16.38 99
25+25+35+60	2.28	2.28	3.19	5.46			13.20 (3.20 - 15.00)	3.76 (0.76 - 4.72)	16.51 99
25+25+35+71	2.12	2.12	2.96	6.01			13.20 (3.20 - 15.10)	3.68 (0.76 - 4.50)	16.16 99
25+25+42+42	2.43	2.43	4.07	4.07			13.00 (3.20 - 15.00)	3.67 (0.76 - 4.72)	16.12 99
25+25+42+50	2.32	2.32	3.90	4.65			13.20 (3.20 - 15.00)	3.78 (0.76 - 4.72)	16.60 99
25+25+42+60	2.17	2.17	3.65	5.21			13.20 (3.20 - 15.00)	3.71 (0.76 - 4.72)	16.29 99
25+25+42+71	2.02	2.02	3.40	5.75			13.20 (3.20 - 15.10)	3.63 (0.76 - 4.50)	15.94 99
25+25+50+50	2.20	2.20	4.40	4.40			13.20 (3.20 - 15.00)	3.72 (0.76 - 4.72)	16.34 99
25+25+50+60	2.06	2.06	4.13	4.95			13.20 (3.20 - 15.10)	3.65 (0.76 - 4.50)	16.03 99

MXZ-6C120VA HEATING

Indoor units combination	Heating capacity (kW)						Outdoor unit power consumption (kW)	Current (A)	Power factor (%)
	Unit A	Unit B	Unit C	Unit D	Unit E	Unit F			
15+15+22+50+60	1.24	1.24	1.82	4.14	4.96		13.40 (3.50 - 15.60)	3.36 (0.77 - 4.88)	14.76 99
15+15+22+50+71	1.16	1.16	1.70	3.87	5.50		13.40 (3.50 - 15.60)	3.35 (0.77 - 4.87)	14.71 99
15+15+22+60+60	1.17	1.17	1.71	4.67	4.67		13.40 (3.50 - 15.60)	3.35 (0.77 - 4.87)	14.71 99
15+15+25+25+25	1.73	1.73	2.88	2.88	2.88		12.10 (3.50 - 15.10)	3.03 (0.79 - 4.85)	13.31 99
15+15+25+25+35	1.72	1.72	2.87	2.87	4.02		13.20 (3.50 - 15.30)	3.22 (0.77 - 4.57)	14.14 99
15+15+25+25+42	1.64	1.64	2.73	2.73	4.58		13.30 (3.50 - 15.50)	3.30 (0.77 - 4.80)	14.49 99
15+15+25+25+50	1.55	1.55	2.58	2.58	5.15		13.40 (3.50 - 15.60)	3.39 (0.77 - 4.91)	14.89 99
15+15+25+25+60	1.44	1.44	2.39	2.39	5.74		13.40 (3.50 - 15.60)	3.38 (0.77 - 4.90)	14.84 99
15+15+25+25+71	1.33	1.33	2.22	2.22	6.30		13.40 (3.50 - 15.60)	3.37 (0.77 - 4.89)	14.80 99
15+15+25+35+35	1.61	1.61	2.68	3.75	3.75		13.40 (3.50 - 15.60)	3.39 (0.77 - 4.91)	14.89 99
15+15+25+35+42	1.52	1.52	2.54	3.55	4.26		13.40 (3.50 - 15.60)	3.38 (0.77 - 4.90)	14.84 99
15+15+25+35+50	1.44	1.44	2.39	3.35	4.79		13.40 (3.50 - 15.60)	3.38 (0.77 - 4.90)	14.84 99
15+15+25+35+60	1.34	1.34	2.23	3.13	5.36		13.40 (3.50 - 15.60)	3.37 (0.77 - 4.89)	14.80 99
15+15+25+35+71	1.25	1.25	2.08	2.91	5.91		13.40 (3.50 - 15.60)	3.36 (0.77 - 4.88)	14.76 99
15+15+25+42+42	1.45	1.45	2.41	4.05	4.05		13.40 (3.50 - 15.60)	3.38 (0.77 - 4.90)	14.84 99
15+15+25+42+50	1.37	1.37	2.28	3.83	4.56		13.40 (3.50 - 15.60)	3.37 (0.77 - 4.89)	14.80 99
15+15+25+42+60	1.28	1.28	2.13	3.58	5.12		13.40 (3.50 - 15.60)	3.36 (0.77 - 4.88)	14.76 99
15+15+25+42+71	1.20	1.20	1.99	3.35	5.66		13.40 (3.50 - 15.60)	3.36 (0.77 - 4.88)	14.76 99
15+15+25+50+50	1.30	1.30	2.16	4.32	4.32		13.40 (3.50 - 15.60)	3.37 (0.77 - 4.89)	14.80 99
15+15+25+50+60	1.22	1.22	2.03	4.06	4.87		13.40 (3.50 - 15.60)	3.36 (0.77 - 4.88)	14.76 99
15+15+25+50+71	1.14	1.14	1.90	3.81	5.41		13.40 (3.50 - 15.60)	3.35 (0.77 - 4.87)	14.71 99
15+15+25+60+60	1.15	1.15	1.91	4.59	4.59		13.40 (3.50 - 15.60)	3.35 (0.77 - 4.87)	14.71 99
15+15+35+35+35	1.49	1.49	3.47	3.47	3.47		13.40 (3.50 - 15.60)	3.38 (0.77 - 4.90)	14.84 99
15+15+35+35+42	1.42	1.42	3.30	3.30	3.96		13.40 (3.50 - 15.60)	3.38 (0.77 - 4.90)	14.84 99
15+15+35+35+50	1.34	1.34	3.13	3.13	4.47		13.40 (3.50 - 15.60)	3.37 (0.77 - 4.89)	14.80 99
15+15+35+35+60	1.26	1.26	2.93	2.93	5.03		13.40 (3.50 - 15.60)	3.36 (0.77 - 4.88)	14.76 99
15+15+35+35+71	1.18	1.18	2.74	2.74	5.56		13.40 (3.50 - 15.60)	3.35 (0.77 - 4.87)	14.71 99
15+15+35+42+42	1.35	1.35	3.15	3.78	3.78		13.40 (3.50 - 15.60)	3.37 (0.77 - 4.89)	14.80 99
15+15+35+42+50	1.28	1.28	2.99	3.58	4.27		13.40 (3.50 - 15.60)	3.36 (0.77 - 4.88)	14.76 99
15+15+35+42+60	1.20	1.20	2.81	3.37	4.81		13.40 (3.50 - 15.60)	3.36 (0.77 - 4.88)	14.76 99
15+15+35+42+71	1.13	1.13	2.63	3.16	5.34		13.40 (3.50 - 15.60)	3.35 (0.77 - 4.87)	14.71 99
15+15+35+50+50	1.22	1.22	2.84	4.06	4.06		13.40 (3.50 - 15.60)	3.36 (0.77 - 4.88)	14.76 99
15+15+35+50+60	1.15	1.15	2.68	3.83	4.59		13.40 (3.50 - 15.60)	3.35 (0.77 - 4.87)	14.71 99
15+15+42+42+42	1.29	1.29	3.61	3.61	3.61		13.40 (3.50 - 15.60)	3.37 (0.77 - 4.89)	14.80 99
15+15+42+42+50	1.23	1.23	3.43	3.43	4.09		13.40 (3.50 - 15.60)	3.36 (0.77 - 4.88)	14.76 99
15+15+42+42+60	1.16	1.16	3.23	3.23	4.62		13.40 (3.50 - 15.60)	3.35 (0.77 - 4.87)	14.71 99
15+15+42+50+50	1.17	1.17	3.27	3.90	3.90		13.40 (3.50 - 15.60)	3.35 (0.77 - 4.87)	14.71 99
15+15+50+50+50	1.12	1.12	3.72	3.72	3.72		13.40 (3.50 - 15.60)	3.35 (0.77 - 4.87)	14.71 99
15+20+20+20+20	1.66	2.21	2.21	2.21	2.21		10.50 (3.40 - 14.70)	2.73 (0.80 - 5.56)	11.99 99
15+20+20+20+22	1.65	2.21	2.21	2.21	2.43		10.70 (3.40 - 14.80)	2.81 (0.80 - 5.60)	12.34 99
15+20+20+20+25	1.65	2.20	2.20	2.20	2.75		11.00 (3.40 - 14.90)	2.93 (0.80 - 5.64)	12.87 99
15+20+20+20+35	1.79	2.38	2.38	2.38	4.17		13.10 (3.50 - 15.20)	3.13 (0.77 - 4.46)	13.75 99
15+20+20+20+42	1.69	2.26	2.26	2.26	4.74		13.20 (3.50 - 15.40)	3.22 (0.77 - 4.69)	14.14 99
15+20+20+20+50	1.61	2.14	2.14	2.14	5.36		13.40 (3.50 - 15.60)	3.39 (0.77 - 4.91)	14.89 99
15+20+20+20+60	1.49	1.99	1.99	1.99	5.96		13.40 (3.50 - 15.60)	3.38 (0.77 - 4.90)	14.84 99
15+20+20+20+71	1.38	1.84	1.84	1.84	6.52		13.40 (3.50 - 15.60)	3.37 (0.77 - 4.89)	14.80 99

MXZ-6C120VA HEATING

Indoor units combination	Heating capacity (kW)						Outdoor unit power consumption (kW)	Current (A)	Power factor (%)
	Unit A	Unit B	Unit C	Unit D	Unit E	Unit F			
15+15+15+20+20	1.68	1.68	1.68	2.24	2.24		9.50 (3.40 - 14.20)	2.32 (0.80 - 5.37)	10.19 99
15+15+15+20+22	1.67	1.67	1.67	2.23	2.45		9.70 (3.40 - 14.30)	2.40 (0.80 - 5.41)	10.54 99
15+15+15+20+25	1.67	1.67	1.67	2.22	2.78		10.00 (3.40 - 14.50)	2.52 (0.80 - 5.49)	11.07 99
15+15+15+20+35	1.65	1.65	1.65	2.20	3.85		11.00 (3.40 - 14.90)	2.93 (0.80 - 5.64)	12.87 99
15+15+15+20+42	1.75	1.75	1.75	2.34	4.91		12.50 (3.50 - 15.10)	3.07 (0.78 - 4.85)	13.48 99
15+15+15+20+50	1.72	1.72	1.72	2.30	5.74		13.20 (3.50 - 15.30)	3.22 (0.77 - 4.57)	14.14 99
15+15+15+20+60	1.61	1.61	1.61	2.14	6.43		13.40 (3.50 - 15.60)	3.39 (0.77 - 4.91)	14.89 99
15+15+15+20+71	1.48	1.48	1.48	1.97	7.00		13.40 (3.50 - 15.60)	3.38 (0.77 - 4.90)	14.84 99
15+15+15+22+22	1.67	1.67	1.67	2.45	2.45		9.90 (3.40 - 14.40)	2.48 (0.80 - 5.45)	10.89 99
15+15+15+22+25	1.66	1.66	1.66	2.44	2.77		10.20 (3.40 - 14.50)	2.60 (0.80 - 5.49)	11.42 99
15+15+15+22+35	1.68	1.68	1.68	2.46	3.91		11.40 (3.40 - 15.00)	2.97 (0.79 - 5.25)	13.04 99
15+15+15+22+42	1.78	1.78	1.78	2.60	4.97		12.90 (3.50 - 15.20)	3.11 (0.77 - 4.46)	13.66 99
15+15+15+22+50	1.69	1.69	1.69	2.48	5.64		13.20 (3.50 - 15.40)	3.22 (0.77 - 4.69)	14.14 99
15+15+15+22+60	1.58	1.58	1.58	2.32	6.33		13.40 (3.50 - 15.60)	3.39 (0.77 - 4.91)	14.89 99
15+15+15+22+71	1.46	1.46	1.46	2.14	6.89		13.40 (3.50 - 15.60)	3.38 (0.77 - 4.90)	14.84 99
15+15+15+25+25	1.66	1.66	1.66	2.76	2.76		10.50 (3.40 - 14.70)	2.73 (0.80 - 5.56)	11.99 99
15+15+15+25+35	1.73	1.73	1.73	2.88	4.03		12.10 (3.50 - 15.10)	3.03 (0.79 - 4.85)	13.31 99
15+15+15+25+42	1.75	1.75	1.75	2.92	4.91		13.10 (3.50 - 15.30)	3.13 (0.77 - 4.57)	13.75 99
15+15+15+25+50	1.66	1.66	1.66	2.77	5.54		13.30 (3.50 - 15.50)	3.30 (0.77 - 4.80)	14.49 99
15+15+15+25+60	1.55	1.55	1.55	2.58	6.18		13.40 (3.50 - 15.60)	3.39 (0.77 - 4.91)	14.89 99
15+15+15+25+71	1.43	1.43	1.43	2.38	6.75		13.40 (3.50 - 15.60)	3.38 (0.77 - 4.90)	14.84 99
15+15+15+35+35	1.72	1.72	1.72	4.02	4.02		13.20 (3.50 - 15.30)	3.22 (0.77 - 4.57)	14.14 99
15+15+15+35+42	1.64	1.64	1.64	3.82	4.58		13.30 (3.50 - 15.50)	3.30 (0.77 - 4.80)	14.49 99
15+15+15+35+50	1.55	1.55	1.55	3.61	5.15		13.40 (3.50 - 15.60)	3.39 (0.77 - 4.91)	14.89 99
15+15+15+35+60	1.44	1.44	1.44	3.35	5.74		13.40 (3.50 - 15.60)	3.38 (0.77 - 4.90)	14.84 99
15+15+15+35+71	1.33	1.33	1.33	3.11	6.30		13.40 (3.50 - 15.60)	3.37 (0.77 - 4.89)	14.80 99
15+15+15+42+42	1.56	1.56	1.56	4.36	4.36		13.40 (3.50 - 15.60)	3.39 (0.77 - 4.91)	14.89 99
15+15+15+42+50	1.47	1.47	1.47	4.11	4.89		13.40 (3.50 - 15.60)	3.38 (0.77 - 4.90)	14.84 99
15+15+15+42+60	1.37	1.37	1.37	3.83	5.47		13.40 (3.50 - 15.60)	3.37 (0.77 - 4.89)	14.80 99
15+15+15+42+71	1.27	1.27	1.27	3.56	6.02		13.40 (3.50 - 15.60)	3.36 (0.77 - 4.88)	14.76 99
15+15+15+50+50	1.39	1.39	1.39	4.62	4.62		13.40 (3.50 - 15.60)	3.37 (0.77 - 4.89)	14.80 99
15+15+15+50+60	1.30	1.30	1.30	4.32	5.19		13.40 (3.50 - 15.60)	3.37 (0.77 - 4.89)	14.80 99
15+15+15+50+71	1.21	1.21	1.21	4.04	5.73		13.40 (3.50 - 15.60)	3.36 (0.77 - 4.88)	14.76 99
15+15+15+60+60	1.22	1.22	1.22	4.87	4.87		13.40 (3.50 - 15.60)	3.36 (0.77 - 4.88)	14.76 99
15+15+15+60+71	1.14	1.14	1.14	4.57	5.41		13.40 (3.50 - 15.60)	3.35 (0.77 - 4.87)	14.71 99
15+15+20+20+20	1.67	1.67	2.22	2.22	2.22		10.00 (3.40 - 14.50)	2.52 (0.80 - 5.49)	11.07 99
15+15+20+20+22	1.66	1.66	2.22	2.22	2.44		10.20 (3.40 - 14.50)	2.60 (0.80 - 5.49)	11.42 99
15+15+20+20+25	1.66	1.66	2.21	2.21	2.76		10.50 (3.40 - 14.70)	2.73 (0.80 - 5.56)	11.99 99
15+15+20+20+35	1.73	1.73	2.30	2.30	4.03		12.10 (3.50 - 15.10)	3.03 (0.79 - 4.85)	13.31 99
15+15+20+20+42	1.75	1.75	2.34	2.34	4.91		13.10 (3.50 - 15.30)	3.13 (0.77 - 4.57)	13.75 99
15+15+20+20+50	1.66	1.66	2.22	2.22	5.54		13.30 (3.50 - 15.50)	3.30 (0.77 - 4.80)	14.49 99
15+15+20+20+60	1.55	1.55	2.06	2.06	6.18		13.40 (3.50 - 15.60)	3.39 (0.77 - 4.91)	14.89 99
15+15+20+20+71	1.43	1.43	1.90	1.90	6.75		13.40 (3.50 - 15.60)	3.38 (0.77 - 4.90)	14.84 99
15+15+20+22+22	1.66	1.66	2.21	2.43	2.43		10.40 (3.40 - 14.60)	2.69 (0.80 - 5.53)	11.81 99
15+15+20+22+25	1.65	1.65	2.21	2.43	2.76		10.70 (3.40 - 14.80)	2.81 (0.80 - 5.60)	12.34 99
15+15+20+22+35	1.75	1.75	2.34	2.57	4.09		12.50 (3.50 - 15.10)	3.07 (0.78 - 4.85)	13.48 99

MXZ-6C120VA HEATING

Indoor units combination	Heating capacity (kW)						Outdoor unit power consumption (kW)	Current (A)	Power factor (%)	
	Unit A	Unit B	Unit C	Unit D	Unit E	Unit F				
15+15+20+22+42	1.74	1.74	2.32	2.55	4.86		13.20 (3.50 - 15.30)	3.22 (0.77 - 4.57)	14.14	99
15+15+20+22+50	1.64	1.64	2.18	2.40	5.45		13.30 (3.50 - 15.50)	3.30 (0.77 - 4.80)	14.49	99
15+15+20+22+60	1.52	1.52	2.03	2.23	6.09		13.40 (3.50 - 15.60)	3.38 (0.77 - 4.90)	14.84	99
15+15+20+22+71	1.41	1.41	1.87	2.06	6.65		13.40 (3.50 - 15.60)	3.38 (0.77 - 4.90)	14.84	99
15+15+20+25+25	1.65	1.65	2.20	2.75	2.75		11.00 (3.40 - 14.90)	2.93 (0.80 - 5.64)	12.87	99
15+15+20+25+35	1.79	1.79	2.38	2.98	4.17		13.10 (3.50 - 15.20)	3.13 (0.77 - 4.46)	13.75	99
15+15+20+25+42	1.69	1.69	2.26	2.82	4.74		13.20 (3.50 - 15.40)	3.22 (0.77 - 4.69)	14.14	99
15+15+20+25+50	1.61	1.61	2.14	2.68	5.36		13.40 (3.50 - 15.60)	3.39 (0.77 - 4.91)	14.89	99
15+15+20+25+60	1.49	1.49	1.99	2.48	5.96		13.40 (3.50 - 15.60)	3.38 (0.77 - 4.90)	14.84	99
15+15+20+25+71	1.38	1.38	1.84	2.29	6.52		13.40 (3.50 - 15.60)	3.37 (0.77 - 4.89)	14.80	99
15+15+20+35+35	1.66	1.66	2.22	3.88	3.88		13.30 (3.50 - 15.50)	3.30 (0.77 - 4.80)	14.49	99
15+15+20+35+42	1.58	1.58	2.11	3.69	4.43		13.40 (3.50 - 15.60)	3.39 (0.77 - 4.91)	14.89	99
15+15+20+35+50	1.49	1.49	1.99	3.47	4.96		13.40 (3.50 - 15.60)	3.38 (0.77 - 4.90)	14.84	99
15+15+20+35+60	1.39	1.39	1.85	3.23	5.54		13.40 (3.50 - 15.60)	3.37 (0.77 - 4.89)	14.80	99
15+15+20+35+71	1.29	1.29	1.72	3.01	6.10		13.40 (3.50 - 15.60)	3.37 (0.77 - 4.89)	14.80	99
15+15+20+42+42	1.50	1.50	2.00	4.20	4.20		13.40 (3.50 - 15.60)	3.38 (0.77 - 4.90)	14.84	99
15+15+20+42+50	1.42	1.42	1.89	3.96	4.72		13.40 (3.50 - 15.60)	3.38 (0.77 - 4.90)	14.84	99
15+15+20+42+60	1.32	1.32	1.76	3.70	5.29		13.40 (3.50 - 15.60)	3.37 (0.77 - 4.89)	14.80	99
15+15+20+42+71	1.23	1.23	1.64	3.45	5.84		13.40 (3.50 - 15.60)	3.36 (0.77 - 4.88)	14.76	99
15+15+20+50+50	1.34	1.34	1.79	4.47	4.47		13.40 (3.50 - 15.60)	3.37 (0.77 - 4.89)	14.80	99
15+15+20+50+60	1.26	1.26	1.68	4.19	5.03		13.40 (3.50 - 15.60)	3.36 (0.77 - 4.88)	14.76	99
15+15+20+50+71	1.18	1.18	1.57	3.92	5.56		13.40 (3.50 - 15.60)	3.35 (0.77 - 4.87)	14.71	99
15+15+20+60+60	1.18	1.18	1.58	4.73	4.73		13.40 (3.50 - 15.60)	3.35 (0.77 - 4.87)	14.71	99
15+15+22+22+22	1.66	1.66	2.43	2.43	2.43		10.60 (3.40 - 14.70)	2.77 (0.80 - 5.56)	12.17	99
15+15+22+22+25	1.65	1.65	2.42	2.42	2.75		10.90 (3.40 - 14.90)	2.89 (0.80 - 5.64)	12.69	99
15+15+22+22+35	1.78	1.78	2.60	2.60	4.14		12.90 (3.50 - 15.20)	3.11 (0.77 - 4.46)	13.66	99
15+15+22+22+42	1.71	1.71	2.50	2.50	4.78		13.20 (3.50 - 15.40)	3.22 (0.77 - 4.69)	14.14	99
15+15+22+22+50	1.62	1.62	2.38	2.38	5.40		13.40 (3.50 - 15.60)	3.39 (0.77 - 4.91)	14.89	99
15+15+22+22+60	1.50	1.50	2.20	2.20	6.00		13.40 (3.50 - 15.60)	3.38 (0.77 - 4.90)	14.84	99
15+15+22+22+71	1.39	1.39	2.03	2.03	6.56		13.40 (3.50 - 15.60)	3.37 (0.77 - 4.89)	14.80	99
15+15+22+25+25	1.68	1.68	2.46	2.79	2.79		11.40 (3.40 - 15.00)	2.97 (0.79 - 5.25)	13.04	99
15+15+22+25+35	1.75	1.75	2.57	2.92	4.09		13.10 (3.50 - 15.30)	3.13 (0.77 - 4.57)	13.75	99
15+15+22+25+42	1.68	1.68	2.46	2.79	4.69		13.30 (3.50 - 15.40)	3.30 (0.77 - 4.69)	14.49	99
15+15+22+25+50	1.58	1.58	2.32	2.64	5.28		13.40 (3.50 - 15.60)	3.39 (0.77 - 4.91)	14.89	99
15+15+22+25+60	1.47	1.47	2.15	2.45	5.87		13.40 (3.50 - 15.60)	3.38 (0.77 - 4.90)	14.84	99
15+15+22+25+71	1.36	1.36	1.99	2.26	6.43		13.40 (3.50 - 15.60)	3.37 (0.77 - 4.89)	14.80	99
15+15+22+35+35	1.64	1.64	2.40	3.82	3.82		13.30 (3.50 - 15.50)	3.30 (0.77 - 4.80)	14.49	99
15+15+22+35+42	1.56	1.56	2.29	3.64	4.36		13.40 (3.50 - 15.60)	3.39 (0.77 - 4.91)	14.89	99
15+15+22+35+50	1.47	1.47	2.15	3.42	4.89		13.40 (3.50 - 15.60)	3.38 (0.77 - 4.90)	14.84	99
15+15+22+35+60	1.37	1.37	2.01	3.19	5.47		13.40 (3.50 - 15.60)	3.37 (0.77 - 4.89)	14.80	99
15+15+22+35+71	1.27	1.27	1.87	2.97	6.02		13.40 (3.50 - 15.60)	3.36 (0.77 - 4.88)	14.76	99
15+15+22+42+42	1.48	1.48	2.17	4.14	4.14		13.40 (3.50 - 15.60)	3.38 (0.77 - 4.90)	14.84	99
15+15+22+42+50	1.40	1.40	2.05	3.91	4.65		13.40 (3.50 - 15.60)	3.37 (0.77 - 4.89)	14.80	99
15+15+22+42+60	1.31	1.31	1.91	3.65	5.22		13.40 (3.50 - 15.60)	3.37 (0.77 - 4.89)	14.80	99
15+15+22+42+71	1.22	1.22	1.79	3.41	5.77		13.40 (3.50 - 15.60)	3.36 (0.77 - 4.88)	14.76	99
15+15+22+50+50	1.32	1.32	1.94	4.41	4.41		13.40 (3.50 - 15.60)	3.37 (0.77 - 4.89)	14.80	99

MXZ-6C120VA HEATING

Indoor units combination	Heating capacity (kW)						Outdoor unit power consumption (kW)	Current (A)	Power factor (%)
	Unit A	Unit B	Unit C	Unit D	Unit E	Unit F			
15+15+22+50+60	1.24	1.24	1.82	4.14	4.96		(13.40 / 3.50 - 15.60) (3.36 / 0.77 - 4.88)	14.76	99
15+15+22+50+71	1.16	1.16	1.70	3.87	5.50		(13.40 / 3.50 - 15.60) (3.35 / 0.77 - 4.87)	14.71	99
15+15+22+60+60	1.17	1.17	1.71	4.67	4.67		(13.40 / 3.50 - 15.60) (3.35 / 0.77 - 4.87)	14.71	99
15+15+25+25+25	1.73	1.73	2.88	2.88	2.88		(12.10 / 3.50 - 15.10) (3.03 / 0.79 - 4.85)	13.31	99
15+15+25+25+35	1.72	1.72	2.87	2.87	4.02		(13.20 / 3.50 - 15.30) (3.22 / 0.77 - 4.57)	14.14	99
15+15+25+25+42	1.64	1.64	2.73	2.73	4.58		(13.30 / 3.50 - 15.50) (3.30 / 0.77 - 4.80)	14.49	99
15+15+25+25+50	1.55	1.55	2.58	2.58	5.15		(13.40 / 3.50 - 15.60) (3.39 / 0.77 - 4.91)	14.89	99
15+15+25+25+60	1.44	1.44	2.39	2.39	5.74		(13.40 / 3.50 - 15.60) (3.38 / 0.77 - 4.90)	14.84	99
15+15+25+25+71	1.33	1.33	2.22	2.22	6.30		(13.40 / 3.50 - 15.60) (3.37 / 0.77 - 4.89)	14.80	99
15+15+25+35+35	1.61	1.61	2.68	3.75	3.75		(13.40 / 3.50 - 15.60) (3.39 / 0.77 - 4.91)	14.89	99
15+15+25+35+42	1.52	1.52	2.54	3.55	4.26		(13.40 / 3.50 - 15.60) (3.38 / 0.77 - 4.90)	14.84	99
15+15+25+35+50	1.44	1.44	2.39	3.35	4.79		(13.40 / 3.50 - 15.60) (3.38 / 0.77 - 4.90)	14.84	99
15+15+25+35+60	1.34	1.34	2.23	3.13	5.36		(13.40 / 3.50 - 15.60) (3.37 / 0.77 - 4.89)	14.80	99
15+15+25+35+71	1.25	1.25	2.08	2.91	5.91		(13.40 / 3.50 - 15.60) (3.36 / 0.77 - 4.88)	14.76	99
15+15+25+42+42	1.45	1.45	2.41	4.05	4.05		(13.40 / 3.50 - 15.60) (3.38 / 0.77 - 4.90)	14.84	99
15+15+25+42+50	1.37	1.37	2.28	3.83	4.56		(13.40 / 3.50 - 15.60) (3.37 / 0.77 - 4.89)	14.80	99
15+15+25+42+60	1.28	1.28	2.13	3.58	5.12		(13.40 / 3.50 - 15.60) (3.36 / 0.77 - 4.88)	14.76	99
15+15+25+42+71	1.20	1.20	1.99	3.35	5.66		(13.40 / 3.50 - 15.60) (3.36 / 0.77 - 4.88)	14.76	99
15+15+25+50+50	1.30	1.30	2.16	4.32	4.32		(13.40 / 3.50 - 15.60) (3.37 / 0.77 - 4.89)	14.80	99
15+15+25+50+60	1.22	1.22	2.03	4.06	4.87		(13.40 / 3.50 - 15.60) (3.36 / 0.77 - 4.88)	14.76	99
15+15+25+50+71	1.14	1.14	1.90	3.81	5.41		(13.40 / 3.50 - 15.60) (3.35 / 0.77 - 4.87)	14.71	99
15+15+25+60+60	1.15	1.15	1.91	4.59	4.59		(13.40 / 3.50 - 15.60) (3.35 / 0.77 - 4.87)	14.71	99
15+15+35+35+35	1.49	1.49	3.47	3.47	3.47		(13.40 / 3.50 - 15.60) (3.38 / 0.77 - 4.90)	14.84	99
15+15+35+35+42	1.42	1.42	3.30	3.30	3.96		(13.40 / 3.50 - 15.60) (3.38 / 0.77 - 4.90)	14.84	99
15+15+35+35+50	1.34	1.34	3.13	3.13	4.47		(13.40 / 3.50 - 15.60) (3.37 / 0.77 - 4.89)	14.80	99
15+15+35+35+60	1.26	1.26	2.93	2.93	5.03		(13.40 / 3.50 - 15.60) (3.36 / 0.77 - 4.88)	14.76	99
15+15+35+35+71	1.18	1.18	2.74	2.74	5.56		(13.40 / 3.50 - 15.60) (3.35 / 0.77 - 4.87)	14.71	99
15+15+35+42+42	1.35	1.35	3.15	3.78	3.78		(13.40 / 3.50 - 15.60) (3.37 / 0.77 - 4.89)	14.80	99
15+15+35+42+50	1.28	1.28	2.99	3.58	4.27		(13.40 / 3.50 - 15.60) (3.36 / 0.77 - 4.88)	14.76	99
15+15+35+42+60	1.20	1.20	2.81	3.37	4.81		(13.40 / 3.50 - 15.60) (3.36 / 0.77 - 4.88)	14.76	99
15+15+35+42+71	1.13	1.13	2.63	3.16	5.34		(13.40 / 3.50 - 15.60) (3.35 / 0.77 - 4.87)	14.71	99
15+15+35+50+50	1.22	1.22	2.84	4.06	4.06		(13.40 / 3.50 - 15.60) (3.36 / 0.77 - 4.88)	14.76	99
15+15+35+50+60	1.15	1.15	2.68	3.83	4.59		(13.40 / 3.50 - 15.60) (3.35 / 0.77 - 4.87)	14.71	99
15+15+42+42+42	1.29	1.29	3.61	3.61	3.61		(13.40 / 3.50 - 15.60) (3.37 / 0.77 - 4.89)	14.80	99
15+15+42+42+50	1.23	1.23	3.43	3.43	4.09		(13.40 / 3.50 - 15.60) (3.36 / 0.77 - 4.88)	14.76	99
15+15+42+42+60	1.16	1.16	3.23	3.23	4.62		(13.40 / 3.50 - 15.60) (3.35 / 0.77 - 4.87)	14.71	99
15+15+42+50+50	1.17	1.17	3.27	3.90	3.90		(13.40 / 3.50 - 15.60) (3.35 / 0.77 - 4.87)	14.71	99
15+15+50+50+50	1.12	1.12	3.72	3.72	3.72		(13.40 / 3.50 - 15.60) (3.35 / 0.77 - 4.87)	14.71	99
15+20+20+20+20	1.66	2.21	2.21	2.21	2.21		(10.50 / 3.40 - 14.70) (2.73 / 0.80 - 5.56)	11.99	99
15+20+20+20+22	1.65	2.21	2.21	2.21	2.43		(10.70 / 3.40 - 14.80) (2.81 / 0.80 - 5.60)	12.34	99
15+20+20+20+25	1.65	2.20	2.20	2.20	2.75		(11.00 / 3.40 - 14.90) (2.93 / 0.80 - 5.64)	12.87	99
15+20+20+20+35	1.79	2.38	2.38	2.38	4.17		(13.10 / 3.50 - 15.20) (3.13 / 0.77 - 4.46)	13.75	99
15+20+20+20+42	1.69	2.26	2.26	2.26	4.74		(13.20 / 3.50 - 15.40) (3.22 / 0.77 - 4.69)	14.14	99
15+20+20+20+50	1.61	2.14	2.14	2.14	5.36		(13.40 / 3.50 - 15.60) (3.39 / 0.77 - 4.91)	14.89	99
15+20+20+20+60	1.49	1.99	1.99	1.99	5.96		(13.40 / 3.50 - 15.60) (3.38 / 0.77 - 4.90)	14.84	99
15+20+20+20+71	1.38	1.84	1.84	1.84	6.52		(13.40 / 3.50 - 15.60) (3.37 / 0.77 - 4.89)	14.80	99

MXZ-6C120VA HEATING

Indoor units combination	Heating capacity (kW)						Outdoor unit power consumption (kW)	Current (A)	Power factor (%)	
	Unit A	Unit B	Unit C	Unit D	Unit E	Unit F				
15+20+20+22+22	1.65	2.20	2.20	2.42	2.42		10.90 (3.40 - 14.90)	2.89 (0.80 - 5.64)	12.69	99
15+20+20+22+25	1.68	2.24	2.24	2.46	2.79		11.40 (3.40 - 15.00)	2.97 (0.79 - 5.25)	13.04	99
15+20+20+22+35	1.75	2.34	2.34	2.57	4.09		13.10 (3.50 - 15.30)	3.13 (0.77 - 4.57)	13.75	99
15+20+20+22+42	1.68	2.24	2.24	2.46	4.69		13.30 (3.50 - 15.40)	3.30 (0.77 - 4.69)	14.49	99
15+20+20+22+50	1.58	2.11	2.11	2.32	5.28		13.40 (3.50 - 15.60)	3.39 (0.77 - 4.91)	14.89	99
15+20+20+22+60	1.47	1.96	1.96	2.15	5.87		13.40 (3.50 - 15.60)	3.38 (0.77 - 4.90)	14.84	99
15+20+20+22+71	1.36	1.81	1.81	1.99	6.43		13.40 (3.50 - 15.60)	3.37 (0.77 - 4.89)	14.80	99
15+20+20+25+25	1.73	2.30	2.30	2.88	2.88		12.10 (3.50 - 15.10)	3.03 (0.79 - 4.85)	13.31	99
15+20+20+25+35	1.72	2.30	2.30	2.87	4.02		13.20 (3.50 - 15.30)	3.22 (0.77 - 4.57)	14.14	99
15+20+20+25+42	1.64	2.18	2.18	2.73	4.58		13.30 (3.50 - 15.50)	3.30 (0.77 - 4.80)	14.49	99
15+20+20+25+50	1.55	2.06	2.06	2.58	5.15		13.40 (3.50 - 15.60)	3.39 (0.77 - 4.91)	14.89	99
15+20+20+25+60	1.44	1.91	1.91	2.39	5.74		13.40 (3.50 - 15.60)	3.38 (0.77 - 4.90)	14.84	99
15+20+20+25+71	1.33	1.77	1.77	2.22	6.30		13.40 (3.50 - 15.60)	3.37 (0.77 - 4.89)	14.80	99
15+20+20+35+35	1.61	2.14	2.14	3.75	3.75		13.40 (3.50 - 15.60)	3.39 (0.77 - 4.91)	14.89	99
15+20+20+35+42	1.52	2.03	2.03	3.55	4.26		13.40 (3.50 - 15.60)	3.38 (0.77 - 4.90)	14.84	99
15+20+20+35+50	1.44	1.91	1.91	3.35	4.79		13.40 (3.50 - 15.60)	3.38 (0.77 - 4.90)	14.84	99
15+20+20+35+60	1.34	1.79	1.79	3.13	5.36		13.40 (3.50 - 15.60)	3.37 (0.77 - 4.89)	14.80	99
15+20+20+35+71	1.25	1.66	1.66	2.91	5.91		13.40 (3.50 - 15.60)	3.36 (0.77 - 4.88)	14.76	99
15+20+20+42+42	1.45	1.93	1.93	4.05	4.05		13.40 (3.50 - 15.60)	3.38 (0.77 - 4.90)	14.84	99
15+20+20+42+50	1.37	1.82	1.82	3.83	4.56		13.40 (3.50 - 15.60)	3.37 (0.77 - 4.89)	14.80	99
15+20+20+42+60	1.28	1.71	1.71	3.58	5.12		13.40 (3.50 - 15.60)	3.36 (0.77 - 4.88)	14.76	99
15+20+20+42+71	1.20	1.60	1.60	3.35	5.66		13.40 (3.50 - 15.60)	3.36 (0.77 - 4.88)	14.76	99
15+20+20+50+50	1.30	1.73	1.73	4.32	4.32		13.40 (3.50 - 15.60)	3.37 (0.77 - 4.89)	14.80	99
15+20+20+50+60	1.22	1.62	1.62	4.06	4.87		13.40 (3.50 - 15.60)	3.36 (0.77 - 4.88)	14.76	99
15+20+20+50+71	1.14	1.52	1.52	3.81	5.41		13.40 (3.50 - 15.60)	3.35 (0.77 - 4.87)	14.71	99
15+20+20+60+60	1.15	1.53	1.53	4.59	4.59		13.40 (3.50 - 15.60)	3.35 (0.77 - 4.87)	14.71	99
15+20+22+22+22	1.66	2.22	2.44	2.44	2.44		11.20 (3.40 - 14.90)	2.95 (0.80 - 5.64)	12.96	99
15+20+22+22+25	1.70	2.27	2.50	2.50	2.84		11.80 (3.40 - 15.00)	3.01 (0.79 - 5.25)	13.22	99
15+20+22+22+35	1.74	2.32	2.55	2.55	4.05		13.20 (3.50 - 15.30)	3.22 (0.77 - 4.57)	14.14	99
15+20+22+22+42	1.65	2.20	2.42	2.42	4.62		13.30 (3.50 - 15.50)	3.30 (0.77 - 4.80)	14.49	99
15+20+22+22+50	1.56	2.08	2.29	2.29	5.19		13.40 (3.50 - 15.60)	3.39 (0.77 - 4.91)	14.89	99
15+20+22+22+60	1.45	1.93	2.12	2.12	5.78		13.40 (3.50 - 15.60)	3.38 (0.77 - 4.90)	14.84	99
15+20+22+22+71	1.34	1.79	1.97	1.97	6.34		13.40 (3.50 - 15.60)	3.37 (0.77 - 4.89)	14.80	99
15+20+22+25+25	1.75	2.34	2.57	2.92	2.92		12.50 (3.50 - 15.10)	3.07 (0.78 - 4.85)	13.48	99
15+20+22+25+35	1.69	2.26	2.48	2.82	3.95		13.20 (3.50 - 15.40)	3.22 (0.77 - 4.69)	14.14	99
15+20+22+25+42	1.62	2.16	2.38	2.70	4.54		13.40 (3.50 - 15.60)	3.39 (0.77 - 4.91)	14.89	99
15+20+22+25+50	1.52	2.03	2.23	2.54	5.08		13.40 (3.50 - 15.60)	3.38 (0.77 - 4.90)	14.84	99
15+20+22+25+60	1.42	1.89	2.08	2.36	5.66		13.40 (3.50 - 15.60)	3.38 (0.77 - 4.90)	14.84	99
15+20+22+25+71	1.31	1.75	1.93	2.19	6.22		13.40 (3.50 - 15.60)	3.37 (0.77 - 4.89)	14.80	99
15+20+22+35+35	1.58	2.11	2.32	3.69	3.69		13.40 (3.50 - 15.60)	3.39 (0.77 - 4.91)	14.89	99
15+20+22+35+42	1.50	2.00	2.20	3.50	4.20		13.40 (3.50 - 15.60)	3.38 (0.77 - 4.90)	14.84	99
15+20+22+35+50	1.42	1.89	2.08	3.30	4.72		13.40 (3.50 - 15.60)	3.38 (0.77 - 4.90)	14.84	99
15+20+22+35+60	1.32	1.76	1.94	3.09	5.29		13.40 (3.50 - 15.60)	3.37 (0.77 - 4.89)	14.80	99
15+20+22+35+71	1.23	1.64	1.81	2.88	5.84		13.40 (3.50 - 15.60)	3.36 (0.77 - 4.88)	14.76	99
15+20+22+42+42	1.43	1.90	2.09	3.99	3.99		13.40 (3.50 - 15.60)	3.38 (0.77 - 4.90)	14.84	99
15+20+22+42+50	1.35	1.80	1.98	3.78	4.50		13.40 (3.50 - 15.60)	3.37 (0.77 - 4.89)	14.80	99

MXZ-6C120VA HEATING

Indoor units combination	Heating capacity (kW)						Outdoor unit power consumption (kW)	Current (A)	Power factor (%)
	Unit A	Unit B	Unit C	Unit D	Unit E	Unit F			
15+20+22+42+60	1.26	1.69	1.85	3.54	5.06		13.40 (3.50 - 15.60)	3.36 (0.77 - 4.88)	14.76 99
15+20+22+42+71	1.18	1.58	1.73	3.31	5.60		13.40 (3.50 - 15.60)	3.35 (0.77 - 4.87)	14.71 99
15+20+22+50+50	1.28	1.71	1.88	4.27	4.27		13.40 (3.50 - 15.60)	3.36 (0.77 - 4.88)	14.76 99
15+20+22+50+60	1.20	1.60	1.77	4.01	4.81		13.40 (3.50 - 15.60)	3.36 (0.77 - 4.88)	14.76 99
15+20+22+50+71	1.13	1.51	1.66	3.76	5.34		13.40 (3.50 - 15.60)	3.35 (0.77 - 4.87)	14.71 99
15+20+22+60+60	1.14	1.51	1.67	4.54	4.54		13.40 (3.50 - 15.60)	3.35 (0.77 - 4.87)	14.71 99
15+20+25+25+25	1.79	2.38	2.98	2.98	2.98		13.10 (3.50 - 15.20)	3.13 (0.77 - 4.46)	13.75 99
15+20+25+25+35	1.66	2.22	2.77	2.77	3.88		13.30 (3.50 - 15.50)	3.30 (0.77 - 4.80)	14.49 99
15+20+25+25+42	1.58	2.11	2.64	2.64	4.43		13.40 (3.50 - 15.60)	3.39 (0.77 - 4.91)	14.89 99
15+20+25+25+50	1.49	1.99	2.48	2.48	4.96		13.40 (3.50 - 15.60)	3.38 (0.77 - 4.90)	14.84 99
15+20+25+25+60	1.39	1.85	2.31	2.31	5.54		13.40 (3.50 - 15.60)	3.37 (0.77 - 4.89)	14.80 99
15+20+25+25+71	1.29	1.72	2.15	2.15	6.10		13.40 (3.50 - 15.60)	3.37 (0.77 - 4.89)	14.80 99
15+20+25+35+35	1.55	2.06	2.58	3.61	3.61		13.40 (3.50 - 15.60)	3.39 (0.77 - 4.91)	14.89 99
15+20+25+35+42	1.47	1.96	2.45	3.42	4.11		13.40 (3.50 - 15.60)	3.38 (0.77 - 4.90)	14.84 99
15+20+25+35+50	1.39	1.85	2.31	3.23	4.62		13.40 (3.50 - 15.60)	3.37 (0.77 - 4.89)	14.80 99
15+20+25+35+60	1.30	1.73	2.16	3.03	5.19		13.40 (3.50 - 15.60)	3.37 (0.77 - 4.89)	14.80 99
15+20+25+35+71	1.21	1.61	2.02	2.83	5.73		13.40 (3.50 - 15.60)	3.36 (0.77 - 4.88)	14.76 99
15+20+25+42+42	1.40	1.86	2.33	3.91	3.91		13.40 (3.50 - 15.60)	3.37 (0.77 - 4.89)	14.80 99
15+20+25+42+50	1.32	1.76	2.20	3.70	4.41		13.40 (3.50 - 15.60)	3.37 (0.77 - 4.89)	14.80 99
15+20+25+42+60	1.24	1.65	2.07	3.47	4.96		13.40 (3.50 - 15.60)	3.36 (0.77 - 4.88)	14.76 99
15+20+25+42+71	1.16	1.55	1.94	3.25	5.50		13.40 (3.50 - 15.60)	3.35 (0.77 - 4.87)	14.71 99
15+20+25+50+50	1.26	1.68	2.09	4.19	4.19		13.40 (3.50 - 15.60)	3.36 (0.77 - 4.88)	14.76 99
15+20+25+50+60	1.18	1.58	1.97	3.94	4.73		13.40 (3.50 - 15.60)	3.35 (0.77 - 4.87)	14.71 99
15+20+25+60+60	1.12	1.49	1.86	4.47	4.47		13.40 (3.50 - 15.60)	3.35 (0.77 - 4.87)	14.71 99
15+20+35+35+35	1.44	1.91	3.35	3.35	3.35		13.40 (3.50 - 15.60)	3.38 (0.77 - 4.90)	14.84 99
15+20+35+35+42	1.37	1.82	3.19	3.19	3.83		13.40 (3.50 - 15.60)	3.37 (0.77 - 4.89)	14.80 99
15+20+35+35+50	1.30	1.73	3.03	3.03	4.32		13.40 (3.50 - 15.60)	3.37 (0.77 - 4.89)	14.80 99
15+20+35+35+60	1.22	1.62	2.84	2.84	4.87		13.40 (3.50 - 15.60)	3.36 (0.77 - 4.88)	14.76 99
15+20+35+35+71	1.14	1.52	2.66	2.66	5.41		13.40 (3.50 - 15.60)	3.35 (0.77 - 4.87)	14.71 99
15+20+35+42+42	1.31	1.74	3.05	3.65	3.65		13.40 (3.50 - 15.60)	3.37 (0.77 - 4.89)	14.80 99
15+20+35+42+50	1.24	1.65	2.90	3.47	4.14		13.40 (3.50 - 15.60)	3.36 (0.77 - 4.88)	14.76 99
15+20+35+42+60	1.17	1.56	2.73	3.27	4.67		13.40 (3.50 - 15.60)	3.35 (0.77 - 4.87)	14.71 99
15+20+35+50+50	1.18	1.58	2.76	3.94	3.94		13.40 (3.50 - 15.60)	3.35 (0.77 - 4.87)	14.71 99
15+20+35+50+60	1.12	1.49	2.61	3.72	4.47		13.40 (3.50 - 15.60)	3.35 (0.77 - 4.87)	14.71 99
15+20+42+42+42	1.25	1.66	3.50	3.50	3.50		13.40 (3.50 - 15.60)	3.36 (0.77 - 4.88)	14.76 99
15+20+42+42+50	1.19	1.59	3.33	3.33	3.96		13.40 (3.50 - 15.60)	3.35 (0.77 - 4.87)	14.71 99
15+20+42+42+60	1.12	1.50	3.14	3.14	4.49		13.40 (3.50 - 15.60)	3.35 (0.77 - 4.87)	14.71 99
15+20+42+50+50	1.14	1.51	3.18	3.79	3.79		13.40 (3.50 - 15.60)	3.35 (0.77 - 4.87)	14.71 99
15+22+22+22+22	1.69	2.48	2.48	2.48	2.48		11.60 (3.40 - 15.00)	2.99 (0.79 - 5.25)	13.13 99
15+22+22+22+25	1.74	2.55	2.55	2.55	2.90		12.30 (3.50 - 15.10)	3.05 (0.78 - 4.85)	13.39 99
15+22+22+22+35	1.71	2.50	2.50	2.50	3.98		13.20 (3.50 - 15.40)	3.22 (0.77 - 4.69)	14.14 99
15+22+22+22+42	1.63	2.40	2.40	2.40	4.58		13.40 (3.50 - 15.50)	3.39 (0.77 - 4.80)	14.89 99
15+22+22+22+50	1.53	2.25	2.25	2.25	5.11		13.40 (3.50 - 15.60)	3.39 (0.77 - 4.91)	14.89 99
15+22+22+22+60	1.43	2.09	2.09	2.09	5.70		13.40 (3.50 - 15.60)	3.38 (0.77 - 4.90)	14.84 99
15+22+22+22+71	1.32	1.94	1.94	1.94	6.26		13.40 (3.50 - 15.60)	3.37 (0.77 - 4.89)	14.80 99
15+22+22+25+25	1.78	2.60	2.60	2.96	2.96		12.90 (3.50 - 15.20)	3.11 (0.77 - 4.46)	13.66 99

MXZ-6C120VA HEATING

Indoor units combination	Heating capacity (kW)						Outdoor unit power consumption (kW)	Current (A)	Power factor (%)
	Unit A	Unit B	Unit C	Unit D	Unit E	Unit F			
15+22+22+25+35	1.68	2.46	2.46	2.79	3.91	13.30 (3.50 - 15.40)	3.30 (0.77 - 4.69)	14.49	99
15+22+22+25+42	1.60	2.34	2.34	2.66	4.47	13.40 (3.50 - 15.60)	3.39 (0.77 - 4.91)	14.89	99
15+22+22+25+50	1.50	2.20	2.20	2.50	5.00	13.40 (3.50 - 15.60)	3.38 (0.77 - 4.90)	14.84	99
15+22+22+25+60	1.40	2.05	2.05	2.33	5.58	13.40 (3.50 - 15.60)	3.37 (0.77 - 4.89)	14.80	99
15+22+22+25+71	1.30	1.90	1.90	2.16	6.14	13.40 (3.50 - 15.60)	3.37 (0.77 - 4.89)	14.80	99
15+22+22+35+35	1.56	2.29	2.29	3.64	3.64	13.40 (3.50 - 15.60)	3.39 (0.77 - 4.91)	14.89	99
15+22+22+35+42	1.48	2.17	2.17	3.45	4.14	13.40 (3.50 - 15.60)	3.38 (0.77 - 4.90)	14.84	99
15+22+22+35+50	1.40	2.05	2.05	3.26	4.65	13.40 (3.50 - 15.60)	3.37 (0.77 - 4.89)	14.80	99
15+22+22+35+60	1.31	1.91	1.91	3.05	5.22	13.40 (3.50 - 15.60)	3.37 (0.77 - 4.89)	14.80	99
15+22+22+35+71	1.22	1.79	1.79	2.84	5.77	13.40 (3.50 - 15.60)	3.36 (0.77 - 4.88)	14.76	99
15+22+22+42+42	1.41	2.06	2.06	3.94	3.94	13.40 (3.50 - 15.60)	3.38 (0.77 - 4.90)	14.84	99
15+22+22+42+50	1.33	1.95	1.95	3.73	4.44	13.40 (3.50 - 15.60)	3.37 (0.77 - 4.89)	14.80	99
15+22+22+42+60	1.25	1.83	1.83	3.50	4.99	13.40 (3.50 - 15.60)	3.36 (0.77 - 4.88)	14.76	99
15+22+22+42+71	1.17	1.71	1.71	3.27	5.53	13.40 (3.50 - 15.60)	3.35 (0.77 - 4.87)	14.71	99
15+22+22+50+50	1.26	1.85	1.85	4.21	4.21	13.40 (3.50 - 15.60)	3.36 (0.77 - 4.88)	14.76	99
15+22+22+50+60	1.19	1.74	1.74	3.96	4.76	13.40 (3.50 - 15.60)	3.35 (0.77 - 4.87)	14.71	99
15+22+22+50+71	1.12	1.64	1.64	3.72	5.29	13.40 (3.50 - 15.60)	3.35 (0.77 - 4.87)	14.71	99
15+22+22+60+60	1.12	1.65	1.65	4.49	4.49	13.40 (3.50 - 15.60)	3.35 (0.77 - 4.87)	14.71	99
15+22+25+25+25	1.75	2.57	2.92	2.92	2.92	13.10 (3.50 - 15.30)	3.13 (0.77 - 4.57)	13.75	99
15+22+25+25+35	1.64	2.40	2.73	2.73	3.82	13.30 (3.50 - 15.50)	3.30 (0.77 - 4.80)	14.49	99
15+22+25+25+42	1.56	2.29	2.60	2.60	4.36	13.40 (3.50 - 15.60)	3.39 (0.77 - 4.91)	14.89	99
15+22+25+25+50	1.47	2.15	2.45	2.45	4.89	13.40 (3.50 - 15.60)	3.38 (0.77 - 4.90)	14.84	99
15+22+25+25+60	1.37	2.01	2.28	2.28	5.47	13.40 (3.50 - 15.60)	3.37 (0.77 - 4.89)	14.80	99
15+22+25+25+71	1.27	1.87	2.12	2.12	6.02	13.40 (3.50 - 15.60)	3.36 (0.77 - 4.88)	14.76	99
15+22+25+35+35	1.52	2.23	2.54	3.55	3.55	13.40 (3.50 - 15.60)	3.38 (0.77 - 4.90)	14.84	99
15+22+25+35+42	1.45	2.12	2.41	3.37	4.05	13.40 (3.50 - 15.60)	3.38 (0.77 - 4.90)	14.84	99
15+22+25+35+50	1.37	2.01	2.28	3.19	4.56	13.40 (3.50 - 15.60)	3.37 (0.77 - 4.89)	14.80	99
15+22+25+35+60	1.28	1.88	2.13	2.99	5.12	13.40 (3.50 - 15.60)	3.36 (0.77 - 4.88)	14.76	99
15+22+25+35+71	1.20	1.75	1.99	2.79	5.66	13.40 (3.50 - 15.60)	3.36 (0.77 - 4.88)	14.76	99
15+22+25+42+42	1.38	2.02	2.29	3.85	3.85	13.40 (3.50 - 15.60)	3.37 (0.77 - 4.89)	14.80	99
15+22+25+42+50	1.31	1.91	2.18	3.65	4.35	13.40 (3.50 - 15.60)	3.37 (0.77 - 4.89)	14.80	99
15+22+25+42+60	1.23	1.80	2.04	3.43	4.90	13.40 (3.50 - 15.60)	3.36 (0.77 - 4.88)	14.76	99
15+22+25+42+71	1.15	1.68	1.91	3.22	5.44	13.40 (3.50 - 15.60)	3.35 (0.77 - 4.87)	14.71	99
15+22+25+50+50	1.24	1.82	2.07	4.14	4.14	13.40 (3.50 - 15.60)	3.36 (0.77 - 4.88)	14.76	99
15+22+25+50+60	1.17	1.71	1.95	3.90	4.67	13.40 (3.50 - 15.60)	3.35 (0.77 - 4.87)	14.71	99
15+22+35+35+35	1.42	2.08	3.30	3.30	3.30	13.40 (3.50 - 15.60)	3.38 (0.77 - 4.90)	14.84	99
15+22+35+35+42	1.35	1.98	3.15	3.15	3.78	13.40 (3.50 - 15.60)	3.37 (0.77 - 4.89)	14.80	99
15+22+35+35+50	1.28	1.88	2.99	2.99	4.27	13.40 (3.50 - 15.60)	3.36 (0.77 - 4.88)	14.76	99
15+22+35+35+60	1.20	1.77	2.81	2.81	4.81	13.40 (3.50 - 15.60)	3.36 (0.77 - 4.88)	14.76	99
15+22+35+35+71	1.13	1.66	2.63	2.63	5.34	13.40 (3.50 - 15.60)	3.35 (0.77 - 4.87)	14.71	99
15+22+35+42+42	1.29	1.89	3.01	3.61	3.61	13.40 (3.50 - 15.60)	3.37 (0.77 - 4.89)	14.80	99
15+22+35+42+50	1.23	1.80	2.86	3.43	4.09	13.40 (3.50 - 15.60)	3.36 (0.77 - 4.88)	14.76	99
15+22+35+42+60	1.16	1.69	2.70	3.23	4.62	13.40 (3.50 - 15.60)	3.35 (0.77 - 4.87)	14.71	99
15+22+35+50+50	1.17	1.71	2.73	3.90	3.90	13.40 (3.50 - 15.60)	3.35 (0.77 - 4.87)	14.71	99
15+22+42+42+42	1.23	1.81	3.45	3.45	3.45	13.40 (3.50 - 15.60)	3.36 (0.77 - 4.88)	14.76	99
15+22+42+42+50	1.18	1.72	3.29	3.29	3.92	13.40 (3.50 - 15.60)	3.35 (0.77 - 4.87)	14.71	99

MXZ-6C120VA HEATING

Indoor units combination	Heating capacity (kW)						Outdoor unit power consumption (kW)	Current (A)	Power factor (%)
	Unit A	Unit B	Unit C	Unit D	Unit E	Unit F			
15+22+42+50+50	1.12	1.65	3.14	3.74	3.74		13.40 (3.50 - 15.60)	3.35 (0.77 - 4.87)	14.71 99
15+25+25+25+25	1.72	2.87	2.87	2.87	2.87		13.20 (3.50 - 15.30)	3.22 (0.77 - 4.57)	14.14 99
15+25+25+25+35	1.61	2.68	2.68	2.68	3.75		13.40 (3.50 - 15.60)	3.39 (0.77 - 4.91)	14.89 99
15+25+25+25+42	1.52	2.54	2.54	2.54	4.26		13.40 (3.50 - 15.60)	3.38 (0.77 - 4.90)	14.84 99
15+25+25+25+50	1.44	2.39	2.39	2.39	4.79		13.40 (3.50 - 15.60)	3.38 (0.77 - 4.90)	14.84 99
15+25+25+25+60	1.34	2.23	2.23	2.23	5.36		13.40 (3.50 - 15.60)	3.37 (0.77 - 4.89)	14.80 99
15+25+25+25+71	1.25	2.08	2.08	2.08	5.91		13.40 (3.50 - 15.60)	3.36 (0.77 - 4.88)	14.76 99
15+25+25+35+35	1.49	2.48	2.48	3.47	3.47		13.40 (3.50 - 15.60)	3.38 (0.77 - 4.90)	14.84 99
15+25+25+35+42	1.42	2.36	2.36	3.30	3.96		13.40 (3.50 - 15.60)	3.38 (0.77 - 4.90)	14.84 99
15+25+25+35+50	1.34	2.23	2.23	3.13	4.47		13.40 (3.50 - 15.60)	3.37 (0.77 - 4.89)	14.80 99
15+25+25+35+60	1.26	2.09	2.09	2.93	5.03		13.40 (3.50 - 15.60)	3.36 (0.77 - 4.88)	14.76 99
15+25+25+35+71	1.18	1.96	1.96	2.74	5.56		13.40 (3.50 - 15.60)	3.35 (0.77 - 4.87)	14.71 99
15+25+25+42+42	1.35	2.25	2.25	3.78	3.78		13.40 (3.50 - 15.60)	3.37 (0.77 - 4.89)	14.80 99
15+25+25+42+50	1.28	2.13	2.13	3.58	4.27		13.40 (3.50 - 15.60)	3.36 (0.77 - 4.88)	14.76 99
15+25+25+42+60	1.20	2.01	2.01	3.37	4.81		13.40 (3.50 - 15.60)	3.36 (0.77 - 4.88)	14.76 99
15+25+25+42+71	1.13	1.88	1.88	3.16	5.34		13.40 (3.50 - 15.60)	3.35 (0.77 - 4.87)	14.71 99
15+25+25+50+50	1.22	2.03	2.03	4.06	4.06		13.40 (3.50 - 15.60)	3.36 (0.77 - 4.88)	14.76 99
15+25+25+50+60	1.15	1.91	1.91	3.83	4.59		13.40 (3.50 - 15.60)	3.35 (0.77 - 4.87)	14.71 99
15+25+35+35+35	1.39	2.31	3.23	3.23	3.23		13.40 (3.50 - 15.60)	3.37 (0.77 - 4.89)	14.80 99
15+25+35+35+42	1.32	2.20	3.09	3.09	3.70		13.40 (3.50 - 15.60)	3.37 (0.77 - 4.89)	14.80 99
15+25+35+35+50	1.26	2.09	2.93	2.93	4.19		13.40 (3.50 - 15.60)	3.36 (0.77 - 4.88)	14.76 99
15+25+35+35+60	1.18	1.97	2.76	2.76	4.73		13.40 (3.50 - 15.60)	3.35 (0.77 - 4.87)	14.71 99
15+25+35+42+42	1.26	2.11	2.95	3.54	3.54		13.40 (3.50 - 15.60)	3.36 (0.77 - 4.88)	14.76 99
15+25+35+42+50	1.20	2.01	2.81	3.37	4.01		13.40 (3.50 - 15.60)	3.36 (0.77 - 4.88)	14.76 99
15+25+35+42+60	1.14	1.89	2.65	3.18	4.54		13.40 (3.50 - 15.60)	3.35 (0.77 - 4.87)	14.71 99
15+25+35+50+50	1.15	1.91	2.68	3.83	3.83		13.40 (3.50 - 15.60)	3.35 (0.77 - 4.87)	14.71 99
15+25+42+42+42	1.21	2.02	3.39	3.39	3.39		13.40 (3.50 - 15.60)	3.36 (0.77 - 4.88)	14.76 99
15+25+42+42+50	1.16	1.93	3.23	3.23	3.85		13.40 (3.50 - 15.60)	3.35 (0.77 - 4.87)	14.71 99
15+35+35+35+35	1.30	3.03	3.03	3.03	3.03		13.40 (3.50 - 15.60)	3.37 (0.77 - 4.89)	14.80 99
15+35+35+35+42	1.24	2.90	2.90	2.90	3.47		13.40 (3.50 - 15.60)	3.36 (0.77 - 4.88)	14.76 99
15+35+35+35+50	1.18	2.76	2.76	2.76	3.94		13.40 (3.50 - 15.60)	3.35 (0.77 - 4.87)	14.71 99
15+35+35+35+60	1.12	2.61	2.61	2.61	4.47		13.40 (3.50 - 15.60)	3.35 (0.77 - 4.87)	14.71 99
15+35+35+42+42	1.19	2.78	2.78	3.33	3.33		13.40 (3.50 - 15.60)	3.35 (0.77 - 4.87)	14.71 99
15+35+35+42+50	1.14	2.65	2.65	3.18	3.79		13.40 (3.50 - 15.60)	3.35 (0.77 - 4.87)	14.71 99
15+35+42+42+42	1.14	2.66	3.20	3.20	3.20		13.40 (3.50 - 15.60)	3.35 (0.77 - 4.87)	14.71 99
20+20+20+20+20	2.20	2.20	2.20	2.20	2.20		11.00 (3.40 - 14.90)	2.93 (0.80 - 5.64)	12.87 99
20+20+20+20+22	2.24	2.24	2.24	2.24	2.46		11.40 (3.40 - 15.00)	2.97 (0.79 - 5.25)	13.04 99
20+20+20+20+25	2.30	2.30	2.30	2.30	2.88		12.10 (3.50 - 15.10)	3.03 (0.79 - 4.85)	13.31 99
20+20+20+20+35	2.30	2.30	2.30	2.30	4.02		13.20 (3.50 - 15.30)	3.22 (0.77 - 4.57)	14.14 99
20+20+20+20+42	2.18	2.18	2.18	2.18	4.58		13.30 (3.50 - 15.50)	3.30 (0.77 - 4.80)	14.49 99
20+20+20+20+50	2.06	2.06	2.06	2.06	5.15		13.40 (3.50 - 15.60)	3.39 (0.77 - 4.91)	14.89 99
20+20+20+20+60	1.91	1.91	1.91	1.91	5.74		13.40 (3.50 - 15.60)	3.38 (0.77 - 4.90)	14.84 99
20+20+20+20+71	1.77	1.77	1.77	1.77	6.30		13.40 (3.50 - 15.60)	3.37 (0.77 - 4.89)	14.80 99
20+20+20+22+22	2.27	2.27	2.27	2.50	2.50		11.80 (3.40 - 15.00)	3.01 (0.79 - 5.25)	13.22 99
20+20+20+22+25	2.34	2.34	2.34	2.57	2.92		12.50 (3.50 - 15.10)	3.07 (0.78 - 4.85)	13.48 99
20+20+20+22+35	2.26	2.26	2.26	2.48	3.95		13.20 (3.50 - 15.40)	3.22 (0.77 - 4.69)	14.14 99

MXZ-6C120VA HEATING

Indoor units combination	Heating capacity (kW)						Outdoor unit power consumption (kW)	Current (A)	Power factor (%)	
	Unit A	Unit B	Unit C	Unit D	Unit E	Unit F				
20+20+20+22+42	2.16	2.16	2.16	2.38	4.54		13.40 (3.50 - 15.60)	3.39 (0.77 - 4.91)	14.89	99
20+20+20+22+50	2.03	2.03	2.03	2.23	5.08		13.40 (3.50 - 15.60)	3.38 (0.77 - 4.90)	14.84	99
20+20+20+22+60	1.89	1.89	1.89	2.08	5.66		13.40 (3.50 - 15.60)	3.38 (0.77 - 4.90)	14.84	99
20+20+20+22+71	1.75	1.75	1.75	1.93	6.22		13.40 (3.50 - 15.60)	3.37 (0.77 - 4.89)	14.80	99
20+20+20+25+25	2.38	2.38	2.38	2.98	2.98		13.10 (3.50 - 15.20)	3.13 (0.77 - 4.46)	13.75	99
20+20+20+25+35	2.22	2.22	2.22	2.77	3.88		13.30 (3.50 - 15.50)	3.30 (0.77 - 4.80)	14.49	99
20+20+20+25+42	2.11	2.11	2.11	2.64	4.43		13.40 (3.50 - 15.60)	3.39 (0.77 - 4.91)	14.89	99
20+20+20+25+50	1.99	1.99	1.99	2.48	4.96		13.40 (3.50 - 15.60)	3.38 (0.77 - 4.90)	14.84	99
20+20+20+25+60	1.85	1.85	1.85	2.31	5.54		13.40 (3.50 - 15.60)	3.37 (0.77 - 4.89)	14.80	99
20+20+20+25+71	1.72	1.72	1.72	2.15	6.10		13.40 (3.50 - 15.60)	3.37 (0.77 - 4.89)	14.80	99
20+20+20+35+35	2.06	2.06	2.06	3.61	3.61		13.40 (3.50 - 15.60)	3.39 (0.77 - 4.91)	14.89	99
20+20+20+35+42	1.96	1.96	1.96	3.42	4.11		13.40 (3.50 - 15.60)	3.38 (0.77 - 4.90)	14.84	99
20+20+20+35+50	1.85	1.85	1.85	3.23	4.62		13.40 (3.50 - 15.60)	3.37 (0.77 - 4.89)	14.80	99
20+20+20+35+60	1.73	1.73	1.73	3.03	5.19		13.40 (3.50 - 15.60)	3.37 (0.77 - 4.89)	14.80	99
20+20+20+35+71	1.61	1.61	1.61	2.83	5.73		13.40 (3.50 - 15.60)	3.36 (0.77 - 4.88)	14.76	99
20+20+20+42+42	1.86	1.86	1.86	3.91	3.91		13.40 (3.50 - 15.60)	3.37 (0.77 - 4.89)	14.80	99
20+20+20+42+50	1.76	1.76	1.76	3.70	4.41		13.40 (3.50 - 15.60)	3.37 (0.77 - 4.89)	14.80	99
20+20+20+42+60	1.65	1.65	1.65	3.47	4.96		13.40 (3.50 - 15.60)	3.36 (0.77 - 4.88)	14.76	99
20+20+20+42+71	1.55	1.55	1.55	3.25	5.50		13.40 (3.50 - 15.60)	3.35 (0.77 - 4.87)	14.71	99
20+20+20+50+50	1.68	1.68	1.68	4.19	4.19		13.40 (3.50 - 15.60)	3.36 (0.77 - 4.88)	14.76	99
20+20+20+50+60	1.58	1.58	1.58	3.94	4.73		13.40 (3.50 - 15.60)	3.35 (0.77 - 4.87)	14.71	99
20+20+20+60+60	1.49	1.49	1.49	4.47	4.47		13.40 (3.50 - 15.60)	3.35 (0.77 - 4.87)	14.71	99
20+20+22+22+22	2.32	2.32	2.55	2.55	2.55		12.30 (3.50 - 15.10)	3.05 (0.78 - 4.85)	13.39	99
20+20+22+22+25	2.37	2.37	2.60	2.60	2.96		12.90 (3.50 - 15.20)	3.11 (0.77 - 4.46)	13.66	99
20+20+22+22+35	2.24	2.24	2.46	2.46	3.91		13.30 (3.50 - 15.40)	3.30 (0.77 - 4.69)	14.49	99
20+20+22+22+42	2.13	2.13	2.34	2.34	4.47		13.40 (3.50 - 15.60)	3.39 (0.77 - 4.91)	14.89	99
20+20+22+22+50	2.00	2.00	2.20	2.20	5.00		13.40 (3.50 - 15.60)	3.38 (0.77 - 4.90)	14.84	99
20+20+22+22+60	1.86	1.86	2.05	2.05	5.58		13.40 (3.50 - 15.60)	3.37 (0.77 - 4.89)	14.80	99
20+20+22+22+71	1.73	1.73	1.90	1.90	6.14		13.40 (3.50 - 15.60)	3.37 (0.77 - 4.89)	14.80	99
20+20+22+25+25	2.34	2.34	2.57	2.92	2.92		13.10 (3.50 - 15.30)	3.13 (0.77 - 4.57)	13.75	99
20+20+22+25+35	2.18	2.18	2.40	2.73	3.82		13.30 (3.50 - 15.50)	3.30 (0.77 - 4.80)	14.49	99
20+20+22+25+42	2.08	2.08	2.29	2.60	4.36		13.40 (3.50 - 15.60)	3.39 (0.77 - 4.91)	14.89	99
20+20+22+25+50	1.96	1.96	2.15	2.45	4.89		13.40 (3.50 - 15.60)	3.38 (0.77 - 4.90)	14.84	99
20+20+22+25+60	1.82	1.82	2.01	2.28	5.47		13.40 (3.50 - 15.60)	3.37 (0.77 - 4.89)	14.80	99
20+20+22+25+71	1.70	1.70	1.87	2.12	6.02		13.40 (3.50 - 15.60)	3.36 (0.77 - 4.88)	14.76	99
20+20+22+35+35	2.03	2.03	2.23	3.55	3.55		13.40 (3.50 - 15.60)	3.38 (0.77 - 4.90)	14.84	99
20+20+22+35+42	1.93	1.93	2.12	3.37	4.05		13.40 (3.50 - 15.60)	3.38 (0.77 - 4.90)	14.84	99
20+20+22+35+50	1.82	1.82	2.01	3.19	4.56		13.40 (3.50 - 15.60)	3.37 (0.77 - 4.89)	14.80	99
20+20+22+35+60	1.71	1.71	1.88	2.99	5.12		13.40 (3.50 - 15.60)	3.36 (0.77 - 4.88)	14.76	99
20+20+22+35+71	1.60	1.60	1.75	2.79	5.66		13.40 (3.50 - 15.60)	3.36 (0.77 - 4.88)	14.76	99
20+20+22+42+42	1.84	1.84	2.02	3.85	3.85		13.40 (3.50 - 15.60)	3.37 (0.77 - 4.89)	14.80	99
20+20+22+42+50	1.74	1.74	1.91	3.65	4.35		13.40 (3.50 - 15.60)	3.37 (0.77 - 4.89)	14.80	99
20+20+22+42+60	1.63	1.63	1.80	3.43	4.90		13.40 (3.50 - 15.60)	3.36 (0.77 - 4.88)	14.76	99
20+20+22+42+71	1.53	1.53	1.68	3.22	5.44		13.40 (3.50 - 15.60)	3.35 (0.77 - 4.87)	14.71	99
20+20+22+50+50	1.65	1.65	1.82	4.14	4.14		13.40 (3.50 - 15.60)	3.36 (0.77 - 4.88)	14.76	99
20+20+22+50+60	1.56	1.56	1.71	3.90	4.67		13.40 (3.50 - 15.60)	3.35 (0.77 - 4.87)	14.71	99

MXZ-6C120VA HEATING

Indoor units combination	Heating capacity (kW)						Outdoor unit power consumption (kW)	Current (A)	Power factor (%)	
	Unit A	Unit B	Unit C	Unit D	Unit E	Unit F				
20+20+25+25+25	2.30	2.30	2.87	2.87	2.87		13.20 (3.50 - 15.30)	3.22 (0.77 - 4.57)	14.14	99
20+20+25+25+35	2.14	2.14	2.68	2.68	3.75		13.40 (3.50 - 15.60)	3.39 (0.77 - 4.91)	14.89	99
20+20+25+25+42	2.03	2.03	2.54	2.54	4.26		13.40 (3.50 - 15.60)	3.38 (0.77 - 4.90)	14.84	99
20+20+25+25+50	1.91	1.91	2.39	2.39	4.79		13.40 (3.50 - 15.60)	3.38 (0.77 - 4.90)	14.84	99
20+20+25+25+60	1.79	1.79	2.23	2.23	5.36		13.40 (3.50 - 15.60)	3.37 (0.77 - 4.89)	14.80	99
20+20+25+25+71	1.66	1.66	2.08	2.08	5.91		13.40 (3.50 - 15.60)	3.36 (0.77 - 4.88)	14.76	99
20+20+25+35+35	1.99	1.99	2.48	3.47	3.47		13.40 (3.50 - 15.60)	3.38 (0.77 - 4.90)	14.84	99
20+20+25+35+42	1.89	1.89	2.36	3.30	3.96		13.40 (3.50 - 15.60)	3.38 (0.77 - 4.90)	14.84	99
20+20+25+35+50	1.79	1.79	2.23	3.13	4.47		13.40 (3.50 - 15.60)	3.37 (0.77 - 4.89)	14.80	99
20+20+25+35+60	1.68	1.68	2.09	2.93	5.03		13.40 (3.50 - 15.60)	3.36 (0.77 - 4.88)	14.76	99
20+20+25+35+71	1.57	1.57	1.96	2.74	5.56		13.40 (3.50 - 15.60)	3.35 (0.77 - 4.87)	14.71	99
20+20+25+42+42	1.80	1.80	2.25	3.78	3.78		13.40 (3.50 - 15.60)	3.37 (0.77 - 4.89)	14.80	99
20+20+25+42+50	1.71	1.71	2.13	3.58	4.27		13.40 (3.50 - 15.60)	3.36 (0.77 - 4.88)	14.76	99
20+20+25+42+60	1.60	1.60	2.01	3.37	4.81		13.40 (3.50 - 15.60)	3.36 (0.77 - 4.88)	14.76	99
20+20+25+42+71	1.51	1.51	1.88	3.16	5.34		13.40 (3.50 - 15.60)	3.35 (0.77 - 4.87)	14.71	99
20+20+25+50+50	1.62	1.62	2.03	4.06	4.06		13.40 (3.50 - 15.60)	3.36 (0.77 - 4.88)	14.76	99
20+20+25+50+60	1.53	1.53	1.91	3.83	4.59		13.40 (3.50 - 15.60)	3.35 (0.77 - 4.87)	14.71	99
20+20+35+35+35	1.85	1.85	3.23	3.23	3.23		13.40 (3.50 - 15.60)	3.37 (0.77 - 4.89)	14.80	99
20+20+35+35+42	1.76	1.76	3.09	3.09	3.70		13.40 (3.50 - 15.60)	3.37 (0.77 - 4.89)	14.80	99
20+20+35+35+50	1.68	1.68	2.93	2.93	4.19		13.40 (3.50 - 15.60)	3.36 (0.77 - 4.88)	14.76	99
20+20+35+35+60	1.58	1.58	2.76	2.76	4.73		13.40 (3.50 - 15.60)	3.35 (0.77 - 4.87)	14.71	99
20+20+35+42+42	1.69	1.69	2.95	3.54	3.54		13.40 (3.50 - 15.60)	3.36 (0.77 - 4.88)	14.76	99
20+20+35+42+50	1.60	1.60	2.81	3.37	4.01		13.40 (3.50 - 15.60)	3.36 (0.77 - 4.88)	14.76	99
20+20+35+42+60	1.51	1.51	2.65	3.18	4.54		13.40 (3.50 - 15.60)	3.35 (0.77 - 4.87)	14.71	99
20+20+35+50+50	1.53	1.53	2.68	3.83	3.83		13.40 (3.50 - 15.60)	3.35 (0.77 - 4.87)	14.71	99
20+20+42+42+42	1.61	1.61	3.39	3.39	3.39		13.40 (3.50 - 15.60)	3.36 (0.77 - 4.88)	14.76	99
20+20+42+42+50	1.54	1.54	3.23	3.23	3.85		13.40 (3.50 - 15.60)	3.35 (0.77 - 4.87)	14.71	99
20+22+22+22+22	2.35	2.59	2.59	2.59	2.59		12.70 (3.50 - 15.10)	3.09 (0.78 - 4.85)	13.57	99
20+22+22+22+25	2.36	2.60	2.60	2.60	2.95		13.10 (3.50 - 15.20)	3.13 (0.77 - 4.46)	13.75	99
20+22+22+22+35	2.20	2.42	2.42	2.42	3.85		13.30 (3.50 - 15.50)	3.30 (0.77 - 4.80)	14.49	99
20+22+22+22+42	2.09	2.30	2.30	2.30	4.40		13.40 (3.50 - 15.60)	3.39 (0.77 - 4.91)	14.89	99
20+22+22+22+50	1.97	2.17	2.17	2.17	4.93		13.40 (3.50 - 15.60)	3.38 (0.77 - 4.90)	14.84	99
20+22+22+22+60	1.84	2.02	2.02	2.02	5.51		13.40 (3.50 - 15.60)	3.37 (0.77 - 4.89)	14.80	99
20+22+22+22+71	1.71	1.88	1.88	1.88	6.06		13.40 (3.50 - 15.60)	3.36 (0.77 - 4.88)	14.76	99
20+22+22+25+25	2.32	2.55	2.55	2.89	2.89		13.20 (3.50 - 15.30)	3.22 (0.77 - 4.57)	14.14	99
20+22+22+25+35	2.16	2.38	2.38	2.70	3.78		13.40 (3.50 - 15.60)	3.39 (0.77 - 4.91)	14.89	99
20+22+22+25+42	2.05	2.25	2.25	2.56	4.30		13.40 (3.50 - 15.60)	3.39 (0.77 - 4.91)	14.89	99
20+22+22+25+50	1.93	2.12	2.12	2.41	4.82		13.40 (3.50 - 15.60)	3.38 (0.77 - 4.90)	14.84	99
20+22+22+25+60	1.80	1.98	1.98	2.25	5.40		13.40 (3.50 - 15.60)	3.37 (0.77 - 4.89)	14.80	99
20+22+22+25+71	1.68	1.84	1.84	2.09	5.95		13.40 (3.50 - 15.60)	3.36 (0.77 - 4.88)	14.76	99
20+22+22+35+35	2.00	2.20	2.20	3.50	3.50		13.40 (3.50 - 15.60)	3.38 (0.77 - 4.90)	14.84	99
20+22+22+35+42	1.90	2.09	2.09	3.33	3.99		13.40 (3.50 - 15.60)	3.38 (0.77 - 4.90)	14.84	99
20+22+22+35+50	1.80	1.98	1.98	3.15	4.50		13.40 (3.50 - 15.60)	3.37 (0.77 - 4.89)	14.80	99
20+22+22+35+60	1.69	1.85	1.85	2.95	5.06		13.40 (3.50 - 15.60)	3.36 (0.77 - 4.88)	14.76	99
20+22+22+35+71	1.58	1.73	1.73	2.76	5.60		13.40 (3.50 - 15.60)	3.35 (0.77 - 4.87)	14.71	99
20+22+22+42+42	1.81	1.99	1.99	3.80	3.80		13.40 (3.50 - 15.60)	3.37 (0.77 - 4.89)	14.80	99

MXZ-6C120VA HEATING

Indoor units combination	Heating capacity (kW)						Outdoor unit power consumption (kW)	Current (A)	Power factor (%)
	Unit A	Unit B	Unit C	Unit D	Unit E	Unit F			
20+22+22+42+50	1.72	1.89	1.89	3.61	4.29		13.40 (3.50 - 15.60)	3.37 (0.77 - 4.89)	14.80 99
20+22+22+42+60	1.61	1.78	1.78	3.39	4.84		13.40 (3.50 - 15.60)	3.36 (0.77 - 4.88)	14.76 99
20+22+22+42+71	1.51	1.67	1.67	3.18	5.38		13.40 (3.50 - 15.60)	3.35 (0.77 - 4.87)	14.71 99
20+22+22+50+50	1.63	1.80	1.80	4.09	4.09		13.40 (3.50 - 15.60)	3.36 (0.77 - 4.88)	14.76 99
20+22+22+50+60	1.54	1.69	1.69	3.85	4.62		13.40 (3.50 - 15.60)	3.35 (0.77 - 4.87)	14.71 99
20+22+25+25+25	2.26	2.48	2.82	2.82	2.82		13.20 (3.50 - 15.40)	3.22 (0.77 - 4.69)	14.14 99
20+22+25+25+35	2.11	2.32	2.64	2.64	3.69		13.40 (3.50 - 15.60)	3.39 (0.77 - 4.91)	14.89 99
20+22+25+25+42	2.00	2.20	2.50	2.50	4.20		13.40 (3.50 - 15.60)	3.38 (0.77 - 4.90)	14.84 99
20+22+25+25+50	1.89	2.08	2.36	2.36	4.72		13.40 (3.50 - 15.60)	3.38 (0.77 - 4.90)	14.84 99
20+22+25+25+60	1.76	1.94	2.20	2.20	5.29		13.40 (3.50 - 15.60)	3.37 (0.77 - 4.89)	14.80 99
20+22+25+25+71	1.64	1.81	2.06	2.06	5.84		13.40 (3.50 - 15.60)	3.36 (0.77 - 4.88)	14.76 99
20+22+25+35+35	1.96	2.15	2.45	3.42	3.42		13.40 (3.50 - 15.60)	3.38 (0.77 - 4.90)	14.84 99
20+22+25+35+42	1.86	2.05	2.33	3.26	3.91		13.40 (3.50 - 15.60)	3.37 (0.77 - 4.89)	14.80 99
20+22+25+35+50	1.76	1.94	2.20	3.09	4.41		13.40 (3.50 - 15.60)	3.37 (0.77 - 4.89)	14.80 99
20+22+25+35+60	1.65	1.82	2.07	2.90	4.96		13.40 (3.50 - 15.60)	3.36 (0.77 - 4.88)	14.76 99
20+22+25+35+71	1.55	1.70	1.94	2.71	5.50		13.40 (3.50 - 15.60)	3.35 (0.77 - 4.87)	14.71 99
20+22+25+42+42	1.77	1.95	2.22	3.73	3.73		13.40 (3.50 - 15.60)	3.37 (0.77 - 4.89)	14.80 99
20+22+25+42+50	1.69	1.85	2.11	3.54	4.21		13.40 (3.50 - 15.60)	3.36 (0.77 - 4.88)	14.76 99
20+22+25+42+60	1.59	1.74	1.98	3.33	4.76		13.40 (3.50 - 15.60)	3.35 (0.77 - 4.87)	14.71 99
20+22+25+42+71	1.49	1.64	1.86	3.13	5.29		13.40 (3.50 - 15.60)	3.35 (0.77 - 4.87)	14.71 99
20+22+25+50+50	1.60	1.77	2.01	4.01	4.01		13.40 (3.50 - 15.60)	3.36 (0.77 - 4.88)	14.76 99
20+22+25+50+60	1.51	1.67	1.89	3.79	4.54		13.40 (3.50 - 15.60)	3.35 (0.77 - 4.87)	14.71 99
20+22+35+35+35	1.82	2.01	3.19	3.19	3.19		13.40 (3.50 - 15.60)	3.37 (0.77 - 4.89)	14.80 99
20+22+35+35+42	1.74	1.91	3.05	3.05	3.65		13.40 (3.50 - 15.60)	3.37 (0.77 - 4.89)	14.80 99
20+22+35+35+50	1.65	1.82	2.90	2.90	4.14		13.40 (3.50 - 15.60)	3.36 (0.77 - 4.88)	14.76 99
20+22+35+35+60	1.56	1.71	2.73	2.73	4.67		13.40 (3.50 - 15.60)	3.35 (0.77 - 4.87)	14.71 99
20+22+35+42+42	1.66	1.83	2.91	3.50	3.50		13.40 (3.50 - 15.60)	3.36 (0.77 - 4.88)	14.76 99
20+22+35+42+50	1.59	1.74	2.78	3.33	3.96		13.40 (3.50 - 15.60)	3.35 (0.77 - 4.87)	14.71 99
20+22+35+42+60	1.50	1.65	2.62	3.14	4.49		13.40 (3.50 - 15.60)	3.35 (0.77 - 4.87)	14.71 99
20+22+35+50+50	1.51	1.67	2.65	3.79	3.79		13.40 (3.50 - 15.60)	3.35 (0.77 - 4.87)	14.71 99
20+22+42+42+42	1.60	1.75	3.35	3.35	3.35		13.40 (3.50 - 15.60)	3.36 (0.77 - 4.88)	14.76 99
20+22+42+42+50	1.52	1.68	3.20	3.20	3.81		13.40 (3.50 - 15.60)	3.35 (0.77 - 4.87)	14.71 99
20+25+25+25+25	2.22	2.77	2.77	2.77	2.77		13.30 (3.50 - 15.50)	3.30 (0.77 - 4.80)	14.49 99
20+25+25+25+35	2.06	2.58	2.58	2.58	3.61		13.40 (3.50 - 15.60)	3.39 (0.77 - 4.91)	14.89 99
20+25+25+25+42	1.96	2.45	2.45	2.45	4.11		13.40 (3.50 - 15.60)	3.38 (0.77 - 4.90)	14.84 99
20+25+25+25+50	1.85	2.31	2.31	2.31	4.62		13.40 (3.50 - 15.60)	3.37 (0.77 - 4.89)	14.80 99
20+25+25+25+60	1.73	2.16	2.16	2.16	5.19		13.40 (3.50 - 15.60)	3.37 (0.77 - 4.89)	14.80 99
20+25+25+25+71	1.61	2.02	2.02	2.02	5.73		13.40 (3.50 - 15.60)	3.36 (0.77 - 4.88)	14.76 99
20+25+25+35+35	1.91	2.39	2.39	3.35	3.35		13.40 (3.50 - 15.60)	3.38 (0.77 - 4.90)	14.84 99
20+25+25+35+42	1.82	2.28	2.28	3.19	3.83		13.40 (3.50 - 15.60)	3.37 (0.77 - 4.89)	14.80 99
20+25+25+35+50	1.73	2.16	2.16	3.03	4.32		13.40 (3.50 - 15.60)	3.37 (0.77 - 4.89)	14.80 99
20+25+25+35+60	1.62	2.03	2.03	2.84	4.87		13.40 (3.50 - 15.60)	3.36 (0.77 - 4.88)	14.76 99
20+25+25+35+71	1.52	1.90	1.90	2.66	5.41		13.40 (3.50 - 15.60)	3.35 (0.77 - 4.87)	14.71 99
20+25+25+42+42	1.74	2.18	2.18	3.65	3.65		13.40 (3.50 - 15.60)	3.37 (0.77 - 4.89)	14.80 99
20+25+25+42+50	1.65	2.07	2.07	3.47	4.14		13.40 (3.50 - 15.60)	3.36 (0.77 - 4.88)	14.76 99
20+25+25+42+60	1.56	1.95	1.95	3.27	4.67		13.40 (3.50 - 15.60)	3.35 (0.77 - 4.87)	14.71 99

MXZ-6C120VA HEATING

Indoor units combination	Heating capacity (kW)						Outdoor unit power consumption (kW)	Current (A)	Power factor (%)
	Unit A	Unit B	Unit C	Unit D	Unit E	Unit F			
20+25+25+50+50	1.58	1.97	1.97	3.94	3.94		13.40 (3.50 - 15.60)	3.35 (0.77 - 4.87)	14.71 99
20+25+25+50+60	1.49	1.86	1.86	3.72	4.47		13.40 (3.50 - 15.60)	3.35 (0.77 - 4.87)	14.71 99
20+25+35+35+35	1.79	2.23	3.13	3.13	3.13		13.40 (3.50 - 15.60)	3.37 (0.77 - 4.89)	14.80 99
20+25+35+35+42	1.71	2.13	2.99	2.99	3.58		13.40 (3.50 - 15.60)	3.36 (0.77 - 4.88)	14.76 99
20+25+35+35+50	1.62	2.03	2.84	2.84	4.06		13.40 (3.50 - 15.60)	3.36 (0.77 - 4.88)	14.76 99
20+25+35+35+60	1.53	1.91	2.68	2.68	4.59		13.40 (3.50 - 15.60)	3.35 (0.77 - 4.87)	14.71 99
20+25+35+42+42	1.63	2.04	2.86	3.43	3.43		13.40 (3.50 - 15.60)	3.36 (0.77 - 4.88)	14.76 99
20+25+35+42+50	1.56	1.95	2.73	3.27	3.90		13.40 (3.50 - 15.60)	3.35 (0.77 - 4.87)	14.71 99
20+25+35+50+50	1.49	1.86	2.61	3.72	3.72		13.40 (3.50 - 15.60)	3.35 (0.77 - 4.87)	14.71 99
20+25+42+42+42	1.57	1.96	3.29	3.29	3.29		13.40 (3.50 - 15.60)	3.35 (0.77 - 4.87)	14.71 99
20+25+42+42+50	1.50	1.87	3.14	3.14	3.74		13.40 (3.50 - 15.60)	3.35 (0.77 - 4.87)	14.71 99
20+35+35+35+35	1.68	2.93	2.93	2.93	2.93		13.40 (3.50 - 15.60)	3.36 (0.77 - 4.88)	14.76 99
20+35+35+35+42	1.60	2.81	2.81	2.81	3.37		13.40 (3.50 - 15.60)	3.36 (0.77 - 4.88)	14.76 99
20+35+35+35+50	1.53	2.68	2.68	2.68	3.83		13.40 (3.50 - 15.60)	3.35 (0.77 - 4.87)	14.71 99
20+35+35+42+42	1.54	2.70	2.70	3.23	3.23		13.40 (3.50 - 15.60)	3.35 (0.77 - 4.87)	14.71 99
22+22+22+22+22	2.62	2.62	2.62	2.62	2.62		13.10 (3.50 - 15.20)	3.13 (0.77 - 4.46)	13.75 99
22+22+22+22+25	2.57	2.57	2.57	2.57	2.92		13.20 (3.50 - 15.30)	3.22 (0.77 - 4.57)	14.14 99
22+22+22+22+35	2.40	2.40	2.40	2.40	3.81		13.40 (3.50 - 15.50)	3.39 (0.77 - 4.80)	14.89 99
22+22+22+22+42	2.27	2.27	2.27	2.27	4.33		13.40 (3.50 - 15.60)	3.39 (0.77 - 4.91)	14.89 99
22+22+22+22+50	2.14	2.14	2.14	2.14	4.86		13.40 (3.50 - 15.60)	3.38 (0.77 - 4.90)	14.84 99
22+22+22+22+60	1.99	1.99	1.99	1.99	5.43		13.40 (3.50 - 15.60)	3.37 (0.77 - 4.89)	14.80 99
22+22+22+22+71	1.85	1.85	1.85	1.85	5.98		13.40 (3.50 - 15.60)	3.36 (0.77 - 4.88)	14.76 99
22+22+22+25+25	2.50	2.50	2.50	2.84	2.84		13.20 (3.50 - 15.40)	3.22 (0.77 - 4.69)	14.14 99
22+22+22+25+35	2.34	2.34	2.34	2.66	3.72		13.40 (3.50 - 15.60)	3.39 (0.77 - 4.91)	14.89 99
22+22+22+25+42	2.22	2.22	2.22	2.52	4.23		13.40 (3.50 - 15.60)	3.38 (0.77 - 4.90)	14.84 99
22+22+22+25+50	2.09	2.09	2.09	2.38	4.75		13.40 (3.50 - 15.60)	3.38 (0.77 - 4.90)	14.84 99
22+22+22+25+60	1.95	1.95	1.95	2.22	5.32		13.40 (3.50 - 15.60)	3.37 (0.77 - 4.89)	14.80 99
22+22+22+25+71	1.82	1.82	1.82	2.07	5.87		13.40 (3.50 - 15.60)	3.36 (0.77 - 4.88)	14.76 99
22+22+22+35+35	2.17	2.17	2.17	3.45	3.45		13.40 (3.50 - 15.60)	3.38 (0.77 - 4.90)	14.84 99
22+22+22+35+42	2.06	2.06	2.06	3.28	3.94		13.40 (3.50 - 15.60)	3.38 (0.77 - 4.90)	14.84 99
22+22+22+35+50	1.95	1.95	1.95	3.11	4.44		13.40 (3.50 - 15.60)	3.37 (0.77 - 4.89)	14.80 99
22+22+22+35+60	1.83	1.83	1.83	2.91	4.99		13.40 (3.50 - 15.60)	3.36 (0.77 - 4.88)	14.76 99
22+22+22+35+71	1.71	1.71	1.71	2.73	5.53		13.40 (3.50 - 15.60)	3.35 (0.77 - 4.87)	14.71 99
22+22+22+42+42	1.97	1.97	1.97	3.75	3.75		13.40 (3.50 - 15.60)	3.37 (0.77 - 4.89)	14.80 99
22+22+22+42+50	1.87	1.87	1.87	3.56	4.24		13.40 (3.50 - 15.60)	3.36 (0.77 - 4.88)	14.76 99
22+22+22+42+60	1.75	1.75	1.75	3.35	4.79		13.40 (3.50 - 15.60)	3.36 (0.77 - 4.88)	14.76 99
22+22+22+42+71	1.65	1.65	1.65	3.14	5.32		13.40 (3.50 - 15.60)	3.35 (0.77 - 4.87)	14.71 99
22+22+22+50+50	1.78	1.78	1.78	4.04	4.04		13.40 (3.50 - 15.60)	3.36 (0.77 - 4.88)	14.76 99
22+22+22+50+60	1.68	1.68	1.68	3.81	4.57		13.40 (3.50 - 15.60)	3.35 (0.77 - 4.87)	14.71 99
22+22+25+25+25	2.46	2.46	2.79	2.79	2.79		13.30 (3.50 - 15.40)	3.30 (0.77 - 4.69)	14.49 99
22+22+25+25+35	2.29	2.29	2.60	2.60	3.64		13.40 (3.50 - 15.60)	3.39 (0.77 - 4.91)	14.89 99
22+22+25+25+42	2.17	2.17	2.46	2.46	4.14		13.40 (3.50 - 15.60)	3.38 (0.77 - 4.90)	14.84 99
22+22+25+25+50	2.05	2.05	2.33	2.33	4.65		13.40 (3.50 - 15.60)	3.37 (0.77 - 4.89)	14.80 99
22+22+25+25+60	1.91	1.91	2.18	2.18	5.22		13.40 (3.50 - 15.60)	3.37 (0.77 - 4.89)	14.80 99
22+22+25+25+71	1.79	1.79	2.03	2.03	5.77		13.40 (3.50 - 15.60)	3.36 (0.77 - 4.88)	14.76 99
22+22+25+35+35	2.12	2.12	2.41	3.37	3.37		13.40 (3.50 - 15.60)	3.38 (0.77 - 4.90)	14.84 99

MXZ-6C120VA HEATING

Indoor units combination	Heating capacity (kW)						Outdoor unit power consumption (kW)	Current (A)	Power factor (%)
	Unit A	Unit B	Unit C	Unit D	Unit E	Unit F			
22+22+25+35+42	2.02	2.02	2.29	3.21	3.85		13.40 (3.50 - 15.60)	3.37 (0.77 - 4.89)	14.80 99
22+22+25+35+50	1.91	1.91	2.18	3.05	4.35		13.40 (3.50 - 15.60)	3.37 (0.77 - 4.89)	14.80 99
22+22+25+35+60	1.80	1.80	2.04	2.86	4.90		13.40 (3.50 - 15.60)	3.36 (0.77 - 4.88)	14.76 99
22+22+25+35+71	1.68	1.68	1.91	2.68	5.44		13.40 (3.50 - 15.60)	3.35 (0.77 - 4.87)	14.71 99
22+22+25+42+42	1.93	1.93	2.19	3.68	3.68		13.40 (3.50 - 15.60)	3.37 (0.77 - 4.89)	14.80 99
22+22+25+42+50	1.83	1.83	2.08	3.50	4.16		13.40 (3.50 - 15.60)	3.36 (0.77 - 4.88)	14.76 99
22+22+25+42+60	1.72	1.72	1.96	3.29	4.70		13.40 (3.50 - 15.60)	3.35 (0.77 - 4.87)	14.71 99
22+22+25+50+50	1.74	1.74	1.98	3.96	3.96		13.40 (3.50 - 15.60)	3.35 (0.77 - 4.87)	14.71 99
22+22+25+50+60	1.65	1.65	1.87	3.74	4.49		13.40 (3.50 - 15.60)	3.35 (0.77 - 4.87)	14.71 99
22+22+35+35+35	1.98	1.98	3.15	3.15	3.15		13.40 (3.50 - 15.60)	3.37 (0.77 - 4.89)	14.80 99
22+22+35+35+42	1.89	1.89	3.01	3.01	3.61		13.40 (3.50 - 15.60)	3.37 (0.77 - 4.89)	14.80 99
22+22+35+35+50	1.80	1.80	2.86	2.86	4.09		13.40 (3.50 - 15.60)	3.36 (0.77 - 4.88)	14.76 99
22+22+35+35+60	1.69	1.69	2.70	2.70	4.62		13.40 (3.50 - 15.60)	3.35 (0.77 - 4.87)	14.71 99
22+22+35+42+42	1.81	1.81	2.88	3.45	3.45		13.40 (3.50 - 15.60)	3.36 (0.77 - 4.88)	14.76 99
22+22+35+42+50	1.72	1.72	2.74	3.29	3.92		13.40 (3.50 - 15.60)	3.35 (0.77 - 4.87)	14.71 99
22+22+35+50+50	1.65	1.65	2.62	3.74	3.74		13.40 (3.50 - 15.60)	3.35 (0.77 - 4.87)	14.71 99
22+22+42+42+42	1.73	1.73	3.31	3.31	3.31		13.40 (3.50 - 15.60)	3.35 (0.77 - 4.87)	14.71 99
22+22+42+42+50	1.66	1.66	3.16	3.16	3.76		13.40 (3.50 - 15.60)	3.35 (0.77 - 4.87)	14.71 99
22+25+25+25+25	2.40	2.73	2.73	2.73	2.73		13.30 (3.50 - 15.50)	3.30 (0.77 - 4.80)	14.49 99
22+25+25+25+35	2.23	2.54	2.54	2.54	3.55		13.40 (3.50 - 15.60)	3.38 (0.77 - 4.90)	14.84 99
22+25+25+25+42	2.12	2.41	2.41	2.41	4.05		13.40 (3.50 - 15.60)	3.38 (0.77 - 4.90)	14.84 99
22+25+25+25+50	2.01	2.28	2.28	2.28	4.56		13.40 (3.50 - 15.60)	3.37 (0.77 - 4.89)	14.80 99
22+25+25+25+60	1.88	2.13	2.13	2.13	5.12		13.40 (3.50 - 15.60)	3.36 (0.77 - 4.88)	14.76 99
22+25+25+25+71	1.75	1.99	1.99	1.99	5.66		13.40 (3.50 - 15.60)	3.36 (0.77 - 4.88)	14.76 99
22+25+25+35+35	2.08	2.36	2.36	3.30	3.30		13.40 (3.50 - 15.60)	3.38 (0.77 - 4.90)	14.84 99
22+25+25+35+42	1.98	2.25	2.25	3.15	3.78		13.40 (3.50 - 15.60)	3.37 (0.77 - 4.89)	14.80 99
22+25+25+35+50	1.88	2.13	2.13	2.99	4.27		13.40 (3.50 - 15.60)	3.36 (0.77 - 4.88)	14.76 99
22+25+25+35+60	1.77	2.01	2.01	2.81	4.81		13.40 (3.50 - 15.60)	3.36 (0.77 - 4.88)	14.76 99
22+25+25+35+71	1.66	1.88	1.88	2.63	5.34		13.40 (3.50 - 15.60)	3.35 (0.77 - 4.87)	14.71 99
22+25+25+42+42	1.89	2.15	2.15	3.61	3.61		13.40 (3.50 - 15.60)	3.37 (0.77 - 4.89)	14.80 99
22+25+25+42+50	1.80	2.04	2.04	3.43	4.09		13.40 (3.50 - 15.60)	3.36 (0.77 - 4.88)	14.76 99
22+25+25+42+60	1.69	1.93	1.93	3.23	4.62		13.40 (3.50 - 15.60)	3.35 (0.77 - 4.87)	14.71 99
22+25+25+50+50	1.71	1.95	1.95	3.90	3.90		13.40 (3.50 - 15.60)	3.35 (0.77 - 4.87)	14.71 99
22+25+35+35+35	1.94	2.20	3.09	3.09	3.09		13.40 (3.50 - 15.60)	3.37 (0.77 - 4.89)	14.80 99
22+25+35+35+42	1.85	2.11	2.95	2.95	3.54		13.40 (3.50 - 15.60)	3.36 (0.77 - 4.88)	14.76 99
22+25+35+35+50	1.77	2.01	2.81	2.81	4.01		13.40 (3.50 - 15.60)	3.36 (0.77 - 4.88)	14.76 99
22+25+35+35+60	1.67	1.89	2.65	2.65	4.54		13.40 (3.50 - 15.60)	3.35 (0.77 - 4.87)	14.71 99
22+25+35+42+42	1.78	2.02	2.83	3.39	3.39		13.40 (3.50 - 15.60)	3.36 (0.77 - 4.88)	14.76 99
22+25+35+42+50	1.69	1.93	2.70	3.23	3.85		13.40 (3.50 - 15.60)	3.35 (0.77 - 4.87)	14.71 99
22+25+42+42+42	1.70	1.94	3.25	3.25	3.25		13.40 (3.50 - 15.60)	3.35 (0.77 - 4.87)	14.71 99
22+35+35+35+35	1.82	2.90	2.90	2.90	2.90		13.40 (3.50 - 15.60)	3.36 (0.77 - 4.88)	14.76 99
22+35+35+35+42	1.74	2.78	2.78	2.78	3.33		13.40 (3.50 - 15.60)	3.35 (0.77 - 4.87)	14.71 99
22+35+35+35+50	1.67	2.65	2.65	2.65	3.79		13.40 (3.50 - 15.60)	3.35 (0.77 - 4.87)	14.71 99
22+35+35+42+42	1.68	2.66	2.66	3.20	3.20		13.40 (3.50 - 15.60)	3.35 (0.77 - 4.87)	14.71 99
25+25+25+25+25	2.68	2.68	2.68	2.68	2.68		13.40 (3.50 - 15.60)	3.39 (0.77 - 4.91)	14.89 99
25+25+25+25+35	2.48	2.48	2.48	2.48	3.47		13.40 (3.50 - 15.60)	3.38 (0.77 - 4.90)	14.84 99

MXZ-6C120VA HEATING

Indoor units combination	Heating capacity (kW)						Outdoor unit power consumption (kW)	Current (A)	Power factor (%)	
	Unit A	Unit B	Unit C	Unit D	Unit E	Unit F				
25+25+25+25+42	2.36	2.36	2.36	2.36	3.96		13.40 (3.50 - 15.60)	3.38 (0.77 - 4.90)	14.84	99
25+25+25+25+50	2.23	2.23	2.23	2.23	4.47		13.40 (3.50 - 15.60)	3.37 (0.77 - 4.89)	14.80	99
25+25+25+25+60	2.09	2.09	2.09	2.09	5.03		13.40 (3.50 - 15.60)	3.36 (0.77 - 4.88)	14.76	99
25+25+25+25+71	1.96	1.96	1.96	1.96	5.56		13.40 (3.50 - 15.60)	3.35 (0.77 - 4.87)	14.71	99
25+25+25+35+35	2.31	2.31	2.31	3.23	3.23		13.40 (3.50 - 15.60)	3.37 (0.77 - 4.89)	14.80	99
25+25+25+35+42	2.20	2.20	2.20	3.09	3.70		13.40 (3.50 - 15.60)	3.37 (0.77 - 4.89)	14.80	99
25+25+25+35+50	2.09	2.09	2.09	2.93	4.19		13.40 (3.50 - 15.60)	3.36 (0.77 - 4.88)	14.76	99
25+25+25+35+60	1.97	1.97	1.97	2.76	4.73		13.40 (3.50 - 15.60)	3.35 (0.77 - 4.87)	14.71	99
25+25+25+42+42	2.11	2.11	2.11	3.54	3.54		13.40 (3.50 - 15.60)	3.36 (0.77 - 4.88)	14.76	99
25+25+25+42+50	2.01	2.01	2.01	3.37	4.01		13.40 (3.50 - 15.60)	3.36 (0.77 - 4.88)	14.76	99
25+25+25+42+60	1.89	1.89	1.89	3.18	4.54		13.40 (3.50 - 15.60)	3.35 (0.77 - 4.87)	14.71	99
25+25+25+50+50	1.91	1.91	1.91	3.83	3.83		13.40 (3.50 - 15.60)	3.35 (0.77 - 4.87)	14.71	99
25+25+35+35+35	2.16	2.16	3.03	3.03	3.03		13.40 (3.50 - 15.60)	3.37 (0.77 - 4.89)	14.80	99
25+25+35+35+42	2.07	2.07	2.90	2.90	3.47		13.40 (3.50 - 15.60)	3.36 (0.77 - 4.88)	14.76	99
25+25+35+35+50	1.97	1.97	2.76	2.76	3.94		13.40 (3.50 - 15.60)	3.35 (0.77 - 4.87)	14.71	99
25+25+35+35+60	1.86	1.86	2.61	2.61	4.47		13.40 (3.50 - 15.60)	3.35 (0.77 - 4.87)	14.71	99
25+25+35+42+42	1.98	1.98	2.78	3.33	3.33		13.40 (3.50 - 15.60)	3.35 (0.77 - 4.87)	14.71	99
25+25+35+42+50	1.89	1.89	2.65	3.18	3.79		13.40 (3.50 - 15.60)	3.35 (0.77 - 4.87)	14.71	99
25+25+42+42+42	1.90	1.90	3.20	3.20	3.20		13.40 (3.50 - 15.60)	3.35 (0.77 - 4.87)	14.71	99
25+35+35+35+35	2.03	2.84	2.84	2.84	2.84		13.40 (3.50 - 15.60)	3.36 (0.77 - 4.88)	14.76	99
25+35+35+35+42	1.95	2.73	2.73	2.73	3.27		13.40 (3.50 - 15.60)	3.35 (0.77 - 4.87)	14.71	99
25+35+35+35+50	1.86	2.61	2.61	2.61	3.72		13.40 (3.50 - 15.60)	3.35 (0.77 - 4.87)	14.71	99
25+35+35+42+42	1.87	2.62	2.62	3.14	3.14		13.40 (3.50 - 15.60)	3.35 (0.77 - 4.87)	14.71	99
35+35+35+35+35	2.68	2.68	2.68	2.68	2.68		13.40 (3.50 - 15.60)	3.35 (0.77 - 4.87)	14.71	99
15+15+15+15+15+15	1.70	1.70	1.70	1.70	1.70	1.70	10.20 (3.40 - 15.90)	2.37 (0.79 - 6.02)	10.41	99
15+15+15+15+15+20	1.69	1.69	1.69	1.69	1.69	2.25	10.70 (3.40 - 15.90)	2.61 (0.79 - 6.02)	11.46	99
15+15+15+15+15+22	1.69	1.69	1.69	1.69	1.69	2.47	10.90 (3.40 - 15.90)	2.71 (0.79 - 6.02)	11.90	99
15+15+15+15+15+25	1.68	1.68	1.68	1.68	1.68	2.80	11.20 (3.40 - 15.90)	2.85 (0.79 - 6.02)	12.52	99
15+15+15+15+15+35	1.66	1.66	1.66	1.66	1.66	3.88	12.20 (3.40 - 16.00)	3.34 (0.79 - 6.01)	14.67	99
15+15+15+15+15+42	1.65	1.65	1.65	1.65	1.65	4.63	12.90 (3.40 - 16.00)	3.68 (0.79 - 6.01)	16.16	99
15+15+15+15+15+50	1.62	1.62	1.62	1.62	1.62	5.40	13.50 (3.40 - 16.20)	3.71 (0.78 - 5.69)	16.29	99
15+15+15+15+15+60	1.56	1.56	1.56	1.56	1.56	6.22	14.00 (3.50 - 16.50)	3.51 (0.76 - 5.19)	15.42	99
15+15+15+15+15+71	1.44	1.44	1.44	1.44	1.44	6.81	14.00 (3.50 - 16.50)	3.48 (0.76 - 5.16)	15.28	99
15+15+15+15+20+20	1.68	1.68	1.68	1.68	2.24	2.24	11.20 (3.40 - 15.90)	2.85 (0.79 - 6.02)	12.52	99
15+15+15+15+20+22	1.68	1.68	1.68	1.68	2.24	2.46	11.40 (3.40 - 15.90)	2.95 (0.79 - 6.02)	12.96	99
15+15+15+15+20+25	1.67	1.67	1.67	1.67	2.23	2.79	11.70 (3.40 - 16.00)	3.10 (0.79 - 6.01)	13.61	99
15+15+15+15+20+35	1.66	1.66	1.66	1.66	2.21	3.87	12.70 (3.40 - 16.00)	3.58 (0.79 - 6.01)	15.72	99
15+15+15+15+20+42	1.64	1.64	1.64	1.64	2.18	4.58	13.30 (3.40 - 16.10)	3.78 (0.79 - 5.85)	16.60	99
15+15+15+15+20+50	1.60	1.60	1.60	1.60	2.14	5.35	13.90 (3.50 - 16.40)	3.56 (0.77 - 5.36)	15.63	99
15+15+15+15+20+60	1.50	1.50	1.50	1.50	2.00	6.00	14.00 (3.50 - 16.50)	3.50 (0.76 - 5.18)	15.37	99
15+15+15+15+20+71	1.39	1.39	1.39	1.39	1.85	6.58	14.00 (3.50 - 16.50)	3.47 (0.76 - 5.15)	15.24	99
15+15+15+15+22+22	1.67	1.67	1.67	1.67	2.45	2.45	11.60 (3.40 - 15.90)	3.05 (0.79 - 6.02)	13.39	99
15+15+15+15+22+25	1.67	1.67	1.67	1.67	2.45	2.78	11.90 (3.40 - 16.00)	3.19 (0.79 - 6.01)	14.01	99
15+15+15+15+22+35	1.65	1.65	1.65	1.65	2.43	3.86	12.90 (3.40 - 16.00)	3.68 (0.79 - 6.01)	16.16	99
15+15+15+15+22+42	1.63	1.63	1.63	1.63	2.40	4.57	13.50 (3.40 - 16.20)	3.71 (0.78 - 5.69)	16.29	99
15+15+15+15+22+50	1.59	1.59	1.59	1.59	2.33	5.30	14.00 (3.50 - 16.50)	3.52 (0.76 - 5.20)	15.46	99

MXZ-6C120VA HEATING

Indoor units combination	Heating capacity (kW)						Outdoor unit power consumption (kW)	Current (A)	Power factor (%)	
	Unit A	Unit B	Unit C	Unit D	Unit E	Unit F				
15+15+15+15+22+60	1.48	1.48	1.48	1.48	2.17	5.92	14.00 (3.50 - 16.50)	3.49 (0.76 - 5.17)	15.33	99
15+15+15+15+22+71	1.37	1.37	1.37	1.37	2.01	6.50	14.00 (3.50 - 16.50)	3.47 (0.76 - 5.15)	15.24	99
15+15+15+15+25+25	1.66	1.66	1.66	1.66	2.77	2.77	12.20 (3.40 - 16.00)	3.34 (0.79 - 6.01)	14.67	99
15+15+15+15+25+35	1.65	1.65	1.65	1.65	2.75	3.85	13.20 (3.40 - 16.00)	3.82 (0.79 - 6.01)	16.78	99
15+15+15+15+25+42	1.62	1.62	1.62	1.62	2.70	4.53	13.70 (3.50 - 16.30)	3.63 (0.77 - 5.52)	15.94	99
15+15+15+15+25+50	1.56	1.56	1.56	1.56	2.59	5.19	14.00 (3.50 - 16.50)	3.51 (0.76 - 5.19)	15.42	99
15+15+15+15+25+60	1.45	1.45	1.45	1.45	2.41	5.79	14.00 (3.50 - 16.50)	3.48 (0.76 - 5.16)	15.28	99
15+15+15+15+25+71	1.35	1.35	1.35	1.35	2.24	6.37	14.00 (3.50 - 16.50)	3.47 (0.76 - 5.15)	15.24	99
15+15+15+15+35+35	1.60	1.60	1.60	1.60	3.74	3.74	13.90 (3.50 - 16.40)	3.56 (0.77 - 5.36)	15.63	99
15+15+15+15+35+42	1.53	1.53	1.53	1.53	3.58	4.29	14.00 (3.50 - 16.50)	3.51 (0.76 - 5.19)	15.42	99
15+15+15+15+35+50	1.45	1.45	1.45	1.45	3.38	4.83	14.00 (3.50 - 16.50)	3.48 (0.76 - 5.16)	15.28	99
15+15+15+15+35+60	1.35	1.35	1.35	1.35	3.16	5.42	14.00 (3.50 - 16.50)	3.47 (0.76 - 5.15)	15.24	99
15+15+15+15+35+71	1.27	1.27	1.27	1.27	2.95	5.99	14.00 (3.50 - 16.50)	3.47 (0.76 - 5.15)	15.24	99
15+15+15+15+42+42	1.46	1.46	1.46	1.46	4.08	4.08	14.00 (3.50 - 16.50)	3.49 (0.76 - 5.17)	15.33	99
15+15+15+15+42+50	1.38	1.38	1.38	1.38	3.87	4.61	14.00 (3.50 - 16.50)	3.47 (0.76 - 5.15)	15.24	99
15+15+15+15+42+60	1.30	1.30	1.30	1.30	3.63	5.19	14.00 (3.50 - 16.50)	3.47 (0.76 - 5.15)	15.24	99
15+15+15+15+42+71	1.21	1.21	1.21	1.21	3.40	5.75	14.00 (3.50 - 16.50)	3.47 (0.76 - 5.15)	15.24	99
15+15+15+15+50+50	1.31	1.31	1.31	1.31	4.38	4.38	14.00 (3.50 - 16.50)	3.47 (0.76 - 5.15)	15.24	99
15+15+15+15+50+60	1.24	1.24	1.24	1.24	4.12	4.94	14.00 (3.50 - 16.50)	3.47 (0.76 - 5.15)	15.24	99
15+15+15+15+60+60	1.17	1.17	1.17	1.17	4.67	4.67	14.00 (3.50 - 16.50)	3.47 (0.76 - 5.15)	15.24	99
15+15+15+20+20+20	1.67	1.67	1.67	2.23	2.23	2.23	11.70 (3.40 - 16.00)	3.10 (0.79 - 6.01)	13.61	99
15+15+15+20+20+22	1.67	1.67	1.67	2.22	2.22	2.45	11.90 (3.40 - 16.00)	3.19 (0.79 - 6.01)	14.01	99
15+15+15+20+20+25	1.66	1.66	1.66	2.22	2.22	2.77	12.20 (3.40 - 16.00)	3.34 (0.79 - 6.01)	14.67	99
15+15+15+20+20+35	1.65	1.65	1.65	2.20	2.20	3.85	13.20 (3.40 - 16.00)	3.82 (0.79 - 6.01)	16.78	99
15+15+15+20+20+42	1.62	1.62	1.62	2.16	2.16	4.53	13.70 (3.50 - 16.30)	3.63 (0.77 - 5.52)	15.94	99
15+15+15+20+20+50	1.56	1.56	1.56	2.07	2.07	5.19	14.00 (3.50 - 16.50)	3.51 (0.76 - 5.19)	15.42	99
15+15+15+20+20+60	1.45	1.45	1.45	1.93	1.93	5.79	14.00 (3.50 - 16.50)	3.48 (0.76 - 5.16)	15.28	99
15+15+15+20+20+71	1.35	1.35	1.35	1.79	1.79	6.37	14.00 (3.50 - 16.50)	3.47 (0.76 - 5.15)	15.24	99
15+15+15+20+22+22	1.67	1.67	1.67	2.22	2.44	2.44	12.10 (3.40 - 16.00)	3.29 (0.79 - 6.01)	14.45	99
15+15+15+20+22+25	1.66	1.66	1.66	2.21	2.44	2.77	12.40 (3.40 - 16.00)	3.43 (0.79 - 6.01)	15.06	99
15+15+15+20+22+35	1.64	1.64	1.64	2.18	2.40	3.82	13.30 (3.40 - 16.10)	3.78 (0.79 - 5.85)	16.60	99
15+15+15+20+22+42	1.60	1.60	1.60	2.14	2.35	4.49	13.80 (3.50 - 16.40)	3.60 (0.77 - 5.36)	15.81	99
15+15+15+20+22+50	1.53	1.53	1.53	2.04	2.25	5.11	14.00 (3.50 - 16.50)	3.51 (0.76 - 5.19)	15.42	99
15+15+15+20+22+60	1.43	1.43	1.43	1.90	2.10	5.71	14.00 (3.50 - 16.50)	3.48 (0.76 - 5.16)	15.28	99
15+15+15+20+22+71	1.33	1.33	1.33	1.77	1.95	6.29	14.00 (3.50 - 16.50)	3.47 (0.76 - 5.15)	15.24	99
15+15+15+20+25+25	1.66	1.66	1.66	2.21	2.76	2.76	12.70 (3.40 - 16.00)	3.58 (0.79 - 6.01)	15.72	99
15+15+15+20+25+35	1.62	1.62	1.62	2.16	2.70	3.78	13.50 (3.40 - 16.20)	3.71 (0.78 - 5.69)	16.29	99
15+15+15+20+25+42	1.59	1.59	1.59	2.12	2.65	4.45	14.00 (3.50 - 16.50)	3.52 (0.76 - 5.20)	15.46	99
15+15+15+20+25+50	1.50	1.50	1.50	2.00	2.50	5.00	14.00 (3.50 - 16.50)	3.50 (0.76 - 5.18)	15.37	99
15+15+15+20+25+60	1.40	1.40	1.40	1.87	2.33	5.60	14.00 (3.50 - 16.50)	3.47 (0.76 - 5.15)	15.24	99
15+15+15+20+25+71	1.30	1.30	1.30	1.74	2.17	6.17	14.00 (3.50 - 16.50)	3.47 (0.76 - 5.15)	15.24	99
15+15+15+20+35+35	1.56	1.56	1.56	2.07	3.63	3.63	14.00 (3.50 - 16.50)	3.51 (0.76 - 5.19)	15.42	99
15+15+15+20+35+42	1.48	1.48	1.48	1.97	3.45	4.14	14.00 (3.50 - 16.50)	3.49 (0.76 - 5.17)	15.33	99
15+15+15+20+35+50	1.40	1.40	1.40	1.87	3.27	4.67	14.00 (3.50 - 16.50)	3.47 (0.76 - 5.15)	15.24	99
15+15+15+20+35+60	1.31	1.31	1.31	1.75	3.06	5.25	14.00 (3.50 - 16.50)	3.47 (0.76 - 5.15)	15.24	99
15+15+15+20+35+71	1.23	1.23	1.23	1.64	2.87	5.81	14.00 (3.50 - 16.50)	3.47 (0.76 - 5.15)	15.24	99

MXZ-6C120VA HEATING

Indoor units combination	Heating capacity (kW)						Outdoor unit power consumption (kW)	Current (A)	Power factor (%)
	Unit A	Unit B	Unit C	Unit D	Unit E	Unit F			
15+15+15+20+42+42	1.41	1.41	1.41	1.88	3.95	3.95	14.00 (3.50 - 16.50)	3.47 (0.76 - 5.15)	15.24 99
15+15+15+20+42+50	1.34	1.34	1.34	1.78	3.75	4.46	14.00 (3.50 - 16.50)	3.47 (0.76 - 5.15)	15.24 99
15+15+15+20+42+60	1.26	1.26	1.26	1.68	3.52	5.03	14.00 (3.50 - 16.50)	3.47 (0.76 - 5.15)	15.24 99
15+15+15+20+42+71	1.18	1.18	1.18	1.57	3.30	5.58	14.00 (3.50 - 16.50)	3.47 (0.76 - 5.15)	15.24 99
15+15+15+20+50+50	1.27	1.27	1.27	1.70	4.24	4.24	14.00 (3.50 - 16.50)	3.47 (0.76 - 5.15)	15.24 99
15+15+15+20+50+60	1.20	1.20	1.20	1.60	4.00	4.80	14.00 (3.50 - 16.50)	3.47 (0.76 - 5.15)	15.24 99
15+15+15+22+22+22	1.66	1.66	1.66	2.44	2.44	2.44	12.30 (3.40 - 16.00)	3.39 (0.79 - 6.01)	14.89 99
15+15+15+22+22+25	1.66	1.66	1.66	2.43	2.43	2.76	12.60 (3.40 - 16.00)	3.53 (0.79 - 6.01)	15.50 99
15+15+15+22+22+35	1.63	1.63	1.63	2.40	2.40	3.81	13.50 (3.40 - 16.20)	3.71 (0.78 - 5.69)	16.29 99
15+15+15+22+22+42	1.59	1.59	1.59	2.33	2.33	4.46	13.90 (3.50 - 16.50)	3.56 (0.76 - 5.20)	15.63 99
15+15+15+22+22+50	1.51	1.51	1.51	2.22	2.22	5.04	14.00 (3.50 - 16.50)	3.50 (0.76 - 5.18)	15.37 99
15+15+15+22+22+60	1.41	1.41	1.41	2.07	2.07	5.64	14.00 (3.50 - 16.50)	3.47 (0.76 - 5.15)	15.24 99
15+15+15+22+22+71	1.31	1.31	1.31	1.93	1.93	6.21	14.00 (3.50 - 16.50)	3.47 (0.76 - 5.15)	15.24 99
15+15+15+22+25+25	1.65	1.65	1.65	2.43	2.76	2.76	12.90 (3.40 - 16.00)	3.68 (0.79 - 6.01)	16.16 99
15+15+15+22+25+35	1.62	1.62	1.62	2.37	2.70	3.78	13.70 (3.50 - 16.30)	3.63 (0.77 - 5.52)	15.94 99
15+15+15+22+25+42	1.57	1.57	1.57	2.30	2.61	4.39	14.00 (3.50 - 16.50)	3.51 (0.76 - 5.19)	15.42 99
15+15+15+22+25+50	1.48	1.48	1.48	2.17	2.46	4.93	14.00 (3.50 - 16.50)	3.49 (0.76 - 5.17)	15.33 99
15+15+15+22+25+60	1.38	1.38	1.38	2.03	2.30	5.53	14.00 (3.50 - 16.50)	3.47 (0.76 - 5.15)	15.24 99
15+15+15+22+25+71	1.29	1.29	1.29	1.89	2.15	6.10	14.00 (3.50 - 16.50)	3.47 (0.76 - 5.15)	15.24 99
15+15+15+22+35+35	1.53	1.53	1.53	2.25	3.58	3.58	14.00 (3.50 - 16.50)	3.51 (0.76 - 5.19)	15.42 99
15+15+15+22+35+42	1.46	1.46	1.46	2.14	3.40	4.08	14.00 (3.50 - 16.50)	3.49 (0.76 - 5.17)	15.33 99
15+15+15+22+35+50	1.38	1.38	1.38	2.03	3.22	4.61	14.00 (3.50 - 16.50)	3.47 (0.76 - 5.15)	15.24 99
15+15+15+22+35+60	1.30	1.30	1.30	1.90	3.02	5.19	14.00 (3.50 - 16.50)	3.47 (0.76 - 5.15)	15.24 99
15+15+15+22+35+71	1.21	1.21	1.21	1.78	2.83	5.75	14.00 (3.50 - 16.50)	3.47 (0.76 - 5.15)	15.24 99
15+15+15+22+42+42	1.39	1.39	1.39	2.04	3.89	3.89	14.00 (3.50 - 16.50)	3.47 (0.76 - 5.15)	15.24 99
15+15+15+22+42+50	1.32	1.32	1.32	1.94	3.70	4.40	14.00 (3.50 - 16.50)	3.47 (0.76 - 5.15)	15.24 99
15+15+15+22+42+60	1.24	1.24	1.24	1.82	3.48	4.97	14.00 (3.50 - 16.50)	3.47 (0.76 - 5.15)	15.24 99
15+15+15+22+42+71	1.17	1.17	1.17	1.71	3.27	5.52	14.00 (3.50 - 16.50)	3.47 (0.76 - 5.15)	15.24 99
15+15+15+22+50+50	1.26	1.26	1.26	1.84	4.19	4.19	14.00 (3.50 - 16.50)	3.47 (0.76 - 5.15)	15.24 99
15+15+15+22+50+60	1.19	1.19	1.19	1.74	3.95	4.75	14.00 (3.50 - 16.50)	3.47 (0.76 - 5.15)	15.24 99
15+15+15+25+25+25	1.65	1.65	1.65	2.75	2.75	2.75	13.20 (3.40 - 16.00)	3.82 (0.79 - 6.01)	16.78 99
15+15+15+25+25+35	1.60	1.60	1.60	2.67	2.67	3.74	13.90 (3.50 - 16.40)	3.56 (0.77 - 5.36)	15.63 99
15+15+15+25+25+42	1.53	1.53	1.53	2.55	2.55	4.29	14.00 (3.50 - 16.50)	3.51 (0.76 - 5.19)	15.42 99
15+15+15+25+25+50	1.45	1.45	1.45	2.41	2.41	4.83	14.00 (3.50 - 16.50)	3.48 (0.76 - 5.16)	15.28 99
15+15+15+25+25+60	1.35	1.35	1.35	2.26	2.26	5.42	14.00 (3.50 - 16.50)	3.47 (0.76 - 5.15)	15.24 99
15+15+15+25+25+71	1.27	1.27	1.27	2.11	2.11	5.99	14.00 (3.50 - 16.50)	3.47 (0.76 - 5.15)	15.24 99
15+15+15+25+35+35	1.50	1.50	1.50	2.50	3.50	3.50	14.00 (3.50 - 16.50)	3.50 (0.76 - 5.18)	15.37 99
15+15+15+25+35+42	1.43	1.43	1.43	2.38	3.33	4.00	14.00 (3.50 - 16.50)	3.48 (0.76 - 5.16)	15.28 99
15+15+15+25+35+50	1.35	1.35	1.35	2.26	3.16	4.52	14.00 (3.50 - 16.50)	3.47 (0.76 - 5.15)	15.24 99
15+15+15+25+35+60	1.27	1.27	1.27	2.12	2.97	5.09	14.00 (3.50 - 16.50)	3.47 (0.76 - 5.15)	15.24 99
15+15+15+25+35+71	1.19	1.19	1.19	1.99	2.78	5.65	14.00 (3.50 - 16.50)	3.47 (0.76 - 5.15)	15.24 99
15+15+15+25+42+42	1.36	1.36	1.36	2.27	3.82	3.82	14.00 (3.50 - 16.50)	3.47 (0.76 - 5.15)	15.24 99
15+15+15+25+42+50	1.30	1.30	1.30	2.16	3.63	4.32	14.00 (3.50 - 16.50)	3.47 (0.76 - 5.15)	15.24 99
15+15+15+25+42+60	1.22	1.22	1.22	2.03	3.42	4.88	14.00 (3.50 - 16.50)	3.47 (0.76 - 5.15)	15.24 99
15+15+15+25+50+50	1.24	1.24	1.24	2.06	4.12	4.12	14.00 (3.50 - 16.50)	3.47 (0.76 - 5.15)	15.24 99
15+15+15+25+50+60	1.17	1.17	1.17	1.94	3.89	4.67	14.00 (3.50 - 16.50)	3.47 (0.76 - 5.15)	15.24 99

MXZ-6C120VA HEATING

Indoor units combination	Heating capacity (kW)						Outdoor unit power consumption (kW)	Current (A)	Power factor (%)
	Unit A	Unit B	Unit C	Unit D	Unit E	Unit F			
15+15+15+35+35+35	1.40	1.40	1.40	3.27	3.27	3.27	14.00 (3.50 - 16.50)	3.47 (0.76 - 5.15)	15.24 99
15+15+15+35+35+42	1.34	1.34	1.34	3.12	3.12	3.75	14.00 (3.50 - 16.50)	3.47 (0.76 - 5.15)	15.24 99
15+15+15+35+35+50	1.27	1.27	1.27	2.97	2.97	4.24	14.00 (3.50 - 16.50)	3.47 (0.76 - 5.15)	15.24 99
15+15+15+35+35+60	1.20	1.20	1.20	2.80	2.80	4.80	14.00 (3.50 - 16.50)	3.47 (0.76 - 5.15)	15.24 99
15+15+15+35+42+42	1.28	1.28	1.28	2.99	3.59	3.59	14.00 (3.50 - 16.50)	3.47 (0.76 - 5.15)	15.24 99
15+15+15+35+42+50	1.22	1.22	1.22	2.85	3.42	4.07	14.00 (3.50 - 16.50)	3.47 (0.76 - 5.15)	15.24 99
15+15+15+35+50+50	1.17	1.17	1.17	2.72	3.89	3.89	14.00 (3.50 - 16.50)	3.47 (0.76 - 5.15)	15.24 99
15+15+15+42+42+42	1.23	1.23	1.23	3.44	3.44	3.44	14.00 (3.50 - 16.50)	3.47 (0.76 - 5.15)	15.24 99
15+15+15+42+42+50	1.17	1.17	1.17	3.28	3.28	3.91	14.00 (3.50 - 16.50)	3.47 (0.76 - 5.15)	15.24 99
15+15+20+20+20+20	1.66	1.66	2.22	2.22	2.22	2.22	12.20 (3.40 - 16.00)	3.34 (0.79 - 6.01)	14.67 99
15+15+20+20+20+22	1.66	1.66	2.21	2.21	2.21	2.44	12.40 (3.40 - 16.00)	3.43 (0.79 - 6.01)	15.06 99
15+15+20+20+20+25	1.66	1.66	2.21	2.21	2.21	2.76	12.70 (3.40 - 16.00)	3.58 (0.79 - 6.01)	15.72 99
15+15+20+20+20+35	1.62	1.62	2.16	2.16	2.16	3.78	13.50 (3.40 - 16.20)	3.71 (0.78 - 5.69)	16.29 99
15+15+20+20+20+42	1.59	1.59	2.12	2.12	2.12	4.45	14.00 (3.50 - 16.50)	3.52 (0.76 - 5.20)	15.46 99
15+15+20+20+20+50	1.50	1.50	2.00	2.00	2.00	5.00	14.00 (3.50 - 16.50)	3.50 (0.76 - 5.18)	15.37 99
15+15+20+20+20+60	1.40	1.40	1.87	1.87	1.87	5.60	14.00 (3.50 - 16.50)	3.47 (0.76 - 5.15)	15.24 99
15+15+20+20+20+71	1.30	1.30	1.74	1.74	1.74	6.17	14.00 (3.50 - 16.50)	3.47 (0.76 - 5.15)	15.24 99
15+15+20+20+22+22	1.66	1.66	2.21	2.21	2.43	2.43	12.60 (3.40 - 16.00)	3.53 (0.79 - 6.01)	15.50 99
15+15+20+20+22+25	1.65	1.65	2.21	2.21	2.43	2.76	12.90 (3.40 - 16.00)	3.68 (0.79 - 6.01)	16.16 99
15+15+20+20+22+35	1.62	1.62	2.16	2.16	2.37	3.78	13.70 (3.50 - 16.30)	3.63 (0.77 - 5.52)	15.94 99
15+15+20+20+22+42	1.57	1.57	2.09	2.09	2.30	4.39	14.00 (3.50 - 16.50)	3.51 (0.76 - 5.19)	15.42 99
15+15+20+20+22+50	1.48	1.48	1.97	1.97	2.17	4.93	14.00 (3.50 - 16.50)	3.49 (0.76 - 5.17)	15.33 99
15+15+20+20+22+60	1.38	1.38	1.84	1.84	2.03	5.53	14.00 (3.50 - 16.50)	3.47 (0.76 - 5.15)	15.24 99
15+15+20+20+22+71	1.29	1.29	1.72	1.72	1.89	6.10	14.00 (3.50 - 16.50)	3.47 (0.76 - 5.15)	15.24 99
15+15+20+20+25+25	1.65	1.65	2.20	2.20	2.75	2.75	13.20 (3.40 - 16.00)	3.82 (0.79 - 6.01)	16.78 99
15+15+20+20+25+35	1.60	1.60	2.14	2.14	2.67	3.74	13.90 (3.50 - 16.40)	3.56 (0.77 - 5.36)	15.63 99
15+15+20+20+25+42	1.53	1.53	2.04	2.04	2.55	4.29	14.00 (3.50 - 16.50)	3.51 (0.76 - 5.19)	15.42 99
15+15+20+20+25+50	1.45	1.45	1.93	1.93	2.41	4.83	14.00 (3.50 - 16.50)	3.48 (0.76 - 5.16)	15.28 99
15+15+20+20+25+60	1.35	1.35	1.81	1.81	2.26	5.42	14.00 (3.50 - 16.50)	3.47 (0.76 - 5.15)	15.24 99
15+15+20+20+25+71	1.27	1.27	1.69	1.69	2.11	5.99	14.00 (3.50 - 16.50)	3.47 (0.76 - 5.15)	15.24 99
15+15+20+20+35+35	1.50	1.50	2.00	2.00	3.50	3.50	14.00 (3.50 - 16.50)	3.50 (0.76 - 5.18)	15.37 99
15+15+20+20+35+42	1.43	1.43	1.90	1.90	3.33	4.00	14.00 (3.50 - 16.50)	3.48 (0.76 - 5.16)	15.28 99
15+15+20+20+35+50	1.35	1.35	1.81	1.81	3.16	4.52	14.00 (3.50 - 16.50)	3.47 (0.76 - 5.15)	15.24 99
15+15+20+20+35+60	1.27	1.27	1.70	1.70	2.97	5.09	14.00 (3.50 - 16.50)	3.47 (0.76 - 5.15)	15.24 99
15+15+20+20+35+71	1.19	1.19	1.59	1.59	2.78	5.65	14.00 (3.50 - 16.50)	3.47 (0.76 - 5.15)	15.24 99
15+15+20+20+42+42	1.36	1.36	1.82	1.82	3.82	3.82	14.00 (3.50 - 16.50)	3.47 (0.76 - 5.15)	15.24 99
15+15+20+20+42+50	1.30	1.30	1.73	1.73	3.63	4.32	14.00 (3.50 - 16.50)	3.47 (0.76 - 5.15)	15.24 99
15+15+20+20+42+60	1.22	1.22	1.63	1.63	3.42	4.88	14.00 (3.50 - 16.50)	3.47 (0.76 - 5.15)	15.24 99
15+15+20+20+50+50	1.24	1.24	1.65	1.65	4.12	4.12	14.00 (3.50 - 16.50)	3.47 (0.76 - 5.15)	15.24 99
15+15+20+20+50+60	1.17	1.17	1.56	1.56	3.89	4.67	14.00 (3.50 - 16.50)	3.47 (0.76 - 5.15)	15.24 99
15+15+20+22+22+22	1.66	1.66	2.21	2.43	2.43	2.43	12.80 (3.40 - 16.00)	3.63 (0.79 - 6.01)	15.94 99
15+15+20+22+22+25	1.65	1.65	2.20	2.42	2.42	2.75	13.10 (3.40 - 16.00)	3.77 (0.79 - 6.01)	16.56 99
15+15+20+22+22+35	1.60	1.60	2.14	2.35	2.35	3.74	13.80 (3.50 - 16.40)	3.60 (0.77 - 5.36)	15.81 99
15+15+20+22+22+42	1.54	1.54	2.06	2.26	2.26	4.32	14.00 (3.50 - 16.50)	3.51 (0.76 - 5.19)	15.42 99
15+15+20+22+22+50	1.46	1.46	1.94	2.14	2.14	4.86	14.00 (3.50 - 16.50)	3.49 (0.76 - 5.17)	15.33 99
15+15+20+22+22+60	1.36	1.36	1.82	2.00	2.00	5.45	14.00 (3.50 - 16.50)	3.47 (0.76 - 5.15)	15.24 99

MXZ-6C120VA HEATING

Indoor units combination	Heating capacity (kW)						Outdoor unit power consumption (kW)	Current (A)	Power factor (%)
	Unit A	Unit B	Unit C	Unit D	Unit E	Unit F			
15+15+20+22+22+71	1.27	1.27	1.70	1.87	1.87	6.02	14.00 (3.50 - 16.50)	3.47 (0.76 - 5.15)	15.24 99
15+15+20+22+25+25	1.64	1.64	2.18	2.40	2.73	2.73	13.30 (3.40 - 16.10)	3.78 (0.79 - 5.85)	16.60 99
15+15+20+22+25+35	1.59	1.59	2.12	2.33	2.65	3.71	14.00 (3.50 - 16.50)	3.52 (0.76 - 5.20)	15.46 99
15+15+20+22+25+42	1.51	1.51	2.01	2.22	2.52	4.23	14.00 (3.50 - 16.50)	3.50 (0.76 - 5.18)	15.37 99
15+15+20+22+25+50	1.43	1.43	1.90	2.10	2.38	4.76	14.00 (3.50 - 16.50)	3.48 (0.76 - 5.16)	15.28 99
15+15+20+22+25+60	1.34	1.34	1.78	1.96	2.23	5.35	14.00 (3.50 - 16.50)	3.47 (0.76 - 5.15)	15.24 99
15+15+20+22+25+71	1.25	1.25	1.67	1.83	2.08	5.92	14.00 (3.50 - 16.50)	3.47 (0.76 - 5.15)	15.24 99
15+15+20+22+35+35	1.48	1.48	1.97	2.17	3.45	3.45	14.00 (3.50 - 16.50)	3.49 (0.76 - 5.17)	15.33 99
15+15+20+22+35+42	1.41	1.41	1.88	2.07	3.29	3.95	14.00 (3.50 - 16.50)	3.47 (0.76 - 5.15)	15.24 99
15+15+20+22+35+50	1.34	1.34	1.78	1.96	3.12	4.46	14.00 (3.50 - 16.50)	3.47 (0.76 - 5.15)	15.24 99
15+15+20+22+35+60	1.26	1.26	1.68	1.84	2.93	5.03	14.00 (3.50 - 16.50)	3.47 (0.76 - 5.15)	15.24 99
15+15+20+22+35+71	1.18	1.18	1.57	1.73	2.75	5.58	14.00 (3.50 - 16.50)	3.47 (0.76 - 5.15)	15.24 99
15+15+20+22+42+42	1.35	1.35	1.79	1.97	3.77	3.77	14.00 (3.50 - 16.50)	3.47 (0.76 - 5.15)	15.24 99
15+15+20+22+42+50	1.28	1.28	1.71	1.88	3.59	4.27	14.00 (3.50 - 16.50)	3.47 (0.76 - 5.15)	15.24 99
15+15+20+22+42+60	1.21	1.21	1.61	1.77	3.38	4.83	14.00 (3.50 - 16.50)	3.47 (0.76 - 5.15)	15.24 99
15+15+20+22+50+50	1.22	1.22	1.63	1.79	4.07	4.07	14.00 (3.50 - 16.50)	3.47 (0.76 - 5.15)	15.24 99
15+15+20+25+25+25	1.62	1.62	2.16	2.70	2.70	2.70	13.50 (3.40 - 16.20)	3.71 (0.78 - 5.69)	16.29 99
15+15+20+25+25+35	1.56	1.56	2.07	2.59	2.59	3.63	14.00 (3.50 - 16.50)	3.51 (0.76 - 5.19)	15.42 99
15+15+20+25+25+42	1.48	1.48	1.97	2.46	2.46	4.14	14.00 (3.50 - 16.50)	3.49 (0.76 - 5.17)	15.33 99
15+15+20+25+25+50	1.40	1.40	1.87	2.33	2.33	4.67	14.00 (3.50 - 16.50)	3.47 (0.76 - 5.15)	15.24 99
15+15+20+25+25+60	1.31	1.31	1.75	2.19	2.19	5.25	14.00 (3.50 - 16.50)	3.47 (0.76 - 5.15)	15.24 99
15+15+20+25+25+71	1.23	1.23	1.64	2.05	2.05	5.81	14.00 (3.50 - 16.50)	3.47 (0.76 - 5.15)	15.24 99
15+15+20+25+35+35	1.45	1.45	1.93	2.41	3.38	3.38	14.00 (3.50 - 16.50)	3.48 (0.76 - 5.16)	15.28 99
15+15+20+25+35+42	1.38	1.38	1.84	2.30	3.22	3.87	14.00 (3.50 - 16.50)	3.47 (0.76 - 5.15)	15.24 99
15+15+20+25+35+50	1.31	1.31	1.75	2.19	3.06	4.38	14.00 (3.50 - 16.50)	3.47 (0.76 - 5.15)	15.24 99
15+15+20+25+35+60	1.24	1.24	1.65	2.06	2.88	4.94	14.00 (3.50 - 16.50)	3.47 (0.76 - 5.15)	15.24 99
15+15+20+25+42+42	1.32	1.32	1.76	2.20	3.70	3.70	14.00 (3.50 - 16.50)	3.47 (0.76 - 5.15)	15.24 99
15+15+20+25+42+50	1.26	1.26	1.68	2.10	3.52	4.19	14.00 (3.50 - 16.50)	3.47 (0.76 - 5.15)	15.24 99
15+15+20+25+42+60	1.19	1.19	1.58	1.98	3.32	4.75	14.00 (3.50 - 16.50)	3.47 (0.76 - 5.15)	15.24 99
15+15+20+25+50+50	1.20	1.20	1.60	2.00	4.00	4.00	14.00 (3.50 - 16.50)	3.47 (0.76 - 5.15)	15.24 99
15+15+20+35+35+35	1.35	1.35	1.81	3.16	3.16	3.16	14.00 (3.50 - 16.50)	3.47 (0.76 - 5.15)	15.24 99
15+15+20+35+35+42	1.30	1.30	1.73	3.02	3.02	3.63	14.00 (3.50 - 16.50)	3.47 (0.76 - 5.15)	15.24 99
15+15+20+35+35+50	1.24	1.24	1.65	2.88	2.88	4.12	14.00 (3.50 - 16.50)	3.47 (0.76 - 5.15)	15.24 99
15+15+20+35+35+60	1.17	1.17	1.56	2.72	2.72	4.67	14.00 (3.50 - 16.50)	3.47 (0.76 - 5.15)	15.24 99
15+15+20+35+42+42	1.24	1.24	1.66	2.90	3.48	3.48	14.00 (3.50 - 16.50)	3.47 (0.76 - 5.15)	15.24 99
15+15+20+35+42+50	1.19	1.19	1.58	2.77	3.32	3.95	14.00 (3.50 - 16.50)	3.47 (0.76 - 5.15)	15.24 99
15+15+20+42+42+42	1.19	1.19	1.59	3.34	3.34	3.34	14.00 (3.50 - 16.50)	3.47 (0.76 - 5.15)	15.24 99
15+15+22+22+22+22	1.65	1.65	2.42	2.42	2.42	2.42	13.00 (3.40 - 16.00)	3.72 (0.79 - 6.01)	16.34 99
15+15+22+22+22+25	1.65	1.65	2.42	2.42	2.42	2.75	13.30 (3.40 - 16.00)	3.78 (0.79 - 6.01)	16.60 99
15+15+22+22+22+35	1.59	1.59	2.33	2.33	2.33	3.71	13.90 (3.50 - 16.50)	3.56 (0.76 - 5.20)	15.63 99
15+15+22+22+22+42	1.52	1.52	2.23	2.23	2.23	4.26	14.00 (3.50 - 16.50)	3.50 (0.76 - 5.18)	15.37 99
15+15+22+22+22+50	1.44	1.44	2.11	2.11	2.11	4.79	14.00 (3.50 - 16.50)	3.48 (0.76 - 5.16)	15.28 99
15+15+22+22+22+60	1.35	1.35	1.97	1.97	1.97	5.38	14.00 (3.50 - 16.50)	3.47 (0.76 - 5.15)	15.24 99
15+15+22+22+22+71	1.26	1.26	1.84	1.84	1.84	5.95	14.00 (3.50 - 16.50)	3.47 (0.76 - 5.15)	15.24 99
15+15+22+22+25+25	1.63	1.63	2.40	2.40	2.72	2.72	13.50 (3.40 - 16.20)	3.71 (0.78 - 5.69)	16.29 99
15+15+22+22+25+35	1.57	1.57	2.30	2.30	2.61	3.66	14.00 (3.50 - 16.50)	3.51 (0.76 - 5.19)	15.42 99

MXZ-6C120VA HEATING

Indoor units combination	Heating capacity (kW)						Outdoor unit power consumption (kW)	Current (A)	Power factor (%)	
	Unit A	Unit B	Unit C	Unit D	Unit E	Unit F				
15+15+22+22+25+42	1.49	1.49	2.18	2.18	2.48	4.17	14.00 (3.50 - 16.50)	3.50 (0.76 - 5.18)	15.37	99
15+15+22+22+25+50	1.41	1.41	2.07	2.07	2.35	4.70	14.00 (3.50 - 16.50)	3.47 (0.76 - 5.15)	15.24	99
15+15+22+22+25+60	1.32	1.32	1.94	1.94	2.20	5.28	14.00 (3.50 - 16.50)	3.47 (0.76 - 5.15)	15.24	99
15+15+22+22+25+71	1.24	1.24	1.81	1.81	2.06	5.85	14.00 (3.50 - 16.50)	3.47 (0.76 - 5.15)	15.24	99
15+15+22+22+35+35	1.46	1.46	2.14	2.14	3.40	3.40	14.00 (3.50 - 16.50)	3.49 (0.76 - 5.17)	15.33	99
15+15+22+22+35+42	1.39	1.39	2.04	2.04	3.25	3.89	14.00 (3.50 - 16.50)	3.47 (0.76 - 5.15)	15.24	99
15+15+22+22+35+50	1.32	1.32	1.94	1.94	3.08	4.40	14.00 (3.50 - 16.50)	3.47 (0.76 - 5.15)	15.24	99
15+15+22+22+35+60	1.24	1.24	1.82	1.82	2.90	4.97	14.00 (3.50 - 16.50)	3.47 (0.76 - 5.15)	15.24	99
15+15+22+22+35+71	1.17	1.17	1.71	1.71	2.72	5.52	14.00 (3.50 - 16.50)	3.47 (0.76 - 5.15)	15.24	99
15+15+22+22+42+42	1.33	1.33	1.95	1.95	3.72	3.72	14.00 (3.50 - 16.50)	3.47 (0.76 - 5.15)	15.24	99
15+15+22+22+42+50	1.27	1.27	1.86	1.86	3.54	4.22	14.00 (3.50 - 16.50)	3.47 (0.76 - 5.15)	15.24	99
15+15+22+22+42+60	1.19	1.19	1.75	1.75	3.34	4.77	14.00 (3.50 - 16.50)	3.47 (0.76 - 5.15)	15.24	99
15+15+22+22+50+50	1.21	1.21	1.77	1.77	4.02	4.02	14.00 (3.50 - 16.50)	3.47 (0.76 - 5.15)	15.24	99
15+15+22+25+25+25	1.62	1.62	2.37	2.70	2.70	2.70	13.70 (3.50 - 16.30)	3.63 (0.77 - 5.52)	15.94	99
15+15+22+25+25+35	1.53	1.53	2.25	2.55	2.55	3.58	14.00 (3.50 - 16.50)	3.51 (0.76 - 5.19)	15.42	99
15+15+22+25+25+42	1.46	1.46	2.14	2.43	2.43	4.08	14.00 (3.50 - 16.50)	3.49 (0.76 - 5.17)	15.33	99
15+15+22+25+25+50	1.38	1.38	2.03	2.30	2.30	4.61	14.00 (3.50 - 16.50)	3.47 (0.76 - 5.15)	15.24	99
15+15+22+25+25+60	1.30	1.30	1.90	2.16	2.16	5.19	14.00 (3.50 - 16.50)	3.47 (0.76 - 5.15)	15.24	99
15+15+22+25+25+71	1.21	1.21	1.78	2.02	2.02	5.75	14.00 (3.50 - 16.50)	3.47 (0.76 - 5.15)	15.24	99
15+15+22+25+35+35	1.43	1.43	2.10	2.38	3.33	3.33	14.00 (3.50 - 16.50)	3.48 (0.76 - 5.16)	15.28	99
15+15+22+25+35+42	1.36	1.36	2.00	2.27	3.18	3.82	14.00 (3.50 - 16.50)	3.47 (0.76 - 5.15)	15.24	99
15+15+22+25+35+50	1.30	1.30	1.90	2.16	3.02	4.32	14.00 (3.50 - 16.50)	3.47 (0.76 - 5.15)	15.24	99
15+15+22+25+35+60	1.22	1.22	1.79	2.03	2.85	4.88	14.00 (3.50 - 16.50)	3.47 (0.76 - 5.15)	15.24	99
15+15+22+25+42+42	1.30	1.30	1.91	2.17	3.65	3.65	14.00 (3.50 - 16.50)	3.47 (0.76 - 5.15)	15.24	99
15+15+22+25+42+50	1.24	1.24	1.82	2.07	3.48	4.14	14.00 (3.50 - 16.50)	3.47 (0.76 - 5.15)	15.24	99
15+15+22+25+42+60	1.17	1.17	1.72	1.96	3.28	4.69	14.00 (3.50 - 16.50)	3.47 (0.76 - 5.15)	15.24	99
15+15+22+25+50+50	1.19	1.19	1.74	1.98	3.95	3.95	14.00 (3.50 - 16.50)	3.47 (0.76 - 5.15)	15.24	99
15+15+22+35+35+35	1.34	1.34	1.96	3.12	3.12	3.12	14.00 (3.50 - 16.50)	3.47 (0.76 - 5.15)	15.24	99
15+15+22+35+35+42	1.28	1.28	1.88	2.99	2.99	3.59	14.00 (3.50 - 16.50)	3.47 (0.76 - 5.15)	15.24	99
15+15+22+35+35+50	1.22	1.22	1.79	2.85	2.85	4.07	14.00 (3.50 - 16.50)	3.47 (0.76 - 5.15)	15.24	99
15+15+22+35+42+42	1.23	1.23	1.80	2.87	3.44	3.44	14.00 (3.50 - 16.50)	3.47 (0.76 - 5.15)	15.24	99
15+15+22+35+42+50	1.17	1.17	1.72	2.74	3.28	3.91	14.00 (3.50 - 16.50)	3.47 (0.76 - 5.15)	15.24	99
15+15+22+42+42+42	1.18	1.18	1.73	3.30	3.30	3.30	14.00 (3.50 - 16.50)	3.47 (0.76 - 5.15)	15.24	99
15+15+25+25+25+25	1.60	1.60	2.67	2.67	2.67	2.67	13.90 (3.50 - 16.40)	3.56 (0.77 - 5.36)	15.63	99
15+15+25+25+25+35	1.50	1.50	2.50	2.50	2.50	3.50	14.00 (3.50 - 16.50)	3.50 (0.76 - 5.18)	15.37	99
15+15+25+25+25+42	1.43	1.43	2.38	2.38	2.38	4.00	14.00 (3.50 - 16.50)	3.48 (0.76 - 5.16)	15.28	99
15+15+25+25+25+50	1.35	1.35	2.26	2.26	2.26	4.52	14.00 (3.50 - 16.50)	3.47 (0.76 - 5.15)	15.24	99
15+15+25+25+25+60	1.27	1.27	2.12	2.12	2.12	5.09	14.00 (3.50 - 16.50)	3.47 (0.76 - 5.15)	15.24	99
15+15+25+25+25+71	1.19	1.19	1.99	1.99	1.99	5.65	14.00 (3.50 - 16.50)	3.47 (0.76 - 5.15)	15.24	99
15+15+25+25+35+35	1.40	1.40	2.33	2.33	3.27	3.27	14.00 (3.50 - 16.50)	3.47 (0.76 - 5.15)	15.24	99
15+15+25+25+35+42	1.34	1.34	2.23	2.23	3.12	3.75	14.00 (3.50 - 16.50)	3.47 (0.76 - 5.15)	15.24	99
15+15+25+25+35+50	1.27	1.27	2.12	2.12	2.97	4.24	14.00 (3.50 - 16.50)	3.47 (0.76 - 5.15)	15.24	99
15+15+25+25+35+60	1.20	1.20	2.00	2.00	2.80	4.80	14.00 (3.50 - 16.50)	3.47 (0.76 - 5.15)	15.24	99
15+15+25+25+42+42	1.28	1.28	2.13	2.13	3.59	3.59	14.00 (3.50 - 16.50)	3.47 (0.76 - 5.15)	15.24	99
15+15+25+25+42+50	1.22	1.22	2.03	2.03	3.42	4.07	14.00 (3.50 - 16.50)	3.47 (0.76 - 5.15)	15.24	99
15+15+25+25+50+50	1.17	1.17	1.94	1.94	3.89	3.89	14.00 (3.50 - 16.50)	3.47 (0.76 - 5.15)	15.24	99

MXZ-6C120VA HEATING

Indoor units combination	Heating capacity (kW)						Outdoor unit power consumption (kW)	Current (A)	Power factor (%)	
	Unit A	Unit B	Unit C	Unit D	Unit E	Unit F				
15+15+25+35+35+35	1.31	1.31	2.19	3.06	3.06	3.06	14.00 (3.50 - 16.50)	3.47 (0.76 - 5.15)	15.24	99
15+15+25+35+35+42	1.26	1.26	2.10	2.93	2.93	3.52	14.00 (3.50 - 16.50)	3.47 (0.76 - 5.15)	15.24	99
15+15+25+35+35+50	1.20	1.20	2.00	2.80	2.80	4.00	14.00 (3.50 - 16.50)	3.47 (0.76 - 5.15)	15.24	99
15+15+25+35+42+42	1.21	1.21	2.01	2.82	3.38	3.38	14.00 (3.50 - 16.50)	3.47 (0.76 - 5.15)	15.24	99
15+15+35+35+35+35	1.24	1.24	2.88	2.88	2.88	2.88	14.00 (3.50 - 16.50)	3.47 (0.76 - 5.15)	15.24	99
15+15+35+35+35+42	1.19	1.19	2.77	2.77	2.77	3.32	14.00 (3.50 - 16.50)	3.47 (0.76 - 5.15)	15.24	99
15+20+20+20+20+20	1.66	2.21	2.21	2.21	2.21	2.21	12.70 (3.40 - 16.00)	3.58 (0.79 - 6.01)	15.72	99
15+20+20+20+20+22	1.65	2.21	2.21	2.21	2.21	2.43	12.90 (3.40 - 16.00)	3.68 (0.79 - 6.01)	16.16	99
15+20+20+20+20+25	1.65	2.20	2.20	2.20	2.20	2.75	13.20 (3.40 - 16.00)	3.82 (0.79 - 6.01)	16.78	99
15+20+20+20+20+35	1.60	2.14	2.14	2.14	2.14	3.74	13.90 (3.50 - 16.40)	3.56 (0.77 - 5.36)	15.63	99
15+20+20+20+20+42	1.53	2.04	2.04	2.04	2.04	4.29	14.00 (3.50 - 16.50)	3.51 (0.76 - 5.19)	15.42	99
15+20+20+20+20+50	1.45	1.93	1.93	1.93	1.93	4.83	14.00 (3.50 - 16.50)	3.48 (0.76 - 5.16)	15.28	99
15+20+20+20+20+60	1.35	1.81	1.81	1.81	1.81	5.42	14.00 (3.50 - 16.50)	3.47 (0.76 - 5.15)	15.24	99
15+20+20+20+20+71	1.27	1.69	1.69	1.69	1.69	5.99	14.00 (3.50 - 16.50)	3.47 (0.76 - 5.15)	15.24	99
15+20+20+20+22+22	1.65	2.20	2.20	2.20	2.42	2.42	13.10 (3.40 - 16.00)	3.77 (0.79 - 6.01)	16.56	99
15+20+20+20+22+25	1.64	2.18	2.18	2.18	2.40	2.73	13.30 (3.40 - 16.10)	3.78 (0.79 - 5.85)	16.60	99
15+20+20+20+22+35	1.59	2.12	2.12	2.12	2.33	3.71	14.00 (3.50 - 16.50)	3.52 (0.76 - 5.20)	15.46	99
15+20+20+20+22+42	1.51	2.01	2.01	2.01	2.22	4.23	14.00 (3.50 - 16.50)	3.50 (0.76 - 5.18)	15.37	99
15+20+20+20+22+50	1.43	1.90	1.90	1.90	2.10	4.76	14.00 (3.50 - 16.50)	3.48 (0.76 - 5.16)	15.28	99
15+20+20+20+22+60	1.34	1.78	1.78	1.78	1.96	5.35	14.00 (3.50 - 16.50)	3.47 (0.76 - 5.15)	15.24	99
15+20+20+20+22+71	1.25	1.67	1.67	1.67	1.83	5.92	14.00 (3.50 - 16.50)	3.47 (0.76 - 5.15)	15.24	99
15+20+20+20+25+25	1.62	2.16	2.16	2.16	2.70	2.70	13.50 (3.40 - 16.20)	3.71 (0.78 - 5.69)	16.29	99
15+20+20+20+25+35	1.56	2.07	2.07	2.07	2.59	3.63	14.00 (3.50 - 16.50)	3.51 (0.76 - 5.19)	15.42	99
15+20+20+20+25+42	1.48	1.97	1.97	1.97	2.46	4.14	14.00 (3.50 - 16.50)	3.49 (0.76 - 5.17)	15.33	99
15+20+20+20+25+50	1.40	1.87	1.87	1.87	2.33	4.67	14.00 (3.50 - 16.50)	3.47 (0.76 - 5.15)	15.24	99
15+20+20+20+25+60	1.31	1.75	1.75	1.75	2.19	5.25	14.00 (3.50 - 16.50)	3.47 (0.76 - 5.15)	15.24	99
15+20+20+20+25+71	1.23	1.64	1.64	1.64	2.05	5.81	14.00 (3.50 - 16.50)	3.47 (0.76 - 5.15)	15.24	99
15+20+20+20+35+35	1.45	1.93	1.93	1.93	3.38	3.38	14.00 (3.50 - 16.50)	3.48 (0.76 - 5.16)	15.28	99
15+20+20+20+35+42	1.38	1.84	1.84	1.84	3.22	3.87	14.00 (3.50 - 16.50)	3.47 (0.76 - 5.15)	15.24	99
15+20+20+20+35+50	1.31	1.75	1.75	1.75	3.06	4.38	14.00 (3.50 - 16.50)	3.47 (0.76 - 5.15)	15.24	99
15+20+20+20+35+60	1.24	1.65	1.65	1.65	2.88	4.94	14.00 (3.50 - 16.50)	3.47 (0.76 - 5.15)	15.24	99
15+20+20+20+42+42	1.32	1.76	1.76	1.76	3.70	3.70	14.00 (3.50 - 16.50)	3.47 (0.76 - 5.15)	15.24	99
15+20+20+20+42+50	1.26	1.68	1.68	1.68	3.52	4.19	14.00 (3.50 - 16.50)	3.47 (0.76 - 5.15)	15.24	99
15+20+20+20+42+60	1.19	1.58	1.58	1.58	3.32	4.75	14.00 (3.50 - 16.50)	3.47 (0.76 - 5.15)	15.24	99
15+20+20+20+50+50	1.20	1.60	1.60	1.60	4.00	4.00	14.00 (3.50 - 16.50)	3.47 (0.76 - 5.15)	15.24	99
15+20+20+22+22+22	1.65	2.20	2.20	2.42	2.42	2.42	13.30 (3.40 - 16.00)	3.78 (0.79 - 6.01)	16.60	99
15+20+20+22+22+25	1.63	2.18	2.18	2.40	2.40	2.72	13.50 (3.40 - 16.20)	3.71 (0.78 - 5.69)	16.29	99
15+20+20+22+22+35	1.57	2.09	2.09	2.30	2.30	3.66	14.00 (3.50 - 16.50)	3.51 (0.76 - 5.19)	15.42	99
15+20+20+22+22+42	1.49	1.99	1.99	2.18	2.18	4.17	14.00 (3.50 - 16.50)	3.50 (0.76 - 5.18)	15.37	99
15+20+20+22+22+50	1.41	1.88	1.88	2.07	2.07	4.70	14.00 (3.50 - 16.50)	3.47 (0.76 - 5.15)	15.24	99
15+20+20+22+22+60	1.32	1.76	1.76	1.94	1.94	5.28	14.00 (3.50 - 16.50)	3.47 (0.76 - 5.15)	15.24	99
15+20+20+22+22+71	1.24	1.65	1.65	1.81	1.81	5.85	14.00 (3.50 - 16.50)	3.47 (0.76 - 5.15)	15.24	99
15+20+20+22+25+25	1.62	2.16	2.16	2.37	2.70	2.70	13.70 (3.50 - 16.30)	3.63 (0.77 - 5.52)	15.94	99
15+20+20+22+25+35	1.53	2.04	2.04	2.25	2.55	3.58	14.00 (3.50 - 16.50)	3.51 (0.76 - 5.19)	15.42	99
15+20+20+22+25+42	1.46	1.94	1.94	2.14	2.43	4.08	14.00 (3.50 - 16.50)	3.49 (0.76 - 5.17)	15.33	99
15+20+20+22+25+50	1.38	1.84	1.84	2.03	2.30	4.61	14.00 (3.50 - 16.50)	3.47 (0.76 - 5.15)	15.24	99

MXZ-6C120VA HEATING

Indoor units combination	Heating capacity (kW)						Outdoor unit power consumption (kW)	Current (A)	Power factor (%)
	Unit A	Unit B	Unit C	Unit D	Unit E	Unit F			
15+20+20+22+25+60	1.30	1.73	1.73	1.90	2.16	5.19	14.00 (3.50 - 16.50)	3.47 (0.76 - 5.15)	15.24 99
15+20+20+22+25+71	1.21	1.62	1.62	1.78	2.02	5.75	14.00 (3.50 - 16.50)	3.47 (0.76 - 5.15)	15.24 99
15+20+20+22+35+35	1.43	1.90	1.90	2.10	3.33	3.33	14.00 (3.50 - 16.50)	3.48 (0.76 - 5.16)	15.28 99
15+20+20+22+35+42	1.36	1.82	1.82	2.00	3.18	3.82	14.00 (3.50 - 16.50)	3.47 (0.76 - 5.15)	15.24 99
15+20+20+22+35+50	1.30	1.73	1.73	1.90	3.02	4.32	14.00 (3.50 - 16.50)	3.47 (0.76 - 5.15)	15.24 99
15+20+20+22+35+60	1.22	1.63	1.63	1.79	2.85	4.88	14.00 (3.50 - 16.50)	3.47 (0.76 - 5.15)	15.24 99
15+20+20+22+42+42	1.30	1.74	1.74	1.91	3.65	3.65	14.00 (3.50 - 16.50)	3.47 (0.76 - 5.15)	15.24 99
15+20+20+22+42+50	1.24	1.66	1.66	1.82	3.48	4.14	14.00 (3.50 - 16.50)	3.47 (0.76 - 5.15)	15.24 99
15+20+20+22+42+60	1.17	1.56	1.56	1.72	3.28	4.69	14.00 (3.50 - 16.50)	3.47 (0.76 - 5.15)	15.24 99
15+20+20+22+50+50	1.19	1.58	1.58	1.74	3.95	3.95	14.00 (3.50 - 16.50)	3.47 (0.76 - 5.15)	15.24 99
15+20+20+25+25+25	1.60	2.14	2.14	2.67	2.67	2.67	13.90 (3.50 - 16.40)	3.56 (0.77 - 5.36)	15.63 99
15+20+20+25+25+35	1.50	2.00	2.00	2.50	2.50	3.50	14.00 (3.50 - 16.50)	3.50 (0.76 - 5.18)	15.37 99
15+20+20+25+25+42	1.43	1.90	1.90	2.38	2.38	4.00	14.00 (3.50 - 16.50)	3.48 (0.76 - 5.16)	15.28 99
15+20+20+25+25+50	1.35	1.81	1.81	2.26	2.26	4.52	14.00 (3.50 - 16.50)	3.47 (0.76 - 5.15)	15.24 99
15+20+20+25+25+60	1.27	1.70	1.70	2.12	2.12	5.09	14.00 (3.50 - 16.50)	3.47 (0.76 - 5.15)	15.24 99
15+20+20+25+25+71	1.19	1.59	1.59	1.99	1.99	5.65	14.00 (3.50 - 16.50)	3.47 (0.76 - 5.15)	15.24 99
15+20+20+25+35+35	1.40	1.87	1.87	2.33	3.27	3.27	14.00 (3.50 - 16.50)	3.47 (0.76 - 5.15)	15.24 99
15+20+20+25+35+42	1.34	1.78	1.78	2.23	3.12	3.75	14.00 (3.50 - 16.50)	3.47 (0.76 - 5.15)	15.24 99
15+20+20+25+35+50	1.27	1.70	1.70	2.12	2.97	4.24	14.00 (3.50 - 16.50)	3.47 (0.76 - 5.15)	15.24 99
15+20+20+25+35+60	1.20	1.60	1.60	2.00	2.80	4.80	14.00 (3.50 - 16.50)	3.47 (0.76 - 5.15)	15.24 99
15+20+20+25+42+42	1.28	1.71	1.71	2.13	3.59	3.59	14.00 (3.50 - 16.50)	3.47 (0.76 - 5.15)	15.24 99
15+20+20+25+42+50	1.22	1.63	1.63	2.03	3.42	4.07	14.00 (3.50 - 16.50)	3.47 (0.76 - 5.15)	15.24 99
15+20+20+25+50+50	1.17	1.56	1.56	1.94	3.89	3.89	14.00 (3.50 - 16.50)	3.47 (0.76 - 5.15)	15.24 99
15+20+20+35+35+35	1.31	1.75	1.75	3.06	3.06	3.06	14.00 (3.50 - 16.50)	3.47 (0.76 - 5.15)	15.24 99
15+20+20+35+35+42	1.26	1.68	1.68	2.93	2.93	3.52	14.00 (3.50 - 16.50)	3.47 (0.76 - 5.15)	15.24 99
15+20+20+35+35+50	1.20	1.60	1.60	2.80	2.80	4.00	14.00 (3.50 - 16.50)	3.47 (0.76 - 5.15)	15.24 99
15+20+20+35+42+42	1.21	1.61	1.61	2.82	3.38	3.38	14.00 (3.50 - 16.50)	3.47 (0.76 - 5.15)	15.24 99
15+20+22+22+22+22	1.63	2.18	2.40	2.40	2.40	2.40	13.40 (3.40 - 16.10)	3.75 (0.78 - 5.85)	16.47 99
15+20+22+22+22+25	1.62	2.16	2.37	2.37	2.37	2.70	13.60 (3.50 - 16.30)	3.67 (0.78 - 5.52)	16.12 99
15+20+22+22+22+35	1.54	2.06	2.26	2.26	2.26	3.60	14.00 (3.50 - 16.50)	3.51 (0.76 - 5.19)	15.42 99
15+20+22+22+22+42	1.47	1.96	2.15	2.15	2.15	4.11	14.00 (3.50 - 16.50)	3.49 (0.76 - 5.17)	15.33 99
15+20+22+22+22+50	1.39	1.85	2.04	2.04	2.04	4.64	14.00 (3.50 - 16.50)	3.47 (0.76 - 5.15)	15.24 99
15+20+22+22+22+60	1.30	1.74	1.91	1.91	1.91	5.22	14.00 (3.50 - 16.50)	3.47 (0.76 - 5.15)	15.24 99
15+20+22+22+22+71	1.22	1.63	1.79	1.79	1.79	5.78	14.00 (3.50 - 16.50)	3.47 (0.76 - 5.15)	15.24 99
15+20+22+22+25+25	1.60	2.14	2.35	2.35	2.67	2.67	13.80 (3.50 - 16.40)	3.60 (0.77 - 5.36)	15.81 99
15+20+22+22+25+35	1.51	2.01	2.22	2.22	2.52	3.53	14.00 (3.50 - 16.50)	3.50 (0.76 - 5.18)	15.37 99
15+20+22+22+25+42	1.44	1.92	2.11	2.11	2.40	4.03	14.00 (3.50 - 16.50)	3.48 (0.76 - 5.16)	15.28 99
15+20+22+22+25+50	1.36	1.82	2.00	2.00	2.27	4.55	14.00 (3.50 - 16.50)	3.47 (0.76 - 5.15)	15.24 99
15+20+22+22+25+60	1.28	1.71	1.88	1.88	2.13	5.12	14.00 (3.50 - 16.50)	3.47 (0.76 - 5.15)	15.24 99
15+20+22+22+25+71	1.20	1.60	1.76	1.76	2.00	5.68	14.00 (3.50 - 16.50)	3.47 (0.76 - 5.15)	15.24 99
15+20+22+22+35+35	1.41	1.88	2.07	2.07	3.29	3.29	14.00 (3.50 - 16.50)	3.47 (0.76 - 5.15)	15.24 99
15+20+22+22+35+42	1.35	1.79	1.97	1.97	3.14	3.77	14.00 (3.50 - 16.50)	3.47 (0.76 - 5.15)	15.24 99
15+20+22+22+35+50	1.28	1.71	1.88	1.88	2.99	4.27	14.00 (3.50 - 16.50)	3.47 (0.76 - 5.15)	15.24 99
15+20+22+22+35+60	1.21	1.61	1.77	1.77	2.82	4.83	14.00 (3.50 - 16.50)	3.47 (0.76 - 5.15)	15.24 99
15+20+22+22+42+42	1.29	1.72	1.89	1.89	3.61	3.61	14.00 (3.50 - 16.50)	3.47 (0.76 - 5.15)	15.24 99
15+20+22+22+42+50	1.23	1.64	1.80	1.80	3.44	4.09	14.00 (3.50 - 16.50)	3.47 (0.76 - 5.15)	15.24 99

MXZ-6C120VA HEATING

Indoor units combination	Heating capacity (kW)						Outdoor unit power consumption (kW)	Current (A)	Power factor (%)
	Unit A	Unit B	Unit C	Unit D	Unit E	Unit F			
15+20+22+22+50+50	1.17	1.56	1.72	1.72	3.91	3.91	14.00 (3.50 - 16.50)	3.47 (0.76 - 5.15)	15.24 99
15+20+22+25+25+25	1.59	2.12	2.33	2.65	2.65	2.65	14.00 (3.50 - 16.50)	3.52 (0.76 - 5.20)	15.46 99
15+20+22+25+25+35	1.48	1.97	2.17	2.46	2.46	3.45	14.00 (3.50 - 16.50)	3.49 (0.76 - 5.17)	15.33 99
15+20+22+25+25+42	1.41	1.88	2.07	2.35	2.35	3.95	14.00 (3.50 - 16.50)	3.47 (0.76 - 5.15)	15.24 99
15+20+22+25+25+50	1.34	1.78	1.96	2.23	2.23	4.46	14.00 (3.50 - 16.50)	3.47 (0.76 - 5.15)	15.24 99
15+20+22+25+25+60	1.26	1.68	1.84	2.10	2.10	5.03	14.00 (3.50 - 16.50)	3.47 (0.76 - 5.15)	15.24 99
15+20+22+25+25+71	1.18	1.57	1.73	1.97	1.97	5.58	14.00 (3.50 - 16.50)	3.47 (0.76 - 5.15)	15.24 99
15+20+22+25+35+35	1.38	1.84	2.03	2.30	3.22	3.22	14.00 (3.50 - 16.50)	3.47 (0.76 - 5.15)	15.24 99
15+20+22+25+35+42	1.32	1.76	1.94	2.20	3.08	3.70	14.00 (3.50 - 16.50)	3.47 (0.76 - 5.15)	15.24 99
15+20+22+25+35+50	1.26	1.68	1.84	2.10	2.93	4.19	14.00 (3.50 - 16.50)	3.47 (0.76 - 5.15)	15.24 99
15+20+22+25+35+60	1.19	1.58	1.74	1.98	2.77	4.75	14.00 (3.50 - 16.50)	3.47 (0.76 - 5.15)	15.24 99
15+20+22+25+42+42	1.27	1.69	1.86	2.11	3.54	3.54	14.00 (3.50 - 16.50)	3.47 (0.76 - 5.15)	15.24 99
15+20+22+25+42+50	1.21	1.61	1.77	2.01	3.38	4.02	14.00 (3.50 - 16.50)	3.47 (0.76 - 5.15)	15.24 99
15+20+22+35+35+35	1.30	1.73	1.90	3.02	3.02	3.02	14.00 (3.50 - 16.50)	3.47 (0.76 - 5.15)	15.24 99
15+20+22+35+35+42	1.24	1.66	1.82	2.90	2.90	3.48	14.00 (3.50 - 16.50)	3.47 (0.76 - 5.15)	15.24 99
15+20+22+35+35+50	1.19	1.58	1.74	2.77	2.77	3.95	14.00 (3.50 - 16.50)	3.47 (0.76 - 5.15)	15.24 99
15+20+22+35+42+42	1.19	1.59	1.75	2.78	3.34	3.34	14.00 (3.50 - 16.50)	3.47 (0.76 - 5.15)	15.24 99
15+20+25+25+25+25	1.56	2.07	2.59	2.59	2.59	2.59	14.00 (3.50 - 16.50)	3.51 (0.76 - 5.19)	15.42 99
15+20+25+25+25+35	1.45	1.93	2.41	2.41	2.41	3.38	14.00 (3.50 - 16.50)	3.48 (0.76 - 5.16)	15.28 99
15+20+25+25+25+42	1.38	1.84	2.30	2.30	2.30	3.87	14.00 (3.50 - 16.50)	3.47 (0.76 - 5.15)	15.24 99
15+20+25+25+25+50	1.31	1.75	2.19	2.19	2.19	4.38	14.00 (3.50 - 16.50)	3.47 (0.76 - 5.15)	15.24 99
15+20+25+25+25+60	1.24	1.65	2.06	2.06	2.06	4.94	14.00 (3.50 - 16.50)	3.47 (0.76 - 5.15)	15.24 99
15+20+25+25+35+35	1.35	1.81	2.26	2.26	3.16	3.16	14.00 (3.50 - 16.50)	3.47 (0.76 - 5.15)	15.24 99
15+20+25+25+35+42	1.30	1.73	2.16	2.16	3.02	3.63	14.00 (3.50 - 16.50)	3.47 (0.76 - 5.15)	15.24 99
15+20+25+25+35+50	1.24	1.65	2.06	2.06	2.88	4.12	14.00 (3.50 - 16.50)	3.47 (0.76 - 5.15)	15.24 99
15+20+25+25+35+60	1.17	1.56	1.94	1.94	2.72	4.67	14.00 (3.50 - 16.50)	3.47 (0.76 - 5.15)	15.24 99
15+20+25+25+42+42	1.24	1.66	2.07	2.07	3.48	3.48	14.00 (3.50 - 16.50)	3.47 (0.76 - 5.15)	15.24 99
15+20+25+25+42+50	1.19	1.58	1.98	1.98	3.32	3.95	14.00 (3.50 - 16.50)	3.47 (0.76 - 5.15)	15.24 99
15+20+25+35+35+35	1.27	1.70	2.12	2.97	2.97	2.97	14.00 (3.50 - 16.50)	3.47 (0.76 - 5.15)	15.24 99
15+20+25+35+35+42	1.22	1.63	2.03	2.85	2.85	3.42	14.00 (3.50 - 16.50)	3.47 (0.76 - 5.15)	15.24 99
15+20+25+35+35+50	1.17	1.56	1.94	2.72	2.72	3.89	14.00 (3.50 - 16.50)	3.47 (0.76 - 5.15)	15.24 99
15+20+25+35+42+42	1.17	1.56	1.96	2.74	3.28	3.28	14.00 (3.50 - 16.50)	3.47 (0.76 - 5.15)	15.24 99
15+20+35+35+35+35	1.20	1.60	2.80	2.80	2.80	2.80	14.00 (3.50 - 16.50)	3.47 (0.76 - 5.15)	15.24 99
15+22+22+22+22+22	1.62	2.38	2.38	2.38	2.38	2.38	13.50 (3.40 - 16.20)	3.71 (0.78 - 5.69)	16.29 99
15+22+22+22+22+25	1.61	2.35	2.35	2.35	2.35	2.68	13.70 (3.50 - 16.30)	3.63 (0.77 - 5.52)	15.94 99
15+22+22+22+22+35	1.52	2.23	2.23	2.23	2.23	3.55	14.00 (3.50 - 16.50)	3.50 (0.76 - 5.18)	15.37 99
15+22+22+22+22+42	1.45	2.12	2.12	2.12	2.12	4.06	14.00 (3.50 - 16.50)	3.48 (0.76 - 5.16)	15.28 99
15+22+22+22+22+50	1.37	2.01	2.01	2.01	2.01	4.58	14.00 (3.50 - 16.50)	3.47 (0.76 - 5.15)	15.24 99
15+22+22+22+22+60	1.29	1.89	1.89	1.89	1.89	5.15	14.00 (3.50 - 16.50)	3.47 (0.76 - 5.15)	15.24 99
15+22+22+22+22+71	1.21	1.77	1.77	1.77	1.77	5.71	14.00 (3.50 - 16.50)	3.47 (0.76 - 5.15)	15.24 99
15+22+22+22+25+25	1.59	2.33	2.33	2.33	2.65	2.65	13.90 (3.50 - 16.50)	3.56 (0.76 - 5.20)	15.63 99
15+22+22+22+25+35	1.49	2.18	2.18	2.18	2.48	3.48	14.00 (3.50 - 16.50)	3.50 (0.76 - 5.18)	15.37 99
15+22+22+22+25+42	1.42	2.08	2.08	2.08	2.36	3.97	14.00 (3.50 - 16.50)	3.48 (0.76 - 5.16)	15.28 99
15+22+22+22+25+50	1.35	1.97	1.97	1.97	2.24	4.49	14.00 (3.50 - 16.50)	3.47 (0.76 - 5.15)	15.24 99
15+22+22+22+25+60	1.27	1.86	1.86	1.86	2.11	5.06	14.00 (3.50 - 16.50)	3.47 (0.76 - 5.15)	15.24 99
15+22+22+22+25+71	1.19	1.74	1.74	1.74	1.98	5.62	14.00 (3.50 - 16.50)	3.47 (0.76 - 5.15)	15.24 99

MXZ-6C120VA HEATING

Indoor units combination	Heating capacity (kW)						Outdoor unit power consumption (kW)	Current (A)	Power factor (%)
	Unit A	Unit B	Unit C	Unit D	Unit E	Unit F			
15+22+22+22+35+35	1.39	2.04	2.04	2.04	3.25	3.25	14.00 (3.50 - 16.50)	3.47 (0.76 - 5.15)	15.24 99
15+22+22+22+35+42	1.33	1.95	1.95	1.95	3.10	3.72	14.00 (3.50 - 16.50)	3.47 (0.76 - 5.15)	15.24 99
15+22+22+22+35+50	1.27	1.86	1.86	1.86	2.95	4.22	14.00 (3.50 - 16.50)	3.47 (0.76 - 5.15)	15.24 99
15+22+22+22+35+60	1.19	1.75	1.75	1.75	2.78	4.77	14.00 (3.50 - 16.50)	3.47 (0.76 - 5.15)	15.24 99
15+22+22+22+42+42	1.27	1.87	1.87	1.87	3.56	3.56	14.00 (3.50 - 16.50)	3.47 (0.76 - 5.15)	15.24 99
15+22+22+22+42+50	1.21	1.78	1.78	1.78	3.40	4.05	14.00 (3.50 - 16.50)	3.47 (0.76 - 5.15)	15.24 99
15+22+22+25+25+25	1.57	2.30	2.30	2.61	2.61	2.61	14.00 (3.50 - 16.50)	3.51 (0.76 - 5.19)	15.42 99
15+22+22+25+25+35	1.46	2.14	2.14	2.43	2.43	3.40	14.00 (3.50 - 16.50)	3.49 (0.76 - 5.17)	15.33 99
15+22+22+25+25+42	1.39	2.04	2.04	2.32	2.32	3.89	14.00 (3.50 - 16.50)	3.47 (0.76 - 5.15)	15.24 99
15+22+22+25+25+50	1.32	1.94	1.94	2.20	2.20	4.40	14.00 (3.50 - 16.50)	3.47 (0.76 - 5.15)	15.24 99
15+22+22+25+25+60	1.24	1.82	1.82	2.07	2.07	4.97	14.00 (3.50 - 16.50)	3.47 (0.76 - 5.15)	15.24 99
15+22+22+25+25+71	1.17	1.71	1.71	1.94	1.94	5.52	14.00 (3.50 - 16.50)	3.47 (0.76 - 5.15)	15.24 99
15+22+22+25+35+35	1.36	2.00	2.00	2.27	3.18	3.18	14.00 (3.50 - 16.50)	3.47 (0.76 - 5.15)	15.24 99
15+22+22+25+35+42	1.30	1.91	1.91	2.17	3.04	3.65	14.00 (3.50 - 16.50)	3.47 (0.76 - 5.15)	15.24 99
15+22+22+25+35+50	1.24	1.82	1.82	2.07	2.90	4.14	14.00 (3.50 - 16.50)	3.47 (0.76 - 5.15)	15.24 99
15+22+22+25+35+60	1.17	1.72	1.72	1.96	2.74	4.69	14.00 (3.50 - 16.50)	3.47 (0.76 - 5.15)	15.24 99
15+22+22+25+42+42	1.25	1.83	1.83	2.08	3.50	3.50	14.00 (3.50 - 16.50)	3.47 (0.76 - 5.15)	15.24 99
15+22+22+25+42+50	1.19	1.75	1.75	1.99	3.34	3.98	14.00 (3.50 - 16.50)	3.47 (0.76 - 5.15)	15.24 99
15+22+22+35+35+35	1.28	1.88	1.88	2.99	2.99	2.99	14.00 (3.50 - 16.50)	3.47 (0.76 - 5.15)	15.24 99
15+22+22+35+35+42	1.23	1.80	1.80	2.87	2.87	3.44	14.00 (3.50 - 16.50)	3.47 (0.76 - 5.15)	15.24 99
15+22+22+35+35+50	1.17	1.72	1.72	2.74	2.74	3.91	14.00 (3.50 - 16.50)	3.47 (0.76 - 5.15)	15.24 99
15+22+22+35+42+42	1.18	1.73	1.73	2.75	3.30	3.30	14.00 (3.50 - 16.50)	3.47 (0.76 - 5.15)	15.24 99
15+22+25+35+35+42	1.21	1.77	2.01	2.82	2.82	3.38	14.00 (3.50 - 16.50)	3.47 (0.76 - 5.15)	15.24 99
15+22+35+35+35+35	1.19	1.74	2.77	2.77	2.77	2.77	14.00 (3.50 - 16.50)	3.47 (0.76 - 5.15)	15.24 99
15+25+25+25+25+25	1.50	2.50	2.50	2.50	2.50	2.50	14.00 (3.50 - 16.50)	3.50 (0.76 - 5.18)	15.37 99
15+25+25+25+25+35	1.40	2.33	2.33	2.33	2.33	3.27	14.00 (3.50 - 16.50)	3.47 (0.76 - 5.15)	15.24 99
15+25+25+25+25+42	1.34	2.23	2.23	2.23	2.23	3.75	14.00 (3.50 - 16.50)	3.47 (0.76 - 5.15)	15.24 99
15+25+25+25+25+50	1.27	2.12	2.12	2.12	2.12	4.24	14.00 (3.50 - 16.50)	3.47 (0.76 - 5.15)	15.24 99
15+25+25+25+25+60	1.20	2.00	2.00	2.00	2.00	4.80	14.00 (3.50 - 16.50)	3.47 (0.76 - 5.15)	15.24 99
15+25+25+25+35+35	1.31	2.19	2.19	2.19	3.06	3.06	14.00 (3.50 - 16.50)	3.47 (0.76 - 5.15)	15.24 99
15+25+25+25+35+42	1.26	2.10	2.10	2.10	2.93	3.52	14.00 (3.50 - 16.50)	3.47 (0.76 - 5.15)	15.24 99
15+25+25+25+35+50	1.20	2.00	2.00	2.00	2.80	4.00	14.00 (3.50 - 16.50)	3.47 (0.76 - 5.15)	15.24 99
15+25+25+25+42+42	1.21	2.01	2.01	2.01	3.38	3.38	14.00 (3.50 - 16.50)	3.47 (0.76 - 5.15)	15.24 99
15+25+25+35+35+35	1.24	2.06	2.06	2.88	2.88	2.88	14.00 (3.50 - 16.50)	3.47 (0.76 - 5.15)	15.24 99
15+25+25+35+35+42	1.19	1.98	1.98	2.77	2.77	3.32	14.00 (3.50 - 16.50)	3.47 (0.76 - 5.15)	15.24 99
15+25+35+35+35+35	1.17	1.94	2.72	2.72	2.72	2.72	14.00 (3.50 - 16.50)	3.47 (0.76 - 5.15)	15.24 99
20+20+20+20+20+20	2.20	2.20	2.20	2.20	2.20	2.20	13.20 (3.40 - 16.00)	3.82 (0.79 - 6.01)	16.78 99
20+20+20+20+20+22	2.18	2.18	2.18	2.18	2.18	2.40	13.30 (3.40 - 16.10)	3.78 (0.79 - 5.85)	16.60 99
20+20+20+20+20+25	2.16	2.16	2.16	2.16	2.16	2.70	13.50 (3.40 - 16.20)	3.71 (0.78 - 5.69)	16.29 99
20+20+20+20+20+35	2.07	2.07	2.07	2.07	2.07	3.63	14.00 (3.50 - 16.50)	3.51 (0.76 - 5.19)	15.42 99
20+20+20+20+20+42	1.97	1.97	1.97	1.97	1.97	4.14	14.00 (3.50 - 16.50)	3.49 (0.76 - 5.17)	15.33 99
20+20+20+20+20+50	1.87	1.87	1.87	1.87	1.87	4.67	14.00 (3.50 - 16.50)	3.47 (0.76 - 5.15)	15.24 99
20+20+20+20+20+60	1.75	1.75	1.75	1.75	1.75	5.25	14.00 (3.50 - 16.50)	3.47 (0.76 - 5.15)	15.24 99
20+20+20+20+20+71	1.64	1.64	1.64	1.64	1.64	5.81	14.00 (3.50 - 16.50)	3.47 (0.76 - 5.15)	15.24 99
20+20+20+20+22+22	2.18	2.18	2.18	2.18	2.40	2.40	13.50 (3.40 - 16.20)	3.71 (0.78 - 5.69)	16.29 99
20+20+20+20+22+25	2.16	2.16	2.16	2.16	2.37	2.70	13.70 (3.50 - 16.30)	3.63 (0.77 - 5.52)	15.94 99

MXZ-6C120VA HEATING

Indoor units combination	Heating capacity (kW)						Outdoor unit power consumption (kW)	Current (A)	Power factor (%)	
	Unit A	Unit B	Unit C	Unit D	Unit E	Unit F				
20+20+20+20+22+35	2.04	2.04	2.04	2.04	2.25	3.58	14.00 (3.50 - 16.50)	3.51 (0.76 - 5.19)	15.42	99
20+20+20+20+22+42	1.94	1.94	1.94	1.94	2.14	4.08	14.00 (3.50 - 16.50)	3.49 (0.76 - 5.17)	15.33	99
20+20+20+20+22+50	1.84	1.84	1.84	1.84	2.03	4.61	14.00 (3.50 - 16.50)	3.47 (0.76 - 5.15)	15.24	99
20+20+20+20+22+60	1.73	1.73	1.73	1.73	1.90	5.19	14.00 (3.50 - 16.50)	3.47 (0.76 - 5.15)	15.24	99
20+20+20+20+22+71	1.62	1.62	1.62	1.62	1.78	5.75	14.00 (3.50 - 16.50)	3.47 (0.76 - 5.15)	15.24	99
20+20+20+20+25+25	2.14	2.14	2.14	2.14	2.67	2.67	13.90 (3.50 - 16.40)	3.56 (0.77 - 5.36)	15.63	99
20+20+20+20+25+35	2.00	2.00	2.00	2.00	2.50	3.50	14.00 (3.50 - 16.50)	3.50 (0.76 - 5.18)	15.37	99
20+20+20+20+25+42	1.90	1.90	1.90	1.90	2.38	4.00	14.00 (3.50 - 16.50)	3.48 (0.76 - 5.16)	15.28	99
20+20+20+20+25+50	1.81	1.81	1.81	1.81	2.26	4.52	14.00 (3.50 - 16.50)	3.47 (0.76 - 5.15)	15.24	99
20+20+20+20+25+60	1.70	1.70	1.70	1.70	2.12	5.09	14.00 (3.50 - 16.50)	3.47 (0.76 - 5.15)	15.24	99
20+20+20+20+25+71	1.59	1.59	1.59	1.59	1.99	5.65	14.00 (3.50 - 16.50)	3.47 (0.76 - 5.15)	15.24	99
20+20+20+20+35+35	1.87	1.87	1.87	1.87	3.27	3.27	14.00 (3.50 - 16.50)	3.47 (0.76 - 5.15)	15.24	99
20+20+20+20+35+42	1.78	1.78	1.78	1.78	3.12	3.75	14.00 (3.50 - 16.50)	3.47 (0.76 - 5.15)	15.24	99
20+20+20+20+35+50	1.70	1.70	1.70	1.70	2.97	4.24	14.00 (3.50 - 16.50)	3.47 (0.76 - 5.15)	15.24	99
20+20+20+20+35+60	1.60	1.60	1.60	1.60	2.80	4.80	14.00 (3.50 - 16.50)	3.47 (0.76 - 5.15)	15.24	99
20+20+20+20+42+42	1.71	1.71	1.71	1.71	3.59	3.59	14.00 (3.50 - 16.50)	3.47 (0.76 - 5.15)	15.24	99
20+20+20+20+42+50	1.63	1.63	1.63	1.63	3.42	4.07	14.00 (3.50 - 16.50)	3.47 (0.76 - 5.15)	15.24	99
20+20+20+20+50+50	1.56	1.56	1.56	1.56	3.89	3.89	14.00 (3.50 - 16.50)	3.47 (0.76 - 5.15)	15.24	99
20+20+20+22+22+22	2.16	2.16	2.16	2.37	2.37	2.37	13.60 (3.50 - 16.30)	3.67 (0.78 - 5.52)	16.12	99
20+20+20+22+22+25	2.14	2.14	2.14	2.35	2.35	2.67	13.80 (3.50 - 16.40)	3.60 (0.77 - 5.36)	15.81	99
20+20+20+22+22+35	2.01	2.01	2.01	2.22	2.22	3.53	14.00 (3.50 - 16.50)	3.50 (0.76 - 5.18)	15.37	99
20+20+20+22+22+42	1.92	1.92	1.92	2.11	2.11	4.03	14.00 (3.50 - 16.50)	3.48 (0.76 - 5.16)	15.28	99
20+20+20+22+22+50	1.82	1.82	1.82	2.00	2.00	4.55	14.00 (3.50 - 16.50)	3.47 (0.76 - 5.15)	15.24	99
20+20+20+22+22+60	1.71	1.71	1.71	1.88	1.88	5.12	14.00 (3.50 - 16.50)	3.47 (0.76 - 5.15)	15.24	99
20+20+20+22+22+71	1.60	1.60	1.60	1.76	1.76	5.68	14.00 (3.50 - 16.50)	3.47 (0.76 - 5.15)	15.24	99
20+20+20+22+25+25	2.12	2.12	2.12	2.33	2.65	2.65	14.00 (3.50 - 16.50)	3.52 (0.76 - 5.20)	15.46	99
20+20+20+22+25+35	1.97	1.97	1.97	2.17	2.46	3.45	14.00 (3.50 - 16.50)	3.49 (0.76 - 5.17)	15.33	99
20+20+20+22+25+42	1.88	1.88	1.88	2.07	2.35	3.95	14.00 (3.50 - 16.50)	3.47 (0.76 - 5.15)	15.24	99
20+20+20+22+25+50	1.78	1.78	1.78	1.96	2.23	4.46	14.00 (3.50 - 16.50)	3.47 (0.76 - 5.15)	15.24	99
20+20+20+22+25+60	1.68	1.68	1.68	1.84	2.10	5.03	14.00 (3.50 - 16.50)	3.47 (0.76 - 5.15)	15.24	99
20+20+20+22+25+71	1.57	1.57	1.57	1.73	1.97	5.58	14.00 (3.50 - 16.50)	3.47 (0.76 - 5.15)	15.24	99
20+20+20+22+35+35	1.84	1.84	1.84	2.03	3.22	3.22	14.00 (3.50 - 16.50)	3.47 (0.76 - 5.15)	15.24	99
20+20+20+22+35+42	1.76	1.76	1.76	1.94	3.08	3.70	14.00 (3.50 - 16.50)	3.47 (0.76 - 5.15)	15.24	99
20+20+20+22+35+50	1.68	1.68	1.68	1.84	2.93	4.19	14.00 (3.50 - 16.50)	3.47 (0.76 - 5.15)	15.24	99
20+20+20+22+35+60	1.58	1.58	1.58	1.74	2.77	4.75	14.00 (3.50 - 16.50)	3.47 (0.76 - 5.15)	15.24	99
20+20+20+22+42+42	1.69	1.69	1.69	1.86	3.54	3.54	14.00 (3.50 - 16.50)	3.47 (0.76 - 5.15)	15.24	99
20+20+20+22+42+50	1.61	1.61	1.61	1.77	3.38	4.02	14.00 (3.50 - 16.50)	3.47 (0.76 - 5.15)	15.24	99
20+20+20+25+25+25	2.07	2.07	2.07	2.59	2.59	2.59	14.00 (3.50 - 16.50)	3.51 (0.76 - 5.19)	15.42	99
20+20+20+25+25+35	1.93	1.93	1.93	2.41	2.41	3.38	14.00 (3.50 - 16.50)	3.48 (0.76 - 5.16)	15.28	99
20+20+20+25+25+42	1.84	1.84	1.84	2.30	2.30	3.87	14.00 (3.50 - 16.50)	3.47 (0.76 - 5.15)	15.24	99
20+20+20+25+25+50	1.75	1.75	1.75	2.19	2.19	4.38	14.00 (3.50 - 16.50)	3.47 (0.76 - 5.15)	15.24	99
20+20+20+25+25+60	1.65	1.65	1.65	2.06	2.06	4.94	14.00 (3.50 - 16.50)	3.47 (0.76 - 5.15)	15.24	99
20+20+20+25+35+35	1.81	1.81	1.81	2.26	3.16	3.16	14.00 (3.50 - 16.50)	3.47 (0.76 - 5.15)	15.24	99
20+20+20+25+35+42	1.73	1.73	1.73	2.16	3.02	3.63	14.00 (3.50 - 16.50)	3.47 (0.76 - 5.15)	15.24	99
20+20+20+25+35+50	1.65	1.65	1.65	2.06	2.88	4.12	14.00 (3.50 - 16.50)	3.47 (0.76 - 5.15)	15.24	99
20+20+20+25+35+60	1.56	1.56	1.56	1.94	2.72	4.67	14.00 (3.50 - 16.50)	3.47 (0.76 - 5.15)	15.24	99

MXZ-6C120VA HEATING

Indoor units combination	Heating capacity (kW)						Outdoor unit power consumption (kW)	Current (A)	Power factor (%)	
	Unit A	Unit B	Unit C	Unit D	Unit E	Unit F				
20+20+20+25+42+42	1.66	1.66	1.66	2.07	3.48	3.48	14.00 (3.50 - 16.50)	3.47 (0.76 - 5.15)	15.24	99
20+20+20+25+42+50	1.58	1.58	1.58	1.98	3.32	3.95	14.00 (3.50 - 16.50)	3.47 (0.76 - 5.15)	15.24	99
20+20+20+35+35+35	1.70	1.70	1.70	2.97	2.97	2.97	14.00 (3.50 - 16.50)	3.47 (0.76 - 5.15)	15.24	99
20+20+20+35+35+42	1.63	1.63	1.63	2.85	2.85	3.42	14.00 (3.50 - 16.50)	3.47 (0.76 - 5.15)	15.24	99
20+20+20+35+35+50	1.56	1.56	1.56	2.72	2.72	3.89	14.00 (3.50 - 16.50)	3.47 (0.76 - 5.15)	15.24	99
20+20+20+35+42+42	1.56	1.56	1.56	2.74	3.28	3.28	14.00 (3.50 - 16.50)	3.47 (0.76 - 5.15)	15.24	99
20+20+22+22+22+22	2.14	2.14	2.35	2.35	2.35	2.35	13.70 (3.50 - 16.30)	3.63 (0.77 - 5.52)	15.94	99
20+20+22+22+22+25	2.12	2.12	2.33	2.33	2.33	2.65	13.90 (3.50 - 16.50)	3.56 (0.76 - 5.20)	15.63	99
20+20+22+22+22+35	1.99	1.99	2.18	2.18	2.18	3.48	14.00 (3.50 - 16.50)	3.50 (0.76 - 5.18)	15.37	99
20+20+22+22+22+42	1.89	1.89	2.08	2.08	2.08	3.97	14.00 (3.50 - 16.50)	3.48 (0.76 - 5.16)	15.28	99
20+20+22+22+22+50	1.79	1.79	1.97	1.97	1.97	4.49	14.00 (3.50 - 16.50)	3.47 (0.76 - 5.15)	15.24	99
20+20+22+22+22+60	1.69	1.69	1.86	1.86	1.86	5.06	14.00 (3.50 - 16.50)	3.47 (0.76 - 5.15)	15.24	99
20+20+22+22+22+71	1.58	1.58	1.74	1.74	1.74	5.62	14.00 (3.50 - 16.50)	3.47 (0.76 - 5.15)	15.24	99
20+20+22+22+25+25	2.09	2.09	2.30	2.30	2.61	2.61	14.00 (3.50 - 16.50)	3.51 (0.76 - 5.19)	15.42	99
20+20+22+22+25+35	1.94	1.94	2.14	2.14	2.43	3.40	14.00 (3.50 - 16.50)	3.49 (0.76 - 5.17)	15.33	99
20+20+22+22+25+42	1.85	1.85	2.04	2.04	2.32	3.89	14.00 (3.50 - 16.50)	3.47 (0.76 - 5.15)	15.24	99
20+20+22+22+25+50	1.76	1.76	1.94	1.94	2.20	4.40	14.00 (3.50 - 16.50)	3.47 (0.76 - 5.15)	15.24	99
20+20+22+22+25+60	1.66	1.66	1.82	1.82	2.07	4.97	14.00 (3.50 - 16.50)	3.47 (0.76 - 5.15)	15.24	99
20+20+22+22+25+71	1.56	1.56	1.71	1.71	1.94	5.52	14.00 (3.50 - 16.50)	3.47 (0.76 - 5.15)	15.24	99
20+20+22+22+35+35	1.82	1.82	2.00	2.00	3.18	3.18	14.00 (3.50 - 16.50)	3.47 (0.76 - 5.15)	15.24	99
20+20+22+22+35+42	1.74	1.74	1.91	1.91	3.04	3.65	14.00 (3.50 - 16.50)	3.47 (0.76 - 5.15)	15.24	99
20+20+22+22+35+50	1.66	1.66	1.82	1.82	2.90	4.14	14.00 (3.50 - 16.50)	3.47 (0.76 - 5.15)	15.24	99
20+20+22+22+35+60	1.56	1.56	1.72	1.72	2.74	4.69	14.00 (3.50 - 16.50)	3.47 (0.76 - 5.15)	15.24	99
20+20+22+22+42+42	1.67	1.67	1.83	1.83	3.50	3.50	14.00 (3.50 - 16.50)	3.47 (0.76 - 5.15)	15.24	99
20+20+22+22+42+50	1.59	1.59	1.75	1.75	3.34	3.98	14.00 (3.50 - 16.50)	3.47 (0.76 - 5.15)	15.24	99
20+20+22+25+25+25	2.04	2.04	2.25	2.55	2.55	2.55	14.00 (3.50 - 16.50)	3.51 (0.76 - 5.19)	15.42	99
20+20+22+25+25+35	1.90	1.90	2.10	2.38	2.38	3.33	14.00 (3.50 - 16.50)	3.48 (0.76 - 5.16)	15.28	99
20+20+22+25+25+42	1.82	1.82	2.00	2.27	2.27	3.82	14.00 (3.50 - 16.50)	3.47 (0.76 - 5.15)	15.24	99
20+20+22+25+25+50	1.73	1.73	1.90	2.16	2.16	4.32	14.00 (3.50 - 16.50)	3.47 (0.76 - 5.15)	15.24	99
20+20+22+25+25+60	1.63	1.63	1.79	2.03	2.03	4.88	14.00 (3.50 - 16.50)	3.47 (0.76 - 5.15)	15.24	99
20+20+22+25+35+35	1.78	1.78	1.96	2.23	3.12	3.12	14.00 (3.50 - 16.50)	3.47 (0.76 - 5.15)	15.24	99
20+20+22+25+35+42	1.71	1.71	1.88	2.13	2.99	3.59	14.00 (3.50 - 16.50)	3.47 (0.76 - 5.15)	15.24	99
20+20+22+25+35+50	1.63	1.63	1.79	2.03	2.85	4.07	14.00 (3.50 - 16.50)	3.47 (0.76 - 5.15)	15.24	99
20+20+22+25+42+42	1.64	1.64	1.80	2.05	3.44	3.44	14.00 (3.50 - 16.50)	3.47 (0.76 - 5.15)	15.24	99
20+20+22+25+42+50	1.56	1.56	1.72	1.96	3.28	3.91	14.00 (3.50 - 16.50)	3.47 (0.76 - 5.15)	15.24	99
20+20+22+35+35+35	1.68	1.68	1.84	2.93	2.93	2.93	14.00 (3.50 - 16.50)	3.47 (0.76 - 5.15)	15.24	99
20+20+22+35+35+42	1.61	1.61	1.77	2.82	2.82	3.38	14.00 (3.50 - 16.50)	3.47 (0.76 - 5.15)	15.24	99
20+20+25+25+25+25	2.00	2.00	2.50	2.50	2.50	2.50	14.00 (3.50 - 16.50)	3.50 (0.76 - 5.18)	15.37	99
20+20+25+25+25+35	1.87	1.87	2.33	2.33	2.33	3.27	14.00 (3.50 - 16.50)	3.47 (0.76 - 5.15)	15.24	99
20+20+25+25+25+42	1.78	1.78	2.23	2.23	2.23	3.75	14.00 (3.50 - 16.50)	3.47 (0.76 - 5.15)	15.24	99
20+20+25+25+25+50	1.70	1.70	2.12	2.12	2.12	4.24	14.00 (3.50 - 16.50)	3.47 (0.76 - 5.15)	15.24	99
20+20+25+25+25+60	1.60	1.60	2.00	2.00	2.00	4.80	14.00 (3.50 - 16.50)	3.47 (0.76 - 5.15)	15.24	99
20+20+25+25+35+35	1.75	1.75	2.19	2.19	3.06	3.06	14.00 (3.50 - 16.50)	3.47 (0.76 - 5.15)	15.24	99
20+20+25+25+35+42	1.68	1.68	2.10	2.10	2.93	3.52	14.00 (3.50 - 16.50)	3.47 (0.76 - 5.15)	15.24	99
20+20+25+25+35+50	1.60	1.60	2.00	2.00	2.80	4.00	14.00 (3.50 - 16.50)	3.47 (0.76 - 5.15)	15.24	99
20+20+25+25+42+42	1.61	1.61	2.01	2.01	3.38	3.38	14.00 (3.50 - 16.50)	3.47 (0.76 - 5.15)	15.24	99

MXZ-6C120VA HEATING

Indoor units combination	Heating capacity (kW)						Outdoor unit power consumption (kW)	Current (A)	Power factor (%)
	Unit A	Unit B	Unit C	Unit D	Unit E	Unit F			
20+20+25+35+35+35	1.65	1.65	2.06	2.88	2.88	2.88	14.00 (3.50 - 16.50)	3.47 (0.76 - 5.15)	15.24 99
20+20+25+35+35+42	1.58	1.58	1.98	2.77	2.77	3.32	14.00 (3.50 - 16.50)	3.47 (0.76 - 5.15)	15.24 99
20+20+35+35+35+35	1.56	1.56	2.72	2.72	2.72	2.72	14.00 (3.50 - 16.50)	3.47 (0.76 - 5.15)	15.24 99
20+22+22+22+22+22	2.14	2.35	2.35	2.35	2.35	2.35	13.90 (3.50 - 16.40)	3.56 (0.77 - 5.36)	15.63 99
20+22+22+22+22+25	2.11	2.32	2.32	2.32	2.32	2.63	14.00 (3.50 - 16.50)	3.52 (0.76 - 5.20)	15.46 99
20+22+22+22+22+35	1.96	2.15	2.15	2.15	2.15	3.43	14.00 (3.50 - 16.50)	3.49 (0.76 - 5.17)	15.33 99
20+22+22+22+22+42	1.87	2.05	2.05	2.05	2.05	3.92	14.00 (3.50 - 16.50)	3.47 (0.76 - 5.15)	15.24 99
20+22+22+22+22+50	1.77	1.95	1.95	1.95	1.95	4.43	14.00 (3.50 - 16.50)	3.47 (0.76 - 5.15)	15.24 99
20+22+22+22+22+60	1.67	1.83	1.83	1.83	1.83	5.00	14.00 (3.50 - 16.50)	3.47 (0.76 - 5.15)	15.24 99
20+22+22+22+22+71	1.56	1.72	1.72	1.72	1.72	5.55	14.00 (3.50 - 16.50)	3.47 (0.76 - 5.15)	15.24 99
20+22+22+22+25+25	2.06	2.26	2.26	2.26	2.57	2.57	14.00 (3.50 - 16.50)	3.51 (0.76 - 5.19)	15.42 99
20+22+22+22+25+35	1.92	2.11	2.11	2.11	2.40	3.36	14.00 (3.50 - 16.50)	3.48 (0.76 - 5.16)	15.28 99
20+22+22+22+25+42	1.83	2.01	2.01	2.01	2.29	3.84	14.00 (3.50 - 16.50)	3.47 (0.76 - 5.15)	15.24 99
20+22+22+22+25+50	1.74	1.91	1.91	1.91	2.17	4.35	14.00 (3.50 - 16.50)	3.47 (0.76 - 5.15)	15.24 99
20+22+22+22+25+60	1.64	1.80	1.80	1.80	2.05	4.91	14.00 (3.50 - 16.50)	3.47 (0.76 - 5.15)	15.24 99
20+22+22+22+35+35	1.79	1.97	1.97	1.97	3.14	3.14	14.00 (3.50 - 16.50)	3.47 (0.76 - 5.15)	15.24 99
20+22+22+22+35+42	1.72	1.89	1.89	1.89	3.01	3.61	14.00 (3.50 - 16.50)	3.47 (0.76 - 5.15)	15.24 99
20+22+22+22+35+50	1.64	1.80	1.80	1.80	2.87	4.09	14.00 (3.50 - 16.50)	3.47 (0.76 - 5.15)	15.24 99
20+22+22+22+42+42	1.65	1.81	1.81	1.81	3.46	3.46	14.00 (3.50 - 16.50)	3.47 (0.76 - 5.15)	15.24 99
20+22+22+22+42+50	1.57	1.73	1.73	1.73	3.30	3.93	14.00 (3.50 - 16.50)	3.47 (0.76 - 5.15)	15.24 99
20+22+22+25+25+25	2.01	2.22	2.22	2.52	2.52	2.52	14.00 (3.50 - 16.50)	3.50 (0.76 - 5.18)	15.37 99
20+22+22+25+25+35	1.88	2.07	2.07	2.35	2.35	3.29	14.00 (3.50 - 16.50)	3.47 (0.76 - 5.15)	15.24 99
20+22+22+25+25+42	1.79	1.97	1.97	2.24	2.24	3.77	14.00 (3.50 - 16.50)	3.47 (0.76 - 5.15)	15.24 99
20+22+22+25+25+50	1.71	1.88	1.88	2.13	2.13	4.27	14.00 (3.50 - 16.50)	3.47 (0.76 - 5.15)	15.24 99
20+22+22+25+25+60	1.61	1.77	1.77	2.01	2.01	4.83	14.00 (3.50 - 16.50)	3.47 (0.76 - 5.15)	15.24 99
20+22+22+25+35+35	1.76	1.94	1.94	2.20	3.08	3.08	14.00 (3.50 - 16.50)	3.47 (0.76 - 5.15)	15.24 99
20+22+22+25+35+42	1.69	1.86	1.86	2.11	2.95	3.54	14.00 (3.50 - 16.50)	3.47 (0.76 - 5.15)	15.24 99
20+22+22+25+35+50	1.61	1.77	1.77	2.01	2.82	4.02	14.00 (3.50 - 16.50)	3.47 (0.76 - 5.15)	15.24 99
20+22+22+25+42+42	1.62	1.78	1.78	2.02	3.40	3.40	14.00 (3.50 - 16.50)	3.47 (0.76 - 5.15)	15.24 99
20+22+22+35+35+35	1.66	1.82	1.82	2.90	2.90	2.90	14.00 (3.50 - 16.50)	3.47 (0.76 - 5.15)	15.24 99
20+22+22+35+35+42	1.59	1.75	1.75	2.78	2.78	3.34	14.00 (3.50 - 16.50)	3.47 (0.76 - 5.15)	15.24 99
20+22+25+25+25+25	1.97	2.17	2.46	2.46	2.46	2.46	14.00 (3.50 - 16.50)	3.49 (0.76 - 5.17)	15.33 99
20+22+25+25+25+35	1.84	2.03	2.30	2.30	2.30	3.22	14.00 (3.50 - 16.50)	3.47 (0.76 - 5.15)	15.24 99
20+22+25+25+25+42	1.76	1.94	2.20	2.20	2.20	3.70	14.00 (3.50 - 16.50)	3.47 (0.76 - 5.15)	15.24 99
20+22+25+25+25+50	1.68	1.84	2.10	2.10	2.10	4.19	14.00 (3.50 - 16.50)	3.47 (0.76 - 5.15)	15.24 99
20+22+25+25+25+60	1.58	1.74	1.98	1.98	1.98	4.75	14.00 (3.50 - 16.50)	3.47 (0.76 - 5.15)	15.24 99
20+22+25+25+35+35	1.73	1.90	2.16	2.16	3.02	3.02	14.00 (3.50 - 16.50)	3.47 (0.76 - 5.15)	15.24 99
20+22+25+25+35+42	1.66	1.82	2.07	2.07	2.90	3.48	14.00 (3.50 - 16.50)	3.47 (0.76 - 5.15)	15.24 99
20+22+25+25+35+50	1.58	1.74	1.98	1.98	2.77	3.95	14.00 (3.50 - 16.50)	3.47 (0.76 - 5.15)	15.24 99
20+22+25+25+42+42	1.59	1.75	1.99	1.99	3.34	3.34	14.00 (3.50 - 16.50)	3.47 (0.76 - 5.15)	15.24 99
20+22+25+35+35+35	1.63	1.79	2.03	2.85	2.85	2.85	14.00 (3.50 - 16.50)	3.47 (0.76 - 5.15)	15.24 99
20+22+25+35+35+42	1.56	1.72	1.96	2.74	2.74	3.28	14.00 (3.50 - 16.50)	3.47 (0.76 - 5.15)	15.24 99
20+25+25+25+25+25	1.93	2.41	2.41	2.41	2.41	2.41	14.00 (3.50 - 16.50)	3.48 (0.76 - 5.16)	15.28 99
20+25+25+25+25+35	1.81	2.26	2.26	2.26	2.26	3.16	14.00 (3.50 - 16.50)	3.47 (0.76 - 5.15)	15.24 99
20+25+25+25+25+42	1.73	2.16	2.16	2.16	2.16	3.63	14.00 (3.50 - 16.50)	3.47 (0.76 - 5.15)	15.24 99
20+25+25+25+25+50	1.65	2.06	2.06	2.06	2.06	4.12	14.00 (3.50 - 16.50)	3.47 (0.76 - 5.15)	15.24 99

MXZ-6C120VA HEATING

Indoor units combination	Heating capacity (kW)						Outdoor unit power consumption (kW)	Current (A)	Power factor (%)
	Unit A	Unit B	Unit C	Unit D	Unit E	Unit F			
20+25+25+25+25+60	1.56	1.94	1.94	1.94	1.94	4.67	14.00 (3.50 - 16.50)	3.47 (0.76 - 5.15)	15.24 99
20+25+25+25+35+35	1.70	2.12	2.12	2.12	2.97	2.97	14.00 (3.50 - 16.50)	3.47 (0.76 - 5.15)	15.24 99
20+25+25+25+35+42	1.63	2.03	2.03	2.03	2.85	3.42	14.00 (3.50 - 16.50)	3.47 (0.76 - 5.15)	15.24 99
20+25+25+25+35+50	1.56	1.94	1.94	1.94	2.72	3.89	14.00 (3.50 - 16.50)	3.47 (0.76 - 5.15)	15.24 99
20+25+25+25+42+42	1.56	1.96	1.96	1.96	3.28	3.28	14.00 (3.50 - 16.50)	3.47 (0.76 - 5.15)	15.24 99
20+25+25+35+35+35	1.60	2.00	2.00	2.80	2.80	2.80	14.00 (3.50 - 16.50)	3.47 (0.76 - 5.15)	15.24 99
22+22+22+22+22+22	2.33	2.33	2.33	2.33	2.33	2.33	14.00 (3.50 - 16.50)	3.52 (0.76 - 5.20)	15.46 99
22+22+22+22+22+25	2.28	2.28	2.28	2.28	2.28	2.59	14.00 (3.50 - 16.50)	3.51 (0.76 - 5.19)	15.42 99
22+22+22+22+22+35	2.12	2.12	2.12	2.12	2.12	3.38	14.00 (3.50 - 16.50)	3.48 (0.76 - 5.16)	15.28 99
22+22+22+22+22+42	2.03	2.03	2.03	2.03	2.03	3.87	14.00 (3.50 - 16.50)	3.47 (0.76 - 5.15)	15.24 99
22+22+22+22+22+50	1.93	1.93	1.93	1.93	1.93	4.38	14.00 (3.50 - 16.50)	3.47 (0.76 - 5.15)	15.24 99
22+22+22+22+22+60	1.81	1.81	1.81	1.81	1.81	4.94	14.00 (3.50 - 16.50)	3.47 (0.76 - 5.15)	15.24 99
22+22+22+22+25+25	2.23	2.23	2.23	2.23	2.54	2.54	14.00 (3.50 - 16.50)	3.50 (0.76 - 5.18)	15.37 99
22+22+22+22+25+35	2.08	2.08	2.08	2.08	2.36	3.31	14.00 (3.50 - 16.50)	3.48 (0.76 - 5.16)	15.28 99
22+22+22+22+25+42	1.99	1.99	1.99	1.99	2.26	3.79	14.00 (3.50 - 16.50)	3.47 (0.76 - 5.15)	15.24 99
22+22+22+22+25+50	1.89	1.89	1.89	1.89	2.15	4.29	14.00 (3.50 - 16.50)	3.47 (0.76 - 5.15)	15.24 99
22+22+22+22+25+60	1.78	1.78	1.78	1.78	2.02	4.86	14.00 (3.50 - 16.50)	3.47 (0.76 - 5.15)	15.24 99
22+22+22+22+35+35	1.95	1.95	1.95	1.95	3.10	3.10	14.00 (3.50 - 16.50)	3.47 (0.76 - 5.15)	15.24 99
22+22+22+22+35+42	1.87	1.87	1.87	1.87	2.97	3.56	14.00 (3.50 - 16.50)	3.47 (0.76 - 5.15)	15.24 99
22+22+22+22+35+50	1.78	1.78	1.78	1.78	2.83	4.05	14.00 (3.50 - 16.50)	3.47 (0.76 - 5.15)	15.24 99
22+22+22+22+42+42	1.79	1.79	1.79	1.79	3.42	3.42	14.00 (3.50 - 16.50)	3.47 (0.76 - 5.15)	15.24 99
22+22+22+22+42+50	1.71	1.71	1.71	1.71	3.27	3.89	14.00 (3.50 - 16.50)	3.47 (0.76 - 5.15)	15.24 99
22+22+22+25+25+25	2.18	2.18	2.18	2.48	2.48	2.48	14.00 (3.50 - 16.50)	3.50 (0.76 - 5.18)	15.37 99
22+22+22+25+25+35	2.04	2.04	2.04	2.32	2.32	3.25	14.00 (3.50 - 16.50)	3.47 (0.76 - 5.15)	15.24 99
22+22+22+25+25+42	1.95	1.95	1.95	2.22	2.22	3.72	14.00 (3.50 - 16.50)	3.47 (0.76 - 5.15)	15.24 99
22+22+22+25+25+50	1.86	1.86	1.86	2.11	2.11	4.22	14.00 (3.50 - 16.50)	3.47 (0.76 - 5.15)	15.24 99
22+22+22+25+25+60	1.75	1.75	1.75	1.99	1.99	4.77	14.00 (3.50 - 16.50)	3.47 (0.76 - 5.15)	15.24 99
22+22+22+25+35+35	1.91	1.91	1.91	2.17	3.04	3.04	14.00 (3.50 - 16.50)	3.47 (0.76 - 5.15)	15.24 99
22+22+22+25+35+42	1.83	1.83	1.83	2.08	2.92	3.50	14.00 (3.50 - 16.50)	3.47 (0.76 - 5.15)	15.24 99
22+22+22+25+35+50	1.75	1.75	1.75	1.99	2.78	3.98	14.00 (3.50 - 16.50)	3.47 (0.76 - 5.15)	15.24 99
22+22+22+25+42+42	1.76	1.76	1.76	2.00	3.36	3.36	14.00 (3.50 - 16.50)	3.47 (0.76 - 5.15)	15.24 99
22+22+22+35+35+35	1.80	1.80	1.80	2.87	2.87	2.87	14.00 (3.50 - 16.50)	3.47 (0.76 - 5.15)	15.24 99
22+22+22+35+35+42	1.73	1.73	1.73	2.75	2.75	3.30	14.00 (3.50 - 16.50)	3.47 (0.76 - 5.15)	15.24 99
22+22+25+25+25+25	2.14	2.14	2.43	2.43	2.43	2.43	14.00 (3.50 - 16.50)	3.49 (0.76 - 5.17)	15.33 99
22+22+25+25+25+35	2.00	2.00	2.27	2.27	2.27	3.18	14.00 (3.50 - 16.50)	3.47 (0.76 - 5.15)	15.24 99
22+22+25+25+25+42	1.91	1.91	2.17	2.17	2.17	3.65	14.00 (3.50 - 16.50)	3.47 (0.76 - 5.15)	15.24 99
22+22+25+25+25+50	1.82	1.82	2.07	2.07	2.07	4.14	14.00 (3.50 - 16.50)	3.47 (0.76 - 5.15)	15.24 99
22+22+25+25+25+60	1.72	1.72	1.96	1.96	1.96	4.69	14.00 (3.50 - 16.50)	3.47 (0.76 - 5.15)	15.24 99
22+22+25+25+35+35	1.88	1.88	2.13	2.13	2.99	2.99	14.00 (3.50 - 16.50)	3.47 (0.76 - 5.15)	15.24 99
22+22+25+25+35+42	1.80	1.80	2.05	2.05	2.87	3.44	14.00 (3.50 - 16.50)	3.47 (0.76 - 5.15)	15.24 99
22+22+25+25+35+50	1.72	1.72	1.96	1.96	2.74	3.91	14.00 (3.50 - 16.50)	3.47 (0.76 - 5.15)	15.24 99
22+22+25+25+42+42	1.73	1.73	1.97	1.97	3.30	3.30	14.00 (3.50 - 16.50)	3.47 (0.76 - 5.15)	15.24 99
22+22+25+35+35+35	1.77	1.77	2.01	2.82	2.82	2.82	14.00 (3.50 - 16.50)	3.47 (0.76 - 5.15)	15.24 99
22+25+25+25+25+25	2.10	2.38	2.38	2.38	2.38	2.38	14.00 (3.50 - 16.50)	3.48 (0.76 - 5.16)	15.28 99
22+25+25+25+25+35	1.96	2.23	2.23	2.23	2.23	3.12	14.00 (3.50 - 16.50)	3.47 (0.76 - 5.15)	15.24 99
22+25+25+25+25+42	1.88	2.13	2.13	2.13	2.13	3.59	14.00 (3.50 - 16.50)	3.47 (0.76 - 5.15)	15.24 99

MXZ-6C120VA HEATING

Indoor units combination	Heating capacity (kW)							Outdoor unit power consumption (kW)	Current (A)	Power factor (%)
	Unit A	Unit B	Unit C	Unit D	Unit E	Unit F	Total			
22+25+25+25+25+50	1.79	2.03	2.03	2.03	2.03	4.07	14.00 (3.50 - 16.50)	3.47 (0.76 - 5.15)	15.24	99
22+25+25+25+35+35	1.84	2.10	2.10	2.10	2.93	2.93	14.00 (3.50 - 16.50)	3.47 (0.76 - 5.15)	15.24	99
22+25+25+25+35+42	1.77	2.01	2.01	2.01	2.82	3.38	14.00 (3.50 - 16.50)	3.47 (0.76 - 5.15)	15.24	99
22+25+25+35+35+35	1.74	1.98	1.98	2.77	2.77	2.77	14.00 (3.50 - 16.50)	3.47 (0.76 - 5.15)	15.24	99
25+25+25+25+25+25	2.33	2.33	2.33	2.33	2.33	2.33	14.00 (3.50 - 16.50)	3.47 (0.76 - 5.15)	15.24	99
25+25+25+25+25+35	2.19	2.19	2.19	2.19	2.19	3.06	14.00 (3.50 - 16.50)	3.47 (0.76 - 5.15)	15.24	99
25+25+25+25+25+42	2.10	2.10	2.10	2.10	2.10	3.52	14.00 (3.50 - 16.50)	3.47 (0.76 - 5.15)	15.24	99
25+25+25+25+25+50	2.00	2.00	2.00	2.00	2.00	4.00	14.00 (3.50 - 16.50)	3.47 (0.76 - 5.15)	15.24	99
25+25+25+25+35+35	2.06	2.06	2.06	2.06	2.88	2.88	14.00 (3.50 - 16.50)	3.47 (0.76 - 5.15)	15.24	99
25+25+25+25+35+42	1.98	1.98	1.98	1.98	2.77	3.32	14.00 (3.50 - 16.50)	3.47 (0.76 - 5.15)	15.24	99
25+25+25+35+35+35	1.94	1.94	1.94	2.72	2.72	2.72	14.00 (3.50 - 16.50)	3.47 (0.76 - 5.15)	15.24	99

MXZ-6C122VA COOLING

Indoor units combination	Cooling Capacity (kW)							Outdoor unit power consumption (kW)	Current (A)	Power factor (%)
	Unit A	Unit B	Unit C	Unit D	Unit E	Unit F	Total			
15	1.50	-	-	-	-	-	1.50 (1.40-2.10)	0.960 (0.890-1.150)	4.22	99
20	2.00	-	-	-	-	-	2.00 (1.80-2.80)	0.980 (0.890-1.540)	4.30	99
22	2.20	-	-	-	-	-	2.20 (2.00-3.00)	0.890 (0.850-0.940)	3.91	99
25	2.50	-	-	-	-	-	2.50 (2.20-3.30)	0.890 (0.850-0.970)	3.91	99
35	3.50	-	-	-	-	-	3.50 (2.50-4.30)	1.030 (0.850-1.180)	4.52	99
42	4.20	-	-	-	-	-	4.20 (2.50-5.00)	1.230 (0.850-1.460)	5.40	99
50	5.00	-	-	-	-	-	5.00 (2.60-5.60)	1.440 (0.850-1.630)	6.32	99
60	6.00	-	-	-	-	-	6.00 (2.70-7.50)	1.840 (0.830-2.310)	8.08	99
71	7.10	-	-	-	-	-	7.10 (2.70-8.70)	2.310 (0.830-2.840)	10.14	99
15+15	1.50	1.50	-	-	-	-	3.00 (2.50-4.20)	0.910 (0.880-2.300)	4.00	99
15+20	1.50	2.00	-	-	-	-	3.50 (2.50-4.90)	0.989 (0.880-2.690)	4.34	99
15+22	1.50	2.20	-	-	-	-	3.70 (2.50-5.10)	1.020 (0.880-2.800)	4.48	99
15+25	1.50	2.50	-	-	-	-	4.00 (2.50-5.50)	1.067 (0.880-3.020)	4.69	99
15+35	1.50	3.50	-	-	-	-	5.00 (2.70-6.50)	1.350 (0.840-2.280)	5.93	99
15+42	1.50	4.20	-	-	-	-	5.70 (2.70-7.20)	1.626 (0.840-2.520)	7.14	99
15+50	1.50	5.00	-	-	-	-	6.50 (2.80-7.90)	1.941 (0.840-2.750)	8.53	99
15+60	1.50	6.00	-	-	-	-	7.50 (2.80-8.70)	2.756 (0.840-3.020)	12.10	99
15+71	1.48	7.02	-	-	-	-	8.50 (2.80-9.30)	2.948 (0.840-3.130)	12.95	99
20+20	2.00	2.00	-	-	-	-	4.00 (2.50-5.50)	1.067 (0.880-3.020)	4.69	99
20+22	2.00	2.20	-	-	-	-	4.20 (2.60-5.70)	1.099 (0.860-2.460)	4.82	99
20+25	2.00	2.50	-	-	-	-	4.50 (2.70-6.00)	1.167 (0.840-1.960)	5.12	99
20+35	2.00	3.50	-	-	-	-	5.50 (2.70-7.00)	1.547 (0.840-2.450)	6.79	99
20+42	2.00	4.20	-	-	-	-	6.20 (2.80-7.60)	1.823 (0.840-2.650)	8.01	99
20+50	2.00	5.00	-	-	-	-	7.00 (2.80-8.40)	2.296 (0.840-2.920)	10.08	99
20+60	2.00	6.00	-	-	-	-	8.00 (2.80-9.00)	2.943 (0.840-3.080)	12.92	99
20+71	1.89	6.71	-	-	-	-	8.60 (2.80-9.30)	2.949 (0.840-3.130)	12.95	99
22+22	2.20	2.20	-	-	-	-	4.40 (2.70-5.90)	1.130 (0.850-2.200)	4.96	99
22+25	2.20	2.50	-	-	-	-	4.70 (2.70-6.20)	1.240 (0.840-2.090)	5.45	99
22+35	2.20	3.50	-	-	-	-	5.70 (2.70-7.20)	1.626 (0.840-2.520)	7.14	99
22+42	2.20	4.20	-	-	-	-	6.40 (2.80-7.80)	1.902 (0.840-2.720)	8.35	99
22+50	2.20	5.00	-	-	-	-	7.20 (2.80-8.50)	2.480 (0.840-2.970)	10.89	99
22+60	2.20	6.00	-	-	-	-	8.20 (2.80-9.10)	2.945 (0.840-3.110)	12.93	99
22+71	2.06	6.64	-	-	-	-	8.70 (2.80-9.40)	2.950 (0.840-3.130)	12.96	99
25+25	2.50	2.50	-	-	-	-	5.00 (2.70-6.50)	1.350 (0.840-2.280)	5.93	99
25+35	2.50	3.50	-	-	-	-	6.00 (2.80-7.50)	1.744 (0.840-2.620)	7.66	99
25+42	2.50	4.20	-	-	-	-	6.70 (2.80-8.10)	2.020 (0.840-2.820)	8.87	99
25+50	2.50	5.00	-	-	-	-	7.50 (2.80-8.70)	2.756 (0.840-3.020)	12.10	99
25+60	2.47	5.93	-	-	-	-	8.40 (2.80-9.20)	2.947 (0.840-3.130)	12.94	99
25+71	2.29	6.51	-	-	-	-	8.80 (2.80-9.40)	2.960 (0.840-3.130)	13.00	99
35+35	3.50	3.50	-	-	-	-	7.00 (2.80-8.40)	2.296 (0.840-2.920)	10.08	99
35+42	3.50	4.20	-	-	-	-	7.70 (2.80-8.80)	2.940 (0.840-3.040)	12.91	99
35+50	3.46	4.94	-	-	-	-	8.40 (2.80-9.20)	2.947 (0.840-3.130)	12.94	99
35+60	3.21	5.49	-	-	-	-	8.70 (2.80-9.40)	2.950 (0.840-3.130)	12.96	99
35+71	3.00	6.10	-	-	-	-	9.10 (2.80-9.70)	2.990 (0.830-3.160)	13.13	99
42+42	4.20	4.20	-	-	-	-	8.40 (2.80-9.20)	2.947 (0.840-3.130)	12.94	99
42+50	3.97	4.73	-	-	-	-	8.70 (2.80-9.40)	2.950 (0.840-3.130)	12.96	99

MXZ-6C122VA COOLING

Indoor units combination	Cooling Capacity (kW)							Outdoor unit power consumption (kW)	Current (A)	Power factor (%)
	Unit A	Unit B	Unit C	Unit D	Unit E	Unit F	Total			
42+60	3.75	5.35	-	-	-	-	9.10 (2.80-9.70)	2.990 (0.830-3.160)	13.13	99
42+71	3.49	5.91	-	-	-	-	9.40 (2.90-10.00)	3.020 (0.820-3.200)	13.26	99
50+50	4.45	4.45	-	-	-	-	8.90 (2.80-9.50)	2.970 (0.840-3.130)	13.04	99
50+60	4.23	5.07	-	-	-	-	9.30 (2.90-9.90)	3.010 (0.830-3.190)	13.22	99
50+71	3.97	5.63	-	-	-	-	9.60 (2.90-10.20)	3.040 (0.810-3.230)	13.35	99
60+60	4.80	4.80	-	-	-	-	9.60 (2.90-10.20)	3.040 (0.810-3.230)	13.35	99
60+71	4.44	5.26	-	-	-	-	9.70 (2.90-10.30)	3.050 (0.810-3.240)	13.39	99
71+71	4.85	4.85	-	-	-	-	9.70 (2.90-10.30)	3.050 (0.810-3.240)	13.39	99
15+15+15	1.50	1.50	1.50	-	-	-	4.50 (2.90-6.00)	1.200 (0.950-3.280)	5.27	99
15+15+20	1.50	1.50	2.00	-	-	-	5.00 (2.90-6.80)	1.308 (0.950-3.560)	5.75	99
15+15+22	1.50	1.50	2.20	-	-	-	5.20 (2.90-7.10)	1.352 (0.950-3.670)	5.94	99
15+15+25	1.50	1.50	2.50	-	-	-	5.50 (3.00-7.50)	1.417 (0.950-3.810)	6.22	99
15+15+35	1.50	1.50	3.50	-	-	-	6.50 (3.20-8.50)	1.633 (0.900-2.500)	7.17	99
15+15+42	1.50	1.50	4.20	-	-	-	7.20 (3.20-9.20)	1.865 (0.890-3.000)	8.19	99
15+15+50	1.54	1.54	5.13	-	-	-	8.20 (3.20-9.80)	2.350 (0.890-3.400)	10.32	99
15+15+60	1.48	1.48	5.93	-	-	-	8.90 (3.30-10.40)	2.725 (0.890-3.750)	11.97	99
15+15+71	1.43	1.43	6.75	-	-	-	9.60 (3.30-11.00)	3.100 (0.890-4.110)	13.61	99
15+20+20	1.50	2.00	2.00	-	-	-	5.50 (3.00-7.50)	1.417 (0.950-3.810)	6.22	99
15+20+22	1.50	2.00	2.20	-	-	-	5.70 (3.00-7.80)	1.460 (0.950-3.910)	6.41	99
15+20+25	1.50	2.00	2.50	-	-	-	6.00 (3.00-8.30)	1.525 (0.950-4.090)	6.70	99
15+20+35	1.50	2.00	3.50	-	-	-	7.00 (3.20-8.90)	1.768 (0.890-2.790)	7.77	99
15+20+42	1.48	1.97	4.15	-	-	-	7.60 (3.20-9.60)	2.059 (0.890-3.280)	9.04	99
15+20+50	1.45	1.93	4.82	-	-	-	8.20 (3.20-10.10)	2.350 (0.890-3.580)	10.32	99
15+20+60	1.41	1.87	5.62	-	-	-	8.90 (3.30-10.60)	2.725 (0.890-3.870)	11.97	99
15+20+71	1.36	1.81	6.43	-	-	-	9.60 (3.30-11.20)	3.100 (0.890-4.230)	13.61	99
15+22+22	1.50	2.20	2.20	-	-	-	5.90 (3.00-8.10)	1.503 (0.950-4.020)	6.60	99
15+22+25	1.50	2.20	2.50	-	-	-	6.20 (3.10-8.40)	1.568 (0.930-3.300)	6.89	99
15+22+35	1.50	2.20	3.50	-	-	-	7.20 (3.20-9.20)	1.865 (0.890-3.000)	8.19	99
15+22+42	1.42	2.09	3.99	-	-	-	7.50 (3.20-9.70)	2.011 (0.890-3.340)	8.83	99
15+22+50	1.41	2.07	4.71	-	-	-	8.20 (3.20-10.20)	2.350 (0.890-3.640)	10.32	99
15+22+60	1.38	2.02	5.51	-	-	-	8.90 (3.30-10.70)	2.725 (0.890-3.930)	11.97	99
15+22+71	1.33	1.96	6.31	-	-	-	9.60 (3.30-11.20)	3.100 (0.890-4.230)	13.61	99
15+25+25	1.50	2.50	2.50	-	-	-	6.50 (3.20-8.50)	1.633 (0.900-2.500)	7.17	99
15+25+35	1.50	2.50	3.50	-	-	-	7.50 (3.20-9.50)	2.011 (0.890-3.220)	8.83	99
15+25+42	1.50	2.50	4.20	-	-	-	8.20 (3.20-9.90)	2.350 (0.890-3.460)	10.32	99
15+25+50	1.48	2.47	4.94	-	-	-	8.90 (3.30-10.40)	2.725 (0.890-3.750)	11.97	99
15+25+60	1.44	2.40	5.76	-	-	-	9.60 (3.30-10.90)	3.100 (0.890-4.050)	13.61	99
15+25+71	1.31	2.18	6.20	-	-	-	9.70 (3.30-11.30)	3.200 (0.890-4.290)	14.05	99
15+35+35	1.45	3.38	3.38	-	-	-	8.20 (3.20-10.10)	2.350 (0.890-3.580)	10.32	99
15+35+42	1.45	3.39	4.06	-	-	-	8.90 (3.30-10.50)	2.725 (0.890-3.810)	11.97	99
15+35+50	1.44	3.36	4.80	-	-	-	9.60 (3.30-10.90)	3.100 (0.890-4.050)	13.61	99
15+35+60	1.32	3.09	5.29	-	-	-	9.70 (3.30-11.30)	3.200 (0.890-4.290)	14.05	99
15+35+71	1.21	2.83	5.75	-	-	-	9.80 (3.30-11.40)	3.290 (0.890-4.360)	14.45	99
15+42+42	1.35	3.78	3.78	-	-	-	8.90 (3.30-10.90)	2.725 (0.890-4.050)	11.97	99
15+42+50	1.35	3.77	4.49	-	-	-	9.60 (3.30-11.20)	3.100 (0.890-4.230)	13.61	99
15+42+60	1.26	3.52	5.03	-	-	-	9.80 (3.30-11.40)	3.290 (0.890-4.360)	14.45	99

MXZ-6C122VA COOLING

Indoor units combination	Cooling Capacity (kW)							Outdoor unit power consumption (kW)	Current (A)	Power factor (%)
	Unit A	Unit B	Unit C	Unit D	Unit E	Unit F	Total			
15+42+71	1.17	3.28	5.55	-	-	-	10.00 (3.30-11.60)	3.423 (0.890-4.490)	15.03	99
15+50+50	1.27	4.22	4.22	-	-	-	9.70 (3.30-11.30)	3.200 (0.890-4.290)	14.05	99
15+50+60	1.19	3.96	4.75	-	-	-	9.90 (3.30-11.50)	3.357 (0.890-4.420)	14.74	99
15+50+71	1.13	3.75	5.33	-	-	-	10.20 (3.30-11.80)	3.540 (0.890-4.640)	15.55	99
15+60+60	1.13	4.53	4.53	-	-	-	10.20 (3.30-11.80)	3.540 (0.890-4.640)	15.55	99
15+60+71	1.08	4.32	5.11	-	-	-	10.50 (3.30-12.10)	3.690 (0.890-4.860)	16.21	99
15+71+71	1.03	4.88	4.88	-	-	-	10.80 (3.30-12.40)	3.711 (0.880-4.800)	16.30	99
20+20+20	2.00	2.00	2.00	-	-	-	6.00 (3.00-8.30)	1.525 (0.950-4.090)	6.70	99
20+20+22	2.00	2.00	2.20	-	-	-	6.20 (3.10-8.40)	1.568 (0.930-3.300)	6.89	99
20+20+25	2.00	2.00	2.50	-	-	-	6.50 (3.20-8.50)	1.633 (0.900-2.500)	7.17	99
20+20+35	2.00	2.00	3.50	-	-	-	7.50 (3.20-9.50)	2.011 (0.890-3.220)	8.83	99
20+20+42	2.00	2.00	4.20	-	-	-	8.20 (3.20-9.90)	2.350 (0.890-3.460)	10.32	99
20+20+50	1.98	1.98	4.94	-	-	-	8.90 (3.30-10.40)	2.725 (0.890-3.750)	11.97	99
20+20+60	1.92	1.92	5.76	-	-	-	9.60 (3.30-10.90)	3.100 (0.890-4.050)	13.61	99
20+20+71	1.75	1.75	6.20	-	-	-	9.70 (3.30-11.30)	3.200 (0.890-4.290)	14.05	99
20+22+22	2.00	2.20	2.20	-	-	-	6.40 (3.10-8.40)	1.612 (0.910-3.300)	7.08	99
20+22+25	2.00	2.20	2.50	-	-	-	6.70 (3.20-8.60)	1.677 (0.890-2.570)	7.36	99
20+22+35	1.97	2.17	3.45	-	-	-	7.60 (3.20-9.60)	2.059 (0.890-3.280)	9.04	99
20+22+42	1.95	2.15	4.10	-	-	-	8.20 (3.20-10.00)	2.350 (0.890-3.520)	10.32	99
20+22+50	1.93	2.13	4.84	-	-	-	8.90 (3.30-10.50)	2.725 (0.890-3.810)	11.97	99
20+22+60	1.88	2.07	5.65	-	-	-	9.60 (3.30-11.00)	3.100 (0.890-4.110)	13.61	99
20+22+71	1.72	1.89	6.09	-	-	-	9.70 (3.30-11.30)	3.200 (0.890-4.290)	14.05	99
20+25+25	2.00	2.50	2.50	-	-	-	7.00 (3.20-8.90)	1.768 (0.890-2.790)	7.77	99
20+25+35	2.05	2.56	3.59	-	-	-	8.20 (3.20-9.80)	2.350 (0.890-3.400)	10.32	99
20+25+42	1.89	2.36	3.96	-	-	-	8.20 (3.20-10.20)	2.350 (0.890-3.640)	10.32	99
20+25+50	1.87	2.34	4.68	-	-	-	8.90 (3.30-10.60)	2.725 (0.890-3.870)	11.97	99
20+25+60	1.83	2.29	5.49	-	-	-	9.60 (3.30-11.20)	3.100 (0.890-4.230)	13.61	99
20+25+71	1.69	2.11	6.00	-	-	-	9.80 (3.30-11.40)	3.290 (0.890-4.360)	14.45	99
20+35+35	1.98	3.46	3.46	-	-	-	8.90 (3.30-10.40)	2.725 (0.890-3.750)	11.97	99
20+35+42	1.84	3.21	3.85	-	-	-	8.90 (3.30-10.70)	2.725 (0.890-3.930)	11.97	99
20+35+50	1.83	3.20	4.57	-	-	-	9.60 (3.30-11.20)	3.100 (0.890-4.230)	13.61	99
20+35+60	1.69	2.95	5.06	-	-	-	9.70 (3.30-11.30)	3.200 (0.890-4.290)	14.05	99
20+35+71	1.57	2.75	5.58	-	-	-	9.90 (3.30-11.50)	3.357 (0.890-4.420)	14.74	99
20+42+42	1.85	3.88	3.88	-	-	-	9.60 (3.30-11.10)	3.100 (0.890-4.170)	13.61	99
20+42+50	1.73	3.64	4.33	-	-	-	9.70 (3.30-11.30)	3.200 (0.890-4.290)	14.05	99
20+42+60	1.61	3.37	4.82	-	-	-	9.80 (3.30-11.40)	3.290 (0.890-4.360)	14.45	99
20+42+71	1.52	3.19	5.39	-	-	-	10.10 (3.30-11.70)	3.490 (0.890-4.570)	15.33	99
20+50+50	1.63	4.08	4.08	-	-	-	9.80 (3.30-11.40)	3.290 (0.890-4.360)	14.45	99
20+50+60	1.54	3.85	4.62	-	-	-	10.00 (3.30-11.60)	3.423 (0.890-4.490)	15.03	99
20+50+71	1.46	3.65	5.19	-	-	-	10.30 (3.30-11.90)	3.590 (0.890-4.710)	15.77	99
20+60+60	1.47	4.41	4.41	-	-	-	10.30 (3.30-11.90)	3.590 (0.890-4.710)	15.77	99
20+60+71	1.40	4.21	4.98	-	-	-	10.60 (3.30-12.20)	3.740 (0.890-4.930)	16.43	99
20+71+71	1.36	4.82	4.82	-	-	-	11.00 (3.30-12.50)	3.682 (0.870-4.740)	16.17	99
22+22+22	2.20	2.20	2.20	-	-	-	6.60 (3.20-8.50)	1.655 (0.890-2.500)	7.27	99
22+22+25	2.20	2.20	2.50	-	-	-	6.90 (3.20-8.80)	1.720 (0.890-2.720)	7.55	99
22+22+35	2.09	2.09	3.32	-	-	-	7.50 (3.20-9.70)	2.011 (0.890-3.340)	8.83	99

MXZ-6C122VA COOLING

Indoor units combination	Cooling Capacity (kW)							Outdoor unit power consumption (kW)	Current (A)	Power factor (%)
	Unit A	Unit B	Unit C	Unit D	Unit E	Unit F	Total			
22+22+42	2.10	2.10	4.00	-	-	-	8.20 (3.20-10.10)	2.350 (0.890-3.580)	10.32	99
22+22+50	2.08	2.08	4.73	-	-	-	8.90 (3.30-10.60)	2.725 (0.890-3.870)	11.97	99
22+22+60	2.03	2.03	5.54	-	-	-	9.60 (3.30-11.10)	3.100 (0.890-4.170)	13.61	99
22+22+71	1.86	1.86	5.99	-	-	-	9.70 (3.30-11.30)	3.200 (0.890-4.290)	14.05	99
22+25+25	2.20	2.50	2.50	-	-	-	7.20 (3.20-9.20)	1.865 (0.890-3.000)	8.19	99
22+25+35	2.20	2.50	3.50	-	-	-	8.20 (3.20-9.90)	2.350 (0.890-3.460)	10.32	99
22+25+42	2.03	2.30	3.87	-	-	-	8.20 (3.20-10.30)	2.350 (0.890-3.700)	10.32	99
22+25+50	2.02	2.29	4.59	-	-	-	8.90 (3.30-10.70)	2.725 (0.890-3.930)	11.97	99
22+25+60	1.97	2.24	5.38	-	-	-	9.60 (3.30-11.20)	3.100 (0.890-4.230)	13.61	99
22+25+71	1.83	2.08	5.90	-	-	-	9.80 (3.30-11.40)	3.290 (0.890-4.360)	14.45	99
22+35+35	2.13	3.39	3.39	-	-	-	8.90 (3.30-10.50)	2.725 (0.890-3.810)	11.97	99
22+35+42	1.98	3.15	3.78	-	-	-	8.90 (3.30-10.90)	2.725 (0.890-4.050)	11.97	99
22+35+50	1.97	3.14	4.49	-	-	-	9.60 (3.30-11.20)	3.100 (0.890-4.230)	13.61	99
22+35+60	1.84	2.93	5.03	-	-	-	9.80 (3.30-11.40)	3.290 (0.890-4.360)	14.45	99
22+35+71	1.72	2.73	5.55	-	-	-	10.00 (3.30-11.60)	3.423 (0.890-4.490)	15.03	99
22+42+42	1.99	3.80	3.80	-	-	-	9.60 (3.30-11.20)	3.100 (0.890-4.230)	13.61	99
22+42+50	1.87	3.57	4.25	-	-	-	9.70 (3.30-11.30)	3.200 (0.890-4.290)	14.05	99
22+42+60	1.76	3.35	4.79	-	-	-	9.90 (3.30-11.50)	3.357 (0.890-4.420)	14.74	99
22+42+71	1.66	3.17	5.36	-	-	-	10.20 (3.30-11.80)	3.540 (0.890-4.640)	15.55	99
22+50+50	1.77	4.02	4.02	-	-	-	9.80 (3.30-11.40)	3.290 (0.890-4.360)	14.45	99
22+50+60	1.68	3.83	4.59	-	-	-	10.10 (3.30-11.70)	3.490 (0.890-4.570)	15.33	99
22+50+71	1.60	3.64	5.16	-	-	-	10.40 (3.30-12.00)	3.640 (0.890-4.780)	15.99	99
22+60+60	1.61	4.39	4.39	-	-	-	10.40 (3.30-12.00)	3.640 (0.890-4.780)	15.99	99
22+60+71	1.54	4.20	4.97	-	-	-	10.70 (3.30-12.30)	3.726 (0.890-4.870)	16.36	99
22+71+71	1.48	4.76	4.76	-	-	-	11.00 (3.30-12.60)	3.682 (0.870-4.680)	16.17	99
25+25+25	2.50	2.50	2.50	-	-	-	7.50 (3.20-9.50)	2.011 (0.890-3.220)	8.83	99
25+25+35	2.41	2.41	3.38	-	-	-	8.20 (3.20-10.10)	2.350 (0.890-3.580)	10.32	99
25+25+42	2.42	2.42	4.06	-	-	-	8.90 (3.30-10.50)	2.725 (0.890-3.810)	11.97	99
25+25+50	2.40	2.40	4.80	-	-	-	9.60 (3.30-10.90)	3.100 (0.890-4.050)	13.61	99
25+25+60	2.20	2.20	5.29	-	-	-	9.70 (3.30-11.30)	3.200 (0.890-4.290)	14.05	99
25+25+71	2.02	2.02	5.75	-	-	-	9.80 (3.30-11.40)	3.290 (0.890-4.360)	14.45	99
25+35+35	2.34	3.28	3.28	-	-	-	8.90 (3.30-10.60)	2.725 (0.890-3.870)	11.97	99
25+35+42	2.35	3.29	3.95	-	-	-	9.60 (3.30-11.00)	3.100 (0.890-4.110)	13.61	99
25+35+50	2.20	3.09	4.41	-	-	-	9.70 (3.30-11.30)	3.200 (0.890-4.290)	14.05	99
25+35+60	2.04	2.86	4.90	-	-	-	9.80 (3.30-11.40)	3.290 (0.890-4.360)	14.45	99
25+35+71	1.91	2.67	5.42	-	-	-	10.00 (3.30-11.60)	3.423 (0.890-4.490)	15.03	99
25+42+42	2.22	3.74	3.74	-	-	-	9.70 (3.30-11.30)	3.200 (0.890-4.290)	14.05	99
25+42+50	2.09	3.52	4.19	-	-	-	9.80 (3.30-11.40)	3.290 (0.890-4.360)	14.45	99
25+42+60	1.95	3.27	4.68	-	-	-	9.90 (3.30-11.50)	3.357 (0.890-4.420)	14.74	99
25+42+71	1.87	3.13	5.30	-	-	-	10.30 (3.30-11.90)	3.590 (0.890-4.710)	15.77	99
25+50+50	1.98	3.96	3.96	-	-	-	9.90 (3.30-11.50)	3.357 (0.890-4.420)	14.74	99
25+50+60	1.89	3.78	4.53	-	-	-	10.20 (3.30-11.80)	3.540 (0.890-4.640)	15.55	99
25+50+71	1.80	3.60	5.11	-	-	-	10.50 (3.30-12.10)	3.690 (0.890-4.860)	16.21	99
25+60+60	1.81	4.34	4.34	-	-	-	10.50 (3.30-12.10)	3.690 (0.890-4.860)	16.21	99
25+60+71	1.73	4.15	4.92	-	-	-	10.80 (3.30-12.40)	3.711 (0.880-4.800)	16.30	99
25+71+71	1.66	4.72	4.72	-	-	-	11.10 (3.40-12.70)	3.668 (0.870-4.610)	16.11	99

MXZ-6C122VA COOLING

Indoor units combination	Cooling Capacity (kW)							Outdoor unit power consumption (kW)	Current (A)	Power factor (%)
	Unit A	Unit B	Unit C	Unit D	Unit E	Unit F	Total			
35+35+35	3.20	3.20	3.20	-	-	-	9.60 (3.30-11.20)	3.100 (0.890-4.230)	13.61	99
35+35+42	3.03	3.03	3.64	-	-	-	9.70 (3.30-11.30)	3.200 (0.890-4.290)	14.05	99
35+35+50	2.86	2.86	4.08	-	-	-	9.80 (3.30-11.40)	3.290 (0.890-4.360)	14.45	99
35+35+60	2.69	2.69	4.62	-	-	-	10.00 (3.30-11.60)	3.423 (0.890-4.490)	15.03	99
35+35+71	2.56	2.56	5.19	-	-	-	10.30 (3.30-11.90)	3.590 (0.890-4.710)	15.77	99
35+42+42	2.88	3.46	3.46	-	-	-	9.80 (3.30-11.40)	3.290 (0.890-4.360)	14.45	99
35+42+50	2.73	3.27	3.90	-	-	-	9.90 (3.30-11.50)	3.357 (0.890-4.420)	14.74	99
35+42+60	2.61	3.13	4.47	-	-	-	10.20 (3.30-11.80)	3.540 (0.890-4.640)	15.55	99
35+42+71	2.48	2.98	5.04	-	-	-	10.50 (3.30-12.10)	3.690 (0.890-4.860)	16.21	99
35+50+50	2.64	3.78	3.78	-	-	-	10.20 (3.30-11.80)	3.540 (0.890-4.640)	15.55	99
35+50+60	2.53	3.62	4.34	-	-	-	10.50 (3.30-12.10)	3.690 (0.890-4.860)	16.21	99
35+50+71	2.42	3.46	4.92	-	-	-	10.80 (3.30-12.40)	3.711 (0.880-4.800)	16.30	99
35+60+60	2.44	4.18	4.18	-	-	-	10.80 (3.30-12.30)	3.711 (0.880-4.870)	16.30	99
35+60+71	2.34	4.01	4.75	-	-	-	11.10 (3.40-12.60)	3.668 (0.870-4.680)	16.11	99
35+71+71	2.25	4.57	4.57	-	-	-	11.40 (3.40-12.90)	3.624 (0.850-4.480)	15.92	99
42+42+42	3.30	3.30	3.30	-	-	-	9.90 (3.30-11.50)	3.357 (0.890-4.420)	14.74	99
42+42+50	3.17	3.17	3.77	-	-	-	10.10 (3.30-11.70)	3.490 (0.890-4.570)	15.33	99
42+42+60	3.03	3.03	4.33	-	-	-	10.40 (3.30-12.00)	3.640 (0.890-4.780)	15.99	99
42+42+71	2.93	2.93	4.95	-	-	-	10.80 (3.30-12.30)	3.711 (0.880-4.870)	16.30	99
42+50+50	3.08	3.66	3.66	-	-	-	10.40 (3.30-12.00)	3.640 (0.890-4.780)	15.99	99
42+50+60	2.96	3.52	4.22	-	-	-	10.70 (3.30-12.30)	3.726 (0.890-4.870)	16.36	99
42+50+71	2.83	3.37	4.79	-	-	-	11.00 (3.30-12.50)	3.682 (0.870-4.740)	16.17	99
42+60+60	2.85	4.07	4.07	-	-	-	11.00 (3.30-12.50)	3.682 (0.870-4.740)	16.17	99
42+60+71	2.74	3.92	4.64	-	-	-	11.30 (3.40-12.80)	3.639 (0.860-4.550)	15.98	99
50+50+50	3.53	3.53	3.53	-	-	-	10.60 (3.30-12.20)	3.740 (0.890-4.930)	16.43	99
50+50+60	3.41	3.41	4.09	-	-	-	10.90 (3.30-12.50)	3.697 (0.880-4.740)	16.23	99
50+50+71	3.27	3.27	4.65	-	-	-	11.20 (3.40-12.80)	3.653 (0.860-4.550)	16.04	99
50+60+60	3.29	3.95	3.95	-	-	-	11.20 (3.40-12.70)	3.653 (0.860-4.610)	16.04	99
60+60+60	3.83	3.83	3.83	-	-	-	11.50 (3.40-13.00)	3.610 (0.850-4.420)	15.85	99
15+15+15+15	1.50	1.50	1.50	1.50	-	-	6.00 (3.10-8.40)	1.450 (0.910-4.130)	6.37	99
15+15+15+20	1.50	1.50	1.50	2.00	-	-	6.50 (3.10-9.00)	1.653 (0.910-4.190)	7.26	99
15+15+15+22	1.50	1.50	1.50	2.20	-	-	6.70 (3.10-9.20)	1.734 (0.910-4.210)	7.61	99
15+15+15+25	1.50	1.50	1.50	2.50	-	-	7.00 (3.10-9.50)	1.855 (0.910-4.240)	8.15	99
15+15+15+35	1.50	1.50	1.50	3.50	-	-	8.00 (3.10-10.60)	2.240 (0.910-4.340)	9.84	99
15+15+15+42	1.50	1.50	1.50	4.20	-	-	8.70 (3.30-11.00)	2.380 (0.880-3.850)	10.45	99
15+15+15+50	1.50	1.50	1.50	5.00	-	-	9.50 (3.30-11.50)	2.703 (0.870-3.980)	11.87	99
15+15+15+60	1.44	1.44	1.44	5.77	-	-	10.10 (3.30-11.90)	3.092 (0.870-4.100)	13.58	99
15+15+15+71	1.33	1.33	1.33	6.30	-	-	10.30 (3.30-12.00)	3.172 (0.870-4.140)	13.93	99
15+15+20+20	1.50	1.50	2.00	2.00	-	-	7.00 (3.10-9.50)	1.855 (0.910-4.240)	8.15	99
15+15+20+22	1.50	1.50	2.00	2.20	-	-	7.20 (3.10-9.70)	1.936 (0.910-4.250)	8.50	99
15+15+20+25	1.50	1.50	2.00	2.50	-	-	7.50 (3.10-10.10)	2.058 (0.910-4.290)	9.04	99
15+15+20+35	1.50	1.50	2.00	3.50	-	-	8.50 (3.20-10.90)	2.340 (0.890-3.970)	10.28	99
15+15+20+42	1.50	1.50	2.00	4.20	-	-	9.20 (3.30-11.30)	2.545 (0.870-3.930)	11.18	99
15+15+20+50	1.50	1.50	2.00	5.00	-	-	10.00 (3.30-11.80)	2.965 (0.870-4.050)	13.02	99
15+15+20+60	1.39	1.39	1.85	5.56	-	-	10.20 (3.30-12.00)	3.128 (0.870-4.140)	13.74	99
15+15+20+71	1.29	1.29	1.72	6.10	-	-	10.40 (3.40-12.10)	3.208 (0.870-4.190)	14.09	99

MXZ-6C122VA COOLING

Indoor units combination	Cooling Capacity (kW)							Outdoor unit power consumption (kW)	Current (A)	Power factor (%)
	Unit A	Unit B	Unit C	Unit D	Unit E	Unit F	Total			
15+15+22+22	1.50	1.50	2.20	2.20	-	-	7.40 (3.10-9.90)	2.017 (0.910-4.290)	8.86	99
15+15+22+25	1.50	1.50	2.20	2.50	-	-	7.70 (3.10-10.30)	2.139 (0.910-4.310)	9.39	99
15+15+22+35	1.50	1.50	2.20	3.50	-	-	8.70 (3.30-11.00)	2.380 (0.880-3.850)	10.45	99
15+15+22+42	1.50	1.50	2.20	4.20	-	-	9.40 (3.30-11.40)	2.650 (0.870-3.950)	11.64	99
15+15+22+50	1.47	1.47	2.16	4.90	-	-	10.00 (3.30-11.80)	3.070 (0.870-4.050)	13.48	99
15+15+22+60	1.37	1.37	2.00	5.46	-	-	10.20 (3.30-12.00)	3.143 (0.870-4.140)	13.80	99
15+15+22+71	1.27	1.27	1.86	6.00	-	-	10.40 (3.40-12.10)	3.223 (0.870-4.190)	14.15	99
15+15+25+25	1.50	1.50	2.50	2.50	-	-	8.00 (3.10-10.60)	2.240 (0.910-4.340)	9.84	99
15+15+25+35	1.50	1.50	2.50	3.50	-	-	9.00 (3.30-11.10)	2.440 (0.870-3.880)	10.72	99
15+15+25+42	1.50	1.50	2.50	4.20	-	-	9.70 (3.30-11.60)	2.808 (0.870-4.000)	12.33	99
15+15+25+50	1.44	1.44	2.40	4.81	-	-	10.10 (3.30-11.90)	3.092 (0.870-4.100)	13.58	99
15+15+25+60	1.34	1.34	2.24	5.37	-	-	10.30 (3.30-12.00)	3.165 (0.870-4.140)	13.90	99
15+15+25+71	1.25	1.25	2.08	5.92	-	-	10.50 (3.40-12.20)	3.246 (0.870-4.240)	14.26	99
15+15+35+35	1.50	1.50	3.50	3.50	-	-	10.00 (3.30-11.80)	2.965 (0.870-4.050)	13.02	99
15+15+35+42	1.42	1.42	3.30	3.96	-	-	10.10 (3.30-11.90)	3.106 (0.870-4.100)	13.64	99
15+15+35+50	1.34	1.34	3.13	4.48	-	-	10.30 (3.30-12.00)	3.165 (0.870-4.140)	13.90	99
15+15+35+60	1.25	1.25	2.91	4.99	-	-	10.40 (3.40-12.20)	3.238 (0.870-4.240)	14.22	99
15+15+35+71	1.17	1.17	2.73	5.53	-	-	10.60 (3.40-12.30)	3.326 (0.870-4.280)	14.61	99
15+15+42+42	1.34	1.34	3.76	3.76	-	-	10.20 (3.30-12.00)	3.157 (0.870-4.140)	13.87	99
15+15+42+50	1.28	1.28	3.58	4.26	-	-	10.40 (3.40-12.10)	3.215 (0.870-4.190)	14.12	99
15+15+42+60	1.20	1.20	3.37	4.82	-	-	10.60 (3.40-12.30)	3.294 (0.870-4.280)	14.47	99
15+15+42+71	1.12	1.12	3.14	5.31	-	-	10.70 (3.40-12.40)	3.358 (0.870-4.330)	14.75	99
15+15+50+50	1.21	1.21	4.04	4.04	-	-	10.50 (3.40-12.30)	3.278 (0.870-4.280)	14.40	99
15+15+50+60	1.15	1.15	3.82	4.59	-	-	10.70 (3.40-12.40)	3.352 (0.870-4.330)	14.72	99
15+15+50+71	1.06	1.06	3.54	5.03	-	-	10.70 (3.40-12.40)	3.374 (0.870-4.330)	14.82	99
15+15+60+60	1.07	1.07	4.28	4.28	-	-	10.70 (3.40-12.40)	3.372 (0.870-4.330)	14.81	99
15+15+60+71	1.01	1.01	4.02	4.76	-	-	10.80 (3.40-12.50)	3.380 (0.870-4.400)	14.84	99
15+15+71+71	0.94	0.94	4.46	4.46	-	-	10.80 (3.40-12.50)	3.618 (0.870-4.400)	15.89	99
15+20+20+20	1.50	2.00	2.00	2.00	-	-	7.50 (3.10-10.10)	2.058 (0.910-4.290)	9.04	99
15+20+20+22	1.50	2.00	2.00	2.20	-	-	7.70 (3.10-10.30)	2.139 (0.910-4.310)	9.39	99
15+20+20+25	1.50	2.00	2.00	2.50	-	-	8.00 (3.10-10.60)	2.240 (0.910-4.340)	9.84	99
15+20+20+35	1.50	2.00	2.00	3.50	-	-	9.00 (3.30-11.10)	2.440 (0.870-3.880)	10.72	99
15+20+20+42	1.50	2.00	2.00	4.20	-	-	9.70 (3.30-11.60)	2.808 (0.870-4.000)	12.33	99
15+20+20+50	1.44	1.92	1.92	4.81	-	-	10.10 (3.30-11.90)	3.092 (0.870-4.100)	13.58	99
15+20+20+60	1.34	1.79	1.79	5.37	-	-	10.30 (3.30-12.00)	3.165 (0.870-4.140)	13.90	99
15+20+20+71	1.25	1.67	1.67	5.92	-	-	10.50 (3.40-12.20)	3.246 (0.870-4.240)	14.26	99
15+20+22+22	1.50	2.00	2.20	2.20	-	-	7.90 (3.10-10.50)	2.220 (0.910-4.330)	9.75	99
15+20+22+25	1.50	2.00	2.20	2.50	-	-	8.20 (3.20-10.70)	2.280 (0.900-4.220)	10.01	99
15+20+22+35	1.50	2.00	2.20	3.50	-	-	9.20 (3.30-11.30)	2.545 (0.870-3.930)	11.18	99
15+20+22+42	1.50	2.00	2.20	4.20	-	-	9.90 (3.30-11.70)	2.913 (0.870-4.030)	12.79	99
15+20+22+50	1.42	1.89	2.08	4.72	-	-	10.10 (3.30-11.90)	3.106 (0.870-4.100)	13.64	99
15+20+22+60	1.32	1.76	1.94	5.28	-	-	10.30 (3.30-12.10)	3.179 (0.870-4.190)	13.96	99
15+20+22+71	1.23	1.64	1.80	5.82	-	-	10.50 (3.40-12.20)	3.262 (0.870-4.240)	14.33	99
15+20+25+25	1.50	2.00	2.50	2.50	-	-	8.50 (3.20-10.90)	2.340 (0.890-3.970)	10.28	99
15+20+25+35	1.50	2.00	2.50	3.50	-	-	9.50 (3.30-11.50)	2.703 (0.870-3.980)	11.87	99
15+20+25+42	1.47	1.96	2.45	4.12	-	-	10.00 (3.30-11.80)	3.070 (0.870-4.050)	13.48	99

MXZ-6C122VA COOLING

Indoor units combination	Cooling Capacity (kW)							Outdoor unit power consumption (kW)	Current (A)	Power factor (%)
	Unit A	Unit B	Unit C	Unit D	Unit E	Unit F	Total			
15+20+25+50	1.39	1.85	2.32	4.64	-	-	10.20 (3.30-12.00)	3.128 (0.870-4.140)	13.74	99
15+20+25+60	1.30	1.73	2.17	5.20	-	-	10.40 (3.40-12.10)	3.201 (0.870-4.190)	14.06	99
15+20+25+71	1.20	1.60	2.00	5.69	-	-	10.50 (3.40-12.30)	3.286 (0.870-4.280)	14.43	99
15+20+35+35	1.44	1.92	3.37	3.37	-	-	10.10 (3.30-11.90)	3.092 (0.870-4.100)	13.58	99
15+20+35+42	1.37	1.82	3.19	3.83	-	-	10.20 (3.30-12.00)	3.143 (0.870-4.140)	13.80	99
15+20+35+50	1.30	1.73	3.03	4.33	-	-	10.40 (3.40-12.10)	3.201 (0.870-4.190)	14.06	99
15+20+35+60	1.21	1.62	2.83	4.85	-	-	10.50 (3.40-12.30)	3.278 (0.870-4.280)	14.40	99
15+20+35+71	1.14	1.52	2.66	5.39	-	-	10.70 (3.40-12.40)	3.354 (0.870-4.330)	14.73	99
15+20+42+42	1.30	1.73	3.64	3.64	-	-	10.30 (3.30-12.10)	3.194 (0.870-4.190)	14.03	99
15+20+42+50	1.24	1.65	3.47	4.13	-	-	10.50 (3.40-12.20)	3.254 (0.870-4.240)	14.29	99
15+20+42+60	1.16	1.55	3.25	4.64	-	-	10.60 (3.40-12.40)	3.334 (0.870-4.330)	14.64	99
15+20+42+71	1.08	1.45	3.04	5.13	-	-	10.70 (3.40-12.40)	3.368 (0.870-4.330)	14.79	99
15+20+50+50	1.18	1.57	3.93	3.93	-	-	10.60 (3.40-12.30)	3.318 (0.870-4.280)	14.57	99
15+20+50+60	1.11	1.48	3.69	4.43	-	-	10.70 (3.40-12.40)	3.362 (0.870-4.330)	14.77	99
15+20+50+71	1.04	1.38	3.46	4.92	-	-	10.80 (3.40-12.50)	3.380 (0.870-4.400)	14.84	99
15+20+60+60	1.05	1.39	4.18	4.18	-	-	10.80 (3.40-12.50)	3.380 (0.870-4.400)	14.84	99
15+20+60+71	0.98	1.30	3.90	4.62	-	-	10.80 (3.40-12.50)	3.380 (0.870-4.400)	14.84	99
15+20+71+71	0.92	1.22	4.33	4.33	-	-	10.80 (3.40-12.50)	3.857 (0.870-4.400)	16.94	99
15+22+22+22	1.50	2.20	2.20	2.20	-	-	8.10 (3.10-10.70)	2.260 (0.910-4.220)	9.93	99
15+22+22+25	1.50	2.20	2.20	2.50	-	-	8.40 (3.20-10.80)	2.320 (0.890-4.100)	10.19	99
15+22+22+35	1.50	2.20	2.20	3.50	-	-	9.40 (3.30-11.40)	2.650 (0.870-3.950)	11.64	99
15+22+22+42	1.49	2.18	2.18	4.16	-	-	10.00 (3.30-11.80)	3.018 (0.870-4.050)	13.25	99
15+22+22+50	1.40	2.06	2.06	4.68	-	-	10.20 (3.30-11.90)	3.121 (0.870-4.100)	13.71	99
15+22+22+60	1.30	1.90	1.90	5.19	-	-	10.30 (3.30-12.10)	3.194 (0.870-4.190)	14.03	99
15+22+22+71	1.21	1.78	1.78	5.73	-	-	10.50 (3.40-12.30)	3.278 (0.870-4.280)	14.40	99
15+22+25+25	1.50	2.20	2.50	2.50	-	-	8.70 (3.30-11.00)	2.380 (0.880-3.850)	10.45	99
15+22+25+35	1.50	2.20	2.50	3.50	-	-	9.70 (3.30-11.60)	2.808 (0.870-4.000)	12.33	99
15+22+25+42	1.46	2.14	2.43	4.08	-	-	10.10 (3.30-11.90)	3.085 (0.870-4.100)	13.55	99
15+22+25+50	1.37	2.00	2.28	4.55	-	-	10.20 (3.30-12.00)	3.143 (0.870-4.140)	13.80	99
15+22+25+60	1.28	1.88	2.13	5.11	-	-	10.40 (3.40-12.10)	3.215 (0.870-4.190)	14.12	99
15+22+25+71	1.20	1.75	1.99	5.66	-	-	10.60 (3.40-12.30)	3.302 (0.870-4.280)	14.50	99
15+22+35+35	1.42	2.08	3.30	3.30	-	-	10.10 (3.30-11.90)	3.106 (0.870-4.100)	13.64	99
15+22+35+42	1.34	1.97	3.13	3.76	-	-	10.20 (3.30-12.00)	3.157 (0.870-4.140)	13.87	99
15+22+35+50	1.28	1.88	2.98	4.26	-	-	10.40 (3.40-12.10)	3.215 (0.870-4.190)	14.12	99
15+22+35+60	1.20	1.77	2.81	4.82	-	-	10.60 (3.40-12.30)	3.294 (0.870-4.280)	14.47	99
15+22+35+71	1.12	1.65	2.62	5.31	-	-	10.70 (3.40-12.40)	3.358 (0.870-4.330)	14.75	99
15+22+42+42	1.29	1.89	3.61	3.61	-	-	10.40 (3.40-12.10)	3.208 (0.870-4.190)	14.09	99
15+22+42+50	1.22	1.79	3.42	4.07	-	-	10.50 (3.40-12.20)	3.270 (0.870-4.240)	14.36	99
15+22+42+60	1.15	1.69	3.23	4.62	-	-	10.70 (3.40-12.40)	3.350 (0.870-4.330)	14.71	99
15+22+42+71	1.07	1.57	3.00	5.06	-	-	10.70 (3.40-12.40)	3.372 (0.870-4.330)	14.81	99
15+22+50+50	1.16	1.70	3.87	3.87	-	-	10.60 (3.40-12.40)	3.334 (0.870-4.330)	14.64	99
15+22+50+60	1.09	1.60	3.64	4.37	-	-	10.70 (3.40-12.40)	3.366 (0.870-4.330)	14.78	99
15+22+50+71	1.03	1.50	3.42	4.85	-	-	10.80 (3.40-12.50)	3.380 (0.870-4.400)	14.84	99
15+22+60+60	1.03	1.51	4.13	4.13	-	-	10.80 (3.40-12.50)	3.380 (0.870-4.400)	14.84	99
15+22+60+71	0.96	1.41	3.86	4.56	-	-	10.80 (3.40-12.50)	3.428 (0.870-4.400)	15.05	99
15+22+71+71	0.91	1.33	4.28	4.28	-	-	10.80 (3.40-12.50)	3.952 (0.870-4.400)	17.36	99

MXZ-6C122VA COOLING

Indoor units combination	Cooling Capacity (kW)							Outdoor unit power consumption (kW)	Current (A)	Power factor (%)
	Unit A	Unit B	Unit C	Unit D	Unit E	Unit F	Total			
15+25+25+25	1.50	2.50	2.50	2.50	-	-	9.00 (3.30-11.10)	2.440 (0.870-3.880)	10.72	99
15+25+25+35	1.50	2.50	2.50	3.50	-	-	10.00 (3.30-11.80)	2.965 (0.870-4.050)	13.02	99
15+25+25+42	1.42	2.36	2.36	3.96	-	-	10.10 (3.30-11.90)	3.106 (0.870-4.100)	13.64	99
15+25+25+50	1.34	2.24	2.24	4.48	-	-	10.30 (3.30-12.00)	3.165 (0.870-4.140)	13.90	99
15+25+25+60	1.25	2.08	2.08	4.99	-	-	10.40 (3.40-12.20)	3.238 (0.870-4.240)	14.22	99
15+25+25+71	1.17	1.95	1.95	5.53	-	-	10.60 (3.40-12.30)	3.326 (0.870-4.280)	14.61	99
15+25+35+35	1.39	2.32	3.25	3.25	-	-	10.20 (3.30-12.00)	3.128 (0.870-4.140)	13.74	99
15+25+35+42	1.32	2.20	3.08	3.70	-	-	10.30 (3.30-12.10)	3.179 (0.870-4.190)	13.96	99
15+25+35+50	1.25	2.08	2.91	4.16	-	-	10.40 (3.40-12.20)	3.238 (0.870-4.240)	14.22	99
15+25+35+60	1.18	1.96	2.75	4.71	-	-	10.60 (3.40-12.30)	3.318 (0.870-4.280)	14.57	99
15+25+35+71	1.10	1.83	2.57	5.20	-	-	10.70 (3.40-12.40)	3.364 (0.870-4.330)	14.77	99
15+25+42+42	1.26	2.10	3.52	3.52	-	-	10.40 (3.40-12.20)	3.230 (0.870-4.240)	14.19	99
15+25+42+50	1.20	2.01	3.37	4.02	-	-	10.60 (3.40-12.30)	3.294 (0.870-4.280)	14.47	99
15+25+42+60	1.13	1.88	3.16	4.52	-	-	10.70 (3.40-12.40)	3.356 (0.870-4.330)	14.74	99
15+25+42+71	1.05	1.75	2.94	4.97	-	-	10.70 (3.40-12.40)	3.378 (0.870-4.330)	14.84	99
15+25+50+50	1.15	1.91	3.82	3.82	-	-	10.70 (3.40-12.40)	3.352 (0.870-4.330)	14.72	99
15+25+50+60	1.07	1.78	3.57	4.28	-	-	10.70 (3.40-12.40)	3.372 (0.870-4.330)	14.81	99
15+25+50+71	1.01	1.68	3.35	4.76	-	-	10.80 (3.40-12.50)	3.380 (0.870-4.400)	14.84	99
15+25+60+60	1.01	1.69	4.05	4.05	-	-	10.80 (3.40-12.50)	3.380 (0.870-4.400)	14.84	99
15+25+60+71	0.95	1.58	3.79	4.48	-	-	10.80 (3.40-12.50)	3.571 (0.870-4.400)	15.68	99
15+35+35+35	1.30	3.03	3.03	3.03	-	-	10.40 (3.40-12.10)	3.201 (0.870-4.190)	14.06	99
15+35+35+42	1.24	2.89	2.89	3.47	-	-	10.50 (3.40-12.20)	3.254 (0.870-4.240)	14.29	99
15+35+35+50	1.18	2.75	2.75	3.93	-	-	10.60 (3.40-12.30)	3.318 (0.870-4.280)	14.57	99
15+35+35+60	1.11	2.58	2.58	4.43	-	-	10.70 (3.40-12.40)	3.362 (0.870-4.330)	14.77	99
15+35+35+71	1.04	2.42	2.42	4.92	-	-	10.80 (3.40-12.50)	3.380 (0.870-4.400)	14.84	99
15+35+42+42	1.19	2.77	3.32	3.32	-	-	10.60 (3.40-12.30)	3.310 (0.870-4.280)	14.54	99
15+35+42+50	1.13	2.64	3.16	3.77	-	-	10.70 (3.40-12.40)	3.356 (0.870-4.330)	14.74	99
15+35+42+60	1.06	2.46	2.96	4.22	-	-	10.70 (3.40-12.40)	3.376 (0.870-4.330)	14.83	99
15+35+42+71	0.99	2.32	2.78	4.70	-	-	10.80 (3.40-12.50)	3.380 (0.870-4.400)	14.84	99
15+35+50+50	1.07	2.50	3.57	3.57	-	-	10.70 (3.40-12.40)	3.372 (0.870-4.330)	14.81	99
15+35+50+60	1.01	2.36	3.38	4.05	-	-	10.80 (3.40-12.50)	3.380 (0.870-4.400)	14.84	99
15+35+50+71	0.95	2.21	3.16	4.48	-	-	10.80 (3.40-12.50)	3.571 (0.870-4.400)	15.68	99
15+35+60+60	0.95	2.22	3.81	3.81	-	-	10.80 (3.40-12.50)	3.523 (0.870-4.400)	15.47	99
15+42+42+42	1.14	3.19	3.19	3.19	-	-	10.70 (3.40-12.40)	3.354 (0.870-4.330)	14.73	99
15+42+42+50	1.08	3.02	3.02	3.59	-	-	10.70 (3.40-12.40)	3.370 (0.870-4.330)	14.80	99
15+42+42+60	1.02	2.85	2.85	4.08	-	-	10.80 (3.40-12.50)	3.380 (0.870-4.400)	14.84	99
15+42+42+71	0.95	2.67	2.67	4.51	-	-	10.80 (3.40-12.50)	3.523 (0.870-4.400)	15.47	99
15+42+50+50	1.03	2.89	3.44	3.44	-	-	10.80 (3.40-12.50)	3.380 (0.870-4.400)	14.84	99
15+42+50+60	0.97	2.72	3.23	3.88	-	-	10.80 (3.40-12.50)	3.380 (0.870-4.400)	14.84	99
15+42+50+71	0.91	2.55	3.03	4.31	-	-	10.80 (3.40-12.50)	3.905 (0.870-4.400)	17.15	99
15+42+60+60	0.92	2.56	3.66	3.66	-	-	10.80 (3.40-12.50)	3.857 (0.870-4.400)	16.94	99
15+50+50+50	0.98	3.27	3.27	3.27	-	-	10.80 (3.40-12.50)	3.380 (0.870-4.400)	14.84	99
15+50+50+60	0.93	3.09	3.09	3.70	-	-	10.80 (3.40-12.50)	3.762 (0.870-4.400)	16.52	99
20+20+20+20	2.00	2.00	2.00	2.00	-	-	8.00 (3.10-10.60)	2.240 (0.910-4.340)	9.84	99
20+20+20+22	2.00	2.00	2.00	2.20	-	-	8.20 (3.20-10.70)	2.280 (0.900-4.220)	10.01	99
20+20+20+25	2.00	2.00	2.00	2.50	-	-	8.50 (3.20-10.90)	2.340 (0.890-3.970)	10.28	99

MXZ-6C122VA COOLING

Indoor units combination	Cooling Capacity (kW)							Outdoor unit power consumption (kW)	Current (A)	Power factor (%)
	Unit A	Unit B	Unit C	Unit D	Unit E	Unit F	Total			
20+20+20+35	2.00	2.00	2.00	3.50	-	-	9.50 (3.30-11.50)	2.703 (0.870-3.980)	11.87	99
20+20+20+42	1.96	1.96	1.96	4.12	-	-	10.00 (3.30-11.80)	3.070 (0.870-4.050)	13.48	99
20+20+20+50	1.85	1.85	1.85	4.64	-	-	10.20 (3.30-12.00)	3.128 (0.870-4.140)	13.74	99
20+20+20+60	1.73	1.73	1.73	5.20	-	-	10.40 (3.40-12.10)	3.201 (0.870-4.190)	14.06	99
20+20+20+71	1.60	1.60	1.60	5.69	-	-	10.50 (3.40-12.30)	3.286 (0.870-4.280)	14.43	99
20+20+22+22	2.00	2.00	2.20	2.20	-	-	8.40 (3.20-10.80)	2.320 (0.890-4.100)	10.19	99
20+20+22+25	2.00	2.00	2.20	2.50	-	-	8.70 (3.30-11.00)	2.380 (0.880-3.850)	10.45	99
20+20+22+35	2.00	2.00	2.20	3.50	-	-	9.70 (3.30-11.60)	2.808 (0.870-4.000)	12.33	99
20+20+22+42	1.94	1.94	2.14	4.08	-	-	10.10 (3.30-11.90)	3.085 (0.870-4.100)	13.55	99
20+20+22+50	1.82	1.82	2.00	4.55	-	-	10.20 (3.30-12.00)	3.143 (0.870-4.140)	13.80	99
20+20+22+60	1.70	1.70	1.88	5.11	-	-	10.40 (3.40-12.10)	3.215 (0.870-4.190)	14.12	99
20+20+22+71	1.59	1.59	1.75	5.66	-	-	10.60 (3.40-12.30)	3.302 (0.870-4.280)	14.50	99
20+20+25+25	2.00	2.00	2.50	2.50	-	-	9.00 (3.30-11.10)	2.440 (0.870-3.880)	10.72	99
20+20+25+35	2.00	2.00	2.50	3.50	-	-	10.00 (3.30-11.80)	2.965 (0.870-4.050)	13.02	99
20+20+25+42	1.89	1.89	2.36	3.96	-	-	10.10 (3.30-11.90)	3.106 (0.870-4.100)	13.64	99
20+20+25+50	1.79	1.79	2.24	4.48	-	-	10.30 (3.30-12.00)	3.165 (0.870-4.140)	13.90	99
20+20+25+60	1.66	1.66	2.08	4.99	-	-	10.40 (3.40-12.20)	3.238 (0.870-4.240)	14.22	99
20+20+25+71	1.56	1.56	1.95	5.53	-	-	10.60 (3.40-12.30)	3.326 (0.870-4.280)	14.61	99
20+20+35+35	1.85	1.85	3.25	3.25	-	-	10.20 (3.30-12.00)	3.128 (0.870-4.140)	13.74	99
20+20+35+42	1.76	1.76	3.08	3.70	-	-	10.30 (3.30-12.10)	3.179 (0.870-4.190)	13.96	99
20+20+35+50	1.66	1.66	2.91	4.16	-	-	10.40 (3.40-12.20)	3.238 (0.870-4.240)	14.22	99
20+20+35+60	1.57	1.57	2.75	4.71	-	-	10.60 (3.40-12.30)	3.318 (0.870-4.280)	14.57	99
20+20+35+71	1.47	1.47	2.57	5.20	-	-	10.70 (3.40-12.40)	3.364 (0.870-4.330)	14.77	99
20+20+42+42	1.68	1.68	3.52	3.52	-	-	10.40 (3.40-12.20)	3.230 (0.870-4.240)	14.19	99
20+20+42+50	1.61	1.61	3.37	4.02	-	-	10.60 (3.40-12.30)	3.294 (0.870-4.280)	14.47	99
20+20+42+60	1.51	1.51	3.16	4.52	-	-	10.70 (3.40-12.40)	3.356 (0.870-4.330)	14.74	99
20+20+42+71	1.40	1.40	2.94	4.97	-	-	10.70 (3.40-12.40)	3.378 (0.870-4.330)	14.84	99
20+20+50+50	1.53	1.53	3.82	3.82	-	-	10.70 (3.40-12.40)	3.352 (0.870-4.330)	14.72	99
20+20+50+60	1.43	1.43	3.57	4.28	-	-	10.70 (3.40-12.40)	3.372 (0.870-4.330)	14.81	99
20+20+50+71	1.34	1.34	3.35	4.76	-	-	10.80 (3.40-12.50)	3.380 (0.870-4.400)	14.84	99
20+20+60+60	1.35	1.35	4.05	4.05	-	-	10.80 (3.40-12.50)	3.380 (0.870-4.400)	14.84	99
20+20+60+71	1.26	1.26	3.79	4.48	-	-	10.80 (3.40-12.50)	3.571 (0.870-4.400)	15.68	99
20+22+22+22	2.00	2.20	2.20	2.20	-	-	8.60 (3.30-10.90)	2.360 (0.880-3.970)	10.36	99
20+22+22+25	2.00	2.20	2.20	2.50	-	-	8.90 (3.30-11.10)	2.420 (0.870-3.880)	10.63	99
20+22+22+35	2.00	2.20	2.20	3.50	-	-	9.90 (3.30-11.70)	2.913 (0.870-4.030)	12.79	99
20+22+22+42	1.91	2.10	2.10	4.00	-	-	10.10 (3.30-11.90)	3.099 (0.870-4.100)	13.61	99
20+22+22+50	1.79	1.97	1.97	4.47	-	-	10.20 (3.30-12.00)	3.157 (0.870-4.140)	13.87	99
20+22+22+60	1.68	1.85	1.85	5.03	-	-	10.40 (3.40-12.20)	3.230 (0.870-4.240)	14.19	99
20+22+22+71	1.57	1.73	1.73	5.57	-	-	10.60 (3.40-12.30)	3.318 (0.870-4.280)	14.57	99
20+22+25+25	2.00	2.20	2.50	2.50	-	-	9.20 (3.30-11.30)	2.545 (0.870-3.930)	11.18	99
20+22+25+35	1.96	2.16	2.45	3.43	-	-	10.00 (3.30-11.80)	3.070 (0.870-4.050)	13.48	99
20+22+25+42	1.87	2.06	2.34	3.93	-	-	10.20 (3.30-11.90)	3.121 (0.870-4.100)	13.71	99
20+22+25+50	1.76	1.94	2.20	4.40	-	-	10.30 (3.30-12.10)	3.179 (0.870-4.190)	13.96	99
20+22+25+60	1.65	1.82	2.07	4.96	-	-	10.50 (3.40-12.20)	3.254 (0.870-4.240)	14.29	99
20+22+25+71	1.55	1.71	1.94	5.51	-	-	10.70 (3.40-12.40)	3.342 (0.870-4.330)	14.68	99
20+22+35+35	1.82	2.00	3.19	3.19	-	-	10.20 (3.30-12.00)	3.143 (0.870-4.140)	13.80	99

MXZ-6C122VA COOLING

Indoor units combination	Cooling Capacity (kW)							Outdoor unit power consumption (kW)	Current (A)	Power factor (%)
	Unit A	Unit B	Unit C	Unit D	Unit E	Unit F	Total			
20+22+35+42	1.73	1.90	3.03	3.64	-	-	10.30 (3.30-12.10)	3.194 (0.870-4.190)	14.03	99
20+22+35+50	1.65	1.82	2.89	4.13	-	-	10.50 (3.40-12.20)	3.254 (0.870-4.240)	14.29	99
20+22+35+60	1.55	1.70	2.71	4.64	-	-	10.60 (3.40-12.40)	3.334 (0.870-4.330)	14.64	99
20+22+35+71	1.45	1.59	2.53	5.13	-	-	10.70 (3.40-12.40)	3.368 (0.870-4.330)	14.79	99
20+22+42+42	1.67	1.83	3.50	3.50	-	-	10.50 (3.40-12.20)	3.246 (0.870-4.240)	14.26	99
20+22+42+50	1.58	1.74	3.32	3.96	-	-	10.60 (3.40-12.30)	3.310 (0.870-4.280)	14.54	99
20+22+42+60	1.49	1.63	3.12	4.46	-	-	10.70 (3.40-12.40)	3.360 (0.870-4.330)	14.76	99
20+22+42+71	1.39	1.53	2.93	4.95	-	-	10.80 (3.40-12.50)	3.380 (0.870-4.400)	14.84	99
20+22+50+50	1.51	1.66	3.77	3.77	-	-	10.70 (3.40-12.40)	3.356 (0.870-4.330)	14.74	99
20+22+50+60	1.41	1.55	3.52	4.22	-	-	10.70 (3.40-12.40)	3.376 (0.870-4.330)	14.83	99
20+22+50+71	1.33	1.46	3.31	4.70	-	-	10.80 (3.40-12.50)	3.380 (0.870-4.400)	14.84	99
20+22+60+60	1.33	1.47	4.00	4.00	-	-	10.80 (3.40-12.50)	3.380 (0.870-4.400)	14.84	99
20+22+60+71	1.25	1.37	3.75	4.43	-	-	10.80 (3.40-12.50)	3.666 (0.870-4.400)	16.10	99
20+25+25+25	2.00	2.50	2.50	2.50	-	-	9.50 (3.30-11.50)	2.703 (0.870-3.980)	11.87	99
20+25+25+35	1.92	2.40	2.40	3.37	-	-	10.10 (3.30-11.90)	3.092 (0.870-4.100)	13.58	99
20+25+25+42	1.82	2.28	2.28	3.83	-	-	10.20 (3.30-12.00)	3.143 (0.870-4.140)	13.80	99
20+25+25+50	1.73	2.17	2.17	4.33	-	-	10.40 (3.40-12.10)	3.201 (0.870-4.190)	14.06	99
20+25+25+60	1.62	2.02	2.02	4.85	-	-	10.50 (3.40-12.30)	3.278 (0.870-4.280)	14.40	99
20+25+25+71	1.52	1.90	1.90	5.39	-	-	10.70 (3.40-12.40)	3.354 (0.870-4.330)	14.73	99
20+25+35+35	1.79	2.24	3.13	3.13	-	-	10.30 (3.30-12.00)	3.165 (0.870-4.140)	13.90	99
20+25+35+42	1.70	2.13	2.98	3.58	-	-	10.40 (3.40-12.10)	3.215 (0.870-4.190)	14.12	99
20+25+35+50	1.62	2.02	2.83	4.04	-	-	10.50 (3.40-12.30)	3.278 (0.870-4.280)	14.40	99
20+25+35+60	1.53	1.91	2.68	4.59	-	-	10.70 (3.40-12.40)	3.352 (0.870-4.330)	14.72	99
20+25+35+71	1.42	1.77	2.48	5.03	-	-	10.70 (3.40-12.40)	3.374 (0.870-4.330)	14.82	99
20+25+42+42	1.63	2.03	3.42	3.42	-	-	10.50 (3.40-12.20)	3.270 (0.870-4.240)	14.36	99
20+25+42+50	1.55	1.93	3.25	3.87	-	-	10.60 (3.40-12.40)	3.334 (0.870-4.330)	14.64	99
20+25+42+60	1.46	1.82	3.06	4.37	-	-	10.70 (3.40-12.40)	3.366 (0.870-4.330)	14.78	99
20+25+42+71	1.37	1.71	2.87	4.85	-	-	10.80 (3.40-12.50)	3.380 (0.870-4.400)	14.84	99
20+25+50+50	1.48	1.84	3.69	3.69	-	-	10.70 (3.40-12.40)	3.362 (0.870-4.330)	14.77	99
20+25+50+60	1.39	1.74	3.48	4.18	-	-	10.80 (3.40-12.50)	3.380 (0.870-4.400)	14.84	99
20+25+50+71	1.30	1.63	3.25	4.62	-	-	10.80 (3.40-12.50)	3.380 (0.870-4.400)	14.84	99
20+25+60+60	1.31	1.64	3.93	3.93	-	-	10.80 (3.40-12.50)	3.380 (0.870-4.400)	14.84	99
20+25+60+71	1.23	1.53	3.68	4.36	-	-	10.80 (3.40-12.50)	3.809 (0.870-4.400)	16.73	99
20+35+35+35	1.66	2.91	2.91	2.91	-	-	10.40 (3.40-12.20)	3.238 (0.870-4.240)	14.22	99
20+35+35+42	1.61	2.81	2.81	3.37	-	-	10.60 (3.40-12.30)	3.294 (0.870-4.280)	14.47	99
20+35+35+50	1.53	2.68	2.68	3.82	-	-	10.70 (3.40-12.40)	3.352 (0.870-4.330)	14.72	99
20+35+35+60	1.43	2.50	2.50	4.28	-	-	10.70 (3.40-12.40)	3.372 (0.870-4.330)	14.81	99
20+35+35+71	1.34	2.35	2.35	4.76	-	-	10.80 (3.40-12.50)	3.380 (0.870-4.400)	14.84	99
20+35+42+42	1.54	2.69	3.23	3.23	-	-	10.70 (3.40-12.40)	3.350 (0.870-4.330)	14.71	99
20+35+42+50	1.46	2.55	3.06	3.64	-	-	10.70 (3.40-12.40)	3.366 (0.870-4.330)	14.78	99
20+35+42+60	1.38	2.41	2.89	4.13	-	-	10.80 (3.40-12.50)	3.380 (0.870-4.400)	14.84	99
20+35+42+71	1.29	2.25	2.70	4.56	-	-	10.80 (3.40-12.50)	3.428 (0.870-4.400)	15.05	99
20+35+50+50	1.39	2.44	3.48	3.48	-	-	10.80 (3.40-12.50)	3.380 (0.870-4.400)	14.84	99
20+35+50+60	1.31	2.29	3.27	3.93	-	-	10.80 (3.40-12.50)	3.380 (0.870-4.400)	14.84	99
20+35+50+71	1.23	2.15	3.07	4.36	-	-	10.80 (3.40-12.50)	3.809 (0.870-4.400)	16.73	99
20+35+60+60	1.23	2.16	3.70	3.70	-	-	10.80 (3.40-12.50)	3.762 (0.870-4.400)	16.52	99

MXZ-6C122VA COOLING

Indoor units combination	Cooling Capacity (kW)							Outdoor unit power consumption (kW)	Current (A)	Power factor (%)
	Unit A	Unit B	Unit C	Unit D	Unit E	Unit F	Total			
20+42+42+42	1.47	3.08	3.08	3.08	-	-	10.70 (3.40-12.40)	3.364 (0.870-4.330)	14.77	99
20+42+42+50	1.40	2.95	2.95	3.51	-	-	10.80 (3.40-12.50)	3.380 (0.870-4.400)	14.84	99
20+42+42+60	1.32	2.77	2.77	3.95	-	-	10.80 (3.40-12.50)	3.380 (0.870-4.400)	14.84	99
20+42+42+71	1.23	2.59	2.59	4.38	-	-	10.80 (3.40-12.50)	3.762 (0.870-4.400)	16.52	99
20+42+50+50	1.33	2.80	3.33	3.33	-	-	10.80 (3.40-12.50)	3.380 (0.870-4.400)	14.84	99
20+42+50+60	1.26	2.64	3.14	3.77	-	-	10.80 (3.40-12.50)	3.618 (0.870-4.400)	15.89	99
20+50+50+50	1.27	3.18	3.18	3.18	-	-	10.80 (3.40-12.50)	3.523 (0.870-4.400)	15.47	99
20+50+50+60	1.20	3.00	3.00	3.60	-	-	10.80 (3.40-12.50)	4.000 (0.870-4.400)	17.57	99
22+22+22+22	2.20	2.20	2.20	2.20	-	-	8.80 (3.30-11.00)	2.400 (0.870-3.850)	10.54	99
22+22+22+25	2.20	2.20	2.20	2.50	-	-	9.10 (3.30-11.20)	2.493 (0.870-3.900)	10.95	99
22+22+22+35	2.18	2.18	2.18	3.47	-	-	10.00 (3.30-11.80)	3.018 (0.870-4.050)	13.25	99
22+22+22+42	2.06	2.06	2.06	3.93	-	-	10.10 (3.30-11.90)	3.114 (0.870-4.100)	13.67	99
22+22+22+50	1.95	1.95	1.95	4.44	-	-	10.30 (3.30-12.00)	3.172 (0.870-4.140)	13.93	99
22+22+22+60	1.83	1.83	1.83	5.00	-	-	10.50 (3.40-12.20)	3.246 (0.870-4.240)	14.26	99
22+22+22+71	1.70	1.70	1.70	5.49	-	-	10.60 (3.40-12.40)	3.334 (0.870-4.330)	14.64	99
22+22+25+25	2.20	2.20	2.50	2.50	-	-	9.40 (3.30-11.40)	2.650 (0.870-3.950)	11.64	99
22+22+25+35	2.14	2.14	2.43	3.40	-	-	10.10 (3.30-11.90)	3.085 (0.870-4.100)	13.55	99
22+22+25+42	2.02	2.02	2.30	3.86	-	-	10.20 (3.30-12.00)	3.135 (0.870-4.140)	13.77	99
22+22+25+50	1.90	1.90	2.16	4.33	-	-	10.30 (3.30-12.10)	3.194 (0.870-4.190)	14.03	99
22+22+25+60	1.79	1.79	2.03	4.88	-	-	10.50 (3.40-12.20)	3.270 (0.870-4.240)	14.36	99
22+22+25+71	1.68	1.68	1.91	5.43	-	-	10.70 (3.40-12.40)	3.352 (0.870-4.330)	14.72	99
22+22+35+35	1.97	1.97	3.13	3.13	-	-	10.20 (3.30-12.00)	3.157 (0.870-4.140)	13.87	99
22+22+35+42	1.89	1.89	3.01	3.61	-	-	10.40 (3.40-12.10)	3.208 (0.870-4.190)	14.09	99
22+22+35+50	1.79	1.79	2.85	4.07	-	-	10.50 (3.40-12.20)	3.270 (0.870-4.240)	14.36	99
22+22+35+60	1.69	1.69	2.69	4.62	-	-	10.70 (3.40-12.40)	3.350 (0.870-4.330)	14.71	99
22+22+35+71	1.57	1.57	2.50	5.06	-	-	10.70 (3.40-12.40)	3.372 (0.870-4.330)	14.81	99
22+22+42+42	1.80	1.80	3.45	3.45	-	-	10.50 (3.40-12.20)	3.262 (0.870-4.240)	14.33	99
22+22+42+50	1.71	1.71	3.27	3.90	-	-	10.60 (3.40-12.30)	3.326 (0.870-4.280)	14.61	99
22+22+42+60	1.61	1.61	3.08	4.40	-	-	10.70 (3.40-12.40)	3.364 (0.870-4.330)	14.77	99
22+22+42+71	1.51	1.51	2.89	4.88	-	-	10.80 (3.40-12.50)	3.380 (0.870-4.400)	14.84	99
22+22+50+50	1.63	1.63	3.72	3.72	-	-	10.70 (3.40-12.40)	3.360 (0.870-4.330)	14.76	99
22+22+50+60	1.54	1.54	3.51	4.21	-	-	10.80 (3.40-12.50)	3.380 (0.870-4.400)	14.84	99
22+22+50+71	1.44	1.44	3.27	4.65	-	-	10.80 (3.40-12.50)	3.380 (0.870-4.400)	14.84	99
22+22+60+60	1.45	1.45	3.95	3.95	-	-	10.80 (3.40-12.50)	3.380 (0.870-4.400)	14.84	99
22+22+60+71	1.36	1.36	3.70	4.38	-	-	10.80 (3.40-12.50)	3.762 (0.870-4.400)	16.52	99
22+25+25+25	2.20	2.50	2.50	2.50	-	-	9.70 (3.30-11.60)	2.808 (0.870-4.000)	12.33	99
22+25+25+35	2.08	2.36	2.36	3.30	-	-	10.10 (3.30-11.90)	3.106 (0.870-4.100)	13.64	99
22+25+25+42	1.97	2.24	2.24	3.76	-	-	10.20 (3.30-12.00)	3.157 (0.870-4.140)	13.87	99
22+25+25+50	1.88	2.13	2.13	4.26	-	-	10.40 (3.40-12.10)	3.215 (0.870-4.190)	14.12	99
22+25+25+60	1.77	2.01	2.01	4.82	-	-	10.60 (3.40-12.30)	3.294 (0.870-4.280)	14.47	99
22+25+25+71	1.65	1.87	1.87	5.31	-	-	10.70 (3.40-12.40)	3.358 (0.870-4.330)	14.75	99
22+25+35+35	1.94	2.20	3.08	3.08	-	-	10.30 (3.30-12.10)	3.179 (0.870-4.190)	13.96	99
22+25+35+42	1.85	2.10	2.94	3.52	-	-	10.40 (3.40-12.20)	3.230 (0.870-4.240)	14.19	99
22+25+35+50	1.77	2.01	2.81	4.02	-	-	10.60 (3.40-12.30)	3.294 (0.870-4.280)	14.47	99
22+25+35+60	1.66	1.88	2.64	4.52	-	-	10.70 (3.40-12.40)	3.356 (0.870-4.330)	14.74	99
22+25+35+71	1.54	1.75	2.45	4.97	-	-	10.70 (3.40-12.40)	3.378 (0.870-4.330)	14.84	99

MXZ-6C122VA COOLING

Indoor units combination	Cooling Capacity (kW)							Outdoor unit power consumption (kW)	Current (A)	Power factor (%)
	Unit A	Unit B	Unit C	Unit D	Unit E	Unit F	Total			
22+25+42+42	1.76	2.00	3.37	3.37	-	-	10.50 (3.40-12.30)	3.286 (0.870-4.280)	14.43	99
22+25+42+50	1.69	1.92	3.23	3.85	-	-	10.70 (3.40-12.40)	3.350 (0.870-4.330)	14.71	99
22+25+42+60	1.58	1.80	3.02	4.31	-	-	10.70 (3.40-12.40)	3.370 (0.870-4.330)	14.80	99
22+25+42+71	1.49	1.69	2.84	4.79	-	-	10.80 (3.40-12.50)	3.380 (0.870-4.400)	14.84	99
22+25+50+50	1.60	1.82	3.64	3.64	-	-	10.70 (3.40-12.40)	3.366 (0.870-4.330)	14.78	99
22+25+50+60	1.51	1.72	3.44	4.13	-	-	10.80 (3.40-12.50)	3.380 (0.870-4.400)	14.84	99
22+25+50+71	1.41	1.61	3.21	4.56	-	-	10.80 (3.40-12.50)	3.428 (0.870-4.400)	15.05	99
22+25+60+60	1.42	1.62	3.88	3.88	-	-	10.80 (3.40-12.50)	3.380 (0.870-4.400)	14.84	99
22+25+60+71	1.33	1.52	3.64	4.31	-	-	10.80 (3.40-12.50)	3.905 (0.870-4.400)	17.15	99
22+35+35+35	1.82	2.89	2.89	2.89	-	-	10.50 (3.40-12.20)	3.254 (0.870-4.240)	14.29	99
22+35+35+42	1.74	2.77	2.77	3.32	-	-	10.60 (3.40-12.30)	3.310 (0.870-4.280)	14.54	99
22+35+35+50	1.66	2.64	2.64	3.77	-	-	10.70 (3.40-12.40)	3.356 (0.870-4.330)	14.74	99
22+35+35+60	1.55	2.46	2.46	4.22	-	-	10.70 (3.40-12.40)	3.376 (0.870-4.330)	14.83	99
22+35+35+71	1.46	2.32	2.32	4.70	-	-	10.80 (3.40-12.50)	3.380 (0.870-4.400)	14.84	99
22+35+42+42	1.67	2.66	3.19	3.19	-	-	10.70 (3.40-12.40)	3.354 (0.870-4.330)	14.73	99
22+35+42+50	1.58	2.51	3.02	3.59	-	-	10.70 (3.40-12.40)	3.370 (0.870-4.330)	14.80	99
22+35+42+60	1.49	2.38	2.85	4.08	-	-	10.80 (3.40-12.50)	3.380 (0.870-4.400)	14.84	99
22+35+42+71	1.40	2.22	2.67	4.51	-	-	10.80 (3.40-12.50)	3.523 (0.870-4.400)	15.47	99
22+35+50+50	1.51	2.41	3.44	3.44	-	-	10.80 (3.40-12.50)	3.380 (0.870-4.400)	14.84	99
22+35+50+60	1.42	2.26	3.23	3.88	-	-	10.80 (3.40-12.50)	3.380 (0.870-4.400)	14.84	99
22+35+50+71	1.33	2.12	3.03	4.31	-	-	10.80 (3.40-12.50)	3.905 (0.870-4.400)	17.15	99
22+35+60+60	1.34	2.14	3.66	3.66	-	-	10.80 (3.40-12.50)	3.857 (0.870-4.400)	16.94	99
22+42+42+42	1.59	3.04	3.04	3.04	-	-	10.70 (3.40-12.40)	3.368 (0.870-4.330)	14.79	99
22+42+42+50	1.52	2.91	2.91	3.46	-	-	10.80 (3.40-12.50)	3.380 (0.870-4.400)	14.84	99
22+42+42+60	1.43	2.73	2.73	3.90	-	-	10.80 (3.40-12.50)	3.380 (0.870-4.400)	14.84	99
22+42+42+71	1.34	2.56	2.56	4.33	-	-	10.80 (3.40-12.50)	3.857 (0.870-4.400)	16.94	99
22+42+50+50	1.45	2.77	3.29	3.29	-	-	10.80 (3.40-12.50)	3.380 (0.870-4.400)	14.84	99
22+42+50+60	1.37	2.61	3.10	3.72	-	-	10.80 (3.40-12.50)	3.714 (0.870-4.400)	16.31	99
22+50+50+50	1.38	3.14	3.14	3.14	-	-	10.80 (3.40-12.50)	3.618 (0.870-4.400)	15.89	99
25+25+25+25	2.50	2.50	2.50	2.50	-	-	10.00 (3.30-11.80)	2.965 (0.870-4.050)	13.02	99
25+25+25+35	2.32	2.32	2.32	3.25	-	-	10.20 (3.30-12.00)	3.128 (0.870-4.140)	13.74	99
25+25+25+42	2.20	2.20	2.20	3.70	-	-	10.30 (3.30-12.10)	3.179 (0.870-4.190)	13.96	99
25+25+25+50	2.08	2.08	2.08	4.16	-	-	10.40 (3.40-12.20)	3.238 (0.870-4.240)	14.22	99
25+25+25+60	1.96	1.96	1.96	4.71	-	-	10.60 (3.40-12.30)	3.318 (0.870-4.280)	14.57	99
25+25+25+71	1.83	1.83	1.83	5.20	-	-	10.70 (3.40-12.40)	3.364 (0.870-4.330)	14.77	99
25+25+35+35	2.17	2.17	3.03	3.03	-	-	10.40 (3.40-12.10)	3.201 (0.870-4.190)	14.06	99
25+25+35+42	2.07	2.07	2.89	3.47	-	-	10.50 (3.40-12.20)	3.254 (0.870-4.240)	14.29	99
25+25+35+50	1.96	1.96	2.75	3.93	-	-	10.60 (3.40-12.30)	3.318 (0.870-4.280)	14.57	99
25+25+35+60	1.84	1.84	2.58	4.43	-	-	10.70 (3.40-12.40)	3.362 (0.870-4.330)	14.77	99
25+25+35+71	1.73	1.73	2.42	4.92	-	-	10.80 (3.40-12.50)	3.380 (0.870-4.400)	14.84	99
25+25+42+42	1.98	1.98	3.32	3.32	-	-	10.60 (3.40-12.30)	3.310 (0.870-4.280)	14.54	99
25+25+42+50	1.88	1.88	3.16	3.77	-	-	10.70 (3.40-12.40)	3.356 (0.870-4.330)	14.74	99
25+25+42+60	1.76	1.76	2.96	4.22	-	-	10.70 (3.40-12.40)	3.376 (0.870-4.330)	14.83	99
25+25+42+71	1.66	1.66	2.78	4.70	-	-	10.80 (3.40-12.50)	3.380 (0.870-4.400)	14.84	99
25+25+50+50	1.78	1.78	3.57	3.57	-	-	10.70 (3.40-12.40)	3.372 (0.870-4.330)	14.81	99
25+25+50+60	1.69	1.69	3.38	4.05	-	-	10.80 (3.40-12.50)	3.380 (0.870-4.400)	14.84	99

MXZ-6C122VA COOLING

Indoor units combination	Cooling Capacity (kW)							Outdoor unit power consumption (kW)	Current (A)	Power factor (%)
	Unit A	Unit B	Unit C	Unit D	Unit E	Unit F	Total			
25+25+50+71	1.58	1.58	3.16	4.48	-	-	10.80 (3.40-12.50)	3.571 (0.870-4.400)	15.68	99
25+25+60+60	1.59	1.59	3.81	3.81	-	-	10.80 (3.40-12.50)	3.523 (0.870-4.400)	15.47	99
25+35+35+35	2.02	2.83	2.83	2.83	-	-	10.50 (3.40-12.30)	3.278 (0.870-4.280)	14.40	99
25+35+35+42	1.93	2.71	2.71	3.25	-	-	10.60 (3.40-12.40)	3.334 (0.870-4.330)	14.64	99
25+35+35+50	1.84	2.58	2.58	3.69	-	-	10.70 (3.40-12.40)	3.362 (0.870-4.330)	14.77	99
25+35+35+60	1.74	2.44	2.44	4.18	-	-	10.80 (3.40-12.50)	3.380 (0.870-4.400)	14.84	99
25+35+35+71	1.63	2.28	2.28	4.62	-	-	10.80 (3.40-12.50)	3.380 (0.870-4.400)	14.84	99
25+35+42+42	1.86	2.60	3.12	3.12	-	-	10.70 (3.40-12.40)	3.360 (0.870-4.330)	14.76	99
25+35+42+50	1.76	2.46	2.96	3.52	-	-	10.70 (3.40-12.40)	3.376 (0.870-4.330)	14.83	99
25+35+42+60	1.67	2.33	2.80	4.00	-	-	10.80 (3.40-12.50)	3.380 (0.870-4.400)	14.84	99
25+35+42+71	1.56	2.18	2.62	4.43	-	-	10.80 (3.40-12.50)	3.666 (0.870-4.400)	16.10	99
25+35+50+50	1.69	2.36	3.38	3.38	-	-	10.80 (3.40-12.50)	3.380 (0.870-4.400)	14.84	99
25+35+50+60	1.59	2.22	3.18	3.81	-	-	10.80 (3.40-12.50)	3.523 (0.870-4.400)	15.47	99
25+35+60+60	1.50	2.10	3.60	3.60	-	-	10.80 (3.40-12.50)	4.000 (0.870-4.400)	17.57	99
25+42+42+42	1.77	2.98	2.98	2.98	-	-	10.70 (3.40-12.40)	3.374 (0.870-4.330)	14.82	99
25+42+42+50	1.70	2.85	2.85	3.40	-	-	10.80 (3.40-12.50)	3.380 (0.870-4.400)	14.84	99
25+42+42+60	1.60	2.68	2.68	3.83	-	-	10.80 (3.40-12.50)	3.475 (0.870-4.400)	15.26	99
25+42+42+71	1.50	2.52	2.52	4.26	-	-	10.80 (3.40-12.50)	4.000 (0.870-4.400)	17.57	99
25+42+50+50	1.62	2.72	3.23	3.23	-	-	10.80 (3.40-12.50)	3.380 (0.870-4.400)	14.84	99
25+42+50+60	1.53	2.56	3.05	3.66	-	-	10.80 (3.40-12.50)	3.857 (0.870-4.400)	16.94	99
25+50+50+50	1.54	3.09	3.09	3.09	-	-	10.80 (3.40-12.50)	3.762 (0.870-4.400)	16.52	99
35+35+35+35	2.68	2.68	2.68	2.68	-	-	10.70 (3.40-12.40)	3.352 (0.870-4.330)	14.72	99
35+35+35+42	2.55	2.55	2.55	3.06	-	-	10.70 (3.40-12.40)	3.366 (0.870-4.330)	14.78	99
35+35+35+50	2.44	2.44	2.44	3.48	-	-	10.80 (3.40-12.50)	3.380 (0.870-4.400)	14.84	99
35+35+35+60	2.29	2.29	2.29	3.93	-	-	10.80 (3.40-12.50)	3.380 (0.870-4.400)	14.84	99
35+35+35+71	2.15	2.15	2.15	4.36	-	-	10.80 (3.40-12.50)	3.809 (0.870-4.400)	16.73	99
35+35+42+42	2.45	2.45	2.95	2.95	-	-	10.80 (3.40-12.50)	3.380 (0.870-4.400)	14.84	99
35+35+42+50	2.33	2.33	2.80	3.33	-	-	10.80 (3.40-12.50)	3.380 (0.870-4.400)	14.84	99
35+35+42+60	2.20	2.20	2.64	3.77	-	-	10.80 (3.40-12.50)	3.618 (0.870-4.400)	15.89	99
35+35+50+50	2.22	2.22	3.18	3.18	-	-	10.80 (3.40-12.50)	3.523 (0.870-4.400)	15.47	99
35+35+50+60	2.10	2.10	3.00	3.60	-	-	10.80 (3.40-12.50)	4.000 (0.870-4.400)	17.57	99
35+42+42+42	2.35	2.82	2.82	2.82	-	-	10.80 (3.40-12.50)	3.380 (0.870-4.400)	14.84	99
35+42+42+50	2.24	2.68	2.68	3.20	-	-	10.80 (3.40-12.50)	3.475 (0.870-4.400)	15.26	99
35+42+42+60	2.11	2.53	2.53	3.62	-	-	10.80 (3.40-12.50)	3.952 (0.870-4.400)	17.36	99
35+42+50+50	2.14	2.56	3.05	3.05	-	-	10.80 (3.40-12.50)	3.857 (0.870-4.400)	16.94	99
42+42+42+42	2.70	2.70	2.70	2.70	-	-	10.80 (3.40-12.50)	3.428 (0.870-4.400)	15.05	99
42+42+42+50	2.58	2.58	2.58	3.07	-	-	10.80 (3.40-12.50)	3.809 (0.870-4.400)	16.73	99
15+15+15+15+15	1.50	1.50	1.50	1.50	1.50	-	7.50 (3.30-10.50)	1.800 (0.930-4.910)	7.91	99
15+15+15+15+20	1.50	1.50	1.50	1.50	2.00	-	8.00 (3.30-10.80)	2.062 (0.930-5.040)	9.05	99
15+15+15+15+22	1.50	1.50	1.50	1.50	2.20	-	8.20 (3.30-10.90)	2.166 (0.930-5.090)	9.51	99
15+15+15+15+25	1.50	1.50	1.50	1.50	2.50	-	8.50 (3.30-11.00)	2.323 (0.930-5.130)	10.20	99
15+15+15+15+35	1.50	1.50	1.50	1.50	3.50	-	9.50 (3.30-11.50)	2.846 (0.930-5.350)	12.50	99
15+15+15+15+42	1.50	1.50	1.50	1.50	4.20	-	10.20 (3.30-12.10)	3.185 (0.920-5.550)	13.99	99
15+15+15+15+50	1.50	1.50	1.50	1.50	5.00	-	11.00 (3.50-13.20)	3.385 (0.890-5.810)	14.87	99
15+15+15+15+60	1.45	1.45	1.45	1.45	5.80	-	11.60 (3.50-13.20)	3.616 (0.890-5.780)	15.88	99
15+15+15+15+71	1.36	1.36	1.36	1.36	6.45	-	11.90 (3.50-13.20)	3.867 (0.890-5.760)	16.98	99

MXZ-6C122VA COOLING

Indoor units combination	Cooling Capacity (kW)							Outdoor unit power consumption (kW)	Current (A)	Power factor (%)
	Unit A	Unit B	Unit C	Unit D	Unit E	Unit F	Total			
15+15+15+20+20	1.50	1.50	1.50	2.00	2.00	-	8.50 (3.30-11.00)	2.323 (0.930-5.130)	10.20	99
15+15+15+20+22	1.50	1.50	1.50	2.00	2.20	-	8.70 (3.30-11.10)	2.428 (0.930-5.170)	10.66	99
15+15+15+20+25	1.50	1.50	1.50	2.00	2.50	-	9.00 (3.30-11.30)	2.585 (0.930-5.260)	11.35	99
15+15+15+20+35	1.50	1.50	1.50	2.00	3.50	-	10.00 (3.30-11.80)	3.108 (0.930-5.480)	13.65	99
15+15+15+20+42	1.50	1.50	1.50	2.00	4.20	-	10.70 (3.40-12.80)	3.310 (0.900-5.720)	14.54	99
15+15+15+20+50	1.47	1.47	1.47	1.97	4.91	-	11.30 (3.50-13.20)	3.501 (0.890-5.790)	15.38	99
15+15+15+20+60	1.43	1.43	1.43	1.90	5.71	-	11.90 (3.50-13.20)	3.730 (0.890-5.760)	16.38	99
15+15+15+20+71	1.32	1.32	1.32	1.76	6.26	-	12.00 (3.50-13.30)	3.905 (0.890-5.780)	17.15	99
15+15+15+22+22	1.50	1.50	1.50	2.20	2.20	-	8.90 (3.30-11.20)	2.532 (0.930-5.260)	11.12	99
15+15+15+22+25	1.50	1.50	1.50	2.20	2.50	-	9.20 (3.30-11.40)	2.689 (0.930-5.300)	11.81	99
15+15+15+22+35	1.50	1.50	1.50	2.20	3.50	-	10.20 (3.30-12.10)	3.185 (0.920-5.550)	13.99	99
15+15+15+22+42	1.50	1.50	1.50	2.20	4.20	-	10.90 (3.50-13.10)	3.360 (0.890-5.790)	14.76	99
15+15+15+22+50	1.46	1.46	1.46	2.14	4.87	-	11.40 (3.50-13.20)	3.547 (0.890-5.790)	15.58	99
15+15+15+22+60	1.41	1.41	1.41	2.06	5.62	-	11.90 (3.50-13.20)	3.776 (0.890-5.760)	16.58	99
15+15+15+22+71	1.30	1.30	1.30	1.91	6.17	-	12.00 (3.50-13.30)	3.913 (0.890-5.780)	17.19	99
15+15+15+25+25	1.50	1.50	1.50	2.50	2.50	-	9.50 (3.30-11.50)	2.846 (0.930-5.350)	12.50	99
15+15+15+25+35	1.50	1.50	1.50	2.50	3.50	-	10.50 (3.40-12.50)	3.260 (0.910-5.650)	14.32	99
15+15+15+25+42	1.49	1.49	1.49	2.48	4.16	-	11.10 (3.50-13.20)	3.433 (0.890-5.800)	15.08	99
15+15+15+25+50	1.45	1.45	1.45	2.42	4.83	-	11.60 (3.50-13.20)	3.616 (0.890-5.780)	15.88	99
15+15+15+25+60	1.37	1.37	1.37	2.29	5.49	-	11.90 (3.50-13.20)	3.844 (0.890-5.760)	16.88	99
15+15+15+25+71	1.28	1.28	1.28	2.13	6.04	-	12.00 (3.50-13.30)	3.925 (0.890-5.780)	17.24	99
15+15+15+35+35	1.47	1.47	1.47	3.44	3.44	-	11.30 (3.50-13.20)	3.501 (0.890-5.790)	15.38	99
15+15+15+35+42	1.44	1.44	1.44	3.36	4.03	-	11.70 (3.50-13.20)	3.661 (0.890-5.770)	16.08	99
15+15+15+35+50	1.37	1.37	1.37	3.20	4.58	-	11.90 (3.50-13.20)	3.844 (0.890-5.760)	16.88	99
15+15+15+35+60	1.29	1.29	1.29	3.00	5.14	-	12.00 (3.50-13.30)	3.921 (0.890-5.780)	17.22	99
15+15+15+35+71	1.20	1.20	1.20	2.80	5.69	-	12.10 (3.50-13.30)	3.958 (0.890-5.780)	17.38	99
15+15+15+42+42	1.38	1.38	1.38	3.87	3.87	-	11.90 (3.50-13.20)	3.821 (0.890-5.760)	16.78	99
15+15+15+42+50	1.31	1.31	1.31	3.68	4.38	-	12.00 (3.50-13.30)	3.909 (0.890-5.780)	17.17	99
15+15+15+42+60	1.22	1.22	1.22	3.43	4.90	-	12.00 (3.50-13.30)	3.946 (0.890-5.780)	17.33	99
15+15+15+42+71	1.15	1.15	1.15	3.22	5.44	-	12.10 (3.50-13.30)	3.980 (0.890-5.780)	17.48	99
15+15+15+50+50	1.24	1.24	1.24	4.14	4.14	-	12.00 (3.50-13.30)	3.940 (0.890-5.780)	17.30	99
15+15+15+50+60	1.17	1.17	1.17	3.90	4.68	-	12.10 (3.50-13.30)	3.971 (0.890-5.780)	17.44	99
15+15+15+50+71	1.09	1.09	1.09	3.64	5.18	-	12.10 (3.50-13.30)	4.020 (0.890-5.780)	17.65	99
15+15+15+60+60	1.10	1.10	1.10	4.40	4.40	-	12.10 (3.50-13.30)	4.015 (0.890-5.780)	17.63	99
15+15+15+60+71	1.04	1.04	1.04	4.16	4.92	-	12.20 (3.50-13.40)	4.030 (0.890-5.790)	17.70	99
15+15+20+20+20	1.50	1.50	2.00	2.00	2.00	-	9.00 (3.30-11.30)	2.585 (0.930-5.260)	11.35	99
15+15+20+20+22	1.50	1.50	2.00	2.00	2.20	-	9.20 (3.30-11.40)	2.689 (0.930-5.300)	11.81	99
15+15+20+20+25	1.50	1.50	2.00	2.00	2.50	-	9.50 (3.30-11.50)	2.846 (0.930-5.350)	12.50	99
15+15+20+20+35	1.50	1.50	2.00	2.00	3.50	-	10.50 (3.40-12.50)	3.260 (0.910-5.650)	14.32	99
15+15+20+20+42	1.49	1.49	1.98	1.98	4.16	-	11.10 (3.50-13.20)	3.433 (0.890-5.800)	15.08	99
15+15+20+20+50	1.45	1.45	1.93	1.93	4.83	-	11.60 (3.50-13.20)	3.616 (0.890-5.780)	15.88	99
15+15+20+20+60	1.37	1.37	1.83	1.83	5.49	-	11.90 (3.50-13.20)	3.844 (0.890-5.760)	16.88	99
15+15+20+20+71	1.28	1.28	1.70	1.70	6.04	-	12.00 (3.50-13.30)	3.925 (0.890-5.780)	17.24	99
15+15+20+22+22	1.50	1.50	2.00	2.20	2.20	-	9.40 (3.30-11.50)	2.794 (0.930-5.350)	12.27	99
15+15+20+22+25	1.50	1.50	2.00	2.20	2.50	-	9.70 (3.30-11.60)	2.951 (0.930-5.390)	12.96	99
15+15+20+22+35	1.50	1.50	2.00	2.20	3.50	-	10.70 (3.40-12.80)	3.310 (0.900-5.720)	14.54	99

MXZ-6C122VA COOLING

Indoor units combination	Cooling Capacity (kW)							Outdoor unit power consumption (kW)	Current (A)	Power factor (%)
	Unit A	Unit B	Unit C	Unit D	Unit E	Unit F	Total			
15+15+20+22+42	1.47	1.47	1.96	2.16	4.13	-	11.20 (3.50-13.20)	3.479 (0.890-5.800)	15.28	99
15+15+20+22+50	1.44	1.44	1.92	2.11	4.80	-	11.70 (3.50-13.20)	3.661 (0.890-5.770)	16.08	99
15+15+20+22+60	1.35	1.35	1.80	1.98	5.41	-	11.90 (3.50-13.20)	3.890 (0.890-5.760)	17.08	99
15+15+20+22+71	1.26	1.26	1.68	1.85	5.96	-	12.00 (3.50-13.30)	3.932 (0.890-5.780)	17.27	99
15+15+20+25+25	1.50	1.50	2.00	2.50	2.50	-	10.00 (3.30-11.80)	3.108 (0.930-5.480)	13.65	99
15+15+20+25+35	1.50	1.50	2.00	2.50	3.50	-	11.00 (3.50-13.20)	3.385 (0.890-5.810)	14.87	99
15+15+20+25+42	1.46	1.46	1.95	2.44	4.09	-	11.40 (3.50-13.20)	3.547 (0.890-5.790)	15.58	99
15+15+20+25+50	1.43	1.43	1.90	2.38	4.76	-	11.90 (3.50-13.20)	3.730 (0.890-5.760)	16.38	99
15+15+20+25+60	1.33	1.33	1.78	2.22	5.33	-	12.00 (3.50-13.30)	3.902 (0.890-5.780)	17.13	99
15+15+20+25+71	1.23	1.23	1.64	2.05	5.84	-	12.00 (3.50-13.30)	3.943 (0.890-5.780)	17.32	99
15+15+20+35+35	1.45	1.45	1.93	3.38	3.38	-	11.60 (3.50-13.20)	3.616 (0.890-5.780)	15.88	99
15+15+20+35+42	1.41	1.41	1.87	3.28	3.94	-	11.90 (3.50-13.20)	3.776 (0.890-5.760)	16.58	99
15+15+20+35+50	1.33	1.33	1.78	3.11	4.44	-	12.00 (3.50-13.30)	3.902 (0.890-5.780)	17.13	99
15+15+20+35+60	1.24	1.24	1.66	2.90	4.97	-	12.00 (3.50-13.30)	3.940 (0.890-5.780)	17.30	99
15+15+20+35+71	1.16	1.16	1.55	2.71	5.51	-	12.10 (3.50-13.30)	3.974 (0.890-5.780)	17.45	99
15+15+20+42+42	1.34	1.34	1.79	3.76	3.76	-	12.00 (3.50-13.30)	3.898 (0.890-5.780)	17.12	99
15+15+20+42+50	1.27	1.27	1.69	3.55	4.23	-	12.00 (3.50-13.30)	3.928 (0.890-5.780)	17.25	99
15+15+20+42+60	1.19	1.19	1.59	3.34	4.78	-	12.10 (3.50-13.30)	3.962 (0.890-5.780)	17.40	99
15+15+20+42+71	1.11	1.11	1.48	3.12	5.27	-	12.10 (3.50-13.30)	4.005 (0.890-5.780)	17.59	99
15+15+20+50+50	1.21	1.21	1.61	4.03	4.03	-	12.10 (3.50-13.30)	3.955 (0.890-5.780)	17.37	99
15+15+20+50+60	1.13	1.13	1.51	3.78	4.54	-	12.10 (3.50-13.30)	3.990 (0.890-5.780)	17.52	99
15+15+20+50+71	1.07	1.07	1.43	3.57	5.07	-	12.20 (3.50-13.40)	4.030 (0.890-5.790)	17.70	99
15+15+20+60+60	1.08	1.08	1.44	4.31	4.31	-	12.20 (3.50-13.40)	4.030 (0.890-5.790)	17.70	99
15+15+22+22+22	1.50	1.50	2.20	2.20	2.20	-	9.60 (3.30-11.60)	2.898 (0.930-5.390)	12.73	99
15+15+22+22+25	1.50	1.50	2.20	2.20	2.50	-	9.90 (3.30-11.70)	3.055 (0.930-5.440)	13.42	99
15+15+22+22+35	1.50	1.50	2.20	2.20	3.50	-	10.90 (3.50-13.10)	3.360 (0.890-5.790)	14.76	99
15+15+22+22+42	1.47	1.47	2.16	2.16	4.13	-	11.40 (3.50-13.20)	3.524 (0.890-5.790)	15.48	99
15+15+22+22+50	1.43	1.43	2.09	2.09	4.76	-	11.80 (3.50-13.20)	3.707 (0.890-5.760)	16.28	99
15+15+22+22+60	1.34	1.34	1.97	1.97	5.37	-	12.00 (3.50-13.30)	3.898 (0.890-5.780)	17.12	99
15+15+22+22+71	1.24	1.24	1.82	1.82	5.88	-	12.00 (3.50-13.30)	3.940 (0.890-5.780)	17.30	99
15+15+22+25+25	1.50	1.50	2.20	2.50	2.50	-	10.20 (3.30-12.10)	3.185 (0.920-5.550)	13.99	99
15+15+22+25+35	1.49	1.49	2.18	2.48	3.47	-	11.10 (3.50-13.20)	3.433 (0.890-5.800)	15.08	99
15+15+22+25+42	1.45	1.45	2.13	2.42	4.06	-	11.50 (3.50-13.20)	3.593 (0.890-5.780)	15.78	99
15+15+22+25+50	1.41	1.41	2.06	2.34	4.69	-	11.90 (3.50-13.20)	3.776 (0.890-5.760)	16.58	99
15+15+22+25+60	1.31	1.31	1.93	2.19	5.26	-	12.00 (3.50-13.30)	3.909 (0.890-5.780)	17.17	99
15+15+22+25+71	1.22	1.22	1.78	2.03	5.76	-	12.00 (3.50-13.30)	3.949 (0.890-5.780)	17.34	99
15+15+22+35+35	1.44	1.44	2.11	3.36	3.36	-	11.70 (3.50-13.20)	3.661 (0.890-5.770)	16.08	99
15+15+22+35+42	1.38	1.38	2.03	3.23	3.87	-	11.90 (3.50-13.20)	3.821 (0.890-5.760)	16.78	99
15+15+22+35+50	1.31	1.31	1.93	3.07	4.38	-	12.00 (3.50-13.30)	3.909 (0.890-5.780)	17.17	99
15+15+22+35+60	1.22	1.22	1.80	2.86	4.90	-	12.00 (3.50-13.30)	3.946 (0.890-5.780)	17.33	99
15+15+22+35+71	1.15	1.15	1.68	2.68	5.44	-	12.10 (3.50-13.30)	3.980 (0.890-5.780)	17.48	99
15+15+22+42+42	1.32	1.32	1.94	3.71	3.71	-	12.00 (3.50-13.30)	3.905 (0.890-5.780)	17.15	99
15+15+22+42+50	1.25	1.25	1.83	3.50	4.17	-	12.00 (3.50-13.30)	3.936 (0.890-5.780)	17.29	99
15+15+22+42+60	1.18	1.18	1.73	3.30	4.71	-	12.10 (3.50-13.30)	3.968 (0.890-5.780)	17.43	99
15+15+22+42+71	1.10	1.10	1.61	3.08	5.21	-	12.10 (3.50-13.30)	4.015 (0.890-5.780)	17.63	99
15+15+22+50+50	1.19	1.19	1.75	3.98	3.98	-	12.10 (3.50-13.30)	3.962 (0.890-5.780)	17.40	99

MXZ-6C122VA COOLING

Indoor units combination	Cooling Capacity (kW)							Outdoor unit power consumption (kW)	Current (A)	Power factor (%)
	Unit A	Unit B	Unit C	Unit D	Unit E	Unit F	Total			
15+15+22+50+60	1.12	1.12	1.64	3.73	4.48	-	12.10 (3.50-13.30)	4.000 (0.890-5.780)	17.57	99
15+15+22+50+71	1.06	1.06	1.55	3.53	5.01	-	12.20 (3.50-13.40)	4.030 (0.890-5.790)	17.70	99
15+15+22+60+60	1.06	1.06	1.56	4.26	4.26	-	12.20 (3.50-13.40)	4.030 (0.890-5.790)	17.70	99
15+15+25+25+25	1.50	1.50	2.50	2.50	2.50	-	10.50 (3.40-12.50)	3.260 (0.910-5.650)	14.32	99
15+15+25+25+35	1.47	1.47	2.46	2.46	3.44	-	11.30 (3.50-13.20)	3.501 (0.890-5.790)	15.38	99
15+15+25+25+42	1.44	1.44	2.40	2.40	4.03	-	11.70 (3.50-13.20)	3.661 (0.890-5.770)	16.08	99
15+15+25+25+50	1.37	1.37	2.29	2.29	4.58	-	11.90 (3.50-13.20)	3.844 (0.890-5.760)	16.88	99
15+15+25+25+60	1.29	1.29	2.14	2.14	5.14	-	12.00 (3.50-13.30)	3.921 (0.890-5.780)	17.22	99
15+15+25+25+71	1.20	1.20	2.00	2.00	5.69	-	12.10 (3.50-13.30)	3.958 (0.890-5.780)	17.38	99
15+15+25+35+35	1.43	1.43	2.38	3.33	3.33	-	11.90 (3.50-13.20)	3.730 (0.890-5.760)	16.38	99
15+15+25+35+42	1.35	1.35	2.25	3.16	3.79	-	11.90 (3.50-13.20)	3.890 (0.890-5.760)	17.08	99
15+15+25+35+50	1.29	1.29	2.14	3.00	4.29	-	12.00 (3.50-13.30)	3.921 (0.890-5.780)	17.22	99
15+15+25+35+60	1.21	1.21	2.02	2.82	4.84	-	12.10 (3.50-13.30)	3.955 (0.890-5.780)	17.37	99
15+15+25+35+71	1.13	1.13	1.88	2.63	5.34	-	12.10 (3.50-13.30)	3.995 (0.890-5.780)	17.55	99
15+15+25+42+42	1.29	1.29	2.16	3.63	3.63	-	12.00 (3.50-13.30)	3.917 (0.890-5.780)	17.20	99
15+15+25+42+50	1.22	1.22	2.04	3.43	4.08	-	12.00 (3.50-13.30)	3.946 (0.890-5.780)	17.33	99
15+15+25+42+60	1.16	1.16	1.93	3.24	4.62	-	12.10 (3.50-13.30)	3.977 (0.890-5.780)	17.47	99
15+15+25+42+71	1.09	1.09	1.82	3.05	5.16	-	12.20 (3.50-13.40)	4.030 (0.890-5.790)	17.70	99
15+15+25+50+50	1.17	1.17	1.95	3.90	3.90	-	12.10 (3.50-13.30)	3.971 (0.890-5.780)	17.44	99
15+15+25+50+60	1.10	1.10	1.83	3.67	4.40	-	12.10 (3.50-13.30)	4.015 (0.890-5.780)	17.63	99
15+15+25+50+71	1.04	1.04	1.73	3.47	4.92	-	12.20 (3.50-13.40)	4.030 (0.890-5.790)	17.70	99
15+15+25+60+60	1.05	1.05	1.74	4.18	4.18	-	12.20 (3.50-13.40)	4.030 (0.890-5.790)	17.70	99
15+15+35+35+35	1.33	1.33	3.11	3.11	3.11	-	12.00 (3.50-13.30)	3.902 (0.890-5.780)	17.13	99
15+15+35+35+42	1.27	1.27	2.96	2.96	3.55	-	12.00 (3.50-13.30)	3.928 (0.890-5.780)	17.25	99
15+15+35+35+50	1.21	1.21	2.82	2.82	4.03	-	12.10 (3.50-13.30)	3.955 (0.890-5.780)	17.37	99
15+15+35+35+60	1.13	1.13	2.65	2.65	4.54	-	12.10 (3.50-13.30)	3.990 (0.890-5.780)	17.52	99
15+15+35+35+71	1.07	1.07	2.50	2.50	5.07	-	12.20 (3.50-13.40)	4.030 (0.890-5.790)	17.70	99
15+15+35+42+42	1.21	1.21	2.82	3.38	3.38	-	12.00 (3.50-13.30)	3.952 (0.890-5.780)	17.36	99
15+15+35+42+50	1.16	1.16	2.70	3.24	3.85	-	12.10 (3.50-13.30)	3.977 (0.890-5.780)	17.47	99
15+15+35+42+60	1.10	1.10	2.56	3.07	4.38	-	12.20 (3.50-13.40)	4.025 (0.890-5.790)	17.68	99
15+15+35+42+71	1.03	1.03	2.40	2.88	4.87	-	12.20 (3.50-13.40)	4.030 (0.890-5.790)	17.70	99
15+15+35+50+50	1.10	1.10	2.57	3.67	3.67	-	12.10 (3.50-13.30)	4.015 (0.890-5.780)	17.63	99
15+15+35+50+60	1.05	1.05	2.44	3.49	4.18	-	12.20 (3.50-13.40)	4.030 (0.890-5.790)	17.70	99
15+15+42+42+42	1.16	1.16	3.26	3.26	3.26	-	12.10 (3.50-13.30)	3.974 (0.890-5.780)	17.45	99
15+15+42+42+50	1.11	1.11	3.10	3.10	3.69	-	12.10 (3.50-13.30)	4.010 (0.890-5.780)	17.61	99
15+15+42+42+60	1.05	1.05	2.94	2.94	4.21	-	12.20 (3.50-13.40)	4.030 (0.890-5.790)	17.70	99
15+15+42+50+50	1.06	1.06	2.98	3.55	3.55	-	12.20 (3.50-13.40)	4.030 (0.890-5.790)	17.70	99
15+15+50+50+50	1.02	1.02	3.39	3.39	3.39	-	12.20 (3.50-13.40)	4.030 (0.890-5.790)	17.70	99
15+20+20+20+20	1.50	2.00	2.00	2.00	2.00	-	9.50 (3.30-11.50)	2.846 (0.930-5.350)	12.50	99
15+20+20+20+22	1.50	2.00	2.00	2.00	2.20	-	9.70 (3.30-11.60)	2.951 (0.930-5.390)	12.96	99
15+20+20+20+25	1.50	2.00	2.00	2.00	2.50	-	10.00 (3.30-11.80)	3.108 (0.930-5.480)	13.65	99
15+20+20+20+35	1.50	2.00	2.00	2.00	3.50	-	11.00 (3.50-13.20)	3.385 (0.890-5.810)	14.87	99
15+20+20+20+42	1.46	1.95	1.95	1.95	4.09	-	11.40 (3.50-13.20)	3.547 (0.890-5.790)	15.58	99
15+20+20+20+50	1.43	1.90	1.90	1.90	4.76	-	11.90 (3.50-13.20)	3.730 (0.890-5.760)	16.38	99
15+20+20+20+60	1.33	1.78	1.78	1.78	5.33	-	12.00 (3.50-13.30)	3.902 (0.890-5.780)	17.13	99
15+20+20+20+71	1.23	1.64	1.64	1.64	5.84	-	12.00 (3.50-13.30)	3.943 (0.890-5.780)	17.32	99

MXZ-6C122VA COOLING

Indoor units combination	Cooling Capacity (kW)							Outdoor unit power consumption (kW)	Current (A)	Power factor (%)
	Unit A	Unit B	Unit C	Unit D	Unit E	Unit F	Total			
15+20+20+22+22	1.50	2.00	2.00	2.20	2.20	-	9.90 (3.30-11.70)	3.055 (0.930-5.440)	13.42	99
15+20+20+22+25	1.50	2.00	2.00	2.20	2.50	-	10.20 (3.30-12.10)	3.185 (0.920-5.550)	13.99	99
15+20+20+22+35	1.49	1.98	1.98	2.18	3.47	-	11.10 (3.50-13.20)	3.433 (0.890-5.800)	15.08	99
15+20+20+22+42	1.45	1.93	1.93	2.13	4.06	-	11.50 (3.50-13.20)	3.593 (0.890-5.780)	15.78	99
15+20+20+22+50	1.41	1.87	1.87	2.06	4.69	-	11.90 (3.50-13.20)	3.776 (0.890-5.760)	16.58	99
15+20+20+22+60	1.31	1.75	1.75	1.93	5.26	-	12.00 (3.50-13.30)	3.909 (0.890-5.780)	17.17	99
15+20+20+22+71	1.22	1.62	1.62	1.78	5.76	-	12.00 (3.50-13.30)	3.949 (0.890-5.780)	17.34	99
15+20+20+25+25	1.50	2.00	2.00	2.50	2.50	-	10.50 (3.40-12.50)	3.260 (0.910-5.650)	14.32	99
15+20+20+25+35	1.47	1.97	1.97	2.46	3.44	-	11.30 (3.50-13.20)	3.501 (0.890-5.790)	15.38	99
15+20+20+25+42	1.44	1.92	1.92	2.40	4.03	-	11.70 (3.50-13.20)	3.661 (0.890-5.770)	16.08	99
15+20+20+25+50	1.37	1.83	1.83	2.29	4.58	-	11.90 (3.50-13.20)	3.844 (0.890-5.760)	16.88	99
15+20+20+25+60	1.29	1.71	1.71	2.14	5.14	-	12.00 (3.50-13.30)	3.921 (0.890-5.780)	17.22	99
15+20+20+25+71	1.20	1.60	1.60	2.00	5.69	-	12.10 (3.50-13.30)	3.958 (0.890-5.780)	17.38	99
15+20+20+35+35	1.43	1.90	1.90	3.33	3.33	-	11.90 (3.50-13.20)	3.730 (0.890-5.760)	16.38	99
15+20+20+35+42	1.35	1.80	1.80	3.16	3.79	-	11.90 (3.50-13.20)	3.890 (0.890-5.760)	17.08	99
15+20+20+35+50	1.29	1.71	1.71	3.00	4.29	-	12.00 (3.50-13.30)	3.921 (0.890-5.780)	17.22	99
15+20+20+35+60	1.21	1.61	1.61	2.82	4.84	-	12.10 (3.50-13.30)	3.955 (0.890-5.780)	17.37	99
15+20+20+35+71	1.13	1.50	1.50	2.63	5.34	-	12.10 (3.50-13.30)	3.995 (0.890-5.780)	17.55	99
15+20+20+42+42	1.29	1.73	1.73	3.63	3.63	-	12.00 (3.50-13.30)	3.917 (0.890-5.780)	17.20	99
15+20+20+42+50	1.22	1.63	1.63	3.43	4.08	-	12.00 (3.50-13.30)	3.946 (0.890-5.780)	17.33	99
15+20+20+42+60	1.16	1.54	1.54	3.24	4.62	-	12.10 (3.50-13.30)	3.977 (0.890-5.780)	17.47	99
15+20+20+42+71	1.09	1.45	1.45	3.05	5.16	-	12.20 (3.50-13.40)	4.030 (0.890-5.790)	17.70	99
15+20+20+50+50	1.17	1.56	1.56	3.90	3.90	-	12.10 (3.50-13.30)	3.971 (0.890-5.780)	17.44	99
15+20+20+50+60	1.10	1.47	1.47	3.67	4.40	-	12.10 (3.50-13.30)	4.015 (0.890-5.780)	17.63	99
15+20+20+50+71	1.04	1.39	1.39	3.47	4.92	-	12.20 (3.50-13.40)	4.030 (0.890-5.790)	17.70	99
15+20+20+60+60	1.05	1.39	1.39	4.18	4.18	-	12.20 (3.50-13.40)	4.030 (0.890-5.790)	17.70	99
15+20+22+22+22	1.50	2.00	2.20	2.20	2.20	-	10.10 (3.30-11.90)	3.160 (0.930-5.500)	13.88	99
15+20+22+22+25	1.50	2.00	2.20	2.20	2.50	-	10.40 (3.40-12.40)	3.235 (0.910-5.620)	14.21	99
15+20+22+22+35	1.47	1.96	2.16	2.16	3.44	-	11.20 (3.50-13.20)	3.479 (0.890-5.800)	15.28	99
15+20+22+22+42	1.45	1.93	2.13	2.13	4.06	-	11.70 (3.50-13.20)	3.639 (0.890-5.770)	15.98	99
15+20+22+22+50	1.38	1.84	2.03	2.03	4.61	-	11.90 (3.50-13.20)	3.821 (0.890-5.760)	16.78	99
15+20+22+22+60	1.29	1.73	1.90	1.90	5.18	-	12.00 (3.50-13.30)	3.917 (0.890-5.780)	17.20	99
15+20+22+22+71	1.21	1.61	1.77	1.77	5.73	-	12.10 (3.50-13.30)	3.955 (0.890-5.780)	17.37	99
15+20+22+25+25	1.50	2.00	2.20	2.50	2.50	-	10.70 (3.40-12.80)	3.310 (0.900-5.720)	14.54	99
15+20+22+25+35	1.46	1.95	2.14	2.44	3.41	-	11.40 (3.50-13.20)	3.547 (0.890-5.790)	15.58	99
15+20+22+25+42	1.43	1.90	2.09	2.38	4.00	-	11.80 (3.50-13.20)	3.707 (0.890-5.760)	16.28	99
15+20+22+25+50	1.35	1.80	1.98	2.25	4.51	-	11.90 (3.50-13.20)	3.890 (0.890-5.760)	17.08	99
15+20+22+25+60	1.27	1.69	1.86	2.11	5.07	-	12.00 (3.50-13.30)	3.928 (0.890-5.780)	17.25	99
15+20+22+25+71	1.19	1.58	1.74	1.98	5.62	-	12.10 (3.50-13.30)	3.965 (0.890-5.780)	17.41	99
15+20+22+35+35	1.41	1.87	2.06	3.28	3.28	-	11.90 (3.50-13.20)	3.776 (0.890-5.760)	16.58	99
15+20+22+35+42	1.34	1.79	1.97	3.13	3.76	-	12.00 (3.50-13.30)	3.898 (0.890-5.780)	17.12	99
15+20+22+35+50	1.27	1.69	1.86	2.96	4.23	-	12.00 (3.50-13.30)	3.928 (0.890-5.780)	17.25	99
15+20+22+35+60	1.19	1.59	1.75	2.79	4.78	-	12.10 (3.50-13.30)	3.962 (0.890-5.780)	17.40	99
15+20+22+35+71	1.11	1.48	1.63	2.60	5.27	-	12.10 (3.50-13.30)	4.005 (0.890-5.780)	17.59	99
15+20+22+42+42	1.28	1.70	1.87	3.57	3.57	-	12.00 (3.50-13.30)	3.925 (0.890-5.780)	17.24	99
15+20+22+42+50	1.21	1.61	1.77	3.38	4.03	-	12.00 (3.50-13.30)	3.952 (0.890-5.780)	17.36	99

MXZ-6C122VA COOLING

Indoor units combination	Cooling Capacity (kW)							Outdoor unit power consumption (kW)	Current (A)	Power factor (%)
	Unit A	Unit B	Unit C	Unit D	Unit E	Unit F	Total			
15+20+22+42+60	1.14	1.52	1.67	3.20	4.57	-	12.10 (3.50-13.30)	3.985 (0.890-5.780)	17.50	99
15+20+22+42+71	1.08	1.44	1.58	3.01	5.10	-	12.20 (3.50-13.40)	4.030 (0.890-5.790)	17.70	99
15+20+22+50+50	1.16	1.54	1.70	3.85	3.85	-	12.10 (3.50-13.30)	3.977 (0.890-5.780)	17.47	99
15+20+22+50+60	1.10	1.46	1.61	3.65	4.38	-	12.20 (3.50-13.40)	4.025 (0.890-5.790)	17.68	99
15+20+22+50+71	1.03	1.37	1.51	3.43	4.87	-	12.20 (3.50-13.40)	4.030 (0.890-5.790)	17.70	99
15+20+22+60+60	1.03	1.38	1.52	4.14	4.14	-	12.20 (3.50-13.40)	4.030 (0.890-5.790)	17.70	99
15+20+25+25+25	1.50	2.00	2.50	2.50	2.50	-	11.00 (3.50-13.20)	3.385 (0.890-5.810)	14.87	99
15+20+25+25+35	1.45	1.93	2.42	2.42	3.38	-	11.60 (3.50-13.20)	3.616 (0.890-5.780)	15.88	99
15+20+25+25+42	1.41	1.87	2.34	2.34	3.94	-	11.90 (3.50-13.20)	3.776 (0.890-5.760)	16.58	99
15+20+25+25+50	1.33	1.78	2.22	2.22	4.44	-	12.00 (3.50-13.30)	3.902 (0.890-5.780)	17.13	99
15+20+25+25+60	1.24	1.66	2.07	2.07	4.97	-	12.00 (3.50-13.30)	3.940 (0.890-5.780)	17.30	99
15+20+25+25+71	1.16	1.55	1.94	1.94	5.51	-	12.10 (3.50-13.30)	3.974 (0.890-5.780)	17.45	99
15+20+25+35+35	1.37	1.83	2.29	3.20	3.20	-	11.90 (3.50-13.20)	3.844 (0.890-5.760)	16.88	99
15+20+25+35+42	1.31	1.75	2.19	3.07	3.68	-	12.00 (3.50-13.30)	3.909 (0.890-5.780)	17.17	99
15+20+25+35+50	1.24	1.66	2.07	2.90	4.14	-	12.00 (3.50-13.30)	3.940 (0.890-5.780)	17.30	99
15+20+25+35+60	1.17	1.56	1.95	2.73	4.68	-	12.10 (3.50-13.30)	3.971 (0.890-5.780)	17.44	99
15+20+25+35+71	1.09	1.46	1.82	2.55	5.18	-	12.10 (3.50-13.30)	4.020 (0.890-5.780)	17.65	99
15+20+25+42+42	1.25	1.67	2.08	3.50	3.50	-	12.00 (3.50-13.30)	3.936 (0.890-5.780)	17.29	99
15+20+25+42+50	1.19	1.59	1.99	3.34	3.98	-	12.10 (3.50-13.30)	3.962 (0.890-5.780)	17.40	99
15+20+25+42+60	1.12	1.49	1.87	3.14	4.48	-	12.10 (3.50-13.30)	4.000 (0.890-5.780)	17.57	99
15+20+25+42+71	1.06	1.41	1.76	2.96	5.01	-	12.20 (3.50-13.40)	4.030 (0.890-5.790)	17.70	99
15+20+25+50+50	1.13	1.51	1.89	3.78	3.78	-	12.10 (3.50-13.30)	3.990 (0.890-5.780)	17.52	99
15+20+25+50+60	1.08	1.44	1.79	3.59	4.31	-	12.20 (3.50-13.40)	4.030 (0.890-5.790)	17.70	99
15+20+25+60+60	1.02	1.36	1.69	4.07	4.07	-	12.20 (3.50-13.40)	4.030 (0.890-5.790)	17.70	99
15+20+35+35+35	1.29	1.71	3.00	3.00	3.00	-	12.00 (3.50-13.30)	3.921 (0.890-5.780)	17.22	99
15+20+35+35+42	1.22	1.63	2.86	2.86	3.43	-	12.00 (3.50-13.30)	3.946 (0.890-5.780)	17.33	99
15+20+35+35+50	1.17	1.56	2.73	2.73	3.90	-	12.10 (3.50-13.30)	3.971 (0.890-5.780)	17.44	99
15+20+35+35+60	1.10	1.47	2.57	2.57	4.40	-	12.10 (3.50-13.30)	4.015 (0.890-5.780)	17.63	99
15+20+35+35+71	1.04	1.39	2.43	2.43	4.92	-	12.20 (3.50-13.40)	4.030 (0.890-5.790)	17.70	99
15+20+35+42+42	1.18	1.57	2.75	3.30	3.30	-	12.10 (3.50-13.30)	3.968 (0.890-5.780)	17.43	99
15+20+35+42+50	1.12	1.49	2.61	3.14	3.73	-	12.10 (3.50-13.30)	4.000 (0.890-5.780)	17.57	99
15+20+35+42+60	1.06	1.42	2.48	2.98	4.26	-	12.20 (3.50-13.40)	4.030 (0.890-5.790)	17.70	99
15+20+35+50+50	1.08	1.44	2.51	3.59	3.59	-	12.20 (3.50-13.40)	4.030 (0.890-5.790)	17.70	99
15+20+35+50+60	1.02	1.36	2.37	3.39	4.07	-	12.20 (3.50-13.40)	4.030 (0.890-5.790)	17.70	99
15+20+42+42+42	1.13	1.50	3.16	3.16	3.16	-	12.10 (3.50-13.30)	3.995 (0.890-5.780)	17.55	99
15+20+42+42+50	1.08	1.44	3.03	3.03	3.61	-	12.20 (3.50-13.40)	4.030 (0.890-5.790)	17.70	99
15+20+42+42+60	1.02	1.36	2.86	2.86	4.09	-	12.20 (3.50-13.40)	4.030 (0.890-5.790)	17.70	99
15+20+42+50+50	1.03	1.38	2.89	3.45	3.45	-	12.20 (3.50-13.40)	4.030 (0.890-5.790)	17.70	99
15+22+22+22+22	1.50	2.20	2.20	2.20	2.20	-	10.30 (3.40-12.20)	3.210 (0.920-5.570)	14.10	99
15+22+22+22+25	1.50	2.20	2.20	2.20	2.50	-	10.60 (3.40-12.60)	3.285 (0.910-5.670)	14.43	99
15+22+22+22+35	1.47	2.16	2.16	2.16	3.44	-	11.40 (3.50-13.20)	3.524 (0.890-5.790)	15.48	99
15+22+22+22+42	1.44	2.11	2.11	2.11	4.03	-	11.80 (3.50-13.20)	3.684 (0.890-5.770)	16.18	99
15+22+22+22+50	1.36	2.00	2.00	2.00	4.54	-	11.90 (3.50-13.20)	3.867 (0.890-5.760)	16.98	99
15+22+22+22+60	1.28	1.87	1.87	1.87	5.11	-	12.00 (3.50-13.30)	3.925 (0.890-5.780)	17.24	99
15+22+22+22+71	1.19	1.75	1.75	1.75	5.65	-	12.10 (3.50-13.30)	3.962 (0.890-5.780)	17.40	99
15+22+22+25+25	1.50	2.20	2.20	2.50	2.50	-	10.90 (3.50-13.10)	3.360 (0.890-5.790)	14.76	99

MXZ-6C122VA COOLING

Indoor units combination	Cooling Capacity (kW)							Outdoor unit power consumption (kW)	Current (A)	Power factor (%)
	Unit A	Unit B	Unit C	Unit D	Unit E	Unit F	Total			
15+15+15+35+35+35	1.22	1.22	1.22	2.85	2.85	2.85	12.20 (3.50-13.50)	3.966 (0.880-5.320)	17.42	99
15+15+15+35+35+42	1.17	1.17	1.17	2.72	2.72	3.26	12.20 (3.50-13.50)	3.962 (0.880-5.320)	17.40	99
15+15+15+35+35+50	1.11	1.11	1.11	2.59	2.59	3.70	12.20 (3.50-13.50)	3.958 (0.880-5.320)	17.38	99
15+15+15+35+35+60	1.05	1.05	1.05	2.44	2.44	4.18	12.20 (3.50-13.50)	3.953 (0.880-5.320)	17.36	99
15+15+15+35+42+42	1.12	1.12	1.12	2.60	3.12	3.12	12.20 (3.50-13.50)	3.959 (0.880-5.320)	17.38	99
15+15+15+35+42+50	1.06	1.06	1.06	2.48	2.98	3.55	12.20 (3.50-13.50)	3.954 (0.880-5.320)	17.37	99
15+15+15+35+50+50	1.02	1.02	1.02	2.37	3.39	3.39	12.20 (3.50-13.50)	3.950 (0.880-5.320)	17.35	99
15+15+15+42+42+42	1.07	1.07	1.07	3.00	3.00	3.00	12.20 (3.50-13.50)	3.955 (0.880-5.320)	17.37	99
15+15+15+42+42+50	1.02	1.02	1.02	2.86	2.86	3.41	12.20 (3.50-13.50)	3.951 (0.880-5.320)	17.35	99
15+15+20+20+20+20	1.45	1.45	1.93	1.93	1.93	1.93	10.60 (3.30-12.50)	3.401 (0.910-5.630)	14.94	99
15+15+20+20+20+22	1.45	1.45	1.93	1.93	1.93	2.12	10.80 (3.30-12.60)	3.503 (0.910-5.650)	15.38	99
15+15+20+20+20+25	1.43	1.43	1.91	1.91	1.91	2.39	11.00 (3.30-12.60)	3.656 (0.910-5.650)	16.06	99
15+15+20+20+20+35	1.40	1.40	1.87	1.87	1.87	3.28	11.70 (3.40-13.10)	3.930 (0.900-5.490)	17.26	99
15+15+20+20+20+42	1.36	1.36	1.82	1.82	1.82	3.82	12.00 (3.50-13.50)	3.998 (0.880-5.370)	17.56	99
15+15+20+20+20+50	1.31	1.31	1.74	1.74	1.74	4.36	12.20 (3.50-13.50)	3.984 (0.880-5.350)	17.50	99
15+15+20+20+20+60	1.22	1.22	1.63	1.63	1.63	4.88	12.20 (3.50-13.50)	3.966 (0.880-5.320)	17.42	99
15+15+20+20+20+71	1.14	1.14	1.52	1.52	1.52	5.38	12.20 (3.50-13.50)	3.960 (0.880-5.320)	17.39	99
15+15+20+20+22+22	1.43	1.43	1.91	1.91	2.10	2.10	10.90 (3.30-12.60)	3.605 (0.910-5.650)	15.83	99
15+15+20+20+22+25	1.44	1.44	1.91	1.91	2.11	2.39	11.20 (3.30-12.60)	3.758 (0.910-5.650)	16.50	99
15+15+20+20+22+35	1.39	1.39	1.86	1.86	2.04	3.25	11.80 (3.40-13.20)	3.953 (0.890-5.460)	17.36	99
15+15+20+20+22+42	1.35	1.35	1.81	1.81	1.99	3.79	12.10 (3.50-13.50)	3.995 (0.880-5.360)	17.54	99
15+15+20+20+22+50	1.29	1.29	1.72	1.72	1.89	4.30	12.20 (3.50-13.50)	3.980 (0.880-5.340)	17.48	99
15+15+20+20+22+60	1.20	1.20	1.61	1.61	1.77	4.82	12.20 (3.50-13.50)	3.965 (0.880-5.320)	17.41	99
15+15+20+20+22+71	1.12	1.12	1.50	1.50	1.65	5.31	12.20 (3.50-13.50)	3.959 (0.880-5.320)	17.39	99
15+15+20+20+25+25	1.43	1.43	1.90	1.90	2.38	2.38	11.40 (3.30-12.80)	3.872 (0.910-5.590)	17.00	99
15+15+20+20+25+35	1.37	1.37	1.83	1.83	2.29	3.20	11.90 (3.50-13.50)	3.988 (0.880-5.370)	17.52	99
15+15+20+20+25+42	1.32	1.32	1.77	1.77	2.21	3.71	12.10 (3.50-13.50)	3.989 (0.880-5.350)	17.52	99
15+15+20+20+25+50	1.26	1.26	1.68	1.68	2.10	4.21	12.20 (3.50-13.50)	3.975 (0.880-5.330)	17.46	99
15+15+20+20+25+60	1.18	1.18	1.57	1.57	1.97	4.72	12.20 (3.50-13.50)	3.963 (0.880-5.320)	17.41	99
15+15+20+20+25+71	1.10	1.10	1.47	1.47	1.84	5.22	12.20 (3.50-13.50)	3.957 (0.880-5.320)	17.38	99
15+15+20+20+35+35	1.31	1.31	1.74	1.74	3.05	3.05	12.20 (3.50-13.50)	3.984 (0.880-5.350)	17.50	99
15+15+20+20+35+42	1.24	1.24	1.66	1.66	2.90	3.49	12.20 (3.50-13.50)	3.971 (0.880-5.330)	17.44	99
15+15+20+20+35+50	1.18	1.18	1.57	1.57	2.75	3.94	12.20 (3.50-13.50)	3.963 (0.880-5.320)	17.41	99
15+15+20+20+35+60	1.11	1.11	1.48	1.48	2.59	4.44	12.20 (3.50-13.50)	3.958 (0.880-5.320)	17.38	99
15+15+20+20+35+71	1.04	1.04	1.39	1.39	2.43	4.92	12.20 (3.50-13.50)	3.952 (0.880-5.320)	17.36	99
15+15+20+20+42+42	1.19	1.19	1.58	1.58	3.33	3.33	12.20 (3.50-13.50)	3.964 (0.880-5.320)	17.41	99
15+15+20+20+42+50	1.13	1.13	1.51	1.51	3.16	3.77	12.20 (3.50-13.50)	3.960 (0.880-5.320)	17.39	99
15+15+20+20+42+60	1.06	1.06	1.42	1.42	2.98	4.26	12.20 (3.50-13.50)	3.954 (0.880-5.320)	17.37	99
15+15+20+20+50+50	1.08	1.08	1.44	1.44	3.59	3.59	12.20 (3.50-13.50)	3.955 (0.880-5.320)	17.37	99
15+15+20+20+50+60	1.02	1.02	1.36	1.36	3.39	4.07	12.20 (3.50-13.50)	3.950 (0.880-5.320)	17.35	99
15+15+20+22+22+22	1.44	1.44	1.91	2.11	2.11	2.11	11.10 (3.30-12.60)	3.707 (0.910-5.650)	16.28	99
15+15+20+22+22+25	1.42	1.42	1.90	2.09	2.09	2.37	11.30 (3.30-12.60)	3.860 (0.910-5.650)	16.95	99
15+15+20+22+22+35	1.38	1.38	1.84	2.03	2.03	3.23	11.90 (3.50-13.40)	3.977 (0.890-5.400)	17.46	99
15+15+20+22+22+42	1.33	1.33	1.78	1.96	1.96	3.74	12.10 (3.50-13.50)	3.991 (0.880-5.360)	17.53	99
15+15+20+22+22+50	1.27	1.27	1.69	1.86	1.86	4.24	12.20 (3.50-13.50)	3.977 (0.880-5.330)	17.46	99
15+15+20+22+22+60	1.19	1.19	1.58	1.74	1.74	4.75	12.20 (3.50-13.50)	3.964 (0.880-5.320)	17.41	99

MXZ-6C122VA COOLING

Indoor units combination	Cooling Capacity (kW)							Outdoor unit power consumption (kW)	Current (A)	Power factor (%)
	Unit A	Unit B	Unit C	Unit D	Unit E	Unit F	Total			
15+15+20+22+22+71	1.11	1.11	1.48	1.63	1.63	5.25	12.20 (3.50-13.50)	3.958 (0.880-5.320)	17.38	99
15+15+20+22+25+25	1.41	1.41	1.89	2.07	2.36	2.36	11.50 (3.40-12.90)	3.895 (0.900-5.560)	17.11	99
15+15+20+22+25+35	1.36	1.36	1.82	2.00	2.27	3.18	12.00 (3.50-13.50)	3.998 (0.880-5.370)	17.56	99
15+15+20+22+25+42	1.32	1.32	1.76	1.93	2.19	3.69	12.20 (3.50-13.50)	3.986 (0.880-5.350)	17.50	99
15+15+20+22+25+50	1.24	1.24	1.66	1.83	2.07	4.15	12.20 (3.50-13.50)	3.971 (0.880-5.330)	17.44	99
15+15+20+22+25+60	1.17	1.17	1.55	1.71	1.94	4.66	12.20 (3.50-13.50)	3.962 (0.880-5.320)	17.40	99
15+15+20+22+25+71	1.09	1.09	1.45	1.60	1.82	5.16	12.20 (3.50-13.50)	3.956 (0.880-5.320)	17.38	99
15+15+20+22+35+35	1.29	1.29	1.72	1.89	3.01	3.01	12.20 (3.50-13.50)	3.980 (0.880-5.340)	17.48	99
15+15+20+22+35+42	1.23	1.23	1.64	1.80	2.87	3.44	12.20 (3.50-13.50)	3.968 (0.880-5.320)	17.43	99
15+15+20+22+35+50	1.17	1.17	1.55	1.71	2.72	3.89	12.20 (3.50-13.50)	3.962 (0.880-5.320)	17.40	99
15+15+20+22+35+60	1.10	1.10	1.46	1.61	2.56	4.38	12.20 (3.50-13.50)	3.957 (0.880-5.320)	17.38	99
15+15+20+22+35+71	1.03	1.03	1.37	1.51	2.40	4.87	12.20 (3.50-13.50)	3.951 (0.880-5.320)	17.35	99
15+15+20+22+42+42	1.17	1.17	1.56	1.72	3.28	3.28	12.20 (3.50-13.50)	3.963 (0.880-5.320)	17.40	99
15+15+20+22+42+50	1.12	1.12	1.49	1.64	3.12	3.72	12.20 (3.50-13.50)	3.959 (0.880-5.320)	17.38	99
15+15+20+22+42+60	1.05	1.05	1.40	1.54	2.94	4.21	12.20 (3.50-13.50)	3.953 (0.880-5.320)	17.36	99
15+15+20+22+50+50	1.06	1.06	1.42	1.56	3.55	3.55	12.20 (3.50-13.50)	3.954 (0.880-5.320)	17.37	99
15+15+20+25+25+25	1.40	1.40	1.87	2.34	2.34	2.34	11.70 (3.40-13.10)	3.930 (0.900-5.490)	17.26	99
15+15+20+25+25+35	1.34	1.34	1.79	2.24	2.24	3.14	12.10 (3.50-13.50)	3.993 (0.880-5.360)	17.54	99
15+15+20+25+25+42	1.29	1.29	1.72	2.15	2.15	3.61	12.20 (3.50-13.50)	3.980 (0.880-5.340)	17.48	99
15+15+20+25+25+50	1.22	1.22	1.63	2.03	2.03	4.07	12.20 (3.50-13.50)	3.966 (0.880-5.320)	17.42	99
15+15+20+25+25+60	1.14	1.14	1.53	1.91	1.91	4.58	12.20 (3.50-13.50)	3.961 (0.880-5.320)	17.39	99
15+15+20+25+25+71	1.07	1.07	1.43	1.78	1.78	5.07	12.20 (3.50-13.50)	3.955 (0.880-5.320)	17.37	99
15+15+20+25+35+35	1.26	1.26	1.68	2.10	2.94	2.94	12.20 (3.50-13.50)	3.975 (0.880-5.330)	17.46	99
15+15+20+25+35+42	1.20	1.20	1.61	2.01	2.81	3.37	12.20 (3.50-13.50)	3.965 (0.880-5.320)	17.41	99
15+15+20+25+35+50	1.14	1.14	1.53	1.91	2.67	3.81	12.20 (3.50-13.50)	3.961 (0.880-5.320)	17.39	99
15+15+20+25+35+60	1.08	1.08	1.44	1.79	2.51	4.31	12.20 (3.50-13.50)	3.955 (0.880-5.320)	17.37	99
15+15+20+25+42+42	1.15	1.15	1.53	1.92	3.22	3.22	12.20 (3.50-13.50)	3.961 (0.880-5.320)	17.40	99
15+15+20+25+42+50	1.10	1.10	1.46	1.83	3.07	3.65	12.20 (3.50-13.50)	3.957 (0.880-5.320)	17.38	99
15+15+20+25+42+60	1.03	1.03	1.38	1.72	2.89	4.14	12.20 (3.50-13.50)	3.952 (0.880-5.320)	17.35	99
15+15+20+25+50+50	1.05	1.05	1.39	1.74	3.49	3.49	12.20 (3.50-13.50)	3.953 (0.880-5.320)	17.36	99
15+15+20+35+35+35	1.18	1.18	1.57	2.75	2.75	2.75	12.20 (3.50-13.50)	3.963 (0.880-5.320)	17.41	99
15+15+20+35+35+42	1.13	1.13	1.51	2.64	2.64	3.16	12.20 (3.50-13.50)	3.960 (0.880-5.320)	17.39	99
15+15+20+35+35+50	1.08	1.08	1.44	2.51	2.51	3.59	12.20 (3.50-13.50)	3.955 (0.880-5.320)	17.37	99
15+15+20+35+35+60	1.02	1.02	1.36	2.37	2.37	4.07	12.20 (3.50-13.50)	3.950 (0.880-5.320)	17.35	99
15+15+20+35+42+42	1.08	1.08	1.44	2.53	3.03	3.03	12.20 (3.50-13.50)	3.956 (0.880-5.320)	17.37	99
15+15+20+35+42+50	1.03	1.03	1.38	2.41	2.89	3.45	12.20 (3.50-13.50)	3.952 (0.880-5.320)	17.35	99
15+15+20+42+42+42	1.04	1.04	1.39	2.91	2.91	2.91	12.20 (3.50-13.50)	3.952 (0.880-5.320)	17.36	99
15+15+22+22+22+22	1.42	1.42	2.09	2.09	2.09	2.09	11.20 (3.30-12.60)	3.809 (0.910-5.650)	16.73	99
15+15+22+22+22+25	1.43	1.43	2.09	2.09	2.09	2.38	11.50 (3.30-12.80)	3.883 (0.910-5.590)	17.05	99
15+15+22+22+22+35	1.37	1.37	2.02	2.02	2.02	3.21	12.00 (3.50-13.50)	4.000 (0.880-5.370)	17.57	99
15+15+22+22+22+42	1.33	1.33	1.94	1.94	1.94	3.71	12.20 (3.50-13.50)	3.987 (0.880-5.350)	17.51	99
15+15+22+22+22+50	1.25	1.25	1.84	1.84	1.84	4.18	12.20 (3.50-13.50)	3.973 (0.880-5.330)	17.45	99
15+15+22+22+22+60	1.17	1.17	1.72	1.72	1.72	4.69	12.20 (3.50-13.50)	3.963 (0.880-5.320)	17.40	99
15+15+22+22+22+71	1.10	1.10	1.61	1.61	1.61	5.19	12.20 (3.50-13.50)	3.957 (0.880-5.320)	17.38	99
15+15+22+22+25+25	1.40	1.40	2.06	2.06	2.34	2.34	11.60 (3.40-13.10)	3.918 (0.900-5.490)	17.21	99
15+15+22+22+25+35	1.35	1.35	1.99	1.99	2.26	3.16	12.10 (3.50-13.50)	3.995 (0.880-5.360)	17.54	99

MXZ-6C122VA COOLING

Indoor units combination	Cooling Capacity (kW)							Outdoor unit power consumption (kW)	Current (A)	Power factor (%)
	Unit A	Unit B	Unit C	Unit D	Unit E	Unit F	Total			
15+15+22+22+25+42	1.30	1.30	1.90	1.90	2.16	3.63	12.20 (3.50-13.50)	3.982 (0.880-5.340)	17.49	99
15+15+22+22+25+50	1.23	1.23	1.80	1.80	2.05	4.09	12.20 (3.50-13.50)	3.968 (0.880-5.320)	17.43	99
15+15+22+22+25+60	1.15	1.15	1.69	1.69	1.92	4.60	12.20 (3.50-13.50)	3.961 (0.880-5.320)	17.40	99
15+15+22+22+25+71	1.08	1.08	1.58	1.58	1.79	5.10	12.20 (3.50-13.50)	3.955 (0.880-5.320)	17.37	99
15+15+22+22+35+35	1.27	1.27	1.86	1.86	2.97	2.97	12.20 (3.50-13.50)	3.977 (0.880-5.330)	17.46	99
15+15+22+22+35+42	1.21	1.21	1.78	1.78	2.83	3.39	12.20 (3.50-13.50)	3.965 (0.880-5.320)	17.42	99
15+15+22+22+35+50	1.15	1.15	1.69	1.69	2.69	3.84	12.20 (3.50-13.50)	3.961 (0.880-5.320)	17.40	99
15+15+22+22+35+60	1.08	1.08	1.59	1.59	2.53	4.33	12.20 (3.50-13.50)	3.956 (0.880-5.320)	17.37	99
15+15+22+22+35+71	1.02	1.02	1.49	1.49	2.37	4.81	12.20 (3.50-13.50)	3.950 (0.880-5.320)	17.35	99
15+15+22+22+42+42	1.16	1.16	1.70	1.70	3.24	3.24	12.20 (3.50-13.50)	3.962 (0.880-5.320)	17.40	99
15+15+22+22+42+50	1.10	1.10	1.62	1.62	3.09	3.67	12.20 (3.50-13.50)	3.957 (0.880-5.320)	17.38	99
15+15+22+22+42+60	1.04	1.04	1.53	1.53	2.91	4.16	12.20 (3.50-13.50)	3.952 (0.880-5.320)	17.36	99
15+15+22+22+50+50	1.05	1.05	1.54	1.54	3.51	3.51	12.20 (3.50-13.50)	3.953 (0.880-5.320)	17.36	99
15+15+22+25+25+25	1.39	1.39	2.04	2.32	2.32	2.32	11.80 (3.40-13.20)	3.953 (0.890-5.460)	17.36	99
15+15+22+25+25+35	1.32	1.32	1.94	2.21	2.21	3.09	12.10 (3.50-13.50)	3.989 (0.880-5.350)	17.52	99
15+15+22+25+25+42	1.27	1.27	1.86	2.12	2.12	3.56	12.20 (3.50-13.50)	3.977 (0.880-5.330)	17.46	99
15+15+22+25+25+50	1.20	1.20	1.77	2.01	2.01	4.01	12.20 (3.50-13.50)	3.965 (0.880-5.320)	17.41	99
15+15+22+25+25+60	1.13	1.13	1.66	1.88	1.88	4.52	12.20 (3.50-13.50)	3.960 (0.880-5.320)	17.39	99
15+15+22+25+25+71	1.06	1.06	1.55	1.76	1.76	5.01	12.20 (3.50-13.50)	3.954 (0.880-5.320)	17.36	99
15+15+22+25+35+35	1.24	1.24	1.83	2.07	2.90	2.90	12.20 (3.50-13.50)	3.971 (0.880-5.330)	17.44	99
15+15+22+25+35+42	1.19	1.19	1.74	1.98	2.77	3.33	12.20 (3.50-13.50)	3.964 (0.880-5.320)	17.41	99
15+15+22+25+35+50	1.13	1.13	1.66	1.88	2.64	3.77	12.20 (3.50-13.50)	3.960 (0.880-5.320)	17.39	99
15+15+22+25+35+60	1.06	1.06	1.56	1.77	2.48	4.26	12.20 (3.50-13.50)	3.954 (0.880-5.320)	17.37	99
15+15+22+25+42+42	1.14	1.14	1.67	1.89	3.18	3.18	12.20 (3.50-13.50)	3.960 (0.880-5.320)	17.39	99
15+15+22+25+42+50	1.08	1.08	1.59	1.80	3.03	3.61	12.20 (3.50-13.50)	3.956 (0.880-5.320)	17.37	99
15+15+22+25+42+60	1.02	1.02	1.50	1.70	2.86	4.09	12.20 (3.50-13.50)	3.951 (0.880-5.320)	17.35	99
15+15+22+25+50+50	1.03	1.03	1.52	1.72	3.45	3.45	12.20 (3.50-13.50)	3.952 (0.880-5.320)	17.35	99
15+15+22+35+35+35	1.17	1.17	1.71	2.72	2.72	2.72	12.20 (3.50-13.50)	3.962 (0.880-5.320)	17.40	99
15+15+22+35+35+42	1.12	1.12	1.64	2.60	2.60	3.12	12.20 (3.50-13.50)	3.959 (0.880-5.320)	17.38	99
15+15+22+35+35+50	1.06	1.06	1.56	2.48	2.48	3.55	12.20 (3.50-13.50)	3.954 (0.880-5.320)	17.37	99
15+15+22+35+42+42	1.07	1.07	1.57	2.50	3.00	3.00	12.20 (3.50-13.50)	3.955 (0.880-5.320)	17.37	99
15+15+22+35+42+50	1.02	1.02	1.50	2.39	2.86	3.41	12.20 (3.50-13.50)	3.951 (0.880-5.320)	17.35	99
15+15+22+42+42+42	1.03	1.03	1.51	2.88	2.88	2.88	12.20 (3.50-13.50)	3.951 (0.880-5.320)	17.35	99
15+15+25+25+25+25	1.37	1.37	2.29	2.29	2.29	2.29	11.90 (3.50-13.50)	3.988 (0.880-5.370)	17.52	99
15+15+25+25+25+35	1.31	1.31	2.18	2.18	2.18	3.05	12.20 (3.50-13.50)	3.984 (0.880-5.350)	17.50	99
15+15+25+25+25+42	1.24	1.24	2.07	2.07	2.07	3.49	12.20 (3.50-13.50)	3.971 (0.880-5.330)	17.44	99
15+15+25+25+25+50	1.18	1.18	1.97	1.97	1.97	3.94	12.20 (3.50-13.50)	3.963 (0.880-5.320)	17.41	99
15+15+25+25+25+60	1.11	1.11	1.85	1.85	1.85	4.44	12.20 (3.50-13.50)	3.958 (0.880-5.320)	17.38	99
15+15+25+25+25+71	1.04	1.04	1.73	1.73	1.73	4.92	12.20 (3.50-13.50)	3.952 (0.880-5.320)	17.36	99
15+15+25+25+35+35	1.22	1.22	2.03	2.03	2.85	2.85	12.20 (3.50-13.50)	3.966 (0.880-5.320)	17.42	99
15+15+25+25+35+42	1.17	1.17	1.94	1.94	2.72	3.26	12.20 (3.50-13.50)	3.962 (0.880-5.320)	17.40	99
15+15+25+25+35+50	1.11	1.11	1.85	1.85	2.59	3.70	12.20 (3.50-13.50)	3.958 (0.880-5.320)	17.38	99
15+15+25+25+35+60	1.05	1.05	1.74	1.74	2.44	4.18	12.20 (3.50-13.50)	3.953 (0.880-5.320)	17.36	99
15+15+25+25+42+42	1.12	1.12	1.86	1.86	3.12	3.12	12.20 (3.50-13.50)	3.959 (0.880-5.320)	17.38	99
15+15+25+25+42+50	1.06	1.06	1.77	1.77	2.98	3.55	12.20 (3.50-13.50)	3.954 (0.880-5.320)	17.37	99
15+15+25+25+50+50	1.02	1.02	1.69	1.69	3.39	3.39	12.20 (3.50-13.50)	3.950 (0.880-5.320)	17.35	99

MXZ-6C122VA COOLING

Indoor units combination	Cooling Capacity (kW)							Outdoor unit power consumption (kW)	Current (A)	Power factor (%)
	Unit A	Unit B	Unit C	Unit D	Unit E	Unit F	Total			
15+15+25+35+35+35	1.14	1.14	1.91	2.67	2.67	2.67	12.20 (3.50-13.50)	3.961 (0.880-5.320)	17.39	99
15+15+25+35+35+42	1.10	1.10	1.83	2.56	2.56	3.07	12.20 (3.50-13.50)	3.957 (0.880-5.320)	17.38	99
15+15+25+35+35+50	1.05	1.05	1.74	2.44	2.44	3.49	12.20 (3.50-13.50)	3.953 (0.880-5.320)	17.36	99
15+15+25+35+42+42	1.05	1.05	1.75	2.45	2.94	2.94	12.20 (3.50-13.50)	3.953 (0.880-5.320)	17.36	99
15+15+35+35+35+35	1.08	1.08	2.51	2.51	2.51	2.51	12.20 (3.50-13.50)	3.955 (0.880-5.320)	17.37	99
15+15+35+35+35+42	1.03	1.03	2.41	2.41	2.41	2.89	12.20 (3.50-13.50)	3.952 (0.880-5.320)	17.35	99
15+20+20+20+20+20	1.43	1.91	1.91	1.91	1.91	1.91	11.00 (3.30-12.60)	3.656 (0.910-5.650)	16.06	99
15+20+20+20+20+22	1.44	1.91	1.91	1.91	1.91	2.11	11.20 (3.30-12.60)	3.758 (0.910-5.650)	16.50	99
15+20+20+20+20+25	1.43	1.90	1.90	1.90	1.90	2.38	11.40 (3.30-12.80)	3.872 (0.910-5.590)	17.00	99
15+20+20+20+20+35	1.37	1.83	1.83	1.83	1.83	3.20	11.90 (3.50-13.50)	3.988 (0.880-5.370)	17.52	99
15+20+20+20+20+42	1.32	1.77	1.77	1.77	1.77	3.71	12.10 (3.50-13.50)	3.989 (0.880-5.350)	17.52	99
15+20+20+20+20+50	1.26	1.68	1.68	1.68	1.68	4.21	12.20 (3.50-13.50)	3.975 (0.880-5.330)	17.46	99
15+20+20+20+20+60	1.18	1.57	1.57	1.57	1.57	4.72	12.20 (3.50-13.50)	3.963 (0.880-5.320)	17.41	99
15+20+20+20+20+71	1.10	1.47	1.47	1.47	1.47	5.22	12.20 (3.50-13.50)	3.957 (0.880-5.320)	17.38	99
15+20+20+20+22+22	1.42	1.90	1.90	1.90	2.09	2.09	11.30 (3.30-12.60)	3.860 (0.910-5.650)	16.95	99
15+20+20+20+22+25	1.41	1.89	1.89	1.89	2.07	2.36	11.50 (3.40-12.90)	3.895 (0.900-5.560)	17.11	99
15+20+20+20+22+35	1.36	1.82	1.82	1.82	2.00	3.18	12.00 (3.50-13.50)	3.998 (0.880-5.370)	17.56	99
15+20+20+20+22+42	1.32	1.76	1.76	1.76	1.93	3.69	12.20 (3.50-13.50)	3.986 (0.880-5.350)	17.50	99
15+20+20+20+22+50	1.24	1.66	1.66	1.66	1.83	4.15	12.20 (3.50-13.50)	3.971 (0.880-5.330)	17.44	99
15+20+20+20+22+60	1.17	1.55	1.55	1.55	1.71	4.66	12.20 (3.50-13.50)	3.962 (0.880-5.320)	17.40	99
15+20+20+20+22+71	1.09	1.45	1.45	1.45	1.60	5.16	12.20 (3.50-13.50)	3.956 (0.880-5.320)	17.38	99
15+20+20+20+25+25	1.40	1.87	1.87	1.87	2.34	2.34	11.70 (3.40-13.10)	3.930 (0.900-5.490)	17.26	99
15+20+20+20+25+35	1.34	1.79	1.79	1.79	2.24	3.14	12.10 (3.50-13.50)	3.993 (0.880-5.360)	17.54	99
15+20+20+20+25+42	1.29	1.72	1.72	1.72	2.15	3.61	12.20 (3.50-13.50)	3.980 (0.880-5.340)	17.48	99
15+20+20+20+25+50	1.22	1.63	1.63	1.63	2.03	4.07	12.20 (3.50-13.50)	3.966 (0.880-5.320)	17.42	99
15+20+20+20+25+60	1.14	1.53	1.53	1.53	1.91	4.58	12.20 (3.50-13.50)	3.961 (0.880-5.320)	17.39	99
15+20+20+20+25+71	1.07	1.43	1.43	1.43	1.78	5.07	12.20 (3.50-13.50)	3.955 (0.880-5.320)	17.37	99
15+20+20+20+35+35	1.26	1.68	1.68	1.68	2.94	2.94	12.20 (3.50-13.50)	3.975 (0.880-5.330)	17.46	99
15+20+20+20+35+42	1.20	1.61	1.61	1.61	2.81	3.37	12.20 (3.50-13.50)	3.965 (0.880-5.320)	17.41	99
15+20+20+20+35+50	1.14	1.53	1.53	1.53	2.67	3.81	12.20 (3.50-13.50)	3.961 (0.880-5.320)	17.39	99
15+20+20+20+35+60	1.08	1.44	1.44	1.44	2.51	4.31	12.20 (3.50-13.50)	3.955 (0.880-5.320)	17.37	99
15+20+20+20+42+42	1.15	1.53	1.53	1.53	3.22	3.22	12.20 (3.50-13.50)	3.961 (0.880-5.320)	17.40	99
15+20+20+20+42+50	1.10	1.46	1.46	1.46	3.07	3.65	12.20 (3.50-13.50)	3.957 (0.880-5.320)	17.38	99
15+20+20+20+42+60	1.03	1.38	1.38	1.38	2.89	4.14	12.20 (3.50-13.50)	3.952 (0.880-5.320)	17.35	99
15+20+20+20+50+50	1.05	1.39	1.39	1.39	3.49	3.49	12.20 (3.50-13.50)	3.953 (0.880-5.320)	17.36	99
15+20+20+22+22+22	1.43	1.90	1.90	2.09	2.09	2.09	11.50 (3.30-12.80)	3.883 (0.910-5.590)	17.05	99
15+20+20+22+22+25	1.40	1.87	1.87	2.06	2.06	2.34	11.60 (3.40-13.10)	3.918 (0.900-5.490)	17.21	99
15+20+20+22+22+35	1.35	1.81	1.81	1.99	1.99	3.16	12.10 (3.50-13.50)	3.995 (0.880-5.360)	17.54	99
15+20+20+22+22+42	1.30	1.73	1.73	1.90	1.90	3.63	12.20 (3.50-13.50)	3.982 (0.880-5.340)	17.49	99
15+20+20+22+22+50	1.23	1.64	1.64	1.80	1.80	4.09	12.20 (3.50-13.50)	3.968 (0.880-5.320)	17.43	99
15+20+20+22+22+60	1.15	1.53	1.53	1.69	1.69	4.60	12.20 (3.50-13.50)	3.961 (0.880-5.320)	17.40	99
15+20+20+22+22+71	1.08	1.44	1.44	1.58	1.58	5.10	12.20 (3.50-13.50)	3.955 (0.880-5.320)	17.37	99
15+20+20+22+25+25	1.39	1.86	1.86	2.04	2.32	2.32	11.80 (3.40-13.20)	3.953 (0.890-5.460)	17.36	99
15+20+20+22+25+35	1.32	1.77	1.77	1.94	2.21	3.09	12.10 (3.50-13.50)	3.989 (0.880-5.350)	17.52	99
15+20+20+22+25+42	1.27	1.69	1.69	1.86	2.12	3.56	12.20 (3.50-13.50)	3.977 (0.880-5.330)	17.46	99
15+20+20+22+25+50	1.20	1.61	1.61	1.77	2.01	4.01	12.20 (3.50-13.50)	3.965 (0.880-5.320)	17.41	99

MXZ-6C122VA COOLING

Indoor units combination	Cooling Capacity (kW)							Outdoor unit power consumption (kW)	Current (A)	Power factor (%)
	Unit A	Unit B	Unit C	Unit D	Unit E	Unit F	Total			
15+15+25+35+35+35	1.14	1.14	1.91	2.67	2.67	2.67	12.20 (3.50-13.50)	3.961 (0.880-5.320)	17.39	99
15+15+25+35+35+42	1.10	1.10	1.83	2.56	2.56	3.07	12.20 (3.50-13.50)	3.957 (0.880-5.320)	17.38	99
15+15+25+35+35+50	1.05	1.05	1.74	2.44	2.44	3.49	12.20 (3.50-13.50)	3.953 (0.880-5.320)	17.36	99
15+15+25+35+42+42	1.05	1.05	1.75	2.45	2.94	2.94	12.20 (3.50-13.50)	3.953 (0.880-5.320)	17.36	99
15+15+35+35+35+35	1.08	1.08	2.51	2.51	2.51	2.51	12.20 (3.50-13.50)	3.955 (0.880-5.320)	17.37	99
15+15+35+35+35+42	1.03	1.03	2.41	2.41	2.41	2.89	12.20 (3.50-13.50)	3.952 (0.880-5.320)	17.35	99
15+20+20+20+20+20	1.43	1.91	1.91	1.91	1.91	1.91	11.00 (3.30-12.60)	3.656 (0.910-5.650)	16.06	99
15+20+20+20+20+22	1.44	1.91	1.91	1.91	1.91	2.11	11.20 (3.30-12.60)	3.758 (0.910-5.650)	16.50	99
15+20+20+20+20+25	1.43	1.90	1.90	1.90	1.90	2.38	11.40 (3.30-12.80)	3.872 (0.910-5.590)	17.00	99
15+20+20+20+20+35	1.37	1.83	1.83	1.83	1.83	3.20	11.90 (3.50-13.50)	3.988 (0.880-5.370)	17.52	99
15+20+20+20+20+42	1.32	1.77	1.77	1.77	1.77	3.71	12.10 (3.50-13.50)	3.989 (0.880-5.350)	17.52	99
15+20+20+20+20+50	1.26	1.68	1.68	1.68	1.68	4.21	12.20 (3.50-13.50)	3.975 (0.880-5.330)	17.46	99
15+20+20+20+20+60	1.18	1.57	1.57	1.57	1.57	4.72	12.20 (3.50-13.50)	3.963 (0.880-5.320)	17.41	99
15+20+20+20+20+71	1.10	1.47	1.47	1.47	1.47	5.22	12.20 (3.50-13.50)	3.957 (0.880-5.320)	17.38	99
15+20+20+20+22+22	1.42	1.90	1.90	1.90	2.09	2.09	11.30 (3.30-12.60)	3.860 (0.910-5.650)	16.95	99
15+20+20+20+22+25	1.41	1.89	1.89	1.89	2.07	2.36	11.50 (3.40-12.90)	3.895 (0.900-5.560)	17.11	99
15+20+20+20+22+35	1.36	1.82	1.82	1.82	2.00	3.18	12.00 (3.50-13.50)	3.998 (0.880-5.370)	17.56	99
15+20+20+20+22+42	1.32	1.76	1.76	1.76	1.93	3.69	12.20 (3.50-13.50)	3.986 (0.880-5.350)	17.50	99
15+20+20+20+22+50	1.24	1.66	1.66	1.66	1.83	4.15	12.20 (3.50-13.50)	3.971 (0.880-5.330)	17.44	99
15+20+20+20+22+60	1.17	1.55	1.55	1.55	1.71	4.66	12.20 (3.50-13.50)	3.962 (0.880-5.320)	17.40	99
15+20+20+20+22+71	1.09	1.45	1.45	1.45	1.60	5.16	12.20 (3.50-13.50)	3.956 (0.880-5.320)	17.38	99
15+20+20+20+25+25	1.40	1.87	1.87	1.87	2.34	2.34	11.70 (3.40-13.10)	3.930 (0.900-5.490)	17.26	99
15+20+20+20+25+35	1.34	1.79	1.79	1.79	2.24	3.14	12.10 (3.50-13.50)	3.993 (0.880-5.360)	17.54	99
15+20+20+20+25+42	1.29	1.72	1.72	1.72	2.15	3.61	12.20 (3.50-13.50)	3.980 (0.880-5.340)	17.48	99
15+20+20+20+25+50	1.22	1.63	1.63	1.63	2.03	4.07	12.20 (3.50-13.50)	3.966 (0.880-5.320)	17.42	99
15+20+20+20+25+60	1.14	1.53	1.53	1.53	1.91	4.58	12.20 (3.50-13.50)	3.961 (0.880-5.320)	17.39	99
15+20+20+20+25+71	1.07	1.43	1.43	1.43	1.78	5.07	12.20 (3.50-13.50)	3.955 (0.880-5.320)	17.37	99
15+20+20+20+35+35	1.26	1.68	1.68	1.68	2.94	2.94	12.20 (3.50-13.50)	3.975 (0.880-5.330)	17.46	99
15+20+20+20+35+42	1.20	1.61	1.61	1.61	2.81	3.37	12.20 (3.50-13.50)	3.965 (0.880-5.320)	17.41	99
15+20+20+20+35+50	1.14	1.53	1.53	1.53	2.67	3.81	12.20 (3.50-13.50)	3.961 (0.880-5.320)	17.39	99
15+20+20+20+35+60	1.08	1.44	1.44	1.44	2.51	4.31	12.20 (3.50-13.50)	3.955 (0.880-5.320)	17.37	99
15+20+20+20+42+42	1.15	1.53	1.53	1.53	3.22	3.22	12.20 (3.50-13.50)	3.961 (0.880-5.320)	17.40	99
15+20+20+20+42+50	1.10	1.46	1.46	1.46	3.07	3.65	12.20 (3.50-13.50)	3.957 (0.880-5.320)	17.38	99
15+20+20+20+42+60	1.03	1.38	1.38	1.38	2.89	4.14	12.20 (3.50-13.50)	3.952 (0.880-5.320)	17.35	99
15+20+20+20+50+50	1.05	1.39	1.39	1.39	3.49	3.49	12.20 (3.50-13.50)	3.953 (0.880-5.320)	17.36	99
15+20+20+22+22+22	1.43	1.90	1.90	2.09	2.09	2.09	11.50 (3.30-12.80)	3.883 (0.910-5.590)	17.05	99
15+20+20+22+22+25	1.40	1.87	1.87	2.06	2.06	2.34	11.60 (3.40-13.10)	3.918 (0.900-5.490)	17.21	99
15+20+20+22+22+35	1.35	1.81	1.81	1.99	1.99	3.16	12.10 (3.50-13.50)	3.995 (0.880-5.360)	17.54	99
15+20+20+22+22+42	1.30	1.73	1.73	1.90	1.90	3.63	12.20 (3.50-13.50)	3.982 (0.880-5.340)	17.49	99
15+20+20+22+22+50	1.23	1.64	1.64	1.80	1.80	4.09	12.20 (3.50-13.50)	3.968 (0.880-5.320)	17.43	99
15+20+20+22+22+60	1.15	1.53	1.53	1.69	1.69	4.60	12.20 (3.50-13.50)	3.961 (0.880-5.320)	17.40	99
15+20+20+22+22+71	1.08	1.44	1.44	1.58	1.58	5.10	12.20 (3.50-13.50)	3.955 (0.880-5.320)	17.37	99
15+20+20+22+25+25	1.39	1.86	1.86	2.04	2.32	2.32	11.80 (3.40-13.20)	3.953 (0.890-5.460)	17.36	99
15+20+20+22+25+35	1.32	1.77	1.77	1.94	2.21	3.09	12.10 (3.50-13.50)	3.989 (0.880-5.350)	17.52	99
15+20+20+22+25+42	1.27	1.69	1.69	1.86	2.12	3.56	12.20 (3.50-13.50)	3.977 (0.880-5.330)	17.46	99
15+20+20+22+25+50	1.20	1.61	1.61	1.77	2.01	4.01	12.20 (3.50-13.50)	3.965 (0.880-5.320)	17.41	99

MXZ-6C122VA COOLING

Indoor units combination	Cooling Capacity (kW)							Outdoor unit power consumption (kW)	Current (A)	Power factor (%)
	Unit A	Unit B	Unit C	Unit D	Unit E	Unit F	Total			
15+20+22+22+50+50	1.02	1.36	1.50	1.50	3.41	3.41	12.20 (3.50-13.50)	3.951 (0.880-5.320)	17.35	99
15+20+22+25+25+25	1.36	1.82	2.00	2.27	2.27	2.27	12.00 (3.50-13.50)	3.998 (0.880-5.370)	17.56	99
15+20+22+25+25+35	1.29	1.72	1.89	2.15	2.15	3.01	12.20 (3.50-13.50)	3.980 (0.880-5.340)	17.48	99
15+20+22+25+25+42	1.23	1.64	1.80	2.05	2.05	3.44	12.20 (3.50-13.50)	3.968 (0.880-5.320)	17.43	99
15+20+22+25+25+50	1.17	1.55	1.71	1.94	1.94	3.89	12.20 (3.50-13.50)	3.962 (0.880-5.320)	17.40	99
15+20+22+25+25+60	1.10	1.46	1.61	1.83	1.83	4.38	12.20 (3.50-13.50)	3.957 (0.880-5.320)	17.38	99
15+20+22+25+25+71	1.03	1.37	1.51	1.71	1.71	4.87	12.20 (3.50-13.50)	3.951 (0.880-5.320)	17.35	99
15+20+22+25+35+35	1.20	1.61	1.77	2.01	2.81	2.81	12.20 (3.50-13.50)	3.965 (0.880-5.320)	17.41	99
15+20+22+25+35+42	1.15	1.53	1.69	1.92	2.69	3.22	12.20 (3.50-13.50)	3.961 (0.880-5.320)	17.40	99
15+20+22+25+35+50	1.10	1.46	1.61	1.83	2.56	3.65	12.20 (3.50-13.50)	3.957 (0.880-5.320)	17.38	99
15+20+22+25+35+60	1.03	1.38	1.52	1.72	2.41	4.14	12.20 (3.50-13.50)	3.952 (0.880-5.320)	17.35	99
15+20+22+25+42+42	1.10	1.47	1.62	1.84	3.09	3.09	12.20 (3.50-13.50)	3.957 (0.880-5.320)	17.38	99
15+20+22+25+42+50	1.05	1.40	1.54	1.75	2.94	3.51	12.20 (3.50-13.50)	3.953 (0.880-5.320)	17.36	99
15+20+22+35+35+35	1.13	1.51	1.66	2.64	2.64	2.64	12.20 (3.50-13.50)	3.960 (0.880-5.320)	17.39	99
15+20+22+35+35+42	1.08	1.44	1.59	2.53	2.53	3.03	12.20 (3.50-13.50)	3.956 (0.880-5.320)	17.37	99
15+20+22+35+35+50	1.03	1.38	1.52	2.41	2.41	3.45	12.20 (3.50-13.50)	3.952 (0.880-5.320)	17.35	99
15+20+22+35+42+42	1.04	1.39	1.53	2.43	2.91	2.91	12.20 (3.50-13.50)	3.952 (0.880-5.320)	17.36	99
15+20+25+25+25+25	1.34	1.79	2.24	2.24	2.24	2.24	12.10 (3.50-13.50)	3.993 (0.880-5.360)	17.54	99
15+20+25+25+25+35	1.26	1.68	2.10	2.10	2.10	2.94	12.20 (3.50-13.50)	3.975 (0.880-5.330)	17.46	99
15+20+25+25+25+42	1.20	1.61	2.01	2.01	2.01	3.37	12.20 (3.50-13.50)	3.965 (0.880-5.320)	17.41	99
15+20+25+25+25+50	1.14	1.53	1.91	1.91	1.91	3.81	12.20 (3.50-13.50)	3.961 (0.880-5.320)	17.39	99
15+20+25+25+25+60	1.08	1.44	1.79	1.79	1.79	4.31	12.20 (3.50-13.50)	3.955 (0.880-5.320)	17.37	99
15+20+25+25+35+35	1.18	1.57	1.97	1.97	2.75	2.75	12.20 (3.50-13.50)	3.963 (0.880-5.320)	17.41	99
15+20+25+25+35+42	1.13	1.51	1.88	1.88	2.64	3.16	12.20 (3.50-13.50)	3.960 (0.880-5.320)	17.39	99
15+20+25+25+35+50	1.08	1.44	1.79	1.79	2.51	3.59	12.20 (3.50-13.50)	3.955 (0.880-5.320)	17.37	99
15+20+25+25+35+60	1.02	1.36	1.69	1.69	2.37	4.07	12.20 (3.50-13.50)	3.950 (0.880-5.320)	17.35	99
15+20+25+25+42+42	1.08	1.44	1.80	1.80	3.03	3.03	12.20 (3.50-13.50)	3.956 (0.880-5.320)	17.37	99
15+20+25+25+42+50	1.03	1.38	1.72	1.72	2.89	3.45	12.20 (3.50-13.50)	3.952 (0.880-5.320)	17.35	99
15+20+25+35+35+35	1.11	1.48	1.85	2.59	2.59	2.59	12.20 (3.50-13.50)	3.958 (0.880-5.320)	17.38	99
15+20+25+35+35+42	1.06	1.42	1.77	2.48	2.48	2.98	12.20 (3.50-13.50)	3.954 (0.880-5.320)	17.37	99
15+20+25+35+35+50	1.02	1.36	1.69	2.37	2.37	3.39	12.20 (3.50-13.50)	3.950 (0.880-5.320)	17.35	99
15+20+25+35+42+42	1.02	1.36	1.70	2.39	2.86	2.86	12.20 (3.50-13.50)	3.951 (0.880-5.320)	17.35	99
15+20+35+35+35+35	1.05	1.39	2.44	2.44	2.44	2.44	12.20 (3.50-13.50)	3.953 (0.880-5.320)	17.36	99
15+22+22+22+22+22	1.40	2.06	2.06	2.06	2.06	2.06	11.70 (3.40-13.10)	3.930 (0.900-5.490)	17.26	99
15+22+22+22+22+25	1.38	2.03	2.03	2.03	2.03	2.30	11.80 (3.50-13.40)	3.965 (0.890-5.400)	17.41	99
15+22+22+22+22+35	1.33	1.94	1.94	1.94	1.94	3.09	12.20 (3.50-13.50)	3.987 (0.880-5.350)	17.51	99
15+22+22+22+22+42	1.26	1.85	1.85	1.85	1.85	3.53	12.20 (3.50-13.50)	3.975 (0.880-5.330)	17.46	99
15+22+22+22+22+50	1.20	1.75	1.75	1.75	1.75	3.99	12.20 (3.50-13.50)	3.964 (0.880-5.320)	17.41	99
15+22+22+22+22+60	1.12	1.65	1.65	1.65	1.65	4.49	12.20 (3.50-13.50)	3.959 (0.880-5.320)	17.39	99
15+22+22+22+22+71	1.05	1.54	1.54	1.54	1.54	4.98	12.20 (3.50-13.50)	3.953 (0.880-5.320)	17.36	99
15+22+22+22+25+25	1.37	2.02	2.02	2.02	2.29	2.29	12.00 (3.50-13.50)	4.000 (0.880-5.370)	17.57	99
15+22+22+22+25+35	1.30	1.90	1.90	1.90	2.16	3.03	12.20 (3.50-13.50)	3.982 (0.880-5.340)	17.49	99
15+22+22+22+25+42	1.24	1.81	1.81	1.81	2.06	3.46	12.20 (3.50-13.50)	3.970 (0.880-5.320)	17.43	99
15+22+22+22+25+50	1.17	1.72	1.72	1.72	1.96	3.91	12.20 (3.50-13.50)	3.963 (0.880-5.320)	17.40	99
15+22+22+22+25+60	1.10	1.62	1.62	1.62	1.84	4.41	12.20 (3.50-13.50)	3.957 (0.880-5.320)	17.38	99
15+22+22+22+25+71	1.03	1.52	1.52	1.52	1.72	4.89	12.20 (3.50-13.50)	3.952 (0.880-5.320)	17.35	99

MXZ-6C122VA COOLING

Indoor units combination	Cooling Capacity (kW)							Outdoor unit power consumption (kW)	Current (A)	Power factor (%)
	Unit A	Unit B	Unit C	Unit D	Unit E	Unit F	Total			
15+22+22+22+35+35	1.21	1.78	1.78	1.78	2.83	2.83	12.20 (3.50-13.50)	3.965 (0.880-5.320)	17.42	99
15+22+22+22+35+42	1.16	1.70	1.70	1.70	2.70	3.24	12.20 (3.50-13.50)	3.962 (0.880-5.320)	17.40	99
15+22+22+22+35+50	1.10	1.62	1.62	1.62	2.57	3.67	12.20 (3.50-13.50)	3.957 (0.880-5.320)	17.38	99
15+22+22+22+35+60	1.04	1.53	1.53	1.53	2.43	4.16	12.20 (3.50-13.50)	3.952 (0.880-5.320)	17.36	99
15+22+22+22+42+42	1.11	1.63	1.63	1.63	3.11	3.11	12.20 (3.50-13.50)	3.958 (0.880-5.320)	17.38	99
15+22+22+22+42+50	1.06	1.55	1.55	1.55	2.96	3.53	12.20 (3.50-13.50)	3.954 (0.880-5.320)	17.36	99
15+22+22+25+25+25	1.35	1.99	1.99	2.26	2.26	2.26	12.10 (3.50-13.50)	3.995 (0.880-5.360)	17.54	99
15+22+22+25+25+35	1.27	1.86	1.86	2.12	2.12	2.97	12.20 (3.50-13.50)	3.977 (0.880-5.330)	17.46	99
15+22+22+25+25+42	1.21	1.78	1.78	2.02	2.02	3.39	12.20 (3.50-13.50)	3.965 (0.880-5.320)	17.42	99
15+22+22+25+25+50	1.15	1.69	1.69	1.92	1.92	3.84	12.20 (3.50-13.50)	3.961 (0.880-5.320)	17.40	99
15+22+22+25+25+60	1.08	1.59	1.59	1.80	1.80	4.33	12.20 (3.50-13.50)	3.956 (0.880-5.320)	17.37	99
15+22+22+25+25+71	1.02	1.49	1.49	1.69	1.69	4.81	12.20 (3.50-13.50)	3.950 (0.880-5.320)	17.35	99
15+22+22+25+35+35	1.19	1.74	1.74	1.98	2.77	2.77	12.20 (3.50-13.50)	3.964 (0.880-5.320)	17.41	99
15+22+22+25+35+42	1.14	1.67	1.67	1.89	2.65	3.18	12.20 (3.50-13.50)	3.960 (0.880-5.320)	17.39	99
15+22+22+25+35+50	1.08	1.59	1.59	1.80	2.53	3.61	12.20 (3.50-13.50)	3.956 (0.880-5.320)	17.37	99
15+22+22+25+35+60	1.02	1.50	1.50	1.70	2.39	4.09	12.20 (3.50-13.50)	3.951 (0.880-5.320)	17.35	99
15+22+22+25+42+42	1.09	1.60	1.60	1.82	3.05	3.05	12.20 (3.50-13.50)	3.956 (0.880-5.320)	17.38	99
15+22+22+25+42+50	1.04	1.53	1.53	1.73	2.91	3.47	12.20 (3.50-13.50)	3.952 (0.880-5.320)	17.36	99
15+22+22+35+35+35	1.12	1.64	1.64	2.60	2.60	2.60	12.20 (3.50-13.50)	3.959 (0.880-5.320)	17.38	99
15+22+22+35+35+42	1.07	1.57	1.57	2.50	2.50	3.00	12.20 (3.50-13.50)	3.955 (0.880-5.320)	17.37	99
15+22+22+35+35+50	1.02	1.50	1.50	2.39	2.39	3.41	12.20 (3.50-13.50)	3.951 (0.880-5.320)	17.35	99
15+22+22+35+42+42	1.03	1.51	1.51	2.40	2.88	2.88	12.20 (3.50-13.50)	3.951 (0.880-5.320)	17.35	99
15+22+25+25+25+25	1.32	1.94	2.21	2.21	2.21	2.21	12.10 (3.50-13.50)	3.989 (0.880-5.350)	17.52	99
15+22+25+25+25+35	1.24	1.83	2.07	2.07	2.07	2.90	12.20 (3.50-13.50)	3.971 (0.880-5.330)	17.44	99
15+22+25+25+25+42	1.19	1.74	1.98	1.98	1.98	3.33	12.20 (3.50-13.50)	3.964 (0.880-5.320)	17.41	99
15+22+25+25+25+50	1.13	1.66	1.88	1.88	1.88	3.77	12.20 (3.50-13.50)	3.960 (0.880-5.320)	17.39	99
15+22+25+25+25+60	1.06	1.56	1.77	1.77	1.77	4.26	12.20 (3.50-13.50)	3.954 (0.880-5.320)	17.37	99
15+22+25+25+35+35	1.17	1.71	1.94	1.94	2.72	2.72	12.20 (3.50-13.50)	3.962 (0.880-5.320)	17.40	99
15+22+25+25+35+42	1.12	1.64	1.86	1.86	2.60	3.12	12.20 (3.50-13.50)	3.959 (0.880-5.320)	17.38	99
15+22+25+25+35+50	1.06	1.56	1.77	1.77	2.48	3.55	12.20 (3.50-13.50)	3.954 (0.880-5.320)	17.37	99
15+22+25+25+42+42	1.07	1.57	1.78	1.78	3.00	3.00	12.20 (3.50-13.50)	3.955 (0.880-5.320)	17.37	99
15+22+25+25+42+50	1.02	1.50	1.70	1.70	2.86	3.41	12.20 (3.50-13.50)	3.951 (0.880-5.320)	17.35	99
15+22+25+35+35+35	1.10	1.61	1.83	2.56	2.56	2.56	12.20 (3.50-13.50)	3.957 (0.880-5.320)	17.38	99
15+22+25+35+35+42	1.05	1.54	1.75	2.45	2.45	2.94	12.20 (3.50-13.50)	3.953 (0.880-5.320)	17.36	99
15+22+35+35+35+35	1.03	1.52	2.41	2.41	2.41	2.41	12.20 (3.50-13.50)	3.952 (0.880-5.320)	17.35	99
15+25+25+25+25+25	1.31	2.18	2.18	2.18	2.18	2.18	12.20 (3.50-13.50)	3.984 (0.880-5.350)	17.50	99
15+25+25+25+25+35	1.22	2.03	2.03	2.03	2.03	2.85	12.20 (3.50-13.50)	3.966 (0.880-5.320)	17.42	99
15+25+25+25+25+42	1.17	1.94	1.94	1.94	1.94	3.26	12.20 (3.50-13.50)	3.962 (0.880-5.320)	17.40	99
15+25+25+25+25+50	1.11	1.85	1.85	1.85	1.85	3.70	12.20 (3.50-13.50)	3.958 (0.880-5.320)	17.38	99
15+25+25+25+25+60	1.05	1.74	1.74	1.74	1.74	4.18	12.20 (3.50-13.50)	3.953 (0.880-5.320)	17.36	99
15+25+25+25+35+35	1.14	1.91	1.91	1.91	2.67	2.67	12.20 (3.50-13.50)	3.961 (0.880-5.320)	17.39	99
15+25+25+25+35+42	1.10	1.83	1.83	1.83	2.56	3.07	12.20 (3.50-13.50)	3.957 (0.880-5.320)	17.38	99
15+25+25+25+35+50	1.05	1.74	1.74	1.74	2.44	3.49	12.20 (3.50-13.50)	3.953 (0.880-5.320)	17.36	99
15+25+25+25+42+42	1.05	1.75	1.75	1.75	2.94	2.94	12.20 (3.50-13.50)	3.953 (0.880-5.320)	17.36	99
15+25+25+35+35+35	1.08	1.79	1.79	2.51	2.51	2.51	12.20 (3.50-13.50)	3.955 (0.880-5.320)	17.37	99
15+25+25+35+35+42	1.03	1.72	1.72	2.41	2.41	2.89	12.20 (3.50-13.50)	3.952 (0.880-5.320)	17.35	99

MXZ-6C122VA COOLING

Indoor units combination	Cooling Capacity (kW)							Outdoor unit power consumption (kW)	Current (A)	Power factor (%)
	Unit A	Unit B	Unit C	Unit D	Unit E	Unit F	Total			
15+25+35+35+35+35	1.02	1.69	2.37	2.37	2.37	2.37	12.20 (3.50-13.50)	3.950 (0.880-5.320)	17.35	99
20+20+20+20+20+20	1.90	1.90	1.90	1.90	1.90	1.90	11.40 (3.30-12.80)	3.872 (0.910-5.590)	17.00	99
20+20+20+20+20+22	1.89	1.89	1.89	1.89	1.89	2.07	11.50 (3.40-12.90)	3.895 (0.900-5.560)	17.11	99
20+20+20+20+20+25	1.87	1.87	1.87	1.87	1.87	2.34	11.70 (3.40-13.10)	3.930 (0.900-5.490)	17.26	99
20+20+20+20+20+35	1.79	1.79	1.79	1.79	1.79	3.14	12.10 (3.50-13.50)	3.993 (0.880-5.360)	17.54	99
20+20+20+20+20+42	1.72	1.72	1.72	1.72	1.72	3.61	12.20 (3.50-13.50)	3.980 (0.880-5.340)	17.48	99
20+20+20+20+20+50	1.63	1.63	1.63	1.63	1.63	4.07	12.20 (3.50-13.50)	3.966 (0.880-5.320)	17.42	99
20+20+20+20+20+60	1.53	1.53	1.53	1.53	1.53	4.58	12.20 (3.50-13.50)	3.961 (0.880-5.320)	17.39	99
20+20+20+20+20+71	1.43	1.43	1.43	1.43	1.43	5.07	12.20 (3.50-13.50)	3.955 (0.880-5.320)	17.37	99
20+20+20+20+22+22	1.87	1.87	1.87	1.87	2.06	2.06	11.60 (3.40-13.10)	3.918 (0.900-5.490)	17.21	99
20+20+20+20+22+25	1.86	1.86	1.86	1.86	2.04	2.32	11.80 (3.40-13.20)	3.953 (0.890-5.460)	17.36	99
20+20+20+20+22+35	1.77	1.77	1.77	1.77	1.94	3.09	12.10 (3.50-13.50)	3.989 (0.880-5.350)	17.52	99
20+20+20+20+22+42	1.69	1.69	1.69	1.69	1.86	3.56	12.20 (3.50-13.50)	3.977 (0.880-5.330)	17.46	99
20+20+20+20+22+50	1.61	1.61	1.61	1.61	1.77	4.01	12.20 (3.50-13.50)	3.965 (0.880-5.320)	17.41	99
20+20+20+20+22+60	1.51	1.51	1.51	1.51	1.66	4.52	12.20 (3.50-13.50)	3.960 (0.880-5.320)	17.39	99
20+20+20+20+22+71	1.41	1.41	1.41	1.41	1.55	5.01	12.20 (3.50-13.50)	3.954 (0.880-5.320)	17.36	99
20+20+20+20+25+25	1.83	1.83	1.83	1.83	2.29	2.29	11.90 (3.50-13.50)	3.988 (0.880-5.370)	17.52	99
20+20+20+20+25+35	1.74	1.74	1.74	1.74	2.18	3.05	12.20 (3.50-13.50)	3.984 (0.880-5.350)	17.50	99
20+20+20+20+25+42	1.66	1.66	1.66	1.66	2.07	3.49	12.20 (3.50-13.50)	3.971 (0.880-5.330)	17.44	99
20+20+20+20+25+50	1.57	1.57	1.57	1.57	1.97	3.94	12.20 (3.50-13.50)	3.963 (0.880-5.320)	17.41	99
20+20+20+20+25+60	1.48	1.48	1.48	1.48	1.85	4.44	12.20 (3.50-13.50)	3.958 (0.880-5.320)	17.38	99
20+20+20+20+25+71	1.39	1.39	1.39	1.39	1.73	4.92	12.20 (3.50-13.50)	3.952 (0.880-5.320)	17.36	99
20+20+20+20+35+35	1.63	1.63	1.63	1.63	2.85	2.85	12.20 (3.50-13.50)	3.966 (0.880-5.320)	17.42	99
20+20+20+20+35+42	1.55	1.55	1.55	1.55	2.72	3.26	12.20 (3.50-13.50)	3.962 (0.880-5.320)	17.40	99
20+20+20+20+35+50	1.48	1.48	1.48	1.48	2.59	3.70	12.20 (3.50-13.50)	3.958 (0.880-5.320)	17.38	99
20+20+20+20+35+60	1.39	1.39	1.39	1.39	2.44	4.18	12.20 (3.50-13.50)	3.953 (0.880-5.320)	17.36	99
20+20+20+20+42+42	1.49	1.49	1.49	1.49	3.12	3.12	12.20 (3.50-13.50)	3.959 (0.880-5.320)	17.38	99
20+20+20+20+42+50	1.42	1.42	1.42	1.42	2.98	3.55	12.20 (3.50-13.50)	3.954 (0.880-5.320)	17.37	99
20+20+20+20+50+50	1.36	1.36	1.36	1.36	3.39	3.39	12.20 (3.50-13.50)	3.950 (0.880-5.320)	17.35	99
20+20+20+22+22+22	1.86	1.86	1.86	2.04	2.04	2.04	11.70 (3.40-13.20)	3.942 (0.890-5.460)	17.31	99
20+20+20+22+22+25	1.84	1.84	1.84	2.03	2.03	2.31	11.90 (3.50-13.40)	3.977 (0.890-5.400)	17.46	99
20+20+20+22+22+35	1.76	1.76	1.76	1.93	1.93	3.07	12.20 (3.50-13.50)	3.986 (0.880-5.350)	17.50	99
20+20+20+22+22+42	1.67	1.67	1.67	1.84	1.84	3.51	12.20 (3.50-13.50)	3.973 (0.880-5.330)	17.45	99
20+20+20+22+22+50	1.58	1.58	1.58	1.74	1.74	3.96	12.20 (3.50-13.50)	3.964 (0.880-5.320)	17.41	99
20+20+20+22+22+60	1.49	1.49	1.49	1.64	1.64	4.46	12.20 (3.50-13.50)	3.959 (0.880-5.320)	17.38	99
20+20+20+22+22+71	1.39	1.39	1.39	1.53	1.53	4.95	12.20 (3.50-13.50)	3.953 (0.880-5.320)	17.36	99
20+20+20+22+25+25	1.82	1.82	1.82	2.00	2.27	2.27	12.00 (3.50-13.50)	3.998 (0.880-5.370)	17.56	99
20+20+20+22+25+35	1.72	1.72	1.72	1.89	2.15	3.01	12.20 (3.50-13.50)	3.980 (0.880-5.340)	17.48	99
20+20+20+22+25+42	1.64	1.64	1.64	1.80	2.05	3.44	12.20 (3.50-13.50)	3.968 (0.880-5.320)	17.43	99
20+20+20+22+25+50	1.55	1.55	1.55	1.71	1.94	3.89	12.20 (3.50-13.50)	3.962 (0.880-5.320)	17.40	99
20+20+20+22+25+60	1.46	1.46	1.46	1.61	1.83	4.38	12.20 (3.50-13.50)	3.957 (0.880-5.320)	17.38	99
20+20+20+22+25+71	1.37	1.37	1.37	1.51	1.71	4.87	12.20 (3.50-13.50)	3.951 (0.880-5.320)	17.35	99
20+20+20+22+35+35	1.61	1.61	1.61	1.77	2.81	2.81	12.20 (3.50-13.50)	3.965 (0.880-5.320)	17.41	99
20+20+20+22+35+42	1.53	1.53	1.53	1.69	2.69	3.22	12.20 (3.50-13.50)	3.961 (0.880-5.320)	17.40	99
20+20+20+22+35+50	1.46	1.46	1.46	1.61	2.56	3.65	12.20 (3.50-13.50)	3.957 (0.880-5.320)	17.38	99
20+20+20+22+35+60	1.38	1.38	1.38	1.52	2.41	4.14	12.20 (3.50-13.50)	3.952 (0.880-5.320)	17.35	99

MXZ-6C122VA COOLING

Indoor units combination	Cooling Capacity (kW)							Outdoor unit power consumption (kW)	Current (A)	Power factor (%)
	Unit A	Unit B	Unit C	Unit D	Unit E	Unit F	Total			
20+20+20+22+42+42	1.47	1.47	1.47	1.62	3.09	3.09	12.20 (3.50-13.50)	3.957 (0.880-5.320)	17.38	99
20+20+20+22+42+50	1.40	1.40	1.40	1.54	2.94	3.51	12.20 (3.50-13.50)	3.953 (0.880-5.320)	17.36	99
20+20+20+25+25+25	1.79	1.79	1.79	2.24	2.24	2.24	12.10 (3.50-13.50)	3.993 (0.880-5.360)	17.54	99
20+20+20+25+25+35	1.68	1.68	1.68	2.10	2.10	2.94	12.20 (3.50-13.50)	3.975 (0.880-5.330)	17.46	99
20+20+20+25+25+42	1.61	1.61	1.61	2.01	2.01	3.37	12.20 (3.50-13.50)	3.965 (0.880-5.320)	17.41	99
20+20+20+25+25+50	1.53	1.53	1.53	1.91	1.91	3.81	12.20 (3.50-13.50)	3.961 (0.880-5.320)	17.39	99
20+20+20+25+25+60	1.44	1.44	1.44	1.79	1.79	4.31	12.20 (3.50-13.50)	3.955 (0.880-5.320)	17.37	99
20+20+20+25+35+35	1.57	1.57	1.57	1.97	2.75	2.75	12.20 (3.50-13.50)	3.963 (0.880-5.320)	17.41	99
20+20+20+25+35+42	1.51	1.51	1.51	1.88	2.64	3.16	12.20 (3.50-13.50)	3.960 (0.880-5.320)	17.39	99
20+20+20+25+35+50	1.44	1.44	1.44	1.79	2.51	3.59	12.20 (3.50-13.50)	3.955 (0.880-5.320)	17.37	99
20+20+20+25+35+60	1.36	1.36	1.36	1.69	2.37	4.07	12.20 (3.50-13.50)	3.950 (0.880-5.320)	17.35	99
20+20+20+25+42+42	1.44	1.44	1.44	1.80	3.03	3.03	12.20 (3.50-13.50)	3.956 (0.880-5.320)	17.37	99
20+20+20+25+42+50	1.38	1.38	1.38	1.72	2.89	3.45	12.20 (3.50-13.50)	3.952 (0.880-5.320)	17.35	99
20+20+20+35+35+35	1.48	1.48	1.48	2.59	2.59	2.59	12.20 (3.50-13.50)	3.958 (0.880-5.320)	17.38	99
20+20+20+35+35+42	1.42	1.42	1.42	2.48	2.48	2.98	12.20 (3.50-13.50)	3.954 (0.880-5.320)	17.37	99
20+20+20+35+35+50	1.36	1.36	1.36	2.37	2.37	3.39	12.20 (3.50-13.50)	3.950 (0.880-5.320)	17.35	99
20+20+20+35+42+42	1.36	1.36	1.36	2.39	2.86	2.86	12.20 (3.50-13.50)	3.951 (0.880-5.320)	17.35	99
20+20+22+22+22+22	1.84	1.84	2.03	2.03	2.03	2.03	11.80 (3.50-13.40)	3.965 (0.890-5.400)	17.41	99
20+20+22+22+22+25	1.83	1.83	2.02	2.02	2.02	2.29	12.00 (3.50-13.50)	4.000 (0.880-5.370)	17.57	99
20+20+22+22+22+35	1.73	1.73	1.90	1.90	1.90	3.03	12.20 (3.50-13.50)	3.982 (0.880-5.340)	17.49	99
20+20+22+22+22+42	1.65	1.65	1.81	1.81	1.81	3.46	12.20 (3.50-13.50)	3.970 (0.880-5.320)	17.43	99
20+20+22+22+22+50	1.56	1.56	1.72	1.72	1.72	3.91	12.20 (3.50-13.50)	3.963 (0.880-5.320)	17.40	99
20+20+22+22+22+60	1.47	1.47	1.62	1.62	1.62	4.41	12.20 (3.50-13.50)	3.957 (0.880-5.320)	17.38	99
20+20+22+22+22+71	1.38	1.38	1.52	1.52	1.52	4.89	12.20 (3.50-13.50)	3.952 (0.880-5.320)	17.35	99
20+20+22+22+25+25	1.81	1.81	1.99	1.99	2.26	2.26	12.10 (3.50-13.50)	3.995 (0.880-5.360)	17.54	99
20+20+22+22+25+35	1.69	1.69	1.86	1.86	2.12	2.97	12.20 (3.50-13.50)	3.977 (0.880-5.330)	17.46	99
20+20+22+22+25+42	1.62	1.62	1.78	1.78	2.02	3.39	12.20 (3.50-13.50)	3.965 (0.880-5.320)	17.42	99
20+20+22+22+25+50	1.53	1.53	1.69	1.69	1.92	3.84	12.20 (3.50-13.50)	3.961 (0.880-5.320)	17.40	99
20+20+22+22+25+60	1.44	1.44	1.59	1.59	1.80	4.33	12.20 (3.50-13.50)	3.956 (0.880-5.320)	17.37	99
20+20+22+22+25+71	1.36	1.36	1.49	1.49	1.69	4.81	12.20 (3.50-13.50)	3.950 (0.880-5.320)	17.35	99
20+20+22+22+35+35	1.58	1.58	1.74	1.74	2.77	2.77	12.20 (3.50-13.50)	3.964 (0.880-5.320)	17.41	99
20+20+22+22+35+42	1.52	1.52	1.67	1.67	2.65	3.18	12.20 (3.50-13.50)	3.960 (0.880-5.320)	17.39	99
20+20+22+22+35+50	1.44	1.44	1.59	1.59	2.53	3.61	12.20 (3.50-13.50)	3.956 (0.880-5.320)	17.37	99
20+20+22+22+35+60	1.36	1.36	1.50	1.50	2.39	4.09	12.20 (3.50-13.50)	3.951 (0.880-5.320)	17.35	99
20+20+22+22+42+42	1.45	1.45	1.60	1.60	3.05	3.05	12.20 (3.50-13.50)	3.956 (0.880-5.320)	17.38	99
20+20+22+22+42+50	1.39	1.39	1.53	1.53	2.91	3.47	12.20 (3.50-13.50)	3.952 (0.880-5.320)	17.36	99
20+20+22+25+25+25	1.77	1.77	1.94	2.21	2.21	2.21	12.10 (3.50-13.50)	3.989 (0.880-5.350)	17.52	99
20+20+22+25+25+35	1.66	1.66	1.83	2.07	2.07	2.90	12.20 (3.50-13.50)	3.971 (0.880-5.330)	17.44	99
20+20+22+25+25+42	1.58	1.58	1.74	1.98	1.98	3.33	12.20 (3.50-13.50)	3.964 (0.880-5.320)	17.41	99
20+20+22+25+25+50	1.51	1.51	1.66	1.88	1.88	3.77	12.20 (3.50-13.50)	3.960 (0.880-5.320)	17.39	99
20+20+22+25+25+60	1.42	1.42	1.56	1.77	1.77	4.26	12.20 (3.50-13.50)	3.954 (0.880-5.320)	17.37	99
20+20+22+25+35+35	1.55	1.55	1.71	1.94	2.72	2.72	12.20 (3.50-13.50)	3.962 (0.880-5.320)	17.40	99
20+20+22+25+35+42	1.49	1.49	1.64	1.86	2.60	3.12	12.20 (3.50-13.50)	3.959 (0.880-5.320)	17.38	99
20+20+22+25+35+50	1.42	1.42	1.56	1.77	2.48	3.55	12.20 (3.50-13.50)	3.954 (0.880-5.320)	17.37	99
20+20+22+25+42+42	1.43	1.43	1.57	1.78	3.00	3.00	12.20 (3.50-13.50)	3.955 (0.880-5.320)	17.37	99
20+20+22+25+42+50	1.36	1.36	1.50	1.70	2.86	3.41	12.20 (3.50-13.50)	3.951 (0.880-5.320)	17.35	99

MXZ-6C122VA COOLING

Indoor units combination	Cooling Capacity (kW)							Outdoor unit power consumption (kW)	Current (A)	Power factor (%)
	Unit A	Unit B	Unit C	Unit D	Unit E	Unit F	Total			
20+20+22+35+35+35	1.46	1.46	1.61	2.56	2.56	2.56	12.20 (3.50-13.50)	3.957 (0.880-5.320)	17.38	99
20+20+22+35+35+42	1.40	1.40	1.54	2.45	2.45	2.94	12.20 (3.50-13.50)	3.953 (0.880-5.320)	17.36	99
20+20+25+25+25+25	1.74	1.74	2.18	2.18	2.18	2.18	12.20 (3.50-13.50)	3.984 (0.880-5.350)	17.50	99
20+20+25+25+25+35	1.63	1.63	2.03	2.03	2.03	2.85	12.20 (3.50-13.50)	3.966 (0.880-5.320)	17.42	99
20+20+25+25+25+42	1.55	1.55	1.94	1.94	1.94	3.26	12.20 (3.50-13.50)	3.962 (0.880-5.320)	17.40	99
20+20+25+25+25+50	1.48	1.48	1.85	1.85	1.85	3.70	12.20 (3.50-13.50)	3.958 (0.880-5.320)	17.38	99
20+20+25+25+25+60	1.39	1.39	1.74	1.74	1.74	4.18	12.20 (3.50-13.50)	3.953 (0.880-5.320)	17.36	99
20+20+25+25+35+35	1.53	1.53	1.91	1.91	2.67	2.67	12.20 (3.50-13.50)	3.961 (0.880-5.320)	17.39	99
20+20+25+25+35+42	1.46	1.46	1.83	1.83	2.56	3.07	12.20 (3.50-13.50)	3.957 (0.880-5.320)	17.38	99
20+20+25+25+35+50	1.39	1.39	1.74	1.74	2.44	3.49	12.20 (3.50-13.50)	3.953 (0.880-5.320)	17.36	99
20+20+25+25+42+42	1.40	1.40	1.75	1.75	2.94	2.94	12.20 (3.50-13.50)	3.953 (0.880-5.320)	17.36	99
20+20+25+35+35+35	1.44	1.44	1.79	2.51	2.51	2.51	12.20 (3.50-13.50)	3.955 (0.880-5.320)	17.37	99
20+20+25+35+35+42	1.38	1.38	1.72	2.41	2.41	2.89	12.20 (3.50-13.50)	3.952 (0.880-5.320)	17.35	99
20+20+35+35+35+35	1.36	1.36	2.37	2.37	2.37	2.37	12.20 (3.50-13.50)	3.950 (0.880-5.320)	17.35	99
20+22+22+22+22+22	1.83	2.01	2.01	2.01	2.01	2.01	11.90 (3.50-13.50)	3.988 (0.880-5.370)	17.52	99
20+22+22+22+22+25	1.80	1.98	1.98	1.98	1.98	2.26	12.00 (3.50-13.50)	3.996 (0.880-5.360)	17.55	99
20+22+22+22+22+35	1.71	1.88	1.88	1.88	1.88	2.99	12.20 (3.50-13.50)	3.979 (0.880-5.340)	17.47	99
20+22+22+22+22+42	1.63	1.79	1.79	1.79	1.79	3.42	12.20 (3.50-13.50)	3.966 (0.880-5.320)	17.42	99
20+22+22+22+22+50	1.54	1.70	1.70	1.70	1.70	3.86	12.20 (3.50-13.50)	3.962 (0.880-5.320)	17.40	99
20+22+22+22+22+60	1.45	1.60	1.60	1.60	1.60	4.36	12.20 (3.50-13.50)	3.956 (0.880-5.320)	17.38	99
20+22+22+22+22+71	1.36	1.50	1.50	1.50	1.50	4.84	12.20 (3.50-13.50)	3.951 (0.880-5.320)	17.35	99
20+22+22+22+25+25	1.78	1.96	1.96	1.96	2.22	2.22	12.10 (3.50-13.50)	3.991 (0.880-5.360)	17.53	99
20+22+22+22+25+35	1.67	1.84	1.84	1.84	2.09	2.92	12.20 (3.50-13.50)	3.973 (0.880-5.330)	17.45	99
20+22+22+22+25+42	1.59	1.75	1.75	1.75	1.99	3.35	12.20 (3.50-13.50)	3.964 (0.880-5.320)	17.41	99
20+22+22+22+25+50	1.52	1.67	1.67	1.67	1.89	3.79	12.20 (3.50-13.50)	3.960 (0.880-5.320)	17.39	99
20+22+22+22+25+60	1.43	1.57	1.57	1.57	1.78	4.28	12.20 (3.50-13.50)	3.955 (0.880-5.320)	17.37	99
20+22+22+22+35+35	1.56	1.72	1.72	1.72	2.74	2.74	12.20 (3.50-13.50)	3.963 (0.880-5.320)	17.40	99
20+22+22+22+35+42	1.50	1.65	1.65	1.65	2.62	3.14	12.20 (3.50-13.50)	3.959 (0.880-5.320)	17.39	99
20+22+22+22+35+50	1.43	1.57	1.57	1.57	2.50	3.57	12.20 (3.50-13.50)	3.955 (0.880-5.320)	17.37	99
20+22+22+22+42+42	1.44	1.58	1.58	1.58	3.01	3.01	12.20 (3.50-13.50)	3.955 (0.880-5.320)	17.37	99
20+22+22+22+42+50	1.37	1.51	1.51	1.51	2.88	3.43	12.20 (3.50-13.50)	3.951 (0.880-5.320)	17.35	99
20+22+22+25+25+25	1.76	1.93	1.93	2.19	2.19	2.19	12.20 (3.50-13.50)	3.986 (0.880-5.350)	17.50	99
20+22+22+25+25+35	1.64	1.80	1.80	2.05	2.05	2.87	12.20 (3.50-13.50)	3.968 (0.880-5.320)	17.43	99
20+22+22+25+25+42	1.56	1.72	1.72	1.96	1.96	3.28	12.20 (3.50-13.50)	3.963 (0.880-5.320)	17.40	99
20+22+22+25+25+50	1.49	1.64	1.64	1.86	1.86	3.72	12.20 (3.50-13.50)	3.959 (0.880-5.320)	17.38	99
20+22+22+25+25+60	1.40	1.54	1.54	1.75	1.75	4.21	12.20 (3.50-13.50)	3.953 (0.880-5.320)	17.36	99
20+22+22+25+35+35	1.53	1.69	1.69	1.92	2.69	2.69	12.20 (3.50-13.50)	3.961 (0.880-5.320)	17.40	99
20+22+22+25+35+42	1.47	1.62	1.62	1.84	2.57	3.09	12.20 (3.50-13.50)	3.957 (0.880-5.320)	17.38	99
20+22+22+25+35+50	1.40	1.54	1.54	1.75	2.45	3.51	12.20 (3.50-13.50)	3.953 (0.880-5.320)	17.36	99
20+22+22+25+42+42	1.41	1.55	1.55	1.76	2.96	2.96	12.20 (3.50-13.50)	3.954 (0.880-5.320)	17.36	99
20+22+22+35+35+35	1.44	1.59	1.59	2.53	2.53	2.53	12.20 (3.50-13.50)	3.956 (0.880-5.320)	17.37	99
20+22+22+35+35+42	1.39	1.53	1.53	2.43	2.43	2.91	12.20 (3.50-13.50)	3.952 (0.880-5.320)	17.36	99
20+22+25+25+25+25	1.72	1.89	2.15	2.15	2.15	2.15	12.20 (3.50-13.50)	3.980 (0.880-5.340)	17.48	99
20+22+25+25+25+35	1.61	1.77	2.01	2.01	2.01	2.81	12.20 (3.50-13.50)	3.965 (0.880-5.320)	17.41	99
20+22+25+25+25+42	1.53	1.69	1.92	1.92	1.92	3.22	12.20 (3.50-13.50)	3.961 (0.880-5.320)	17.40	99
20+22+25+25+25+50	1.46	1.61	1.83	1.83	1.83	3.65	12.20 (3.50-13.50)	3.957 (0.880-5.320)	17.38	99

MXZ-6C122VA HEATING

Indoor units combination	Heating Capacity (kW)							Outdoor unit power consumption (kW)	Current (A)	Power factor (%)
	Unit A	Unit B	Unit C	Unit D	Unit E	Unit F	Total			
20+20+20+35	2.23	2.00	2.00	3.50	-	-	10.60 (3.20-14.20)	2.627 (0.780-4.140)	11.54	99
20+20+20+42	2.35	1.96	1.96	4.12	-	-	12.00 (3.20-14.90)	3.070 (0.760-4.250)	13.48	99
20+20+20+50	2.31	1.85	1.85	4.64	-	-	12.70 (3.20-15.00)	3.490 (0.760-4.720)	15.33	99
20+20+20+60	2.15	1.73	1.73	5.20	-	-	12.90 (3.20-15.00)	3.610 (0.760-4.720)	15.85	99
20+20+20+71	1.98	1.60	1.60	5.69	-	-	13.00 (3.20-15.00)	3.670 (0.760-4.720)	16.12	99
20+20+22+22	2.62	2.00	2.20	2.20	-	-	11.00 (3.20-14.40)	2.717 (0.770-4.100)	11.93	99
20+20+22+25	2.60	2.00	2.20	2.50	-	-	11.30 (3.20-14.60)	2.780 (0.760-4.070)	12.21	99
20+20+22+35	2.41	2.00	2.20	3.50	-	-	11.70 (3.20-14.80)	2.940 (0.760-4.180)	12.91	99
20+20+22+42	2.40	1.94	2.14	4.08	-	-	12.50 (3.20-14.90)	3.370 (0.760-4.250)	14.80	99
20+20+22+50	2.32	1.82	2.00	4.55	-	-	13.00 (3.20-15.00)	3.670 (0.760-4.720)	16.12	99
20+20+22+60	2.15	1.70	1.88	5.11	-	-	13.10 (3.20-15.00)	3.730 (0.760-4.720)	16.38	99
20+20+22+71	1.98	1.59	1.75	5.66	-	-	13.20 (3.20-15.00)	3.760 (0.760-4.720)	16.51	99
20+20+25+25	2.56	2.00	2.50	2.50	-	-	11.50 (3.20-14.60)	2.850 (0.760-4.050)	12.52	99
20+20+25+35	2.40	2.00	2.50	3.50	-	-	12.00 (3.20-14.90)	3.070 (0.760-4.250)	13.48	99
20+20+25+42	2.36	1.89	2.36	3.96	-	-	12.60 (3.20-14.90)	3.430 (0.760-4.250)	15.06	99
20+20+25+50	2.26	1.79	2.24	4.48	-	-	13.00 (3.20-15.00)	3.670 (0.760-4.720)	16.12	99
20+20+25+60	2.11	1.66	2.08	4.99	-	-	13.20 (3.20-15.00)	3.790 (0.760-4.720)	16.64	99
20+20+25+71	1.94	1.56	1.95	5.53	-	-	13.20 (3.20-15.00)	3.760 (0.760-4.720)	16.51	99
20+20+35+35	2.22	1.85	3.25	3.25	-	-	12.20 (3.20-14.90)	3.190 (0.760-4.250)	14.01	99
20+20+35+42	2.17	1.76	3.08	3.70	-	-	12.70 (3.20-15.00)	3.490 (0.760-4.720)	15.33	99
20+20+35+50	2.10	1.66	2.91	4.16	-	-	13.10 (3.20-15.00)	3.730 (0.760-4.720)	16.38	99
20+20+35+60	1.96	1.57	2.75	4.71	-	-	13.20 (3.20-15.00)	3.760 (0.760-4.720)	16.51	99
20+20+35+71	1.81	1.47	2.57	5.20	-	-	13.20 (3.20-15.00)	3.750 (0.760-4.720)	16.47	99
20+20+42+42	2.10	1.68	3.52	3.52	-	-	13.00 (3.20-15.00)	3.670 (0.760-4.720)	16.12	99
20+20+42+50	2.00	1.61	3.37	4.02	-	-	13.20 (3.20-15.00)	3.750 (0.760-4.720)	16.47	99
20+20+42+60	1.86	1.51	3.16	4.52	-	-	13.20 (3.20-15.00)	3.700 (0.760-4.720)	16.25	99
20+20+42+71	1.73	1.40	2.94	4.97	-	-	13.20 (3.20-15.10)	3.650 (0.760-4.500)	16.03	99
20+20+50+50	1.89	1.53	3.82	3.82	-	-	13.20 (3.20-15.10)	3.630 (0.760-4.500)	15.94	99
20+20+50+60	1.76	1.43	3.57	4.28	-	-	13.20 (3.20-15.10)	3.600 (0.760-4.500)	15.81	99
20+20+50+71	1.64	1.34	3.35	4.76	-	-	13.20 (3.20-15.10)	3.600 (0.760-4.500)	15.81	99
20+20+60+60	1.65	1.35	4.05	4.05	-	-	13.20 (3.20-15.10)	3.600 (0.760-4.500)	15.81	99
20+20+60+71	1.54	1.26	3.79	4.48	-	-	13.20 (3.20-15.10)	3.600 (0.760-4.500)	15.81	99
20+22+22+22	2.81	2.20	2.20	2.20	-	-	12.10 (3.20-14.90)	3.130 (0.760-4.250)	13.75	99
20+22+22+25	2.74	2.20	2.20	2.50	-	-	12.20 (3.20-14.90)	3.190 (0.760-4.250)	14.01	99
20+22+22+35	2.48	2.20	2.20	3.50	-	-	12.30 (3.20-14.90)	3.250 (0.760-4.250)	14.27	99
20+22+22+42	2.42	2.10	2.10	4.00	-	-	12.80 (3.20-15.00)	3.550 (0.760-4.720)	15.59	99
20+22+22+50	2.32	1.97	1.97	4.47	-	-	13.20 (3.20-15.00)	3.780 (0.760-4.720)	16.60	99
20+22+22+60	2.13	1.85	1.85	5.03	-	-	13.20 (3.20-15.00)	3.760 (0.760-4.720)	16.51	99
20+22+22+71	1.96	1.73	1.73	5.57	-	-	13.20 (3.20-15.00)	3.720 (0.760-4.720)	16.34	99
20+22+25+25	2.67	2.20	2.50	2.50	-	-	12.30 (3.20-14.90)	3.250 (0.760-4.250)	14.27	99
20+22+25+35	2.43	2.16	2.45	3.43	-	-	12.40 (3.20-14.90)	3.310 (0.760-4.250)	14.54	99
20+22+25+42	2.37	2.06	2.34	3.93	-	-	12.90 (3.20-15.00)	3.610 (0.760-4.720)	15.85	99
20+22+25+50	2.26	1.94	2.20	4.40	-	-	13.20 (3.20-15.00)	3.760 (0.760-4.720)	16.51	99
20+22+25+60	2.08	1.82	2.07	4.96	-	-	13.20 (3.20-15.00)	3.750 (0.760-4.720)	16.47	99
20+22+25+71	1.91	1.71	1.94	5.51	-	-	13.20 (3.20-15.00)	3.710 (0.760-4.720)	16.29	99
20+22+35+35	2.25	2.00	3.19	3.19	-	-	12.60 (3.20-15.00)	3.430 (0.760-4.720)	15.06	99

MXZ-6C122VA HEATING

Indoor units combination	Heating Capacity (kW)							Outdoor unit power consumption (kW)	Current (A)	Power factor (%)
	Unit A	Unit B	Unit C	Unit D	Unit E	Unit F	Total			
20+22+35+42	2.18	1.90	3.03	3.64	-	-	13.00 (3.20-15.00)	3.670 (0.760-4.720)	16.12	99
20+22+35+50	2.08	1.82	2.89	4.13	-	-	13.20 (3.20-15.00)	3.760 (0.760-4.720)	16.51	99
20+22+35+60	1.93	1.70	2.71	4.64	-	-	13.20 (3.20-15.00)	3.720 (0.760-4.720)	16.34	99
20+22+35+71	1.78	1.59	2.53	5.13	-	-	13.20 (3.20-15.10)	3.660 (0.760-4.500)	16.07	99
20+22+42+42	2.10	1.83	3.50	3.50	-	-	13.20 (3.20-15.00)	3.760 (0.760-4.720)	16.51	99
20+22+42+50	1.97	1.74	3.32	3.96	-	-	13.20 (3.20-15.10)	3.660 (0.760-4.500)	16.07	99
20+22+42+60	1.83	1.63	3.12	4.46	-	-	13.20 (3.20-15.10)	3.630 (0.760-4.500)	15.94	99
20+22+42+71	1.70	1.53	2.93	4.95	-	-	13.20 (3.20-15.10)	3.600 (0.760-4.500)	15.81	99
20+22+50+50	1.86	1.66	3.77	3.77	-	-	13.20 (3.20-15.10)	3.600 (0.760-4.500)	15.81	99
20+22+50+60	1.74	1.55	3.52	4.22	-	-	13.20 (3.20-15.10)	3.600 (0.760-4.500)	15.81	99
20+22+50+71	1.62	1.46	3.31	4.70	-	-	13.20 (3.20-15.10)	3.600 (0.760-4.500)	15.81	99
20+22+60+60	1.63	1.47	4.00	4.00	-	-	13.20 (3.20-15.10)	3.600 (0.760-4.500)	15.81	99
20+22+60+71	1.53	1.37	3.75	4.43	-	-	13.20 (3.20-15.10)	3.600 (0.760-4.500)	15.81	99
20+25+25+25	2.61	2.50	2.50	2.50	-	-	12.40 (3.20-14.90)	3.310 (0.760-4.250)	14.54	99
20+25+25+35	2.40	2.40	2.40	3.37	-	-	12.60 (3.20-14.90)	3.430 (0.760-4.250)	15.06	99
20+25+25+42	2.32	2.28	2.28	3.83	-	-	13.00 (3.20-15.00)	3.670 (0.760-4.720)	16.12	99
20+25+25+50	2.20	2.17	2.17	4.33	-	-	13.20 (3.20-15.00)	3.760 (0.760-4.720)	16.51	99
20+25+25+60	2.03	2.02	2.02	4.85	-	-	13.20 (3.20-15.00)	3.740 (0.760-4.720)	16.43	99
20+25+25+71	1.87	1.90	1.90	5.39	-	-	13.20 (3.20-15.10)	3.670 (0.760-4.500)	16.12	99
20+25+35+35	2.21	2.24	3.13	3.13	-	-	12.70 (3.20-15.00)	3.490 (0.760-4.720)	15.33	99
20+25+35+42	2.13	2.13	2.98	3.58	-	-	13.00 (3.20-15.00)	3.670 (0.760-4.720)	16.12	99
20+25+35+50	2.03	2.02	2.83	4.04	-	-	13.20 (3.20-15.00)	3.750 (0.760-4.720)	16.47	99
20+25+35+60	1.89	1.91	2.68	4.59	-	-	13.20 (3.20-15.00)	3.700 (0.760-4.720)	16.25	99
20+25+35+71	1.75	1.77	2.48	5.03	-	-	13.20 (3.20-15.10)	3.650 (0.760-4.500)	16.03	99
20+25+42+42	2.05	2.03	3.42	3.42	-	-	13.20 (3.20-15.00)	3.760 (0.760-4.720)	16.51	99
20+25+42+50	1.93	1.93	3.25	3.87	-	-	13.20 (3.20-15.10)	3.650 (0.760-4.500)	16.03	99
20+25+42+60	1.80	1.82	3.06	4.37	-	-	13.20 (3.20-15.10)	3.630 (0.760-4.500)	15.94	99
20+25+42+71	1.67	1.71	2.87	4.85	-	-	13.20 (3.20-15.10)	3.600 (0.760-4.500)	15.81	99
20+25+50+50	1.82	1.84	3.69	3.69	-	-	13.20 (3.20-15.10)	3.600 (0.760-4.500)	15.81	99
20+25+50+60	1.70	1.74	3.48	4.18	-	-	13.20 (3.20-15.10)	3.600 (0.760-4.500)	15.81	99
20+25+50+71	1.59	1.63	3.25	4.62	-	-	13.20 (3.20-15.10)	3.600 (0.760-4.500)	15.81	99
20+25+60+60	1.60	1.64	3.93	3.93	-	-	13.20 (3.20-15.10)	3.600 (0.760-4.500)	15.81	99
20+25+60+71	1.50	1.53	3.68	4.36	-	-	13.20 (3.20-15.10)	3.600 (0.760-4.500)	15.81	99
20+35+35+35	2.05	2.91	2.91	2.91	-	-	12.80 (3.20-15.00)	3.550 (0.760-4.720)	15.59	99
20+35+35+42	1.98	2.81	2.81	3.37	-	-	13.10 (3.20-15.00)	3.730 (0.760-4.720)	16.38	99
20+35+35+50	1.89	2.68	2.68	3.82	-	-	13.20 (3.20-15.00)	3.720 (0.760-4.720)	16.34	99
20+35+35+60	1.76	2.50	2.50	4.28	-	-	13.20 (3.20-15.10)	3.660 (0.760-4.500)	16.07	99
20+35+35+71	1.64	2.35	2.35	4.76	-	-	13.20 (3.20-15.10)	3.650 (0.760-4.500)	16.03	99
20+35+42+42	1.90	2.69	3.23	3.23	-	-	13.20 (3.20-15.00)	3.750 (0.760-4.720)	16.47	99
20+35+42+50	1.80	2.55	3.06	3.64	-	-	13.20 (3.20-15.10)	3.630 (0.760-4.500)	15.94	99
20+35+42+60	1.68	2.41	2.89	4.13	-	-	13.20 (3.20-15.10)	3.600 (0.760-4.500)	15.81	99
20+35+42+71	1.57	2.25	2.70	4.56	-	-	13.20 (3.20-15.10)	3.600 (0.760-4.500)	15.81	99
20+35+50+50	1.70	2.44	3.48	3.48	-	-	13.20 (3.20-15.10)	3.600 (0.760-4.500)	15.81	99
20+35+50+60	1.60	2.29	3.27	3.93	-	-	13.20 (3.20-15.10)	3.600 (0.760-4.500)	15.81	99
20+35+50+71	1.50	2.15	3.07	4.36	-	-	13.20 (3.20-15.10)	3.600 (0.760-4.500)	15.81	99
20+35+60+60	1.51	2.16	3.70	3.70	-	-	13.20 (3.20-15.10)	3.600 (0.760-4.500)	15.81	99

MXZ-6C122VA HEATING

Indoor units combination	Heating Capacity (kW)							Outdoor unit power consumption (kW)	Current (A)	Power factor (%)
	Unit A	Unit B	Unit C	Unit D	Unit E	Unit F	Total			
20+42+42+42	1.81	3.08	3.08	3.08	-	-	13.20 (3.20-15.10)	3.650 (0.760-4.500)	16.03	99
20+42+42+50	1.71	2.95	2.95	3.51	-	-	13.20 (3.20-15.10)	3.600 (0.760-4.500)	15.81	99
20+42+42+60	1.61	2.77	2.77	3.95	-	-	13.20 (3.20-15.10)	3.600 (0.760-4.500)	15.81	99
20+42+42+71	1.51	2.59	2.59	4.38	-	-	13.20 (3.20-15.10)	3.600 (0.760-4.500)	15.81	99
20+42+50+50	1.63	2.80	3.33	3.33	-	-	13.20 (3.20-15.10)	3.600 (0.760-4.500)	15.81	99
20+42+50+60	1.53	2.64	3.14	3.77	-	-	13.20 (3.20-15.10)	3.600 (0.760-4.500)	15.81	99
20+50+50+50	1.55	3.18	3.18	3.18	-	-	13.20 (3.20-15.10)	3.600 (0.760-4.500)	15.81	99
20+50+50+60	1.47	3.00	3.00	3.60	-	-	13.20 (3.20-15.10)	3.600 (0.760-4.500)	15.81	99
22+22+22+22	3.13	2.20	2.20	2.20	-	-	12.50 (3.20-14.90)	3.370 (0.760-4.250)	14.80	99
22+22+22+25	3.05	2.20	2.20	2.50	-	-	12.60 (3.20-14.90)	3.430 (0.760-4.250)	15.06	99
22+22+22+35	2.77	2.18	2.18	3.47	-	-	12.70 (3.20-15.00)	3.490 (0.760-4.720)	15.33	99
22+22+22+42	2.67	2.06	2.06	3.93	-	-	13.10 (3.20-15.00)	3.730 (0.760-4.720)	16.38	99
22+22+22+50	2.50	1.95	1.95	4.44	-	-	13.20 (3.20-15.00)	3.740 (0.760-4.720)	16.43	99
22+22+22+60	2.30	1.83	1.83	5.00	-	-	13.20 (3.20-15.10)	3.700 (0.760-4.500)	16.25	99
22+22+22+71	2.12	1.70	1.70	5.49	-	-	13.20 (3.20-15.10)	3.650 (0.760-4.500)	16.03	99
22+22+25+25	2.95	2.20	2.50	2.50	-	-	12.60 (3.20-15.00)	3.430 (0.760-4.720)	15.06	99
22+22+25+35	2.71	2.14	2.43	3.40	-	-	12.80 (3.20-15.00)	3.550 (0.760-4.720)	15.59	99
22+22+25+42	2.60	2.02	2.30	3.86	-	-	13.10 (3.20-15.00)	3.730 (0.760-4.720)	16.38	99
22+22+25+50	2.44	1.90	2.16	4.33	-	-	13.20 (3.20-15.00)	3.720 (0.760-4.720)	16.34	99
22+22+25+60	2.25	1.79	2.03	4.88	-	-	13.20 (3.20-15.10)	3.660 (0.760-4.500)	16.07	99
22+22+25+71	2.07	1.68	1.91	5.43	-	-	13.20 (3.20-15.10)	3.650 (0.760-4.500)	16.03	99
22+22+35+35	2.49	1.97	3.13	3.13	-	-	12.90 (3.20-15.00)	3.610 (0.760-4.720)	15.85	99
22+22+35+42	2.40	1.89	3.01	3.61	-	-	13.20 (3.20-15.00)	3.780 (0.760-4.720)	16.60	99
22+22+35+50	2.25	1.79	2.85	4.07	-	-	13.20 (3.20-15.10)	3.690 (0.760-4.500)	16.21	99
22+22+35+60	2.09	1.69	2.69	4.62	-	-	13.20 (3.20-15.10)	3.650 (0.760-4.500)	16.03	99
22+22+35+71	1.94	1.57	2.50	5.06	-	-	13.20 (3.20-15.10)	3.610 (0.760-4.500)	15.85	99
22+22+42+42	2.27	1.80	3.45	3.45	-	-	13.20 (3.20-15.00)	3.720 (0.760-4.720)	16.34	99
22+22+42+50	2.14	1.71	3.27	3.90	-	-	13.20 (3.20-15.10)	3.610 (0.760-4.500)	15.85	99
22+22+42+60	1.99	1.61	3.08	4.40	-	-	13.20 (3.20-15.10)	3.600 (0.760-4.500)	15.81	99
22+22+42+71	1.85	1.51	2.89	4.88	-	-	13.20 (3.20-15.10)	3.600 (0.760-4.500)	15.81	99
22+22+50+50	2.02	1.63	3.72	3.72	-	-	13.20 (3.20-15.10)	3.600 (0.760-4.500)	15.81	99
22+22+50+60	1.89	1.54	3.51	4.21	-	-	13.20 (3.20-15.10)	3.600 (0.760-4.500)	15.81	99
22+22+50+71	1.76	1.44	3.27	4.65	-	-	13.20 (3.20-15.10)	3.600 (0.760-4.500)	15.81	99
22+22+60+60	1.77	1.45	3.95	3.95	-	-	13.20 (3.20-15.10)	3.600 (0.760-4.500)	15.81	99
22+22+60+71	1.66	1.36	3.70	4.38	-	-	13.20 (3.20-15.10)	3.600 (0.760-4.500)	15.81	99
22+25+25+25	2.88	2.50	2.50	2.50	-	-	12.70 (3.20-15.00)	3.490 (0.760-4.720)	15.33	99
22+25+25+35	2.65	2.36	2.36	3.30	-	-	12.90 (3.20-15.00)	3.610 (0.760-4.720)	15.85	99
22+25+25+42	2.55	2.24	2.24	3.76	-	-	13.20 (3.20-15.00)	3.790 (0.760-4.720)	16.64	99
22+25+25+50	2.38	2.13	2.13	4.26	-	-	13.20 (3.20-15.00)	3.710 (0.760-4.720)	16.29	99
22+25+25+60	2.20	2.01	2.01	4.82	-	-	13.20 (3.20-15.10)	3.650 (0.760-4.500)	16.03	99
22+25+25+71	2.03	1.87	1.87	5.31	-	-	13.20 (3.20-15.10)	3.630 (0.760-4.500)	15.94	99
22+25+35+35	2.44	2.20	3.08	3.08	-	-	13.00 (3.20-15.00)	3.670 (0.760-4.720)	16.12	99
22+25+35+42	2.34	2.10	2.94	3.52	-	-	13.20 (3.20-15.00)	3.760 (0.760-4.720)	16.51	99
22+25+35+50	2.20	2.01	2.81	4.02	-	-	13.20 (3.20-15.10)	3.660 (0.760-4.500)	16.07	99
22+25+35+60	2.05	1.88	2.64	4.52	-	-	13.20 (3.20-15.10)	3.630 (0.760-4.500)	15.94	99
22+25+35+71	1.90	1.75	2.45	4.97	-	-	13.20 (3.20-15.10)	3.600 (0.760-4.500)	15.81	99

MXZ-6C122VA HEATING

Indoor units combination	Heating Capacity (kW)							Outdoor unit power consumption (kW)	Current (A)	Power factor (%)
	Unit A	Unit B	Unit C	Unit D	Unit E	Unit F	Total			
22+25+42+42	2.22	2.00	3.37	3.37	-	-	13.20 (3.20-15.00)	3.700 (0.760-4.720)	16.25	99
22+25+42+50	2.09	1.92	3.23	3.85	-	-	13.20 (3.20-15.10)	3.600 (0.760-4.500)	15.81	99
22+25+42+60	1.95	1.80	3.02	4.31	-	-	13.20 (3.20-15.10)	3.600 (0.760-4.500)	15.81	99
22+25+42+71	1.82	1.69	2.84	4.79	-	-	13.20 (3.20-15.10)	3.600 (0.760-4.500)	15.81	99
22+25+50+50	1.98	1.82	3.64	3.64	-	-	13.20 (3.20-15.10)	3.600 (0.760-4.500)	15.81	99
22+25+50+60	1.85	1.72	3.44	4.13	-	-	13.20 (3.20-15.10)	3.600 (0.760-4.500)	15.81	99
22+25+50+71	1.73	1.61	3.21	4.56	-	-	13.20 (3.20-15.10)	3.600 (0.760-4.500)	15.81	99
22+25+60+60	1.74	1.62	3.88	3.88	-	-	13.20 (3.20-15.10)	3.600 (0.760-4.500)	15.81	99
22+25+60+71	1.63	1.52	3.64	4.31	-	-	13.20 (3.20-15.10)	3.600 (0.760-4.500)	15.81	99
22+35+35+35	2.27	2.89	2.89	2.89	-	-	13.10 (3.20-15.00)	3.730 (0.760-4.720)	16.38	99
22+35+35+42	2.17	2.77	2.77	3.32	-	-	13.20 (3.20-15.00)	3.760 (0.760-4.720)	16.51	99
22+35+35+50	2.05	2.64	2.64	3.77	-	-	13.20 (3.20-15.10)	3.650 (0.760-4.500)	16.03	99
22+35+35+60	1.91	2.46	2.46	4.22	-	-	13.20 (3.20-15.10)	3.610 (0.760-4.500)	15.85	99
22+35+35+71	1.78	2.32	2.32	4.70	-	-	13.20 (3.20-15.10)	3.600 (0.760-4.500)	15.81	99
22+35+42+42	2.06	2.66	3.19	3.19	-	-	13.20 (3.20-15.10)	3.660 (0.760-4.500)	16.07	99
22+35+42+50	1.95	2.51	3.02	3.59	-	-	13.20 (3.20-15.10)	3.600 (0.760-4.500)	15.81	99
22+35+42+60	1.83	2.38	2.85	4.08	-	-	13.20 (3.20-15.10)	3.600 (0.760-4.500)	15.81	99
22+35+42+71	1.71	2.22	2.67	4.51	-	-	13.20 (3.20-15.10)	3.600 (0.760-4.500)	15.81	99
22+35+50+50	1.85	2.41	3.44	3.44	-	-	13.20 (3.20-15.10)	3.600 (0.760-4.500)	15.81	99
22+35+50+60	1.74	2.26	3.23	3.88	-	-	13.20 (3.20-15.10)	3.600 (0.760-4.500)	15.81	99
22+35+50+71	1.63	2.12	3.03	4.31	-	-	13.20 (3.20-15.10)	3.600 (0.760-4.500)	15.81	99
22+35+60+60	1.64	2.14	3.66	3.66	-	-	13.20 (3.20-15.10)	3.600 (0.760-4.500)	15.81	99
22+42+42+42	1.96	3.04	3.04	3.04	-	-	13.20 (3.20-15.10)	3.600 (0.760-4.500)	15.81	99
22+42+42+50	1.86	2.91	2.91	3.46	-	-	13.20 (3.20-15.10)	3.600 (0.760-4.500)	15.81	99
22+42+42+60	1.75	2.73	2.73	3.90	-	-	13.20 (3.20-15.10)	3.600 (0.760-4.500)	15.81	99
22+42+42+71	1.64	2.56	2.56	4.33	-	-	13.20 (3.20-15.10)	3.600 (0.760-4.500)	15.81	99
22+42+50+50	1.77	2.77	3.29	3.29	-	-	13.20 (3.20-15.10)	3.600 (0.760-4.500)	15.81	99
22+42+50+60	1.67	2.61	3.10	3.72	-	-	13.20 (3.20-15.10)	3.600 (0.760-4.500)	15.81	99
22+50+50+50	1.69	3.14	3.14	3.14	-	-	13.20 (3.20-15.10)	3.600 (0.760-4.500)	15.81	99
25+25+25+25	3.20	2.50	2.50	2.50	-	-	12.80 (3.20-15.00)	3.550 (0.760-4.720)	15.59	99
25+25+25+35	2.95	2.32	2.32	3.25	-	-	13.00 (3.20-15.00)	3.670 (0.760-4.720)	16.12	99
25+25+25+42	2.82	2.20	2.20	3.70	-	-	13.20 (3.20-15.00)	3.780 (0.760-4.720)	16.60	99
25+25+25+50	2.64	2.08	2.08	4.16	-	-	13.20 (3.20-15.10)	3.670 (0.760-4.500)	16.12	99
25+25+25+60	2.44	1.96	1.96	4.71	-	-	13.20 (3.20-15.10)	3.650 (0.760-4.500)	16.03	99
25+25+25+71	2.26	1.83	1.83	5.20	-	-	13.20 (3.20-15.10)	3.610 (0.760-4.500)	15.85	99
25+25+35+35	2.71	2.17	3.03	3.03	-	-	13.00 (3.20-15.00)	3.670 (0.760-4.720)	16.12	99
25+25+35+42	2.60	2.07	2.89	3.47	-	-	13.20 (3.20-15.00)	3.760 (0.760-4.720)	16.51	99
25+25+35+50	2.44	1.96	2.75	3.93	-	-	13.20 (3.20-15.10)	3.650 (0.760-4.500)	16.03	99
25+25+35+60	2.28	1.84	2.58	4.43	-	-	13.20 (3.20-15.10)	3.630 (0.760-4.500)	15.94	99
25+25+35+71	2.12	1.73	2.42	4.92	-	-	13.20 (3.20-15.10)	3.600 (0.760-4.500)	15.81	99
25+25+42+42	2.46	1.98	3.32	3.32	-	-	13.20 (3.20-15.10)	3.670 (0.760-4.500)	16.12	99
25+25+42+50	2.32	1.88	3.16	3.77	-	-	13.20 (3.20-15.10)	3.600 (0.760-4.500)	15.81	99
25+25+42+60	2.17	1.76	2.96	4.22	-	-	13.20 (3.20-15.10)	3.600 (0.760-4.500)	15.81	99
25+25+42+71	2.02	1.66	2.78	4.70	-	-	13.20 (3.20-15.10)	3.600 (0.760-4.500)	15.81	99
25+25+50+50	2.20	1.78	3.57	3.57	-	-	13.20 (3.20-15.10)	3.600 (0.760-4.500)	15.81	99
25+25+50+60	2.06	1.69	3.38	4.05	-	-	13.20 (3.20-15.10)	3.600 (0.760-4.500)	15.81	99

MXZ-6C122VA HEATING

Indoor units combination	Heating Capacity (kW)							Outdoor unit power consumption (kW)	Current (A)	Power factor (%)
	Unit A	Unit B	Unit C	Unit D	Unit E	Unit F	Total			
25+25+50+71	1.93	1.58	3.16	4.48	-	-	13.20 (3.20-15.10)	3.600 (0.760-4.500)	15.81	99
25+25+60+60	1.94	1.59	3.81	3.81	-	-	13.20 (3.20-15.10)	3.600 (0.760-4.500)	15.81	99
25+35+35+35	2.52	2.83	2.83	2.83	-	-	13.10 (3.20-15.00)	3.730 (0.760-4.720)	16.38	99
25+35+35+42	2.41	2.71	2.71	3.25	-	-	13.20 (3.20-15.00)	3.750 (0.760-4.720)	16.47	99
25+35+35+50	2.28	2.58	2.58	3.69	-	-	13.20 (3.20-15.10)	3.630 (0.760-4.500)	15.94	99
25+35+35+60	2.13	2.44	2.44	4.18	-	-	13.20 (3.20-15.10)	3.600 (0.760-4.500)	15.81	99
25+35+35+71	1.99	2.28	2.28	4.62	-	-	13.20 (3.20-15.10)	3.600 (0.760-4.500)	15.81	99
25+35+42+42	2.29	2.60	3.12	3.12	-	-	13.20 (3.20-15.10)	3.650 (0.760-4.500)	16.03	99
25+35+42+50	2.17	2.46	2.96	3.52	-	-	13.20 (3.20-15.10)	3.600 (0.760-4.500)	15.81	99
25+35+42+60	2.04	2.33	2.80	4.00	-	-	13.20 (3.20-15.10)	3.600 (0.760-4.500)	15.81	99
25+35+42+71	1.91	2.18	2.62	4.43	-	-	13.20 (3.20-15.10)	3.600 (0.760-4.500)	15.81	99
25+35+50+50	2.06	2.36	3.38	3.38	-	-	13.20 (3.20-15.10)	3.600 (0.760-4.500)	15.81	99
25+35+50+60	1.94	2.22	3.18	3.81	-	-	13.20 (3.20-15.10)	3.600 (0.760-4.500)	15.81	99
25+35+60+60	1.83	2.10	3.60	3.60	-	-	13.20 (3.20-15.10)	3.600 (0.760-4.500)	15.81	99
25+42+42+42	2.19	2.98	2.98	2.98	-	-	13.20 (3.20-15.10)	3.600 (0.760-4.500)	15.81	99
25+42+42+50	2.08	2.85	2.85	3.40	-	-	13.20 (3.20-15.10)	3.600 (0.760-4.500)	15.81	99
25+42+42+60	1.95	2.68	2.68	3.83	-	-	13.20 (3.20-15.10)	3.600 (0.760-4.500)	15.81	99
25+42+42+71	1.83	2.52	2.52	4.26	-	-	13.20 (3.20-15.10)	3.600 (0.760-4.500)	15.81	99
25+42+50+50	1.98	2.72	3.23	3.23	-	-	13.20 (3.20-15.10)	3.600 (0.760-4.500)	15.81	99
25+42+50+60	1.86	2.56	3.05	3.66	-	-	13.20 (3.20-15.10)	3.600 (0.760-4.500)	15.81	99
25+50+50+50	1.89	3.09	3.09	3.09	-	-	13.20 (3.20-15.10)	3.600 (0.760-4.500)	15.81	99
35+35+35+35	3.30	2.68	2.68	2.68	-	-	13.20 (3.20-15.00)	3.780 (0.760-4.720)	16.60	99
35+35+35+42	3.14	2.55	2.55	3.06	-	-	13.20 (3.20-15.00)	3.720 (0.760-4.720)	16.34	99
35+35+35+50	2.98	2.44	2.44	3.48	-	-	13.20 (3.20-15.10)	3.610 (0.760-4.500)	15.85	99
35+35+35+60	2.80	2.29	2.29	3.93	-	-	13.20 (3.20-15.10)	3.600 (0.760-4.500)	15.81	99
35+35+35+71	2.63	2.15	2.15	4.36	-	-	13.20 (3.20-15.10)	3.600 (0.760-4.500)	15.81	99
35+35+42+42	3.00	2.45	2.95	2.95	-	-	13.20 (3.20-15.10)	3.630 (0.760-4.500)	15.94	99
35+35+42+50	2.85	2.33	2.80	3.33	-	-	13.20 (3.20-15.10)	3.600 (0.760-4.500)	15.81	99
35+35+42+60	2.69	2.20	2.64	3.77	-	-	13.20 (3.20-15.10)	3.600 (0.760-4.500)	15.81	99
35+35+50+50	2.72	2.22	3.18	3.18	-	-	13.20 (3.20-15.10)	3.600 (0.760-4.500)	15.81	99
35+35+50+60	2.57	2.10	3.00	3.60	-	-	13.20 (3.20-15.10)	3.600 (0.760-4.500)	15.81	99
35+42+42+42	2.87	2.82	2.82	2.82	-	-	13.20 (3.20-15.10)	3.600 (0.760-4.500)	15.81	99
35+42+42+50	2.73	2.68	2.68	3.20	-	-	13.20 (3.20-15.10)	3.600 (0.760-4.500)	15.81	99
35+42+42+60	2.58	2.53	2.53	3.62	-	-	13.20 (3.20-15.10)	3.600 (0.760-4.500)	15.81	99
35+42+50+50	2.61	2.56	3.05	3.05	-	-	13.20 (3.20-15.10)	3.600 (0.760-4.500)	15.81	99
42+42+42+42	3.30	2.70	2.70	2.70	-	-	13.20 (3.20-15.10)	3.600 (0.760-4.500)	15.81	99
42+42+42+50	3.15	2.58	2.58	3.07	-	-	13.20 (3.20-15.10)	3.600 (0.760-4.500)	15.81	99
15+15+15+15+15	1.70	1.50	1.50	1.50	1.50	-	8.50 (3.40-13.80)	1.910 (0.800-5.220)	8.39	99
15+15+15+15+20	1.69	1.50	1.50	1.50	2.00	-	9.00 (3.40-14.00)	2.110 (0.800-5.300)	9.27	99
15+15+15+15+22	1.85	1.50	1.50	1.50	2.20	-	10.10 (3.40-14.60)	2.563 (0.800-5.500)	11.25	99
15+15+15+15+25	1.84	1.50	1.50	1.50	2.50	-	10.40 (3.40-14.60)	2.690 (0.800-5.530)	11.81	99
15+15+15+15+35	1.71	1.50	1.50	1.50	3.50	-	10.80 (3.40-14.90)	2.850 (0.800-5.620)	12.52	99
15+15+15+15+42	1.81	1.50	1.50	1.50	4.20	-	12.30 (3.50-15.10)	3.050 (0.780-4.850)	13.39	99
15+15+15+15+50	1.83	1.50	1.50	1.50	5.00	-	13.40 (3.50-15.50)	3.390 (0.770-4.800)	14.89	99
15+15+15+15+60	1.68	1.45	1.45	1.45	5.80	-	13.40 (3.50-15.60)	3.390 (0.770-4.910)	14.89	99
15+15+15+15+71	1.53	1.36	1.36	1.36	6.45	-	13.40 (3.50-15.60)	3.390 (0.770-4.910)	14.89	99

MXZ-6C122VA HEATING

Indoor units combination	Heating Capacity (kW)							Outdoor unit power consumption (kW)	Current (A)	Power factor (%)
	Unit A	Unit B	Unit C	Unit D	Unit E	Unit F	Total			
15+15+15+20+20	1.62	1.50	1.50	2.00	2.00	-	9.20 (3.40-14.10)	2.200 (0.800-5.330)	9.66	99
15+15+15+20+22	1.83	1.50	1.50	2.00	2.20	-	10.60 (3.40-14.70)	2.770 (0.800-5.560)	12.17	99
15+15+15+20+25	1.82	1.50	1.50	2.00	2.50	-	10.90 (3.40-14.90)	2.890 (0.800-5.640)	12.69	99
15+15+15+20+35	1.70	1.50	1.50	2.00	3.50	-	11.30 (3.40-15.00)	2.960 (0.800-5.350)	13.00	99
15+15+15+20+42	1.84	1.50	1.50	2.00	4.20	-	13.10 (3.50-15.20)	3.130 (0.770-4.460)	13.75	99
15+15+15+20+50	1.75	1.47	1.47	1.97	4.91	-	13.40 (3.50-15.60)	3.390 (0.770-4.910)	14.89	99
15+15+15+20+60	1.61	1.43	1.43	1.90	5.71	-	13.40 (3.50-15.60)	3.390 (0.770-4.910)	14.89	99
15+15+15+20+71	1.48	1.32	1.32	1.76	6.26	-	13.40 (3.50-15.60)	3.380 (0.770-4.900)	14.84	99
15+15+15+22+22	1.96	1.50	1.50	2.20	2.20	-	11.60 (3.40-15.00)	2.990 (0.790-5.250)	13.13	99
15+15+15+22+25	1.96	1.50	1.50	2.20	2.50	-	12.00 (3.50-15.10)	3.023 (0.790-4.990)	13.28	99
15+15+15+22+35	1.84	1.50	1.50	2.20	3.50	-	12.50 (3.50-15.10)	3.070 (0.780-4.850)	13.48	99
15+15+15+22+42	1.83	1.50	1.50	2.20	4.20	-	13.30 (3.50-15.50)	3.300 (0.770-4.800)	14.49	99
15+15+15+22+50	1.72	1.46	1.46	2.14	4.87	-	13.40 (3.50-15.60)	3.380 (0.770-4.900)	14.84	99
15+15+15+22+60	1.58	1.41	1.41	2.06	5.62	-	13.40 (3.50-15.60)	3.380 (0.770-4.900)	14.84	99
15+15+15+22+71	1.46	1.30	1.30	1.91	6.17	-	13.40 (3.50-15.60)	3.380 (0.770-4.900)	14.84	99
15+15+15+25+25	1.94	1.50	1.50	2.50	2.50	-	12.30 (3.50-15.10)	3.050 (0.780-4.850)	13.39	99
15+15+15+25+35	1.87	1.50	1.50	2.50	3.50	-	13.10 (3.50-15.20)	3.130 (0.770-4.460)	13.75	99
15+15+15+25+42	1.79	1.49	1.49	2.48	4.16	-	13.40 (3.50-15.60)	3.390 (0.770-4.910)	14.89	99
15+15+15+25+50	1.68	1.45	1.45	2.42	4.83	-	13.40 (3.50-15.60)	3.380 (0.770-4.900)	14.84	99
15+15+15+25+60	1.55	1.37	1.37	2.29	5.49	-	13.40 (3.50-15.60)	3.380 (0.770-4.900)	14.84	99
15+15+15+25+71	1.43	1.28	1.28	2.13	6.04	-	13.40 (3.50-15.60)	3.380 (0.770-4.900)	14.84	99
15+15+15+35+35	1.72	1.47	1.47	3.44	3.44	-	13.20 (3.50-15.30)	3.220 (0.770-4.570)	14.14	99
15+15+15+35+42	1.65	1.44	1.44	3.36	4.03	-	13.40 (3.50-15.60)	3.390 (0.770-4.910)	14.89	99
15+15+15+35+50	1.55	1.37	1.37	3.20	4.58	-	13.40 (3.50-15.60)	3.380 (0.770-4.900)	14.84	99
15+15+15+35+60	1.44	1.29	1.29	3.00	5.14	-	13.40 (3.50-15.60)	3.380 (0.770-4.900)	14.84	99
15+15+15+35+71	1.33	1.20	1.20	2.80	5.69	-	13.40 (3.50-15.60)	3.370 (0.770-4.890)	14.80	99
15+15+15+42+42	1.56	1.38	1.38	3.87	3.87	-	13.40 (3.50-15.60)	3.380 (0.770-4.900)	14.84	99
15+15+15+42+50	1.47	1.31	1.31	3.68	4.38	-	13.40 (3.50-15.60)	3.370 (0.770-4.890)	14.80	99
15+15+15+42+60	1.37	1.22	1.22	3.43	4.90	-	13.40 (3.50-15.60)	3.370 (0.770-4.890)	14.80	99
15+15+15+42+71	1.27	1.15	1.15	3.22	5.44	-	13.40 (3.50-15.60)	3.360 (0.770-4.880)	14.76	99
15+15+15+50+50	1.39	1.24	1.24	4.14	4.14	-	13.40 (3.50-15.60)	3.360 (0.770-4.880)	14.76	99
15+15+15+50+60	1.30	1.17	1.17	3.90	4.68	-	13.40 (3.50-15.60)	3.360 (0.770-4.880)	14.76	99
15+15+15+50+71	1.21	1.09	1.09	3.64	5.18	-	13.40 (3.50-15.60)	3.350 (0.770-4.870)	14.71	99
15+15+15+60+60	1.22	1.10	1.10	4.40	4.40	-	13.40 (3.50-15.60)	3.350 (0.770-4.870)	14.71	99
15+15+15+60+71	1.14	1.04	1.04	4.16	4.92	-	13.40 (3.50-15.60)	3.400 (0.770-4.870)	14.93	99
15+15+20+20+20	1.67	1.50	2.00	2.00	2.00	-	10.00 (3.40-14.50)	2.520 (0.800-5.490)	11.07	99
15+15+20+20+22	1.81	1.50	2.00	2.00	2.20	-	11.10 (3.40-15.00)	2.940 (0.800-5.550)	12.91	99
15+15+20+20+25	1.80	1.50	2.00	2.00	2.50	-	11.40 (3.40-15.00)	2.970 (0.790-5.250)	13.04	99
15+15+20+20+35	1.69	1.50	2.00	2.00	3.50	-	11.80 (3.40-15.00)	3.010 (0.790-5.250)	13.22	99
15+15+20+20+42	1.77	1.49	1.98	1.98	4.16	-	13.20 (3.50-15.30)	3.220 (0.770-4.570)	14.14	99
15+15+20+20+50	1.68	1.45	1.93	1.93	4.83	-	13.40 (3.50-15.60)	3.390 (0.770-4.910)	14.89	99
15+15+20+20+60	1.55	1.37	1.83	1.83	5.49	-	13.40 (3.50-15.60)	3.380 (0.770-4.900)	14.84	99
15+15+20+20+71	1.43	1.28	1.70	1.70	6.04	-	13.40 (3.50-15.60)	3.380 (0.770-4.900)	14.84	99
15+15+20+22+22	1.96	1.50	2.00	2.20	2.20	-	12.30 (3.50-15.10)	3.050 (0.780-4.850)	13.39	99
15+15+20+22+25	1.99	1.50	2.00	2.20	2.50	-	12.90 (3.50-15.20)	3.110 (0.770-4.460)	13.66	99
15+15+20+22+35	1.84	1.50	2.00	2.20	3.50	-	13.10 (3.50-15.30)	3.130 (0.770-4.570)	13.75	99

MXZ-6C122VA HEATING

Indoor units combination	Heating Capacity (kW)							Outdoor unit power consumption (kW)	Current (A)	Power factor (%)
	Unit A	Unit B	Unit C	Unit D	Unit E	Unit F	Total			
15+15+20+22+42	1.76	1.47	1.96	2.16	4.13	-	13.40 (3.50-15.60)	3.390 (0.770-4.910)	14.89	99
15+15+20+22+50	1.65	1.44	1.92	2.11	4.80	-	13.40 (3.50-15.60)	3.380 (0.770-4.900)	14.84	99
15+15+20+22+60	1.52	1.35	1.80	1.98	5.41	-	13.40 (3.50-15.60)	3.380 (0.770-4.900)	14.84	99
15+15+20+22+71	1.41	1.26	1.68	1.85	5.96	-	13.40 (3.50-15.60)	3.370 (0.770-4.890)	14.80	99
15+15+20+25+25	1.97	1.50	2.00	2.50	2.50	-	13.10 (3.50-15.20)	3.130 (0.770-4.460)	13.75	99
15+15+20+25+35	1.80	1.50	2.00	2.50	3.50	-	13.20 (3.50-15.30)	3.220 (0.770-4.570)	14.14	99
15+15+20+25+42	1.72	1.46	1.95	2.44	4.09	-	13.40 (3.50-15.60)	3.390 (0.770-4.910)	14.89	99
15+15+20+25+50	1.61	1.43	1.90	2.38	4.76	-	13.40 (3.50-15.60)	3.380 (0.770-4.900)	14.84	99
15+15+20+25+60	1.49	1.33	1.78	2.22	5.33	-	13.40 (3.50-15.60)	3.380 (0.770-4.900)	14.84	99
15+15+20+25+71	1.38	1.23	1.64	2.05	5.84	-	13.40 (3.50-15.60)	3.370 (0.770-4.890)	14.80	99
15+15+20+35+35	1.66	1.45	1.93	3.38	3.38	-	13.30 (3.50-15.50)	3.300 (0.770-4.800)	14.49	99
15+15+20+35+42	1.58	1.41	1.87	3.28	3.94	-	13.40 (3.50-15.60)	3.390 (0.770-4.910)	14.89	99
15+15+20+35+50	1.49	1.33	1.78	3.11	4.44	-	13.40 (3.50-15.60)	3.380 (0.770-4.900)	14.84	99
15+15+20+35+60	1.39	1.24	1.66	2.90	4.97	-	13.40 (3.50-15.60)	3.370 (0.770-4.890)	14.80	99
15+15+20+35+71	1.29	1.16	1.55	2.71	5.51	-	13.40 (3.50-15.60)	3.370 (0.770-4.890)	14.80	99
15+15+20+42+42	1.50	1.34	1.79	3.76	3.76	-	13.40 (3.50-15.60)	3.380 (0.770-4.900)	14.84	99
15+15+20+42+50	1.42	1.27	1.69	3.55	4.23	-	13.40 (3.50-15.60)	3.370 (0.770-4.890)	14.80	99
15+15+20+42+60	1.32	1.19	1.59	3.34	4.78	-	13.40 (3.50-15.60)	3.360 (0.770-4.880)	14.76	99
15+15+20+42+71	1.23	1.11	1.48	3.12	5.27	-	13.40 (3.50-15.60)	3.360 (0.770-4.880)	14.76	99
15+15+20+50+50	1.34	1.21	1.61	4.03	4.03	-	13.40 (3.50-15.60)	3.360 (0.770-4.880)	14.76	99
15+15+20+50+60	1.26	1.13	1.51	3.78	4.54	-	13.40 (3.50-15.60)	3.350 (0.770-4.870)	14.71	99
15+15+20+50+71	1.18	1.07	1.43	3.57	5.07	-	13.40 (3.50-15.60)	3.350 (0.770-4.870)	14.71	99
15+15+20+60+60	1.18	1.08	1.44	4.31	4.31	-	13.40 (3.50-15.60)	3.350 (0.770-4.870)	14.71	99
15+15+22+22+22	2.06	1.50	2.20	2.20	2.20	-	13.20 (3.50-15.40)	3.220 (0.770-4.690)	14.14	99
15+15+22+22+25	2.02	1.50	2.20	2.20	2.50	-	13.30 (3.50-15.50)	3.300 (0.770-4.800)	14.49	99
15+15+22+22+35	1.84	1.50	2.20	2.20	3.50	-	13.40 (3.50-15.50)	3.390 (0.770-4.800)	14.89	99
15+15+22+22+42	1.73	1.47	2.16	2.16	4.13	-	13.40 (3.50-15.60)	3.390 (0.770-4.910)	14.89	99
15+15+22+22+50	1.62	1.43	2.09	2.09	4.76	-	13.40 (3.50-15.60)	3.380 (0.770-4.900)	14.84	99
15+15+22+22+60	1.50	1.34	1.97	1.97	5.37	-	13.40 (3.50-15.60)	3.370 (0.770-4.890)	14.80	99
15+15+22+22+71	1.39	1.24	1.82	1.82	5.88	-	13.40 (3.50-15.60)	3.370 (0.770-4.890)	14.80	99
15+15+22+25+25	1.96	1.50	2.20	2.50	2.50	-	13.30 (3.50-15.50)	3.300 (0.770-4.800)	14.49	99
15+15+22+25+35	1.79	1.49	2.18	2.48	3.47	-	13.40 (3.50-15.60)	3.390 (0.770-4.910)	14.89	99
15+15+22+25+42	1.69	1.45	2.13	2.42	4.06	-	13.40 (3.50-15.60)	3.380 (0.770-4.900)	14.84	99
15+15+22+25+50	1.58	1.41	2.06	2.34	4.69	-	13.40 (3.50-15.60)	3.370 (0.770-4.890)	14.80	99
15+15+22+25+60	1.47	1.31	1.93	2.19	5.26	-	13.40 (3.50-15.60)	3.370 (0.770-4.890)	14.80	99
15+15+22+25+71	1.36	1.22	1.78	2.03	5.76	-	13.40 (3.50-15.60)	3.360 (0.770-4.880)	14.76	99
15+15+22+35+35	1.65	1.44	2.11	3.36	3.36	-	13.40 (3.50-15.60)	3.390 (0.770-4.910)	14.89	99
15+15+22+35+42	1.56	1.38	2.03	3.23	3.87	-	13.40 (3.50-15.60)	3.380 (0.770-4.900)	14.84	99
15+15+22+35+50	1.47	1.31	1.93	3.07	4.38	-	13.40 (3.50-15.60)	3.370 (0.770-4.890)	14.80	99
15+15+22+35+60	1.37	1.22	1.80	2.86	4.90	-	13.40 (3.50-15.60)	3.370 (0.770-4.890)	14.80	99
15+15+22+35+71	1.27	1.15	1.68	2.68	5.44	-	13.40 (3.50-15.60)	3.360 (0.770-4.880)	14.76	99
15+15+22+42+42	1.48	1.32	1.94	3.71	3.71	-	13.40 (3.50-15.60)	3.370 (0.770-4.890)	14.80	99
15+15+22+42+50	1.40	1.25	1.83	3.50	4.17	-	13.40 (3.50-15.60)	3.360 (0.770-4.880)	14.76	99
15+15+22+42+60	1.31	1.18	1.73	3.30	4.71	-	13.40 (3.50-15.60)	3.360 (0.770-4.880)	14.76	99
15+15+22+42+71	1.22	1.10	1.61	3.08	5.21	-	13.40 (3.50-15.60)	3.350 (0.770-4.870)	14.71	99
15+15+22+50+50	1.32	1.19	1.75	3.98	3.98	-	13.40 (3.50-15.60)	3.350 (0.770-4.870)	14.71	99

MXZ-6C122VA HEATING

Indoor units combination	Heating Capacity (kW)							Outdoor unit power consumption (kW)	Current (A)	Power factor (%)
	Unit A	Unit B	Unit C	Unit D	Unit E	Unit F	Total			
15+15+22+50+60	1.24	1.12	1.64	3.73	4.48	-	13.40 (3.50-15.60)	3.400 (0.770-4.870)	14.93	99
15+15+22+50+71	1.16	1.06	1.55	3.53	5.01	-	13.40 (3.50-15.60)	3.400 (0.770-4.870)	14.93	99
15+15+22+60+60	1.17	1.06	1.56	4.26	4.26	-	13.40 (3.50-15.60)	3.400 (0.770-4.870)	14.93	99
15+15+25+25+25	1.91	1.50	2.50	2.50	2.50	-	13.40 (3.50-15.60)	3.390 (0.770-4.910)	14.89	99
15+15+25+25+35	1.75	1.47	2.46	2.46	3.44	-	13.40 (3.50-15.60)	3.390 (0.770-4.910)	14.89	99
15+15+25+25+42	1.65	1.44	2.40	2.40	4.03	-	13.40 (3.50-15.60)	3.380 (0.770-4.900)	14.84	99
15+15+25+25+50	1.55	1.37	2.29	2.29	4.58	-	13.40 (3.50-15.60)	3.370 (0.770-4.890)	14.80	99
15+15+25+25+60	1.44	1.29	2.14	2.14	5.14	-	13.40 (3.50-15.60)	3.370 (0.770-4.890)	14.80	99
15+15+25+25+71	1.33	1.20	2.00	2.00	5.69	-	13.40 (3.50-15.60)	3.360 (0.770-4.880)	14.76	99
15+15+25+35+35	1.61	1.43	2.38	3.33	3.33	-	13.40 (3.50-15.60)	3.390 (0.770-4.910)	14.89	99
15+15+25+35+42	1.52	1.35	2.25	3.16	3.79	-	13.40 (3.50-15.60)	3.380 (0.770-4.900)	14.84	99
15+15+25+35+50	1.44	1.29	2.14	3.00	4.29	-	13.40 (3.50-15.60)	3.370 (0.770-4.890)	14.80	99
15+15+25+35+60	1.34	1.21	2.02	2.82	4.84	-	13.40 (3.50-15.60)	3.360 (0.770-4.880)	14.76	99
15+15+25+35+71	1.25	1.13	1.88	2.63	5.34	-	13.40 (3.50-15.60)	3.360 (0.770-4.880)	14.76	99
15+15+25+42+42	1.45	1.29	2.16	3.63	3.63	-	13.40 (3.50-15.60)	3.370 (0.770-4.890)	14.80	99
15+15+25+42+50	1.37	1.22	2.04	3.43	4.08	-	13.40 (3.50-15.60)	3.360 (0.770-4.880)	14.76	99
15+15+25+42+60	1.28	1.16	1.93	3.24	4.62	-	13.40 (3.50-15.60)	3.360 (0.770-4.880)	14.76	99
15+15+25+42+71	1.20	1.09	1.82	3.05	5.16	-	13.40 (3.50-15.60)	3.350 (0.770-4.870)	14.71	99
15+15+25+50+50	1.30	1.17	1.95	3.90	3.90	-	13.40 (3.50-15.60)	3.350 (0.770-4.870)	14.71	99
15+15+25+50+60	1.22	1.10	1.83	3.67	4.40	-	13.40 (3.50-15.60)	3.400 (0.770-4.870)	14.93	99
15+15+25+50+71	1.14	1.04	1.73	3.47	4.92	-	13.40 (3.50-15.60)	3.400 (0.770-4.870)	14.93	99
15+15+25+60+60	1.15	1.05	1.74	4.18	4.18	-	13.40 (3.50-15.60)	3.400 (0.770-4.870)	14.93	99
15+15+35+35+35	1.49	1.33	3.11	3.11	3.11	-	13.40 (3.50-15.60)	3.390 (0.770-4.910)	14.89	99
15+15+35+35+42	1.42	1.27	2.96	2.96	3.55	-	13.40 (3.50-15.60)	3.380 (0.770-4.900)	14.84	99
15+15+35+35+50	1.34	1.21	2.82	2.82	4.03	-	13.40 (3.50-15.60)	3.370 (0.770-4.890)	14.80	99
15+15+35+35+60	1.26	1.13	2.65	2.65	4.54	-	13.40 (3.50-15.60)	3.360 (0.770-4.880)	14.76	99
15+15+35+35+71	1.18	1.07	2.50	2.50	5.07	-	13.40 (3.50-15.60)	3.360 (0.770-4.880)	14.76	99
15+15+35+42+42	1.35	1.21	2.82	3.38	3.38	-	13.40 (3.50-15.60)	3.370 (0.770-4.890)	14.80	99
15+15+35+42+50	1.28	1.16	2.70	3.24	3.85	-	13.40 (3.50-15.60)	3.360 (0.770-4.880)	14.76	99
15+15+35+42+60	1.20	1.10	2.56	3.07	4.38	-	13.40 (3.50-15.60)	3.350 (0.770-4.870)	14.71	99
15+15+35+42+71	1.13	1.03	2.40	2.88	4.87	-	13.40 (3.50-15.60)	3.350 (0.770-4.870)	14.71	99
15+15+35+50+50	1.22	1.10	2.57	3.67	3.67	-	13.40 (3.50-15.60)	3.400 (0.770-4.870)	14.93	99
15+15+35+50+60	1.15	1.05	2.44	3.49	4.18	-	13.40 (3.50-15.60)	3.400 (0.770-4.870)	14.93	99
15+15+42+42+42	1.29	1.16	3.26	3.26	3.26	-	13.40 (3.50-15.60)	3.360 (0.770-4.880)	14.76	99
15+15+42+42+50	1.23	1.11	3.10	3.10	3.69	-	13.40 (3.50-15.60)	3.350 (0.770-4.870)	14.71	99
15+15+42+42+60	1.16	1.05	2.94	2.94	4.21	-	13.40 (3.50-15.60)	3.400 (0.770-4.870)	14.93	99
15+15+42+50+50	1.17	1.06	2.98	3.55	3.55	-	13.40 (3.50-15.60)	3.400 (0.770-4.870)	14.93	99
15+15+50+50+50	1.12	1.02	3.39	3.39	3.39	-	13.40 (3.50-15.60)	3.400 (0.770-4.870)	14.93	99
15+20+20+20+20	1.66	2.00	2.00	2.00	2.00	-	10.50 (3.40-14.70)	2.730 (0.800-5.560)	11.99	99
15+20+20+20+22	1.79	2.00	2.00	2.00	2.20	-	11.60 (3.40-15.00)	2.990 (0.790-5.250)	13.13	99
15+20+20+20+25	1.79	2.00	2.00	2.00	2.50	-	11.90 (3.50-15.10)	3.017 (0.790-5.120)	13.25	99
15+20+20+20+35	1.70	2.00	2.00	2.00	3.50	-	12.50 (3.50-15.10)	3.070 (0.780-4.850)	13.48	99
15+20+20+20+42	1.71	1.95	1.95	1.95	4.09	-	13.30 (3.50-15.50)	3.300 (0.770-4.800)	14.49	99
15+20+20+20+50	1.61	1.90	1.90	1.90	4.76	-	13.40 (3.50-15.60)	3.380 (0.770-4.900)	14.84	99
15+20+20+20+60	1.49	1.78	1.78	1.78	5.33	-	13.40 (3.50-15.60)	3.380 (0.770-4.900)	14.84	99
15+20+20+20+71	1.38	1.64	1.64	1.64	5.84	-	13.40 (3.50-15.60)	3.380 (0.770-4.900)	14.84	99

MXZ-6C122VA HEATING

Indoor units combination	Heating Capacity (kW)							Outdoor unit power consumption (kW)	Current (A)	Power factor (%)
	Unit A	Unit B	Unit C	Unit D	Unit E	Unit F	Total			
15+20+20+22+22	1.98	2.00	2.00	2.20	2.20	-	13.10 (3.50-15.20)	3.130 (0.770-4.460)	13.75	99
15+20+20+22+25	1.94	2.00	2.00	2.20	2.50	-	13.20 (3.50-15.30)	3.220 (0.770-4.570)	14.14	99
15+20+20+22+35	1.77	1.98	1.98	2.18	3.47	-	13.20 (3.50-15.40)	3.220 (0.770-4.690)	14.14	99
15+20+20+22+42	1.69	1.93	1.93	2.13	4.06	-	13.40 (3.50-15.60)	3.390 (0.770-4.910)	14.89	99
15+20+20+22+50	1.58	1.87	1.87	2.06	4.69	-	13.40 (3.50-15.60)	3.380 (0.770-4.900)	14.84	99
15+20+20+22+60	1.47	1.75	1.75	1.93	5.26	-	13.40 (3.50-15.60)	3.380 (0.770-4.900)	14.84	99
15+20+20+22+71	1.36	1.62	1.62	1.78	5.76	-	13.40 (3.50-15.60)	3.370 (0.770-4.890)	14.80	99
15+20+20+25+25	1.89	2.00	2.00	2.50	2.50	-	13.20 (3.50-15.40)	3.220 (0.770-4.690)	14.14	99
15+20+20+25+35	1.73	1.97	1.97	2.46	3.44	-	13.30 (3.50-15.50)	3.300 (0.770-4.800)	14.49	99
15+20+20+25+42	1.65	1.92	1.92	2.40	4.03	-	13.40 (3.50-15.60)	3.390 (0.770-4.910)	14.89	99
15+20+20+25+50	1.55	1.83	1.83	2.29	4.58	-	13.40 (3.50-15.60)	3.380 (0.770-4.900)	14.84	99
15+20+20+25+60	1.44	1.71	1.71	2.14	5.14	-	13.40 (3.50-15.60)	3.370 (0.770-4.890)	14.80	99
15+20+20+25+71	1.33	1.60	1.60	2.00	5.69	-	13.40 (3.50-15.60)	3.370 (0.770-4.890)	14.80	99
15+20+20+35+35	1.61	1.90	1.90	3.33	3.33	-	13.40 (3.50-15.60)	3.390 (0.770-4.910)	14.89	99
15+20+20+35+42	1.52	1.80	1.80	3.16	3.79	-	13.40 (3.50-15.60)	3.380 (0.770-4.900)	14.84	99
15+20+20+35+50	1.44	1.71	1.71	3.00	4.29	-	13.40 (3.50-15.60)	3.380 (0.770-4.900)	14.84	99
15+20+20+35+60	1.34	1.61	1.61	2.82	4.84	-	13.40 (3.50-15.60)	3.370 (0.770-4.890)	14.80	99
15+20+20+35+71	1.25	1.50	1.50	2.63	5.34	-	13.40 (3.50-15.60)	3.370 (0.770-4.890)	14.80	99
15+20+20+42+42	1.45	1.73	1.73	3.63	3.63	-	13.40 (3.50-15.60)	3.380 (0.770-4.900)	14.84	99
15+20+20+42+50	1.37	1.63	1.63	3.43	4.08	-	13.40 (3.50-15.60)	3.370 (0.770-4.890)	14.80	99
15+20+20+42+60	1.28	1.54	1.54	3.24	4.62	-	13.40 (3.50-15.60)	3.360 (0.770-4.880)	14.76	99
15+20+20+42+71	1.20	1.45	1.45	3.05	5.16	-	13.40 (3.50-15.60)	3.360 (0.770-4.880)	14.76	99
15+20+20+50+50	1.30	1.56	1.56	3.90	3.90	-	13.40 (3.50-15.60)	3.350 (0.770-4.870)	14.71	99
15+20+20+50+60	1.22	1.47	1.47	3.67	4.40	-	13.40 (3.50-15.60)	3.350 (0.770-4.870)	14.71	99
15+20+20+50+71	1.14	1.39	1.39	3.47	4.92	-	13.40 (3.50-15.60)	3.400 (0.770-4.870)	14.93	99
15+20+20+60+60	1.15	1.39	1.39	4.18	4.18	-	13.40 (3.50-15.60)	3.400 (0.770-4.870)	14.93	99
15+20+22+22+22	1.98	2.00	2.20	2.20	2.20	-	13.30 (3.50-15.50)	3.300 (0.770-4.800)	14.49	99
15+20+22+22+25	1.93	2.00	2.20	2.20	2.50	-	13.40 (3.50-15.60)	3.390 (0.770-4.910)	14.89	99
15+20+22+22+35	1.76	1.96	2.16	2.16	3.44	-	13.40 (3.50-15.60)	3.390 (0.770-4.910)	14.89	99
15+20+22+22+42	1.66	1.93	2.13	2.13	4.06	-	13.40 (3.50-15.60)	3.380 (0.770-4.900)	14.84	99
15+20+22+22+50	1.56	1.84	2.03	2.03	4.61	-	13.40 (3.50-15.60)	3.370 (0.770-4.890)	14.80	99
15+20+22+22+60	1.45	1.73	1.90	1.90	5.18	-	13.40 (3.50-15.60)	3.370 (0.770-4.890)	14.80	99
15+20+22+22+71	1.34	1.61	1.77	1.77	5.73	-	13.40 (3.50-15.60)	3.360 (0.770-4.880)	14.76	99
15+20+22+25+25	1.88	2.00	2.20	2.50	2.50	-	13.40 (3.50-15.60)	3.390 (0.770-4.910)	14.89	99
15+20+22+25+35	1.72	1.95	2.14	2.44	3.41	-	13.40 (3.50-15.60)	3.390 (0.770-4.910)	14.89	99
15+20+22+25+42	1.62	1.90	2.09	2.38	4.00	-	13.40 (3.50-15.60)	3.380 (0.770-4.900)	14.84	99
15+20+22+25+50	1.52	1.80	1.98	2.25	4.51	-	13.40 (3.50-15.60)	3.370 (0.770-4.890)	14.80	99
15+20+22+25+60	1.42	1.69	1.86	2.11	5.07	-	13.40 (3.50-15.60)	3.370 (0.770-4.890)	14.80	99
15+20+22+25+71	1.31	1.58	1.74	1.98	5.62	-	13.40 (3.50-15.60)	3.360 (0.770-4.880)	14.76	99
15+20+22+35+35	1.58	1.87	2.06	3.28	3.28	-	13.40 (3.50-15.60)	3.390 (0.770-4.910)	14.89	99
15+20+22+35+42	1.50	1.79	1.97	3.13	3.76	-	13.40 (3.50-15.60)	3.380 (0.770-4.900)	14.84	99
15+20+22+35+50	1.42	1.69	1.86	2.96	4.23	-	13.40 (3.50-15.60)	3.370 (0.770-4.890)	14.80	99
15+20+22+35+60	1.32	1.59	1.75	2.79	4.78	-	13.40 (3.50-15.60)	3.360 (0.770-4.880)	14.76	99
15+20+22+35+71	1.23	1.48	1.63	2.60	5.27	-	13.40 (3.50-15.60)	3.360 (0.770-4.880)	14.76	99
15+20+22+42+42	1.43	1.70	1.87	3.57	3.57	-	13.40 (3.50-15.60)	3.370 (0.770-4.890)	14.80	99
15+20+22+42+50	1.35	1.61	1.77	3.38	4.03	-	13.40 (3.50-15.60)	3.360 (0.770-4.880)	14.76	99

MXZ-6C122VA HEATING

Indoor units combination	Heating Capacity (kW)							Outdoor unit power consumption (kW)	Current (A)	Power factor (%)
	Unit A	Unit B	Unit C	Unit D	Unit E	Unit F	Total			
15+20+22+42+60	1.26	1.52	1.67	3.20	4.57	-	13.40 (3.50-15.60)	3.350 (0.770-4.870)	14.71	99
15+20+22+42+71	1.18	1.44	1.58	3.01	5.10	-	13.40 (3.50-15.60)	3.350 (0.770-4.870)	14.71	99
15+20+22+50+50	1.28	1.54	1.70	3.85	3.85	-	13.40 (3.50-15.60)	3.400 (0.770-4.870)	14.93	99
15+20+22+50+60	1.20	1.46	1.61	3.65	4.38	-	13.40 (3.50-15.60)	3.400 (0.770-4.870)	14.93	99
15+20+22+50+71	1.13	1.37	1.51	3.43	4.87	-	13.40 (3.50-15.60)	3.400 (0.770-4.870)	14.93	99
15+20+22+60+60	1.14	1.38	1.52	4.14	4.14	-	13.40 (3.50-15.60)	3.400 (0.770-4.870)	14.93	99
15+20+25+25+25	1.83	2.00	2.50	2.50	2.50	-	13.40 (3.50-15.60)	3.390 (0.770-4.910)	14.89	99
15+20+25+25+35	1.68	1.93	2.42	2.42	3.38	-	13.40 (3.50-15.60)	3.390 (0.770-4.910)	14.89	99
15+20+25+25+42	1.58	1.87	2.34	2.34	3.94	-	13.40 (3.50-15.60)	3.380 (0.770-4.900)	14.84	99
15+20+25+25+50	1.49	1.78	2.22	2.22	4.44	-	13.40 (3.50-15.60)	3.370 (0.770-4.890)	14.80	99
15+20+25+25+60	1.39	1.66	2.07	2.07	4.97	-	13.40 (3.50-15.60)	3.360 (0.770-4.880)	14.76	99
15+20+25+25+71	1.29	1.55	1.94	1.94	5.51	-	13.40 (3.50-15.60)	3.360 (0.770-4.880)	14.76	99
15+20+25+35+35	1.55	1.83	2.29	3.20	3.20	-	13.40 (3.50-15.60)	3.380 (0.770-4.900)	14.84	99
15+20+25+35+42	1.47	1.75	2.19	3.07	3.68	-	13.40 (3.50-15.60)	3.380 (0.770-4.900)	14.84	99
15+20+25+35+50	1.39	1.66	2.07	2.90	4.14	-	13.40 (3.50-15.60)	3.370 (0.770-4.890)	14.80	99
15+20+25+35+60	1.30	1.56	1.95	2.73	4.68	-	13.40 (3.50-15.60)	3.360 (0.770-4.880)	14.76	99
15+20+25+35+71	1.21	1.46	1.82	2.55	5.18	-	13.40 (3.50-15.60)	3.360 (0.770-4.880)	14.76	99
15+20+25+42+42	1.40	1.67	2.08	3.50	3.50	-	13.40 (3.50-15.60)	3.370 (0.770-4.890)	14.80	99
15+20+25+42+50	1.32	1.59	1.99	3.34	3.98	-	13.40 (3.50-15.60)	3.360 (0.770-4.880)	14.76	99
15+20+25+42+60	1.24	1.49	1.87	3.14	4.48	-	13.40 (3.50-15.60)	3.350 (0.770-4.870)	14.71	99
15+20+25+42+71	1.16	1.41	1.76	2.96	5.01	-	13.40 (3.50-15.60)	3.350 (0.770-4.870)	14.71	99
15+20+25+50+50	1.26	1.51	1.89	3.78	3.78	-	13.40 (3.50-15.60)	3.400 (0.770-4.870)	14.93	99
15+20+25+50+60	1.18	1.44	1.79	3.59	4.31	-	13.40 (3.50-15.60)	3.400 (0.770-4.870)	14.93	99
15+20+25+50+60	1.12	1.36	1.69	4.07	4.07	-	13.40 (3.50-15.60)	3.400 (0.770-4.870)	14.93	99
15+20+35+35+35	1.44	1.71	3.00	3.00	3.00	-	13.40 (3.50-15.60)	3.380 (0.770-4.900)	14.84	99
15+20+35+35+42	1.37	1.63	2.86	2.86	3.43	-	13.40 (3.50-15.60)	3.380 (0.770-4.900)	14.84	99
15+20+35+35+50	1.30	1.56	2.73	2.73	3.90	-	13.40 (3.50-15.60)	3.360 (0.770-4.880)	14.76	99
15+20+35+35+60	1.22	1.47	2.57	2.57	4.40	-	13.40 (3.50-15.60)	3.360 (0.770-4.880)	14.76	99
15+20+35+35+71	1.14	1.39	2.43	2.43	4.92	-	13.40 (3.50-15.60)	3.350 (0.770-4.870)	14.71	99
15+20+35+42+42	1.31	1.57	2.75	3.30	3.30	-	13.40 (3.50-15.60)	3.370 (0.770-4.890)	14.80	99
15+20+35+42+50	1.24	1.49	2.61	3.14	3.73	-	13.40 (3.50-15.60)	3.350 (0.770-4.870)	14.71	99
15+20+35+42+60	1.17	1.42	2.48	2.98	4.26	-	13.40 (3.50-15.60)	3.350 (0.770-4.870)	14.71	99
15+20+35+50+50	1.18	1.44	2.51	3.59	3.59	-	13.40 (3.50-15.60)	3.400 (0.770-4.870)	14.93	99
15+20+35+50+60	1.12	1.36	2.37	3.39	4.07	-	13.40 (3.50-15.60)	3.400 (0.770-4.870)	14.93	99
15+20+42+42+42	1.25	1.50	3.16	3.16	3.16	-	13.40 (3.50-15.60)	3.360 (0.770-4.880)	14.76	99
15+20+42+42+50	1.19	1.44	3.03	3.03	3.61	-	13.40 (3.50-15.60)	3.400 (0.770-4.870)	14.93	99
15+20+42+42+60	1.12	1.36	2.86	2.86	4.09	-	13.40 (3.50-15.60)	3.400 (0.770-4.870)	14.93	99
15+20+42+50+50	1.14	1.38	2.89	3.45	3.45	-	13.40 (3.50-15.60)	3.400 (0.770-4.870)	14.93	99
15+22+22+22+22	1.95	2.20	2.20	2.20	2.20	-	13.40 (3.50-15.60)	3.390 (0.770-4.910)	14.89	99
15+22+22+22+25	1.90	2.20	2.20	2.20	2.50	-	13.40 (3.50-15.60)	3.390 (0.770-4.910)	14.89	99
15+22+22+22+35	1.73	2.16	2.16	2.16	3.44	-	13.40 (3.50-15.60)	3.380 (0.770-4.900)	14.84	99
15+22+22+22+42	1.63	2.11	2.11	2.11	4.03	-	13.40 (3.50-15.60)	3.380 (0.770-4.900)	14.84	99
15+22+22+22+50	1.53	2.00	2.00	2.00	4.54	-	13.40 (3.50-15.60)	3.360 (0.770-4.880)	14.76	99
15+22+22+22+60	1.43	1.87	1.87	1.87	5.11	-	13.40 (3.50-15.60)	3.360 (0.770-4.880)	14.76	99
15+22+22+22+71	1.32	1.75	1.75	1.75	5.65	-	13.40 (3.50-15.60)	3.360 (0.770-4.880)	14.76	99
15+22+22+25+25	1.84	2.20	2.20	2.50	2.50	-	13.40 (3.50-15.60)	3.380 (0.770-4.900)	14.84	99

MXZ-6C122VA HEATING

Indoor units combination	Heating Capacity (kW)							Outdoor unit power consumption (kW)	Current (A)	Power factor (%)
	Unit A	Unit B	Unit C	Unit D	Unit E	Unit F	Total			
15+22+22+25+35	1.69	2.13	2.13	2.42	3.38	-	13.40 (3.50-15.60)	3.380 (0.770-4.900)	14.84	99
15+22+22+25+42	1.60	2.08	2.08	2.36	3.97	-	13.40 (3.50-15.60)	3.380 (0.770-4.900)	14.84	99
15+22+22+25+50	1.50	1.97	1.97	2.24	4.48	-	13.40 (3.50-15.60)	3.360 (0.770-4.880)	14.76	99
15+22+22+25+60	1.40	1.83	1.83	2.08	5.00	-	13.40 (3.50-15.60)	3.360 (0.770-4.880)	14.76	99
15+22+22+25+71	1.30	1.72	1.72	1.95	5.54	-	13.40 (3.50-15.60)	3.350 (0.770-4.870)	14.71	99
15+22+22+35+35	1.56	2.03	2.03	3.23	3.23	-	13.40 (3.50-15.60)	3.380 (0.770-4.900)	14.84	99
15+22+22+35+42	1.48	1.94	1.94	3.09	3.71	-	13.40 (3.50-15.60)	3.370 (0.770-4.890)	14.80	99
15+22+22+35+50	1.40	1.83	1.83	2.92	4.17	-	13.40 (3.50-15.60)	3.360 (0.770-4.880)	14.76	99
15+22+22+35+60	1.31	1.73	1.73	2.75	4.71	-	13.40 (3.50-15.60)	3.360 (0.770-4.880)	14.76	99
15+22+22+35+71	1.22	1.61	1.61	2.57	5.21	-	13.40 (3.50-15.60)	3.350 (0.770-4.870)	14.71	99
15+22+22+42+42	1.41	1.85	1.85	3.52	3.52	-	13.40 (3.50-15.60)	3.360 (0.770-4.880)	14.76	99
15+22+22+42+50	1.33	1.76	1.76	3.37	4.01	-	13.40 (3.50-15.60)	3.350 (0.770-4.870)	14.71	99
15+22+22+42+60	1.25	1.65	1.65	3.16	4.51	-	13.40 (3.50-15.60)	3.400 (0.770-4.870)	14.93	99
15+22+22+42+71	1.17	1.56	1.56	2.98	5.04	-	13.40 (3.50-15.60)	3.400 (0.770-4.870)	14.93	99
15+22+22+50+50	1.26	1.67	1.67	3.81	3.81	-	13.40 (3.50-15.60)	3.400 (0.770-4.870)	14.93	99
15+22+22+50+60	1.19	1.59	1.59	3.61	4.33	-	13.40 (3.50-15.60)	3.400 (0.770-4.870)	14.93	99
15+22+22+50+71	1.12	1.49	1.49	3.39	4.81	-	13.40 (3.50-15.60)	3.400 (0.770-4.870)	14.93	99
15+22+22+60+60	1.12	1.50	1.50	4.09	4.09	-	13.40 (3.50-15.60)	3.400 (0.770-4.870)	14.93	99
15+22+25+25+25	1.79	2.18	2.48	2.48	2.48	-	13.40 (3.50-15.60)	3.380 (0.770-4.900)	14.84	99
15+22+25+25+35	1.65	2.11	2.40	2.40	3.36	-	13.40 (3.50-15.60)	3.380 (0.770-4.900)	14.84	99
15+22+25+25+42	1.56	2.03	2.31	2.31	3.87	-	13.40 (3.50-15.60)	3.370 (0.770-4.890)	14.80	99
15+22+25+25+50	1.47	1.93	2.19	2.19	4.38	-	13.40 (3.50-15.60)	3.360 (0.770-4.880)	14.76	99
15+22+25+25+60	1.37	1.80	2.04	2.04	4.90	-	13.40 (3.50-15.60)	3.360 (0.770-4.880)	14.76	99
15+22+25+25+71	1.27	1.68	1.91	1.91	5.44	-	13.40 (3.50-15.60)	3.350 (0.770-4.870)	14.71	99
15+22+25+35+35	1.52	1.98	2.25	3.16	3.16	-	13.40 (3.50-15.60)	3.380 (0.770-4.900)	14.84	99
15+22+25+35+42	1.45	1.90	2.16	3.02	3.63	-	13.40 (3.50-15.60)	3.370 (0.770-4.890)	14.80	99
15+22+25+35+50	1.37	1.80	2.04	2.86	4.08	-	13.40 (3.50-15.60)	3.360 (0.770-4.880)	14.76	99
15+22+25+35+60	1.28	1.70	1.93	2.70	4.62	-	13.40 (3.50-15.60)	3.350 (0.770-4.870)	14.71	99
15+22+25+35+71	1.20	1.60	1.82	2.54	5.16	-	13.40 (3.50-15.60)	3.350 (0.770-4.870)	14.71	99
15+22+25+42+42	1.38	1.81	2.05	3.45	3.45	-	13.40 (3.50-15.60)	3.360 (0.770-4.880)	14.76	99
15+22+25+42+50	1.31	1.73	1.96	3.30	3.93	-	13.40 (3.50-15.60)	3.350 (0.770-4.870)	14.71	99
15+22+25+42+60	1.23	1.62	1.84	3.10	4.43	-	13.40 (3.50-15.60)	3.400 (0.770-4.870)	14.93	99
15+22+25+42+71	1.15	1.53	1.74	2.93	4.95	-	13.40 (3.50-15.60)	3.400 (0.770-4.870)	14.93	99
15+22+25+50+50	1.24	1.64	1.87	3.73	3.73	-	13.40 (3.50-15.60)	3.400 (0.770-4.870)	14.93	99
15+22+25+50+60	1.17	1.56	1.77	3.55	4.26	-	13.40 (3.50-15.60)	3.400 (0.770-4.870)	14.93	99
15+22+35+35+35	1.42	1.86	2.96	2.96	2.96	-	13.40 (3.50-15.60)	3.380 (0.770-4.900)	14.84	99
15+22+35+35+42	1.35	1.77	2.82	2.82	3.38	-	13.40 (3.50-15.60)	3.370 (0.770-4.890)	14.80	99
15+22+35+35+50	1.28	1.70	2.70	2.70	3.85	-	13.40 (3.50-15.60)	3.360 (0.770-4.880)	14.76	99
15+22+35+35+60	1.20	1.61	2.56	2.56	4.38	-	13.40 (3.50-15.60)	3.350 (0.770-4.870)	14.71	99
15+22+35+35+71	1.13	1.51	2.40	2.40	4.87	-	13.40 (3.50-15.60)	3.400 (0.770-4.870)	14.93	99
15+22+35+42+42	1.29	1.71	2.71	3.26	3.26	-	13.40 (3.50-15.60)	3.360 (0.770-4.880)	14.76	99
15+22+35+42+50	1.23	1.62	2.58	3.10	3.69	-	13.40 (3.50-15.60)	3.400 (0.770-4.870)	14.93	99
15+22+35+42+60	1.16	1.54	2.45	2.94	4.21	-	13.40 (3.50-15.60)	3.400 (0.770-4.870)	14.93	99
15+22+35+50+50	1.17	1.56	2.48	3.55	3.55	-	13.40 (3.50-15.60)	3.400 (0.770-4.870)	14.93	99
15+22+42+42+42	1.23	1.63	3.12	3.12	3.12	-	13.40 (3.50-15.60)	3.350 (0.770-4.870)	14.71	99
15+22+42+42+50	1.18	1.57	3.00	3.00	3.57	-	13.40 (3.50-15.60)	3.400 (0.770-4.870)	14.93	99

MXZ-6C122VA HEATING

Indoor units combination	Heating Capacity (kW)							Outdoor unit power consumption (kW)	Current (A)	Power factor (%)
	Unit A	Unit B	Unit C	Unit D	Unit E	Unit F	Total			
15+22+42+50+50	1.12	1.50	2.86	3.41	3.41	-	13.40 (3.50-15.60)	3.400 (0.770-4.870)	14.93	99
15+25+25+25+25	1.75	2.46	2.46	2.46	2.46	-	13.40 (3.50-15.60)	3.380 (0.770-4.900)	14.84	99
15+25+25+25+35	1.61	2.38	2.38	2.38	3.33	-	13.40 (3.50-15.60)	3.380 (0.770-4.900)	14.84	99
15+25+25+25+42	1.52	2.25	2.25	2.25	3.79	-	13.40 (3.50-15.60)	3.370 (0.770-4.890)	14.80	99
15+25+25+25+50	1.44	2.14	2.14	2.14	4.29	-	13.40 (3.50-15.60)	3.360 (0.770-4.880)	14.76	99
15+25+25+25+60	1.34	2.02	2.02	2.02	4.84	-	13.40 (3.50-15.60)	3.350 (0.770-4.870)	14.71	99
15+25+25+25+71	1.25	1.88	1.88	1.88	5.34	-	13.40 (3.50-15.60)	3.350 (0.770-4.870)	14.71	99
15+25+25+35+35	1.49	2.22	2.22	3.11	3.11	-	13.40 (3.50-15.60)	3.380 (0.770-4.900)	14.84	99
15+25+25+35+42	1.42	2.11	2.11	2.96	3.55	-	13.40 (3.50-15.60)	3.370 (0.770-4.890)	14.80	99
15+25+25+35+50	1.34	2.02	2.02	2.82	4.03	-	13.40 (3.50-15.60)	3.360 (0.770-4.880)	14.76	99
15+25+25+35+60	1.26	1.89	1.89	2.65	4.54	-	13.40 (3.50-15.60)	3.350 (0.770-4.870)	14.71	99
15+25+25+35+71	1.18	1.78	1.78	2.50	5.07	-	13.40 (3.50-15.60)	3.350 (0.770-4.870)	14.71	99
15+25+25+42+42	1.35	2.01	2.01	3.38	3.38	-	13.40 (3.50-15.60)	3.360 (0.770-4.880)	14.76	99
15+25+25+42+50	1.28	1.93	1.93	3.24	3.85	-	13.40 (3.50-15.60)	3.350 (0.770-4.870)	14.71	99
15+25+25+42+60	1.20	1.83	1.83	3.07	4.38	-	13.40 (3.50-15.60)	3.400 (0.770-4.870)	14.93	99
15+25+25+42+71	1.13	1.71	1.71	2.88	4.87	-	13.40 (3.50-15.60)	3.400 (0.770-4.870)	14.93	99
15+25+25+50+50	1.22	1.83	1.83	3.67	3.67	-	13.40 (3.50-15.60)	3.400 (0.770-4.870)	14.93	99
15+25+25+50+60	1.15	1.74	1.74	3.49	4.18	-	13.40 (3.50-15.60)	3.400 (0.770-4.870)	14.93	99
15+25+35+35+35	1.39	2.07	2.90	2.90	2.90	-	13.40 (3.50-15.60)	3.380 (0.770-4.900)	14.84	99
15+25+35+35+42	1.32	1.99	2.79	2.79	3.34	-	13.40 (3.50-15.60)	3.370 (0.770-4.890)	14.80	99
15+25+35+35+50	1.26	1.89	2.65	2.65	3.78	-	13.40 (3.50-15.60)	3.350 (0.770-4.870)	14.71	99
15+25+35+35+60	1.18	1.79	2.51	2.51	4.31	-	13.40 (3.50-15.60)	3.350 (0.770-4.870)	14.71	99
15+25+35+42+42	1.26	1.90	2.66	3.20	3.20	-	13.40 (3.50-15.60)	3.360 (0.770-4.880)	14.76	99
15+25+35+42+50	1.20	1.83	2.56	3.07	3.65	-	13.40 (3.50-15.60)	3.400 (0.770-4.870)	14.93	99
15+25+35+42+60	1.14	1.72	2.41	2.89	4.14	-	13.40 (3.50-15.60)	3.400 (0.770-4.870)	14.93	99
15+25+35+50+50	1.15	1.74	2.44	3.49	3.49	-	13.40 (3.50-15.60)	3.400 (0.770-4.870)	14.93	99
15+25+42+42+42	1.21	1.82	3.06	3.06	3.06	-	13.40 (3.50-15.60)	3.350 (0.770-4.870)	14.71	99
15+25+42+42+50	1.16	1.75	2.94	2.94	3.51	-	13.40 (3.50-15.60)	3.400 (0.770-4.870)	14.93	99
15+35+35+35+35	1.30	2.73	2.73	2.73	2.73	-	13.40 (3.50-15.60)	3.370 (0.770-4.890)	14.80	99
15+35+35+35+42	1.24	2.61	2.61	2.61	3.14	-	13.40 (3.50-15.60)	3.360 (0.770-4.880)	14.76	99
15+35+35+35+50	1.18	2.51	2.51	2.51	3.59	-	13.40 (3.50-15.60)	3.350 (0.770-4.870)	14.71	99
15+35+35+35+60	1.12	2.37	2.37	2.37	4.07	-	13.40 (3.50-15.60)	3.400 (0.770-4.870)	14.93	99
15+35+35+42+42	1.19	2.53	2.53	3.03	3.03	-	13.40 (3.50-15.60)	3.350 (0.770-4.870)	14.71	99
15+35+35+42+50	1.14	2.41	2.41	2.89	3.45	-	13.40 (3.50-15.60)	3.400 (0.770-4.870)	14.93	99
15+35+42+42+42	1.14	2.43	2.91	2.91	2.91	-	13.40 (3.50-15.60)	3.400 (0.770-4.870)	14.93	99
20+20+20+20+20	2.20	2.00	2.00	2.00	2.00	-	11.00 (3.40-14.90)	2.930 (0.800-5.640)	12.87	99
20+20+20+20+22	2.37	2.00	2.00	2.00	2.20	-	12.10 (3.50-15.10)	3.030 (0.790-4.850)	13.31	99
20+20+20+20+25	2.42	2.00	2.00	2.00	2.50	-	12.70 (3.50-15.10)	3.090 (0.780-4.850)	13.57	99
20+20+20+20+35	2.28	1.97	1.97	1.97	3.44	-	13.10 (3.50-15.20)	3.130 (0.770-4.460)	13.75	99
20+20+20+20+42	2.20	1.92	1.92	1.92	4.03	-	13.40 (3.50-15.60)	3.390 (0.770-4.910)	14.89	99
20+20+20+20+50	2.06	1.83	1.83	1.83	4.58	-	13.40 (3.50-15.60)	3.380 (0.770-4.900)	14.84	99
20+20+20+20+60	1.91	1.71	1.71	1.71	5.14	-	13.40 (3.50-15.60)	3.380 (0.770-4.900)	14.84	99
20+20+20+20+71	1.77	1.60	1.60	1.60	5.69	-	13.40 (3.50-15.60)	3.370 (0.770-4.890)	14.80	99
20+20+20+22+22	2.54	2.00	2.00	2.20	2.20	-	13.20 (3.50-15.30)	3.220 (0.770-4.570)	14.14	99
20+20+20+22+25	2.49	2.00	2.00	2.20	2.50	-	13.30 (3.50-15.40)	3.300 (0.770-4.690)	14.49	99
20+20+20+22+35	2.29	1.95	1.95	2.14	3.41	-	13.40 (3.50-15.50)	3.390 (0.770-4.800)	14.89	99

MXZ-6C122VA HEATING

Indoor units combination	Heating Capacity (kW)							Outdoor unit power consumption (kW)	Current (A)	Power factor (%)
	Unit A	Unit B	Unit C	Unit D	Unit E	Unit F	Total			
20+20+20+22+42	2.16	1.90	1.90	2.09	4.00	-	13.40 (3.50-15.60)	3.390 (0.770-4.910)	14.89	99
20+20+20+22+50	2.03	1.80	1.80	1.98	4.51	-	13.40 (3.50-15.60)	3.380 (0.770-4.900)	14.84	99
20+20+20+22+60	1.89	1.69	1.69	1.86	5.07	-	13.40 (3.50-15.60)	3.370 (0.770-4.890)	14.80	99
20+20+20+22+71	1.75	1.58	1.58	1.74	5.62	-	13.40 (3.50-15.60)	3.370 (0.770-4.890)	14.80	99
20+20+20+25+25	2.42	2.00	2.00	2.50	2.50	-	13.30 (3.50-15.50)	3.300 (0.770-4.800)	14.49	99
20+20+20+25+35	2.23	1.93	1.93	2.42	3.38	-	13.40 (3.50-15.60)	3.390 (0.770-4.910)	14.89	99
20+20+20+25+42	2.11	1.87	1.87	2.34	3.94	-	13.40 (3.50-15.60)	3.380 (0.770-4.900)	14.84	99
20+20+20+25+50	1.99	1.78	1.78	2.22	4.44	-	13.40 (3.50-15.60)	3.370 (0.770-4.890)	14.80	99
20+20+20+25+60	1.85	1.66	1.66	2.07	4.97	-	13.40 (3.50-15.60)	3.370 (0.770-4.890)	14.80	99
20+20+20+25+71	1.72	1.55	1.55	1.94	5.51	-	13.40 (3.50-15.60)	3.360 (0.770-4.880)	14.76	99
20+20+20+35+35	2.06	1.83	1.83	3.20	3.20	-	13.40 (3.50-15.60)	3.390 (0.770-4.910)	14.89	99
20+20+20+35+42	1.96	1.75	1.75	3.07	3.68	-	13.40 (3.50-15.60)	3.380 (0.770-4.900)	14.84	99
20+20+20+35+50	1.85	1.66	1.66	2.90	4.14	-	13.40 (3.50-15.60)	3.370 (0.770-4.890)	14.80	99
20+20+20+35+60	1.73	1.56	1.56	2.73	4.68	-	13.40 (3.50-15.60)	3.370 (0.770-4.890)	14.80	99
20+20+20+35+71	1.61	1.46	1.46	2.55	5.18	-	13.40 (3.50-15.60)	3.360 (0.770-4.880)	14.76	99
20+20+20+42+42	1.86	1.67	1.67	3.50	3.50	-	13.40 (3.50-15.60)	3.370 (0.770-4.890)	14.80	99
20+20+20+42+50	1.76	1.59	1.59	3.34	3.98	-	13.40 (3.50-15.60)	3.360 (0.770-4.880)	14.76	99
20+20+20+42+60	1.65	1.49	1.49	3.14	4.48	-	13.40 (3.50-15.60)	3.360 (0.770-4.880)	14.76	99
20+20+20+42+71	1.55	1.41	1.41	2.96	5.01	-	13.40 (3.50-15.60)	3.350 (0.770-4.870)	14.71	99
20+20+20+50+50	1.68	1.51	1.51	3.78	3.78	-	13.40 (3.50-15.60)	3.350 (0.770-4.870)	14.71	99
20+20+20+50+60	1.58	1.44	1.44	3.59	4.31	-	13.40 (3.50-15.60)	3.400 (0.770-4.870)	14.93	99
20+20+20+60+60	1.49	1.36	1.36	4.07	4.07	-	13.40 (3.50-15.60)	3.400 (0.770-4.870)	14.93	99
20+20+22+22+22	2.53	2.00	2.20	2.20	2.20	-	13.40 (3.50-15.60)	3.390 (0.770-4.910)	14.89	99
20+20+22+22+25	2.46	2.00	2.20	2.20	2.50	-	13.40 (3.50-15.60)	3.390 (0.770-4.910)	14.89	99
20+20+22+22+35	2.25	1.93	2.13	2.13	3.38	-	13.40 (3.50-15.60)	3.390 (0.770-4.910)	14.89	99
20+20+22+22+42	2.13	1.89	2.08	2.08	3.97	-	13.40 (3.50-15.60)	3.380 (0.770-4.900)	14.84	99
20+20+22+22+50	2.00	1.79	1.97	1.97	4.48	-	13.40 (3.50-15.60)	3.370 (0.770-4.890)	14.80	99
20+20+22+22+60	1.86	1.67	1.83	1.83	5.00	-	13.40 (3.50-15.60)	3.360 (0.770-4.880)	14.76	99
20+20+22+22+71	1.73	1.56	1.72	1.72	5.54	-	13.40 (3.50-15.60)	3.360 (0.770-4.880)	14.76	99
20+20+22+25+25	2.39	1.98	2.18	2.48	2.48	-	13.40 (3.50-15.60)	3.390 (0.770-4.910)	14.89	99
20+20+22+25+35	2.20	1.92	2.11	2.40	3.36	-	13.40 (3.50-15.60)	3.390 (0.770-4.910)	14.89	99
20+20+22+25+42	2.08	1.84	2.03	2.31	3.87	-	13.40 (3.50-15.60)	3.380 (0.770-4.900)	14.84	99
20+20+22+25+50	1.96	1.75	1.93	2.19	4.38	-	13.40 (3.50-15.60)	3.370 (0.770-4.890)	14.80	99
20+20+22+25+60	1.82	1.63	1.80	2.04	4.90	-	13.40 (3.50-15.60)	3.360 (0.770-4.880)	14.76	99
20+20+22+25+71	1.70	1.53	1.68	1.91	5.44	-	13.40 (3.50-15.60)	3.360 (0.770-4.880)	14.76	99
20+20+22+35+35	2.03	1.80	1.98	3.16	3.16	-	13.40 (3.50-15.60)	3.380 (0.770-4.900)	14.84	99
20+20+22+35+42	1.93	1.73	1.90	3.02	3.63	-	13.40 (3.50-15.60)	3.380 (0.770-4.900)	14.84	99
20+20+22+35+50	1.82	1.63	1.80	2.86	4.08	-	13.40 (3.50-15.60)	3.360 (0.770-4.880)	14.76	99
20+20+22+35+60	1.71	1.54	1.70	2.70	4.62	-	13.40 (3.50-15.60)	3.360 (0.770-4.880)	14.76	99
20+20+22+35+71	1.60	1.45	1.60	2.54	5.16	-	13.40 (3.50-15.60)	3.360 (0.770-4.880)	14.76	99
20+20+22+42+42	1.84	1.64	1.81	3.45	3.45	-	13.40 (3.50-15.60)	3.370 (0.770-4.890)	14.80	99
20+20+22+42+50	1.74	1.57	1.73	3.30	3.93	-	13.40 (3.50-15.60)	3.360 (0.770-4.880)	14.76	99
20+20+22+42+60	1.63	1.48	1.62	3.10	4.43	-	13.40 (3.50-15.60)	3.350 (0.770-4.870)	14.71	99
20+20+22+42+71	1.53	1.39	1.53	2.93	4.95	-	13.40 (3.50-15.60)	3.400 (0.770-4.870)	14.93	99
20+20+22+50+50	1.65	1.49	1.64	3.73	3.73	-	13.40 (3.50-15.60)	3.400 (0.770-4.870)	14.93	99
20+20+22+50+60	1.56	1.42	1.56	3.55	4.26	-	13.40 (3.50-15.60)	3.400 (0.770-4.870)	14.93	99

MXZ-6C122VA HEATING

Indoor units combination	Heating Capacity (kW)							Outdoor unit power consumption (kW)	Current (A)	Power factor (%)
	Unit A	Unit B	Unit C	Unit D	Unit E	Unit F	Total			
20+20+25+25+25	2.33	1.97	2.46	2.46	2.46	-	13.40 (3.50-15.60)	3.390 (0.770-4.910)	14.89	99
20+20+25+25+35	2.14	1.90	2.38	2.38	3.33	-	13.40 (3.50-15.60)	3.380 (0.770-4.900)	14.84	99
20+20+25+25+42	2.03	1.80	2.25	2.25	3.79	-	13.40 (3.50-15.60)	3.380 (0.770-4.900)	14.84	99
20+20+25+25+50	1.91	1.71	2.14	2.14	4.29	-	13.40 (3.50-15.60)	3.360 (0.770-4.880)	14.76	99
20+20+25+25+60	1.79	1.61	2.02	2.02	4.84	-	13.40 (3.50-15.60)	3.360 (0.770-4.880)	14.76	99
20+20+25+25+71	1.66	1.50	1.88	1.88	5.34	-	13.40 (3.50-15.60)	3.360 (0.770-4.880)	14.76	99
20+20+25+35+35	1.99	1.78	2.22	3.11	3.11	-	13.40 (3.50-15.60)	3.380 (0.770-4.900)	14.84	99
20+20+25+35+42	1.89	1.69	2.11	2.96	3.55	-	13.40 (3.50-15.60)	3.370 (0.770-4.890)	14.80	99
20+20+25+35+50	1.79	1.61	2.02	2.82	4.03	-	13.40 (3.50-15.60)	3.360 (0.770-4.880)	14.76	99
20+20+25+35+60	1.68	1.51	1.89	2.65	4.54	-	13.40 (3.50-15.60)	3.360 (0.770-4.880)	14.76	99
20+20+25+35+71	1.57	1.43	1.78	2.50	5.07	-	13.40 (3.50-15.60)	3.350 (0.770-4.870)	14.71	99
20+20+25+42+42	1.80	1.61	2.01	3.38	3.38	-	13.40 (3.50-15.60)	3.360 (0.770-4.880)	14.76	99
20+20+25+42+50	1.71	1.54	1.93	3.24	3.85	-	13.40 (3.50-15.60)	3.350 (0.770-4.870)	14.71	99
20+20+25+42+60	1.60	1.46	1.83	3.07	4.38	-	13.40 (3.50-15.60)	3.350 (0.770-4.870)	14.71	99
20+20+25+42+71	1.51	1.37	1.71	2.88	4.87	-	13.40 (3.50-15.60)	3.400 (0.770-4.870)	14.93	99
20+20+25+50+50	1.62	1.47	1.83	3.67	3.67	-	13.40 (3.50-15.60)	3.400 (0.770-4.870)	14.93	99
20+20+25+50+60	1.53	1.39	1.74	3.49	4.18	-	13.40 (3.50-15.60)	3.400 (0.770-4.870)	14.93	99
20+20+35+35+35	1.85	1.66	2.90	2.90	2.90	-	13.40 (3.50-15.60)	3.380 (0.770-4.900)	14.84	99
20+20+35+35+42	1.76	1.59	2.79	2.79	3.34	-	13.40 (3.50-15.60)	3.370 (0.770-4.890)	14.80	99
20+20+35+35+50	1.68	1.51	2.65	2.65	3.78	-	13.40 (3.50-15.60)	3.360 (0.770-4.880)	14.76	99
20+20+35+35+60	1.58	1.44	2.51	2.51	4.31	-	13.40 (3.50-15.60)	3.360 (0.770-4.880)	14.76	99
20+20+35+42+42	1.69	1.52	2.66	3.20	3.20	-	13.40 (3.50-15.60)	3.360 (0.770-4.880)	14.76	99
20+20+35+42+50	1.60	1.46	2.56	3.07	3.65	-	13.40 (3.50-15.60)	3.350 (0.770-4.870)	14.71	99
20+20+35+42+60	1.51	1.38	2.41	2.89	4.14	-	13.40 (3.50-15.60)	3.400 (0.770-4.870)	14.93	99
20+20+35+50+50	1.53	1.39	2.44	3.49	3.49	-	13.40 (3.50-15.60)	3.400 (0.770-4.870)	14.93	99
20+20+42+42+42	1.61	1.46	3.06	3.06	3.06	-	13.40 (3.50-15.60)	3.350 (0.770-4.870)	14.71	99
20+20+42+42+50	1.54	1.40	2.94	2.94	3.51	-	13.40 (3.50-15.60)	3.400 (0.770-4.870)	14.93	99
20+22+22+22+22	2.48	2.20	2.20	2.20	2.20	-	13.40 (3.50-15.60)	3.380 (0.770-4.900)	14.84	99
20+22+22+22+25	2.41	2.20	2.20	2.20	2.50	-	13.40 (3.50-15.60)	3.380 (0.770-4.900)	14.84	99
20+22+22+22+35	2.21	2.13	2.13	2.13	3.38	-	13.40 (3.50-15.60)	3.380 (0.770-4.900)	14.84	99
20+22+22+22+42	2.09	2.05	2.05	2.05	3.90	-	13.40 (3.50-15.60)	3.370 (0.770-4.890)	14.80	99
20+22+22+22+50	1.97	1.94	1.94	1.94	4.41	-	13.40 (3.50-15.60)	3.360 (0.770-4.880)	14.76	99
20+22+22+22+60	1.84	1.81	1.81	1.81	4.93	-	13.40 (3.50-15.60)	3.360 (0.770-4.880)	14.76	99
20+22+22+22+71	1.71	1.70	1.70	1.70	5.47	-	13.40 (3.50-15.60)	3.350 (0.770-4.870)	14.71	99
20+22+22+25+25	2.35	2.16	2.16	2.46	2.46	-	13.40 (3.50-15.60)	3.380 (0.770-4.900)	14.84	99
20+22+22+25+35	2.16	2.09	2.09	2.38	3.33	-	13.40 (3.50-15.60)	3.380 (0.770-4.900)	14.84	99
20+22+22+25+42	2.05	2.00	2.00	2.27	3.82	-	13.40 (3.50-15.60)	3.370 (0.770-4.890)	14.80	99
20+22+22+25+50	1.93	1.90	1.90	2.16	4.32	-	13.40 (3.50-15.60)	3.360 (0.770-4.880)	14.76	99
20+22+22+25+60	1.80	1.77	1.77	2.01	4.83	-	13.40 (3.50-15.60)	3.360 (0.770-4.880)	14.76	99
20+22+22+25+71	1.68	1.66	1.66	1.89	5.37	-	13.40 (3.50-15.60)	3.350 (0.770-4.870)	14.71	99
20+22+22+35+35	2.00	1.97	1.97	3.13	3.13	-	13.40 (3.50-15.60)	3.380 (0.770-4.900)	14.84	99
20+22+22+35+42	1.90	1.87	1.87	2.98	3.57	-	13.40 (3.50-15.60)	3.370 (0.770-4.890)	14.80	99
20+22+22+35+50	1.80	1.77	1.77	2.82	4.03	-	13.40 (3.50-15.60)	3.360 (0.770-4.880)	14.76	99
20+22+22+35+60	1.69	1.67	1.67	2.66	4.57	-	13.40 (3.50-15.60)	3.350 (0.770-4.870)	14.71	99
20+22+22+35+71	1.58	1.58	1.58	2.51	5.10	-	13.40 (3.50-15.60)	3.350 (0.770-4.870)	14.71	99
20+22+22+42+42	1.81	1.78	1.78	3.41	3.41	-	13.40 (3.50-15.60)	3.360 (0.770-4.880)	14.76	99

MXZ-6C122VA HEATING

Indoor units combination	Heating Capacity (kW)							Outdoor unit power consumption (kW)	Current (A)	Power factor (%)
	Unit A	Unit B	Unit C	Unit D	Unit E	Unit F	Total			
20+22+22+42+50	1.72	1.71	1.71	3.26	3.88	-	13.40 (3.50-15.60)	3.350 (0.770-4.870)	14.71	99
20+22+22+42+60	1.61	1.60	1.60	3.06	4.37	-	13.40 (3.50-15.60)	3.400 (0.770-4.870)	14.93	99
20+22+22+42+71	1.51	1.52	1.52	2.89	4.89	-	13.40 (3.50-15.60)	3.400 (0.770-4.870)	14.93	99
20+22+22+50+50	1.63	1.62	1.62	3.69	3.69	-	13.40 (3.50-15.60)	3.400 (0.770-4.870)	14.93	99
20+22+22+50+60	1.54	1.54	1.54	3.51	4.21	-	13.40 (3.50-15.60)	3.400 (0.770-4.870)	14.93	99
20+22+25+25+25	2.29	2.14	2.44	2.44	2.44	-	13.40 (3.50-15.60)	3.380 (0.770-4.900)	14.84	99
20+22+25+25+35	2.11	2.06	2.34	2.34	3.28	-	13.40 (3.50-15.60)	3.380 (0.770-4.900)	14.84	99
20+22+25+25+42	2.00	1.97	2.24	2.24	3.76	-	13.40 (3.50-15.60)	3.370 (0.770-4.890)	14.80	99
20+22+25+25+50	1.89	1.86	2.11	2.11	4.23	-	13.40 (3.50-15.60)	3.360 (0.770-4.880)	14.76	99
20+22+25+25+60	1.76	1.75	1.99	1.99	4.78	-	13.40 (3.50-15.60)	3.350 (0.770-4.870)	14.71	99
20+22+25+25+71	1.64	1.63	1.86	1.86	5.27	-	13.40 (3.50-15.60)	3.350 (0.770-4.870)	14.71	99
20+22+25+35+35	1.96	1.93	2.19	3.07	3.07	-	13.40 (3.50-15.60)	3.380 (0.770-4.900)	14.84	99
20+22+25+35+42	1.86	1.83	2.08	2.92	3.50	-	13.40 (3.50-15.60)	3.370 (0.770-4.890)	14.80	99
20+22+25+35+50	1.76	1.75	1.99	2.79	3.98	-	13.40 (3.50-15.60)	3.360 (0.770-4.880)	14.76	99
20+22+25+35+60	1.65	1.64	1.87	2.61	4.48	-	13.40 (3.50-15.60)	3.350 (0.770-4.870)	14.71	99
20+22+25+35+71	1.55	1.55	1.76	2.47	5.01	-	13.40 (3.50-15.60)	3.400 (0.770-4.870)	14.93	99
20+22+25+42+42	1.77	1.76	2.00	3.37	3.37	-	13.40 (3.50-15.60)	3.360 (0.770-4.880)	14.76	99
20+22+25+42+50	1.69	1.67	1.90	3.20	3.81	-	13.40 (3.50-15.60)	3.400 (0.770-4.870)	14.93	99
20+22+25+42+60	1.59	1.59	1.80	3.03	4.33	-	13.40 (3.50-15.60)	3.400 (0.770-4.870)	14.93	99
20+22+25+42+71	1.49	1.49	1.69	2.85	4.81	-	13.40 (3.50-15.60)	3.400 (0.770-4.870)	14.93	99
20+22+25+50+50	1.60	1.61	1.83	3.65	3.65	-	13.40 (3.50-15.60)	3.400 (0.770-4.870)	14.93	99
20+22+25+50+60	1.51	1.52	1.72	3.45	4.14	-	13.40 (3.50-15.60)	3.400 (0.770-4.870)	14.93	99
20+22+35+35+35	1.82	1.80	2.86	2.86	2.86	-	13.40 (3.50-15.60)	3.370 (0.770-4.890)	14.80	99
20+22+35+35+42	1.74	1.73	2.75	2.75	3.30	-	13.40 (3.50-15.60)	3.360 (0.770-4.880)	14.76	99
20+22+35+35+50	1.65	1.64	2.61	2.61	3.73	-	13.40 (3.50-15.60)	3.350 (0.770-4.870)	14.71	99
20+22+35+35+60	1.56	1.56	2.48	2.48	4.26	-	13.40 (3.50-15.60)	3.350 (0.770-4.870)	14.71	99
20+22+35+42+42	1.66	1.65	2.63	3.16	3.16	-	13.40 (3.50-15.60)	3.360 (0.770-4.880)	14.76	99
20+22+35+42+50	1.59	1.59	2.53	3.03	3.61	-	13.40 (3.50-15.60)	3.400 (0.770-4.870)	14.93	99
20+22+35+42+60	1.50	1.50	2.39	2.86	4.09	-	13.40 (3.50-15.60)	3.400 (0.770-4.870)	14.93	99
20+22+35+50+50	1.51	1.52	2.41	3.45	3.45	-	13.40 (3.50-15.60)	3.400 (0.770-4.870)	14.93	99
20+22+42+42+42	1.60	1.60	3.05	3.05	3.05	-	13.40 (3.50-15.60)	3.400 (0.770-4.870)	14.93	99
20+22+42+42+50	1.52	1.53	2.91	2.91	3.47	-	13.40 (3.50-15.60)	3.400 (0.770-4.870)	14.93	99
20+25+25+25+25	2.23	2.42	2.42	2.42	2.42	-	13.40 (3.50-15.60)	3.380 (0.770-4.900)	14.84	99
20+25+25+25+35	2.06	2.29	2.29	2.29	3.20	-	13.40 (3.50-15.60)	3.380 (0.770-4.900)	14.84	99
20+25+25+25+42	1.96	2.19	2.19	2.19	3.68	-	13.40 (3.50-15.60)	3.370 (0.770-4.890)	14.80	99
20+25+25+25+50	1.85	2.07	2.07	2.07	4.14	-	13.40 (3.50-15.60)	3.360 (0.770-4.880)	14.76	99
20+25+25+25+60	1.73	1.95	1.95	1.95	4.68	-	13.40 (3.50-15.60)	3.350 (0.770-4.870)	14.71	99
20+25+25+25+71	1.61	1.82	1.82	1.82	5.18	-	13.40 (3.50-15.60)	3.400 (0.770-4.870)	14.93	99
20+25+25+35+35	1.91	2.14	2.14	3.00	3.00	-	13.40 (3.50-15.60)	3.370 (0.770-4.890)	14.80	99
20+25+25+35+42	1.82	2.04	2.04	2.86	3.43	-	13.40 (3.50-15.60)	3.360 (0.770-4.880)	14.76	99
20+25+25+35+50	1.73	1.95	1.95	2.73	3.90	-	13.40 (3.50-15.60)	3.350 (0.770-4.870)	14.71	99
20+25+25+35+60	1.62	1.83	1.83	2.57	4.40	-	13.40 (3.50-15.60)	3.350 (0.770-4.870)	14.71	99
20+25+25+35+71	1.52	1.73	1.73	2.43	4.92	-	13.40 (3.50-15.60)	3.400 (0.770-4.870)	14.93	99
20+25+25+42+42	1.74	1.96	1.96	3.30	3.30	-	13.40 (3.50-15.60)	3.360 (0.770-4.880)	14.76	99
20+25+25+42+50	1.65	1.87	1.87	3.14	3.73	-	13.40 (3.50-15.60)	3.400 (0.770-4.870)	14.93	99
20+25+25+42+60	1.56	1.77	1.77	2.98	4.26	-	13.40 (3.50-15.60)	3.400 (0.770-4.870)	14.93	99

MXZ-6C122VA HEATING

Indoor units combination	Heating Capacity (kW)							Outdoor unit power consumption (kW)	Current (A)	Power factor (%)
	Unit A	Unit B	Unit C	Unit D	Unit E	Unit F	Total			
20+25+25+50+50	1.58	1.79	1.79	3.59	3.59	-	13.40 (3.50-15.60)	3.400 (0.770-4.870)	14.93	99
20+25+25+50+60	1.49	1.69	1.69	3.39	4.07	-	13.40 (3.50-15.60)	3.400 (0.770-4.870)	14.93	99
20+25+35+35+35	1.79	2.02	2.82	2.82	2.82	-	13.40 (3.50-15.60)	3.370 (0.770-4.890)	14.80	99
20+25+35+35+42	1.71	1.93	2.70	2.70	3.24	-	13.40 (3.50-15.60)	3.360 (0.770-4.880)	14.76	99
20+25+35+35+50	1.62	1.83	2.57	2.57	3.67	-	13.40 (3.50-15.60)	3.350 (0.770-4.870)	14.71	99
20+25+35+35+60	1.53	1.74	2.44	2.44	4.18	-	13.40 (3.50-15.60)	3.400 (0.770-4.870)	14.93	99
20+25+35+42+42	1.63	1.84	2.58	3.10	3.10	-	13.40 (3.50-15.60)	3.350 (0.770-4.870)	14.71	99
20+25+35+42+50	1.56	1.77	2.48	2.98	3.55	-	13.40 (3.50-15.60)	3.400 (0.770-4.870)	14.93	99
20+25+35+50+50	1.49	1.69	2.37	3.39	3.39	-	13.40 (3.50-15.60)	3.400 (0.770-4.870)	14.93	99
20+25+42+42+42	1.57	1.78	3.00	3.00	3.00	-	13.40 (3.50-15.60)	3.400 (0.770-4.870)	14.93	99
20+25+42+42+50	1.50	1.70	2.86	2.86	3.41	-	13.40 (3.50-15.60)	3.400 (0.770-4.870)	14.93	99
20+35+35+35+35	1.68	2.65	2.65	2.65	2.65	-	13.40 (3.50-15.60)	3.370 (0.770-4.890)	14.80	99
20+35+35+35+42	1.60	2.56	2.56	2.56	3.07	-	13.40 (3.50-15.60)	3.360 (0.770-4.880)	14.76	99
20+35+35+35+50	1.53	2.44	2.44	2.44	3.49	-	13.40 (3.50-15.60)	3.350 (0.770-4.870)	14.71	99
20+35+35+42+42	1.54	2.45	2.45	2.94	2.94	-	13.40 (3.50-15.60)	3.350 (0.770-4.870)	14.71	99
22+22+22+22+22	2.68	2.20	2.20	2.20	2.20	-	13.40 (3.50-15.60)	3.380 (0.770-4.900)	14.84	99
22+22+22+22+25	2.61	2.18	2.18	2.18	2.48	-	13.40 (3.50-15.60)	3.380 (0.770-4.900)	14.84	99
22+22+22+22+35	2.40	2.11	2.11	2.11	3.36	-	13.40 (3.50-15.60)	3.380 (0.770-4.900)	14.84	99
22+22+22+22+42	2.27	2.01	2.01	2.01	3.84	-	13.40 (3.50-15.60)	3.370 (0.770-4.890)	14.80	99
22+22+22+22+50	2.14	1.91	1.91	1.91	4.35	-	13.40 (3.50-15.60)	3.350 (0.770-4.870)	14.71	99
22+22+22+22+60	1.99	1.78	1.78	1.78	4.86	-	13.40 (3.50-15.60)	3.350 (0.770-4.870)	14.71	99
22+22+22+22+71	1.85	1.67	1.67	1.67	5.40	-	13.40 (3.50-15.60)	3.400 (0.770-4.870)	14.93	99
22+22+22+25+25	2.54	2.16	2.16	2.46	2.46	-	13.40 (3.50-15.60)	3.380 (0.770-4.900)	14.84	99
22+22+22+25+35	2.34	2.08	2.08	2.36	3.31	-	13.40 (3.50-15.60)	3.370 (0.770-4.890)	14.80	99
22+22+22+25+42	2.22	1.97	1.97	2.24	3.76	-	13.40 (3.50-15.60)	3.360 (0.770-4.880)	14.76	99
22+22+22+25+50	2.09	1.87	1.87	2.13	4.26	-	13.40 (3.50-15.60)	3.350 (0.770-4.870)	14.71	99
22+22+22+25+60	1.95	1.76	1.76	2.00	4.81	-	13.40 (3.50-15.60)	3.350 (0.770-4.870)	14.71	99
22+22+22+25+71	1.82	1.64	1.64	1.87	5.30	-	13.40 (3.50-15.60)	3.400 (0.770-4.870)	14.93	99
22+22+22+35+35	2.17	1.94	1.94	3.09	3.09	-	13.40 (3.50-15.60)	3.370 (0.770-4.890)	14.80	99
22+22+22+35+42	2.06	1.85	1.85	2.94	3.52	-	13.40 (3.50-15.60)	3.360 (0.770-4.880)	14.76	99
22+22+22+35+50	1.95	1.76	1.76	2.80	4.01	-	13.40 (3.50-15.60)	3.350 (0.770-4.870)	14.71	99
22+22+22+35+60	1.83	1.65	1.65	2.63	4.51	-	13.40 (3.50-15.60)	3.400 (0.770-4.870)	14.93	99
22+22+22+35+71	1.71	1.56	1.56	2.48	5.04	-	13.40 (3.50-15.60)	3.400 (0.770-4.870)	14.93	99
22+22+22+42+42	1.97	1.77	1.77	3.39	3.39	-	13.40 (3.50-15.60)	3.350 (0.770-4.870)	14.71	99
22+22+22+42+50	1.87	1.68	1.68	3.22	3.83	-	13.40 (3.50-15.60)	3.400 (0.770-4.870)	14.93	99
22+22+22+42+60	1.75	1.60	1.60	3.05	4.36	-	13.40 (3.50-15.60)	3.400 (0.770-4.870)	14.93	99
22+22+22+42+71	1.65	1.50	1.50	2.86	4.84	-	13.40 (3.50-15.60)	3.400 (0.770-4.870)	14.93	99
22+22+22+50+50	1.78	1.60	1.60	3.64	3.64	-	13.40 (3.50-15.60)	3.400 (0.770-4.870)	14.93	99
22+22+22+50+60	1.68	1.53	1.53	3.47	4.16	-	13.40 (3.50-15.60)	3.400 (0.770-4.870)	14.93	99
22+22+25+25+25	2.48	2.13	2.42	2.42	2.42	-	13.40 (3.50-15.60)	3.370 (0.770-4.890)	14.80	99
22+22+25+25+35	2.29	2.03	2.31	2.31	3.23	-	13.40 (3.50-15.60)	3.370 (0.770-4.890)	14.80	99
22+22+25+25+42	2.17	1.94	2.21	2.21	3.71	-	13.40 (3.50-15.60)	3.360 (0.770-4.880)	14.76	99
22+22+25+25+50	2.05	1.83	2.08	2.08	4.17	-	13.40 (3.50-15.60)	3.350 (0.770-4.870)	14.71	99
22+22+25+25+60	1.91	1.73	1.96	1.96	4.71	-	13.40 (3.50-15.60)	3.400 (0.770-4.870)	14.93	99
22+22+25+25+71	1.79	1.61	1.83	1.83	5.21	-	13.40 (3.50-15.60)	3.400 (0.770-4.870)	14.93	99
22+22+25+35+35	2.12	1.90	2.16	3.02	3.02	-	13.40 (3.50-15.60)	3.370 (0.770-4.890)	14.80	99

MXZ-6C122VA HEATING

Indoor units combination	Heating Capacity (kW)							Outdoor unit power consumption (kW)	Current (A)	Power factor (%)
	Unit A	Unit B	Unit C	Unit D	Unit E	Unit F	Total			
22+22+25+35+42	2.02	1.81	2.05	2.88	3.45	-	13.40 (3.50-15.60)	3.360 (0.770-4.880)	14.76	99
22+22+25+35+50	1.91	1.73	1.96	2.75	3.93	-	13.40 (3.50-15.60)	3.350 (0.770-4.870)	14.71	99
22+22+25+35+60	1.80	1.62	1.84	2.58	4.43	-	13.40 (3.50-15.60)	3.400 (0.770-4.870)	14.93	99
22+22+25+35+71	1.68	1.53	1.74	2.44	4.95	-	13.40 (3.50-15.60)	3.400 (0.770-4.870)	14.93	99
22+22+25+42+42	1.93	1.74	1.98	3.32	3.32	-	13.40 (3.50-15.60)	3.350 (0.770-4.870)	14.71	99
22+22+25+42+50	1.83	1.65	1.88	3.16	3.76	-	13.40 (3.50-15.60)	3.400 (0.770-4.870)	14.93	99
22+22+25+42+60	1.72	1.57	1.78	3.00	4.28	-	13.40 (3.50-15.60)	3.400 (0.770-4.870)	14.93	99
22+22+25+50+50	1.74	1.59	1.80	3.61	3.61	-	13.40 (3.50-15.60)	3.400 (0.770-4.870)	14.93	99
22+22+25+50+60	1.65	1.50	1.70	3.41	4.09	-	13.40 (3.50-15.60)	3.400 (0.770-4.870)	14.93	99
22+22+35+35+35	1.98	1.77	2.82	2.82	2.82	-	13.40 (3.50-15.60)	3.370 (0.770-4.890)	14.80	99
22+22+35+35+42	1.89	1.71	2.71	2.71	3.26	-	13.40 (3.50-15.60)	3.360 (0.770-4.880)	14.76	99
22+22+35+35+50	1.80	1.62	2.58	2.58	3.69	-	13.40 (3.50-15.60)	3.400 (0.770-4.870)	14.93	99
22+22+35+35+60	1.69	1.54	2.45	2.45	4.21	-	13.40 (3.50-15.60)	3.400 (0.770-4.870)	14.93	99
22+22+35+42+42	1.81	1.63	2.60	3.12	3.12	-	13.40 (3.50-15.60)	3.350 (0.770-4.870)	14.71	99
22+22+35+42+50	1.72	1.57	2.50	3.00	3.57	-	13.40 (3.50-15.60)	3.400 (0.770-4.870)	14.93	99
22+22+35+50+50	1.65	1.50	2.39	3.41	3.41	-	13.40 (3.50-15.60)	3.400 (0.770-4.870)	14.93	99
22+22+42+42+42	1.73	1.58	3.01	3.01	3.01	-	13.40 (3.50-15.60)	3.400 (0.770-4.870)	14.93	99
22+22+42+42+50	1.66	1.51	2.88	2.88	3.43	-	13.40 (3.50-15.60)	3.400 (0.770-4.870)	14.93	99
22+25+25+25+25	2.42	2.40	2.40	2.40	2.40	-	13.40 (3.50-15.60)	3.370 (0.770-4.890)	14.80	99
22+25+25+25+35	2.23	2.25	2.25	2.25	3.16	-	13.40 (3.50-15.60)	3.370 (0.770-4.890)	14.80	99
22+25+25+25+42	2.12	2.16	2.16	2.16	3.63	-	13.40 (3.50-15.60)	3.360 (0.770-4.880)	14.76	99
22+25+25+25+50	2.01	2.04	2.04	2.04	4.08	-	13.40 (3.50-15.60)	3.350 (0.770-4.870)	14.71	99
22+25+25+25+60	1.88	1.93	1.93	1.93	4.62	-	13.40 (3.50-15.60)	3.400 (0.770-4.870)	14.93	99
22+25+25+25+71	1.75	1.82	1.82	1.82	5.16	-	13.40 (3.50-15.60)	3.400 (0.770-4.870)	14.93	99
22+25+25+35+35	2.08	2.11	2.11	2.96	2.96	-	13.40 (3.50-15.60)	3.370 (0.770-4.890)	14.80	99
22+25+25+35+42	1.98	2.01	2.01	2.82	3.38	-	13.40 (3.50-15.60)	3.360 (0.770-4.880)	14.76	99
22+25+25+35+50	1.88	1.93	1.93	2.70	3.85	-	13.40 (3.50-15.60)	3.400 (0.770-4.870)	14.93	99
22+25+25+35+60	1.77	1.83	1.83	2.56	4.38	-	13.40 (3.50-15.60)	3.400 (0.770-4.870)	14.93	99
22+25+25+35+71	1.66	1.71	1.71	2.40	4.87	-	13.40 (3.50-15.60)	3.400 (0.770-4.870)	14.93	99
22+25+25+42+42	1.89	1.94	1.94	3.26	3.26	-	13.40 (3.50-15.60)	3.350 (0.770-4.870)	14.71	99
22+25+25+42+50	1.80	1.84	1.84	3.10	3.69	-	13.40 (3.50-15.60)	3.400 (0.770-4.870)	14.93	99
22+25+25+42+60	1.69	1.75	1.75	2.94	4.21	-	13.40 (3.50-15.60)	3.400 (0.770-4.870)	14.93	99
22+25+25+50+50	1.71	1.77	1.77	3.55	3.55	-	13.40 (3.50-15.60)	3.400 (0.770-4.870)	14.93	99
22+25+35+35+35	1.94	1.99	2.79	2.79	2.79	-	13.40 (3.50-15.60)	3.360 (0.770-4.880)	14.76	99
22+25+35+35+42	1.85	1.90	2.66	2.66	3.20	-	13.40 (3.50-15.60)	3.360 (0.770-4.880)	14.76	99
22+25+35+35+50	1.77	1.83	2.56	2.56	3.65	-	13.40 (3.50-15.60)	3.400 (0.770-4.870)	14.93	99
22+25+35+35+60	1.67	1.72	2.41	2.41	4.14	-	13.40 (3.50-15.60)	3.400 (0.770-4.870)	14.93	99
22+25+35+42+42	1.78	1.82	2.55	3.06	3.06	-	13.40 (3.50-15.60)	3.400 (0.770-4.870)	14.93	99
22+25+35+42+50	1.69	1.75	2.45	2.94	3.51	-	13.40 (3.50-15.60)	3.400 (0.770-4.870)	14.93	99
22+25+42+42+42	1.70	1.76	2.96	2.96	2.96	-	13.40 (3.50-15.60)	3.400 (0.770-4.870)	14.93	99
22+35+35+35+35	1.82	2.61	2.61	2.61	2.61	-	13.40 (3.50-15.60)	3.360 (0.770-4.880)	14.76	99
22+35+35+35+42	1.74	2.53	2.53	2.53	3.03	-	13.40 (3.50-15.60)	3.350 (0.770-4.870)	14.71	99
22+35+35+35+50	1.67	2.41	2.41	2.41	3.45	-	13.40 (3.50-15.60)	3.400 (0.770-4.870)	14.93	99
22+35+35+42+42	1.68	2.43	2.43	2.91	2.91	-	13.40 (3.50-15.60)	3.400 (0.770-4.870)	14.93	99
25+25+25+25+25	2.68	2.38	2.38	2.38	2.38	-	13.40 (3.50-15.60)	3.370 (0.770-4.890)	14.80	99
25+25+25+25+35	2.48	2.22	2.22	2.22	3.11	-	13.40 (3.50-15.60)	3.370 (0.770-4.890)	14.80	99

MXZ-6C122VA HEATING

Indoor units combination	Heating Capacity (kW)							Outdoor unit power consumption (kW)	Current (A)	Power factor (%)
	Unit A	Unit B	Unit C	Unit D	Unit E	Unit F	Total			
25+25+25+25+42	2.36	2.11	2.11	2.11	3.55	-	13.40 (3.50-15.60)	3.360 (0.770-4.880)	14.76	99
25+25+25+25+50	2.23	2.02	2.02	2.02	4.03	-	13.40 (3.50-15.60)	3.400 (0.770-4.870)	14.93	99
25+25+25+25+60	2.09	1.89	1.89	1.89	4.54	-	13.40 (3.50-15.60)	3.400 (0.770-4.870)	14.93	99
25+25+25+25+71	1.96	1.78	1.78	1.78	5.07	-	13.40 (3.50-15.60)	3.400 (0.770-4.870)	14.93	99
25+25+25+35+35	2.31	2.07	2.07	2.90	2.90	-	13.40 (3.50-15.60)	3.360 (0.770-4.880)	14.76	99
25+25+25+35+42	2.20	1.99	1.99	2.79	3.34	-	13.40 (3.50-15.60)	3.360 (0.770-4.880)	14.76	99
25+25+25+35+50	2.09	1.89	1.89	2.65	3.78	-	13.40 (3.50-15.60)	3.400 (0.770-4.870)	14.93	99
25+25+25+35+60	1.97	1.79	1.79	2.51	4.31	-	13.40 (3.50-15.60)	3.400 (0.770-4.870)	14.93	99
25+25+25+42+42	2.11	1.90	1.90	3.20	3.20	-	13.40 (3.50-15.60)	3.400 (0.770-4.870)	14.93	99
25+25+25+42+50	2.01	1.83	1.83	3.07	3.65	-	13.40 (3.50-15.60)	3.400 (0.770-4.870)	14.93	99
25+25+25+42+60	1.89	1.72	1.72	2.89	4.14	-	13.40 (3.50-15.60)	3.400 (0.770-4.870)	14.93	99
25+25+25+50+50	1.91	1.74	1.74	3.49	3.49	-	13.40 (3.50-15.60)	3.400 (0.770-4.870)	14.93	99
25+25+35+35+35	2.16	1.95	2.73	2.73	2.73	-	13.40 (3.50-15.60)	3.360 (0.770-4.880)	14.76	99
25+25+35+35+42	2.07	1.87	2.61	2.61	3.14	-	13.40 (3.50-15.60)	3.350 (0.770-4.870)	14.71	99
25+25+35+35+50	1.97	1.79	2.51	2.51	3.59	-	13.40 (3.50-15.60)	3.400 (0.770-4.870)	14.93	99
25+25+35+35+60	1.86	1.69	2.37	2.37	4.07	-	13.40 (3.50-15.60)	3.400 (0.770-4.870)	14.93	99
25+25+35+42+42	1.98	1.80	2.53	3.03	3.03	-	13.40 (3.50-15.60)	3.400 (0.770-4.870)	14.93	99
25+25+35+42+50	1.89	1.72	2.41	2.89	3.45	-	13.40 (3.50-15.60)	3.400 (0.770-4.870)	14.93	99
25+25+42+42+42	1.90	1.73	2.91	2.91	2.91	-	13.40 (3.50-15.60)	3.400 (0.770-4.870)	14.93	99
25+35+35+35+35	2.03	2.57	2.57	2.57	2.57	-	13.40 (3.50-15.60)	3.360 (0.770-4.880)	14.76	99
25+35+35+35+42	1.95	2.48	2.48	2.48	2.98	-	13.40 (3.50-15.60)	3.350 (0.770-4.870)	14.71	99
25+35+35+35+50	1.86	2.37	2.37	2.37	3.39	-	13.40 (3.50-15.60)	3.400 (0.770-4.870)	14.93	99
25+35+35+42+42	1.87	2.39	2.39	2.86	2.86	-	13.40 (3.50-15.60)	3.400 (0.770-4.870)	14.93	99
35+35+35+35+35	2.68	2.44	2.44	2.44	2.44	-	13.40 (3.50-15.60)	3.360 (0.770-4.880)	14.76	99
15+15+15+15+15+15	1.70	1.50	1.50	1.50	1.50	1.50	10.20 (3.40-15.90)	2.400 (0.790-6.020)	10.54	99
15+15+15+15+15+20	1.69	1.48	1.48	1.48	1.48	1.98	10.70 (3.40-16.00)	2.650 (0.790-6.020)	11.64	99
15+15+15+15+15+22	1.73	1.48	1.48	1.48	1.48	2.18	11.20 (3.40-16.00)	2.900 (0.790-6.020)	12.74	99
15+15+15+15+15+25	1.71	1.47	1.47	1.47	1.47	2.45	11.40 (3.40-16.00)	3.000 (0.790-6.020)	13.18	99
15+15+15+15+15+35	1.62	1.45	1.45	1.45	1.45	3.37	11.90 (3.40-16.00)	3.250 (0.790-6.020)	14.27	99
15+15+15+15+15+42	1.71	1.44	1.44	1.44	1.44	4.02	13.30 (3.50-16.10)	3.875 (0.790-5.910)	17.02	99
15+15+15+15+15+50	1.68	1.40	1.40	1.40	1.40	4.68	14.00 (3.50-16.50)	3.699 (0.760-5.200)	16.25	99
15+15+15+15+15+60	1.56	1.34	1.34	1.34	1.34	5.38	14.00 (3.50-16.50)	3.695 (0.760-5.200)	16.23	99
15+15+15+15+15+71	1.44	1.25	1.25	1.25	1.25	5.93	14.00 (3.50-16.50)	3.686 (0.760-5.190)	16.19	99
15+15+15+15+20+20	1.64	1.47	1.47	1.47	1.96	1.96	10.90 (3.40-16.00)	2.750 (0.790-6.020)	12.08	99
15+15+15+15+20+22	1.72	1.47	1.47	1.47	1.96	2.16	11.70 (3.40-16.00)	3.150 (0.790-6.020)	13.83	99
15+15+15+15+20+25	1.73	1.46	1.46	1.46	1.94	2.43	12.10 (3.40-16.00)	3.350 (0.790-6.020)	14.71	99
15+15+15+15+20+35	1.62	1.43	1.43	1.43	1.91	3.35	12.40 (3.40-16.00)	3.500 (0.790-6.020)	15.37	99
15+15+15+15+20+42	1.67	1.41	1.41	1.41	1.89	3.96	13.60 (3.50-16.30)	3.800 (0.780-5.610)	16.69	99
15+15+15+15+20+50	1.62	1.37	1.37	1.37	1.83	4.58	14.00 (3.50-16.50)	3.695 (0.760-5.200)	16.23	99
15+15+15+15+20+60	1.50	1.31	1.31	1.31	1.74	5.23	14.00 (3.50-16.50)	3.688 (0.760-5.190)	16.20	99
15+15+15+15+20+71	1.39	1.21	1.21	1.21	1.62	5.74	14.00 (3.50-16.50)	3.682 (0.760-5.190)	16.17	99
15+15+15+15+22+22	1.85	1.46	1.46	1.46	2.14	2.14	12.80 (3.40-16.00)	3.700 (0.790-6.020)	16.25	99
15+15+15+15+22+25	1.84	1.46	1.46	1.46	2.14	2.43	13.10 (3.40-16.00)	3.850 (0.790-6.020)	16.91	99
15+15+15+15+22+35	1.72	1.44	1.44	1.44	2.11	3.35	13.40 (3.50-16.20)	3.850 (0.790-5.810)	16.91	99
15+15+15+15+22+42	1.69	1.40	1.40	1.40	2.06	3.93	14.00 (3.50-16.50)	3.699 (0.760-5.200)	16.25	99
15+15+15+15+22+50	1.59	1.36	1.36	1.36	2.00	4.55	14.00 (3.50-16.50)	3.686 (0.760-5.190)	16.19	99

MXZ-6C122VA HEATING

Indoor units combination	Heating Capacity (kW)							Outdoor unit power consumption (kW)	Current (A)	Power factor (%)
	Unit A	Unit B	Unit C	Unit D	Unit E	Unit F	Total			
15+15+15+15+22+60	1.48	1.29	1.29	1.29	1.89	5.15	14.00 (3.50-16.50)	3.679 (0.760-5.180)	16.16	99
15+15+15+15+22+71	1.37	1.20	1.20	1.20	1.75	5.66	14.00 (3.50-16.50)	3.674 (0.760-5.180)	16.14	99
15+15+15+15+25+25	1.81	1.45	1.45	1.45	2.41	2.41	13.30 (3.50-16.10)	3.875 (0.790-5.910)	17.02	99
15+15+15+15+25+35	1.70	1.43	1.43	1.43	2.38	3.33	13.60 (3.50-16.30)	3.800 (0.780-5.610)	16.69	99
15+15+15+15+25+42	1.65	1.39	1.39	1.39	2.32	3.90	14.00 (3.50-16.50)	3.697 (0.760-5.200)	16.24	99
15+15+15+15+25+50	1.56	1.34	1.34	1.34	2.24	4.48	14.00 (3.50-16.50)	3.682 (0.760-5.190)	16.17	99
15+15+15+15+25+60	1.45	1.26	1.26	1.26	2.10	5.05	14.00 (3.50-16.50)	3.677 (0.760-5.180)	16.15	99
15+15+15+15+25+71	1.35	1.17	1.17	1.17	1.96	5.55	14.00 (3.50-16.50)	3.671 (0.760-5.180)	16.12	99
15+15+15+15+35+35	1.59	1.37	1.37	1.37	3.20	3.20	13.80 (3.50-16.40)	3.750 (0.770-5.410)	16.47	99
15+15+15+15+35+42	1.53	1.32	1.32	1.32	3.09	3.71	14.00 (3.50-16.50)	3.695 (0.760-5.200)	16.23	99
15+15+15+15+35+50	1.45	1.26	1.26	1.26	2.94	4.21	14.00 (3.50-16.50)	3.679 (0.760-5.180)	16.16	99
15+15+15+15+35+60	1.35	1.18	1.18	1.18	2.75	4.72	14.00 (3.50-16.50)	3.672 (0.760-5.180)	16.13	99
15+15+15+15+35+71	1.27	1.10	1.10	1.10	2.57	5.22	14.00 (3.50-16.50)	3.667 (0.760-5.170)	16.11	99
15+15+15+15+42+42	1.46	1.27	1.27	1.27	3.56	3.56	14.00 (3.50-16.50)	3.682 (0.760-5.190)	16.17	99
15+15+15+15+42+50	1.38	1.20	1.20	1.20	3.37	4.01	14.00 (3.50-16.50)	3.667 (0.760-5.170)	16.11	99
15+15+15+15+42+60	1.30	1.13	1.13	1.13	3.16	4.52	14.00 (3.50-16.50)	3.661 (0.760-5.170)	16.08	99
15+15+15+15+42+71	1.21	1.06	1.06	1.06	2.96	5.01	14.00 (3.50-16.50)	3.656 (0.760-5.160)	16.05	99
15+15+15+15+50+50	1.31	1.14	1.14	1.14	3.81	3.81	14.00 (3.50-16.50)	3.652 (0.760-5.160)	16.04	99
15+15+15+15+50+60	1.24	1.08	1.08	1.08	3.59	4.31	14.00 (3.50-16.50)	3.646 (0.760-5.150)	16.01	99
15+15+15+15+60+60	1.17	1.02	1.02	1.02	4.07	4.07	14.00 (3.50-16.50)	3.640 (0.760-5.150)	15.99	99
15+15+15+20+20+20	1.60	1.46	1.46	1.94	1.94	1.94	11.20 (3.40-16.00)	2.900 (0.790-6.020)	12.74	99
15+15+15+20+20+22	1.72	1.46	1.46	1.94	1.94	2.14	12.30 (3.40-16.00)	3.450 (0.790-6.020)	15.15	99
15+15+15+20+20+25	1.72	1.45	1.45	1.93	1.93	2.41	12.60 (3.40-16.00)	3.600 (0.790-6.020)	15.81	99
15+15+15+20+20+35	1.61	1.43	1.43	1.90	1.90	3.33	12.90 (3.40-16.00)	3.750 (0.790-6.020)	16.47	99
15+15+15+20+20+42	1.63	1.39	1.39	1.86	1.86	3.90	13.80 (3.50-16.40)	3.750 (0.770-5.410)	16.47	99
15+15+15+20+20+50	1.56	1.34	1.34	1.79	1.79	4.48	14.00 (3.50-16.50)	3.690 (0.760-5.200)	16.21	99
15+15+15+20+20+60	1.45	1.26	1.26	1.68	1.68	5.05	14.00 (3.50-16.50)	3.686 (0.760-5.190)	16.19	99
15+15+15+20+20+71	1.35	1.17	1.17	1.56	1.56	5.55	14.00 (3.50-16.50)	3.679 (0.760-5.180)	16.16	99
15+15+15+20+22+22	1.82	1.44	1.44	1.93	2.12	2.12	13.20 (3.40-16.00)	3.900 (0.790-6.010)	17.13	99
15+15+15+20+22+25	1.81	1.45	1.45	1.93	2.12	2.41	13.50 (3.50-16.20)	3.825 (0.780-5.710)	16.80	99
15+15+15+20+22+35	1.68	1.41	1.41	1.89	2.07	3.30	13.70 (3.50-16.40)	3.775 (0.780-5.510)	16.58	99
15+15+15+20+22+42	1.63	1.38	1.38	1.84	2.03	3.87	14.00 (3.50-16.50)	3.695 (0.760-5.200)	16.23	99
15+15+15+20+22+50	1.53	1.32	1.32	1.77	1.94	4.42	14.00 (3.50-16.50)	3.682 (0.760-5.190)	16.17	99
15+15+15+20+22+60	1.43	1.24	1.24	1.66	1.83	4.98	14.00 (3.50-16.50)	3.674 (0.760-5.180)	16.14	99
15+15+15+20+22+71	1.33	1.16	1.16	1.54	1.70	5.48	14.00 (3.50-16.50)	3.670 (0.760-5.180)	16.12	99
15+15+15+20+25+25	1.79	1.43	1.43	1.91	2.39	2.39	13.70 (3.50-16.40)	3.775 (0.780-5.510)	16.58	99
15+15+15+20+25+35	1.66	1.40	1.40	1.87	2.34	3.28	13.80 (3.50-16.40)	3.750 (0.770-5.410)	16.47	99
15+15+15+20+25+42	1.59	1.36	1.36	1.82	2.27	3.82	14.00 (3.50-16.50)	3.695 (0.760-5.200)	16.23	99
15+15+15+20+25+50	1.50	1.31	1.31	1.74	2.18	4.36	14.00 (3.50-16.50)	3.679 (0.760-5.180)	16.16	99
15+15+15+20+25+60	1.40	1.22	1.22	1.63	2.03	4.88	14.00 (3.50-16.50)	3.671 (0.760-5.180)	16.12	99
15+15+15+20+25+71	1.30	1.14	1.14	1.52	1.89	5.38	14.00 (3.50-16.50)	3.666 (0.760-5.170)	16.10	99
15+15+15+20+35+35	1.54	1.34	1.34	1.79	3.14	3.14	13.90 (3.50-16.50)	3.725 (0.770-5.310)	16.36	99
15+15+15+20+35+42	1.48	1.29	1.29	1.72	3.01	3.61	14.00 (3.50-16.50)	3.690 (0.760-5.200)	16.21	99
15+15+15+20+35+50	1.40	1.22	1.22	1.63	2.85	4.07	14.00 (3.50-16.50)	3.674 (0.760-5.180)	16.14	99
15+15+15+20+35+60	1.31	1.14	1.14	1.53	2.67	4.58	14.00 (3.50-16.50)	3.670 (0.760-5.180)	16.12	99
15+15+15+20+35+71	1.23	1.07	1.07	1.43	2.50	5.07	14.00 (3.50-16.50)	3.663 (0.760-5.170)	16.09	99

MXZ-6C122VA HEATING

Indoor units combination	Heating Capacity (kW)							Outdoor unit power consumption (kW)	Current (A)	Power factor (%)
	Unit A	Unit B	Unit C	Unit D	Unit E	Unit F	Total			
15+15+15+20+42+42	1.41	1.23	1.23	1.64	3.44	3.44	14.00 (3.50-16.50)	3.679 (0.760-5.180)	16.16	99
15+15+15+20+42+50	1.34	1.17	1.17	1.55	3.26	3.89	14.00 (3.50-16.50)	3.663 (0.760-5.170)	16.09	99
15+15+15+20+42+60	1.26	1.10	1.10	1.46	3.07	4.38	14.00 (3.50-16.50)	3.657 (0.760-5.160)	16.06	99
15+15+15+20+42+71	1.18	1.03	1.03	1.37	2.88	4.87	14.00 (3.50-16.50)	3.652 (0.760-5.160)	16.04	99
15+15+15+20+50+50	1.27	1.11	1.11	1.48	3.70	3.70	14.00 (3.50-16.50)	3.647 (0.760-5.150)	16.02	99
15+15+15+20+50+60	1.20	1.05	1.05	1.39	3.49	4.18	14.00 (3.50-16.50)	3.642 (0.760-5.150)	15.99	99
15+15+15+22+22+22	1.88	1.45	1.45	2.12	2.12	2.12	13.90 (3.50-16.50)	3.725 (0.770-5.310)	16.36	99
15+15+15+22+22+25	1.83	1.43	1.43	2.10	2.10	2.39	13.90 (3.50-16.50)	3.725 (0.770-5.310)	16.36	99
15+15+15+22+22+35	1.69	1.40	1.40	2.06	2.06	3.27	14.00 (3.50-16.50)	3.699 (0.760-5.200)	16.25	99
15+15+15+22+22+42	1.60	1.37	1.37	2.02	2.02	3.85	14.00 (3.50-16.50)	3.686 (0.760-5.190)	16.19	99
15+15+15+22+22+50	1.51	1.32	1.32	1.93	1.93	4.39	14.00 (3.50-16.50)	3.671 (0.760-5.180)	16.12	99
15+15+15+22+22+60	1.41	1.23	1.23	1.80	1.80	4.91	14.00 (3.50-16.50)	3.665 (0.760-5.170)	16.09	99
15+15+15+22+22+71	1.31	1.14	1.14	1.68	1.68	5.41	14.00 (3.50-16.50)	3.661 (0.760-5.170)	16.08	99
15+15+15+22+25+25	1.79	1.44	1.44	2.11	2.39	2.39	14.00 (3.50-16.50)	3.699 (0.760-5.200)	16.25	99
15+15+15+22+25+35	1.65	1.39	1.39	2.04	2.32	3.25	14.00 (3.50-16.50)	3.697 (0.760-5.200)	16.24	99
15+15+15+22+25+42	1.57	1.35	1.35	1.99	2.26	3.79	14.00 (3.50-16.50)	3.686 (0.760-5.190)	16.19	99
15+15+15+22+25+50	1.48	1.29	1.29	1.89	2.15	4.30	14.00 (3.50-16.50)	3.670 (0.760-5.180)	16.12	99
15+15+15+22+25+60	1.38	1.20	1.20	1.77	2.01	4.82	14.00 (3.50-16.50)	3.663 (0.760-5.170)	16.09	99
15+15+15+22+25+71	1.29	1.12	1.12	1.65	1.87	5.31	14.00 (3.50-16.50)	3.657 (0.760-5.160)	16.06	99
15+15+15+22+35+35	1.53	1.32	1.32	1.94	3.09	3.09	14.00 (3.50-16.50)	3.695 (0.760-5.200)	16.23	99
15+15+15+22+35+42	1.46	1.27	1.27	1.86	2.97	3.56	14.00 (3.50-16.50)	3.682 (0.760-5.190)	16.17	99
15+15+15+22+35+50	1.38	1.20	1.20	1.77	2.81	4.01	14.00 (3.50-16.50)	3.666 (0.760-5.170)	16.10	99
15+15+15+22+35+60	1.30	1.13	1.13	1.66	2.64	4.52	14.00 (3.50-16.50)	3.661 (0.760-5.170)	16.08	99
15+15+15+22+35+71	1.21	1.06	1.06	1.55	2.47	5.01	14.00 (3.50-16.50)	3.653 (0.760-5.160)	16.04	99
15+15+15+22+42+42	1.39	1.21	1.21	1.78	3.39	3.39	14.00 (3.50-16.50)	3.670 (0.760-5.180)	16.12	99
15+15+15+22+42+50	1.32	1.15	1.15	1.69	3.22	3.84	14.00 (3.50-16.50)	3.653 (0.760-5.160)	16.04	99
15+15+15+22+42+60	1.24	1.08	1.08	1.59	3.03	4.33	14.00 (3.50-16.50)	3.647 (0.760-5.150)	16.02	99
15+15+15+22+42+71	1.17	1.02	1.02	1.49	2.85	4.81	14.00 (3.50-16.50)	3.642 (0.760-5.150)	15.99	99
15+15+15+22+50+50	1.26	1.10	1.10	1.61	3.65	3.65	14.00 (3.50-16.50)	3.639 (0.760-5.150)	15.98	99
15+15+15+22+50+60	1.19	1.03	1.03	1.52	3.45	4.14	14.00 (3.50-16.50)	3.633 (0.760-5.150)	15.96	99
15+15+15+25+25+25	1.75	1.43	1.43	2.38	2.38	2.38	14.00 (3.50-16.50)	3.697 (0.760-5.200)	16.24	99
15+15+15+25+25+35	1.62	1.37	1.37	2.29	2.29	3.20	14.00 (3.50-16.50)	3.695 (0.760-5.200)	16.23	99
15+15+15+25+25+42	1.53	1.32	1.32	2.21	2.21	3.71	14.00 (3.50-16.50)	3.682 (0.760-5.190)	16.17	99
15+15+15+25+25+50	1.45	1.26	1.26	2.10	2.10	4.21	14.00 (3.50-16.50)	3.666 (0.760-5.170)	16.10	99
15+15+15+25+25+60	1.35	1.18	1.18	1.97	1.97	4.72	14.00 (3.50-16.50)	3.661 (0.760-5.170)	16.08	99
15+15+15+25+25+71	1.27	1.10	1.10	1.84	1.84	5.22	14.00 (3.50-16.50)	3.655 (0.760-5.160)	16.05	99
15+15+15+25+35+35	1.50	1.31	1.31	2.18	3.05	3.05	14.00 (3.50-16.50)	3.690 (0.760-5.200)	16.21	99
15+15+15+25+35+42	1.43	1.24	1.24	2.07	2.90	3.49	14.00 (3.50-16.50)	3.679 (0.760-5.180)	16.16	99
15+15+15+25+35+50	1.35	1.18	1.18	1.97	2.75	3.94	14.00 (3.50-16.50)	3.663 (0.760-5.170)	16.09	99
15+15+15+25+35+60	1.27	1.11	1.11	1.85	2.59	4.44	14.00 (3.50-16.50)	3.657 (0.760-5.160)	16.06	99
15+15+15+25+35+71	1.19	1.04	1.04	1.73	2.43	4.92	14.00 (3.50-16.50)	3.652 (0.760-5.160)	16.04	99
15+15+15+25+42+42	1.36	1.19	1.19	1.98	3.33	3.33	14.00 (3.50-16.50)	3.666 (0.760-5.170)	16.10	99
15+15+15+25+42+50	1.30	1.13	1.13	1.88	3.16	3.77	14.00 (3.50-16.50)	3.651 (0.760-5.160)	16.03	99
15+15+15+25+42+60	1.22	1.06	1.06	1.77	2.98	4.26	14.00 (3.50-16.50)	3.645 (0.760-5.150)	16.01	99
15+15+15+25+50+50	1.24	1.08	1.08	1.79	3.59	3.59	14.00 (3.50-16.50)	3.638 (0.760-5.150)	15.98	99
15+15+15+25+50+60	1.17	1.02	1.02	1.69	3.39	4.07	14.00 (3.50-16.50)	3.631 (0.760-5.150)	15.95	99

MXZ-6C122VA HEATING

Indoor units combination	Heating Capacity (kW)							Outdoor unit power consumption (kW)	Current (A)	Power factor (%)
	Unit A	Unit B	Unit C	Unit D	Unit E	Unit F	Total			
15+15+15+35+35+35	1.40	1.22	1.22	2.85	2.85	2.85	14.00 (3.50-16.50)	3.686 (0.760-5.190)	16.19	99
15+15+15+35+35+42	1.34	1.17	1.17	2.72	2.72	3.26	14.00 (3.50-16.50)	3.674 (0.760-5.180)	16.14	99
15+15+15+35+35+50	1.27	1.11	1.11	2.59	2.59	3.70	14.00 (3.50-16.50)	3.661 (0.760-5.170)	16.08	99
15+15+15+35+35+60	1.20	1.05	1.05	2.44	2.44	4.18	14.00 (3.50-16.50)	3.653 (0.760-5.160)	16.04	99
15+15+15+35+42+42	1.28	1.12	1.12	2.60	3.12	3.12	14.00 (3.50-16.50)	3.663 (0.760-5.170)	16.09	99
15+15+15+35+42+50	1.22	1.06	1.06	2.48	2.98	3.55	14.00 (3.50-16.50)	3.647 (0.760-5.150)	16.02	99
15+15+15+35+50+50	1.17	1.02	1.02	2.37	3.39	3.39	14.00 (3.50-16.50)	3.633 (0.760-5.150)	15.96	99
15+15+15+42+42+42	1.23	1.07	1.07	3.00	3.00	3.00	14.00 (3.50-16.50)	3.651 (0.760-5.160)	16.03	99
15+15+15+42+42+50	1.17	1.02	1.02	2.86	2.86	3.41	14.00 (3.50-16.50)	3.636 (0.760-5.150)	15.97	99
15+15+20+20+20+20	1.58	1.45	1.93	1.93	1.93	1.93	11.60 (3.40-16.00)	3.100 (0.790-6.020)	13.61	99
15+15+20+20+20+22	1.71	1.45	1.93	1.93	1.93	2.12	12.80 (3.40-16.00)	3.700 (0.790-6.020)	16.25	99
15+15+20+20+20+25	1.70	1.43	1.91	1.91	1.91	2.39	13.00 (3.40-16.00)	3.800 (0.790-6.020)	16.69	99
15+15+20+20+20+35	1.60	1.40	1.87	1.87	1.87	3.28	13.30 (3.50-16.10)	3.875 (0.790-5.910)	17.02	99
15+15+20+20+20+42	1.58	1.36	1.82	1.82	1.82	3.82	13.90 (3.50-16.50)	3.725 (0.770-5.310)	16.36	99
15+15+20+20+20+50	1.50	1.31	1.74	1.74	1.74	4.36	14.00 (3.50-16.50)	3.686 (0.760-5.190)	16.19	99
15+15+20+20+20+60	1.40	1.22	1.63	1.63	1.63	4.88	14.00 (3.50-16.50)	3.682 (0.760-5.190)	16.17	99
15+15+20+20+20+71	1.30	1.14	1.52	1.52	1.52	5.38	14.00 (3.50-16.50)	3.674 (0.760-5.180)	16.14	99
15+15+20+20+22+22	1.79	1.43	1.91	1.91	2.10	2.10	13.60 (3.50-16.30)	3.800 (0.780-5.610)	16.69	99
15+15+20+20+22+25	1.77	1.44	1.91	1.91	2.11	2.39	13.80 (3.50-16.40)	3.750 (0.770-5.410)	16.47	99
15+15+20+20+22+35	1.64	1.39	1.86	1.86	2.04	3.25	13.90 (3.50-16.50)	3.725 (0.770-5.310)	16.36	99
15+15+20+20+22+42	1.57	1.35	1.81	1.81	1.99	3.79	14.00 (3.50-16.50)	3.691 (0.760-5.200)	16.21	99
15+15+20+20+22+50	1.48	1.29	1.72	1.72	1.89	4.30	14.00 (3.50-16.50)	3.677 (0.760-5.180)	16.15	99
15+15+20+20+22+60	1.38	1.20	1.61	1.61	1.77	4.82	14.00 (3.50-16.50)	3.671 (0.760-5.180)	16.12	99
15+15+20+20+22+71	1.29	1.12	1.50	1.50	1.65	5.31	14.00 (3.50-16.50)	3.665 (0.760-5.170)	16.09	99
15+15+20+20+25+25	1.74	1.43	1.90	1.90	2.38	2.38	13.90 (3.50-16.50)	3.725 (0.770-5.310)	16.36	99
15+15+20+20+25+35	1.60	1.37	1.83	1.83	2.29	3.20	13.90 (3.50-16.50)	3.725 (0.770-5.310)	16.36	99
15+15+20+20+25+42	1.53	1.32	1.77	1.77	2.21	3.71	14.00 (3.50-16.50)	3.688 (0.760-5.190)	16.20	99
15+15+20+20+25+50	1.45	1.26	1.68	1.68	2.10	4.21	14.00 (3.50-16.50)	3.674 (0.760-5.180)	16.14	99
15+15+20+20+25+60	1.35	1.18	1.57	1.57	1.97	4.72	14.00 (3.50-16.50)	3.667 (0.760-5.170)	16.11	99
15+15+20+20+25+71	1.27	1.10	1.47	1.47	1.84	5.22	14.00 (3.50-16.50)	3.661 (0.760-5.170)	16.08	99
15+15+20+20+35+35	1.50	1.31	1.74	1.74	3.05	3.05	14.00 (3.50-16.50)	3.697 (0.760-5.200)	16.24	99
15+15+20+20+35+42	1.43	1.24	1.66	1.66	2.90	3.49	14.00 (3.50-16.50)	3.686 (0.760-5.190)	16.19	99
15+15+20+20+35+50	1.35	1.18	1.57	1.57	2.75	3.94	14.00 (3.50-16.50)	3.671 (0.760-5.180)	16.12	99
15+15+20+20+35+60	1.27	1.11	1.48	1.48	2.59	4.44	14.00 (3.50-16.50)	3.664 (0.760-5.170)	16.09	99
15+15+20+20+35+71	1.19	1.04	1.39	1.39	2.43	4.92	14.00 (3.50-16.50)	3.661 (0.760-5.170)	16.08	99
15+15+20+20+42+42	1.36	1.19	1.58	1.58	3.33	3.33	14.00 (3.50-16.50)	3.674 (0.760-5.180)	16.14	99
15+15+20+20+42+50	1.30	1.13	1.51	1.51	3.16	3.77	14.00 (3.50-16.50)	3.661 (0.760-5.170)	16.08	99
15+15+20+20+42+60	1.22	1.06	1.42	1.42	2.98	4.26	14.00 (3.50-16.50)	3.652 (0.760-5.160)	16.04	99
15+15+20+20+50+50	1.24	1.08	1.44	1.44	3.59	3.59	14.00 (3.50-16.50)	3.645 (0.760-5.150)	16.01	99
15+15+20+20+50+60	1.17	1.02	1.36	1.36	3.39	4.07	14.00 (3.50-16.50)	3.638 (0.760-5.150)	15.98	99
15+15+20+22+22+22	1.81	1.44	1.91	2.11	2.11	2.11	14.00 (3.50-16.50)	3.699 (0.760-5.200)	16.25	99
15+15+20+22+22+25	1.76	1.42	1.90	2.09	2.09	2.37	14.00 (3.50-16.50)	3.697 (0.760-5.200)	16.24	99
15+15+20+22+22+35	1.63	1.38	1.84	2.03	2.03	3.23	14.00 (3.50-16.50)	3.695 (0.760-5.200)	16.23	99
15+15+20+22+22+42	1.54	1.33	1.78	1.96	1.96	3.74	14.00 (3.50-16.50)	3.682 (0.760-5.190)	16.17	99
15+15+20+22+22+50	1.46	1.27	1.69	1.86	1.86	4.24	14.00 (3.50-16.50)	3.667 (0.760-5.170)	16.11	99
15+15+20+22+22+60	1.36	1.19	1.58	1.74	1.74	4.75	14.00 (3.50-16.50)	3.661 (0.760-5.170)	16.08	99

MXZ-6C122VA HEATING

Indoor units combination	Heating Capacity (kW)							Outdoor unit power consumption (kW)	Current (A)	Power factor (%)
	Unit A	Unit B	Unit C	Unit D	Unit E	Unit F	Total			
15+15+20+22+22+71	1.27	1.11	1.48	1.63	1.63	5.25	14.00 (3.50-16.50)	3.656 (0.760-5.160)	16.05	99
15+15+20+22+25+25	1.72	1.41	1.89	2.07	2.36	2.36	14.00 (3.50-16.50)	3.695 (0.760-5.200)	16.23	99
15+15+20+22+25+35	1.59	1.36	1.82	2.00	2.27	3.18	14.00 (3.50-16.50)	3.691 (0.760-5.200)	16.21	99
15+15+20+22+25+42	1.51	1.32	1.76	1.93	2.19	3.69	14.00 (3.50-16.50)	3.682 (0.760-5.190)	16.17	99
15+15+20+22+25+50	1.43	1.24	1.66	1.83	2.07	4.15	14.00 (3.50-16.50)	3.665 (0.760-5.170)	16.09	99
15+15+20+22+25+60	1.34	1.17	1.55	1.71	1.94	4.66	14.00 (3.50-16.50)	3.661 (0.760-5.170)	16.08	99
15+15+20+22+25+71	1.25	1.09	1.45	1.60	1.82	5.16	14.00 (3.50-16.50)	3.652 (0.760-5.160)	16.04	99
15+15+20+22+35+35	1.48	1.29	1.72	1.89	3.01	3.01	14.00 (3.50-16.50)	3.688 (0.760-5.190)	16.20	99
15+15+20+22+35+42	1.41	1.23	1.64	1.80	2.87	3.44	14.00 (3.50-16.50)	3.677 (0.760-5.180)	16.15	99
15+15+20+22+35+50	1.34	1.17	1.55	1.71	2.72	3.89	14.00 (3.50-16.50)	3.661 (0.760-5.170)	16.08	99
15+15+20+22+35+60	1.26	1.10	1.46	1.61	2.56	4.38	14.00 (3.50-16.50)	3.656 (0.760-5.160)	16.05	99
15+15+20+22+35+71	1.18	1.03	1.37	1.51	2.40	4.87	14.00 (3.50-16.50)	3.650 (0.760-5.160)	16.03	99
15+15+20+22+42+42	1.35	1.17	1.56	1.72	3.28	3.28	14.00 (3.50-16.50)	3.665 (0.760-5.170)	16.09	99
15+15+20+22+42+50	1.28	1.12	1.49	1.64	3.12	3.72	14.00 (3.50-16.50)	3.650 (0.760-5.160)	16.03	99
15+15+20+22+42+60	1.21	1.05	1.40	1.54	2.94	4.21	14.00 (3.50-16.50)	3.645 (0.760-5.150)	16.01	99
15+15+20+22+50+50	1.22	1.06	1.42	1.56	3.55	3.55	14.00 (3.50-16.50)	3.636 (0.760-5.150)	15.97	99
15+15+20+25+25+25	1.68	1.40	1.87	2.34	2.34	2.34	14.00 (3.50-16.50)	3.695 (0.760-5.200)	16.23	99
15+15+20+25+25+35	1.56	1.34	1.79	2.24	2.24	3.14	14.00 (3.50-16.50)	3.690 (0.760-5.200)	16.21	99
15+15+20+25+25+42	1.48	1.29	1.72	2.15	2.15	3.61	14.00 (3.50-16.50)	3.677 (0.760-5.180)	16.15	99
15+15+20+25+25+50	1.40	1.22	1.63	2.03	2.03	4.07	14.00 (3.50-16.50)	3.661 (0.760-5.170)	16.08	99
15+15+20+25+25+60	1.31	1.14	1.53	1.91	1.91	4.58	14.00 (3.50-16.50)	3.656 (0.760-5.160)	16.05	99
15+15+20+25+25+71	1.23	1.07	1.43	1.78	1.78	5.07	14.00 (3.50-16.50)	3.650 (0.760-5.160)	16.03	99
15+15+20+25+35+35	1.45	1.26	1.68	2.10	2.94	2.94	14.00 (3.50-16.50)	3.686 (0.760-5.190)	16.19	99
15+15+20+25+35+42	1.38	1.20	1.61	2.01	2.81	3.37	14.00 (3.50-16.50)	3.674 (0.760-5.180)	16.14	99
15+15+20+25+35+50	1.31	1.14	1.53	1.91	2.67	3.81	14.00 (3.50-16.50)	3.661 (0.760-5.170)	16.08	99
15+15+20+25+35+60	1.24	1.08	1.44	1.79	2.51	4.31	14.00 (3.50-16.50)	3.652 (0.760-5.160)	16.04	99
15+15+20+25+42+42	1.32	1.15	1.53	1.92	3.22	3.22	14.00 (3.50-16.50)	3.661 (0.760-5.170)	16.08	99
15+15+20+25+42+50	1.26	1.10	1.46	1.83	3.07	3.65	14.00 (3.50-16.50)	3.647 (0.760-5.150)	16.02	99
15+15+20+25+42+60	1.19	1.03	1.38	1.72	2.89	4.14	14.00 (3.50-16.50)	3.641 (0.760-5.150)	15.99	99
15+15+20+25+50+50	1.20	1.05	1.39	1.74	3.49	3.49	14.00 (3.50-16.50)	3.633 (0.760-5.150)	15.96	99
15+15+20+35+35+35	1.35	1.18	1.57	2.75	2.75	2.75	14.00 (3.50-16.50)	3.682 (0.760-5.190)	16.17	99
15+15+20+35+35+42	1.30	1.13	1.51	2.64	2.64	3.16	14.00 (3.50-16.50)	3.671 (0.760-5.180)	16.12	99
15+15+20+35+35+50	1.24	1.08	1.44	2.51	2.51	3.59	14.00 (3.50-16.50)	3.655 (0.760-5.160)	16.05	99
15+15+20+35+35+60	1.17	1.02	1.36	2.37	2.37	4.07	14.00 (3.50-16.50)	3.650 (0.760-5.160)	16.03	99
15+15+20+35+42+42	1.24	1.08	1.44	2.53	3.03	3.03	14.00 (3.50-16.50)	3.661 (0.760-5.170)	16.08	99
15+15+20+35+42+50	1.19	1.03	1.38	2.41	2.89	3.45	14.00 (3.50-16.50)	3.645 (0.760-5.150)	16.01	99
15+15+20+42+42+42	1.19	1.04	1.39	2.91	2.91	2.91	14.00 (3.50-16.50)	3.647 (0.760-5.150)	16.02	99
15+15+22+22+22+22	1.78	1.42	2.09	2.09	2.09	2.09	14.00 (3.50-16.50)	3.690 (0.760-5.200)	16.21	99
15+15+22+22+22+25	1.74	1.43	2.09	2.09	2.09	2.38	14.00 (3.50-16.50)	3.688 (0.760-5.190)	16.20	99
15+15+22+22+22+35	1.60	1.37	2.02	2.02	2.02	3.21	14.00 (3.50-16.50)	3.686 (0.760-5.190)	16.19	99
15+15+22+22+22+42	1.52	1.33	1.94	1.94	1.94	3.71	14.00 (3.50-16.50)	3.672 (0.760-5.180)	16.13	99
15+15+22+22+22+50	1.44	1.25	1.84	1.84	1.84	4.18	14.00 (3.50-16.50)	3.657 (0.760-5.160)	16.06	99
15+15+22+22+22+60	1.35	1.17	1.72	1.72	1.72	4.69	14.00 (3.50-16.50)	3.652 (0.760-5.160)	16.04	99
15+15+22+22+22+71	1.26	1.10	1.61	1.61	1.61	5.19	14.00 (3.50-16.50)	3.646 (0.760-5.150)	16.01	99
15+15+22+22+25+25	1.69	1.40	2.06	2.06	2.34	2.34	14.00 (3.50-16.50)	3.686 (0.760-5.190)	16.19	99
15+15+22+22+25+35	1.57	1.35	1.99	1.99	2.26	3.16	14.00 (3.50-16.50)	3.682 (0.760-5.190)	16.17	99

MXZ-6C122VA HEATING

Indoor units combination	Heating Capacity (kW)							Outdoor unit power consumption (kW)	Current (A)	Power factor (%)
	Unit A	Unit B	Unit C	Unit D	Unit E	Unit F	Total			
15+15+22+22+25+42	1.49	1.30	1.90	1.90	2.16	3.63	14.00 (3.50-16.50)	3.671 (0.760-5.180)	16.12	99
15+15+22+22+25+50	1.41	1.23	1.80	1.80	2.05	4.09	14.00 (3.50-16.50)	3.655 (0.760-5.160)	16.05	99
15+15+22+22+25+60	1.32	1.15	1.69	1.69	1.92	4.60	14.00 (3.50-16.50)	3.650 (0.760-5.160)	16.03	99
15+15+22+22+25+71	1.24	1.08	1.58	1.58	1.79	5.10	14.00 (3.50-16.50)	3.645 (0.760-5.150)	16.01	99
15+15+22+22+35+35	1.46	1.27	1.86	1.86	2.97	2.97	14.00 (3.50-16.50)	3.679 (0.760-5.180)	16.16	99
15+15+22+22+35+42	1.39	1.21	1.78	1.78	2.83	3.39	14.00 (3.50-16.50)	3.667 (0.760-5.170)	16.11	99
15+15+22+22+35+50	1.32	1.15	1.69	1.69	2.69	3.84	14.00 (3.50-16.50)	3.652 (0.760-5.160)	16.04	99
15+15+22+22+35+60	1.24	1.08	1.59	1.59	2.53	4.33	14.00 (3.50-16.50)	3.646 (0.760-5.150)	16.01	99
15+15+22+22+35+71	1.17	1.02	1.49	1.49	2.37	4.81	14.00 (3.50-16.50)	3.640 (0.760-5.150)	15.99	99
15+15+22+22+42+42	1.33	1.16	1.70	1.70	3.24	3.24	14.00 (3.50-16.50)	3.655 (0.760-5.160)	16.05	99
15+15+22+22+42+50	1.27	1.10	1.62	1.62	3.09	3.67	14.00 (3.50-16.50)	3.640 (0.760-5.150)	15.99	99
15+15+22+22+42+60	1.19	1.04	1.53	1.53	2.91	4.16	14.00 (3.50-16.50)	3.636 (0.760-5.150)	15.97	99
15+15+22+22+50+50	1.21	1.05	1.54	1.54	3.51	3.51	14.00 (3.50-16.50)	3.626 (0.760-5.150)	15.93	99
15+15+22+25+25+25	1.65	1.39	2.04	2.32	2.32	2.32	14.00 (3.50-16.50)	3.686 (0.760-5.190)	16.19	99
15+15+22+25+25+35	1.53	1.32	1.94	2.21	2.21	3.09	14.00 (3.50-16.50)	3.682 (0.760-5.190)	16.17	99
15+15+22+25+25+42	1.46	1.27	1.86	2.12	2.12	3.56	14.00 (3.50-16.50)	3.670 (0.760-5.180)	16.12	99
15+15+22+25+25+50	1.38	1.20	1.77	2.01	2.01	4.01	14.00 (3.50-16.50)	3.652 (0.760-5.160)	16.04	99
15+15+22+25+25+60	1.30	1.13	1.66	1.88	1.88	4.52	14.00 (3.50-16.50)	3.647 (0.760-5.150)	16.02	99
15+15+22+25+25+71	1.21	1.06	1.55	1.76	1.76	5.01	14.00 (3.50-16.50)	3.641 (0.760-5.150)	15.99	99
15+15+22+25+35+35	1.43	1.24	1.83	2.07	2.90	2.90	14.00 (3.50-16.50)	3.677 (0.760-5.180)	16.15	99
15+15+22+25+35+42	1.36	1.19	1.74	1.98	2.77	3.33	14.00 (3.50-16.50)	3.665 (0.760-5.170)	16.09	99
15+15+22+25+35+50	1.30	1.13	1.66	1.88	2.64	3.77	14.00 (3.50-16.50)	3.650 (0.760-5.160)	16.03	99
15+15+22+25+35+60	1.22	1.06	1.56	1.77	2.48	4.26	14.00 (3.50-16.50)	3.645 (0.760-5.150)	16.01	99
15+15+22+25+42+42	1.30	1.14	1.67	1.89	3.18	3.18	14.00 (3.50-16.50)	3.652 (0.760-5.160)	16.04	99
15+15+22+25+42+50	1.24	1.08	1.59	1.80	3.03	3.61	14.00 (3.50-16.50)	3.638 (0.760-5.150)	15.98	99
15+15+22+25+42+60	1.17	1.02	1.50	1.70	2.86	4.09	14.00 (3.50-16.50)	3.633 (0.760-5.150)	15.96	99
15+15+22+25+50+50	1.19	1.03	1.52	1.72	3.45	3.45	14.00 (3.50-16.50)	3.624 (0.760-5.150)	15.92	99
15+15+22+35+35+35	1.34	1.17	1.71	2.72	2.72	2.72	14.00 (3.50-16.50)	3.674 (0.760-5.180)	16.14	99
15+15+22+35+35+42	1.28	1.12	1.64	2.60	2.60	3.12	14.00 (3.50-16.50)	3.661 (0.760-5.170)	16.08	99
15+15+22+35+35+50	1.22	1.06	1.56	2.48	2.48	3.55	14.00 (3.50-16.50)	3.646 (0.760-5.150)	16.01	99
15+15+22+35+42+42	1.23	1.07	1.57	2.50	3.00	3.00	14.00 (3.50-16.50)	3.650 (0.760-5.160)	16.03	99
15+15+22+35+42+50	1.17	1.02	1.50	2.39	2.86	3.41	14.00 (3.50-16.50)	3.636 (0.760-5.150)	15.97	99
15+15+22+42+42+42	1.18	1.03	1.51	2.88	2.88	2.88	14.00 (3.50-16.50)	3.638 (0.760-5.150)	15.98	99
15+15+25+25+25+25	1.62	1.37	2.29	2.29	2.29	2.29	14.00 (3.50-16.50)	3.682 (0.760-5.190)	16.17	99
15+15+25+25+25+35	1.50	1.31	2.18	2.18	2.18	3.05	14.00 (3.50-16.50)	3.677 (0.760-5.180)	16.15	99
15+15+25+25+25+42	1.43	1.24	2.07	2.07	2.07	3.49	14.00 (3.50-16.50)	3.665 (0.760-5.170)	16.09	99
15+15+25+25+25+50	1.35	1.18	1.97	1.97	1.97	3.94	14.00 (3.50-16.50)	3.650 (0.760-5.160)	16.03	99
15+15+25+25+25+60	1.27	1.11	1.85	1.85	1.85	4.44	14.00 (3.50-16.50)	3.645 (0.760-5.150)	16.01	99
15+15+25+25+25+71	1.19	1.04	1.73	1.73	1.73	4.92	14.00 (3.50-16.50)	3.639 (0.760-5.150)	15.98	99
15+15+25+25+35+35	1.40	1.22	2.03	2.03	2.85	2.85	14.00 (3.50-16.50)	3.674 (0.760-5.180)	16.14	99
15+15+25+25+35+42	1.34	1.17	1.94	1.94	2.72	3.26	14.00 (3.50-16.50)	3.661 (0.760-5.170)	16.08	99
15+15+25+25+35+50	1.27	1.11	1.85	1.85	2.59	3.70	14.00 (3.50-16.50)	3.647 (0.760-5.150)	16.02	99
15+15+25+25+35+60	1.20	1.05	1.74	1.74	2.44	4.18	14.00 (3.50-16.50)	3.641 (0.760-5.150)	15.99	99
15+15+25+25+42+42	1.28	1.12	1.86	1.86	3.12	3.12	14.00 (3.50-16.50)	3.650 (0.760-5.160)	16.03	99
15+15+25+25+42+50	1.22	1.06	1.77	1.77	2.98	3.55	14.00 (3.50-16.50)	3.636 (0.760-5.150)	15.97	99
15+15+25+25+50+50	1.17	1.02	1.69	1.69	3.39	3.39	14.00 (3.50-16.50)	3.622 (0.760-5.150)	15.90	99

MXZ-6C122VA HEATING

Indoor units combination	Heating Capacity (kW)							Outdoor unit power consumption (kW)	Current (A)	Power factor (%)
	Unit A	Unit B	Unit C	Unit D	Unit E	Unit F	Total			
15+15+25+35+35+35	1.31	1.14	1.91	2.67	2.67	2.67	14.00 (3.50-16.50)	3.671 (0.760-5.180)	16.12	99
15+15+25+35+35+42	1.26	1.10	1.83	2.56	2.56	3.07	14.00 (3.50-16.50)	3.661 (0.760-5.170)	16.08	99
15+15+25+35+35+50	1.20	1.05	1.74	2.44	2.44	3.49	14.00 (3.50-16.50)	3.645 (0.760-5.150)	16.01	99
15+15+25+35+42+42	1.21	1.05	1.75	2.45	2.94	2.94	14.00 (3.50-16.50)	3.647 (0.760-5.150)	16.02	99
15+15+35+35+35+35	1.24	1.08	2.51	2.51	2.51	2.51	14.00 (3.50-16.50)	3.667 (0.760-5.170)	16.11	99
15+15+35+35+35+42	1.19	1.03	2.41	2.41	2.41	2.89	14.00 (3.50-16.50)	3.655 (0.760-5.160)	16.05	99
15+20+20+20+20+20	1.59	1.91	1.91	1.91	1.91	1.91	12.20 (3.40-16.00)	3.400 (0.790-6.020)	14.93	99
15+20+20+20+20+22	1.69	1.91	1.91	1.91	1.91	2.11	13.20 (3.40-16.00)	3.900 (0.790-6.010)	17.13	99
15+20+20+20+20+25	1.68	1.90	1.90	1.90	1.90	2.38	13.40 (3.50-16.20)	3.850 (0.790-5.810)	16.91	99
15+20+20+20+20+35	1.58	1.83	1.83	1.83	1.83	3.20	13.70 (3.50-16.40)	3.775 (0.780-5.510)	16.58	99
15+20+20+20+20+42	1.53	1.77	1.77	1.77	1.77	3.71	14.00 (3.50-16.50)	3.697 (0.760-5.200)	16.24	99
15+20+20+20+20+50	1.45	1.68	1.68	1.68	1.68	4.21	14.00 (3.50-16.50)	3.682 (0.760-5.190)	16.17	99
15+20+20+20+20+60	1.35	1.57	1.57	1.57	1.57	4.72	14.00 (3.50-16.50)	3.677 (0.760-5.180)	16.15	99
15+20+20+20+20+71	1.27	1.47	1.47	1.47	1.47	5.22	14.00 (3.50-16.50)	3.670 (0.760-5.180)	16.12	99
15+20+20+20+22+22	1.75	1.90	1.90	1.90	2.09	2.09	13.90 (3.50-16.50)	3.725 (0.770-5.310)	16.36	99
15+20+20+20+22+25	1.71	1.89	1.89	1.89	2.07	2.36	13.90 (3.50-16.50)	3.725 (0.770-5.310)	16.36	99
15+20+20+20+22+35	1.59	1.82	1.82	1.82	2.00	3.18	14.00 (3.50-16.50)	3.699 (0.760-5.200)	16.25	99
15+20+20+20+22+42	1.51	1.76	1.76	1.76	1.93	3.69	14.00 (3.50-16.50)	3.688 (0.760-5.190)	16.20	99
15+20+20+20+22+50	1.43	1.66	1.66	1.66	1.83	4.15	14.00 (3.50-16.50)	3.671 (0.760-5.180)	16.12	99
15+20+20+20+22+60	1.34	1.55	1.55	1.55	1.71	4.66	14.00 (3.50-16.50)	3.666 (0.760-5.170)	16.10	99
15+20+20+20+22+71	1.25	1.45	1.45	1.45	1.60	5.16	14.00 (3.50-16.50)	3.661 (0.760-5.170)	16.08	99
15+20+20+20+25+25	1.68	1.87	1.87	1.87	2.34	2.34	14.00 (3.50-16.50)	3.699 (0.760-5.200)	16.25	99
15+20+20+20+25+35	1.56	1.79	1.79	1.79	2.24	3.14	14.00 (3.50-16.50)	3.697 (0.760-5.200)	16.24	99
15+20+20+20+25+42	1.48	1.72	1.72	1.72	2.15	3.61	14.00 (3.50-16.50)	3.686 (0.760-5.190)	16.19	99
15+20+20+20+25+50	1.40	1.63	1.63	1.63	2.03	4.07	14.00 (3.50-16.50)	3.670 (0.760-5.180)	16.12	99
15+20+20+20+25+60	1.31	1.53	1.53	1.53	1.91	4.58	14.00 (3.50-16.50)	3.663 (0.760-5.170)	16.09	99
15+20+20+20+25+71	1.23	1.43	1.43	1.43	1.78	5.07	14.00 (3.50-16.50)	3.657 (0.760-5.160)	16.06	99
15+20+20+20+35+35	1.45	1.68	1.68	1.68	2.94	2.94	14.00 (3.50-16.50)	3.695 (0.760-5.200)	16.23	99
15+20+20+20+35+42	1.38	1.61	1.61	1.61	2.81	3.37	14.00 (3.50-16.50)	3.682 (0.760-5.190)	16.17	99
15+20+20+20+35+50	1.31	1.53	1.53	1.53	2.67	3.81	14.00 (3.50-16.50)	3.666 (0.760-5.170)	16.10	99
15+20+20+20+35+60	1.24	1.44	1.44	1.44	2.51	4.31	14.00 (3.50-16.50)	3.661 (0.760-5.170)	16.08	99
15+20+20+20+42+42	1.32	1.53	1.53	1.53	3.22	3.22	14.00 (3.50-16.50)	3.670 (0.760-5.180)	16.12	99
15+20+20+20+42+50	1.26	1.46	1.46	1.46	3.07	3.65	14.00 (3.50-16.50)	3.655 (0.760-5.160)	16.05	99
15+20+20+20+42+60	1.19	1.38	1.38	1.38	2.89	4.14	14.00 (3.50-16.50)	3.648 (0.760-5.150)	16.02	99
15+20+20+20+50+50	1.20	1.39	1.39	1.39	3.49	3.49	14.00 (3.50-16.50)	3.640 (0.760-5.150)	15.99	99
15+20+20+22+22+22	1.74	1.90	1.90	2.09	2.09	2.09	14.00 (3.50-16.50)	3.695 (0.760-5.200)	16.23	99
15+20+20+22+22+25	1.69	1.87	1.87	2.06	2.06	2.34	14.00 (3.50-16.50)	3.695 (0.760-5.200)	16.23	99
15+20+20+22+22+35	1.57	1.81	1.81	1.99	1.99	3.16	14.00 (3.50-16.50)	3.690 (0.760-5.200)	16.21	99
15+20+20+22+22+42	1.49	1.73	1.73	1.90	1.90	3.63	14.00 (3.50-16.50)	3.679 (0.760-5.180)	16.16	99
15+20+20+22+22+50	1.41	1.64	1.64	1.80	1.80	4.09	14.00 (3.50-16.50)	3.663 (0.760-5.170)	16.09	99
15+20+20+22+22+60	1.32	1.53	1.53	1.69	1.69	4.60	14.00 (3.50-16.50)	3.657 (0.760-5.160)	16.06	99
15+20+20+22+22+71	1.24	1.44	1.44	1.58	1.58	5.10	14.00 (3.50-16.50)	3.652 (0.760-5.160)	16.04	99
15+20+20+22+25+25	1.65	1.86	1.86	2.04	2.32	2.32	14.00 (3.50-16.50)	3.690 (0.760-5.200)	16.21	99
15+20+20+22+25+35	1.53	1.77	1.77	1.94	2.21	3.09	14.00 (3.50-16.50)	3.688 (0.760-5.190)	16.20	99
15+20+20+22+25+42	1.46	1.69	1.69	1.86	2.12	3.56	14.00 (3.50-16.50)	3.677 (0.760-5.180)	16.15	99
15+20+20+22+25+50	1.38	1.61	1.61	1.77	2.01	4.01	14.00 (3.50-16.50)	3.661 (0.760-5.170)	16.08	99

MXZ-6C122VA HEATING

Indoor units combination	Heating Capacity (kW)							Outdoor unit power consumption (kW)	Current (A)	Power factor (%)
	Unit A	Unit B	Unit C	Unit D	Unit E	Unit F	Total			
15+25+35+35+35+35	1.17	1.69	2.37	2.37	2.37	2.37	14.00 (3.50-16.50)	3.651 (0.760-5.160)	16.03	99
20+20+20+20+20+20	2.12	1.90	1.90	1.90	1.90	1.90	12.70 (3.40-16.00)	3.650 (0.790-6.020)	16.03	99
20+20+20+20+20+22	2.21	1.89	1.89	1.89	1.89	2.07	13.50 (3.50-16.20)	3.825 (0.780-5.710)	16.80	99
20+20+20+20+20+25	2.19	1.87	1.87	1.87	1.87	2.34	13.70 (3.50-16.40)	3.775 (0.780-5.510)	16.58	99
20+20+20+20+20+35	2.06	1.79	1.79	1.79	1.79	3.14	13.90 (3.50-16.50)	3.725 (0.770-5.310)	16.36	99
20+20+20+20+20+42	1.97	1.72	1.72	1.72	1.72	3.61	14.00 (3.50-16.50)	3.695 (0.760-5.200)	16.23	99
20+20+20+20+20+50	1.87	1.63	1.63	1.63	1.63	4.07	14.00 (3.50-16.50)	3.677 (0.760-5.180)	16.15	99
20+20+20+20+20+60	1.75	1.53	1.53	1.53	1.53	4.58	14.00 (3.50-16.50)	3.671 (0.760-5.180)	16.12	99
20+20+20+20+20+71	1.64	1.43	1.43	1.43	1.43	5.07	14.00 (3.50-16.50)	3.665 (0.760-5.170)	16.09	99
20+20+20+20+22+22	2.26	1.87	1.87	1.87	2.06	2.06	14.00 (3.50-16.50)	3.700 (0.760-5.200)	16.25	99
20+20+20+20+22+25	2.20	1.86	1.86	1.86	2.04	2.32	14.00 (3.50-16.50)	3.697 (0.760-5.200)	16.24	99
20+20+20+20+22+35	2.04	1.77	1.77	1.77	1.94	3.09	14.00 (3.50-16.50)	3.695 (0.760-5.200)	16.23	99
20+20+20+20+22+42	1.94	1.69	1.69	1.69	1.86	3.56	14.00 (3.50-16.50)	3.686 (0.760-5.190)	16.19	99
20+20+20+20+22+50	1.84	1.61	1.61	1.61	1.77	4.01	14.00 (3.50-16.50)	3.667 (0.760-5.170)	16.11	99
20+20+20+20+22+60	1.73	1.51	1.51	1.51	1.66	4.52	14.00 (3.50-16.50)	3.661 (0.760-5.170)	16.08	99
20+20+20+20+22+71	1.62	1.41	1.41	1.41	1.55	5.01	14.00 (3.50-16.50)	3.656 (0.760-5.160)	16.05	99
20+20+20+20+25+25	2.15	1.83	1.83	1.83	2.29	2.29	14.00 (3.50-16.50)	3.695 (0.760-5.200)	16.23	99
20+20+20+20+25+35	2.00	1.74	1.74	1.74	2.18	3.05	14.00 (3.50-16.50)	3.695 (0.760-5.200)	16.23	99
20+20+20+20+25+42	1.90	1.66	1.66	1.66	2.07	3.49	14.00 (3.50-16.50)	3.682 (0.760-5.190)	16.17	99
20+20+20+20+25+50	1.81	1.57	1.57	1.57	1.97	3.94	14.00 (3.50-16.50)	3.665 (0.760-5.170)	16.09	99
20+20+20+20+25+60	1.70	1.48	1.48	1.48	1.85	4.44	14.00 (3.50-16.50)	3.661 (0.760-5.170)	16.08	99
20+20+20+20+25+71	1.59	1.39	1.39	1.39	1.73	4.92	14.00 (3.50-16.50)	3.653 (0.760-5.160)	16.04	99
20+20+20+20+35+35	1.87	1.63	1.63	1.63	2.85	2.85	14.00 (3.50-16.50)	3.688 (0.760-5.190)	16.20	99
20+20+20+20+35+42	1.78	1.55	1.55	1.55	2.72	3.26	14.00 (3.50-16.50)	3.677 (0.760-5.180)	16.15	99
20+20+20+20+35+50	1.70	1.48	1.48	1.48	2.59	3.70	14.00 (3.50-16.50)	3.661 (0.760-5.170)	16.08	99
20+20+20+20+35+60	1.60	1.39	1.39	1.39	2.44	4.18	14.00 (3.50-16.50)	3.656 (0.760-5.160)	16.05	99
20+20+20+20+42+42	1.71	1.49	1.49	1.49	3.12	3.12	14.00 (3.50-16.50)	3.665 (0.760-5.170)	16.09	99
20+20+20+20+42+50	1.63	1.42	1.42	1.42	2.98	3.55	14.00 (3.50-16.50)	3.650 (0.760-5.160)	16.03	99
20+20+20+20+50+50	1.56	1.36	1.36	1.36	3.39	3.39	14.00 (3.50-16.50)	3.636 (0.760-5.150)	15.97	99
20+20+20+22+22+22	2.22	1.86	1.86	2.04	2.04	2.04	14.00 (3.50-16.50)	3.691 (0.760-5.200)	16.21	99
20+20+20+22+22+25	2.17	1.84	1.84	2.03	2.03	2.31	14.00 (3.50-16.50)	3.688 (0.760-5.190)	16.20	99
20+20+20+22+22+35	2.01	1.76	1.76	1.93	1.93	3.07	14.00 (3.50-16.50)	3.686 (0.760-5.190)	16.19	99
20+20+20+22+22+42	1.92	1.67	1.67	1.84	1.84	3.51	14.00 (3.50-16.50)	3.674 (0.760-5.180)	16.14	99
20+20+20+22+22+50	1.82	1.58	1.58	1.74	1.74	3.96	14.00 (3.50-16.50)	3.661 (0.760-5.170)	16.08	99
20+20+20+22+22+60	1.71	1.49	1.49	1.64	1.64	4.46	14.00 (3.50-16.50)	3.652 (0.760-5.160)	16.04	99
20+20+20+22+22+71	1.60	1.39	1.39	1.53	1.53	4.95	14.00 (3.50-16.50)	3.647 (0.760-5.150)	16.02	99
20+20+20+22+25+25	2.12	1.82	1.82	2.00	2.27	2.27	14.00 (3.50-16.50)	3.686 (0.760-5.190)	16.19	99
20+20+20+22+25+35	1.97	1.72	1.72	1.89	2.15	3.01	14.00 (3.50-16.50)	3.686 (0.760-5.190)	16.19	99
20+20+20+22+25+42	1.88	1.64	1.64	1.80	2.05	3.44	14.00 (3.50-16.50)	3.671 (0.760-5.180)	16.12	99
20+20+20+22+25+50	1.78	1.55	1.55	1.71	1.94	3.89	14.00 (3.50-16.50)	3.656 (0.760-5.160)	16.05	99
20+20+20+22+25+60	1.68	1.46	1.46	1.61	1.83	4.38	14.00 (3.50-16.50)	3.650 (0.760-5.160)	16.03	99
20+20+20+22+25+71	1.57	1.37	1.37	1.51	1.71	4.87	14.00 (3.50-16.50)	3.645 (0.760-5.150)	16.01	99
20+20+20+22+35+35	1.84	1.61	1.61	1.77	2.81	2.81	14.00 (3.50-16.50)	3.682 (0.760-5.190)	16.17	99
20+20+20+22+35+42	1.76	1.53	1.53	1.69	2.69	3.22	14.00 (3.50-16.50)	3.667 (0.760-5.170)	16.11	99
20+20+20+22+35+50	1.68	1.46	1.46	1.61	2.56	3.65	14.00 (3.50-16.50)	3.652 (0.760-5.160)	16.04	99
20+20+20+22+35+60	1.58	1.38	1.38	1.52	2.41	4.14	14.00 (3.50-16.50)	3.647 (0.760-5.150)	16.02	99

MXZ-6C122VA HEATING

Indoor units combination	Heating Capacity (kW)							Outdoor unit power consumption (kW)	Current (A)	Power factor (%)
	Unit A	Unit B	Unit C	Unit D	Unit E	Unit F	Total			
15+20+22+22+50+50	1.17	1.36	1.50	1.50	3.41	3.41	14.00 (3.50-16.50)	3.622 (0.760-5.150)	15.91	99
15+20+22+25+25+25	1.59	1.82	2.00	2.27	2.27	2.27	14.00 (3.50-16.50)	3.679 (0.760-5.180)	16.16	99
15+20+22+25+25+35	1.48	1.72	1.89	2.15	2.15	3.01	14.00 (3.50-16.50)	3.677 (0.760-5.180)	16.15	99
15+20+22+25+25+42	1.41	1.64	1.80	2.05	2.05	3.44	14.00 (3.50-16.50)	3.663 (0.760-5.170)	16.09	99
15+20+22+25+25+50	1.34	1.55	1.71	1.94	1.94	3.89	14.00 (3.50-16.50)	3.648 (0.760-5.150)	16.02	99
15+20+22+25+25+60	1.26	1.46	1.61	1.83	1.83	4.38	14.00 (3.50-16.50)	3.643 (0.760-5.150)	16.00	99
15+20+22+25+25+71	1.18	1.37	1.51	1.71	1.71	4.87	14.00 (3.50-16.50)	3.638 (0.760-5.150)	15.98	99
15+20+22+25+35+35	1.38	1.61	1.77	2.01	2.81	2.81	14.00 (3.50-16.50)	3.671 (0.760-5.180)	16.12	99
15+20+22+25+35+42	1.32	1.53	1.69	1.92	2.69	3.22	14.00 (3.50-16.50)	3.661 (0.760-5.170)	16.08	99
15+20+22+25+35+50	1.26	1.46	1.61	1.83	2.56	3.65	14.00 (3.50-16.50)	3.645 (0.760-5.150)	16.01	99
15+20+22+25+35+60	1.19	1.38	1.52	1.72	2.41	4.14	14.00 (3.50-16.50)	3.640 (0.760-5.150)	15.99	99
15+20+22+25+42+42	1.27	1.47	1.62	1.84	3.09	3.09	14.00 (3.50-16.50)	3.648 (0.760-5.150)	16.02	99
15+20+22+25+42+50	1.21	1.40	1.54	1.75	2.94	3.51	14.00 (3.50-16.50)	3.634 (0.760-5.150)	15.96	99
15+20+22+35+35+35	1.30	1.51	1.66	2.64	2.64	2.64	14.00 (3.50-16.50)	3.670 (0.760-5.180)	16.12	99
15+20+22+35+35+42	1.24	1.44	1.59	2.53	2.53	3.03	14.00 (3.50-16.50)	3.657 (0.760-5.160)	16.06	99
15+20+22+35+35+50	1.19	1.38	1.52	2.41	2.41	3.45	14.00 (3.50-16.50)	3.642 (0.760-5.150)	15.99	99
15+20+22+35+42+42	1.19	1.39	1.53	2.43	2.91	2.91	14.00 (3.50-16.50)	3.645 (0.760-5.150)	16.01	99
15+20+25+25+25+25	1.56	1.79	2.24	2.24	2.24	2.24	14.00 (3.50-16.50)	3.677 (0.760-5.180)	16.15	99
15+20+25+25+25+35	1.45	1.68	2.10	2.10	2.10	2.94	14.00 (3.50-16.50)	3.674 (0.760-5.180)	16.14	99
15+20+25+25+25+42	1.38	1.61	2.01	2.01	2.01	3.37	14.00 (3.50-16.50)	3.661 (0.760-5.170)	16.08	99
15+20+25+25+25+50	1.31	1.53	1.91	1.91	1.91	3.81	14.00 (3.50-16.50)	3.646 (0.760-5.150)	16.01	99
15+20+25+25+25+60	1.24	1.44	1.79	1.79	1.79	4.31	14.00 (3.50-16.50)	3.640 (0.760-5.150)	15.99	99
15+20+25+25+35+35	1.35	1.57	1.97	1.97	2.75	2.75	14.00 (3.50-16.50)	3.670 (0.760-5.180)	16.12	99
15+20+25+25+35+42	1.30	1.51	1.88	1.88	2.64	3.16	14.00 (3.50-16.50)	3.657 (0.760-5.160)	16.06	99
15+20+25+25+35+50	1.24	1.44	1.79	1.79	2.51	3.59	14.00 (3.50-16.50)	3.643 (0.760-5.150)	16.00	99
15+20+25+25+35+60	1.17	1.36	1.69	1.69	2.37	4.07	14.00 (3.50-16.50)	3.638 (0.760-5.150)	15.98	99
15+20+25+25+42+42	1.24	1.44	1.80	1.80	3.03	3.03	14.00 (3.50-16.50)	3.646 (0.760-5.150)	16.01	99
15+20+25+25+42+50	1.19	1.38	1.72	1.72	2.89	3.45	14.00 (3.50-16.50)	3.633 (0.760-5.150)	15.96	99
15+20+25+35+35+35	1.27	1.48	1.85	2.59	2.59	2.59	14.00 (3.50-16.50)	3.666 (0.760-5.170)	16.10	99
15+20+25+35+35+42	1.22	1.42	1.77	2.48	2.48	2.98	14.00 (3.50-16.50)	3.655 (0.760-5.160)	16.05	99
15+20+25+35+35+50	1.17	1.36	1.69	2.37	2.37	3.39	14.00 (3.50-16.50)	3.640 (0.760-5.150)	15.99	99
15+20+25+35+42+42	1.17	1.36	1.70	2.39	2.86	2.86	14.00 (3.50-16.50)	3.643 (0.760-5.150)	16.00	99
15+20+35+35+35+35	1.20	1.39	2.44	2.44	2.44	2.44	14.00 (3.50-16.50)	3.663 (0.760-5.170)	16.09	99
15+22+22+22+22+22	1.68	2.06	2.06	2.06	2.06	2.06	14.00 (3.50-16.50)	3.677 (0.760-5.180)	16.15	99
15+22+22+22+22+25	1.64	2.03	2.03	2.03	2.03	2.30	14.00 (3.50-16.50)	3.674 (0.760-5.180)	16.14	99
15+22+22+22+22+35	1.52	1.94	1.94	1.94	1.94	3.09	14.00 (3.50-16.50)	3.671 (0.760-5.180)	16.12	99
15+22+22+22+22+42	1.45	1.85	1.85	1.85	1.85	3.53	14.00 (3.50-16.50)	3.661 (0.760-5.170)	16.08	99
15+22+22+22+22+50	1.37	1.75	1.75	1.75	1.75	3.99	14.00 (3.50-16.50)	3.645 (0.760-5.150)	16.01	99
15+22+22+22+22+60	1.29	1.65	1.65	1.65	1.65	4.49	14.00 (3.50-16.50)	3.639 (0.760-5.150)	15.98	99
15+22+22+22+22+71	1.21	1.54	1.54	1.54	1.54	4.98	14.00 (3.50-16.50)	3.633 (0.760-5.150)	15.96	99
15+22+22+22+25+25	1.60	2.02	2.02	2.02	2.29	2.29	14.00 (3.50-16.50)	3.671 (0.760-5.180)	16.12	99
15+22+22+22+25+35	1.49	1.90	1.90	1.90	2.16	3.03	14.00 (3.50-16.50)	3.670 (0.760-5.180)	16.12	99
15+22+22+22+25+42	1.42	1.81	1.81	1.81	2.06	3.46	14.00 (3.50-16.50)	3.657 (0.760-5.160)	16.06	99
15+22+22+22+25+50	1.35	1.72	1.72	1.72	1.96	3.91	14.00 (3.50-16.50)	3.642 (0.760-5.150)	15.99	99
15+22+22+22+25+60	1.27	1.62	1.62	1.62	1.84	4.41	14.00 (3.50-16.50)	3.636 (0.760-5.150)	15.97	99
15+22+22+22+25+71	1.19	1.52	1.52	1.52	1.72	4.89	14.00 (3.50-16.50)	3.631 (0.760-5.150)	15.95	99

MXZ-6C122VA HEATING

Indoor units combination	Heating Capacity (kW)							Outdoor unit power consumption (kW)	Current (A)	Power factor (%)
	Unit A	Unit B	Unit C	Unit D	Unit E	Unit F	Total			
15+22+22+22+35+35	1.39	1.78	1.78	1.78	2.83	2.83	14.00 (3.50-16.50)	3.665 (0.760-5.170)	16.09	99
15+22+22+22+35+42	1.33	1.70	1.70	1.70	2.70	3.24	14.00 (3.50-16.50)	3.653 (0.760-5.160)	16.04	99
15+22+22+22+35+50	1.27	1.62	1.62	1.62	2.57	3.67	14.00 (3.50-16.50)	3.639 (0.760-5.150)	15.98	99
15+22+22+22+35+60	1.19	1.53	1.53	1.53	2.43	4.16	14.00 (3.50-16.50)	3.633 (0.760-5.150)	15.96	99
15+22+22+22+42+42	1.27	1.63	1.63	1.63	3.11	3.11	14.00 (3.50-16.50)	3.642 (0.760-5.150)	15.99	99
15+22+22+22+42+50	1.21	1.55	1.55	1.55	2.96	3.53	14.00 (3.50-16.50)	3.629 (0.760-5.150)	15.94	99
15+22+22+25+25+25	1.57	1.99	1.99	2.26	2.26	2.26	14.00 (3.50-16.50)	3.670 (0.760-5.180)	16.12	99
15+22+22+25+25+35	1.46	1.86	1.86	2.12	2.12	2.97	14.00 (3.50-16.50)	3.666 (0.760-5.170)	16.10	99
15+22+22+25+25+42	1.39	1.78	1.78	2.02	2.02	3.39	14.00 (3.50-16.50)	3.655 (0.760-5.160)	16.05	99
15+22+22+25+25+50	1.32	1.69	1.69	1.92	1.92	3.84	14.00 (3.50-16.50)	3.640 (0.760-5.150)	15.99	99
15+22+22+25+25+60	1.24	1.59	1.59	1.80	1.80	4.33	14.00 (3.50-16.50)	3.634 (0.760-5.150)	15.96	99
15+22+22+25+25+71	1.17	1.49	1.49	1.69	1.69	4.81	14.00 (3.50-16.50)	3.629 (0.760-5.150)	15.94	99
15+22+22+25+35+35	1.36	1.74	1.74	1.98	2.77	2.77	14.00 (3.50-16.50)	3.663 (0.760-5.170)	16.09	99
15+22+22+25+35+42	1.30	1.67	1.67	1.89	2.65	3.18	14.00 (3.50-16.50)	3.651 (0.760-5.160)	16.03	99
15+22+22+25+35+50	1.24	1.59	1.59	1.80	2.53	3.61	14.00 (3.50-16.50)	3.636 (0.760-5.150)	15.97	99
15+22+22+25+35+60	1.17	1.50	1.50	1.70	2.39	4.09	14.00 (3.50-16.50)	3.631 (0.760-5.150)	15.95	99
15+22+22+25+42+42	1.25	1.60	1.60	1.82	3.05	3.05	14.00 (3.50-16.50)	3.640 (0.760-5.150)	15.99	99
15+22+22+25+42+50	1.19	1.53	1.53	1.73	2.91	3.47	14.00 (3.50-16.50)	3.626 (0.760-5.150)	15.93	99
15+22+22+35+35+35	1.28	1.64	1.64	2.60	2.60	2.60	14.00 (3.50-16.50)	3.661 (0.760-5.170)	16.08	99
15+22+22+35+35+42	1.23	1.57	1.57	2.50	2.50	3.00	14.00 (3.50-16.50)	3.647 (0.760-5.150)	16.02	99
15+22+22+35+35+50	1.17	1.50	1.50	2.39	2.39	3.41	14.00 (3.50-16.50)	3.633 (0.760-5.150)	15.96	99
15+22+22+35+42+42	1.18	1.51	1.51	2.40	2.88	2.88	14.00 (3.50-16.50)	3.636 (0.760-5.150)	15.97	99
15+22+25+25+25+25	1.53	1.94	2.21	2.21	2.21	2.21	14.00 (3.50-16.50)	3.667 (0.760-5.170)	16.11	99
15+22+25+25+25+35	1.43	1.83	2.07	2.07	2.07	2.90	14.00 (3.50-16.50)	3.664 (0.760-5.170)	16.09	99
15+22+25+25+25+42	1.36	1.74	1.98	1.98	1.98	3.33	14.00 (3.50-16.50)	3.652 (0.760-5.160)	16.04	99
15+22+25+25+25+50	1.30	1.66	1.88	1.88	1.88	3.77	14.00 (3.50-16.50)	3.638 (0.760-5.150)	15.98	99
15+22+25+25+25+60	1.22	1.56	1.77	1.77	1.77	4.26	14.00 (3.50-16.50)	3.633 (0.760-5.150)	15.96	99
15+22+25+25+35+35	1.34	1.71	1.94	1.94	2.72	2.72	14.00 (3.50-16.50)	3.661 (0.760-5.170)	16.08	99
15+22+25+25+35+42	1.28	1.64	1.86	1.86	2.60	3.12	14.00 (3.50-16.50)	3.648 (0.760-5.150)	16.02	99
15+22+25+25+35+50	1.22	1.56	1.77	1.77	2.48	3.55	14.00 (3.50-16.50)	3.634 (0.760-5.150)	15.96	99
15+22+25+25+42+42	1.23	1.57	1.78	1.78	3.00	3.00	14.00 (3.50-16.50)	3.638 (0.760-5.150)	15.98	99
15+22+25+25+42+50	1.17	1.50	1.70	1.70	2.86	3.41	14.00 (3.50-16.50)	3.624 (0.760-5.150)	15.92	99
15+22+25+35+35+35	1.26	1.61	1.83	2.56	2.56	2.56	14.00 (3.50-16.50)	3.657 (0.760-5.160)	16.06	99
15+22+25+35+35+42	1.21	1.54	1.75	2.45	2.45	2.94	14.00 (3.50-16.50)	3.645 (0.760-5.150)	16.01	99
15+22+35+35+35+35	1.19	1.52	2.41	2.41	2.41	2.41	14.00 (3.50-16.50)	3.653 (0.760-5.160)	16.04	99
15+25+25+25+25+25	1.50	2.18	2.18	2.18	2.18	2.18	14.00 (3.50-16.50)	3.664 (0.760-5.170)	16.09	99
15+25+25+25+25+35	1.40	2.03	2.03	2.03	2.03	2.85	14.00 (3.50-16.50)	3.661 (0.760-5.170)	16.08	99
15+25+25+25+25+42	1.34	1.94	1.94	1.94	1.94	3.26	14.00 (3.50-16.50)	3.650 (0.760-5.160)	16.03	99
15+25+25+25+25+50	1.27	1.85	1.85	1.85	1.85	3.70	14.00 (3.50-16.50)	3.636 (0.760-5.150)	15.97	99
15+25+25+25+25+60	1.20	1.74	1.74	1.74	1.74	4.18	14.00 (3.50-16.50)	3.629 (0.760-5.150)	15.94	99
15+25+25+25+35+35	1.31	1.91	1.91	1.91	2.67	2.67	14.00 (3.50-16.50)	3.657 (0.760-5.160)	16.06	99
15+25+25+25+35+42	1.26	1.83	1.83	1.83	2.56	3.07	14.00 (3.50-16.50)	3.646 (0.760-5.150)	16.01	99
15+25+25+25+35+50	1.20	1.74	1.74	1.74	2.44	3.49	14.00 (3.50-16.50)	3.633 (0.760-5.150)	15.96	99
15+25+25+25+42+42	1.21	1.75	1.75	1.75	2.94	2.94	14.00 (3.50-16.50)	3.636 (0.760-5.150)	15.97	99
15+25+25+35+35+35	1.24	1.79	1.79	2.51	2.51	2.51	14.00 (3.50-16.50)	3.655 (0.760-5.160)	16.05	99
15+25+25+35+35+42	1.19	1.72	1.72	2.41	2.41	2.89	14.00 (3.50-16.50)	3.643 (0.760-5.150)	16.00	99

MXZ-6C122VA HEATING

Indoor units combination	Heating Capacity (kW)							Outdoor unit power consumption (kW)	Current (A)	Power factor (%)
	Unit A	Unit B	Unit C	Unit D	Unit E	Unit F	Total			
15+25+35+35+35+35	1.17	1.69	2.37	2.37	2.37	2.37	14.00 (3.50-16.50)	3.651 (0.760-5.160)	16.03	99
20+20+20+20+20+20	2.12	1.90	1.90	1.90	1.90	1.90	12.70 (3.40-16.00)	3.650 (0.790-6.020)	16.03	99
20+20+20+20+20+22	2.21	1.89	1.89	1.89	1.89	2.07	13.50 (3.50-16.20)	3.825 (0.780-5.710)	16.80	99
20+20+20+20+20+25	2.19	1.87	1.87	1.87	1.87	2.34	13.70 (3.50-16.40)	3.775 (0.780-5.510)	16.58	99
20+20+20+20+20+35	2.06	1.79	1.79	1.79	1.79	3.14	13.90 (3.50-16.50)	3.725 (0.770-5.310)	16.36	99
20+20+20+20+20+42	1.97	1.72	1.72	1.72	1.72	3.61	14.00 (3.50-16.50)	3.695 (0.760-5.200)	16.23	99
20+20+20+20+20+50	1.87	1.63	1.63	1.63	1.63	4.07	14.00 (3.50-16.50)	3.677 (0.760-5.180)	16.15	99
20+20+20+20+20+60	1.75	1.53	1.53	1.53	1.53	4.58	14.00 (3.50-16.50)	3.671 (0.760-5.180)	16.12	99
20+20+20+20+20+71	1.64	1.43	1.43	1.43	1.43	5.07	14.00 (3.50-16.50)	3.665 (0.760-5.170)	16.09	99
20+20+20+20+22+22	2.26	1.87	1.87	1.87	2.06	2.06	14.00 (3.50-16.50)	3.700 (0.760-5.200)	16.25	99
20+20+20+20+22+25	2.20	1.86	1.86	1.86	2.04	2.32	14.00 (3.50-16.50)	3.697 (0.760-5.200)	16.24	99
20+20+20+20+22+35	2.04	1.77	1.77	1.77	1.94	3.09	14.00 (3.50-16.50)	3.695 (0.760-5.200)	16.23	99
20+20+20+20+22+42	1.94	1.69	1.69	1.69	1.86	3.56	14.00 (3.50-16.50)	3.686 (0.760-5.190)	16.19	99
20+20+20+20+22+50	1.84	1.61	1.61	1.61	1.77	4.01	14.00 (3.50-16.50)	3.667 (0.760-5.170)	16.11	99
20+20+20+20+22+60	1.73	1.51	1.51	1.51	1.66	4.52	14.00 (3.50-16.50)	3.661 (0.760-5.170)	16.08	99
20+20+20+20+22+71	1.62	1.41	1.41	1.41	1.55	5.01	14.00 (3.50-16.50)	3.656 (0.760-5.160)	16.05	99
20+20+20+20+25+25	2.15	1.83	1.83	1.83	2.29	2.29	14.00 (3.50-16.50)	3.695 (0.760-5.200)	16.23	99
20+20+20+20+25+35	2.00	1.74	1.74	1.74	2.18	3.05	14.00 (3.50-16.50)	3.695 (0.760-5.200)	16.23	99
20+20+20+20+25+42	1.90	1.66	1.66	1.66	2.07	3.49	14.00 (3.50-16.50)	3.682 (0.760-5.190)	16.17	99
20+20+20+20+25+50	1.81	1.57	1.57	1.57	1.97	3.94	14.00 (3.50-16.50)	3.665 (0.760-5.170)	16.09	99
20+20+20+20+25+60	1.70	1.48	1.48	1.48	1.85	4.44	14.00 (3.50-16.50)	3.661 (0.760-5.170)	16.08	99
20+20+20+20+25+71	1.59	1.39	1.39	1.39	1.73	4.92	14.00 (3.50-16.50)	3.653 (0.760-5.160)	16.04	99
20+20+20+20+35+35	1.87	1.63	1.63	1.63	2.85	2.85	14.00 (3.50-16.50)	3.688 (0.760-5.190)	16.20	99
20+20+20+20+35+42	1.78	1.55	1.55	1.55	2.72	3.26	14.00 (3.50-16.50)	3.677 (0.760-5.180)	16.15	99
20+20+20+20+35+50	1.70	1.48	1.48	1.48	2.59	3.70	14.00 (3.50-16.50)	3.661 (0.760-5.170)	16.08	99
20+20+20+20+35+60	1.60	1.39	1.39	1.39	2.44	4.18	14.00 (3.50-16.50)	3.656 (0.760-5.160)	16.05	99
20+20+20+20+42+42	1.71	1.49	1.49	1.49	3.12	3.12	14.00 (3.50-16.50)	3.665 (0.760-5.170)	16.09	99
20+20+20+20+42+50	1.63	1.42	1.42	1.42	2.98	3.55	14.00 (3.50-16.50)	3.650 (0.760-5.160)	16.03	99
20+20+20+20+50+50	1.56	1.36	1.36	1.36	3.39	3.39	14.00 (3.50-16.50)	3.636 (0.760-5.150)	15.97	99
20+20+20+22+22+22	2.22	1.86	1.86	2.04	2.04	2.04	14.00 (3.50-16.50)	3.691 (0.760-5.200)	16.21	99
20+20+20+22+22+25	2.17	1.84	1.84	2.03	2.03	2.31	14.00 (3.50-16.50)	3.688 (0.760-5.190)	16.20	99
20+20+20+22+22+35	2.01	1.76	1.76	1.93	1.93	3.07	14.00 (3.50-16.50)	3.686 (0.760-5.190)	16.19	99
20+20+20+22+22+42	1.92	1.67	1.67	1.84	1.84	3.51	14.00 (3.50-16.50)	3.674 (0.760-5.180)	16.14	99
20+20+20+22+22+50	1.82	1.58	1.58	1.74	1.74	3.96	14.00 (3.50-16.50)	3.661 (0.760-5.170)	16.08	99
20+20+20+22+22+60	1.71	1.49	1.49	1.64	1.64	4.46	14.00 (3.50-16.50)	3.652 (0.760-5.160)	16.04	99
20+20+20+22+22+71	1.60	1.39	1.39	1.53	1.53	4.95	14.00 (3.50-16.50)	3.647 (0.760-5.150)	16.02	99
20+20+20+22+25+25	2.12	1.82	1.82	2.00	2.27	2.27	14.00 (3.50-16.50)	3.686 (0.760-5.190)	16.19	99
20+20+20+22+25+35	1.97	1.72	1.72	1.89	2.15	3.01	14.00 (3.50-16.50)	3.686 (0.760-5.190)	16.19	99
20+20+20+22+25+42	1.88	1.64	1.64	1.80	2.05	3.44	14.00 (3.50-16.50)	3.671 (0.760-5.180)	16.12	99
20+20+20+22+25+50	1.78	1.55	1.55	1.71	1.94	3.89	14.00 (3.50-16.50)	3.656 (0.760-5.160)	16.05	99
20+20+20+22+25+60	1.68	1.46	1.46	1.61	1.83	4.38	14.00 (3.50-16.50)	3.650 (0.760-5.160)	16.03	99
20+20+20+22+25+71	1.57	1.37	1.37	1.51	1.71	4.87	14.00 (3.50-16.50)	3.645 (0.760-5.150)	16.01	99
20+20+20+22+35+35	1.84	1.61	1.61	1.77	2.81	2.81	14.00 (3.50-16.50)	3.682 (0.760-5.190)	16.17	99
20+20+20+22+35+42	1.76	1.53	1.53	1.69	2.69	3.22	14.00 (3.50-16.50)	3.667 (0.760-5.170)	16.11	99
20+20+20+22+35+50	1.68	1.46	1.46	1.61	2.56	3.65	14.00 (3.50-16.50)	3.652 (0.760-5.160)	16.04	99
20+20+20+22+35+60	1.58	1.38	1.38	1.52	2.41	4.14	14.00 (3.50-16.50)	3.647 (0.760-5.150)	16.02	99

MXZ-6C122VA HEATING

Indoor units combination	Heating Capacity (kW)							Outdoor unit power consumption (kW)	Current (A)	Power factor (%)
	Unit A	Unit B	Unit C	Unit D	Unit E	Unit F	Total			
20+20+20+22+42+42	1.69	1.47	1.47	1.62	3.09	3.09	14.00 (3.50-16.50)	3.656 (0.760-5.160)	16.05	99
20+20+20+22+42+50	1.61	1.40	1.40	1.54	2.94	3.51	14.00 (3.50-16.50)	3.641 (0.760-5.150)	15.99	99
20+20+20+25+25+25	2.07	1.79	1.79	2.24	2.24	2.24	14.00 (3.50-16.50)	3.686 (0.760-5.190)	16.19	99
20+20+20+25+25+35	1.93	1.68	1.68	2.10	2.10	2.94	14.00 (3.50-16.50)	3.682 (0.760-5.190)	16.17	99
20+20+20+25+25+42	1.84	1.61	1.61	2.01	2.01	3.37	14.00 (3.50-16.50)	3.670 (0.760-5.180)	16.12	99
20+20+20+25+25+50	1.75	1.53	1.53	1.91	1.91	3.81	14.00 (3.50-16.50)	3.653 (0.760-5.160)	16.04	99
20+20+20+25+25+60	1.65	1.44	1.44	1.79	1.79	4.31	14.00 (3.50-16.50)	3.647 (0.760-5.150)	16.02	99
20+20+20+25+35+35	1.81	1.57	1.57	1.97	2.75	2.75	14.00 (3.50-16.50)	3.677 (0.760-5.180)	16.15	99
20+20+20+25+35+42	1.73	1.51	1.51	1.88	2.64	3.16	14.00 (3.50-16.50)	3.665 (0.760-5.170)	16.09	99
20+20+20+25+35+50	1.65	1.44	1.44	1.79	2.51	3.59	14.00 (3.50-16.50)	3.650 (0.760-5.160)	16.03	99
20+20+20+25+35+60	1.56	1.36	1.36	1.69	2.37	4.07	14.00 (3.50-16.50)	3.645 (0.760-5.150)	16.01	99
20+20+20+25+42+42	1.66	1.44	1.44	1.80	3.03	3.03	14.00 (3.50-16.50)	3.653 (0.760-5.160)	16.04	99
20+20+20+25+42+50	1.58	1.38	1.38	1.72	2.89	3.45	14.00 (3.50-16.50)	3.639 (0.760-5.150)	15.98	99
20+20+20+35+35+35	1.70	1.48	1.48	2.59	2.59	2.59	14.00 (3.50-16.50)	3.674 (0.760-5.180)	16.14	99
20+20+20+35+35+42	1.63	1.42	1.42	2.48	2.48	2.98	14.00 (3.50-16.50)	3.661 (0.760-5.170)	16.08	99
20+20+20+35+35+50	1.56	1.36	1.36	2.37	2.37	3.39	14.00 (3.50-16.50)	3.647 (0.760-5.150)	16.02	99
20+20+20+35+42+42	1.56	1.36	1.36	2.39	2.86	2.86	14.00 (3.50-16.50)	3.650 (0.760-5.160)	16.03	99
20+20+22+22+22+22	2.19	1.84	2.03	2.03	2.03	2.03	14.00 (3.50-16.50)	3.682 (0.760-5.190)	16.17	99
20+20+22+22+22+25	2.14	1.83	2.02	2.02	2.02	2.29	14.00 (3.50-16.50)	3.679 (0.760-5.180)	16.16	99
20+20+22+22+22+35	1.99	1.73	1.90	1.90	1.90	3.03	14.00 (3.50-16.50)	3.677 (0.760-5.180)	16.15	99
20+20+22+22+22+42	1.89	1.65	1.81	1.81	1.81	3.46	14.00 (3.50-16.50)	3.664 (0.760-5.170)	16.09	99
20+20+22+22+22+50	1.79	1.56	1.72	1.72	1.72	3.91	14.00 (3.50-16.50)	3.650 (0.760-5.160)	16.03	99
20+20+22+22+22+60	1.69	1.47	1.62	1.62	1.62	4.41	14.00 (3.50-16.50)	3.643 (0.760-5.150)	16.00	99
20+20+22+22+22+71	1.58	1.38	1.52	1.52	1.52	4.89	14.00 (3.50-16.50)	3.638 (0.760-5.150)	15.98	99
20+20+22+22+25+25	2.09	1.81	1.99	1.99	2.26	2.26	14.00 (3.50-16.50)	3.677 (0.760-5.180)	16.15	99
20+20+22+22+25+35	1.94	1.69	1.86	1.86	2.12	2.97	14.00 (3.50-16.50)	3.674 (0.760-5.180)	16.14	99
20+20+22+22+25+42	1.85	1.62	1.78	1.78	2.02	3.39	14.00 (3.50-16.50)	3.661 (0.760-5.170)	16.08	99
20+20+22+22+25+50	1.76	1.53	1.69	1.69	1.92	3.84	14.00 (3.50-16.50)	3.647 (0.760-5.150)	16.02	99
20+20+22+22+25+60	1.66	1.44	1.59	1.59	1.80	4.33	14.00 (3.50-16.50)	3.641 (0.760-5.150)	15.99	99
20+20+22+22+25+71	1.56	1.36	1.49	1.49	1.69	4.81	14.00 (3.50-16.50)	3.636 (0.760-5.150)	15.97	99
20+20+22+22+35+35	1.82	1.58	1.74	1.74	2.77	2.77	14.00 (3.50-16.50)	3.671 (0.760-5.180)	16.12	99
20+20+22+22+35+42	1.74	1.52	1.67	1.67	2.65	3.18	14.00 (3.50-16.50)	3.661 (0.760-5.170)	16.08	99
20+20+22+22+35+50	1.66	1.44	1.59	1.59	2.53	3.61	14.00 (3.50-16.50)	3.645 (0.760-5.150)	16.01	99
20+20+22+22+35+60	1.56	1.36	1.50	1.50	2.39	4.09	14.00 (3.50-16.50)	3.638 (0.760-5.150)	15.98	99
20+20+22+22+42+42	1.67	1.45	1.60	1.60	3.05	3.05	14.00 (3.50-16.50)	3.647 (0.760-5.150)	16.02	99
20+20+22+22+42+50	1.59	1.39	1.53	1.53	2.91	3.47	14.00 (3.50-16.50)	3.633 (0.760-5.150)	15.96	99
20+20+22+25+25+25	2.04	1.77	1.94	2.21	2.21	2.21	14.00 (3.50-16.50)	3.674 (0.760-5.180)	16.14	99
20+20+22+25+25+35	1.90	1.66	1.83	2.07	2.07	2.90	14.00 (3.50-16.50)	3.671 (0.760-5.180)	16.12	99
20+20+22+25+25+42	1.82	1.58	1.74	1.98	1.98	3.33	14.00 (3.50-16.50)	3.661 (0.760-5.170)	16.08	99
20+20+22+25+25+50	1.73	1.51	1.66	1.88	1.88	3.77	14.00 (3.50-16.50)	3.645 (0.760-5.150)	16.01	99
20+20+22+25+25+60	1.63	1.42	1.56	1.77	1.77	4.26	14.00 (3.50-16.50)	3.639 (0.760-5.150)	15.98	99
20+20+22+25+35+35	1.78	1.55	1.71	1.94	2.72	2.72	14.00 (3.50-16.50)	3.667 (0.760-5.170)	16.11	99
20+20+22+25+35+42	1.71	1.49	1.64	1.86	2.60	3.12	14.00 (3.50-16.50)	3.656 (0.760-5.160)	16.05	99
20+20+22+25+35+50	1.63	1.42	1.56	1.77	2.48	3.55	14.00 (3.50-16.50)	3.641 (0.760-5.150)	15.99	99
20+20+22+25+42+42	1.64	1.43	1.57	1.78	3.00	3.00	14.00 (3.50-16.50)	3.645 (0.760-5.150)	16.01	99
20+20+22+25+42+50	1.56	1.36	1.50	1.70	2.86	3.41	14.00 (3.50-16.50)	3.631 (0.760-5.150)	15.95	99

MXZ-6C122VA HEATING

Indoor units combination	Heating Capacity (kW)							Outdoor unit power consumption (kW)	Current (A)	Power factor (%)
	Unit A	Unit B	Unit C	Unit D	Unit E	Unit F	Total			
20+20+22+35+35+35	1.68	1.46	1.61	2.56	2.56	2.56	14.00 (3.50-16.50)	3.665 (0.760-5.170)	16.09	99
20+20+22+35+35+42	1.61	1.40	1.54	2.45	2.45	2.94	14.00 (3.50-16.50)	3.652 (0.760-5.160)	16.04	99
20+20+25+25+25+25	2.00	1.74	2.18	2.18	2.18	2.18	14.00 (3.50-16.50)	3.671 (0.760-5.180)	16.12	99
20+20+25+25+25+35	1.87	1.63	2.03	2.03	2.03	2.85	14.00 (3.50-16.50)	3.670 (0.760-5.180)	16.12	99
20+20+25+25+25+42	1.78	1.55	1.94	1.94	1.94	3.26	14.00 (3.50-16.50)	3.657 (0.760-5.160)	16.06	99
20+20+25+25+25+50	1.70	1.48	1.85	1.85	1.85	3.70	14.00 (3.50-16.50)	3.642 (0.760-5.150)	15.99	99
20+20+25+25+25+60	1.60	1.39	1.74	1.74	1.74	4.18	14.00 (3.50-16.50)	3.636 (0.760-5.150)	15.97	99
20+20+25+25+35+35	1.75	1.53	1.91	1.91	2.67	2.67	14.00 (3.50-16.50)	3.665 (0.760-5.170)	16.09	99
20+20+25+25+35+42	1.68	1.46	1.83	1.83	2.56	3.07	14.00 (3.50-16.50)	3.653 (0.760-5.160)	16.04	99
20+20+25+25+35+50	1.60	1.39	1.74	1.74	2.44	3.49	14.00 (3.50-16.50)	3.639 (0.760-5.150)	15.98	99
20+20+25+25+42+42	1.61	1.40	1.75	1.75	2.94	2.94	14.00 (3.50-16.50)	3.642 (0.760-5.150)	15.99	99
20+20+25+35+35+35	1.65	1.44	1.79	2.51	2.51	2.51	14.00 (3.50-16.50)	3.661 (0.760-5.170)	16.08	99
20+20+25+35+35+42	1.58	1.38	1.72	2.41	2.41	2.89	14.00 (3.50-16.50)	3.650 (0.760-5.160)	16.03	99
20+20+35+35+35+35	1.56	1.36	2.37	2.37	2.37	2.37	14.00 (3.50-16.50)	3.661 (0.760-5.170)	16.08	99
20+22+22+22+22+22	2.15	2.01	2.01	2.01	2.01	2.01	14.00 (3.50-16.50)	3.672 (0.760-5.180)	16.13	99
20+22+22+22+22+25	2.11	1.98	1.98	1.98	1.98	2.26	14.00 (3.50-16.50)	3.670 (0.760-5.180)	16.12	99
20+22+22+22+22+35	1.96	1.88	1.88	1.88	1.88	2.99	14.00 (3.50-16.50)	3.666 (0.760-5.170)	16.10	99
20+22+22+22+22+42	1.87	1.79	1.79	1.79	1.79	3.42	14.00 (3.50-16.50)	3.655 (0.760-5.160)	16.05	99
20+22+22+22+22+50	1.77	1.70	1.70	1.70	1.70	3.86	14.00 (3.50-16.50)	3.640 (0.760-5.150)	15.99	99
20+22+22+22+22+60	1.67	1.60	1.60	1.60	1.60	4.36	14.00 (3.50-16.50)	3.636 (0.760-5.150)	15.97	99
20+22+22+22+22+71	1.56	1.50	1.50	1.50	1.50	4.84	14.00 (3.50-16.50)	3.629 (0.760-5.150)	15.94	99
20+22+22+22+25+25	2.06	1.96	1.96	1.96	2.22	2.22	14.00 (3.50-16.50)	3.667 (0.760-5.170)	16.11	99
20+22+22+22+25+35	1.92	1.84	1.84	1.84	2.09	2.92	14.00 (3.50-16.50)	3.664 (0.760-5.170)	16.09	99
20+22+22+22+25+42	1.83	1.75	1.75	1.75	1.99	3.35	14.00 (3.50-16.50)	3.652 (0.760-5.160)	16.04	99
20+22+22+22+25+50	1.74	1.67	1.67	1.67	1.89	3.79	14.00 (3.50-16.50)	3.638 (0.760-5.150)	15.98	99
20+22+22+22+25+60	1.64	1.57	1.57	1.57	1.78	4.28	14.00 (3.50-16.50)	3.633 (0.760-5.150)	15.96	99
20+22+22+22+35+35	1.79	1.72	1.72	1.72	2.74	2.74	14.00 (3.50-16.50)	3.661 (0.760-5.170)	16.08	99
20+22+22+22+35+42	1.72	1.65	1.65	1.65	2.62	3.14	14.00 (3.50-16.50)	3.650 (0.760-5.160)	16.03	99
20+22+22+22+35+50	1.64	1.57	1.57	1.57	2.50	3.57	14.00 (3.50-16.50)	3.636 (0.760-5.150)	15.97	99
20+22+22+22+42+42	1.65	1.58	1.58	1.58	3.01	3.01	14.00 (3.50-16.50)	3.638 (0.760-5.150)	15.98	99
20+22+22+22+42+50	1.57	1.51	1.51	1.51	2.88	3.43	14.00 (3.50-16.50)	3.624 (0.760-5.150)	15.92	99
20+22+22+25+25+25	2.01	1.93	1.93	2.19	2.19	2.19	14.00 (3.50-16.50)	3.665 (0.760-5.170)	16.09	99
20+22+22+25+25+35	1.88	1.80	1.80	2.05	2.05	2.87	14.00 (3.50-16.50)	3.661 (0.760-5.170)	16.08	99
20+22+22+25+25+42	1.79	1.72	1.72	1.96	1.96	3.28	14.00 (3.50-16.50)	3.650 (0.760-5.160)	16.03	99
20+22+22+25+25+50	1.71	1.64	1.64	1.86	1.86	3.72	14.00 (3.50-16.50)	3.636 (0.760-5.150)	15.97	99
20+22+22+25+25+60	1.61	1.54	1.54	1.75	1.75	4.21	14.00 (3.50-16.50)	3.631 (0.760-5.150)	15.95	99
20+22+22+25+35+35	1.76	1.69	1.69	1.92	2.69	2.69	14.00 (3.50-16.50)	3.661 (0.760-5.170)	16.08	99
20+22+22+25+35+42	1.69	1.62	1.62	1.84	2.57	3.09	14.00 (3.50-16.50)	3.647 (0.760-5.150)	16.02	99
20+22+22+25+35+50	1.61	1.54	1.54	1.75	2.45	3.51	14.00 (3.50-16.50)	3.633 (0.760-5.150)	15.96	99
20+22+22+25+42+42	1.62	1.55	1.55	1.76	2.96	2.96	14.00 (3.50-16.50)	3.636 (0.760-5.150)	15.97	99
20+22+22+35+35+35	1.66	1.59	1.59	2.53	2.53	2.53	14.00 (3.50-16.50)	3.655 (0.760-5.160)	16.05	99
20+22+22+35+35+42	1.59	1.53	1.53	2.43	2.43	2.91	14.00 (3.50-16.50)	3.643 (0.760-5.150)	16.00	99
20+22+25+25+25+25	1.97	1.89	2.15	2.15	2.15	2.15	14.00 (3.50-16.50)	3.662 (0.760-5.170)	16.08	99
20+22+25+25+25+35	1.84	1.77	2.01	2.01	2.01	2.81	14.00 (3.50-16.50)	3.661 (0.760-5.170)	16.08	99
20+22+25+25+25+42	1.76	1.69	1.92	1.92	1.92	3.22	14.00 (3.50-16.50)	3.647 (0.760-5.150)	16.02	99
20+22+25+25+25+50	1.68	1.61	1.83	1.83	1.83	3.65	14.00 (3.50-16.50)	3.633 (0.760-5.150)	15.96	99

MXZ-6C122VA HEATING

Indoor units combination	Heating Capacity (kW)							Outdoor unit power consumption (kW)	Current (A)	Power factor (%)
	Unit A	Unit B	Unit C	Unit D	Unit E	Unit F	Total			
20+22+25+25+25+60	1.58	1.52	1.72	1.72	1.72	4.14	14.00 (3.50-16.50)	3.629 (0.760-5.150)	15.94	99
20+22+25+25+35+35	1.73	1.66	1.88	1.88	2.64	2.64	14.00 (3.50-16.50)	3.656 (0.760-5.160)	16.05	99
20+22+25+25+35+42	1.66	1.59	1.80	1.80	2.53	3.03	14.00 (3.50-16.50)	3.645 (0.760-5.150)	16.01	99
20+22+25+25+35+50	1.58	1.52	1.72	1.72	2.41	3.45	14.00 (3.50-16.50)	3.631 (0.760-5.150)	15.95	99
20+22+25+25+42+42	1.59	1.53	1.73	1.73	2.91	2.91	14.00 (3.50-16.50)	3.633 (0.760-5.150)	15.96	99
20+22+25+35+35+35	1.63	1.56	1.77	2.48	2.48	2.48	14.00 (3.50-16.50)	3.652 (0.760-5.160)	16.04	99
20+22+25+35+35+42	1.56	1.50	1.70	2.39	2.39	2.86	14.00 (3.50-16.50)	3.641 (0.760-5.150)	15.99	99
20+25+25+25+25+25	1.93	2.10	2.10	2.10	2.10	2.10	14.00 (3.50-16.50)	3.661 (0.760-5.170)	16.08	99
20+25+25+25+25+35	1.81	1.97	1.97	1.97	1.97	2.75	14.00 (3.50-16.50)	3.657 (0.760-5.160)	16.06	99
20+25+25+25+25+42	1.73	1.88	1.88	1.88	1.88	3.16	14.00 (3.50-16.50)	3.645 (0.760-5.150)	16.01	99
20+25+25+25+25+50	1.65	1.79	1.79	1.79	1.79	3.59	14.00 (3.50-16.50)	3.631 (0.760-5.150)	15.95	99
20+25+25+25+25+60	1.56	1.69	1.69	1.69	1.69	4.07	14.00 (3.50-16.50)	3.626 (0.760-5.150)	15.93	99
20+25+25+25+35+35	1.70	1.85	1.85	1.85	2.59	2.59	14.00 (3.50-16.50)	3.653 (0.760-5.160)	16.04	99
20+25+25+25+35+42	1.63	1.77	1.77	1.77	2.48	2.98	14.00 (3.50-16.50)	3.642 (0.760-5.150)	15.99	99
20+25+25+25+35+50	1.56	1.69	1.69	1.69	2.37	3.39	14.00 (3.50-16.50)	3.629 (0.760-5.150)	15.94	99
20+25+25+25+42+42	1.56	1.70	1.70	1.70	2.86	2.86	14.00 (3.50-16.50)	3.631 (0.760-5.150)	15.95	99
20+25+25+35+35+35	1.60	1.74	1.74	2.44	2.44	2.44	14.00 (3.50-16.50)	3.650 (0.760-5.160)	16.03	99
22+22+22+22+22+22	2.33	2.00	2.00	2.00	2.00	2.00	14.00 (3.50-16.50)	3.663 (0.760-5.170)	16.09	99
22+22+22+22+22+25	2.28	1.97	1.97	1.97	1.97	2.24	14.00 (3.50-16.50)	3.661 (0.760-5.170)	16.08	99
22+22+22+22+22+35	2.12	1.85	1.85	1.85	1.85	2.94	14.00 (3.50-16.50)	3.657 (0.760-5.160)	16.06	99
22+22+22+22+22+42	2.03	1.77	1.77	1.77	1.77	3.37	14.00 (3.50-16.50)	3.646 (0.760-5.150)	16.01	99
22+22+22+22+22+50	1.93	1.68	1.68	1.68	1.68	3.81	14.00 (3.50-16.50)	3.633 (0.760-5.150)	15.96	99
22+22+22+22+22+60	1.81	1.58	1.58	1.58	1.58	4.31	14.00 (3.50-16.50)	3.626 (0.760-5.150)	15.93	99
22+22+22+22+25+25	2.23	1.94	1.94	1.94	2.21	2.21	14.00 (3.50-16.50)	3.658 (0.760-5.160)	16.07	99
22+22+22+22+25+35	2.08	1.81	1.81	1.81	2.06	2.89	14.00 (3.50-16.50)	3.655 (0.760-5.160)	16.05	99
22+22+22+22+25+42	1.99	1.73	1.73	1.73	1.97	3.31	14.00 (3.50-16.50)	3.643 (0.760-5.150)	16.00	99
22+22+22+22+25+50	1.89	1.65	1.65	1.65	1.87	3.74	14.00 (3.50-16.50)	3.629 (0.760-5.150)	15.94	99
22+22+22+22+25+60	1.78	1.55	1.55	1.55	1.76	4.23	14.00 (3.50-16.50)	3.624 (0.760-5.150)	15.92	99
22+22+22+22+35+35	1.95	1.70	1.70	1.70	2.70	2.70	14.00 (3.50-16.50)	3.652 (0.760-5.160)	16.04	99
22+22+22+22+35+42	1.87	1.63	1.63	1.63	2.59	3.11	14.00 (3.50-16.50)	3.640 (0.760-5.150)	15.99	99
22+22+22+22+35+50	1.78	1.55	1.55	1.55	2.47	3.53	14.00 (3.50-16.50)	3.626 (0.760-5.150)	15.93	99
22+22+22+22+42+42	1.79	1.56	1.56	1.56	2.98	2.98	14.00 (3.50-16.50)	3.629 (0.760-5.150)	15.94	99
22+22+22+22+42+50	1.71	1.49	1.49	1.49	2.85	3.39	14.00 (3.50-16.50)	3.620 (0.760-5.150)	15.90	99
22+22+22+25+25+25	2.18	1.90	1.90	2.16	2.16	2.16	14.00 (3.50-16.50)	3.656 (0.760-5.160)	16.05	99
22+22+22+25+25+35	2.04	1.78	1.78	2.02	2.02	2.83	14.00 (3.50-16.50)	3.652 (0.760-5.160)	16.04	99
22+22+22+25+25+42	1.95	1.70	1.70	1.93	1.93	3.24	14.00 (3.50-16.50)	3.641 (0.760-5.150)	15.99	99
22+22+22+25+25+50	1.86	1.62	1.62	1.84	1.84	3.67	14.00 (3.50-16.50)	3.627 (0.760-5.150)	15.93	99
22+22+22+25+25+60	1.75	1.53	1.53	1.73	1.73	4.16	14.00 (3.50-16.50)	3.622 (0.760-5.150)	15.90	99
22+22+22+25+35+35	1.91	1.67	1.67	1.89	2.65	2.65	14.00 (3.50-16.50)	3.650 (0.760-5.160)	16.03	99
22+22+22+25+35+42	1.83	1.60	1.60	1.82	2.54	3.05	14.00 (3.50-16.50)	3.638 (0.760-5.150)	15.98	99
22+22+22+25+35+50	1.75	1.53	1.53	1.73	2.43	3.47	14.00 (3.50-16.50)	3.624 (0.760-5.150)	15.92	99
22+22+22+25+42+42	1.76	1.53	1.53	1.74	2.93	2.93	14.00 (3.50-16.50)	3.627 (0.760-5.150)	15.93	99
22+22+22+35+35+35	1.80	1.57	1.57	2.50	2.50	2.50	14.00 (3.50-16.50)	3.646 (0.760-5.150)	16.01	99
22+22+22+35+35+42	1.73	1.51	1.51	2.40	2.40	2.88	14.00 (3.50-16.50)	3.636 (0.760-5.150)	15.97	99
22+22+25+25+25+25	2.14	1.86	2.12	2.12	2.12	2.12	14.00 (3.50-16.50)	3.653 (0.760-5.160)	16.04	99
22+22+25+25+25+35	2.00	1.74	1.98	1.98	1.98	2.77	14.00 (3.50-16.50)	3.650 (0.760-5.160)	16.03	99

MXZ-6C122VA HEATING

Indoor units combination	Heating Capacity (kW)							Outdoor unit power consumption (kW)	Current (A)	Power factor (%)
	Unit A	Unit B	Unit C	Unit D	Unit E	Unit F	Total			
22+22+25+25+25+42	1.91	1.67	1.89	1.89	1.89	3.18	14.00 (3.50-16.50)	3.639 (0.760-5.150)	15.98	99
22+22+25+25+25+50	1.82	1.59	1.80	1.80	1.80	3.61	14.00 (3.50-16.50)	3.625 (0.760-5.150)	15.92	99
22+22+25+25+25+60	1.72	1.50	1.70	1.70	1.70	4.09	14.00 (3.50-16.50)	3.620 (0.760-5.150)	15.90	99
22+22+25+25+35+35	1.88	1.64	1.86	1.86	2.60	2.60	14.00 (3.50-16.50)	3.647 (0.760-5.150)	16.02	99
22+22+25+25+35+42	1.80	1.57	1.78	1.78	2.50	3.00	14.00 (3.50-16.50)	3.636 (0.760-5.150)	15.97	99
22+22+25+25+35+50	1.72	1.50	1.70	1.70	2.39	3.41	14.00 (3.50-16.50)	3.622 (0.760-5.150)	15.90	99
22+22+25+25+42+42	1.73	1.51	1.71	1.71	2.88	2.88	14.00 (3.50-16.50)	3.625 (0.760-5.150)	15.92	99
22+22+25+35+35+35	1.77	1.54	1.75	2.45	2.45	2.45	14.00 (3.50-16.50)	3.645 (0.760-5.150)	16.01	99
22+25+25+25+25+25	2.10	2.07	2.07	2.07	2.07	2.07	14.00 (3.50-16.50)	3.651 (0.760-5.160)	16.03	99
22+25+25+25+25+35	1.96	1.94	1.94	1.94	1.94	2.72	14.00 (3.50-16.50)	3.647 (0.760-5.150)	16.02	99
22+25+25+25+25+42	1.88	1.86	1.86	1.86	1.86	3.12	14.00 (3.50-16.50)	3.636 (0.760-5.150)	15.97	99
22+25+25+25+25+50	1.79	1.77	1.77	1.77	1.77	3.55	14.00 (3.50-16.50)	3.622 (0.760-5.150)	15.91	99
22+25+25+25+35+35	1.84	1.83	1.83	1.83	2.56	2.56	14.00 (3.50-16.50)	3.645 (0.760-5.150)	16.01	99
22+25+25+25+35+42	1.77	1.75	1.75	1.75	2.45	2.94	14.00 (3.50-16.50)	3.633 (0.760-5.150)	15.96	99
22+25+25+35+35+35	1.74	1.72	1.72	2.41	2.41	2.41	14.00 (3.50-16.50)	3.641 (0.760-5.150)	15.99	99
25+25+25+25+25+25	2.33	2.03	2.03	2.03	2.03	2.03	14.00 (3.50-16.50)	3.648 (0.760-5.150)	16.02	99
25+25+25+25+25+35	2.19	1.91	1.91	1.91	1.91	2.67	14.00 (3.50-16.50)	3.645 (0.760-5.150)	16.01	99
25+25+25+25+25+42	2.10	1.83	1.83	1.83	1.83	3.07	14.00 (3.50-16.50)	3.634 (0.760-5.150)	15.96	99
25+25+25+25+25+50	2.00	1.74	1.74	1.74	1.74	3.49	14.00 (3.50-16.50)	3.620 (0.760-5.150)	15.90	99
25+25+25+25+35+35	2.06	1.79	1.79	1.79	2.51	2.51	14.00 (3.50-16.50)	3.642 (0.760-5.150)	15.99	99
25+25+25+25+35+42	1.98	1.72	1.72	1.72	2.41	2.89	14.00 (3.50-16.50)	3.631 (0.760-5.150)	15.95	99
25+25+25+35+35+35	1.94	1.69	1.69	2.37	2.37	2.37	14.00 (3.50-16.50)	3.639 (0.760-5.150)	15.98	99