

Air Conditioning | Heating
Ventilation | Controls

TIME FOR
R32

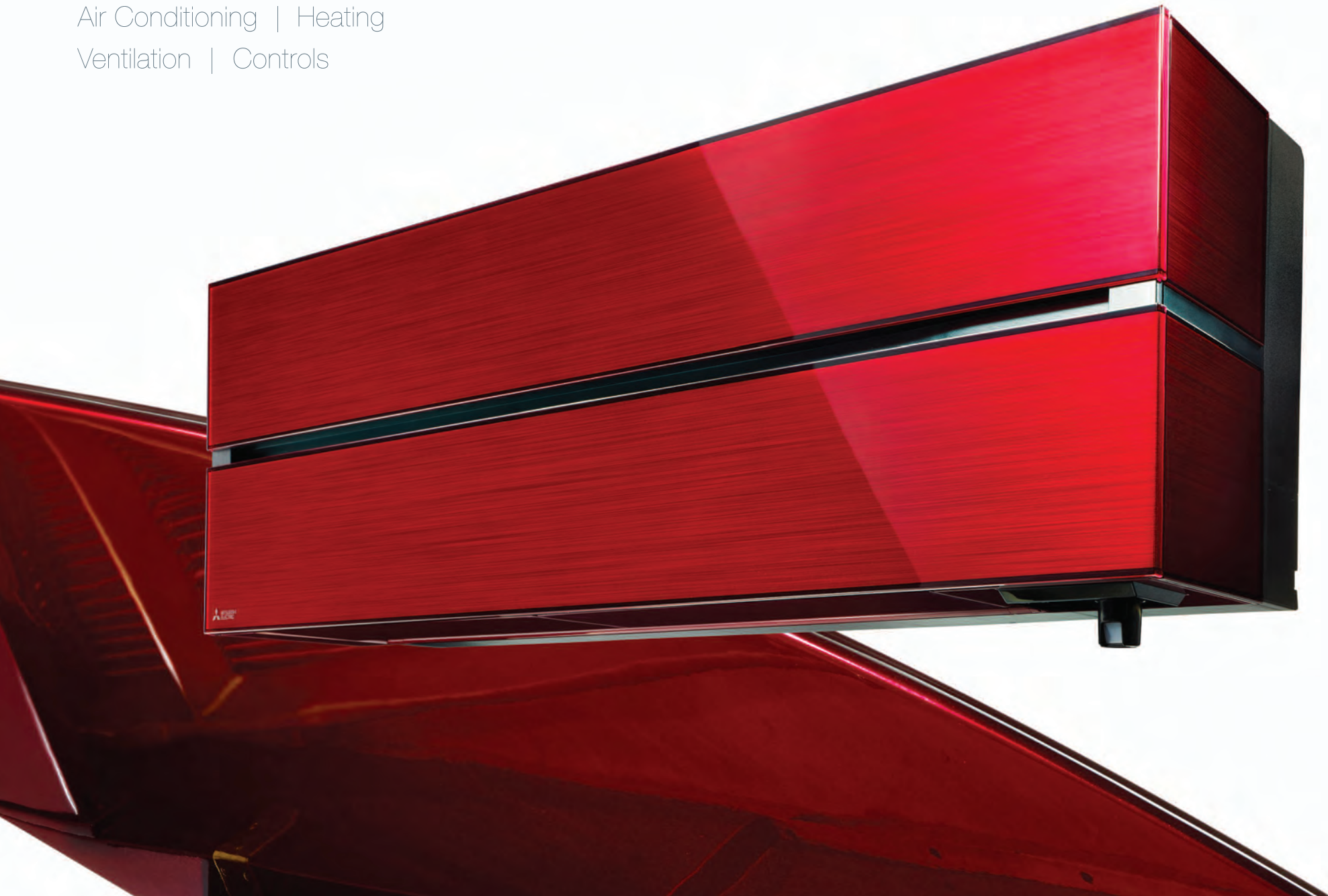





The MSZ-LN wall mounted system

A blend of energy efficiency and sophisticated design













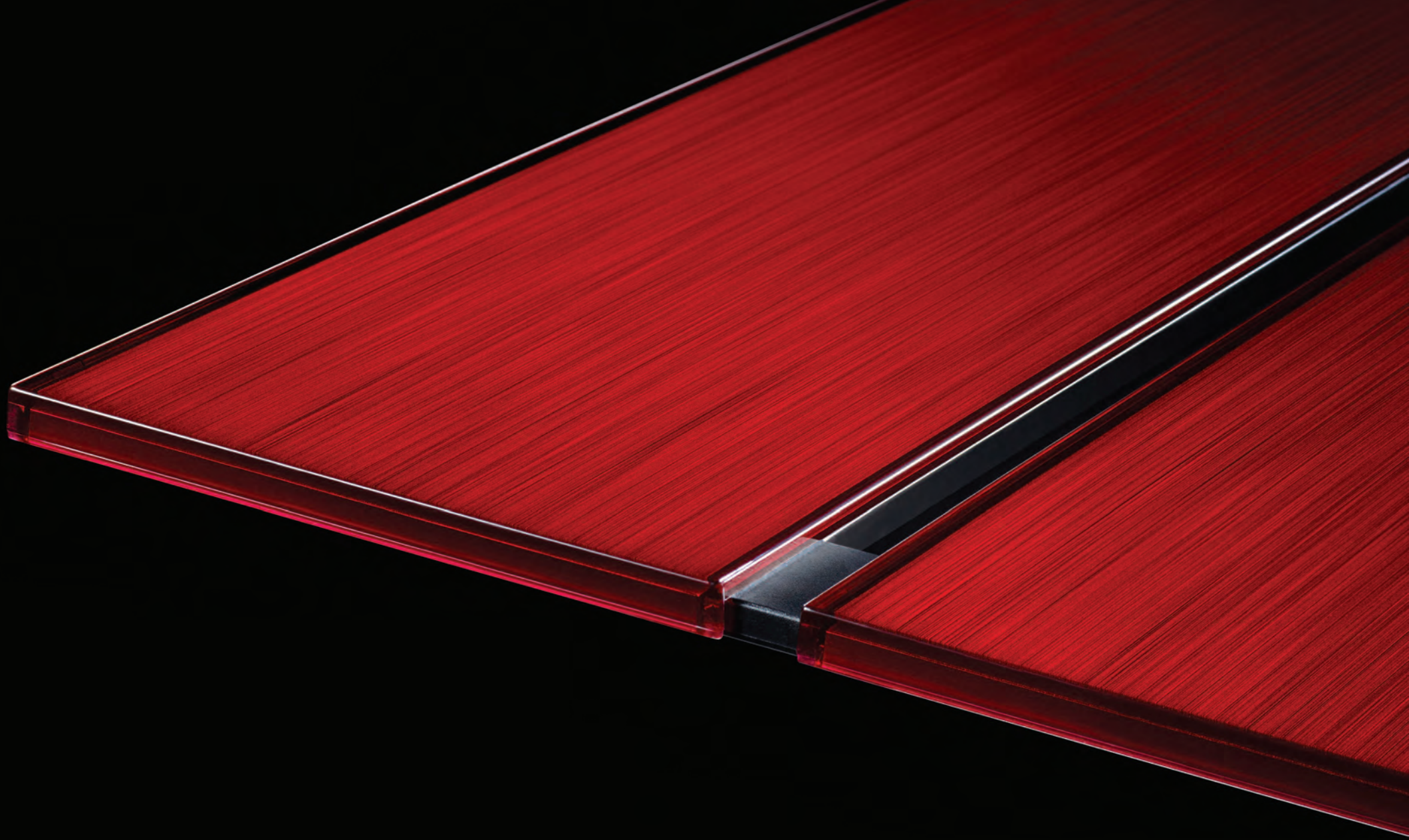

Finished with a range of deep, rich colours and a premium quality feel

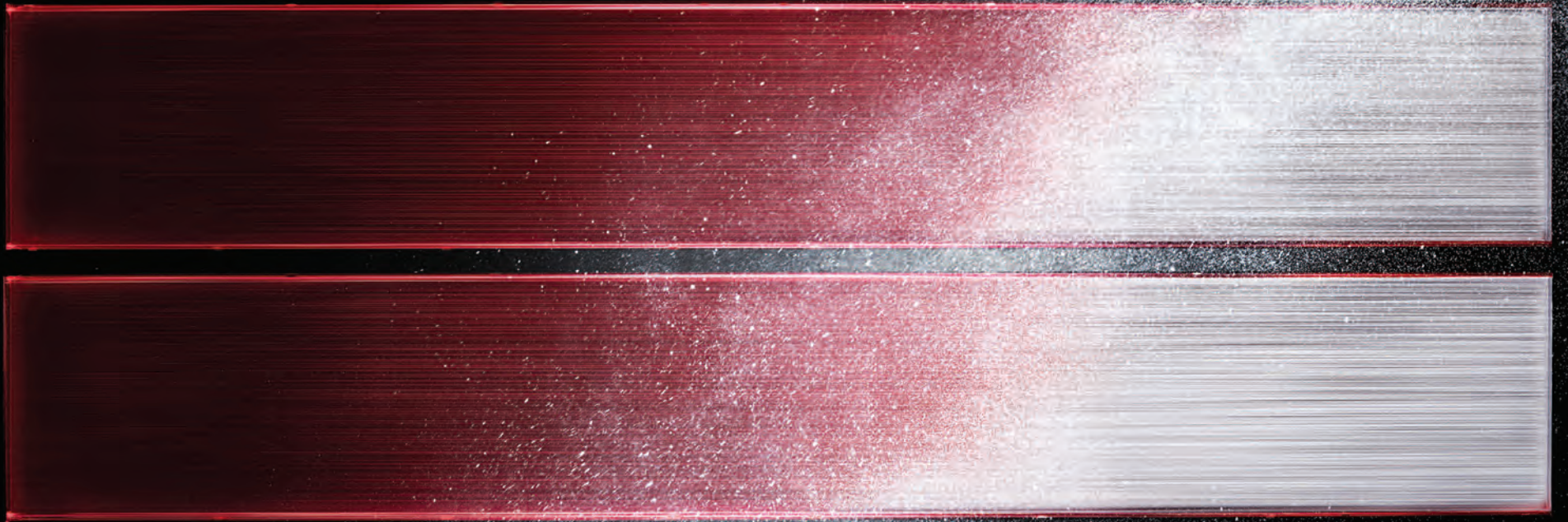

Stylish, colour coordinated remote controllers





Mobile control and monitoring of your Mitsubishi Electric systems

MELCloud is a cloud based solution for controlling and monitoring your Mitsubishi Electric air conditioning or heating systems either locally or remotely by PC, tablet or smartphone app. It offers the ability to control which units are on/off, temperature settings, the 7 day weekly schedule, frost protection settings, holiday mode and also log and record errors.

Ensuring total flexibility from a single device, from any worldwide location, the MELCloud app also provides localised information like weather forecasts and customer service contact details. The MSZ-LN models are the first in our air conditioning range to come with the Wi-Fi interface needed to connect to MELCloud built into the unit as standard.



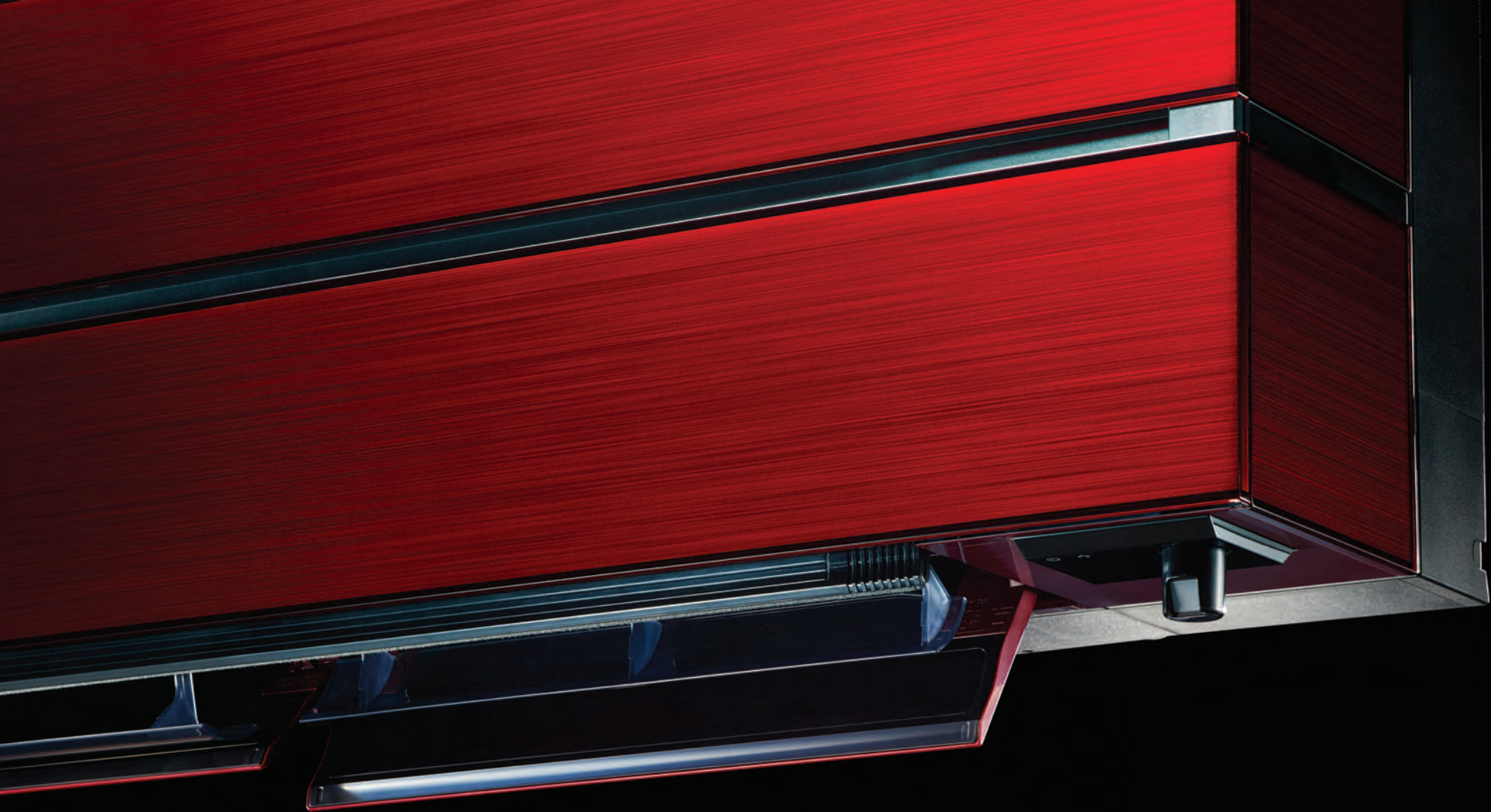

i-see infrared sensor and double vanes provide enhanced comfort and energy savings

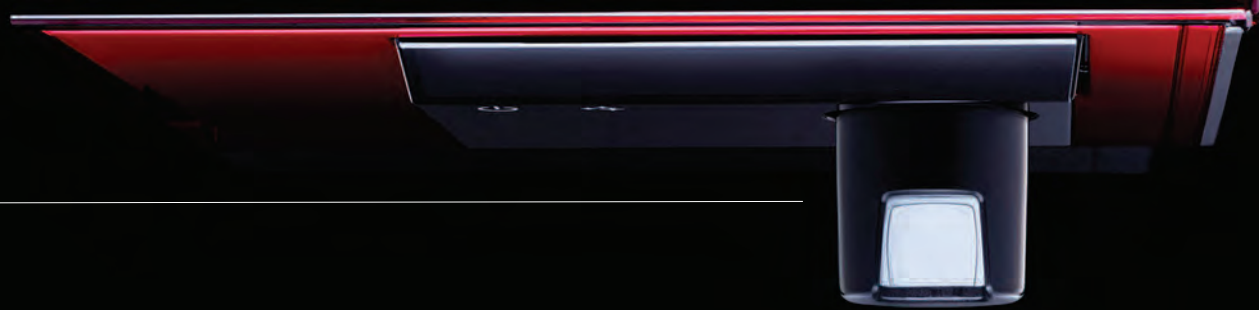

30°C

22°C

Low  High

i-see Sensor

The i-see Sensor provides customised comfort by automatically monitoring room occupancy, position and body temperature.

Double Vanes

Double vanes operate independently to distribute airflow evenly throughout the room.



Dual-Barrier Coating

Mitsubishi Electric's proprietary coating prevents dust and grease accumulation.



- Grease mist
- Cigarette smoke

- Dust
- Dirt

- Dual Barrier Coating used in:
- Heat exchanger
 - Fan
 - Air duct

Plasma Quad Plus Filter

Uses powerful plasma technology to filter out even microscopic particles.

Plasma Quad Plus

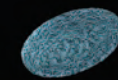
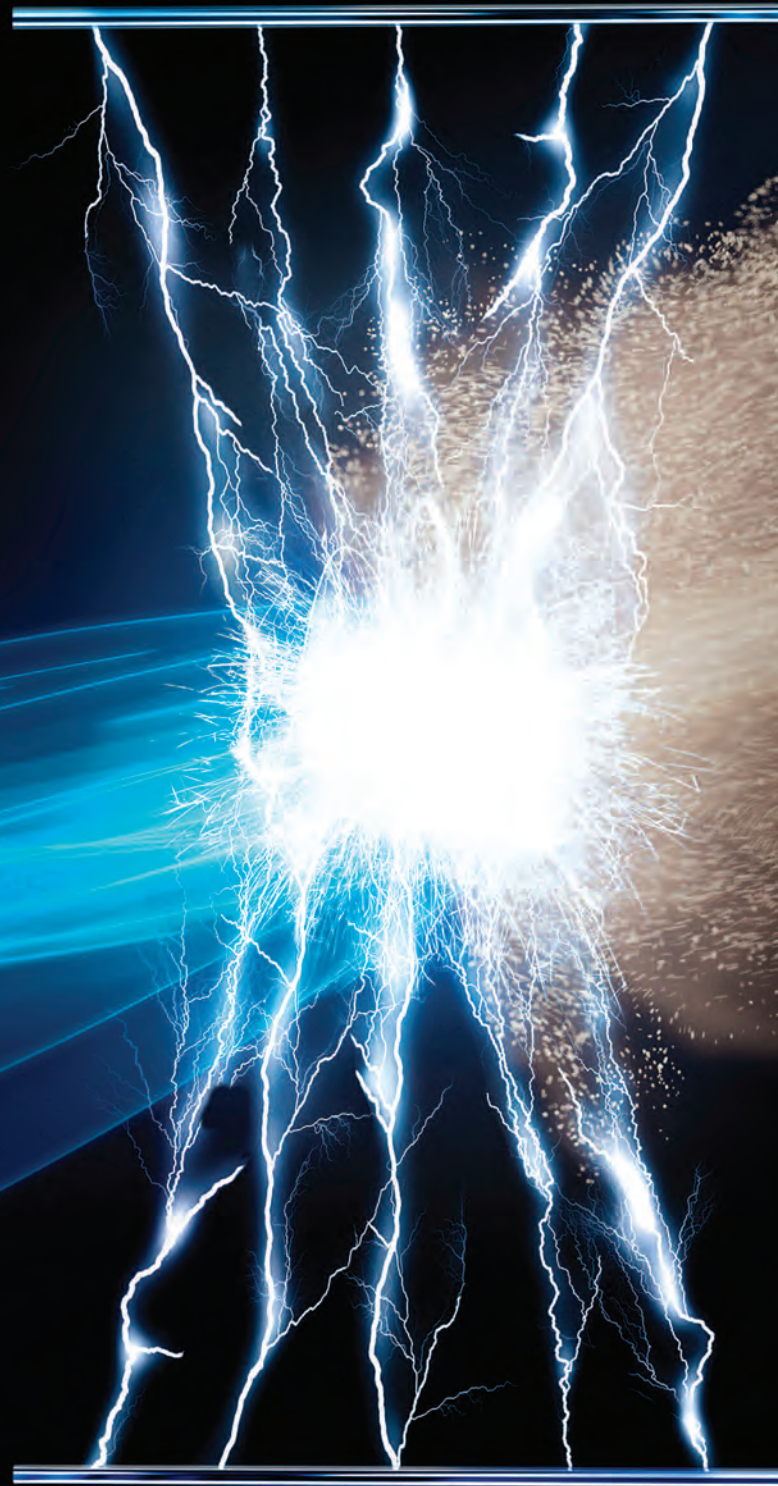

Bacteria

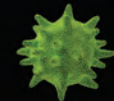

Viruses



Allergens



Dust



Moulds



Microparticle
(PM2.5)

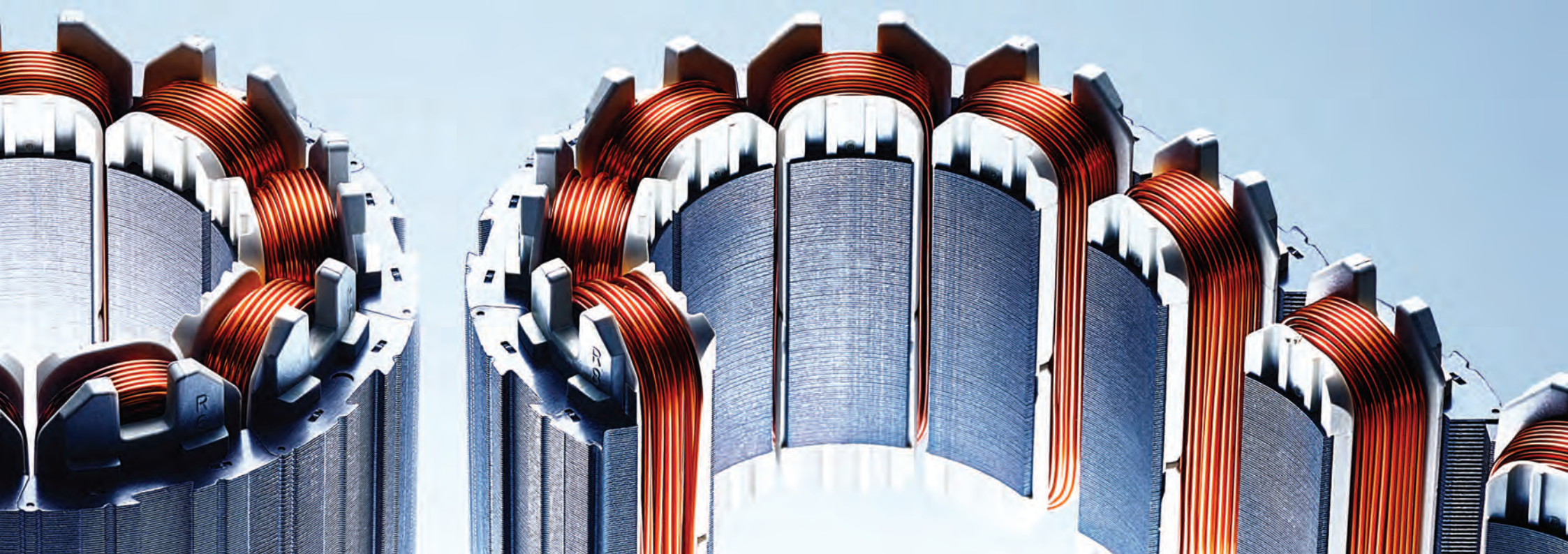

Built using micron-precise calculations, the compressor is the heart of the MSZ-LN air conditioning system



Poki-Poki Motor



Dramatically enhanced motor efficiency utilising Mitsubishi Electric's original dense winding technology.

Heat Caulking



Mitsubishi Electric's heat caulking method minimises cylinder distortion for even greater efficiency.

Designed to provide powerful heating,
even on bitterly cold or snowy days

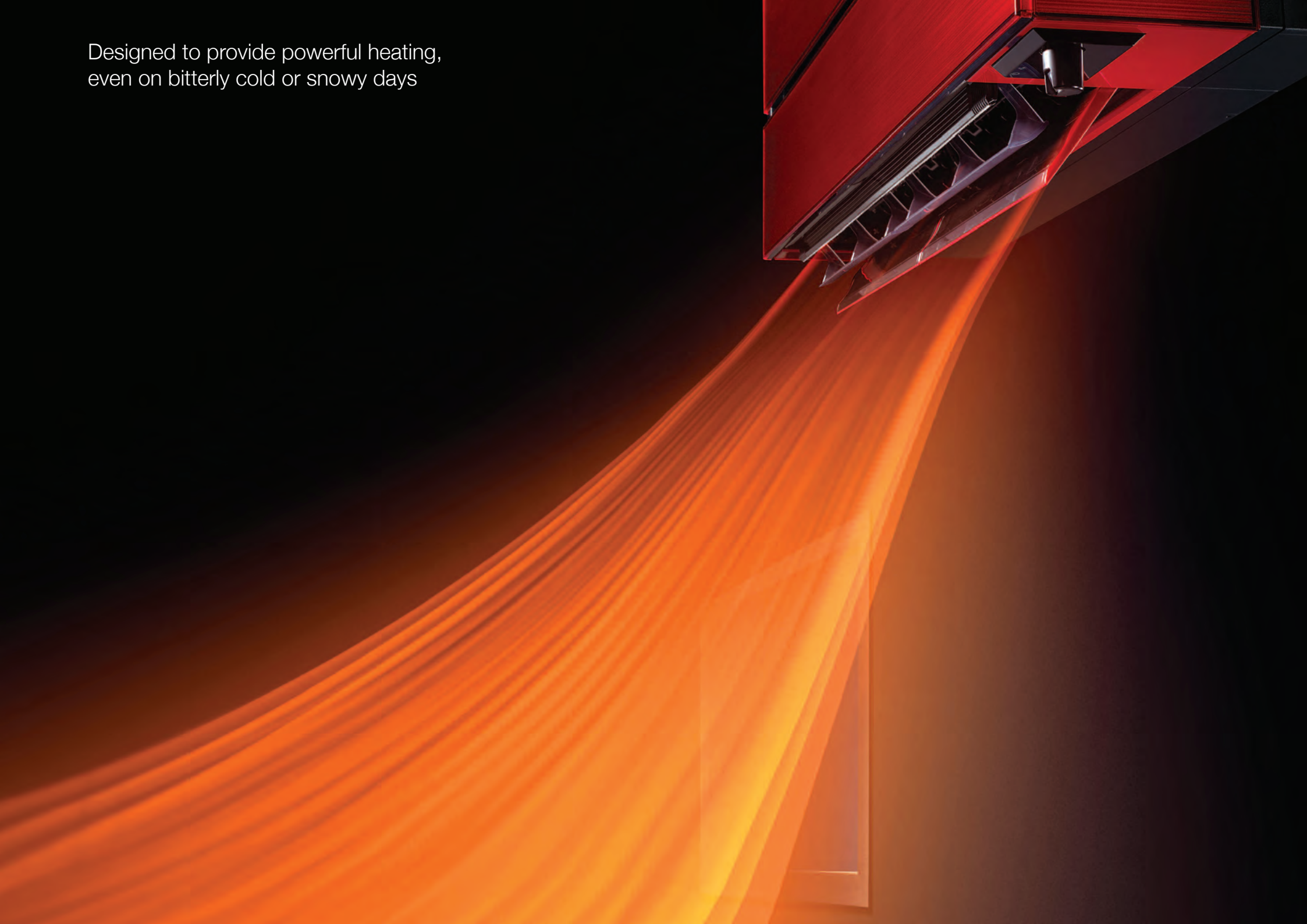

Solutions that address the ban on R22 refrigerant

As of 1st January 2015 it became illegal to use R22 refrigerant^{*1} to service and maintain air conditioning units, yet there are a large number of systems still in use in the UK that rely on R22.

Many of these building operators remain unaware that whilst their air conditioning will not be illegal to run, it may need immediate replacement if it requires maintenance involving any degassing of the system.

The continual rise in energy costs also means everyone involved in the built environment is focusing on energy use and consumption and this is where modern equipment can really help to support replacement.

The MSZ-LN models incorporate our unique '**Replace Technology**' which allows the upgrade of systems using existing pipe work, without the need to apply any special cleaning machines.

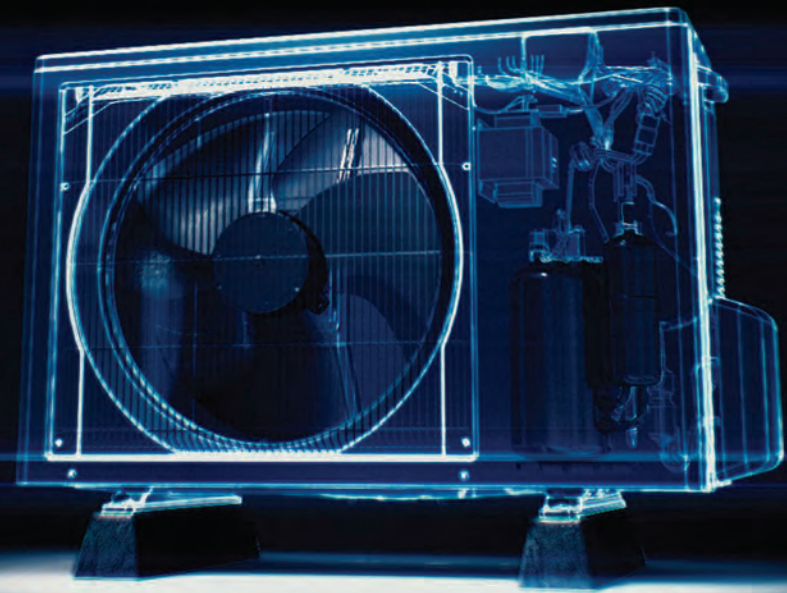

^{*1} The EC Ozone Regulation (No.1005/2009) was introduced to control and phase out the remaining uses of all Ozone Depleting Substances (ODS) such as R22 refrigerant. This has led to a total ban on its use for service and maintenance by the start of the year 2015. ODS can result in greater UV radiation reaching the earth's surface which is harmful for humans, animals and plants, leading to increases in skin cancer, cataracts and a reduction in food crop yields. Modern alternatives such as HFC's, which include R32, do not have the same ozone depleting potential (ODP).

MSZ-LN Inverter Heat Pump Wall Mounted System

Product Specifications

M series



MSZ-LN18/25/35/50/60VGR Ruby Red (R)



MSZ-LN18/25/35/50/60VGV Pearl White (V)



MSZ-LN18/25/35/50/60VGB Onyx Black (B)



MSZ-LN18/25/35/50/60VGW Natural White (W)

MSZ-LN - INDOOR UNITS		MSZ-LN18VG R/B/W/W	MSZ-LN25VG R/B/V/W	MSZ-LN35VG R/B/V/W	MSZ-LN50VG R/B/V/W	MSZ-LN60VG R/B/V/W
CAPACITY (KW)	Heating (nominal)	2.0 (0.9 - 4.0)	3.2 (0.8 - 5.4)	4.0 (1.0 - 6.3)	6.0 (1.0 - 8.2)	6.8 (1.8 - 9.3)
	Cooling (nominal)	1.8 (0.9 - 3.0)	2.5 (1.0 - 3.5)	3.5 (0.8 - 4.0)	5.0 (1.0 - 6.0)	6.1 (1.4 - 6.9)
	Heating (UK)	-	2.64 (0.66 - 4.45)	3.3 (0.83 - 5.2)	4.94 (0.82 - 6.75)	5.6 (1.48 - 7.66)
	Cooling (UK)	-	2.48 (0.99 - 3.47)	3.47 (0.79 - 3.96)	4.95 (0.99 - 5.94)	6.05 (1.38 - 6.84)
SHF (nominal)		-	0.97	0.90	0.77	0.75
COP / EER (nominal)		-	5.52 / 5.15	5.00 / 4.27	4.05 / 3.62	3.76 / 3.41
SCOP / SEER (BS EN14825)		-	5.2 / 10.5	5.1 / 9.5	4.6 / 8.5	4.6 / 7.5
ErP ENERGY EFFICIENCY CLASS	Heating/Cooling	-	A+++ / A+++	A+++ / A+++	A++ / A+++	A++ / A++
AIRFLOW (l/s)	Heating (SLo-Lo-Mid-Hi-SHi)	67-95-118-142-240	67-95-118-142-240	71-97-118-142-228	90-107-142-178-262	110-158-192-227-262
	Cooling (SLo-Lo-Mid-Hi-SHi)	71-97-118-147-198	71-97-118-147-198	71-97-118-147-213	95-127-148-177-232	118-147-177-212-262
PIPE SIZE MM (in)	Gas	9.52 (3/8")	9.52 (3/8")	9.52 (3/8")	9.52 (3/8")	12.7 (1/2")
	Liquid	6.35 (1/4")	6.35 (1/4")	6.35 (1/4")	6.35 (1/4")	6.35 (1/4")
SOUND PRESSURE LEVEL (dBA)	Heating (SLo-Lo-Mid-Hi-SHi)	19-24-29-36-45	19-24-29-36-45	19-24-29-36-45	25-29-34-39-47	29-37-41-45-49
	Cooling (SLo-Lo-Mid-Hi-SHi)	19-23-29-36-42	19-23-29-36-42	19-24-29-36-43	27-31-35-39-46	29-37-41-45-49
SOUND POWER LEVEL (dBA)		58	58	58	60	65
DIMENSIONS (mm)	Width x Depth x Height	890 x 233 x 307	890 x 233 x 307	890 x 233 x 307	890 x 233 x 307	890 x 233 x 307
WEIGHT (kg)		15.5	15.5	15.5	15.5	15.5
ELECTRICAL SUPPLY		Fed by Outdoor Unit	Fed by Outdoor Unit	Fed by Outdoor Unit	Fed by Outdoor Unit	Fed by Outdoor Unit
FUSE RATING (BS88) - HRC (A)		6	6	6	6	6
INTERCONNECTING CABLE No. CORES		4	4	4	4	4

Notes: MSZ-LN18VG is for use with MXZ-F Multi-Split outdoor units only.



MUZ-LN - OUTDOOR UNITS		MUZ-LN25VG	MUZ-LN35VG	MUZ-LN50VG	MUZ-LN60VG
SOUND PRESSURE LEVEL (dBA)	Heating/Cooling	49 / 46	50 / 49	54 / 51	55 / 55
SOUND POWER LEVEL (dBA)	Cooling	60	61	64	65
WEIGHT (kg)		35	35	40	55
DIMENSIONS (mm)	Width x Depth x Height	800 x 285 x 550	800 x 285 x 550	800 x 285 x 714	840 x 330 x 880
ELECTRICAL SUPPLY		220-240v, 50Hz	220-240v, 50Hz	220-240v, 50Hz	220-240v, 50Hz
PHASE		Single	Single	Single	Single
SYSTEM POWER INPUT (kW)	Heating/Cooling (nominal)	0.580 / 0.485	0.800 / 0.820	1.480 / 1.380	1.810 / 1.790
	Heating/Cooling (UK)	0.523 / 0.406	0.722 / 0.686	1.335 / 1.151	1.632 / 1.494
STARTING CURRENT (A)		3.0	4.0	6.8	7.9
SYSTEM RUNNING CURRENT (A)	Heating/Cooling [MAX]	3.0 / 2.5 [7.1]	4.0 / 3.9 [9.9]	6.8 / 6.3 [13.9]	7.9 / 7.9 [15.2]
FUSE RATING (BS88) - HRC (A)		10	10	16	16
MAINS CABLE No. CORES		3	3	3	3
MAX PIPE LENGTH (m)		20	20	20	30
MAX HEIGHT DIFFERENCE (m)		12	12	12	15
CHARGE (kg) / CO ₂ EQUIVALENT (t) - R32 (GWP 675) - 7m		1.0 / 0.68	1.0 / 0.68	1.25 / 0.85	1.45 / 0.98
MAX ADDED QUANTITY (kg) / CO ₂ EQUIVALENT (t) - R32 (GWP 675)		0.26 / 0.18	0.26 / 0.18	0.26 / 0.18	0.46 / 0.32

MSZ-LN Inverter Heat Pump Wall Mounted System

Product Dimensions

M series

MSZ-LN18/25/35/50/60VG R/B/V/W

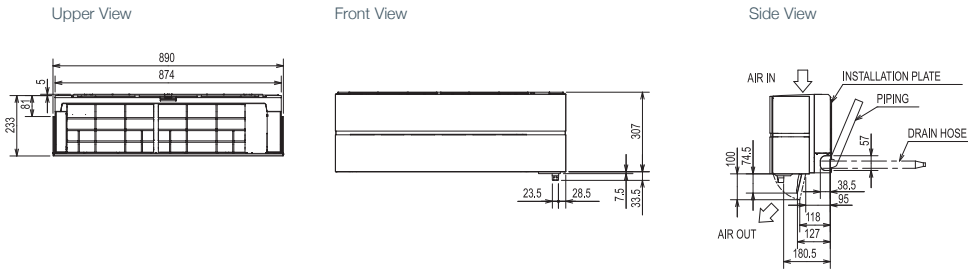

MUZ-LN50VG

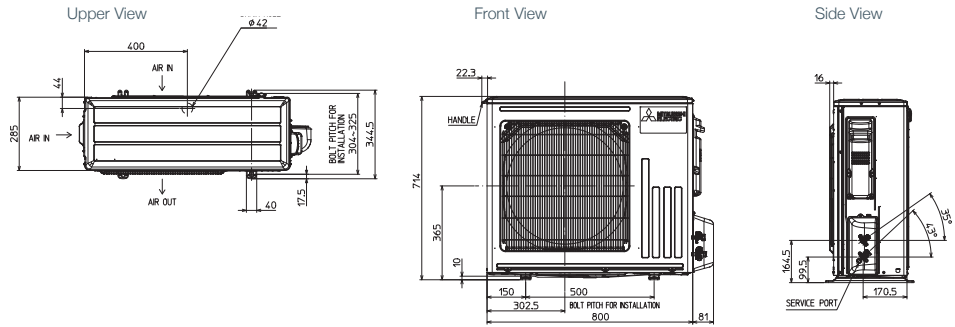

MUZ-LN25/35VG

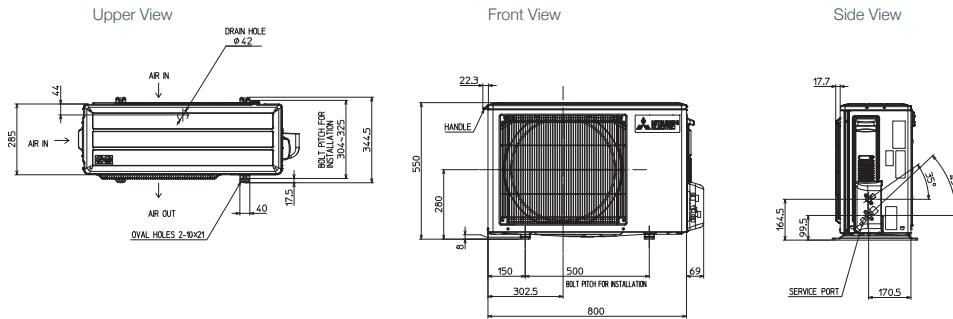

MUZ-LN60VG

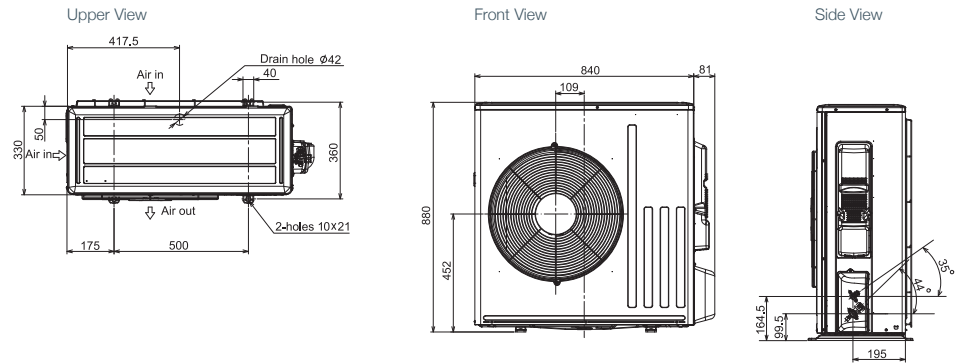

Telephone: 01707 282880

email: air.conditioning@meuk.mee.com web: airconditioning.mitsubishielectric.co.uk microsite: timeforR32.co.uk

UNITED KINGDOM Mitsubishi Electric Europe Living Environment Systems Division, Travellers Lane, Hatfield, Hertfordshire, AL10 8XB, England. General Enquiries Telephone: 01707 282880 Fax: 01707 278881
 IRELAND Mitsubishi Electric Europe, Westgate Business Park, Ballymount, Dublin 24, Ireland. Telephone: Dublin (01) 419 8800 Fax: Dublin (01) 419 8890 International code: (003531)

Country of origin: United Kingdom – Japan – Thailand – Malaysia. ©Mitsubishi Electric Europe 2018. Mitsubishi and Mitsubishi Electric are trademarks of Mitsubishi Electric Europe B.V. The company reserves the right to make any variation in technical specification to the equipment described, or to withdraw or replace products without prior notification or public announcement. Mitsubishi Electric is constantly developing and improving its products. All descriptions, illustrations, drawings and specifications in this publication present only general particulars and shall not form part of any contract. All goods are supplied subject to the Company's General Conditions of Sale, a copy of which is available on request. Third-party product and brand names may be trademarks or registered trademarks of their respective owners.

Note: The fuse rating is for guidance only. Please refer to the relevant databook for detailed specification. It is the responsibility of a qualified electrician/electrical engineer to select the correct cable size and fuse rating based on current regulation and site specific conditions. Mitsubishi Electric's air conditioning equipment and heat pump systems contain a fluorinated greenhouse gas, R410A (GWP:2088), R32 (GWP:675), R407C (GWP:1774) or R134a (GWP:1430). *These GWP values are based on Regulation (EU) No 517/2014 from IPCC 4th edition. In case of Regulation (EU) No.626/2011 from IPCC 3rd edition, these are as follows. R410A (GWP:1975), R32 (GWP: 550), R407C (GWP:1650) or R134a (GWP:1300).



www.greengateway.mitsubishielectric.co.uk

Mitsubishi Electric UK's commitment to the environment

Follow us @meuk_les
 Follow us @green_gateway

Mitsubishi Electric
 Living Environmental Systems I

mitsubishielectric2

thehub.mitsubishielectric.co.uk

Effective as of November 2018
 SAP No. 306985



timeforR32.co.uk