

**Кондиционеры
ВНУТРЕННИЙ БЛОК
Air-Conditioners
INDOOR UNIT
PEA-RP200,250WKA****OPERATION MANUAL****FOR USER**

For safe and correct use, please read this operation manual thoroughly before operating the air-conditioner unit.

English**BEDIENUNGSHANDBUCH****FÜR BENUTZER**

Zum sicheren und einwandfreien Gebrauch der Klimaanlage dieses Bedienungshandbuch vor Inbetriebnahme gründlich durchlesen.

Deutsch**MANUEL D'UTILISATION****POUR L'UTILISATEUR**

Pour une utilisation correcte sans risques, veuillez lire le manuel d'utilisation en entier avant de vous servir du climatiseur.

Français**MANUAL DE INSTRUCCIONES****PARA EL USUARIO**

Lea este manual de instrucciones hasta el final antes de poner en marcha la unidad de aire acondicionado para garantizar un uso seguro y correcto.

Español**ISTRUZIONI DI FUNZIONAMENTO****PER L'UTENTE**

Leggere attentamente questi istruzioni di funzionamento prima di avviare l'unità, per un uso corretto e sicuro della stessa.

Italiano**BEDIENINGSHANDLEIDING****VOOR DE GEBRUIKER**

Voor een veilig en juist gebruik moet u deze bedieningshandleiding grondig doorlezen voordat u de airconditioner gebruikt.

Nederlands**DRIFTSMANUAL****FÖR ANVÄNDAREN**

Läs denna driftsmanual noga för säkert och korrekt bruk innan luftkonditioneringen används.

Svenska**DRIFTSMANUAL****TIL BRUGER**

Læs venligst denne driftsmanual grundigt før airconditionanlægget betjenes af hensyn til sikker og korrekt brug.

Dansk**MANUAL DE OPERAÇÃO****PARA O UTILIZADOR**

Para segurança e utilização correctas, leia atentamente o manual de operação antes de pôr a funcionar a unidade de ar condicionado.

Português**ΕΓΧΕΙΡΙΔΙΟ ΟΔΗΓΙΩΝ ΧΡΗΣΕΩΣ****ΓΙΑ ΤΟΝ ΧΡΗΣΤΗ**

Για ασφάλεια και σωστή χρήση, παρακαλείστε διαβάσετε προσεχτικά αυτό το εγχειρίδιο χρήσεως πριν θέσετε σε λειτουργία τη μονάδα κλιματισμού.

Ελληνικά**РУКОВОДСТВО ПО ЭКСПЛУАТАЦИИ****ДЛЯ ПОЛЬЗОВАТЕЛЯ**

Для обеспечения правильного и безопасного использования следует ознакомиться с инструкциями, указанными в данном руководстве по эксплуатации, тщательным образом до того, как приступить к использованию кондиционера.

Русский**İŞLETME ELKİTABI****KULLANICI İÇİN**

Emniyetli ve doğru biçimde nasıl kullanılacağını öğrenmek için lütfen klima cihazını işletmeden önce bu elkitabını dikkatle okuyunuz.

Türkçe

Contents

1. Safety Precautions	2	5. Emergency Operation for Wireless Remote-controller (option)	9
2. Parts Names	3	6. Trouble Shooting	10
3. Operation	6	7. Specifications	11
4. Timer	9		

Note



Fig. 1

This symbol mark is for EU countries only.

This symbol mark is according to the directive 2012/19/EU Article 14 Information for users and Annex IX, and/or to the directive 2006/66/EC Article 20 Information for end-users and Annex II.

Your MITSUBISHI ELECTRIC product is designed and manufactured with high quality materials and components which can be recycled and/or reused. This symbol means that electrical and electronic equipment, batteries and accumulators, at their end-of-life, should be disposed of separately from your household waste. If a chemical symbol is printed beneath the symbol (Fig. 1), this chemical symbol means that the battery or accumulator contains a heavy metal at a certain concentration.

This will be indicated as follows: Hg: mercury (0.0005%), Cd: cadmium (0.002%), Pb: lead (0.004%)

In the European Union there are separate collection systems for used electrical and electronic products, batteries and accumulators.

Please, dispose of this equipment, batteries and accumulators correctly at your local community waste collection/recycling centre.

Please, help us to conserve the environment we live in!

Note:

The phrase "Wired remote controller" in this operation manual refers only to the PAR-32MAA. If you need any information for the other remote controller, please refer to the instruction book included in this box.

1. Safety Precautions

- ▶ Before installing the unit, make sure you read all the "Safety Precautions".
- ▶ The "Safety Precautions" provide very important points regarding safety. Make sure you follow them.
- ▶ Please report to or take consent by the supply authority before connection to the system.

Symbols used in the text

⚠ Warning:

Describes precautions that should be observed to prevent danger of injury or death to the user.

⚠ Caution:

Describes precautions that should be observed to prevent damage to the unit.

Symbols used in the illustrations

⚡ : Indicates a part which must be grounded.

⚠ Warning:

- The unit must not be installed by the user. Ask the dealer or an authorized company to install the unit. If the unit is installed improperly, water leakage, electric shock or fire may result.
- Do not stand on, or place any items on the unit.
- Do not splash water over the unit and do not touch the unit with wet hands. An electric shock may result.
- Do not spray combustible gas close to the unit. Fire may result.
- Do not place a gas heater or any other open-flame appliance where it will be exposed to the air discharged from the unit. Incomplete combustion may result.
- Do not remove the front panel or the fan guard from the outdoor unit when it is running.
- When you notice exceptionally abnormal noise or vibration, stop operation, turn off the power switch, and contact your dealer.
- Never insert fingers, sticks etc. into the intakes or outlets.

- If you detect odd smells, stop using the unit, turn off the power switch and consult your dealer. Otherwise, a breakdown, electric shock or fire may result.
- This air conditioner is NOT intended for use by children or infirm persons without supervision.
- Young children must be supervised to ensure that they do not play with the air conditioner.
- If the refrigeration gas blows out or leaks, stop the operation of the air conditioner, thoroughly ventilate the room, and contact your dealer.
- Do not use refrigerant other than the type indicated in the manuals provided with the unit and on the nameplate.
 - Doing so may cause the unit or pipes to burst, or result in explosion or fire during use, during repair, or at the time of disposal of the unit.
 - It may also be in violation of applicable laws.
 - MITSUBISHI ELECTRIC CORPORATION cannot be held responsible for malfunctions or accidents resulting from the use of the wrong type of refrigerant.

⚠ Caution:

- Do not use any sharp object to push the buttons, as this may damage the remote controller.
- Never block or cover the indoor or outdoor unit's intakes or outlets.

Disposing of the unit

When you need to dispose of the unit, consult your dealer.

2. Parts Names

Indoor Unit

	PEA-RP-WKA
Fan steps	3 steps
Vane	—
Louver	—
Filter	Normal
Filter cleaning indication	—

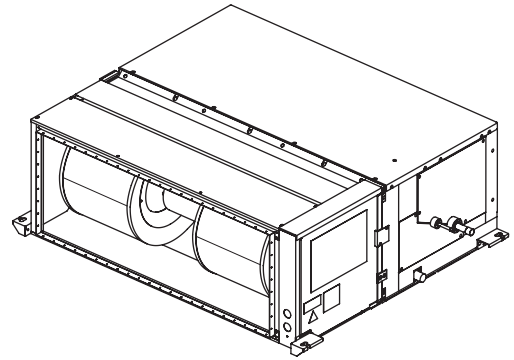

Wired Remote Controller (option)

Controller interface

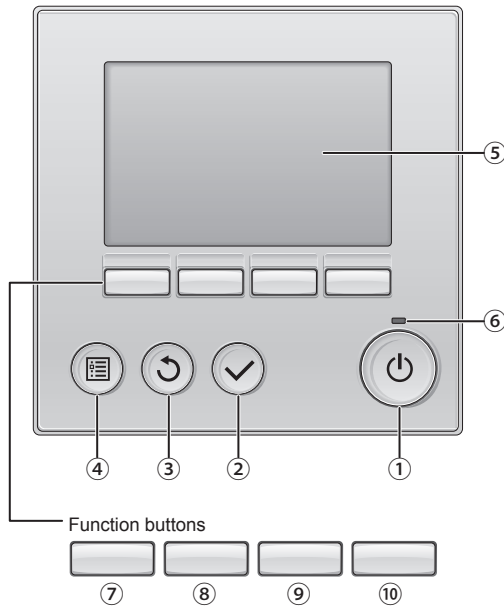

The functions of the function buttons change depending on the screen.

Refer to the button function guide that appears at the bottom of the LCD for the functions they serve on a given screen.

When the system is centrally controlled, the button function guide that corresponds to the locked button will not appear.

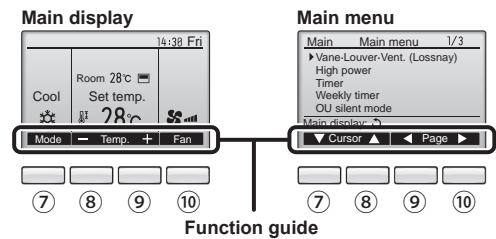

Function guide

① [ON/OFF] button

Press to turn ON/OFF the indoor unit.

② [SELECT] button

Press to save the setting.

③ [RETURN] button

Press to return to the previous screen.

④ [MENU] button

Press to bring up the Main menu.

⑤ Backlit LCD

Operation settings will appear.

When the backlight is off, pressing any button turns the backlight on and it will stay lit for a certain period of time depending on the screen.

When the backlight is off, pressing any button turns the backlight on and does not perform its function. (except for the [ON/OFF] button)

⑥ ON/OFF lamp

This lamp lights up in green while the unit is in operation. It blinks while the remote controller is starting up or when there is an error.

⑦ Function button [F1]

Main display: Press to change the operation mode.

Main menu: Press to move the cursor down.

⑧ Function button [F2]

Main display: Press to decrease temperature.

Main menu: Press to move the cursor up.

⑨ Function button [F3]

Main display: Press to increase temperature.

Main menu: Press to go to the previous page.

⑩ Function button [F4]

Main display: Press to change the fan speed.

Main menu: Press to go to the next page.

2. Parts Names

Display

The main display can be displayed in two different modes: "Full" and "Basic". The factory setting is "Full". To switch to the "Basic" mode, change the setting on the Main display setting. (Refer to operation manual included with remote controller.)

<Full mode>

* All icons are displayed for explanation.

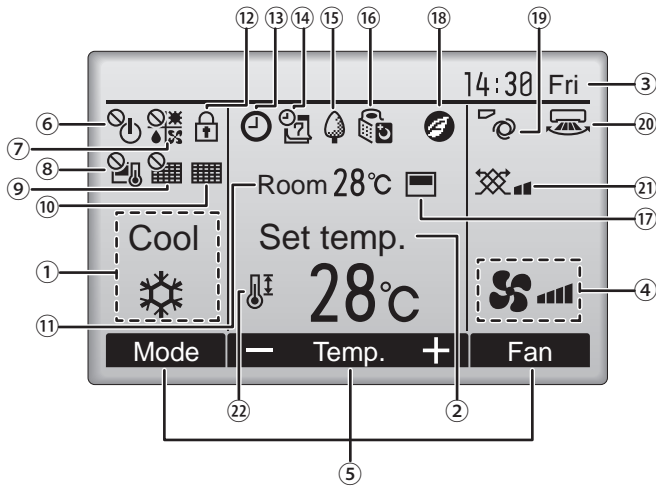

<Basic mode>

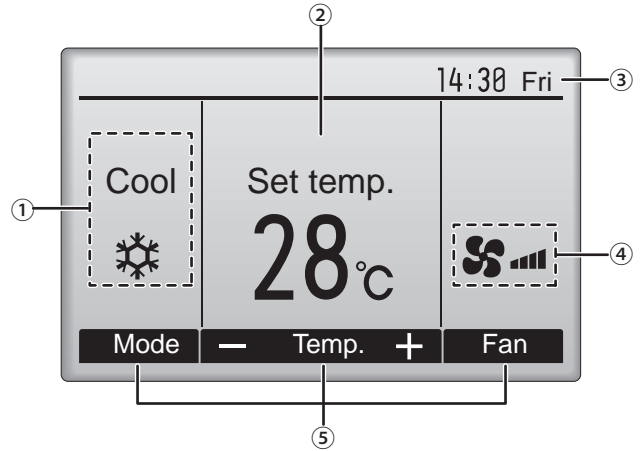

① Operation mode

Indoor unit operation mode appears here.

② Preset temperature

Preset temperature appears here.

③ Clock (See the Installation Manual.)

Current time appears here.

④ Fan speed

Fan speed setting appears here.

⑤ Button function guide

Functions of the corresponding buttons appear here.



Appears when the ON/OFF operation is centrally controlled.



Appears when the operation mode is centrally controlled.



Appears when the preset temperature is centrally controlled.



Appears when the filter reset function is centrally controlled.



Indicates when filter needs maintenance.

⑪ Room temperature (See the Installation Manual.)

Current room temperature appears here.



Appears when the buttons are locked.



Appears when the On/Off timer, Night setback, or Auto-off timer function is enabled.

 appears when the timer is disabled by the centralized control system.



Appears when the Weekly timer is enabled.



Appears while the units are operated in the energy-save mode. (Will not appear on some models of indoor units)



Appears while the outdoor units are operated in the silent mode.



Appears when the built-in thermistor on the remote controller is activated to monitor the room temperature (⑪).

 appears when the thermistor on the indoor unit is activated to monitor the room temperature.



Appears when the units are operated in the energy-save mode with 3D i-see Sensor.



Indicates the vane setting.



Indicates the louver setting.



Indicates the ventilation setting.



Appears when the preset temperature range is restricted.

Most settings (except ON/OFF, mode, fan speed, temperature) can be made from the Menu screen. (Refer to operation manual included with remote controller.)

2. Parts Names

■ Wireless Remote-Controller (option)

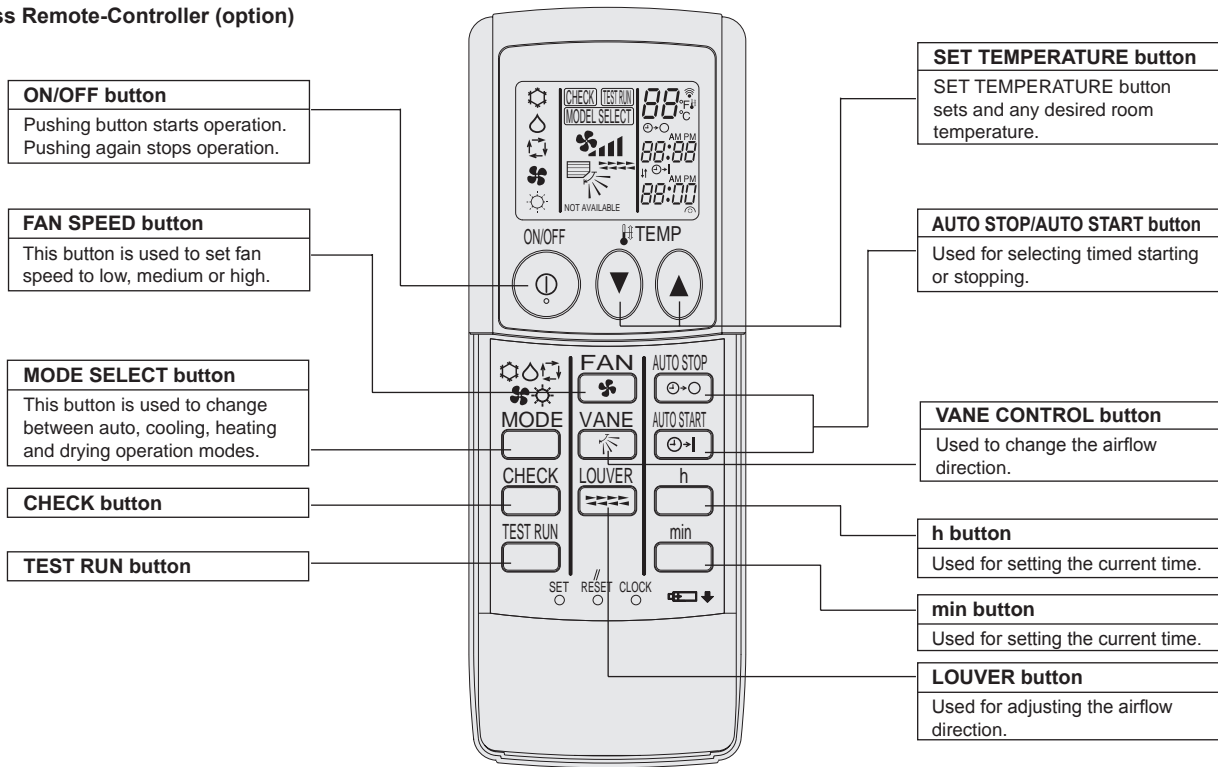

- When using the wireless remote controller, point it towards the receiver on the indoor unit.
- If the remote controller is operated within approximately two minutes after power is supplied to the indoor unit, the indoor unit may beep twice as the unit is performing the initial automatic check.
- The indoor unit beeps to confirm that the signal transmitted from the remote controller has been received. Signals can be received up to approximately 7 meters in a direct line from the indoor unit in an area 45° to the left and right of the unit. However, illumination such as fluorescent lights and strong light can affect the ability of the indoor unit to receive signals.
- If the operation lamp near the receiver on the indoor unit is flashing, the unit needs to be inspected. Consult your dealer for service.
- Handle the remote controller carefully! Do not drop the remote controller or subject it to strong shocks. In addition, do not get the remote controller wet or leave it in a location with high humidity.
- To avoid misplacing the remote controller, install the holder included with the remote controller on a wall and be sure to always place the remote controller in the holder after use.

Battery installation/replacement

1. Remove the top cover, insert two AAA batteries, and then install the top cover.

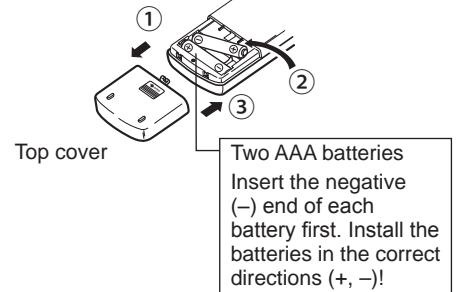

2. Press the Reset button.

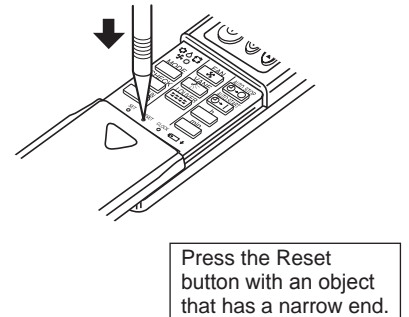

3. Operation

■ About the operation method, refer to the operation manual that comes with each remote controller.

3.1. Turning ON/OFF

3.1.1. For wired remote controller

[ON]

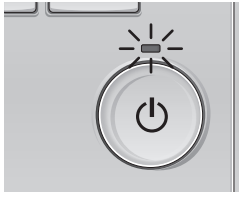

Press the [ON/OFF] button.
The ON/OFF lamp will light up in green, and the operation will start.

[OFF]

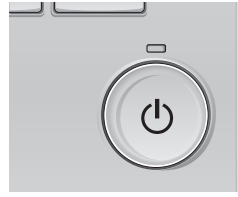

Press the [ON/OFF] button again.
The ON/OFF lamp will come off, and the operation will stop.

■ Operation status memory

	Remote controller setting
Operation mode	Operation mode before the power was turned off
Preset temperature	Preset temperature before the power was turned off
Fan speed	Fan speed before the power was turned off

■ Settable preset temperature range

Operation mode	Preset temperature range
Cool/Dry	19 – 30 °C
Heat	17 – 28 °C
Auto	19 – 28 °C
Fan/Ventilation	Not settable

3.1.2. For wireless remote controller

[ON]

■ Press the ON/OFF button ①.

Note:

● When the unit is restarted, initial settings are as follows.

	Remote Controller settings		
Mode	Last operation mode		
Temperature setting	Last set temperature		
Fan speed	Last set fan speed		
Airflow up/down	Mode	COOL or DRY	Horiz. outlet
		HEAT	Last setting
		FAN	Horiz. outlet

[OFF]

■ Press the ON/OFF button ① again.

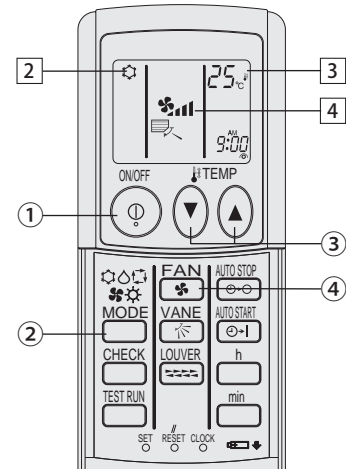

(option)

Note:

Even if you press the ON/OFF button immediately after shutting down the operation is progress, the air conditioner will not start for about three minutes. This is to prevent the internal components from being damaged.

3.2. Mode select

3.2.1. For wired remote controller

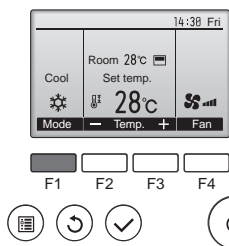

Press the [F1] button to go through the operation modes in the order of "Cool", "Dry", "Fan", "Auto", and "Heat". Select the desired operation mode.

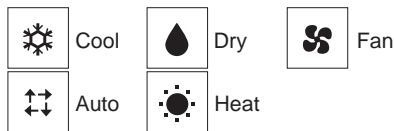

• Operation modes that are not available to the connected indoor unit models will not appear on the display.

3.2.2. For wireless remote controller

■ Press the operation mode (□❄️🌧️🌀🔥) button ② and select the operation mode ③.

- ▶️ ❄️ Cooling mode
- ▶️ 🌧️ Drying mode
- ▶️ 🌀 Fan mode
- ▶️ 🔥 Heating mode
- ▶️ □ Automatic (cooling/heating) mode
- ▶️ 🌀 Ventillation mode

Only indicated on the following condition
Wired remote controller used
LOSSNAY connected

What the blinking mode icon means

The mode icon will blink when other indoor units in the same refrigerant system (connected to the same outdoor unit) are already operated in a different mode. In this case, the rest of the unit in the same group can only be operated in the same mode.

3. Operation

Information for multi system air conditioner (Outdoor unit: MXZ series)

► Multi system air conditioner (Outdoor unit: MXZ series) can connect two or more indoor units with one outdoor unit. According to the capacity, two or more units can operate simultaneously.

- When you try to operate two or more indoor units with one outdoor unit simultaneously, one for the cooling and the other for heating, the operation mode of the indoor unit that operates earlier is selected. The other indoor units that will start the operation later cannot operate, indicating an operation state in flashing.
- In this case, please set all the indoor units to the same operation mode.
- There might be a case that the indoor unit, which is operating in (AUTO) mode. Cannot change over to the operating mode (COOL ↔ HEAT) and becomes a state of standby.
- When indoor unit starts the operation while the defrosting of outdoor unit is being done, it takes a few minutes (max. about 15 minutes) to blow out the warm air.
- In the heating operation, though indoor unit that does not operate may get warm or the sound of refrigerant flowing may be heard, they are not malfunction. The reason is that the refrigerant continuously flows into it.

Automatic operation

- According to a set temperature, cooling operation starts if the room temperature is too hot and heating operation starts if the room temperature is too cold.
- During automatic operation, if the room temperature changes and remains 2 °C or more above the set temperature for 15 minutes, the air conditioner switches to cooling mode. In the same way, if the room temperature remains 2 °C or more below the set temperature for 15 minutes, the air conditioner switches to heating mode.

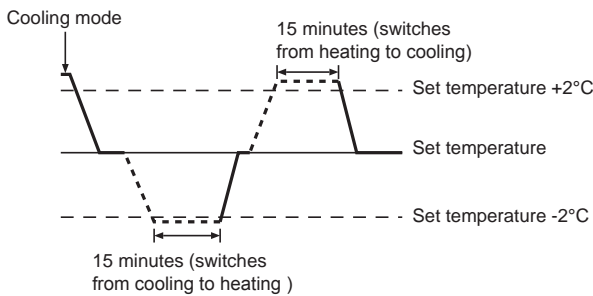

- Because the room temperature is automatically adjusted in order to maintain a fixed effective temperature, cooling operation is performed a few degrees warmer and heating operation is performed a few degrees cooler than the set room temperature once the temperature is reached (automatic energy-saving operation).

3.3. Temperature setting

3.3.1. For wired remote controller

<Cool, Dry, Heat, and Auto>

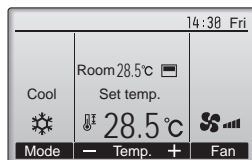
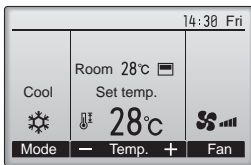

Example display (Centigrade in 0.5-degree increments)

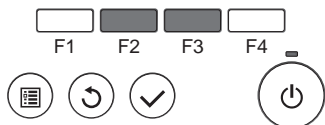

Press the [F2] button to decrease the preset temperature, and press the [F3] button to increase.

- Refer to the table on page 6 for the settable temperature range for different operation modes.
- Preset temperature range cannot be set for Fan/Ventilation operation.
- Preset temperature will be displayed either in Centigrade in 0.5- or 1-degree increments, or in Fahrenheit, depending on the indoor unit model and the display mode setting on the remote controller.

3.3.2. For wireless remote controller

► To decrease the room temperature:

- Press (▼) button (3) to set the desired temperature. The selected temperature is displayed (3).

- Each time you press the button, the temperature value decreases by 1 °C.

► To increase the room temperature:

- Press (▲) button (3) to set the desired temperature. The selected temperature is displayed (3).

- Each time you press the button, the temperature value decreases by 1 °C.

- Available temperature ranges are as follows:

- Cooling/Drying: 19 - 30 °C
- Heating: 17 - 28 °C
- Automatic: 19 - 28 °C

- The display flashes either 8 °C - 39 °C to inform you if the room temperature is lower or higher than the displayed temperature.

3.4. Fan speed setting

3.4.1. For wired remote controller

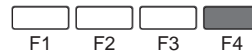
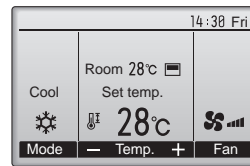

Press the [F4] button to go through the fan speeds in the following order.

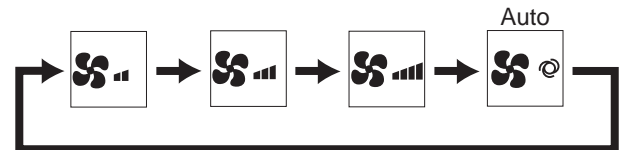

3.4.2. For wireless remote controller

■ Press (4) button to select a desired fan speed.

- Each time you press the button, available options change with the display (4) on the remote controller, as shown below.

Fan speed	Remote controller display			
	Low	Medium	High	Auto
3-stage	(3-stage icon)	(2-stage icon)	(1-stage icon)	(Auto icon)

Notes:

- In the following cases, the actual fan speed generated by the unit will differ from the speed shown the remote controller display.
 1. While the display is in "STAND BY" or "DEFROST" states.
 2. When the temperature of the heat exchanger is low in the heating mode. (e.g. immediately after heating operation starts)
 3. In HEAT mode, when room temperature is higher than the temperature setting.
 4. When the unit is in DRY mode.

3. Operation

3.5. Ventillation (For wired remote controller)

3.5.1. Navigating through the Main menu

<Accessing the Main menu>

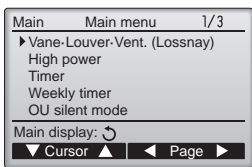

Press the [MENU] button.
The Main menu will appear.

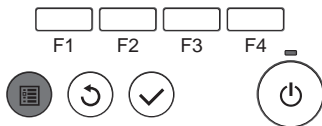

<Item selection>

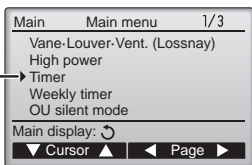

Press [F1] to move the cursor down.
Press [F2] to move the cursor up.

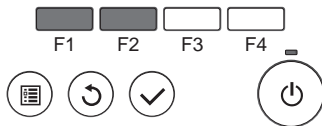

<Navigating through the pages>

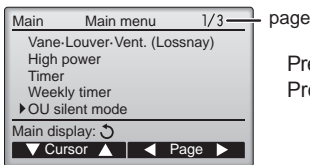

Press [F3] to go to the previous page.
Press [F4] to go to the next page.

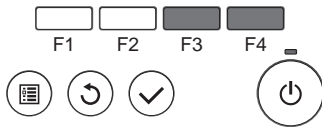

<Saving the settings>



Select the desired item, and press the [SELECT] button.

The screen to set the selected item will appear.

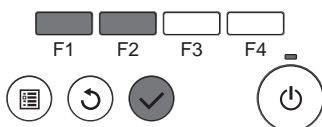

<Exiting the Main menu screen>

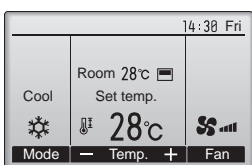

Press the [RETURN] button to exit the Main menu and return to the Main display.

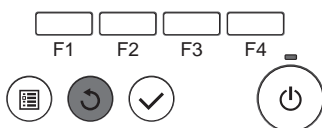

If no buttons are touched for 10 minutes, the screen will automatically return to the Main display. Any settings that have not been saved will be lost.

<Display of unsupported functions>

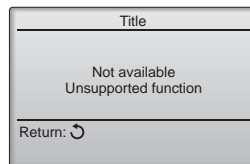

The message at left will appear if the user selects a function not supported by the corresponding indoor unit model.

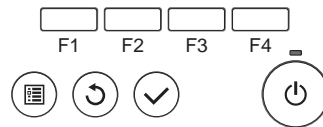

3.5.2. Vane-Vent. (Lossnay)

<Accessing the menu>

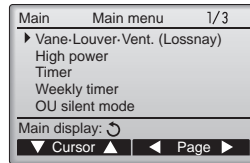

Select "Vane-Louver-Vent. (Lossnay)" from the Main menu, and press the [SELECT] button.

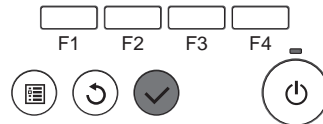

<Vent. setting>

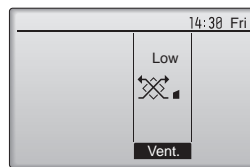

Press the [F3] button to go through the ventilation setting options in the order of "Off", "Low", and "High".

* Settable only when LOSSNAY unit is connected.



The fan on some models of indoor units may be interlocked with certain models of ventilation units.

<Returning to the Main menu>

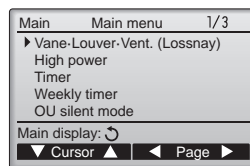

Press the [RETURN] button to go back to the Main menu.

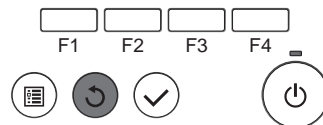

3.6. Ventillation (For wireless remote controller)

- The ventilator will automatically operate when the indoor unit turns on.
- No indication on the wireless remote controller.

4. Timer

- Timer functions are different by each remote controller.
- For details on how to operate the remote controller, refer to the appropriate operation manual included with each remote controller.

4.1. For wireless remote controller

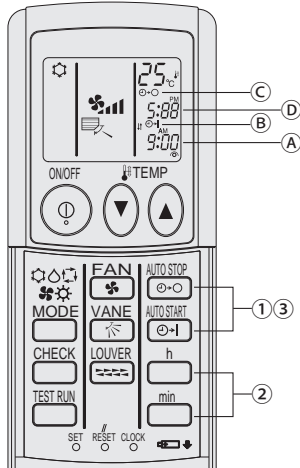

1) Set the current time

- 1) Press the CLOCK button using a thin stick and blink the time (A).
- 2) Press the ^h and ^{min} button to set the current time.
- 3) Press the CLOCK button using a thin stick.

2) Set the time to start the unit as follows

- 1) Press the ^{AUTO STOP} button.
 - Time can be set while the following symbol is blinking.
 - On time: (B) START is blinking.
 - The start times is displayed at (A).
- 2) Use the ^h and ^{min} buttons to set the desired time.
- 3) To cancel the ON timer, press the ^{AUTO STOP} button.

3) Set the time to stop the unit as follows

- 1) Press the ^{AUTO STOP} button.
 - Time can be set while the following symbol is blinking.
 - Off time: (C) STOP is blinking.
 - The stop times is displayed at (D).
- 2) Use the ^h and ^{min} buttons to set the desired time.
- 3) To cancel the OFF timer, press the ^{AUTO STOP} button.

4) Changing the set times

Press the ^{AUTO START} or ^{AUTO STOP} to cancel the timer and repeat from 2) or 3).

5. Emergency Operation for Wireless Remote-controller (option)

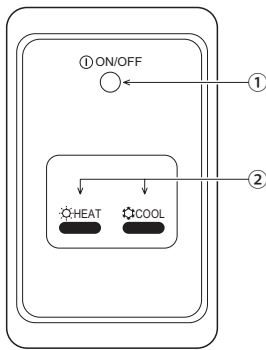

- 1) **ON/OFF lamp** (lit when unit is operating; unlit when unit is not operating)







2) Emergency operation

In cases where the remote control unit does not operate properly, use either the COOL or HEAT button on the wireless remote control signal receiver to toggle the unit on or off. On cooler only units, pushing the HEAT button toggles the fan on and off.

Pressing the COOL or HEAT button selects the following settings.

Operation mode	COOL	HEAT
Preset temperature	24 °C/75 °F	24 °C/75 °F
Fan speed	High	High

6. Trouble Shooting

Having trouble?	Here is the solution. (Unit is operating normally.)
Air conditioner does not heat or cool well.	<ul style="list-style-type: none"> ■ Clean the filter. (Airflow is reduced when the filter is dirty or clogged.) ■ Check the temperature adjustment and adjust the set temperature. ■ Make sure that there is plenty of space around the outdoor unit. Is the indoor unit air intake or outlet blocked? ■ Has a door or window been left open?
When heating operation starts, warm air does not blow from the indoor unit soon.	<ul style="list-style-type: none"> ■ Warm air does not blow until the indoor unit has sufficiently warmed up.
During heating mode, the air conditioner stops before the set room temperature is reached.	<ul style="list-style-type: none"> ■ When the outdoor temperature is low and the humidity is high, frost may form on the outdoor unit. If this occurs, the outdoor unit performs a defrosting operation. Normal operation should begin after approximately 10 minutes.
Airflow direction changes during operation or airflow direction cannot be set.	<ul style="list-style-type: none"> ■ During heating mode, the vanes automatically move to the horizontal airflow direction when the airflow temperature is low or during defrosting mode.
When the airflow direction is changed, the vanes always move up and down past the set position before finally stopping at the position.	<ul style="list-style-type: none"> ■ When the airflow direction is changed, the vanes move to the set position after detecting the base position.
A flowing water sound or occasional hissing sound is heard.	<ul style="list-style-type: none"> ■ These sounds can be heard when refrigerant is flowing in the air conditioner or when the refrigerant flow is changing.
A cracking or creaking sound is heard.	<ul style="list-style-type: none"> ■ These sounds can be heard when parts rub against each due to expansion and contraction from temperature changes.
The room has an unpleasant odor.	<ul style="list-style-type: none"> ■ The indoor unit draws in air that contains gases produced from the walls, carpeting, and furniture as well as odors trapped in clothing, and then blows this air back into the room.
A white mist or vapor is emitted from the indoor unit.	<ul style="list-style-type: none"> ■ If the indoor temperature and the humidity are high, this condition may occur when operation starts. ■ During defrosting mode, cool airflow may blow down and appear like a mist.
Water or vapor is emitted from the outdoor unit.	<ul style="list-style-type: none"> ■ During cooling mode, water may form and drip from the cool pipes and joints. ■ During heating mode, water may form and drip from the heat exchanger. ■ During defrosting mode, water on the heat exchanger evaporates and water vapor may be emitted.
"  appears in the remote controller display.	<ul style="list-style-type: none"> ■ During central control, " appears in the remote controller display and air conditioner operation cannot be started or stopped using the remote controller.
When restarting the air conditioner soon after stopping it, it does not operate even though the ON/OFF button is pressed.	<ul style="list-style-type: none"> ■ Wait approximately three minutes. ■ (Operation has stopped to protect the air conditioner.)
Air conditioner operates without the ON/OFF button being pressed.	<ul style="list-style-type: none"> ■ Is the on timer set? Press the ON/OFF button to stop operation. ■ Is the air conditioner connected to a central remote controller? Consult the concerned people who control the air conditioner. ■ Does " appear in the remote controller display? Consult the concerned people who control the air conditioner. ■ Has the auto recovery feature from power failures been set? Press the ON/OFF button to stop operation.
Air conditioner stops without the ON/OFF button being pressed.	<ul style="list-style-type: none"> ■ Is the off timer set? Press the ON/OFF button to restart operation. ■ Is the air conditioner connected to a central remote controller? Consult the concerned people who control the air conditioner. ■ Does " appear in the remote controller display? Consult the concerned people who control the air conditioner.
Remote controller timer operation cannot be set.	<ul style="list-style-type: none"> ■ Are timer settings invalid? If the timer can be set,  or  appears in the remote controller display.
"PLEASE WAIT" appears in the remote controller display.	<ul style="list-style-type: none"> ■ The initial settings are being performed. Wait approximately 3 minutes.
An error code appears in the remote controller display.	<ul style="list-style-type: none"> ■ The protection devices have operated to protect the air conditioner. ■ Do not attempt to repair this equipment by yourself. Turn off the power switch immediately and consult your dealer. Be sure to provide the dealer with the model name and information that appeared in the remote controller display.
Draining water or motor rotation sound is heard.	<ul style="list-style-type: none"> ■ When cooling operation stops, the drain pump operates and then stops. Wait approximately 3 minutes.
The vanes do not move or the indoor unit does not respond to input from the wireless remote controller.	<ul style="list-style-type: none"> ■ The junction wire connectors of the vane motor and signal receiver may not be connected correctly. Have an installer check the connections. (The colors of the male and female sections of the junction wire connectors must match.)

6. Trouble Shooting

Having trouble?	Here is the solution. (Unit is operating normally.)												
Noise is louder than specifications.	<ul style="list-style-type: none"> The indoor operation sound level is affected by the acoustics of the particular room as shown in the following table and will be higher than the noise specification, which was measured in an echo-free room. <table border="1"> <thead> <tr> <th></th> <th>High sound-absorbing rooms</th> <th>Normal rooms</th> <th>Low sound-absorbing rooms</th> </tr> </thead> <tbody> <tr> <td>Location examples</td> <td>Broadcasting studio, music room, etc.</td> <td>Reception room, hotel lobby, etc.</td> <td>Office, hotel room</td> </tr> <tr> <td>Noise levels</td> <td>3 to 7 dB</td> <td>6 to 10 dB</td> <td>9 to 13 dB</td> </tr> </tbody> </table>		High sound-absorbing rooms	Normal rooms	Low sound-absorbing rooms	Location examples	Broadcasting studio, music room, etc.	Reception room, hotel lobby, etc.	Office, hotel room	Noise levels	3 to 7 dB	6 to 10 dB	9 to 13 dB
	High sound-absorbing rooms	Normal rooms	Low sound-absorbing rooms										
Location examples	Broadcasting studio, music room, etc.	Reception room, hotel lobby, etc.	Office, hotel room										
Noise levels	3 to 7 dB	6 to 10 dB	9 to 13 dB										
Nothing appears in the wireless remote controller display, the display is faint, or signals are not received by the indoor unit unless the remote controller is close.	<ul style="list-style-type: none"> The batteries are low. Replace the batteries and press the Reset button. If nothing appears even after the batteries are replaced, make sure that the batteries are installed in the correct directions (+, -). 												
The operation lamp near the receiver for the wireless remote controller on the indoor unit is flashing.	<ul style="list-style-type: none"> The self diagnosis function has operated to protect the air conditioner. Do not attempt to repair this equipment by yourself. Turn off the power switch immediately and consult your dealer. Be sure to provide the dealer with the model name. 												
The wireless remote controller does not operate (the indoor unit beeps 4 times).	<ul style="list-style-type: none"> Switch the auto mode setting to the AUTO (single set point) mode or AUTO (dual set point) mode. For details, refer to the included Notice (A5 sheet) or the Installation Manual. 												

7. Specifications

Item	Model	PEA-RP200WKA	PEA-RP250WKA	
Power source		220-240V 50Hz		
Dimension	Height / Width / Depth	mm	470/1370/732	470/1370/732
Net weight		kg	108	108
Fan	Airflow rate (Low-Middle-High)	m ³ /min	56-61-72	58-71-84
	External static pressure	Pa	60/75/100/150	60/75/100/150
Sound pressure level (Low-Mid-High)		dB(A)	38-41-44	40-43-46

This product is designed and intended for use in the residential,
commercial and light-industrial environment.

The product at hand is
based on the following
EU regulations:

- Low Voltage Directive 2014/35/EU
- Electromagnetic Compatibility Directive 2014/30/EU
- Machinery Directive 2006/42/EC

Не забудьте указать контактный адрес/номер телефона в данном
руководстве, прежде чем передать его клиенту.

Please be sure to put the contact address/telephone number on
this manual before handing it to the customer.

MITSUBISHI ELECTRIC CORPORATION

Название Компании: ООО «Мицубиси Электрик (РУС)»

Адрес: Россия, 115054, Москва, Космодамианская наб., д. 52, стр. 1

HEAD OFFICE: TOKYO BLDG., 2-7-3, MARUNOUCHI, CHIYODA-KU, TOKYO 100-8310, JAPAN