

SERVICE MANUAL

R32
**Outdoor unit
[Model Name]**
[Service Ref.]

PUZ-M100VKA	PUZ-M100VKA.TH
PUZ-M100VKA-ET	PUZ-M100VKA-ET.TH
PUZ-M125VKA	PUZ-M125VKA.TH
PUZ-M125VKA-ET	PUZ-M125VKA-ET.TH
PUZ-M140VKA	PUZ-M140VKA.TH
PUZ-M140VKA-ET	PUZ-M140VKA-ET.TH
PUZ-M100YKA	PUZ-M100YKA.TH
PUZ-M100YKA-ET	PUZ-M100YKA-ET.TH
PUZ-M125YKA	PUZ-M125YKA.TH
PUZ-M125YKA-ET	PUZ-M125YKA-ET.TH
PUZ-M140YKA	PUZ-M140YKA.TH
PUZ-M140YKA-ET	PUZ-M140YKA-ET.TH

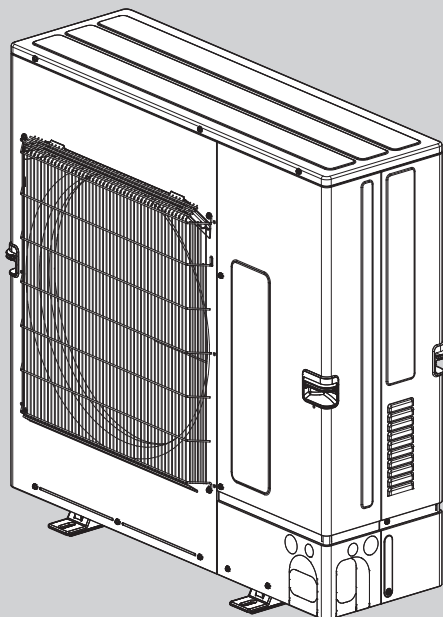

CONTENTS





1. REFERENCE MANUAL	2
2. SAFETY PRECAUTION	2
3. SPECIFICATIONS	12
4. DATA	13
5. OUTLINES AND DIMENSIONS	16
6. WIRING DIAGRAM	17
7. WIRING SPECIFICATIONS	20
8. REFRIGERANT SYSTEM DIAGRAM	25
9. TROUBLESHOOTING	27
10. FUNCTION SETTING	83
11. MONITORING THE OPERATION DATA BY THE REMOTE CONTROLLER	89
12. EASY MAINTENANCE FUNCTION	99
13. DISASSEMBLY PROCEDURE	103

PARTS CATALOG (OCB707)

INDOOR UNIT SERVICE MANUAL

Model Name	Service Ref.	Service Manual No.
PLA-M35/50/60/71/100/125/140EA	PLA-M35/50/60/71/100/125/140EA.UK	OCH697 OCB697
PCA-M50/60/71/100/125/140KA	PCA-M50/60/71/100/125/140KA	OCH659 OCB659
PEAD-M50/60/71/100/125/140JA(L)	PEAD-M50/60/71/100/125/140JA(L).UK	HWE16130 BWE017010
PKA-M50HA(L)	PKA-M50HA(L)	OCH660 OCB660
PKA-M60/71/100KA(L)	PKA-M60/71/100KA(L).TH	OCH661 OCB661

MEANINGS OF SYMBOLS DISPLAYED ON THE UNIT

	WARNING (Risk of fire)	This mark is for R32 refrigerant only. Refrigerant type is written on nameplate of outdoor unit. In case that refrigerant type is R32, this unit uses a flammable refrigerant. If refrigerant leaks and comes in contact with fire or heating part, it will create harmful gas and there is risk of fire.
	Read the OPERATION MANUAL carefully before operation.	
	Service personnel are required to carefully read the OPERATION MANUAL and INSTALLATION MANUAL before operation.	
	Further information is available in the OPERATION MANUAL, INSTALLATION MANUAL, and the like.	

2-1. ALWAYS OBSERVE FOR SAFETY

Before obtaining access to terminal, all supply circuits must be disconnected.

2-2. CAUTIONS RELATED TO NEW REFRIGERANT

Cautions for units utilizing refrigerant R32

Preparation before the repair service

- Prepare the proper tools.
- Prepare the proper protectors.
- Provide adequate ventilation.
- After stopping the operation of the air conditioner, turn off the power-supply breaker.
- Discharge the condenser before the work involving the electric parts.

Precautions during the repair service

- Do not perform the work involving the electric parts with wet hands.
- Do not pour water into the electric parts.
- Do not touch the refrigerant.
- Do not touch the hot or cold areas in the refrigerating cycle.
- When the repair or the inspection of the circuit needs to be done without turning off the power, exercise great caution not to touch the live parts.

Use new refrigerant pipes.

- In case of using the existing pipes for R22, be careful with the following.
- Be sure to clean the pipes and make sure that the insides of the pipes are clean.
 - Change flare nut to the one provided with this product.
 - Use a newly flared pipe.
 - Avoid using thin pipes.

Use a vacuum pump with a reverse flow check valve.

Vacuum pump oil may flow back into refrigerant cycle and that can cause deterioration of refrigerant oil, etc.

**Make sure that the inside and outside of refrigerant piping is clean and it has no contaminants such as sulfur, oxides, dirt, shaving particles, etc, which are hazard to refrigerant cycle.
In addition, use pipes with specified thickness.**

Contamination inside refrigerant piping can cause deterioration of refrigerant oil, etc.

Store the piping indoors, and keep both ends of the piping sealed until just before brazing. (Leave elbow joints, etc. in their packaging.)

If dirt, dust or moisture enters into refrigerant cycle, that can cause deterioration of refrigerant oil or malfunction of compressor.

The refrigerant oil applied to flare and flange connections must be ester oil, ether oil or alkylbenzene oil in a small amount.

If large amount of mineral oil enters, that can cause deterioration of refrigerant oil, etc.

Do not use refrigerant other than R32.

If other refrigerant (R22, etc.) is used, chlorine in refrigerant can cause deterioration of refrigerant oil, etc.

Use the following tools specifically designed for use with R32 refrigerant.

The following tools are necessary to use R32 refrigerant.

Tools for R32	
Gauge manifold	Flare tool
Charge hose	Size adjustment gauge
Gas leak detector	Vacuum pump adaptor
Torque wrench	Electronic refrigerant charging scale

Handle tools with care.

If dirt, dust or moisture enters into refrigerant cycle, that can cause deterioration of refrigerant oil or malfunction of compressor.

Use the specified refrigerant only.

Never use any refrigerant other than that specified.

Doing so may cause a burst, an explosion, or fire when the unit is being used, serviced, or disposed of. Correct refrigerant is specified in the manuals and on the spec labels provided with our products. We will not be held responsible for mechanical failure, system malfunction, unit breakdown or accidents caused by failure to follow the instructions.

Ventilate the room if refrigerant leaks during operation. If refrigerant comes into contact with a flame, poisonous gases will be released.

[1] Warning for service

- (1) Do not alter the unit.
- (2) For installation and relocation work, follow the instructions in the Installation Manual and use tools and pipe components specifically made for use with refrigerant specified in the outdoor unit installation manual.
- (3) Ask a dealer or an authorized technician to install, relocate and repair the unit.
For appliances not accessible to the general public.
- (4) Refrigerant pipes connection shall be accessible for maintenance purposes.
- (5) If the air conditioner is installed in a small room or closed room, measures must be taken to prevent the refrigerant concentration in the room from exceeding the safety limit in the event of refrigerant leakage. Should the refrigerant leak and cause the concentration limit to be exceeded, hazards due to lack of oxygen in the room may result.
- (6) Keep gas-burning appliances, electric heaters, and other fire sources (ignition sources) away from the location where installation, repair, and other air conditioner work will be performed.
If refrigerant comes into contact with a flame, poisonous gases will be released.
- (7) When installing or relocating, or servicing the air conditioner, use only the specified refrigerant (R32) to charge the refrigerant lines.
Do not mix it with any other refrigerant and do not allow air to remain in the lines.
If air is mixed with the refrigerant, then it can be the cause of abnormal high pressure in the refrigerant line, and may result in an explosion and other hazards.
- (8) After installation has been completed, check for refrigerant leaks. If refrigerant leaks into the room and comes into contact with the flame of a heater or portable cooking range, poisonous gases will be released.
- (9) Do not use low temperature solder alloy in case of brazing the refrigerant pipes.
- (10) When performing brazing work, be sure to ventilate the room sufficiently. Make sure that there are no hazardous or flammable materials nearby.
When performing the work in a closed room, small room, or similar location, make sure that there are no refrigerant leaks before performing the work.
If refrigerant leaks and accumulates, it may ignite or poisonous gases may be released.
- (11) Do not install the unit in places where refrigerant may build-up or places with poor ventilation such as a semi-basement or a sunken place in outdoor: Refrigerant is heavier than air, and inclined to fall away from the leak source.
- (12) Do not use means to accelerate the defrosting process or to clean, other than those recommended by the manufacturer.
- (13) The appliance shall be stored in a room without continuously operating ignition sources (for example: open flames, an operating gas appliance or an operating electric heater).
- (14) Do not pierce or burn.
- (15) Be aware that refrigerants may not contain an odour.
- (16) Pipe-work shall be protected from physical damage.
- (17) The installation of pipe-work shall be kept to a minimum.
- (18) Compliance with national gas regulations shall be observed.
- (19) Keep any required ventilation openings clear of obstruction.
- (20) Servicing shall be performed only as recommended by the manufacturer.
- (21) The appliance shall be stored in a well-ventilated area where the room size corresponds to the room area as specified for operation.
- (22) Maintenance, service and repair operations shall be performed by authorized technician with required qualification.
- (23) Be sure to have appropriate ventilation in order to prevent ignition. Furthermore, be sure to carry out fire prevention measures that there are no dangerous or flammable objects in the surrounding area.

[2] Cautions for service

- (1) Perform service after recovering the refrigerant left in unit completely.
- (2) Do not release refrigerant in the air.
- (3) After completing service, charge the cycle with specified amount of refrigerant.
- (4) When performing service, install a filter drier simultaneously.
Be sure to use a filter drier for new refrigerant.

[3] Additional refrigerant charge

When charging directly from cylinder

R32 is a single refrigerant and its composition does not change. Therefore, both liquid charging and gas charging are possible. Liquid charging of refrigerant all at once from the low pressure side may cause the compressor malfunction. Accordingly, make sure that charging is gradual.

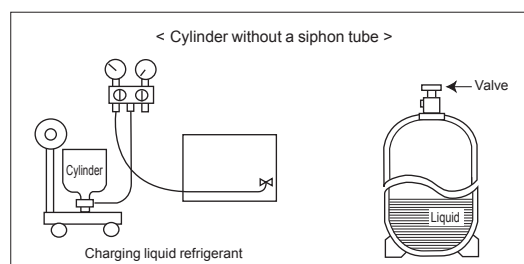
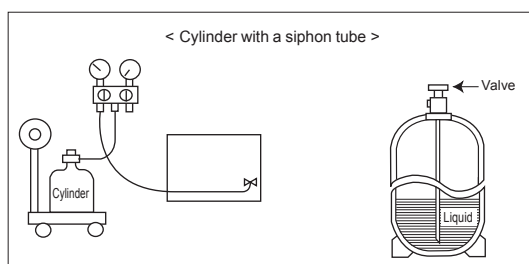

[4] Cautions for unit using R32 refrigerant

Basic work procedures are the same as those for conventional units using refrigerant R410A. However, pay careful attention to the following points.

(1) Information on servicing

(1-1) Checks on the Area

Prior to beginning work on systems containing flammable refrigerants, safety checks are necessary to ensure that the risk of ignition is minimized.

For repair to the refrigerating systems, (1-3) to (1-7) shall be completed prior to conducting work on the systems.

(1-2) Work Procedure

Work shall be undertaken under a controlled procedure so as to minimize the risk of a flammable gas or vapor being present while the work is being performed.

(1-3) General Work Area

All maintenance staff and others working in the local area shall be instructed on the nature of work being carried out.

Work in confined spaces shall be avoided. The area around the workspace shall be sectioned off. Ensure that the conditions within the area have been made safe by control of flammable material.

(1-4) Checking for Presence of Refrigerant

The area shall be checked with an appropriate refrigerant detector prior to and during work, to ensure the technician is aware of potentially toxic or flammable atmospheres. Ensure that the leak detection equipment being used is suitable for use with all applicable refrigerants, i.e. non-sparking, adequately sealed or intrinsically safe.

(1-5) Presence of Fire Extinguisher

If any hot work is to be conducted on the refrigeration equipment or any associated parts, appropriate fire extinguishing equipment shall be available to hand.

Have a dry powder or CO₂ fire extinguisher adjacent to the charging area.

(1-6) No Ignition Sources

No person carrying out work in relation to a refrigeration system which involves exposing any pipe work shall use any sources of ignition in such a manner that it may lead to the risk of fire or explosion. All possible ignition sources, including cigarette smoking, should be kept sufficiently far away from the site of installation, repairing, removing and disposal, during which refrigerant can possibly be released to the surrounding space. Prior to work taking place, the area around the equipment is to be surveyed to make sure that there are no flammable hazards or ignition risks. "No Smoking" signs shall be displayed.

(1-7) Ventilated Area

Ensure that the area is in the open or that it is adequately ventilated before breaking into the system or conducting any hot work. A degree of ventilation shall continue during the period that the work is carried out. The ventilation should safely disperse any released refrigerant and preferably expel it externally into the atmosphere.

(1-8) Checks on the Refrigeration Equipment

Where electrical components are being changed, they shall be fit for the purpose and to the correct specification. At all times the manufacturer's maintenance and service guidelines shall be followed. If in doubt, consult the manufacturer's technical department for assistance.

The following checks shall be applied to installations using flammable refrigerants:

- The charge size is in accordance with the room size within which the refrigerant containing parts are installed.
- The ventilation machinery and outlets are operating adequately and are not obstructed.
- Marking to the equipment continues to be visible and legible. Markings and signs that are illegible shall be corrected.
- Refrigeration pipe or components are installed in a position where they are unlikely to be exposed to any substance which may corrode refrigerant containing components, unless the components are constructed of materials which are inherently resistant to being corroded or are suitably protected against being corroded.

(1-9) Checks on Electrical Devices

Repair and maintenance to electrical components shall include initial safety checks and component inspection procedures. If a fault exists that could compromise safety, then no electrical supply shall be connected to the circuit until it is satisfactorily dealt with. If the fault cannot be corrected immediately but it is necessary to continue operation, an adequate temporary solution shall be used. This shall be reported to the owner of the equipment so all parties are advised. Initial safety checks shall include that:

- capacitors are discharged: this shall be done in a safe manner to avoid possibility of sparking;
- no live electrical components and wiring are exposed while charging, recovering or purging the system;
- there is continuity of earth bonding

(2) Repairs to Sealed Components

(2-1) During repairs to sealed components, all electrical supplies shall be disconnected from the equipment being worked upon prior to any removal of sealed covers, etc. If it is absolutely necessary to have an electrical supply to equipment during servicing, then a permanently operating form of leak detection shall be located at the most critical point to warn of a potentially hazardous situation.

(2-2) Particular attention shall be paid to the following to ensure that by working on electrical components, the casing is not altered in such a way that the level of protection is affected. This shall include damage to cables, excessive number of connections, terminals not made to original specification, damage to seals, incorrect fitting of glands, etc.

Ensure that the apparatus is mounted securely.

Ensure that seals or sealing materials have not degraded to the point that they no longer serve the purpose of preventing the ingress of flammable atmospheres.

Replacement parts shall be in accordance with the manufacturer's specifications.

(3) Repair to intrinsically Safe Components

Do not apply any permanent inductive or capacitance loads to the circuit without ensuring that this will not exceed the permissible voltage and current permitted for the equipment in use.

Intrinsically safe components are the only types that can be worked on while live in the presence of a flammable atmosphere. The test apparatus shall be at the correct rating.

Replace components only with parts specified by the manufacturer. Other parts may result in the ignition of refrigerant in the atmosphere from a leak.

(4) Cabling

Check that cabling will not be subject to wear, corrosion, excessive pressure, vibration, sharp edges or any other adverse environmental effects. The check shall also take into account the effects of aging or continual vibration from sources such as compressors or fans.

(5) Detection of Flammable Refrigerants

Under no circumstances shall potential sources of ignition be used in the searching for or detection of refrigerant leaks. A halide torch (or any other detector using a naked flame) shall not be used.

(6) Leak Detection Methods

Electronic leak detectors may be used to detect refrigerant leaks but, in the case of flammable refrigerants, the sensitivity may not be adequate, or may need re-calibration. (Detection equipment shall be calibrated in a refrigerant-free area.)

Ensure that the detector is not a potential source of ignition and is suitable for the refrigerant used. Leak detection equipment shall be set at a percentage of the LFL of the refrigerant and shall be calibrated to the refrigerant employed, and the appropriate percentage of gas (25% maximum) is confirmed.

Leak detection fluids are suitable for use with most refrigerants but the use of detergents containing chlorine shall be avoided as the chlorine may react with the refrigerant and corrode the copper pipe-work.

If a leak is suspected, all naked flames shall be removed/extinguished.

If a leakage of refrigerant is found which requires brazing, all of the refrigerant shall be recovered from the system, or isolated (by means of shut off valves) in a part of the system remote from the leak. For appliances containing flammable refrigerants, oxygen free nitrogen (OFN) shall then be purged through the system both before and during the brazing process.

(7) Removal and Evacuation

When breaking into the refrigerant circuit to make repairs – or for any other purpose conventional procedures shall be used. However, for flammable refrigerants it is important that best practice is followed since flammability is a consideration. The following procedure shall be adhered to:

- remove refrigerant
- purge the circuit with inert gas
- evacuate
- purge again with inert gas
- open the circuit by cutting or brazing.

The refrigerant charge shall be recovered into the correct recovery cylinders. For appliances containing flammable refrigerants, the system shall be “flushed” with OFN to render the unit safe. This process may need to be repeated several times.

Compressed air or oxygen shall not be used for purging refrigerant systems.

For appliances containing flammable refrigerants, flushing shall be achieved by breaking the vacuum in the system with OFN and continuing to fill until the working pressure is achieved, then venting to atmosphere, and finally pulling down to a vacuum. This process shall be repeated until no refrigerant is within the system. When the final OFN charge is used, the system shall be vented down to atmospheric pressure to enable work to take place. This operation is absolutely vital if brazing operations on the pipe-work are to take place.

Ensure that the outlet for the vacuum pump is not close to any ignition sources and that ventilation is available.

(8) Charging Procedures

In addition to conventional charging procedures, the following requirements shall be followed:

- Ensure that contamination of different refrigerants does not occur when using charging equipment. Hoses or lines shall be as short as possible to minimize the amount of refrigerant contained in them.
- Cylinders shall be kept upright.
- Ensure that the refrigeration system is earthed prior to charging the system with refrigerant.
- Label the system when charging is complete (if not already).
- Extreme care shall be taken not to overfill the refrigeration system.

Prior to recharging the system, it shall be pressure-tested with the appropriate purging gas. The system shall be leak-tested on completion of charging but prior to commissioning. A follow up leak test shall be carried out prior to leaving the site.

(9) Decommissioning

Before carrying out this procedure, it is essential that the technician is completely familiar with the equipment and all its detail. It is recommended good practice that all refrigerants are recovered safely. Prior to the task being carried out, an oil and refrigerant sample shall be taken in case analysis is required prior to re-use of reclaimed refrigerant. It is essential that electrical power is available before the task is commenced.

- a) Become familiar with the equipment and its operation.

- b) Isolate system electrically.
- c) Before attempting the procedure, ensure that:
 - mechanical handling equipment is available, if required, for handling refrigerant cylinders;
 - all personal protective equipment is available and being used correctly;
 - the recovery process is supervised at all times by a competent person;
 - recovery equipment and cylinders conform to the appropriate standards.
- d) Pump down refrigerant system, if possible.
- e) If a vacuum is not possible, make a manifold so that refrigerant can be removed from various parts of the system.
- f) Make sure that cylinder is situated on the scales before recovery takes place.
- g) Start the recovery machine and operate in accordance with manufacturer's instructions.
- h) Do not overfill cylinders. (No more than 80 % volume liquid charge).
- i) Do not exceed the maximum working pressure of the cylinder, even temporarily.
- j) When the cylinders have been filled correctly and the process completed, make sure that the cylinders and the equipment are removed from site promptly and all isolation valves on the equipment are closed off.
- k) Recovered refrigerant shall not be charged into another refrigeration system unless it has been cleaned and checked.

(10) Labelling

Equipment shall be labelled stating that it has been de-commissioned and emptied of refrigerant. The label shall be dated and signed. For appliances containing flammable refrigerants, ensure that there are labels on the equipment stating the equipment contains flammable refrigerant.

(11) Recovery

When removing refrigerant from a system, either for servicing or decommissioning, it is recommended good practice that all refrigerants are removed safely. When transferring refrigerant into cylinders, ensure that only appropriate refrigerant recovery cylinders are employed. Ensure that the correct number of cylinders for holding the total system charge are available. All cylinders to be used are designated for the recovered refrigerant and labelled for that refrigerant (i.e. special cylinders for the recovery of refrigerant). Cylinders shall be complete with pressure-relief valve and associated shut-off valves in good working order. Empty recovery cylinders are evacuated and, if possible, cooled before recovery occurs.

The recovery equipment shall be in good working order with a set of instructions concerning the equipment that is at hand and shall be suitable for the recovery of all appropriate refrigerants including, when applicable, flammable refrigerants. In addition, a set of calibrated weighing scales shall be available and in good working order. Hoses shall be complete with leak-free disconnect couplings and in good condition. Before using the recovery machine, check that it is in satisfactory working order, has been properly maintained and that any associated electrical components are sealed to prevent ignition in the event of a refrigerant release. Consult manufacturer if in doubt.

The recovered refrigerant shall be returned to the refrigerant supplier in the correct recovery cylinder, and the relevant waste transfer note arranged. Do not mix refrigerants in recovery units and especially not in cylinders. If compressors or compressor oils are to be removed, ensure that they have been evacuated to an acceptable level to make certain that flammable refrigerant does not remain within the lubricant. The evacuation process shall be carried out prior to returning the compressor to the suppliers. Only electric heating to the compressor body shall be employed to accelerate this process. When oil is drained from a system, it shall be carried out safely.

[5] Service tools

Use the below service tools as exclusive tools for R32 refrigerant.

No.	Tool name	Specifications
①	Gauge manifold	<ul style="list-style-type: none"> · Only for R32 · Use the existing fitting specifications. (UNF1/2) · Use high-tension side pressure of 5.3MPa·G or over.
②	Charge hose	<ul style="list-style-type: none"> · Only for R32 · Use pressure performance of 5.09MPa·G or over.
③	Electronic weighing scale	—
④	Gas leak detector	· Use the detector for R134A, R407C, R410A or R32.
⑤	Adaptor for reverse flow check	· Attach on vacuum pump.
⑥	Refrigerant charge base	—
⑦	Refrigerant cylinder	<ul style="list-style-type: none"> · Only for R32 · Cylinder with syphon
⑧	Refrigerant recovery equipment	—

2-3. PRECAUTIONS WHEN REUSING EXISTING R22/R410A REFRIGERANT PIPES

(1) Flowchart

- Refer to the flowchart below to determine if the existing pipes can be used and if it is necessary to use a filter dryer.
- If the diameter of the existing pipes is different from the specified diameter, refer to technological data materials to confirm if the pipes can be used.

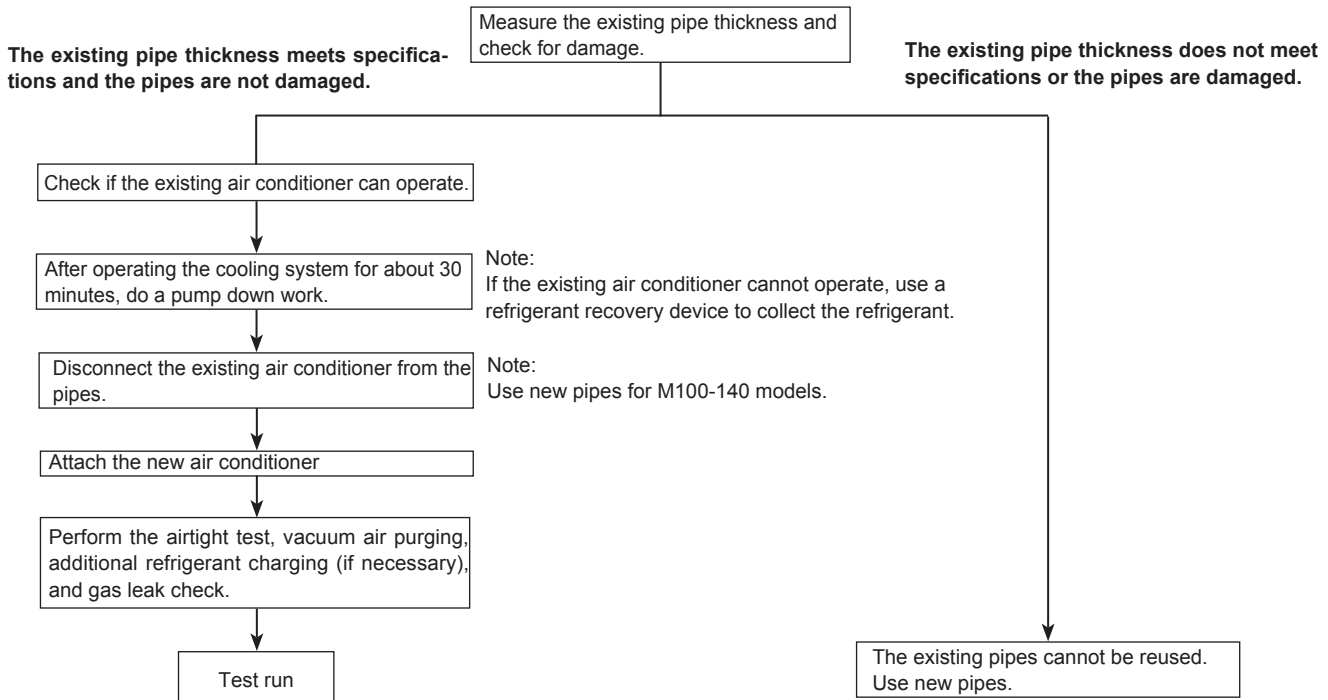

(2) Cautions for refrigerant piping work

New refrigerant R32 is adopted for replacement inverter series. Although the refrigerant piping work for R32 is same as for R22, exclusive tools are necessary so as not to mix with different kind of refrigerant. Furthermore as the working pressure of R32 is 1.6 times higher than that of R22, their sizes of flared sections and flare nuts are different.

① Thickness of pipes

Because the working pressure of R32 is higher compared to R22, be sure to use refrigerant piping with thickness shown below. (Never use pipes of 0.7 mm or below.)

Diagram below: Piping diameter and thickness

Nominal dimensions(inch)	Outside diameter (mm)	Thickness (mm)	
		R32/R410a	R22
1/4	6.35	0.8	0.8
3/8	9.52	0.8	0.8
1/2	12.70	0.8	0.8
5/8	15.88	1.0	1.0
3/4	19.05	—	1.0

② Dimensions of flare cutting and flare nut

The component molecules in HFC refrigerant are smaller compared to conventional refrigerants. In addition to that, R32 is a refrigerant, which has higher risk of leakage because its working pressure is higher than that of other refrigerants. Therefore, to enhance airtightness and strength, flare cutting dimension of copper pipe for R32 has been specified separately from the dimensions for other refrigerants as shown below. The dimension B of flare nut for R32 also has partly been changed to increase strength as shown below. Set copper pipe correctly referring to copper pipe flaring dimensions for R32 below. For 1/2 and 5/8 inch pipes, the dimension B changes.

Use torque wrench corresponding to each dimension.

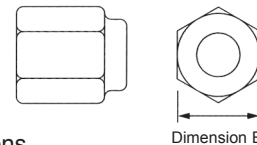
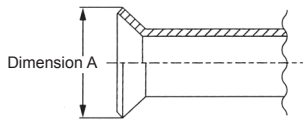

Flare cutting dimensions

Nominal dimensions (inch)	Outside diameter (mm)	Dimension A ($^{+0}_{-0.4}$)(mm)	
		R32/R410A	R22
1/4	6.35	9.1	9.0
3/8	9.52	13.2	13.0
1/2	12.70	16.6	16.2
5/8	15.88	19.7	19.4
3/4	19.05	—	23.3

Flare nut dimensions

Nominal dimensions (inch)	Outside diameter (mm)	Dimension B (mm)	
		R32/R410A	R22
1/4	6.35	17.0	17.0
3/8	9.52	22.0	22.0
1/2	12.70	26.0	24.0
5/8	15.88	29.0	27.0
3/4	19.05	—	36.0

③ Tools for R32 (The following table shows whether conventional tools can be used or not.)

Tools and materials	Use	R32 tools	Can R22 tools be used?	Can R407C tools be used?	Can R410A tools be used?
Gauge manifold	Air purge, refrigerant charge and operation check	Tool exclusive for R32	×	×	○
Charge hose		Tool exclusive for R32	×	×	○
Gas leak detector	Gas leak check	Tool for HFC refrigerant	×	○	○
Refrigerant recovery equipment	Refrigerant recovery	Tool exclusive for R32	×	×	○
Refrigerant cylinder	Refrigerant charge	Tool exclusive for R32	×	×	×
Safety charger	Prevent compressor malfunction when charging refrigerant by spraying liquid refrigerant	Tool exclusive for R32	×	×	○
Charge valve	Prevent gas from blowing out when detaching charge hose	Tool exclusive for R32	×	×	○
Vacuum pump	Vacuum drying and air purge	Tools for other refrigerants can be used if equipped with adapter for reverse flow check	△(Usable if equipped with adapter for reverse flow)	△(Usable if equipped with adapter for reverse flow)	△(Usable if equipped with adapter for reverse flow)
Flare tool	Flaring work of piping	Tools for other refrigerants can be used by adjusting flaring dimension	△(Usable by adjusting flaring dimension)	△(Usable by adjusting flaring dimension)	△(Usable by adjusting flaring dimension)
Bender	Bend the pipes	Tools for other refrigerants can be used	○	○	○
Pipe cutter	Cut the pipes	Tools for other refrigerants can be used	○	○	○
Welder and nitrogen gas cylinder	Weld the pipes	Tools for other refrigerants can be used	○	○	○
Refrigerant charging scale	Refrigerant charge	Tools for other refrigerants can be used	○	○	○
Vacuum gauge or thermistor vacuum gauge and vacuum valve	Check the degree of vacuum. (Vacuum valve prevents back flow of oil and refrigerant to thermistor vacuum gauge)	Tools for other refrigerants can be used	○	○	○
Charging cylinder	Refrigerant charge	Tool exclusive for R32	×	—	×

× : Prepare a new tool. (Use the new tool as the tool exclusive for R32.)

△ : Tools for other refrigerants can be used under certain conditions.

○ : Tools for other refrigerants can be used.

2-4. Choosing the outdoor unit installation location

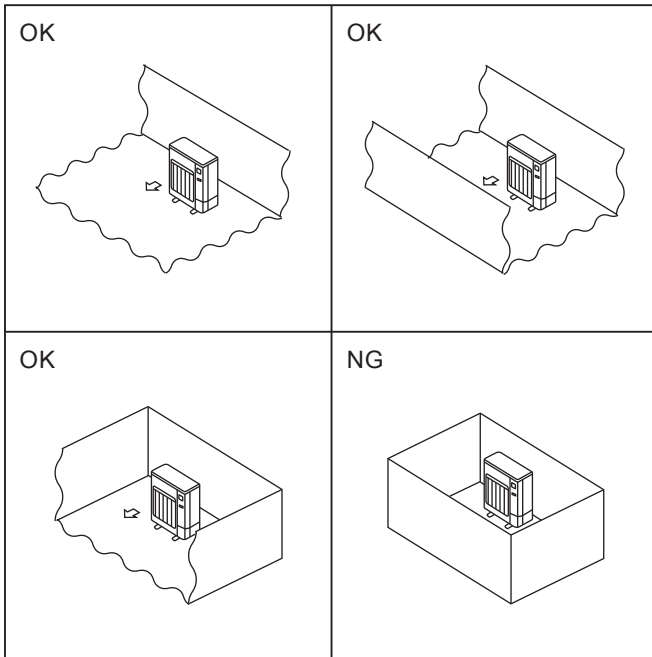

R32 is heavier than air—as well as other refrigerants—so tends to accumulate at the base (in the vicinity of the floor). If R32 accumulates around base, it may reach a flammable concentration in case room is small. To avoid ignition, maintaining a safe work environment is required by ensuring appropriate ventilation. If a refrigerant leak is confirmed in a room or an area where there is insufficient ventilation, refrain from using of flames until the work environment can be improved by ensuring appropriate ventilation.

Install outdoor units in a place where at least one of the four sides is open, and in a sufficiently large space without depressions.

2-5. Minimum installation area

If you unavoidably install a unit in a space where all four sides are blocked or there are depressions, confirm that one of these situations (A, B or C) is satisfied.

Note: These countermeasures are for keeping safety not for specification guarantee.

A) Secure sufficient installation space (minimum installation area A_{min}).

Install in a space with an installation area of A_{min} or more, corresponding to refrigerant quantity M (factory-charged refrigerant + locally added refrigerant).

M [kg]	A_{min} [m ²]
1.0	12
1.5	17
2.0	23
2.5	28
3.0	34
3.5	39
4.0	45
4.5	50
5.0	56
5.5	62
6.0	67
6.5	73
7.0	78
7.5	84

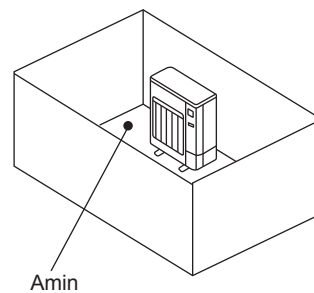

B) Install in a space with a depression height of [0.125 [m]

Height from the bottom of
0.125 [m] or less

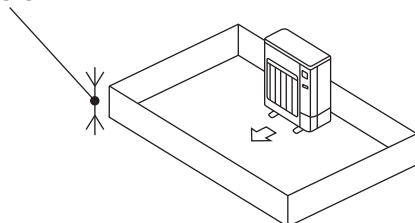

Height from the bottom of
0.125 [m] or less

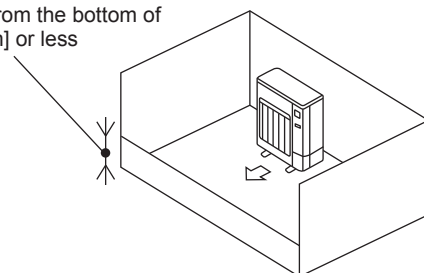

C) Create an appropriate ventilation open area.

Make sure that the width of the open area is 0.9 [m] or more and the height of the open area is 0.15 [m] or more. However, the height from the bottom of the installation space to the bottom edge of the open area should be 0.125 [m] or less.

Open area should be 75% or more opening.

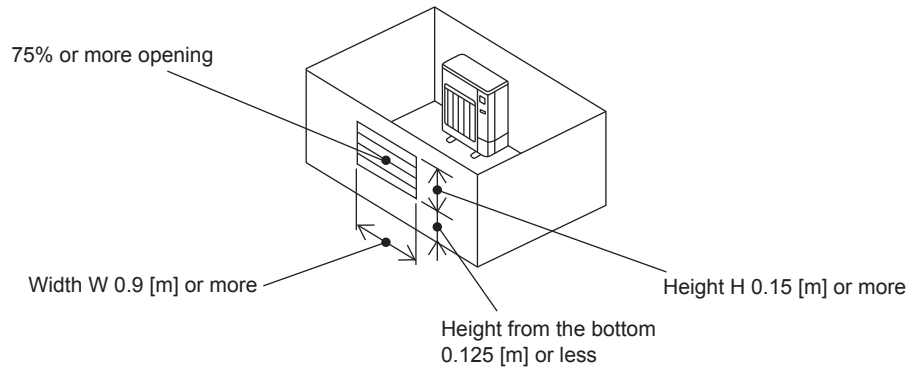

■ Indoor units

Install in a room with a floor area of A_{min} or more, corresponding to refrigerant quantity M (factory-charged refrigerant + locally added refrigerant).

* For the factory-charged refrigerant amount, refer to the spec nameplate or installation manual.

For the amount to be added locally, refer to the installation manual.

Install the indoor unit so that the height from the floor to the bottom of the indoor unit is h_0 ;

for wall mounted: 1.8 m or more;

for ceiling suspended, cassette and ceiling concealed: 2.2 m or more.

* There are restrictions in installation height for each model, so read the installation manual for the particular unit.

M [kg]	A_{min} [m ²]
1.0	4
1.5	6
2.0	8
2.5	10
3.0	12
3.5	14
4.0	16
4.5	20
5.0	24
5.5	29
6.0	35
6.5	41
7.0	47
7.5	54

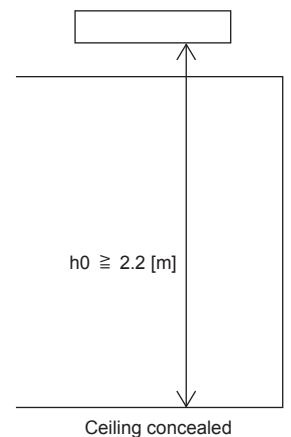
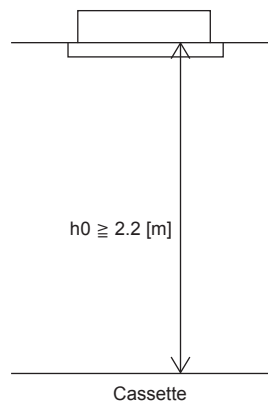
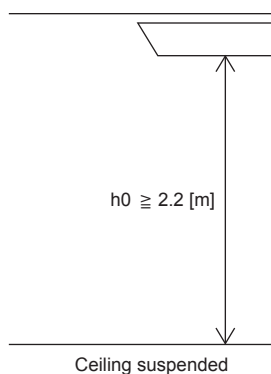
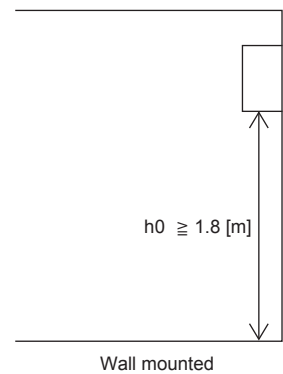

3

SPECIFICATIONS

Service Ref			PUZ-M100VKA.TH PUZ-M100VKA-ET.TH	PUZ-M125VKA.TH PUZ-M125VKA-ET.TH	PUZ-M140VKA.TH PUZ-M140VKA-ET.TH	PUZ-M100YKA.TH PUZ-M100YKA-ET.TH	PUZ-M125YKA.TH PUZ-M125YKA-ET.TH	PUZ-M140YKA.TH PUZ-M140YKA-ET.TH	
Power supply (phase, voltage, cycle)			Single phase, 230 V, 50 Hz			3-phase, 400 V, 50 Hz			
Max. current		A	20	26.5	30	11.5			
External finish			Munsell 3Y 7.8/1.1						
Refrigerant control			Linear Expansion Valve						
Compressor			Hermetic						
Model			SVB220FBGMT	MVB33FBVMC	MVB33FBVMC	SVB220FBAMT	MVB33FBVMC	MVB33FBVMC	
Motor output		kW	1.5	2.5	2.5	1.5	2.5	2.5	
Starter type			Direct input						
Protection devices			Shell thermistor H.P. switch						
Heat exchanger			Plate fin coil						
Fan Fan(drive) x No.			Propeller fan x 1						
Fan motor output		kW	0.200						
Air volume		m ³ /min	79	86	86	79	86	86	
Noise level	Cooling	SPL(dB)	51	54	55	51	54	55	
	Heating	SPL(dB)	54	56	57	54	56	57	
	Cooling	PWL(dB)	70	72	73	70	72	73	
Dimensions	W	mm(inch)	1,050 (41-5/16)						
	D	mm(inch)	330+40 (13+1-3/16)						
	H	mm(inch)	981 (38-5/8)						
Weight		kg	76	84	84	78	85	85	
Refrigerant			R32						
Charge		kg	3.1	3.6	3.6	3.1	3.6	3.6	
Oil (Model)		cc	700 (FW68S)	1100 (FW68S)	1100 (FW68S)	700 (FW68S)	1100 (FW68S)	1100 (FW68S)	
REFRIGERANT PIPING	Pipe size O.D		Liquid	mm(inch)		9.52 (3/8)			
			Gas	mm(inch)		15.88 (5/8)			
	Connection method		Indoor side	Flared					
			Outdoor side	Flared					
	Between the indoor & Outdoor unit		Height difference	Maximum 30 m					
			Piping length	Maximum 55 m	Maximum 65 m		Maximum 55 m	Maximum 65 m	

4

DATA

4-1. REFILLING REFRIGERANT CHARGE (R32: kg)

Service Ref.	Piping length (one way)				Initial charged
	30m	40m	50m	55m	
PUZ-M100VKA(-ET).TH	0	0.4	0.8	1.0	3.1
PUZ-M125VKA(-ET).TH					3.6
PUZ-M140VKA(-ET).TH					3.1
PUZ-M100YKA(-ET).TH					3.6
PUZ-M125YKA(-ET).TH					
PUZ-M140YKA(-ET).TH					

4-2. COMPRESSOR TECHNICAL DATA

(at 20°C)

Service Ref.	PUZ-M100VKA(-ET).TH	PUZ-M100YKA(-ET).TH	PUZ-M125/140VKA(-ET).TH PUZ-M125/140YKA(-ET).TH	
Compressor model	SVB220FBGMT	SVB220FBAMT	MVB33FBVMC	
Winding	U-V	0.95	1.64	0.88
Resistance (Ω)	U-W	0.95	1.64	0.88
	W-V	0.95	1.64	0.88

4-3. NOISE CRITERION CURVES

PUZ-M100VKA(-ET).TH
PUZ-M100YKA(-ET).TH

MODE	SPL(dB)	LINE
COOLING	51	●—●
HEATING	54	○—○

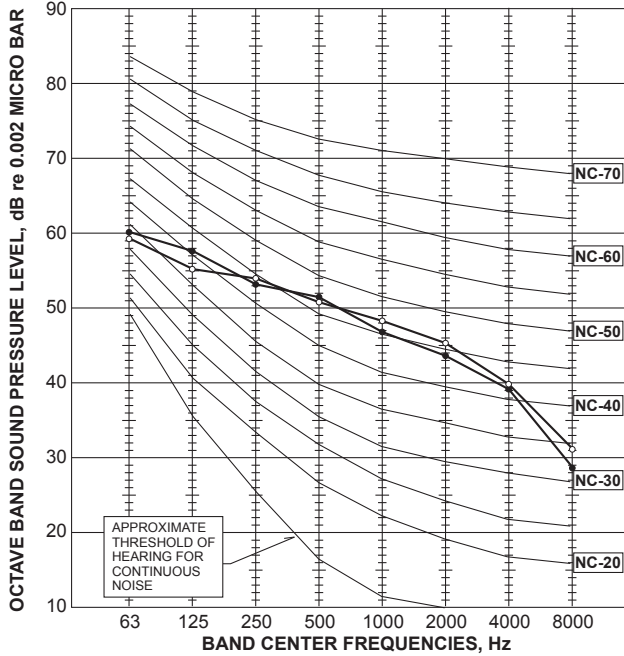

PUZ-M125VKA(-ET).TH
PUZ-M125YKA(-ET).TH

MODE	SPL(dB)	LINE
COOLING	54	●—●
HEATING	56	○—○

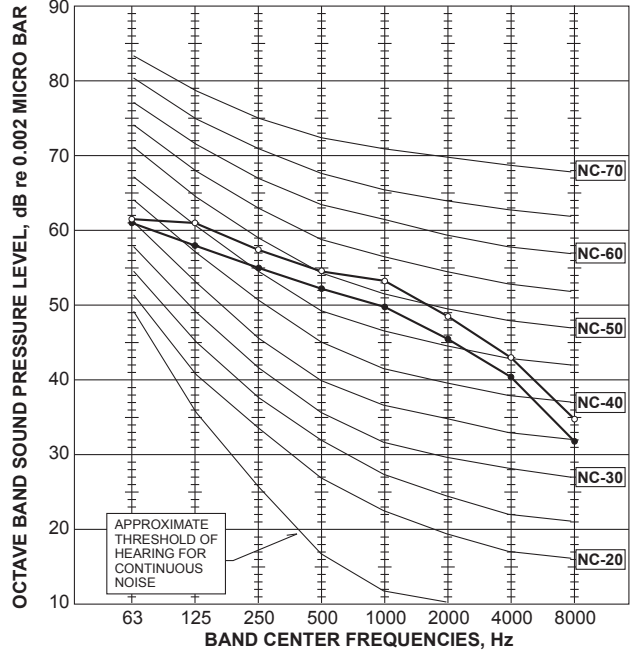

PUZ-M140VKA(-ET).TH
PUZ-M140YKA(-ET).TH

MODE	SPL(dB)	LINE
COOLING	55	●—●
HEATING	57	○—○

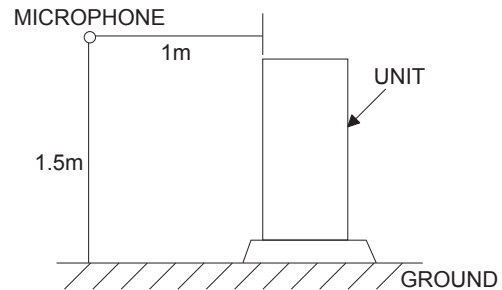
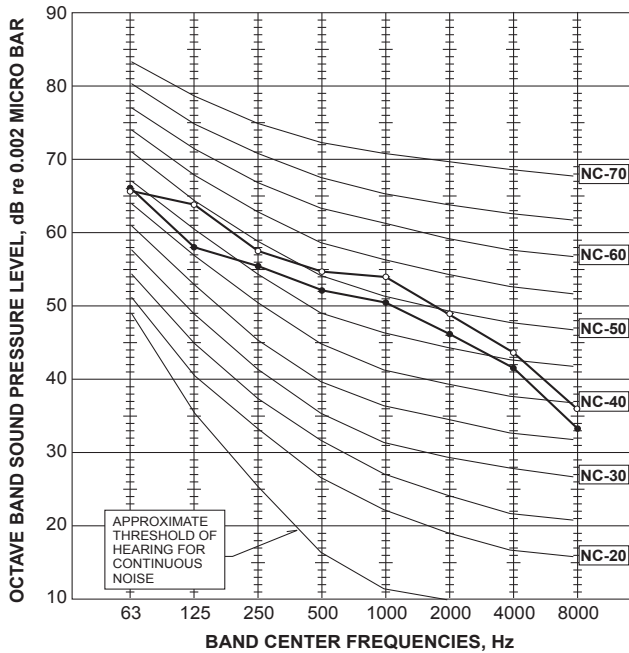

4-4. STANDARD OPERATION DATA

PUZ-M100VKA(-ET).TH PUZ-M100YKA(-ET).TH

PUZ-M125VKA(-ET).TH PUZ-M125YKA(-ET).TH

PUZ-M140VKA(-ET).TH PUZ-M140YKA(-ET).TH

Representative matching				PUZ-M100		PUZ-M125		PUZ-M140		
Mode				COOLING	HEATING	COOLING	HEATING	COOLING	HEATING	
Total	Capacity	W		9.5	11.2	12.1	13.5	13.4	15.0	
	input	kW		2.71	3.01	4.01	3.63	4.96	4.39	
Electrical circuit	Indoor			PLA-M100EA		PLA-M125EA		PLA-M140EA		
	Phase, Hz			1, 50		1, 50		1, 50		
	Voltage			230		230		230		
	Current			A	0.46	0.44	0.66	0.64	0.66	0.64
	Outdoor			PUZ-M100VKA PUZ-M100YKA		PUZ-M125VKA PUZ-M125YKA		PUZ-M140VKA PUZ-M140YKA		
	Phase, Hz			1, 50	3, 50	1, 50	3, 50	1, 50	3, 50	
	Voltage			V	230	400	230	400	230	400
	Current			A	11.7/4.2	13.0/4.7	17.4/6.3	15.6/5.6	21.5/7.8	19.0/6.9
Refrigerant circuit	Discharge Pressure			MPa	2.93	2.70	3.12	2.62	3.28	2.79
	Suction pressure			MPa	0.96	0.70	0.89	0.69	0.84	0.66
	Discharge temperature			°C	90.2	88.7	89.4	81.7	91	88.7
	Condensing temperature			°C	38.0	44.7	39.8	43.5	40.3	45.9
	Suction temperature			°C	14.1	1.3	7.9	0.0	5.6	-0.9
	Ref. pipe length			m	7.5		7.5		7.5	
Indoor side	Intake air temperature		DB	°C	27	20	27	20	27	20
			WB	°C	19	14	19	14	19	14
	Discharge air temperature		DB	°C	13.6	40.1	11.9	41.7	11.3	44.5
Outdoor side	Intake air temperature		DB	°C	35	7	35	7	35	7
			WB	°C	24	6	24	6	24	6
SHF					0.77	—	0.72	—	0.72	—
BF					0.16	—	0.10	—	0.10	—

The unit of pressure has been changed to MPa based on international SI system.

The conversion factor is : 1(MPa)=10.2(kgf/cm²)

PUZ-M100VKA(-ET).TH
 PUZ-M125VKA(-ET).TH
 PUZ-M140VKA(-ET).TH

PUZ-M100YKA(-ET).TH
 PUZ-M125YKA(-ET).TH
 PUZ-M140YKA(-ET).TH

Unit: mm

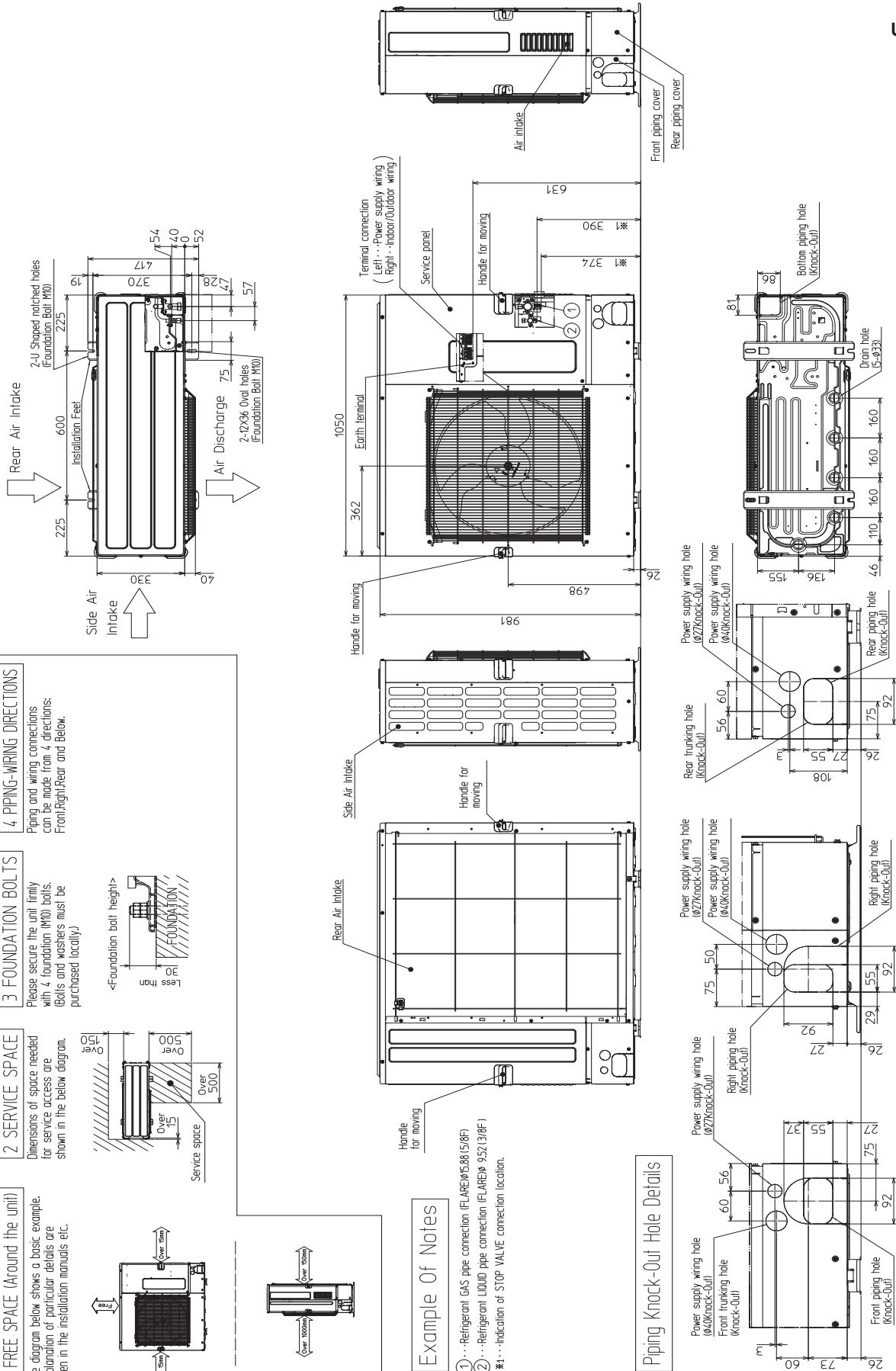

PUZ-M100VKA(-ET).TH

SYMBOL	NAME	SYMBOL	NAME	SYMBOL	NAME
TB1	Terminal Block <Power Supply, Indoor/Outdoor>	LEV-A, LEV-B	Linear Expansion Valve	SW5	Switch <Function Switch>
MC	Motor for Compressor	21S4	Solenoid Valve (4-Way Valve)	SW6	Switch <Model Select>
MF1	Fan Motor	DCL	Reactor	SW7	Switch <Function Switch>
63H	High Pressure Switch	CY1, CY2	Capacitor	SW8	Switch <Function Switch>
TH3	Thermistor <Liquid>	CX1	Capacitor	SW9	Switch <Function Switch>
TH4	Thermistor <Discharge>	P.B.	Power Circuit Board	SWP	Switch <Pump Down>
TH6	Thermistor <2-Phase Pipe>	C.B.	Controller Circuit Board	CN31	Connector <Emergency Operation>
TH7	Thermistor <Ambient>	F1, F2, F3, F4	Fuse <T6.3AL250V>	CN51	Connector <Connection for Option>
TH8	Thermistor <Heat Sink>	SW1	Switch <Manual Defrost, Defect History Record Reset, Refrigerant Address>	CNDM	Connector <Connection for Option>
TH33	Thermistor <Comp. Surface>	SW4	Switch <Function Switch>	CNM	Connector <Connection for Option>
				X52	Relay

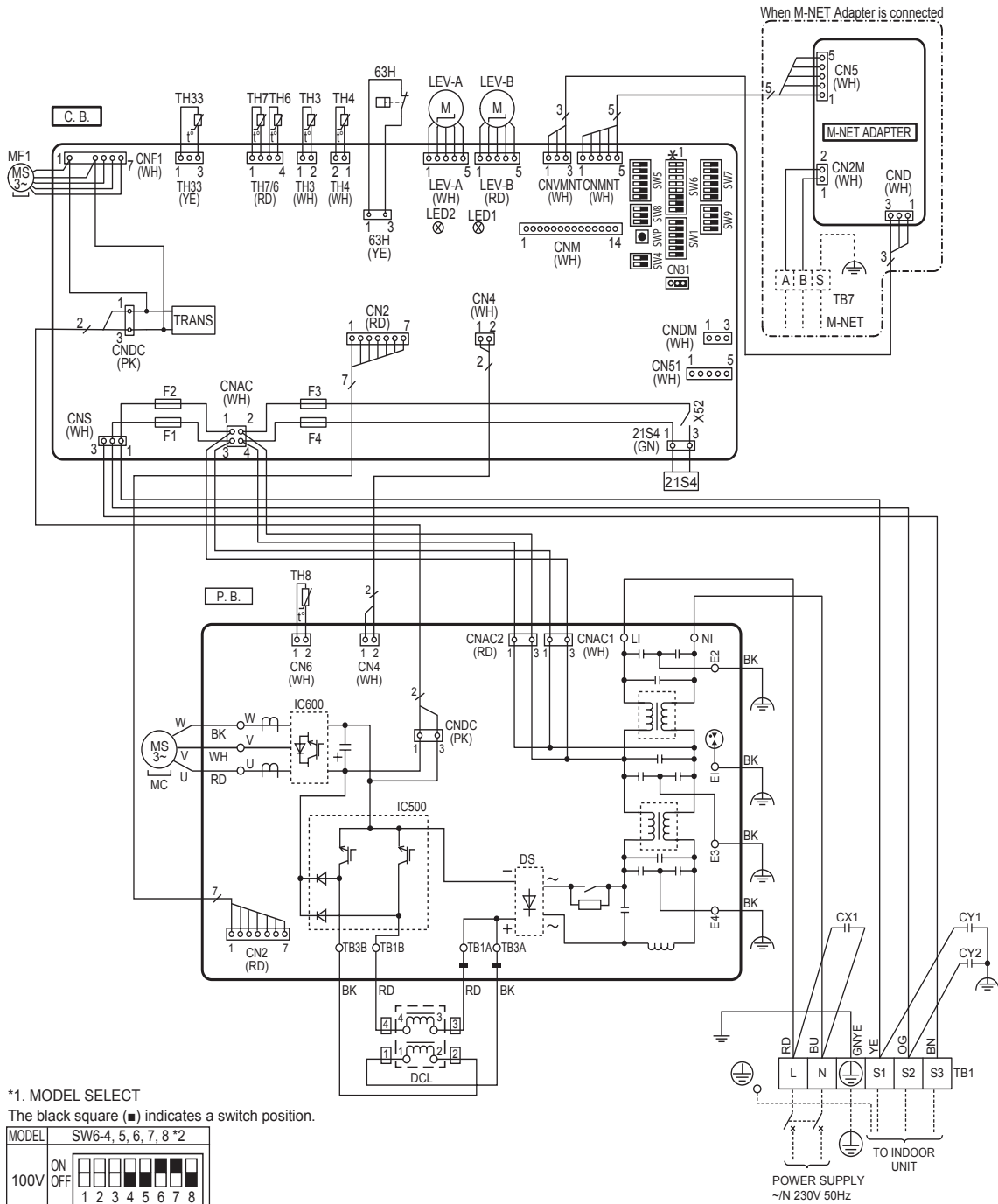

*1. MODEL SELECT
The black square (■) indicates a switch position.

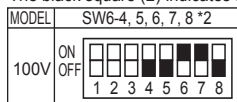

*2. SW6-1 to 3: Function switch

PUZ-M125VKA(-ET).TH PUZ-M140VKA(-ET).TH

SYMBOL	NAME	SYMBOL	NAME	SYMBOL	NAME
TB1	Terminal Block <Power Supply, Indoor/Outdoor>	21S4	Solenoid Valve (4-Way Valve)	SW6	Switch <Model Select>
MC	Motor for Compressor	DCL1, DCL2, DCL3	Reactor	SW7	Switch <Function Switch>
MF1	Fan Motor	CY1, CY2	Capacitor	SW8	Switch <Function Switch>
63H	High Pressure Switch	CX1	Capacitor	SW9	Switch <Function Switch>
TH3	Thermistor <Liquid>	P.B.	Power Circuit Board	SWP	Switch <Pump Down>
TH4	Thermistor <Discharge>	C.B.	Controller Circuit Board	CN31	Connector <Emergency Operation>
TH6	Thermistor <2-Phase Pipe>	F1, F2, F3, F4	Fuse <T6.3AL250V>	CN51	Connector <Connection for Option>
TH7	Thermistor <Ambient>	SW1	Switch <Manual Defrost, Defect History Record Reset, Refrigerant Address>	CNDM	Connector <Connection for Option>
TH8	Thermistor <Heat Sink>	SW4	Switch <Function Switch>	CNM	Connector <Connection for Option>
TH33	Thermistor <Comp. Surface>	SW5	Switch <Function Switch>	X52	Relay
LEV-A, LEV-B	Linear Expansion Valve				

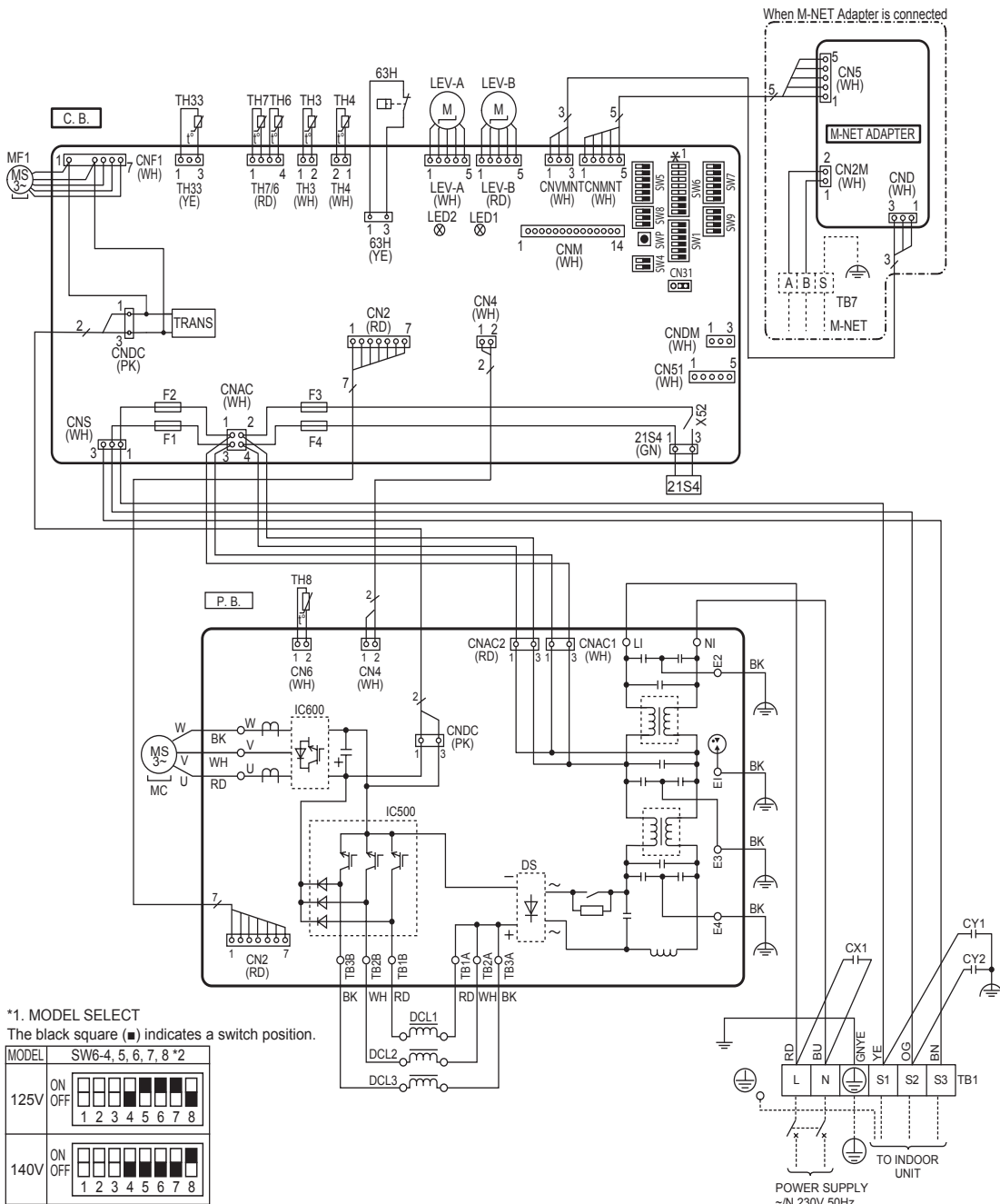

Never splice the power cable or the indoor-outdoor connection cable, otherwise it may result in a smoke, a fire or communication failure.

**PUZ-M100YKA(-ET).TH
 PUZ-M125YKA(-ET).TH
 PUZ-M140YKA(-ET).TH**

SYMBOL	NAME	SYMBOL	NAME	SYMBOL	NAME
TB1	Terminal Block <Power Supply>	21S4	Solenoid Valve (4-Way Valve)	SW5	Switch <Function Switch>
TB2	Terminal Block <Indoor/Outdoor>	ACL4	Reactor	SW6	Switch <Model Select>
MC	Motor for Compressor	DCL	Reactor	SW7	Switch <Function Switch>
MF1	Fan Motor	RS	Resistor	SW8	Switch <Function Switch>
63H	High Pressure Switch	CY1, CY2	Capacitor	SW9	Switch <Function Switch>
TH3	Thermistor <Liquid>	P.B.	Power Circuit Board	SWP	Switch <Pump Down>
TH4	Thermistor <Discharge>	N.F.	Noise Filter Circuit Board	CN31	Connector <Emergency Operation>
TH6	Thermistor <2-Phase Pipe>	C.B.	Controller Circuit Board	CN51	Connector <Connection for Option>
TH7	Thermistor <Ambient>	F1, F2, F3, F4	Fuse <T6.3AL250V>	CNDM	Connector <Connection for Option>
TH8	Thermistor <Heat Sink>	SW1	Switch <Manual Defrost, Defect History Record Reset, Refrigerant Address>	CNM	Connector <Connection for Option>
TH33	Thermistor <Comp. Surface>	SW4	Switch <Function Switch>	X52	Relay
LEV-A, LEV-B	Linear Expansion Valve				

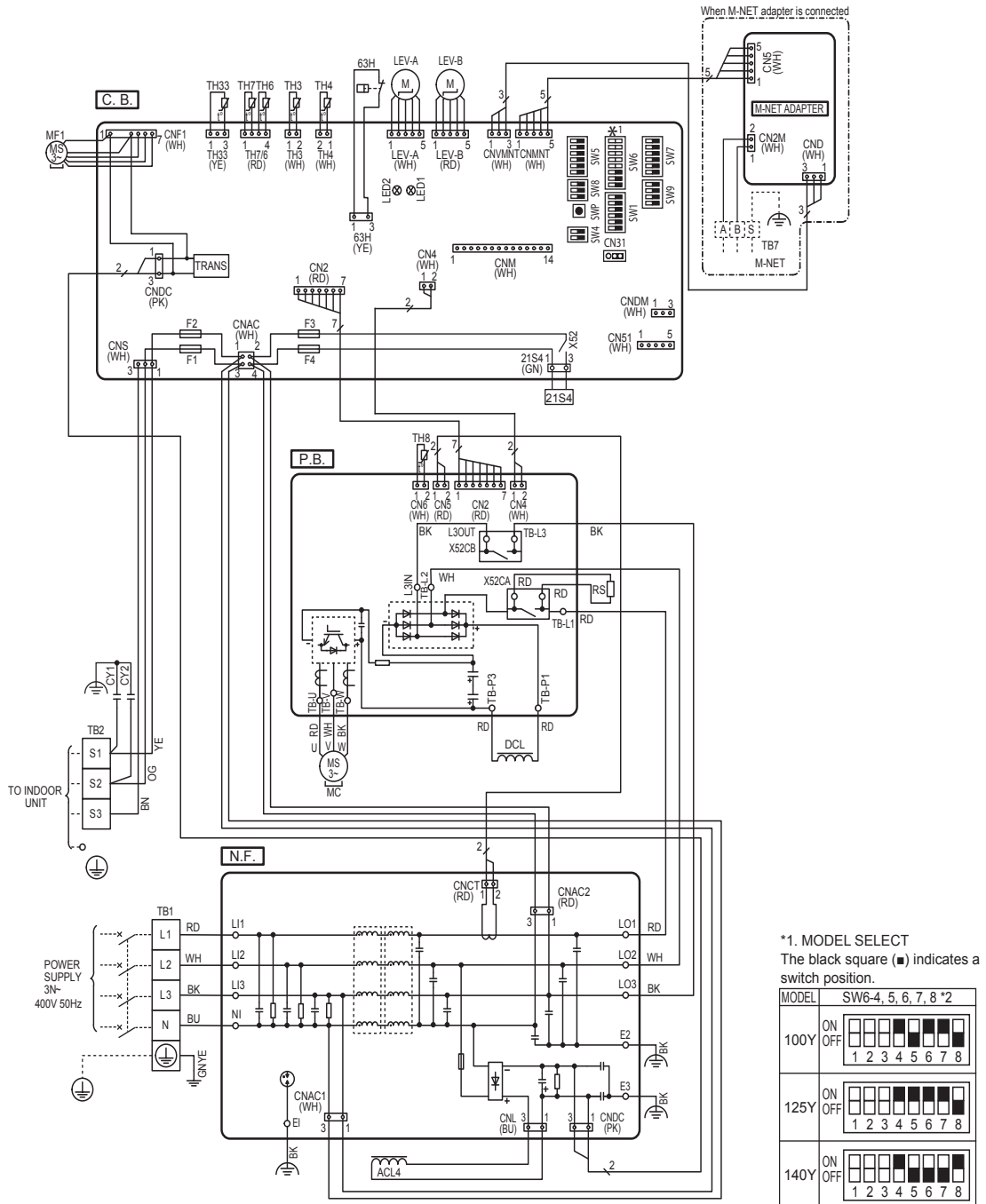

Never splice the power cable or the indoor-outdoor connection cable, otherwise it may result in a smoke, a fire or communication failure.

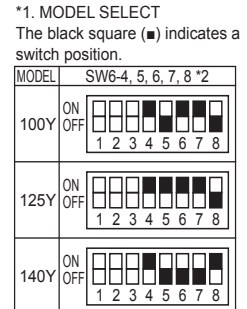

*2. SW6-1 to 3: Function switch

7-1. FIELD ELECTRICAL WIRING (power wiring specifications)

Outdoor unit model		PUZ-M100/125VKA	PUZ-M140VKA	PUZ-M100/125/140YKA
Outdoor unit power supply		~N (single), 50 Hz, 230 V	~N (single), 50 Hz, 230 V	3N~ (3 ph 4-wires), 50 Hz, 400 V
Outdoor unit input capacity Main switch (Breaker) *1		32 A	40 A	16 A
Wiring Wire No. × size (mm ²)	Outdoor unit power supply	3 × Min 6	3 × Min 6	5 × Min 1.5
	Indoor unit-Outdoor unit	3 × 1.5 (Polar)	3 × 1.5 (Polar)	3 × 1.5 (Polar)
	Indoor unit-Outdoor unit earth	1 × Min 1.5	1 × Min. 1.5	1 × Min 1.5
Remote controller-Indoor unit		2 × 0.3 (Non-polar)	2 × 0.3 (Non-polar)	2 × 0.3 (Non-polar)
Circuit rating	Outdoor unit L-N (single)	230 V AC	230 V AC	230 V AC
	Outdoor unit L1-N, L2-N, L3-N (3 phase)	230 V AC	230 V AC	230 V AC
	Indoor unit-Outdoor unit S1-S2	230 V AC	230 V AC	230 V AC
	Indoor unit-Outdoor unit S2-S3	24 V DC	24 V DC	24 V DC
Remote controller-Indoor unit		12 V DC	12 V DC	12 V DC

*1. A breaker with at least 3.0 mm contact separation in each pole shall be provided. Use earth leakage breaker (NV). Make sure that the current leakage breaker is one compatible with higher harmonics. Always use a current leakage breaker that is compatible with higher harmonics as this unit is equipped with an inverter. The use of an inadequate breaker can cause the incorrect operation of inverter.

*2. Max. 45 m
 If 2.5 mm² used, Max. 50 m
 If 2.5 mm² used and S3 separated, Max. 80 m
 • Use one cable for S1 and S2 and another for S3 as shown in the picture.
 • Max. 50 m Total Max. for PEY. Wiring size 3 × 1.5 (Polar).



*3. The 10 m wire is attached in the remote controller accessory.

*4. The figures are NOT always against the ground. S3 terminal has DC 24 V against S2 terminal. However between S3 and S1, these terminals are NOT electrically insulated by the transformer or other device.

⚠ Caution: Be sure to install N-Line. Without N-Line, it could cause damage to the unit.

- Notes:**
1. Wiring size must comply with the applicable local and national code.
 2. Power supply cables and Indoor/Outdoor unit connecting cables shall not be lighter than polychloroprene sheathed flexible cable. (Design 60245 IEC 57)
 3. Install an earth line longer than power cables.

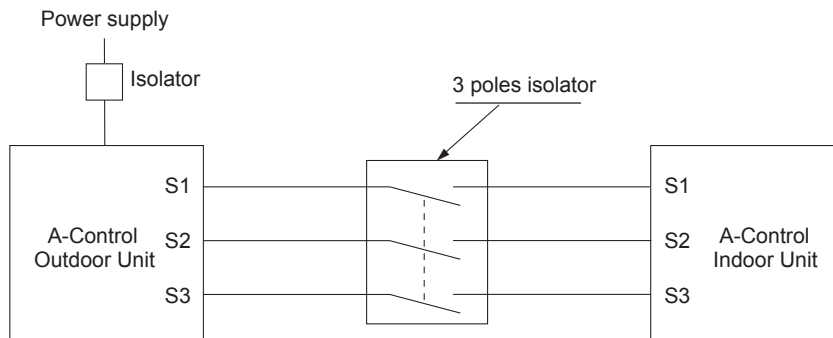

⚠ Warning:
 In case of A-control wiring, there is high voltage potential on the S3 terminal caused by electrical circuit design that has no electrical insulation between power line and communication signal line. Therefore, please turn off the main power supply when servicing. And do not touch the S1, S2, S3 terminals when the power is energized. If isolator should be used between indoor unit and outdoor unit, please use 3-pole type.

Never splice the power cable or the indoor-outdoor unit connection cable, otherwise it may result in a smoke, a fire or communication failure.

1:1 system Electrical wiring

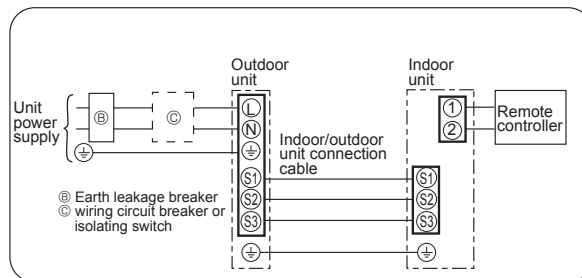

7-2. SEPARATE INDOOR UNIT/ OUTDOOR UNIT POWER SUPPLIES

The following connection patterns are available.
The outdoor unit power supply patterns vary on models.

1:1 System

The optional indoor power supply terminal kit is required.

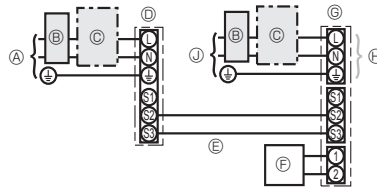

- Ⓐ Outdoor unit power supply
- Ⓑ Earth leakage breaker
- Ⓒ Wiring circuit breaker or isolating switch
- Ⓓ Outdoor unit
- Ⓔ Indoor unit/outdoor unit connecting cords
- Ⓕ Remote controller
- Ⓖ Indoor unit
- Ⓗ Option
- Ⓙ Indoor unit power supply

Affix a label B that is included with the manuals near each wiring diagram for the indoor and outdoor units.

Simultaneous twin/triple system

<For models without heater>

The optional indoor power supply terminal kit is required.

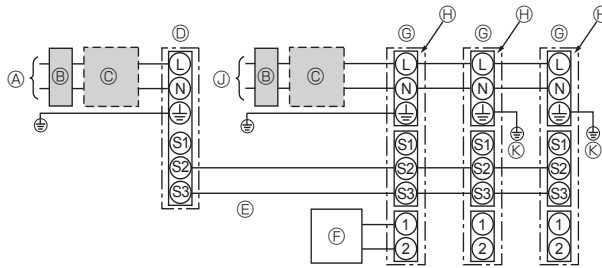

- Ⓐ Outdoor unit power supply
- Ⓑ Earth leakage breaker
- Ⓒ Wiring circuit breaker or isolating switch
- Ⓓ Outdoor unit
- Ⓔ Indoor unit/outdoor unit connecting cables
- Ⓕ Remote controller
- Ⓖ Indoor unit
- Ⓗ Option
- Ⓙ Indoor unit power supply
- Ⓚ Indoor unit earth

Affix a label B that is included with the manuals near each wiring diagram for the indoor and outdoor units.

If the indoor and outdoor units have separate power supplies, refer to the table below.
If the optional indoor power supply terminal kit is used, change the indoor unit electrical box wiring referring to the figure in the right and the DIP switch settings of the outdoor unit control board.

	Indoor unit specifications									
Indoor power supply terminal kit (option)	Required									
Indoor unit electrical box connector connection change	Required									
Label affixed near each wiring diagram for the indoor and outdoor units	Required									
Outdoor unit DIP switch settings (when using separate indoor unit/outdoor unit power supplies only)	<table border="1"> <tr> <td>ON</td> <td></td> <td></td> <td>3</td> <td rowspan="2">(SW8)</td> </tr> <tr> <td>OFF</td> <td>1</td> <td>2</td> <td></td> </tr> </table> <p>Set the SW8-3 to ON.</p>	ON			3	(SW8)	OFF	1	2	
ON			3	(SW8)						
OFF	1	2								

Note:

There are 3 types of labels (labels A, B, and C). Affix the appropriate labels to the units according to the wiring method.

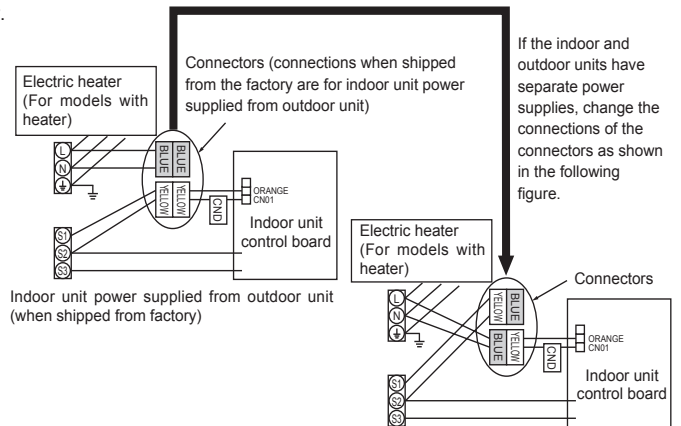

Separate indoor unit/outdoor unit power supplies

Indoor unit model		50-140
Indoor unit power supply		~N (single), 50 Hz, 230 V
Indoor unit input capacity		16 A
Main switch (Breaker)		
Wiring Wire No. x size (mm ²)	Indoor unit power supply	3 × Min 1.5
	Indoor unit power supply earth	1 × Min 1.5
	Indoor unit-Outdoor unit	2 × Min 0.3
	Indoor unit-Outdoor unit earth	-
Circuit rating	Remote controller-Indoor unit	2 × 0.3 (Non-polar)
	Indoor unit L-N	230 V AC
	Indoor unit-Outdoor unit S1-S2	-
	Indoor unit-Outdoor unit S2-S3	24 V DC
Remote controller-Indoor unit		12 V DC

*1. A breaker with at least 3 mm contact separation in each pole shall be provided. Use earth leakage breaker (NV).
The breaker shall be provided to ensure disconnection of all active phase conductor of the supply.

*2. Max. 120 m

*3. Max. 500 m (Max. 200 m when 2 remote controllers are used)

*4. The figures are NOT always against the ground.

Notes: 1. Wiring size must comply with the applicable local and national code.

2. Power supply cables and indoor unit/outdoor unit connecting cables shall not be lighter than polychloroprene sheathed flexible cable. (Design 60245 IEC 57)

3. Install an earth line longer than power cables.

7-3. INDOOR – OUTDOOR CONNECTING CABLE

The cable shall not be lighter than design 60245 IEC or 60227 IEC.

Outdoor power supply	Wire No. × Size (mm ²)	
	Max. 45m	Max. 50m
Indoor unit-Outdoor unit	3 × 1.5 (polar)	3 × 2.5 (polar)
Indoor unit-Outdoor unit earth	1 × Min 1.5	1 × Min 2.5

Note: The Max. cable length may vary depending on the condition of installation, humidity or materials, etc.

Indoor/Outdoor separate power supply	Wire No. × Size (mm ²)	
	Max. 120m	
Indoor unit-Outdoor unit	2 × Min 0.3	
Indoor unit-Outdoor unit earth	—	

Note: The optional indoor power supply terminal kit is necessary.

Be sure to connect the indoor-outdoor connecting cables directly to the units (no intermediate connections). Intermediate connections can lead to communication errors if water enters the cables and causes insufficient insulation to ground or a poor electrical contact at the intermediate connection point.

7-4. M-NET WIRING METHOD

(Points to note)

- (1) Outside the unit, transmission wires should stay away from electric wires in order to prevent electromagnetic noise from making an influence on the signal communication. Place them at intervals of more than 5 cm. Do not put them in the same conduit tube.
- (2) Terminal block (TB7) for transmission wires should never be connected to 220–240 V power supply. If it is connected, electronic parts on M-NET P.C. board may burn out.
- (3) Use 2-core × 1.25mm² shield wire (CVVS, CPEVS) for the transmission wire. Transmission signals may not be sent or received normally if different types of transmission wires are put together in the same multi-conductor cable. Never do this because this may cause a malfunction.

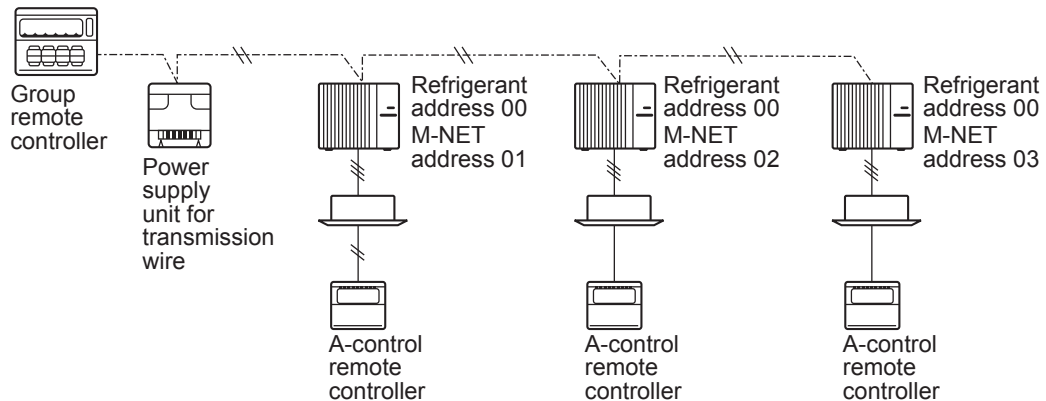

It would be acceptable if M-NET wire (non-polar, 2-cores) is arranged in addition to the wiring for A-control.

- (4) Earth only one of any appliances through M-NET transmission wire (shield wire). Communication error may occur due to the influence of electromagnetic noise.

“Ed” error will appear on the LED display of outdoor unit.

“0403” error will appear on the centralized remote controller.

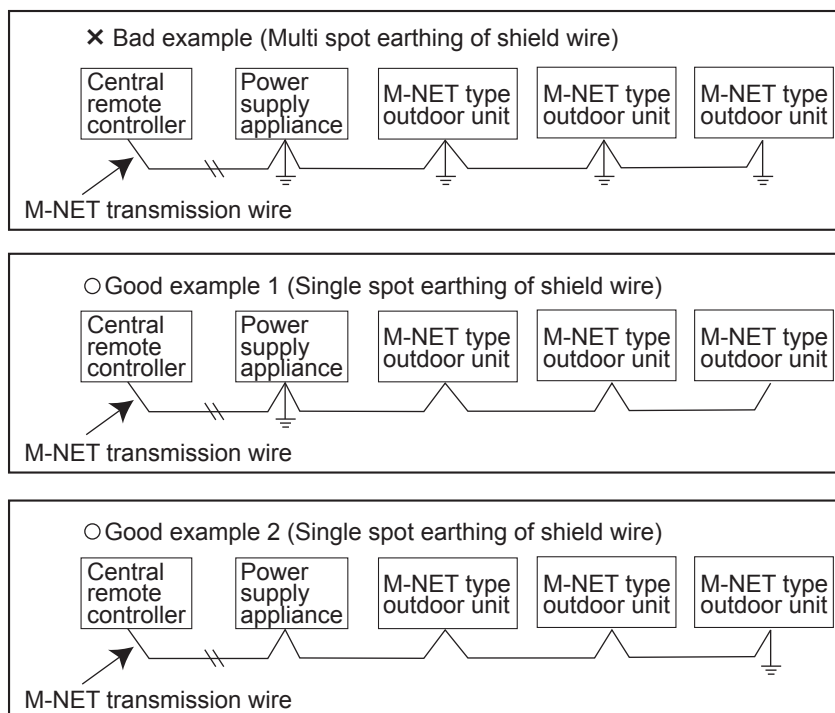

If there are more than 2 earthing spots on the shield wire, noise may enter into the shield wire because the earth wire and shield wire form 1 circuit and the electric potential difference occurs due to the impedance difference among earthing spots. In case of single spot earthing, noise does not enter into the shield wire because the earth wire and shield wire do not form 1 circuit.

To avoid communication errors caused by noise, make sure to observe the single spot earthing method described in the installation manual.

● M-NET wiring

- Use 2-core × 1.25mm² shield wire for electric wires.
(Excluding the case connecting to system controller.)
- Connect the wire to the M-NET terminal block. Connect one core of the transmission wire (non-polar) to A terminal and the other to B. Peel the shield wire, twist the shield part to a string and connect it to S terminal.
- In the system which several outdoor units are being connected, the terminal (A, B, S) on M-NET terminal block should be individually wired to the other outdoor unit's terminal, i.e. A to A, B to B and S to S. In this case, choose one of those outdoor units and drive a screw to fix an earth wire on the plate as shown on the right figure.

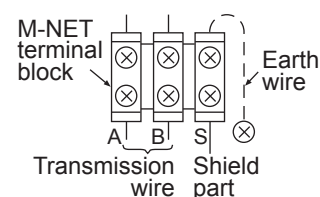

7-4-1. M-NET address setting

In A-control models, M-NET address and refrigerant address should be set only for the outdoor unit. Similar to CITY MULTI system, there is no need to set the address of outdoor unit and remote controller. To construct a central control system, the setting of M-NET address should be conducted only upon the outdoor unit. The setting range should be 1 to 50 (the same as that of the indoor unit in CITY MULTI system), and the address number should be consecutively set in a same group.

Address number can be set by using rotary switches (SW11 for 1st digit and SW12 for 2nd digit), which is located on the M-NET board of outdoor unit. (Initial setting: all addresses are set to "0".)

<Setting example>

M-NET Address No.		1	2	...	50
Switch setting	SW11 1st digit			~	
	SW12 2nd digit			~	

7-4-2. Refrigerant address setting

In the case of multiple grouping system (multiple refrigerant circuits in 1 group), indoor units should be connected by remote controller wiring (TB5) and the refrigerant address needs to be set. Leave the refrigerant addresses to "00" if the group setting is not conducted. Set the refrigerant address by using DIP SW1-3 to -6 on the outdoor controller board. [Initial setting: all switches are OFF. (All refrigerant addresses are "00".)]

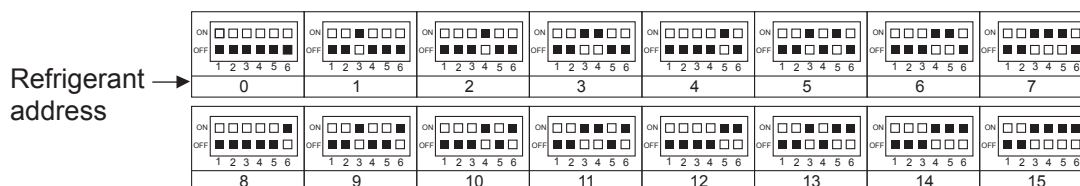

7-4-3. Regulations in address settings

In the case of multiple grouping system, M-NET and refrigerant address settings should be done as explained in the above section. Set the lowest number in the group for the outdoor unit whose refrigerant address is "00" as its M-NET address.

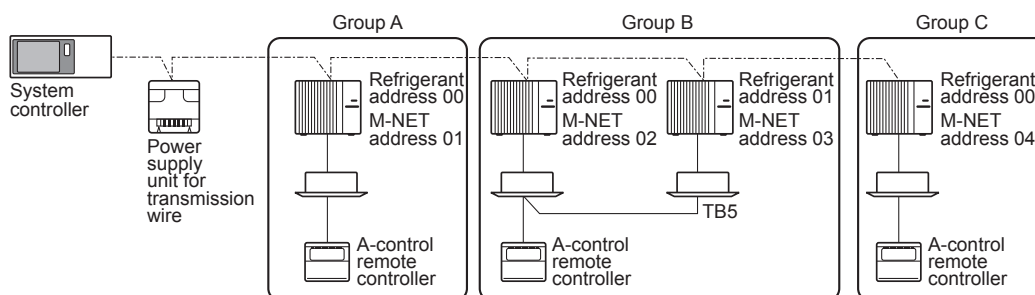

Note: Refrigerant addresses can be overlapped if they are in the different group.

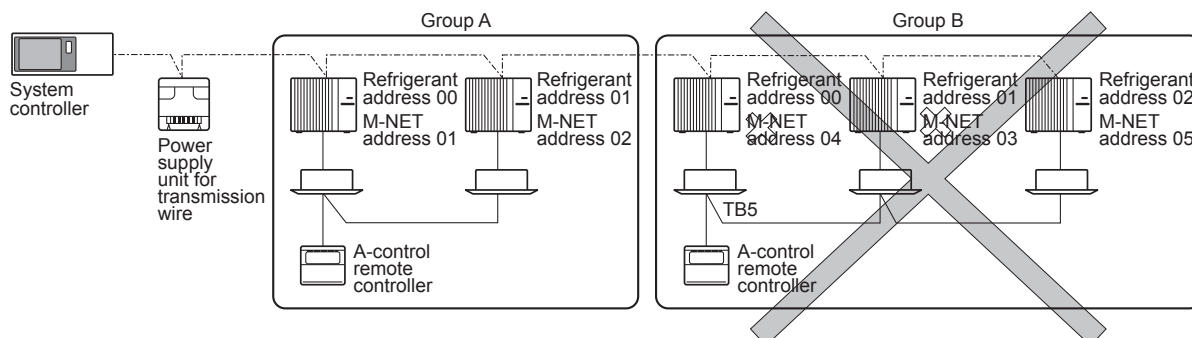

Note:

In group B, M-NET address of the outdoor unit whose refrigerant address is "00" is not set to the minimum in the group. As "3" is right for this situation, the setting is wrong. Taking group A as a good sample, set the minimum M-NET address in the group for the outdoor unit whose refrigerant address is "00".

PUZ-M100VKA(-ET).TH
 PUZ-M125VKA(-ET).TH
 PUZ-M140VKA(-ET).TH

PUZ-M100YKA(-ET).TH
 PUZ-M125YKA(-ET).TH
 PUZ-M140YKA(-ET).TH

Unit : mm (inch)

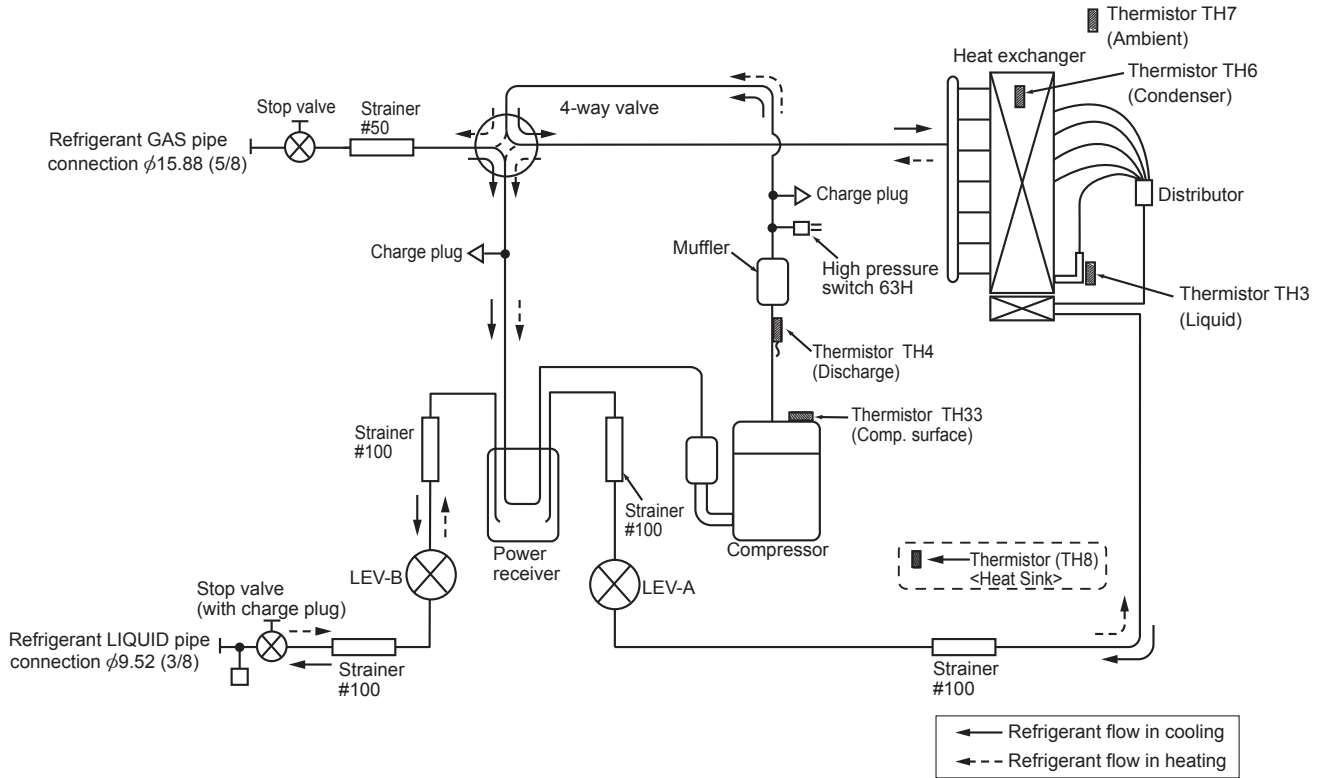

8-1. REFRIGERANT COLLECTING (PUMP DOWN)

When relocating or disposing of the indoor/outdoor unit, pump down the system following the procedure below so that no refrigerant is released into the atmosphere.

- ① Turn off the power supply (circuit breaker).
- ② Connect the low pressure valve on the gauge manifold to the charge plug (low pressure side) on the outdoor unit.
- ③ Close the liquid stop valve completely.
- ④ Supply power (circuit breaker).
 - When power is supplied, make sure that “CENTRALLY CONTROLLED” is not displayed on the remote controller. If “CENTRALLY CONTROLLED” is displayed, the refrigerant collecting (pump down) cannot be completed normally.
 - Startup of the indoor-outdoor communication takes about 3 minutes after the power (circuit breaker) is turned on. Start the pump-down operation 3 to 4 minutes after the power (circuit breaker) is turned on.
- ⑤ Perform the refrigerant collecting operation (cooling test run).
 - Push the pump-down SWP switch (push-button type) on the control board of the outdoor unit. The compressor and ventilators (indoor and outdoor units) start operating (refrigerant collecting operation begins). (LED1 and LED2 on the control board of the outdoor unit are lit.)
 - Only push the pump-down SWP switch if the unit is stopped. However, even if the unit is stopped and the pump-down SWP switch is pushed less than 3 minutes after the compressor stops, the refrigerant collecting operation cannot be performed. Wait until the compressor has been stopped for 3 minutes and then push the pump-down SWP switch again.
- ⑥ Fully close the stop valve on the gas pipe side of the outdoor unit when the pressure gauge on the gauge manifold shows 0.05 to 0 MPa [Gauge] (approx. 0.5 to 0 kgf/cm²) and quickly stop the air conditioner.
 - Because the unit automatically stops in about 3 minutes when the refrigerant collecting operation is completed (LED1 off, LED2 lit), be sure to quickly close the gas stop valve. However, if LED1 is lit, LED2 is off, and the unit is stopped, open the liquid stop valve completely, close the valve completely after 3 minutes or more have passed, and then repeat step ⑤. (Open the gas stop valve completely.)
 - If the refrigerant collecting operation has been completed normally (LED1 off, LED2 lit), the unit will remain stopped until the power supply is turned off.
 - Note that when the extension piping is very long with a large refrigerant amount, it may not be possible to perform a pump-down operation. In this case, use refrigerant recovery equipment to collect all of the refrigerant in the system.
- ⑦ Turn off the power supply (circuit breaker), remove the gauge manifold, and then disconnect the refrigerant pipes.

⚠ Warning:

When pumping down the refrigerant, stop the compressor before disconnecting the refrigerant pipes.

- **If the refrigerant pipes are disconnected while the compressor is operating and the stop valve is open, the pressure in the refrigeration cycle could become extremely high if air is drawn in, causing the pipes to burst, personal injury, etc.**

8-2. START AND FINISH OF TEST RUN

- Operation from the indoor unit
Execute the test run using the installation manual for the indoor unit.
- Operation from the outdoor unit
By using the DIP switch SW4 on the control board of outdoor unit, test run can be started and finished, and its operation mode (cooling) can be set up.
 - ① Turn on SW4-1 to start test run.
 - ② Turn off SW4-1 to finish the test run.
- There may be a faint knocking sound around the machine room after power is supplied, but this is no problem with product because the linear expansion pipe is just moving to adjust opening pulse.
- There may be a knocking sound around the machine room for several seconds after compressor starts operating, but this is no problem with product because the check valve itself, generates the sound because pressure difference is small in the refrigerant circuit.

9-1. TROUBLESHOOTING

<Check code display by self-diagnosis and actions to be taken for service (summary)>

Present and past check codes are logged, and they can be displayed on the wired remote controller and control board of outdoor unit. Actions to be taken for service, which depends on whether or not the trouble is reoccurring in the field, are summarized in the table below. Check the contents below before investigating details.

Unit conditions at service	Check code	Actions to be taken for service (summary)
The trouble is reoccurring.	Displayed	Judge the problem and take a corrective action according to "9-4. SELF-DIAGNOSIS ACTION TABLE".
	Not displayed	Conduct troubleshooting and ascertain the cause of the trouble according to "9-5. TROUBLESHOOTING OF PROBLEMS".
The trouble is not reoccurring.	Logged	①Consider the temporary defects such as the work of protection devices in the refrigerant circuit including compressor, poor connection of wiring, noise, etc. Re-check the symptom, and check the installation environment, refrigerant amount, weather when the trouble occurred, matters related to wiring, etc. ②Reset check code logs and restart the unit after finishing service. ③There is no abnormality in electrical component, controller board, remote controller, etc.
	Not logged	①Re-check the abnormal symptom. ②Conduct troubleshooting and ascertain the cause of the trouble according to "9-5. TROUBLESHOOTING OF PROBLEMS". ③Continue to operate unit for the time being if the cause is not ascertained. ④There is no abnormality concerning of parts such as electrical component, controller board, remote controller, etc.

9-2. CHECKPOINT UNDER TEST RUN

9-2-1. Before test run

- After installation of indoor and outdoor units, piping work and electric wiring work, re-check that there is no refrigerant leakage, loosened connections and incorrect polarity.
- Measure impedance between the ground and the power supply terminal block (L, N) on the outdoor unit by 500 V Megger and check that it is 1.0MΩ or over.
- * Do not use 500 V Megger to indoor/outdoor connecting wire terminal block (S1, S2, S3) and remote controller terminal block (1, 2). This may cause malfunction.
- Make sure that test run switch (SW4) is set to OFF before turning on power supply.
- Turn on power supply 12 hours before test run in order to protect compressor.
- For specific models which require higher ceiling settings or auto-recovery feature from power failure, make proper changes of settings referring to the description of "10. FUNCTION SETTING".

Make sure to read operation manual before test run. (Especially items to secure safety.)

9-2-2. Test run for wired remote controller
<PAR-3xMAA("x" represents 0 or later)>

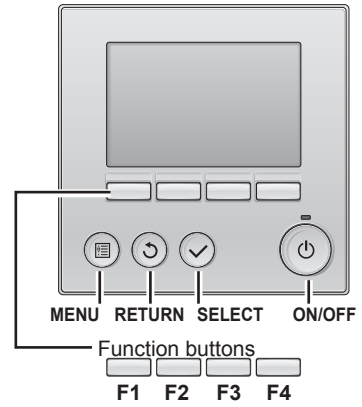

① Select "Service" from the Main menu, and press the button.



Select "Test run" with the **F1** or **F2** button, and press the button.

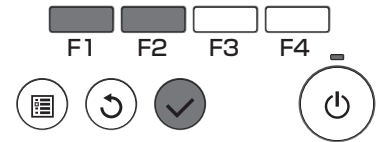
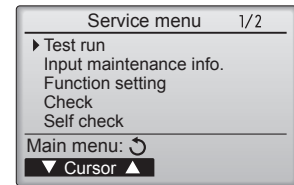

② Select "Test run" with the **F1** or **F2** button, and press the button.

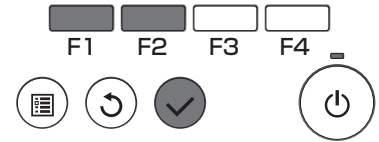
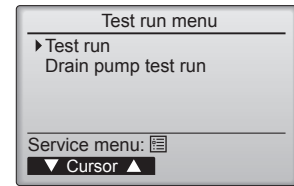

Test run operation

Press the **F1** button to go through the operation modes in the order of "Cool and Heat".

Cool mode: Check the cold air blows out.
 Heat mode: Check the heat blows out.

* Check the operation of the outdoor unit's fan.



Press the button and open the Vane setting screen.

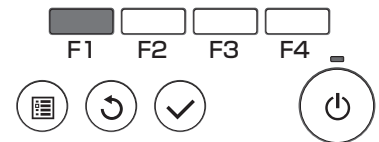
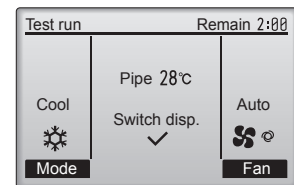

Auto vane check

Check the auto vane with the **F1** **F2** buttons.



Press the button to return to "Test run operation".



Press the button.

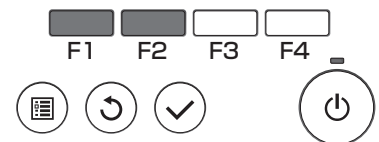
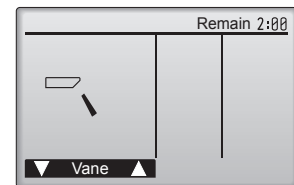

When the test run is completed, the "Test run menu" screen will appear.
 * The test run will automatically stop after two hours.

<Error information>

**When an error occurs, the following screen will appear.
Check the error status, stop the operation, and consult your dealer.**

- ① Check code, error unit, refrigerant address, unit model name, and serial number will appear.

The model name and serial number will appear only if the information have been registered.

Press the **F1** or **F2** button to go to the next page.

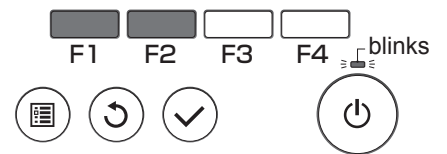
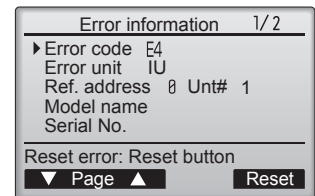

Contact information (dealer's phone number) will appear if the information have been registered.

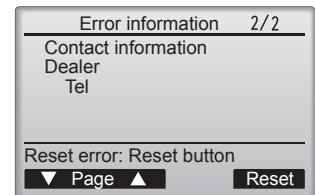

- ② Press the **F4** button or the  button to reset the error that is occurring.

Errors cannot be reset while the ON/OFF operation is prohibited.

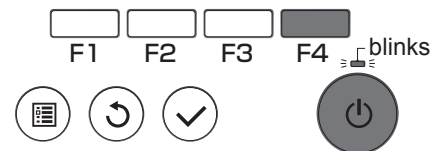
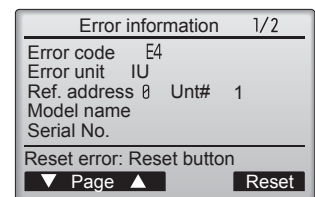

Select "OK" with the **F4** button.

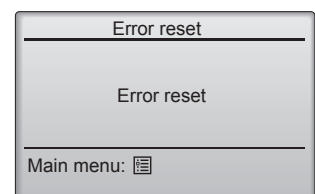
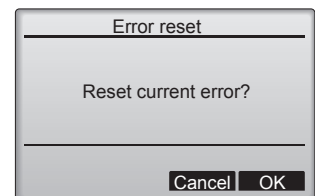

Navigating through the screens

- To go back to the Main menu  button

<Checking the error information>

While no errors are occurring, page 2/2 of the error information can be viewed by selecting "Error information" from the Main menu. Errors cannot be reset from this screen.

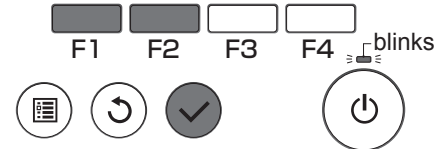
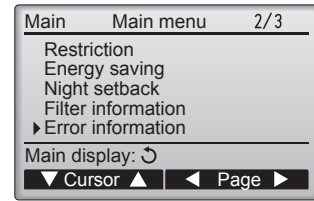

<Error history>

① Select "Service" from the Main menu, and press the [Check] button.



Select "Check" with the [F1] or [F2] button, and press the [Check] button.

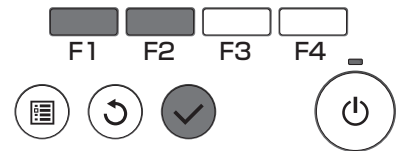
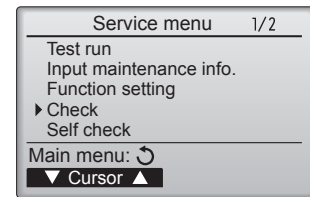

② Select "Error history" with the [F1] or [F2] button, and press the [Check] button.

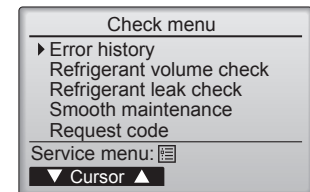

Error history

③ Select "Error history" from the Check menu, and press the [Check] button to view up to 16 error history records.

Four records are shown per page, and the top record on the first page indicates the latest check code record.

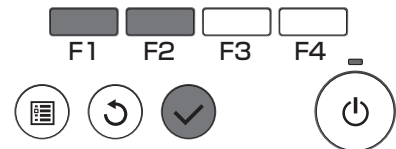
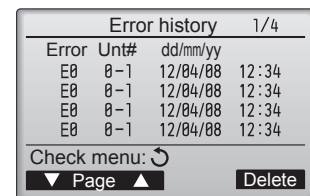

Deleting the error history

④ To delete the error history, press the [F4] button (Delete) on the screen that shows error history. A confirmation screen will appear asking if you want to delete the error history.

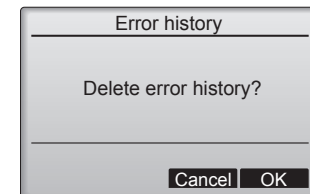

Press the [F4] button (OK) to delete the history.



"Error history deleted" will appear on the screen.



Press the [Reset] button to go back to the Check menu screen.

9-2-3. Test run for wired remote controller <PAR-21MAA>

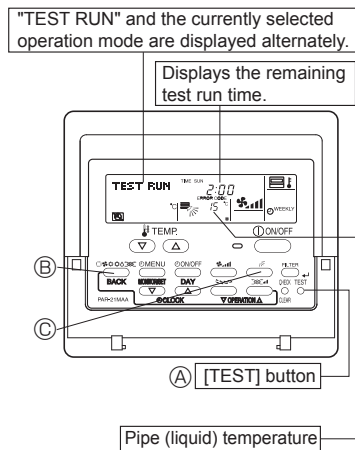

Operating procedures	
1. Turn on the main power supply.	While the room temperature display on the remote controller is "PLEASE WAIT", the remote controller is disabled. Wait until "PLEASE WAIT" disappears before using remote controller. "PLEASE WAIT" appears for about 2 minutes after power supply is turned on. *1
2. Press (A) [TEST] button twice.	The [TEST RUN] appears on the screen.
3. Press (B) [OPERATION SWITCH] button.	Cooling mode: Check if cool air blows and water is drained. Heating mode: Check if warm air blows. (It takes a little while until warm air blows.)
4. Press (C) [AIR DIRECTION] button.	Check for correct motion of auto-vanes.
5. Check the outdoor unit fan for correct running.	The outdoor unit features automatic capacity control to provide optimum fan speeds. Therefore, the fan keeps running at a low speed to meet the current outside air condition unless it exceeds its available maximum power. Then, in actuality, the fan may stop or run in the reverse direction depending on the outside air, but this does not mean malfunction.
6. Press the [ON/OFF] button to reset the test run in progress.	
7. Register the contact number.	

- In case of test run, the OFF timer will be activated, and the test run will automatically stop after 2 hours.
- The room temperature display section shows the pipe temperature of indoor units during the test run.
- Check that all the indoor units are running properly in case of simultaneous twin and triple operation. Malfunctions may not be displayed regardless of incorrect wiring.
- *1 After turning on the power supply, the system will go into startup mode, "PLEASE WAIT" will blink on the display section of the room temperature, and lamp (green) of the remote controller will blink.
As to INDOOR BOARD LED, LED1 will be lit up, LED2 will either be lit up in case the address is 0 or turned off in case the address is not 0. LED3 will blink.
As to OUTDOOR BOARD LED, LED1 (green) and LED2 (red) will be lit up. (After the startup mode of the system finishes, LED2 (red) will be turned off.)
If OUTDOOR BOARD LED is digital display, [] and [] will be displayed alternately every second.
- If one of the above operations does not function correctly, the causes written below should be considered. Find causes from the symptoms.
The below symptoms are under test run mode. "Startup" in the table means the display status of *1 written above.

Symptoms in test run mode		
Remote Controller Display	OUTDOOR BOARD LED Display <> indicates digital display.	Cause
Remote controller displays "PLEASE WAIT", and cannot be operated.	After "startup" is displayed, only green lights up. <00>	• After power is turned on, "PLEASE WAIT" is displayed for 2 minutes during system startup. (Normal)
After power is turned on, "PLEASE WAIT" is displayed for 3 minutes, then check code is displayed.	After "startup" is displayed, green(once) and red(once) blink alternately. <F1>	• Incorrect connection of outdoor terminal block (L1, L2, L3 and S1, S2, S3.)
	After "startup" is displayed, green(once) and red(twice) blink alternately. <F3, F5, F9>	• Outdoor unit's protection device connector is open.
No display appears even when remote controller operation switch is turned on. (Operation lamp does not light up.)	After "startup" is displayed, green(twice) and red(once) blink alternately. <EA, Eb>	• Incorrect wiring between the indoor and outdoor unit (Polarity is wrong for S1, S2, S3.) • Remote controller transmission wire short.
	After "startup" is displayed, only green lights up. <00>	• There is no outdoor unit of address 0. (Address is other than 0.) • Remote controller transmission wire open.
Display appears but soon disappears even when remote controller is operated.	After "startup" is displayed, only green lights up. <00>	• After canceling function selection, operation is not possible for about 30 seconds. (Normal)

Note: Press the remote controller's [CHECK] button twice to perform self-diagnosis. See the table below for the contents of LCD display.











LCD	Contents of trouble	LCD	Contents of trouble
P1	Abnormality of room temperature thermistor	Fb	Abnormality of indoor controller board
P2	Abnormality of pipe temperature thermistor/Liquid	U1~UP	Malfunction outdoor unit
P4	Abnormality of drain sensor/ Float switch connector open	F3~F9	Malfunction outdoor unit
P5	Drain overflow protection is operating.	E0~E5	Remote controller transmitting error
P6	Freeze/overheat protection is operating.	E6~EF	Indoor/outdoor unit communication error
P8	Abnormality of pipe temperature	----	No error history
P9	Abnormality of pipe temperature thermistor/Cond./Eva	FFFF	No applied unit
PL	Abnormality of refrigerant circuit	PA	Forced compressor stop(due to water leakage abnormality)

See the table below for details of the LED display (LED 1, 2, 3) on the indoor controller board.

LED1 (microprocessor power supply)	Lights when power is supplied.
LED2 (remote controller)	Lights when power is supplied for wired remote controller. The indoor unit should be connected to the outdoor unit with address "0" setting.
LED3 (indoor/outdoor communication)	Blinks when indoor and outdoor unit are communicating.

9-2-4. Test run for wireless remote controller

Measure an impedance between the power supply terminal block on the outdoor unit and ground with a 500 V Megger and check that it is equal to or greater than 1.0MΩ.

- ① Turn on the main power to the unit.
- ② Press the  button twice continuously.
(Start this operation from the status of remote controller display turned off.)
A  and current operation mode are displayed.
- ③ Press the  () button to activate  mode, then check whether cool air blows out from the unit.
- ④ Press the  () button to activate  mode, then check whether warm air blows out from the unit.
- ⑤ Press the  button and check whether strong air blows out from the unit.
- ⑥ Press the  button and check whether the auto vane operates properly.
- ⑦ Press the ON/OFF button to stop the test run.

Note:

- Point the remote controller towards the indoor unit receiver while following steps ② to ⑦.
- It is not possible to run in FAN, DRY or AUTO mode.

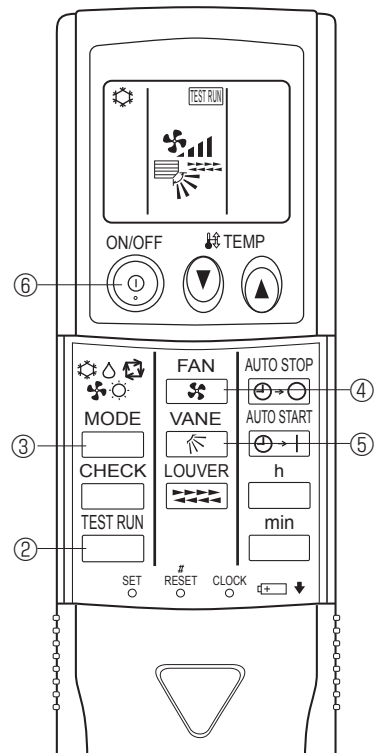

9-3. HOW TO PROCEED "SELF-DIAGNOSIS"

9-3-1. Self-diagnosis <PAR-3xMAA ("x" represents 0 or later)>

① Select "Service" from the Main menu, and press the  button.



Select "Self check" with the **F1** or **F2** button, and press the  button.

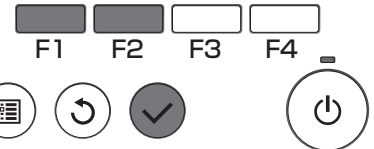
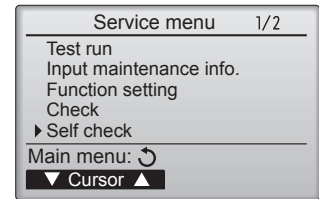

② With the **F1** or **F2** button, enter the refrigerant address, and press the  button.

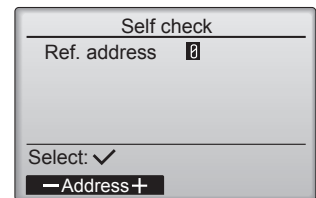

③ Check code, unit number, attribute will appear.
"-" will appear if no error history is available.

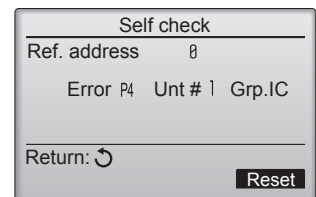

When there is no error history

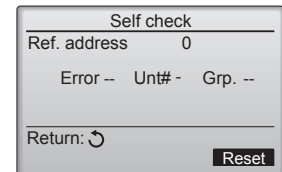

④ Resetting the error history.

Press the **F4** button (Reset) on the screen that shows the check code history.



A confirmation screen will appear asking if you want to delete the check code history.



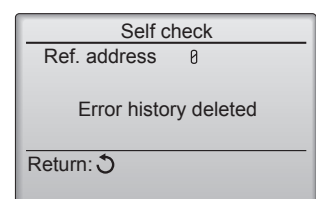
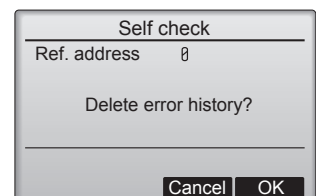

Press the **F4** button (OK) to delete the check code history.

If deletion fails, "Request rejected" will appear.
"Unit not exist" will appear if no indoor units that are correspond to the entered address are found.





Navigating through the screens

- To go back to the Service menu  button
- To return to the previous screen  button

9-3-2. Remote controller check <PAR-3xMAA ("x" represents 0 or later)>



If operations cannot be completed with the remote controller, diagnose the remote controller with this function.

- ① Select "Service" from the Main menu, and press the  button.

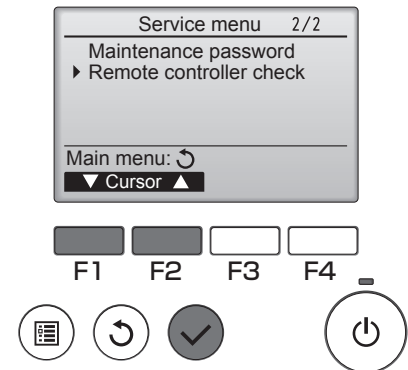
Select "Remote controller check" with the **F1** or **F2** button, and press the  button.



- ② Select "Remote controller check" from the Service menu, and press the  button to start the remote controller check and see the check results.

To cancel the remote controller check and exit the Remote controller check menu screen, press the  or the  button.

The remote controller will not reboot itself.

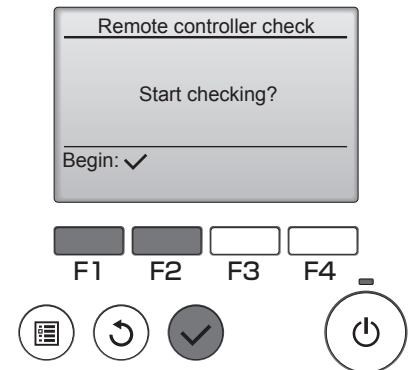

- ③ **OK:** No problems are found with the remote controller. Check other parts for problems.
E3, 6832: There is noise on the transmission line, or the indoor unit or another remote controller is faulty. Check the transmission line and the other remote controllers.
NG (ALL0, ALL1): Send-receive circuit fault. Remote controller needs replacing.
ERC: The number of data errors is the discrepancy between the number of bits in the data transmitted from the remote controller and that of the data that was actually transmitted over the transmission line. If data errors are found, check the transmission line for external noise interference.

Remote controller check results screen

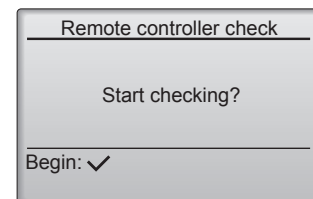

If the  button is pressed after the remote controller check results are displayed, remote controller check will end, and the remote controller will automatically reboot itself.

Check the remote controller display and see if anything is displayed (including lines). Nothing will appear on the remote controller display if the correct voltage (8.5 – 12 VDC) is not supplied to the remote controller. If this is the case, check the remote controller wiring and indoor units.

9-3-3. Self-diagnosis <PAR-21MAA>

When a problem occurs to the air conditioner, the indoor and outdoor units will stop, and the problem is shown in the remote controller display.

[CHECK] and the refrigerant address are displayed on the temperature display, and the check code and unit number are displayed alternately as shown below.

1. (If the outdoor unit is malfunctioning, the unit number will be "00".)
2. In the case of group control, for which one remote controller controls multiple refrigerant systems, the refrigerant address and check code of the unit that first experienced trouble (i.e., the unit that transmitted the check code) will be displayed.
3. To clear the check code, press the **ON/OFF** button.

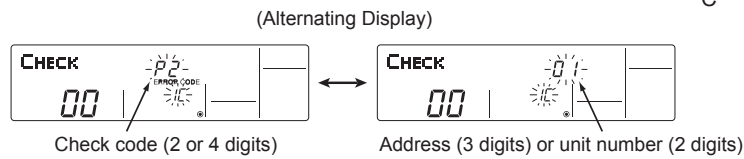
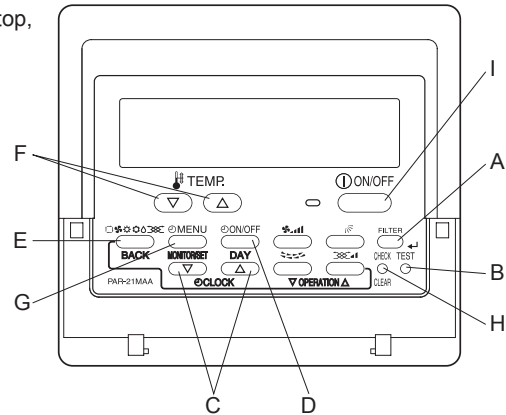

When using remote-/local-controller combined operation, cancel the check code after turning off remote operation.
 During central control by a MELANS controller, cancel the check code by pressing the **ON/OFF** button.

9-3-4. Self-Diagnosis During Maintenance or Service <PAR-21MAA>

Since each unit has a function that stores check codes, the latest check code can be recalled even if it is cancelled by the remote controller or power is turned off.

Check the error history for each unit using the remote controller.

1. Switch to self-diagnosis mode.

Press the **CHECK** button (H in the picture above) twice within 3 seconds.
 The display content will change as shown below.

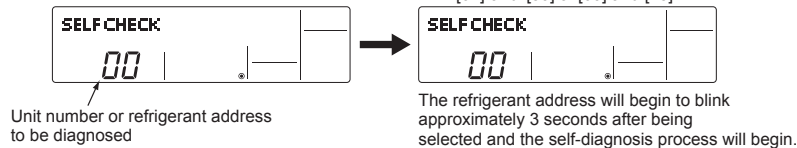

3. Display self-diagnosis results.

<When there is error history>

(For the definition of each check code, refer to the indoor unit's installation manual or service handbook.)

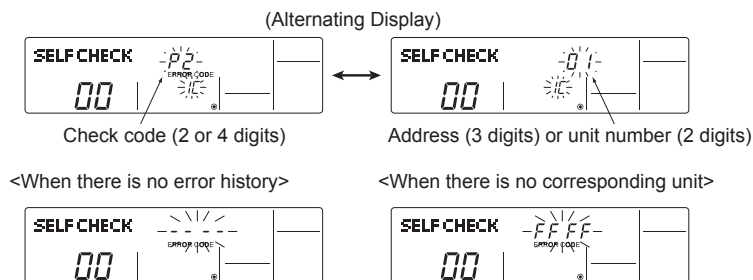

4. Reset the error history.

Display the error history in the diagnosis result display screen (see step 3).



Press the **ON/OFF** button (D in the picture in the previous page) twice within 3 seconds. The self-diagnosis address or refrigerant address will blink.

When the error history is reset, the display will look like the one shown below. However, if you fail to reset the error history, the error content will be displayed again.

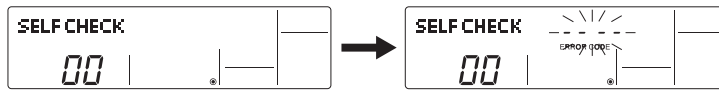

5. Cancel self-diagnosis.

Self-diagnosis can be cancelled by the following 2 methods.

Press the **CHECK** button (H in the picture in the previous page.) → Self-diagnosis will be cancelled and the screen will return to the previous state in effect before the start of self-diagnosis.

Press the **ON/OFF** button (D in the picture in the previous page.) → Self-diagnosis will be cancelled and the indoor unit will stop.

9-3-5. Remote controller check <PAR-21MAA>

If the air conditioner cannot be operated from the remote controller, diagnose the remote controller as explained below.

1. First, check that the power-on indicator is lit.
If the correct voltage (DC12 V) is not supplied to the remote controller, the indicator will not light.
If this occurs, check the remote controller's wiring and the indoor unit.

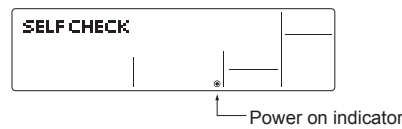

2. Switch to the remote controller self-diagnosis mode.

Press the **CHECK** button (H in the picture in the previous page) for 5 seconds or more. The display content will change as shown below.

Press the **FILTER** button (A in the picture in the previous page) to start self-diagnosis.

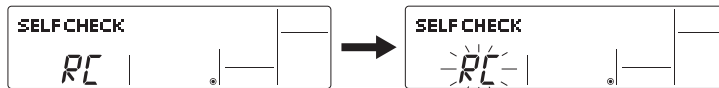

3. Remote controller self-diagnosis result

[When the remote controller is functioning correctly]



Check for other possible causes, as there is no problem with the remote controller.

[When the remote controller malfunctions]

(Error display 1) "NG" blinks. → The remote controller's transmitting-receiving circuit is defective.

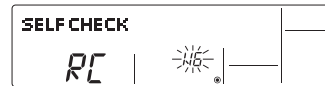

The remote controller must be replaced with a new one.

[Where the remote controller is not defective, but cannot be operated.]
(Error display 2) [E3], [6833] or [6832] blinks. → Transmission is not possible.



There might be noise or interference on the transmission path, or the indoor unit or other remote controllers are defective. Check the transmission path and other controllers.

(Error display 3) "ERC" and the number of data errors are displayed.
→ Data error has occurred.

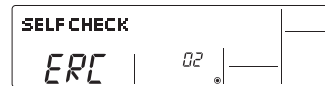

The number of data errors is the difference between the number of bits sent from the remote controller and the number actually transmitted through the transmission path. If such a problem is occurring, the transmitted data is affected by noise, etc. Check the transmission path.

☞ When the number of data errors is "02":
Transmission data from remote controller
Transmission data on transmission path

4. To cancel remote controller diagnosis

Press the **CHECK** button (H in the picture in the previous page) for 5 seconds or more. Remote controller diagnosis will be cancelled, "PLEASE WAIT" and operation lamp will blink. After approximately 30 seconds, the state in effect before the diagnosis will be restored.

9-3-6. Self-diagnosis <Wireless remote controller>



<In case of trouble during operation>

When a malfunction occurs to air conditioner, both indoor unit and outdoor unit will stop and operation lamp blinks to inform unusual stop.

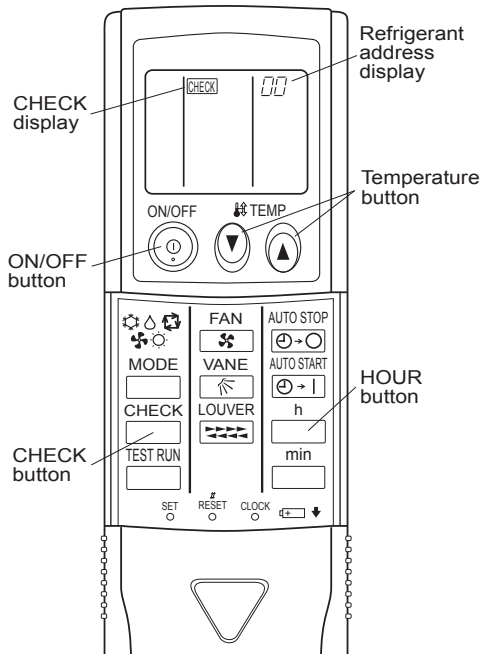
<Malfunction-diagnosis method at maintenance service>



[Procedure]

1. Press the CHECK button twice.
 - "CHECK" lights, and refrigerant address "00" blinks.
 - Check that the remote controller's display has stopped before continuing.
2. Press the TEMP   buttons.
 - Select the refrigerant address of the indoor unit for the self-diagnosis.
Note: Set refrigerant address using the outdoor unit's DIP switch (SW1). (For more information, see the outdoor unit installation manual.)
3. Point the remote controller at the sensor on the indoor unit and press the HOUR button.
 - If an air conditioner error occurs, the indoor unit's sensor emits an intermittent buzzer sound, the operation light blinks, and the check code is output.
(It takes 3 seconds at most for check code to appear.)
4. Point the remote controller at the sensor on the indoor unit and press the ON/OFF button.
 - The check mode is cancelled.

• Refer to the following tables for details on the check codes.

[Output pattern A]

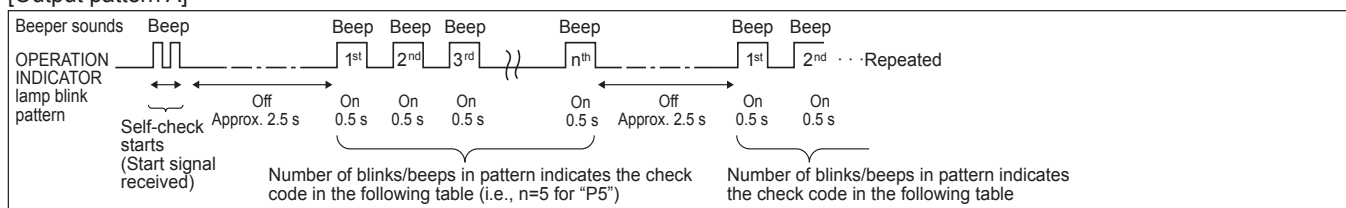

[Output pattern B]

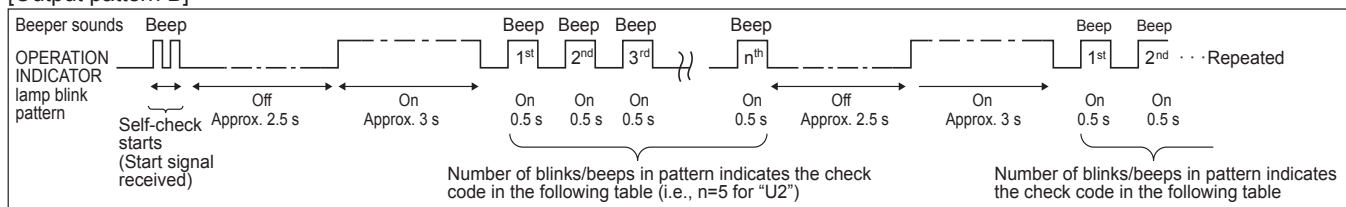

[Output pattern A] Errors detected by indoor unit

Wireless remote controller	Wired remote controller	Symptom	Remarks
Beeper sounds/OPERATION INDICATOR lamp blinks (Number of times)	Check code		
1	P1	Intake sensor error	As for indoor unit, refer to indoor unit's service manual.
2	P2	Pipe (TH2) sensor error	
	P9	Pipe (TH5) sensor error	
3	E6,E7	Indoor/outdoor unit communication error	
4	P4	Drain sensor error/Float switch connector (CN4F) open	
5	P5	Drain pump error	
	PA	Forced compressor stop(due to water leakage abnormality)	
6	P6	Freezing/Overheating protection operation	
7	EE	Combination error between indoor and outdoor units	
8	P8	Pipe temperature error	
9	E4, E5	Remote controller signal receiving error	
10	-	-	
11	Pb	Indoor unit fan motor error	
12	Fb (FB)*	Indoor unit control system error (memory error, etc.)	
14	PL	Abnormality of refrigerant circuit	
-	E0, E3	Remote controller transmission error	
-	E1, E2	Remote controller control board error	

[Output pattern B] Errors detected by unit other than indoor unit (outdoor unit, etc.)

Wireless remote controller	Wired remote controller	Symptom
Beeper sounds/OPERATION INDICATOR lamp blinks (Number of times)	Check code	
1	E9	Indoor/outdoor unit communication error (Transmitting error) (Outdoor unit)
2	UP	Compressor overcurrent interruption
3	U3,U4	Open/short of outdoor unit thermistors
4	UF	Compressor overcurrent interruption (When compressor locked)
5	U2	Abnormal high discharging temperature/49C operated/insufficient refrigerant
6	U1,Ud (UD)*	Abnormal high pressure (63H operated)/Overheating protection operation
7	U5	Abnormal temperature of heat sink
8	U8	Outdoor unit fan protection stop
9	U6	Compressor overcurrent interruption/Abnormal of power module
10	U7	Abnormality of superheat due to low discharge temperature
11	U9,UH	Abnormality such as overvoltage or undervoltage and abnormal synchronous signal to main circuit/Current sensor error
12	-	-
13	-	-
14	Others	Other errors (Refer to the technical manual for the outdoor unit.)

Notes:

1. If the beeper does not sound again after the initial 2 beeps to confirm the self-check start signal was received and the OPERATION INDICATOR lamp does not come on, there are no error records.
2. If the beeper sounds 3 times continuously "beep, beep, beep (0.4 + 0.4 + 0.4 seconds)" after the initial 2 beeps to confirm the self-check start signal was received, the specified refrigerant address is incorrect.

* The check code in the parenthesis indicates PAR-3xMAA ("x" represents 0 or later) model.

9-4. SELF-DIAGNOSIS ACTION TABLE

<Abnormalities detected when the power is ON>

Checkcode	Abnormal points and detection method	Case	Judgment and action
None	—	<p>① No voltage is supplied to terminal block (TB1) of outdoor unit. a) Power supply breaker is turned off. b) Contact failure or disconnection of power supply terminal c) Open phase (L, L2 or N phase)</p> <p>② Electric power is not supplied to power supply terminal of outdoor power circuit board. a) Contact failure of power supply terminal b) Open phase on the outdoor power circuit board (Disconnection of terminal on outdoor power circuit board)</p> <p>③ Electric power is not supplied to outdoor controller circuit board. a) Disconnection of connector (CNDC)</p> <p>④ Disconnection of reactor (DCL or ACL)</p> <p>⑤ Disconnection of outdoor power circuit board (PUZ-M·VKA)/outdoor noise filter circuit board (PUZ-M·YKA) or parts failure in outdoor power circuit board (PUZ-M·VKA)/outdoor noise filter circuit board (PUZ-M·YKA)</p> <p>⑥ Defective outdoor power circuit board</p> <p>⑦ Open of rush current protect resistor (RS) (PUZ-M·YKA)</p> <p>⑧ Defective outdoor controller circuit board</p>	<p>① Check following items. a) Power supply breaker b) Connection of power supply terminal block. (TB1) c) Connection of power supply terminal block. (TB1)</p> <p>② Check following items. a) Connection of power supply terminal block. (TB1) b) Connection of terminal on outdoor power circuit board.</p> <p>③ Check connection of the connector (CNDC) on the outdoor controller circuit board. Refer to "9-9. TEST POINT DIAGRAM".</p> <p>④ Check connection of reactor. (DCL or ACL) Refer to "6. WIRING DIAGRAM".</p> <p>⑤ a) Check connection of outdoor power circuit board (PUZ-M·VKA)/outdoor noise filter circuit board (PUZ-M·YKA). b) Replace outdoor power circuit board (PUZ-M·VKA)/outdoor noise filter circuit board (PUZ-M·YKA). Refer to "9-9. TEST POINT DIAGRAM".</p> <p>⑥ Replace outdoor power circuit board.</p> <p>⑦ Replace rush current protect resistor (RS) * Power circuit board might be short-circuit. Check the power circuit board. (Refer to "9-9. TEST POINT DIAGRAM")</p> <p>⑧ Replace controller board (When items above are checked but the units cannot be repaired.)</p>
F5 (5201)	<p>63H connector open Abnormal if 63H connector circuit is open for 3 minutes continuously after power supply. 63H: High pressure switch</p>	<p>① Disconnection or contact failure of 63H connector on outdoor controller circuit board</p> <p>② Disconnection or contact failure of 63H</p> <p>③ 63H is working due to defective parts.</p> <p>④ Defective outdoor controller circuit board</p>	<p>① Check connection of 63H connector on outdoor controller circuit board. Refer to "9-9. TEST POINT DIAGRAM".</p> <p>② Check the 63H side of connecting wire.</p> <p>③ Check continuity by tester. Replace the parts if the parts are defective.</p> <p>④ Replace outdoor controller circuit board.</p>

Note: Refer to indoor unit section for code P and code E.



Check code	Abnormal points and detection method	Case	Judgment and action
EA (6844)	<p>Miswiring of indoor/outdoor unit connecting wire</p> <p>1. Outdoor controller circuit board can automatically check the number of connected indoor units. Abnormal if the number cannot be checked automatically due to miswiring of indoor/outdoor unit connecting wire and etc. after power is turned on for 4 minutes.</p> <p>2. Abnormal if outdoor controller circuit board recognizes excessive number of indoor units.</p>	<p>① Contact failure or miswiring of indoor/outdoor unit connecting wire</p> <p>② Diameter or length of indoor/outdoor unit connecting wire is out of specified capacity.</p> <p>③ Excessive number of indoor units are connected to 1 outdoor unit. (4 units or more)</p> <p>④ Defective transmitting receiving circuit of outdoor controller circuit board</p> <p>⑤ Defective transmitting receiving circuit of indoor controller board</p> <p>⑥ Defective indoor power board</p> <p>⑦ 2 or more outdoor units have refrigerant address "0" . (In case of group control)</p> <p>⑧ Noise has entered into power supply or indoor / outdoor unit connecting wire.</p>	<p>① Check disconnection or looseness or polarity of indoor/outdoor unit connecting wire of indoor and outdoor units.</p> <p>② Check diameter and length of indoor/outdoor unit connecting wire. Total wiring length: 80 m (including wiring connecting each indoor unit and between indoor and outdoor unit) Also check if the connection order of flat cable is S1, S2, S3.</p> <p>③ Check the number of indoor units that are connected to one outdoor unit. (If EA is detected)</p> <p>④-⑥ Turn the power off once, and on again to check. Replace outdoor controller circuit board, indoor controller board or indoor power board if abnormality occurs again.</p> <p>⑦ Check if refrigerant addresses (SW1-3 to SW1-6 on outdoor controller circuit board) are overlapping in case of group control system.</p>
Eb (6845)	<p>Miswiring of indoor/outdoor unit connecting wire (reverse wiring or disconnection)</p> <p>Outdoor controller circuit board can automatically set the unit number of indoor units. Abnormal if the indoor unit number cannot be set within 4 minutes after power on because of Miswiring (reverse wiring or disconnection) of indoor/outdoor unit connecting wire.</p>	<p>① Contact failure or miswiring of indoor/outdoor unit connecting wire</p> <p>② Diameter or length of indoor/outdoor unit connecting wire is out of specified capacity.</p> <p>④ Defective transmitting receiving circuit of outdoor controller circuit board</p> <p>⑤ Defective transmitting receiving circuit of indoor controller board</p> <p>⑥ Defective indoor power board</p> <p>⑦ 2 or more outdoor units have refrigerant address "0" . (In case of group control)</p> <p>⑧ Noise has entered into power supply or indoor/outdoor unit connecting wire.</p>	<p>⑧ Check transmission path, and remove the cause.</p> <p>The descriptions above, ①-⑧, are common for EA, Eb and EC.</p>
EC (6846)	<p>Startup time over</p> <p>The unit cannot finish startup process within 4 minutes after power on.</p>	<p>① Contact failure of indoor/outdoor unit connecting wire</p> <p>② Diameter or length of indoor/outdoor unit connecting wire is out of specified capacity.</p> <p>⑦ 2 or more outdoor units have refrigerant address "0" . (In case of group control)</p> <p>⑧ Noise has entered into power supply or indoor/outdoor unit connecting wire.</p>	

<Abnormalities detected while unit is operating>

Check code	Abnormal points and detection method	Case	Judgment and action
U1 (1302)	High pressure (High pressure switch 63H operated) Abnormal if high pressure switch 63H (4.15MPa) operated during compressor operation.	<ul style="list-style-type: none"> ① Short cycle of indoor unit ② Clogged filter of indoor unit ③ Decreased airflow caused by dirt of indoor fan ④ Dirt of indoor heat exchanger ⑤ Locked indoor fan motor ⑥ Malfunction of indoor fan motor ⑦ Defective operation of stop valve (Not full open) ⑧ Clogged or broken pipe ⑨ Locked outdoor fan motor ⑩ Malfunction of outdoor fan motor ⑪ Short cycle of outdoor unit ⑫ Dirt of outdoor heat exchanger ⑬ Decreased airflow caused by defective inspection of outside temperature thermistor (It detects lower temperature than actual temperature.) ⑭ Disconnection or contact failure of connector (63H) on outdoor controller board ⑮ Disconnection or contact failure of 63H connection ⑯ Defective outdoor controller board ⑰ Defective action of linear expansion valve ⑱ Malfunction of fan driving circuit 	<ul style="list-style-type: none"> ①-⑥ Check indoor unit and repair defect. ⑦ Check if stop valve is fully open. ⑧ Check piping and repair defect. ⑨-⑫ Check outdoor unit and repair defect. ⑬ Check the detected temperature of outside temperature thermistor on LED display. (SW2 on A-Control Service Tool : Refer to "9-10. FUNCTION OF SWITCHES, CONNECTORS AND JUMPERS".) ⑭-⑯ Turn the power off and check F5 is displayed when the power is turned again. When F5 is displayed, refer to "Judgment and action" for F5. ⑰ Check linear expansion valve. Refer to "9-6. HOW TO CHECK THE PARTS". ⑱ Replace outdoor controller board.
U2 (TH4: 1102) (TH33: 1132)	<p>High discharging temperature High comp. surface temperature</p> <p>1. Abnormal if discharge thermistor (TH4) exceeds 115°C or 110°C continuously for 5 minutes. Abnormal if condenser/evaporator temperature thermistor (TH5) exceeds 40°C during defrosting and discharge thermistor (TH4) exceeds 110°C.</p> <p>2. Abnormal if discharge superheat (TH4 - TH5) increases. All the conditions are detected simultaneously for 10 minutes continuously after 6 minutes past from compressor startup (including the thermostat indication or recovery from defrosting).</p> <ul style="list-style-type: none"> • During compressor operation (in Cooling only) • When discharge superheat is less than 80°C in Cooling. • When condensing temp of TH6 is more than -40°C. (In Cooling only.) <p>3. Abnormal if comp. surface temperature thermistor (TH33) exceeds 115°C or 110°C continuously for 5 minutes.</p>	<ul style="list-style-type: none"> ① Overheated compressor operation caused by shortage of refrigerant ② Defective operation of stop valve ③ Defective thermistor ④ Defective outdoor controller board ⑤ Defective action of linear expansion valve 	<ul style="list-style-type: none"> ① Check intake superheat. Check leakage of refrigerant. Charge additional refrigerant. ② Check if stop valve is fully open. ③④ Turn the power off and check if U3 is displayed when the power is on again. When U3 is displayed, refer to "Judgement and action" for U3. ⑤ Check linear expansion valve. Refer to "9-6. HOW TO CHECK THE PARTS".
U3 (TH4: 5104) (TH33: 5132)	<p>Open/short circuit of discharge thermistor (TH4) / comp. surface thermistor (TH33)</p> <p>Abnormal if open (TH4: -20°C or less, TH33: -20°C or less) or short (217°C or more) is detected during compressor operation. (Detection is inoperative for 10 minutes of compressor starting process.)</p>	<ul style="list-style-type: none"> ① Disconnection or contact failure of connector (TH4/TH33) on the outdoor controller circuit board ② Defective thermistor ③ Defective outdoor controller circuit board 	<ul style="list-style-type: none"> ① Check connection of connector (TH4/TH33) on the outdoor controller circuit board. Check breaking of the lead wire for thermistor (TH4/TH33). Refer to "9-9. TEST POINT DIAGRAM". ② Check resistance value of thermistor (TH4/TH33) or temperature by microprocessor. (Thermistor/TH4/TH33: Refer to "9-6. HOW TO CHECK THE PARTS".) (SW2 on A-Control Service Tool: Refer to "9-10. FUNCTION OF SWITCHES, CONNECTORS AND JUMPERS".) ③ Replace outdoor controller board.



Check code	Abnormal points and detection method	Case	Judgment and action																								
U4 (TH3: 5105) (TH6: 5107) (TH7: 5106) (TH8: 5110)	Open/short of outdoor unit thermistors (TH3, TH6, TH7, and TH8) Abnormal if open or short is detected during compressor operation. Open detection of thermistor TH3 and TH6 is inoperative for 10 seconds to 10 minutes after compressor started. Note: Check which unit has abnormality in its thermistor by switching the mode of SW2. (PAC-SK52ST) (Refer to "9-10. FUNCTION OF SWITCHES, CONNECTORS AND JUMPERS".)	① Disconnection or contact failure of connectors (Outdoor controller circuit board: TH3, TH6/TH7 Outdoor power circuit board: CN6) ② Defective thermistor ③ Defective outdoor controller circuit board	① Check connection of connector (TH3, TH6/TH7) on the outdoor controller circuit board. Check connection of connector (CN6) on the outdoor power circuit board. Check breaking of the lead wire for thermistor TH3, TH6, TH7, and TH8). Refer to "9-9. TEST POINT DIAGRAM". ② Check resistance value of thermistor (TH3, TH6, TH7, and TH8) or check temperature by microprocessor. (Thermistor/TH3, TH6, TH7, and TH8: Refer to "9-6. HOW TO CHECK THE PARTS".) (SW2 on A-Control Service Tool: Refer to "9-10. FUNCTION OF SWITCHES, CONNECTORS AND JUMPERS") ③ Replace outdoor controller circuit board. Note:Emergency operation is available in case of abnormalities of TH3, TH6 and TH7. Refer to "9-8. EMERGENCY OPERATION".																								
<table border="1"> <thead> <tr> <th colspan="2">Thermistors</th> <th>Open detection</th> <th>Short detection</th> </tr> <tr> <th>Symbol</th> <th>Name</th> <td></td> <td></td> </tr> </thead> <tbody> <tr> <td>TH3</td> <td>Thermistor <Liquid></td> <td>-48 °C or below</td> <td>90 °C or above</td> </tr> <tr> <td>TH6</td> <td>Thermistor <2-phase pipe></td> <td>-48 °C or below</td> <td>90 °C or above</td> </tr> <tr> <td>TH7</td> <td>Thermistor <Ambient></td> <td>-48 °C or below</td> <td>90 °C or above</td> </tr> <tr> <td>TH8</td> <td>Thermistor <Heatsink></td> <td>-27 °C or below</td> <td>102 °C or above</td> </tr> </tbody> </table>				Thermistors		Open detection	Short detection	Symbol	Name			TH3	Thermistor <Liquid>	-48 °C or below	90 °C or above	TH6	Thermistor <2-phase pipe>	-48 °C or below	90 °C or above	TH7	Thermistor <Ambient>	-48 °C or below	90 °C or above	TH8	Thermistor <Heatsink>	-27 °C or below	102 °C or above
Thermistors		Open detection	Short detection																								
Symbol	Name																										
TH3	Thermistor <Liquid>	-48 °C or below	90 °C or above																								
TH6	Thermistor <2-phase pipe>	-48 °C or below	90 °C or above																								
TH7	Thermistor <Ambient>	-48 °C or below	90 °C or above																								
TH8	Thermistor <Heatsink>	-27 °C or below	102 °C or above																								
U5 (4230)	Temperature of heatsink Abnormal if heatsink thermistor (TH8) detects temperature indicated below. PUZ-M100VKA 71 °C PUZ-M125/140VKA 74 °C PUZ-M-YKA 77 °C	① The outdoor fan motor is locked. ② Failure of outdoor fan motor ③ Airflow path is clogged. ④ Rise of ambient temperature ⑤ Defective thermistor ⑥ Defective input circuit of outdoor power circuit board ⑦ Failure of outdoor fan drive circuit	①② Check outdoor fan. ③ Check airflow path for cooling. ④ Check if there is something which causes temperature rise around outdoor unit. (Upper limit of ambient temperature is 46°C.) Turn off power, and on again to check if U5 is displayed within 30 minutes. If U4 is displayed instead of U5, follow the action to be taken for U4. ⑤ Check resistance value of thermistor (TH8) or temperature by microcomputer. (Thermistor/TH8: Refer to "9-6. HOW TO CHECK THE PARTS".) (SW2 on A-Control Service Tool: Refer to "9-10. FUNCTION OF SWITCHES, CONNECTORS AND JUMPERS".) ⑥ Replace outdoor power circuit board. ⑦ Replace outdoor controller circuit board.																								
U6 (4250)	Power module Check abnormality by driving power module in case overcurrent is detected. (UF or UP error condition)	① Outdoor stop valve is closed. ② Decrease of power supply voltage ③ Looseness, disconnection or reverse of compressor wiring connection ④ Defective compressor ⑤ Defective outdoor power circuit board	① Open stop valve. ② Check facility of power supply. ③ Correct the wiring (U-V-W phase) to compressor. Refer to "9-9. TEST POINT DIAGRAM (Outdoor power circuit board)". ④ Check compressor referring to "9-6. HOW TO CHECK THE PARTS". ⑤ Replace outdoor power circuit board.																								
U7 (1520)	Too low superheat due to low discharge temperature Abnormal if discharge superheat is continuously detected less than or equal to -15°C for 3 minutes even though linear expansion valve has minimum open pulse after compressor starts operating for 10 minutes.	① Disconnection or loose connection of Discharge thermistor (TH4) ② Defective holder of Discharge thermistor ③ Disconnection or loose connection of linear expansion valve's coil ④ Disconnection or loose connection of linear expansion valve's connector ⑤ Defective linear expansion valve	①② Check the installation conditions of discharge thermistor (TH4). ③ Check the coil of linear expansion valve. Refer to "9-7.HOW TO CHECK THE COMPONENT". ④ Check the connection or contact of LEV-A and LEV-B on outdoor controller circuit board. ⑤ Check linear expansion valve. Refer to "9-6. HOW TO CHECK THE PARTS"																								
U8 (4400)	Outdoor fan motor Abnormal if rotational frequency of the fan motor is not detected during DC fan motor operation. Fan motor rotational frequency is abnormal if; <ul style="list-style-type: none"> • 100 rpm or below detected continuously for 15 seconds at 20°C or more outside air temperature. • 50 rpm or below or 1500 rpm or more detected continuously for 1 minute. 	① Failure in the operation of the DC fan motor ② Failure in the outdoor circuit controller board	① Check or replace the DC fan motor. ② Check the voltage of the outdoor circuit controller board during operation. ③ Replace the outdoor circuit controller board. (when the failure is still indicated even after performing the action ① above.)																								



Check code	Abnormal point and detection method	Case	Judgment and action	
U9 (4220)	Detailed codes	To find out the detail history (latest) about U9 error, turn ON SW2-1, 2-2 and 2-6. Refer to "9-10. FUNCTION OF SWITCHES, CONNECTORS AND JUMPERS".		
	01	Overvoltage error • Increase in DC bus voltage to PUZ-M·VKA: 430 V PUZ-M·YKA: 760 V	① Abnormal increase in power source voltage ② Disconnection of compressor wiring ③ Defective outdoor power circuit board ④ Compressor has a ground fault.	① Check the field facility for the power supply. ② Correct the wiring (U·V·W phase) to compressor. Refer to "9-9. TEST POINT DIAGRAM (Outdoor power circuit board)". ③ Replace outdoor power circuit board. ④ Check compressor for electrical insulation. Replace compressor.
	02	Undervoltage error • Instantaneous decrease in DC bus voltage to PUZ-M·VKA: 200 V PUZ-M·YKA: 350 V	① Decrease in power source voltage, instantaneous stop. ② Defective converter drive circuit in outdoor power circuit board (PUZ-M·VKA) ③ Defective 52C drive circuit in outdoor power circuit board ④ Disconnection or loose connection of rush current protect resistor RS (PUZ-M·YKA) ⑤ Defective rush current protect resistor RS (PUZ-M·YKA) ⑥ Disconnection or loose connection of CN2 on the outdoor power circuit board /controller circuit board (PUZ-M·VKA) ⑦ Power circuit failure on DC supply for 15 V DC output on outdoor controller circuit board (PUZ-M·VKA)	① Check the field facility for the power supply. ② Replace outdoor power circuit board. (PUZ-M·VKA) ③ Replace outdoor power circuit board. ④ Check RS wiring. (PUZ-M·YKA) ⑤ Replace RS. (PUZ-M·YKA) ⑥ Check CN2 wiring. (PUZ-M·VKA) ⑦ Replace outdoor controller circuit board. (PUZ-M·VKA)
	04	Input current sensor error/ L1-phase open error • Decrease in input current through outdoor unit to 0.1 A only if operation frequency is more than or equal to 40 Hz or compressor current is more than or equal to 6 A.	① L1-phase open (PUZ-M·YKA) ② Disconnection or loose connection between TB1 and outdoor noise filter circuit board (PUZ-M·YKA) ③ Disconnection or loose connection of CN5 on the outdoor power circuit board/CNCT on the outdoor noise filter board (PUZ-M·YKA) ④ Defective ACCT (AC current trans) on the outdoor noise filter circuit board (PUZ-M·YKA) ⑤ Defective input current detection circuit in outdoor power circuit board ⑥ Defective outdoor controller circuit board	① Check the field facility for the power supply. (PUZ-M·YKA) ② Check the wiring between TB1 and outdoor noise filter circuit board. (PUZ-M·YKA) ③ Check CN5/CNCT wiring. (PUZ-M·YKA) ④ Replace outdoor noise filter circuit board. (PUZ-M·YKA) ⑤ Replace outdoor power circuit board. ⑥ Replace outdoor controller circuit board.
08	Abnormal power synchronous signal • No input of power synchronous signal to power circuit board • Power synchronous signal of 44 Hz or less, or 65 Hz or more is detected on power circuit board.	① Distortion of power source voltage, noise superimposition. ② Disconnection or loose connection of earth wiring ③ Disconnection or loose connection of CN2 on the outdoor power circuit board /controller circuit board ④ Defective power synchronous signal circuit in outdoor controller circuit board ⑤ Defective power synchronous signal circuit in outdoor power circuit board	① Check the field facility for the power supply. ② Check earth wiring. ③ Check CN2 wiring. ④ Replace outdoor controller circuit board. ⑤ Replace outdoor power circuit board.	

Continue to the next page.

From the previous page.

Check code	Abnormal point and detection method	Case	Judgment and action
U9 (4220)	Detailed codes	<ul style="list-style-type: none"> ① Abnormal increase in power source voltage ② Decrease in power source voltage, instantaneous stop. ③ Disconnection of compressor wiring ④ Misconnection of reactor (DCL) ⑤ Defective outdoor power circuit board ⑥ Defective Reactor(DCL) ⑦ Disconnection or loose connection of CN2 on the outdoor power circuit board/ controller circuit board 	<ul style="list-style-type: none"> ①② Check the field facility for the power supply. ③ Correct the wiring (U.V.W phase) to compressor. Refer to "9-9. TEST POINT DIAGRAM". ④ Correct the wiring of reactor (DCL) ⑤ Replace outdoor power circuit board. ⑥ Replace Reactor (DCL). ⑦ Check CN2 wiring.
	10		
Ud (UD)* (1504)	<p>Over heat protection</p> <p>Abnormal if outdoor pipe thermistor (TH3) detects 70°C or more during compressor operation.</p>	<ul style="list-style-type: none"> ① Defective outdoor fan (fan motor) or short cycle of outdoor unit during cooling operation ② Defective outdoor pipe thermistor (TH3) ③ Defective outdoor controller board 	<ul style="list-style-type: none"> ① Check outdoor unit air passage. ②③ Turn the power off and on again to check the check code. If U4 is displayed, follow the U4 processing direction. <p>*The check code in the parenthesis indicates PAR-3xMAA ("x" represents 0 or later) model.</p>
UF (4100)	<p>Compressor overcurrent interruption (When compressor locked)</p> <p>Abnormal if overcurrent of DC bus or compressor is detected within 30 seconds after compressor starts operating.</p>	<ul style="list-style-type: none"> ① Stop valve is closed. ② Decrease of power supply voltage ③ Looseness, disconnection or reverse of compressor wiring connection ④ Defective compressor ⑤ Defective outdoor power board ⑥ Dip switch setting difference of outdoor controller circuit board. 	<ul style="list-style-type: none"> ① Open stop valve. ② Check facility of power supply. ③ Correct the wiring (U-V-W phase) to compressor. Refer to "9-9. TEST POINT DIAGRAM (Outdoor power circuit board)". ④ Check compressor. Refer to "9-6. HOW TO CHECK THE PARTS". ⑤ Replace outdoor power circuit board. ⑥ Check the DIP switch setting of outdoor controller circuit board. Refer to "Model Select" section at (1) Function of switches" in "9-10. FUNCTION OF SWITCHES, CONNECTORS AND JUMPERS".
UH (5300)	<p>Current sensor error</p> <ul style="list-style-type: none"> • Abnormal if 38 A of incurrent is detected or 34A or more of input current is detected for 10seconds continuously. 	<ul style="list-style-type: none"> ① Defective circuit of current sensor on outdoor power circuit board ② Decrease of power supply voltage 	<ul style="list-style-type: none"> ① Replace outdoor power circuit board. ② Check the facility of power supply.
UL (1300)	<p>Low pressure</p> <p>Abnormal if the following conditions are detected for continuously 3 minutes. Note that it applies when the compressor accumulated operating time is under 30 minutes, and 7 minutes has passed after the compressor operation.</p> <p>TH33 - TH4 \geq 20 °C and TH33 > 80 °C</p> <p>Thermistors: TH33: Comp. Surface temperature TH4: Discharge temperature TH5: Indoor 2-phase pipe temperature TH7: Ambient temperature</p>	<ul style="list-style-type: none"> ① Stop valve of outdoor unit is closed during operation. ② Leakage or shortage of refrigerant ③ Malfunction of linear expansion valve ④ Clogging with foreign objects in refrigerant circuit <p>Note: Clogging occurs in the parts which become below freezing point when water enters in refrigerant circuit.</p>	<ul style="list-style-type: none"> ① Check stop valve. ② Check intake superheat. Check leakage of refrigerant. Check additional refrigerant. ③ Check linear expansion valve. Refer to "9-6. HOW TO CHECK THE PARTS". ④ After recovering refrigerant, remove water from entire refrigerant circuit under vacuum more than 1 hour.

Check code	Abnormal points and detection method	Case	Judgment and action
UP (4210)	Compressor overcurrent interruption Abnormal if overcurrent DC bus or compressor is detected after compressor starts operating for 30 seconds.	① Stop valve of outdoor unit is closed. ② Decrease of power supply voltage ③ Looseness, disconnection or reverse of compressor wiring connection ④ Defective fan of indoor/outdoor units ⑤ Short cycle of indoor/outdoor units ⑥ Defective input circuit of outdoor controller board ⑦ Defective compressor ⑧ Defective outdoor power circuit board ⑨ Dip switch setting difference of outdoor controller circuit board	① Open stop valve. ② Check facility of power supply. ③ Correct the wiring (U-V-W phase) to compressor. Refer to "9-9. TEST POINT DIAGRAM (Outdoor power circuit board)". ④ Check indoor/outdoor fan. ⑤ Solve short cycle. ⑥ Replace outdoor controller circuit board. ⑦ Check compressor. Refer to "9-6. HOW TO CHECK THE PARTS". • Before the replacement of the outdoor controller circuit board, disconnect the wiring to compressor from the outdoor power circuit board and check the output voltage among phases, U, V, W, during test run. No defect on board if voltage among phases (U-V, V-W and W-U) is same. Make sure to perform the voltage check with same performing frequency. ⑧ Replace outdoor power circuit board ⑨ Check the dip switch setting of outdoor controller circuit board
E0 or E4	Remote controller transmission error (E0)/signal receiving error (E4) ① Abnormal if main or sub remote controller cannot receive normally any transmission from indoor unit of refrigerant address "0" for 3 minutes. (Check code : E0) ② Abnormal if sub remote controller could not receive any signal for 2 minutes. (Check code: E0) ① Abnormal if indoor controller board cannot receive normally any data from remote controller board or from other indoor controller board for 3 minutes. (Check code: E4) ② Indoor controller board cannot receive any signal from remote controller for 2 minutes. (Check code: E4)	① Contact failure at transmission wire of remote controller ② All remote controllers are set as "sub" remote controller. In this case, E0 is displayed on remote controller, and E4 is displayed at LED (LED1, LED2) on the outdoor controller circuit board. ③ Miswiring of remote controller ④ Defective transmitting receiving circuit of remote controller ⑤ Defective transmitting receiving circuit of indoor controller board of refrigerant address "0" ⑥ Noise has entered into the transmission wire of remote controller.	① Check disconnection or looseness of indoor unit or transmission wire of remote controller. ② Set one of the remote controllers "main" if there is no problem with the action above. ③ Check wiring of remote controller. • Total wiring length: Max. 500m (Do not use cable × 3 or more.) • The number of connecting indoor units: Max. 16 units • The number of connecting remote controller: Max. 2 units When it is not the above-mentioned problem of ①-③ ④ Diagnose remote controllers. a) When "RC OK" is displayed, remote controllers have no problem. Turn the power off, and on again to check. If abnormality occurs again, replace indoor controller board. b) When "RC NG" is displayed, replace remote controller. c) When "RC E3" or "ERC 00-66" is displayed, noise may be causing abnormality. Note: If the unit is not normal after replacing indoor controller board in group control, indoor controller board of address "0" may be abnormal.
E1 or E2	Remote controller control board ① Abnormal if data cannot be normally read from the nonvolatile memory of the remote controller control board. (Check code: E1) ② Abnormal if the clock function of remote controller cannot be normally operated. (Check code: E2)	① Defective remote controller	① Replace remote controller.

Check code	Abnormal points and detection method	Case	Judgment and action
E3 or E5	<p>Remote controller transmission error (E3)/signal receiving error (E5)</p> <p>① Abnormal if remote controller could not find blank of transmission path for 6 seconds and could not transmit. (Check code: E3)</p> <p>② Remote controller receives transmitted data at the same time, compares the data, and when detecting it, judges different data to be abnormal 30 continuous times. (Check code: E3)</p> <p>① Abnormal if indoor controller board could not find blank of transmission path. (Check code: E5)</p> <p>② Indoor controller board receives transmitted data at the same time, compares the data, and when detecting it, judges different data to be abnormal 30 continuous times. (Check code: E5)</p>	<p>① 2 remote controller are set as "main." (In case of 2 remote controllers)</p> <p>② Remote controller is connected with 2 indoor units or more.</p> <p>③ Repetition of refrigerant address</p> <p>④ Defective transmitting receiving circuit of remote controller</p> <p>⑤ Defective transmitting receiving circuit of indoor controller board</p> <p>⑥ Noise has entered into transmission wire of remote controller.</p>	<p>① Set a remote controller to main, and the other to sub.</p> <p>② Remote controller is connected with only one indoor unit.</p> <p>③ The address changes to a separate setting.</p> <p>④–⑥ Diagnose remote controller.</p> <p>a) When "RC OK" is displayed, remote controllers have no problem. Turn the power off, and on again to check. When becoming abnormal again, replace indoor controller board.</p> <p>b) When "RC NG" is displayed, replace remote controller.</p> <p>c) When "RC E3" or "ERC 00-66" is displayed, noise may be causing abnormality.</p>
E6 (6840)	<p>Indoor/outdoor unit communication error (Signal receiving error)</p> <p>① Abnormal if indoor controller board could not receive any signal normally for 6 minutes after turning the power on.</p> <p>② Abnormal if indoor controller board could not receive any signal normally for 3 minutes.</p> <p>③ Consider the unit as abnormal under the following condition. When 2 or more indoor units are connected to an outdoor unit, indoor controller board could not receive a signal for 3 minutes from outdoor controller circuit board, a signal which allows outdoor controller circuit board to transmit signals.</p>	<p>① Contact failure, short circuit or miswiring (reverse wiring) of indoor/outdoor unit connecting wire</p> <p>② Defective transmitting receiving circuit of outdoor controller circuit board.</p> <p>③ Defective transmitting receiving circuit of indoor controller board.</p> <p>④ Noise has entered into indoor/outdoor unit connecting wire.</p> <p>⑤ Defective fan motor</p> <p>⑥ Disconnection of 52C relay (PUZ-M·VKA)</p>	<p>Check LED display on outdoor controller circuit board. (Connect A-Control service tool (PAC-SK52ST))</p> <p>Refer to EA~EC item if LED displays EA~AC.</p> <p>① Check disconnecting or looseness of indoor/outdoor unit connecting wire of indoor unit or outdoor unit. Check all the units in case of twin/triple/quadruple indoor unit system.</p> <p>②–④ Turn the power off, and on again to check. If abnormality occurs again, replace indoor controller board or outdoor controller circuit board.</p> <p>Other indoor controller board may have defect in case of twin/triple/quadruple indoor unit system.</p> <p>⑤ Turn the power off, and detach fan motor from connector (CNF1, 2). Then turn the power on again. If abnormality is not displayed, replace fan motor. If abnormality is displayed, replace outdoor controller circuit board.</p> <p>⑥ Connect 52C relay properly to CN52C (PUZ-M·VKA)</p>
E7	<p>Indoor/outdoor unit communication error (Transmitting error)</p> <p>Abnormal if "1" receiving is detected 30 times continuously though indoor controller board has transmitted "0".</p>	<p>① Defective transmitting receiving circuit of indoor controller board</p> <p>② Noise has entered into power supply.</p> <p>③ Noise has entered into outdoor control wire.</p>	<p>①–③ Turn the power off, and on again to check. If abnormality occurs again, replace indoor controller board.</p>
E8 (6840)	<p>Indoor/outdoor unit communication error (Signal receiving error) (Outdoor unit)</p> <p>Abnormal if outdoor controller circuit board could not receive anything normally for 3 minutes.</p>	<p>① Contact failure of indoor/outdoor unit connecting wire</p> <p>② Defective communication circuit of outdoor controller circuit board</p> <p>③ Defective communication circuit of indoor controller board</p> <p>④ Noise has entered into indoor/outdoor unit connecting wire.</p>	<p>① Check disconnection or looseness of indoor/outdoor unit connecting wire of indoor or outdoor units.</p> <p>②–④ Turn the power off, and on again to check. Replace indoor controller board or outdoor controller circuit board if abnormality is displayed again.</p>

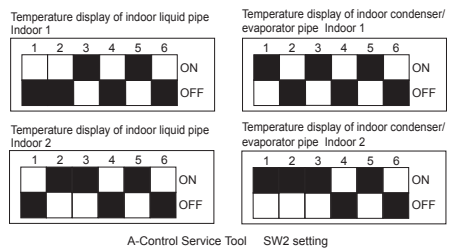
Check code	Abnormal points and detection method	Case	Judgment and action
E9 (6841)	Indoor/outdoor unit communication error (Transmitting error) (Outdoor unit) ① Abnormal if "0" receiving is detected 30 times continuously though outdoor controller circuit board has transmitted "1". ② Abnormal if outdoor controller circuit board could not find blank of transmission path for 3 minutes.	① Indoor/ outdoor unit connecting wire has contact failure. ② Defective communication circuit of outdoor controller circuit board ③ Noise has entered power supply. ④ Noise has entered indoor/ outdoor unit connecting wire.	① Check disconnection or looseness of indoor/ outdoor unit connecting wire. ②-④ Turn the power off, and on again to check. Replace outdoor controller circuit board if abnormality is displayed again.
EF (6607 or 6608)	Non defined check code This code is displayed when non defined check code is received.	① Noise has entered transmission wire of remote controller. ② Noise has entered indoor/ outdoor unit connecting wire. ③ Outdoor unit is not a series of power-inverter.	①② Turn the power off, and on again to check. Replace indoor controller board or outdoor controller circuit board if abnormality is displayed again. ③ Replace outdoor unit with power-inverter type outdoor unit.
Ed (0403)	Serial communication error ① Abnormal if serial communication between outdoor controller circuit board and outdoor power circuit board is defective.	① Breaking of wire or contact failure of connector CN2 between the outdoor controller circuit board and the outdoor power circuit board ② Breaking of wire or contact failure of connector CN4 between the outdoor controller circuit board and the outdoor power circuit board ③ Defective communication circuit of outdoor power circuit board ④ Defective communication circuit of outdoor controller circuit board for outdoor power circuit board	①② Check connection of each connector CN2 and CN4 between the outdoor controller circuit board and the outdoor power circuit board. ③ Replace outdoor power circuit board. ④ Replace outdoor controller circuit board.
	② Abnormal if communication between outdoor controller circuit board and M-NET board is not available.	① Breaking of wire or contact failure of connector between outdoor controller circuit board and M-NET board ② Contact failure of M-NET board power supply line ③ Noise has entered into M-NET transmission wire.	① Check disconnection, looseness, or breaking of connection wire between outdoor controller circuit board (CNMNT) and M-NET board (CN5). ② Check disconnection, looseness, or breaking of connection wire between outdoor controller circuit board (CNMNT) and M-NET board (CND). ③ Check M-NET transmission wiring method.
P8	Pipe temperature Detected as abnormal when the pipe temperature is not in the cooling range 3 minutes after compressor start and 6 minutes after the liquid or condenser/ evaporator pipe is out of cooling range. Note 1) It takes at least 9 minutes to detect. Note 2) Abnormality P8 is not detected in drying mode. Cooling range : Indoor pipe temperature (TH2 or TH5) – intake temperature (TH1) $\leq -3^{\circ}\text{C}$ TH: Lower temperature between liquid pipe temperature and condenser/evaporator temperature	① Slight temperature difference between indoor room temperature and pipe <liquid or condenser/evaporator> temperature thermistor • Shortage of refrigerant • Disconnected holder of pipe <liquid or condenser/ evaporator> thermistor • Defective refrigerant circuit ② Reverse connection of extension pipe (on plural units connection) ③ Reverse wiring of indoor/ outdoor unit connecting wire (on plural units connection) ④ Defective detection of indoor room temperature and pipe <condenser/evaporator> temperature thermistor ⑤ Stop valve is not opened completely.	①-④ Check pipe <liquid or condenser/ evaporator> temperature with room temperature display on remote controller and outdoor controller circuit board. Pipe <liquid or condenser / evaporator> temperature display is indicated by setting SW2 of outdoor controller circuit board as follows. (Conduct temperature check with outdoor controller circuit board after connecting 'A-Control Service Tool (PAC-SK52ST)').  A-Control Service Tool SW2 setting
			②③ Check reverse connection of extension pipe or reverse wiring of indoor/outdoor unit connecting wire.



Check code	Abnormal points and detection method	Case	Judgment and action
PL	<p>Abnormal refrigerant circuit During Cooling or Auto Cooling operation, when the following are regarded as failures when detected for one second.</p> <p>a)The compressor continues to run for 30 or more seconds.</p> <p>b)The liquid pipe temperature or the condenser/evaporator temperature is 75°C or more.</p> <p><u>These detected errors will not be cancelled until the power source is reset.</u></p>	<p>① Disconnection of or leakage in refrigerant pipes</p> <p>② Air into refrigerant piping</p> <p>③ Abnormal operation (no rotation) of indoor fan</p> <ul style="list-style-type: none"> · Defective fan motor · Defective indoor control board <p>④ Defective refrigerant circuit (clogging)</p>	<p>① Check refrigerant pipes for disconnection or leakage.</p> <p>② After the recovery of refrigerant, vacuum dry the whole refrigerant circuit.</p> <p>③ Refer to "9-6. HOW TO CHECK THE PARTS".</p> <p>④ Check refrigerant circuit for operation. <u>To avoid entry of moisture or air into refrigerant circuit which could cause abnormal high pressure, purge air in refrigerant circuit or replace refrigerant.</u></p>

<M-NET communication error>

Note: "Indoor unit" in the text indicates M-NET board in outdoor unit.

Check code	Abnormal points and detection method	Case	Judgment and action
A0 (6600)	<p>Address duplicate definition This error is displayed when transmission from the units of same address is detected.</p> <p>Note: The address and attribute displayed at remote controller indicate the controller that detected abnormality.</p>	<p>① There are 2 or more same address of controller of outdoor unit, indoor unit, FRESH MASTER, or LOSSNAY.</p> <p>② Noise has entered into transmission signal and signal was transformed.</p>	<p>Search the unit with same address as abnormality occurred. If the same address is found, shut the power supply of outdoor unit and indoor unit and FRESH MASTER or LOSSNAY at the same time for 2 minutes or more after the address is corrected, and turn the power on again.</p> <p>Check transmission waveform or noise on transmission wire.</p>
A2 (6602)	<p>Hard ware error of transmission processor Transmission processor intended to transmit "0", but "1" appeared on transmission wire.</p> <p>Note: The address and attribute display at remote controller indicate the controller that detected abnormality.</p>	<p>① Error is detected if waveform is transformed when wiring works of transmission wire of outdoor unit, indoor unit, FRESH MASTER or LOSSNAY are done, or polarity is changed with the power on and transmission data collide each other.</p> <p>② Defective transmitting receiving circuit of transmission processor</p> <p>③ Transmission data is changed by the noise on transmission.</p>	<p>① If the works of transmission wire is done with the power on, shut off the power supply of outdoor unit and indoor unit and FRESH MASTER or LOSSNAY at the same time for 2 minutes or more, and turn the power on again.</p> <p>② Check transmission waveform or noise on transmission wire.</p>
A3 (6603)	<p>BUS BUSY</p> <p>1. Overtime error by collision damage Abnormal if transmitting is not possible for 8-10 minutes continuously because of collision of transmission.</p> <p>2. Data could not reach transmission wire for 8-10 minutes continuously because of noise or etc.</p> <p>Note: The address and attribute displayed at remote controller indicate the controller that detected abnormality.</p>	<p>① Transmission processor could not transmit signal because short cycle voltage of noise and the like have entered into transmission wire continuously.</p> <p>② Transmission quantity has increased and transmission is not possible because there was wiring mistake of terminal block for transmission wire (TB3) and terminal block for central control (TB7) in outdoor unit.</p> <p>③ Transmission are mixed with others and occupation rate on transmission wire rose because of defective repeater (a function to connector or disconnect transmission of control and central control system) of outdoor unit, then abnormality is detected.</p>	<p>① Check if transmission wire of indoor unit, FRESH MASTER, LOSSNAY, or remote controller is not connected to terminal block for central control (TB7) of outdoor unit.</p> <p>② Check if transmission wire of indoor unit, FRESH MASTER or LOSSNAY is not connected to terminal block for transmission wire of outdoor unit.</p> <p>③ Check if terminal block for transmission wire (TB3) and terminal block for central control (TB7) is not connected.</p> <p>④ Check transmission waveform or noise on transmission wire.</p>
A6 (6606)	<p>Communication error with communication processor Defective communication between unit processor and transmission processor</p> <p>Note: The address and attribute display at remote controller indicate the controller that detected abnormality.</p>	<p>① Data of transmission processor or unit processor is not transmitted normally because of accidental trouble such as noise or thunder surge.</p> <p>② Address forwarding from unit processor is not transmitted normally because of defective transmission processor hardware.</p>	<p>Turn off the power supply of outdoor unit, indoor unit and FRESH MASTER or LOSSNAY at the same time for 2 minutes or more, and turn the power on again. System returns normally if abnormality was accidental malfunction. If the same abnormality occurs again, abnormality-generated controller may be defective.</p>



Check code	Abnormal points and detection method	Case	Judgment and action
<p style="text-align: center;">A7 (6607)</p>	<p>NO ACK signal</p> <p>1. Transmitting side controller detects abnormal if a message was transmitted but there is no reply (ACK) that a message was received. Transmitting side detects abnormality every 30 seconds, 6 times continuously.</p> <p>Note: The address and attribute displayed at remote controller indicate the controller that did not reply (ACK).</p>	<p>Common factor that has no relation with abnormality source</p> <p>① The unit of former address does not exist as address switch has changed while the unit was energized.</p> <p>② Extinction of transmission wire voltage and signal is caused by over-range transmission wire.</p> <ul style="list-style-type: none"> • Maximum distance.....200m • Remote controller line..(12m) <p>③ Extinction of transmission wire voltage and signal is caused by type-unmatched transmission wire.</p> <p>Type.....</p> <ul style="list-style-type: none"> With shield wire- CVVS, CPEVS With normal wire (no shield)- VCTF, VCTFK, CVV CVS, VVR, VVF, VCT <p>Diameter.....1.25mm² or more</p> <p>④ Extinction of transmission wire voltage and signal is caused by over-numbered units.</p> <p>⑤ Accidental malfunction of abnormality-detected controller (noise, thunder surge)</p> <p>⑥ Defective of abnormality-generated controller</p>	<p>Always try the following when the error "A7" occurs.</p> <p>① Turn off the power supply of outdoor unit, indoor unit and FRESH MASTER or LOSSNAY at the same time for 2 minutes or more, and turn the power on again. If malfunction was accidental, the unit returns to normal.</p> <p>② Check address switch of abnormality-generated address.</p> <p>③ Check disconnection or looseness of abnormality-generated or abnormality-detected transmission wire (terminal block and connector)</p> <p>④ Check if tolerance range of transmission wire is not exceeded.</p> <p>⑤ Check if type of transmission wire is correct or not.</p> <p>If the cause of trouble is not any of ①-⑤ above, repair the defect, then turn off the power supply of outdoor unit, indoor unit and FRESH MASTER or LOSSNAY at the same time for 2 minutes or more, and turn the power on again.</p> <ul style="list-style-type: none"> • If the cause of trouble is not any of ①-⑤ above in single refrigerant system (one outdoor unit), controller of displayed address or attribute is defective. • If the cause of trouble is not any of ①-⑤ above in different refrigerant system (2 or more outdoor units), judge with ⑥. <p>⑥ If address of abnormality source is the address that should not exist, there is the unit that memorizes nonexistent address information. Delete useless address information with manual setting function of remote controller.</p> <p>Only the system FRESH MASTER or LOSSNAY are connected to, or the system that is equipped with group setting of different refrigerant system.</p> <p>If the cause of trouble is not any of ①-⑥ above, replace the controller board of displayed address or attribute.</p> <p>If the unit does not return normally, multi-controller board of outdoor unit may be defective (repeater circuit).</p> <p>Replace multi-controller board one by one to check if the unit returns normally.</p>
	<p>2. If displayed address or attribute is outdoor unit, indoor unit detects abnormality when indoor unit transmits signal to outdoor unit and there was no reply (ACK).</p>	<p>① Contact failure of transmission wire of outdoor unit or indoor unit</p> <p>② Disconnection of transmission connector (CN2M) of outdoor unit</p> <p>③ Defective transmitting receiving circuit of outdoor unit or indoor unit</p>	
	<p>3. If displayed address or attribute is indoor unit, remote controller detects abnormality when remote controller transmits signal to indoor unit and there was no reply (ACK).</p>	<p>① During group operation with indoor unit of multi- refrigerant system, if remote controller transmits signal to indoor unit while outdoor unit power supply of one refrigerant system is turned off or within 2 minutes of restart, abnormality is detected.</p> <p>② Contact failure of transmission wire of remote controller or indoor unit</p> <p>③ Disconnection of transmission connector (CN2M) of indoor unit</p> <p>④ Defective transmitting receiving circuit of indoor unit or remote controller</p>	

Continued to the next page.

From the previous page.

Check code	Abnormal points and detection method	Case	Judgment and action
A7 (6607)	4. If displayed address or attribute is remote controller, indoor unit detects abnormality when indoor unit transmits signal to remote controller and there was no reply (ACK).	① During group operation with indoor unit of multi- refrigerant system, if indoor unit transmit signal to remote controller while outdoor unit power supply of one refrigerant system is turned off or within 2 minutes of restart, abnormality is detected. ② Contact failure of transmission wire of remote controller or indoor unit ③ Disconnection of transmission connector (CN2M) of indoor unit ④ Defective transmitting receiving circuit of indoor unit or remote controller	Same as mentioned in "A7" of the previous page.
	5. If displayed address or attribute is FRESH MASTER, indoor unit detects abnormality when indoor unit transmits signal to FRESH MASTER and there was no reply (ACK).	① During sequential operation of indoor unit and FRESH MASTER of other refrigerant system, if indoor unit transmits signal to FRESH MASTER while outdoor unit power supply of same refrigerant system with FRESH MASTER is turned off or within 2 minutes of restart, abnormality is detected. ② Contact failure of transmission wire of indoor unit or FRESH MASTER ③ Disconnection of transmission connector (CN2M) of indoor unit or FRESH MASTER ④ Defective transmitting receiving circuit of indoor unit or FRESH MASTER	
	6. If displayed address or attribute is LOSSNAY, indoor unit detects abnormality when indoor unit transmits signal to LOSSNAY and there was no reply (ACK).	① If the power supply of LOSSNAY is off, indoor unit detects abnormality when it transmits signal to LOSSNAY. ② During sequential operation of indoor unit and LOSSNAY of other refrigerant system, if indoor unit transmits signal to LOSSNAY while outdoor unit power supply of same refrigerant system with LOSSNAY is turned off or within 2 minutes of restart, abnormality is detected. ③ Contact failure of transmission wire of indoor unit of LOSSNAY ④ Disconnection of transmission connector (CN2M) of indoor unit ⑤ Defective transmitting receiving circuit of indoor unit or LOSSNAY	
	7. If displayed address or attribute is non-existent.	① The unit of former address does not exist as address switch has changed while the unit was energized. ② Abnormality is detected when indoor unit transmits signal because the address of FRESH MASTER and LOSSNAY are changed after sequential operation of FRESH MASTER and LOSSNAY by remote controller.	

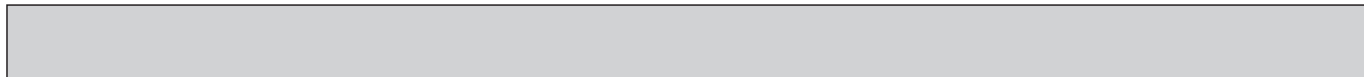

Check code	Abnormal points and detection method	Case	Judgment and action
A8 (6608)	<p>M-NET NO RESPONSE</p> <p>Abnormal if a message was transmitted and there were reply (ACK) that message was received, but response command does not return. Transmitting side detects abnormality every 30 seconds, 6 times continuously.</p> <p>Note: The address and attribute displayed at remote controller indicate the controller that did not reply (ACK).</p>	<p>① Transmitting condition is repeated fault because of noise and the like.</p> <p>② Extinction of transmission wire voltage and signal is caused by over-range transmission wire.</p> <ul style="list-style-type: none"> • Maximum distance 200m • Remote controller line (12m) <p>③ Extinction of transmission wire voltage and signal is caused by type-unmatched transmission wire.</p> <p>Type.....</p> <p>With shield wire- CVVS, CPEVS</p> <p>With normal wire (no shield)- VCTF, VCTFK, CVV CVS, VVR, VVF, VCT</p> <p>Diameter 1.25mm² or more</p> <p>④ Accidental malfunction of abnormality-generated controller</p>	<p>① Check transmission waveform or noise on transmission wire.</p> <p>② Turn off the power supply of outdoor unit and indoor unit and FRESH MASTER or LOSSNAY at the same time for 2 minutes or more, and turn the power on again. If malfunction was accidental, the unit returns to normal. If the same abnormality occurs again, controller of displayed address and attribute may be defective.</p>

9-5. TROUBLESHOOTING OF PROBLEMS

Phenomena	Factor	Countermeasure
1. Remote controller display does not work.	<p>① 12 V DC is not supplied to remote controller. (Power supply display ● is not indicated on LCD.)</p> <p>② 12–15 V DC is supplied to remote controller, however, no display is indicated.</p> <ul style="list-style-type: none"> • "PLEASE WAIT" is not displayed. • "PLEASE WAIT" is displayed. 	<p>① Check LED2 on indoor controller board.</p> <p>(1) When LED2 is lit. Check the remote controller wiring for breaking or contact failure.</p> <p>(2) When LED2 is blinking. Check short circuit of remote controller wiring.</p> <p>(3) When LED2 is not lit. Refer to phenomena No.3 below.</p> <p>② Check the following.</p> <ul style="list-style-type: none"> • Failure of remote controller if "PLEASE WAIT" is not displayed • Refer to phenomena No.2 below if "PLEASE WAIT" is displayed.
2. "PLEASE WAIT" display is remained on the remote controller.	<p>① At longest 2 minutes after the power supply "PLEASE WAIT" is displayed to startup.</p> <p>② Communication error between the remote controller and indoor unit</p> <p>③ Communication error between the indoor and outdoor unit</p> <p>④ Outdoor unit protection device connector is open.</p>	<p>① Normal operation</p> <p>② Self-diagnosis of remote controller</p> <p>③ "PLEASE WAIT" is displayed for 6 minutes at most in case of indoor/outdoor unit communication error. Check LED3 on indoor controller board.</p> <p>(1) When LED3 is not blinking. Check indoor/outdoor connecting wire for Miswiring. (Reverse wiring of S1 and S2, or break of S3 wiring.)</p> <p>(2) When LED3 is blinking. Indoor/outdoor connecting wire is normal.</p> <p>④ Check LED display on outdoor controller circuit board. Refer to "9-10. FUNCTION OF SWITCHES, CONNECTORS AND JUMPERS" Check protection device connector (63H) for contact failure. Refer to "9-9. TEST POINT DIAGRAM".</p>
3. When pressing the remote controller operation switch, the OPERATION display is appeared but it will be turned off soon.	<p>① After cancelling to select function from the remote controller, the remote controller operation switch will be not accepted for approx. 30 seconds.</p>	<p>① Normal operation</p>



Phenomena	Factor	Countermeasure
4. Even controlling by the wireless remote controller, no beep is heard and the unit does not start operating. Operation display is indicated on wireless remote controller.	① The pair number settings of the wireless remote controller and indoor controller board are mismatched.	① Check the pair number settings.
5. When operating by the wireless remote controller, beep sound is heard, however, unit does not start operating.	① No operation for 2 minutes at most after the power supply ON. ② Local remote controller operation is prohibited. <ul style="list-style-type: none"> • Remote controlling adaptor is connected to CN32 on the indoor controller board. • Local remote controller operation is prohibited by centralized controller etc. since it is connected to MELANS. ③ Phenomena of No.2.	① Normal operation ② Normal operation ③ Check the phenomena No.2.
6. Remote controller display works normally and the unit performs cooling operation, however, the capacity cannot be fully obtained. (The air does not cool well.)	① Refrigerant shortage ② Filter clogging ③ Heat exchanger clogging ④ Air duct short cycle	① • If refrigerant leaks, discharging temperature rises and LEV opening increases. Inspect leakage by checking the temperature and opening. • Check pipe connections for gas leakage. ② Open intake grille and check the filter. Clean the filter by removing dirt or dust on it. ③ • If the filter is clogged, indoor pipe temperature rises and discharging pressure increases. Check if heat exchanger is clogged by inspecting discharging pressure. • Clean the heat exchanger. ④ Remove the blockage.
7. ① For 3 minutes after temperature adjuster turns off, the compressor will not start operating even if temperature adjuster is turned on. ② For 3 minutes after temperature adjuster turns on, the compressor will not stop operating even if temperature adjuster is turned off. (Compressor stops operating immediately when turning off by the remote controller.)	①② Normal operation (For protection of compressor)	①② Normal operation

Symptoms: “PLEASE WAIT” is kept being displayed on the remote controller.





Diagnosis flow	Cause	Inspection method and troubleshooting
<pre> graph TD Start[Check the display time of "PLEASE WAIT" after turning on the main power.] --> D1{How long is "PLEASE WAIT" kept being displayed on the remote controller?} D1 -- "6 minutes or more" --> C1[Check the LED display of the outdoor controller circuit board.] D1 -- "2 to 6 minutes" --> D2{Are any check codes displayed on the remote controller?} D1 -- "2 minutes or less" --> C2["PLEASE WAIT" will be displayed during the startup diagnosis after turning on the main power.] D2 -- NO --> C2 D2 -- YES --> C1 C1 --> D3{Are any check codes displayed on the LED?} D3 -- NO --> C3["Defective indoor controller board Defective remote controller"] D3 -- YES --> C4["Miswiring of indoor/outdoor connecting wire Breaking of indoor/outdoor connecting wire (S3) Defective indoor controller board Defective outdoor controller circuit board"] </pre>	<ul style="list-style-type: none"> • “PLEASE WAIT” will be displayed during the startup diagnosis after turning on the main power. • Miswiring of indoor/outdoor connecting wire • Breaking of indoor/outdoor connecting wire (S3) • Defective indoor controller board • Defective outdoor controller circuit board • Defective indoor controller board • Defective remote controller 	<ul style="list-style-type: none"> • Normal. The startup diagnosis will be over in around 2 minutes. • Refer to “Self-diagnosis action table” in order to solve the trouble. • In case of communication errors, the display of remote controller may not match the LED display of the outdoor unit.

Symptoms: Nothing is displayed on the remote controller ①

LED display of the indoor controller board
 LED1 : ○
 LED2 : ○
 LED3 : ○





Diagnosis flow	Cause	Inspection method and troubleshooting
<p>Check the voltage between S1 and S2 on the terminal block (TB4) of the indoor unit which is used to connect the indoor unit and the outdoor unit.</p> <p>198 V AC to 264 V AC?</p> <p>NO</p> <p>Check the voltage among L(L₃) and N on the terminal block (TB1) of the outdoor power circuit board.</p> <p>198 V AC to 264 V AC?</p> <p>NO</p> <p>Check the voltage between S1 and S2 on the terminal block (TB1) of the outdoor unit which is used to connect the indoor unit and the outdoor unit.</p> <p>198 V AC to 264 V AC?</p> <p>NO</p> <p>Check the voltage of indoor controller board (CN2D).</p> <p>12 V DC to 16 V DC ?</p> <p>NO</p> <p>Check the voltage of the unit after removing the indoor power board (CN2S).</p> <p>12 V DC to 16 V DC ?</p> <p>NO</p>	<ul style="list-style-type: none"> • Troubles concerning power supply • Bad wiring of the outdoor controller board • The fuses on the outdoor controller circuit board have melted. • Bad wiring of the outdoor controller board • The fuses on the outdoor controller circuit board have melted. • Defective indoor controller board • Miswiring, breaking or poor connection of indoor/outdoor connecting wire • Defective indoor power board 	<ul style="list-style-type: none"> • Check the power wiring to the outdoor unit. • Check the breaker. • Check the wiring of the outdoor unit. • Check if the wiring is bad. Check if the fuses have melted. The fuses on the outdoor controller circuit board will have been melted when the indoor/outdoor connecting wire short-circuits. • Check if miswiring, breaking or poor contact is causing this problem. Indoor/outdoor connecting wire is polarized 3-core type. Connect the indoor unit and the outdoor unit by wiring each pair of S1, S2 and S3 on the both side of indoor/outdoor terminal blocks. • Replace the indoor controller board. • Check if there is miswiring or breaking of wire. • Replace the indoor power board.

Symptoms: Nothing is displayed on the remote controller ②

LED display of the indoor controller board
 LED1 : 
 LED2 : 
 LED3 :  or 

Diagnosis flow	Cause	Inspection method and troubleshooting
<p>Check the voltage between S1 and S2 on the terminal block (TB4) of the indoor unit which is used to connect the indoor unit and the outdoor unit.</p> <p>198 V AC to 264 V AC?</p> <p>NO → Check the looseness or disconnection of the indoor/outdoor connecting wire.</p> <p>YES → Check the status of the indoor controller board LED3 display.</p> <p>Not lighting. → Check the looseness or disconnection of the indoor/outdoor connecting wire.</p> <p>Blinking. → Check the refrigerant address of the outdoor unit. (SW1-3 to 1-6)</p> <p>Is the refrigerant address "0"?</p> <p>NO → Defective outdoor controller circuit board</p> <p>YES → Check the LED display of the outdoor unit after turning on the main power again.</p> <p>Is anything displayed?</p> <p>NO → Defective outdoor controller circuit board</p> <p>YES → Is "EA" or "Eb" displayed?</p> <p>NO → Can the unit be restarted?</p> <p>YES → Is "E8" displayed?</p> <p>NO → Can all the indoor unit be operated?</p> <p>NO → Defective indoor controller board</p> <p>YES → Check the voltage between S2 and S3 on the terminal block of the outdoor unit.</p> <p>17 V DC to 28 V DC?</p> <p>NO → Defective outdoor power circuit board</p> <p>YES → Defective indoor power board</p>	<ul style="list-style-type: none"> • Breaking or poor contact of the indoor/outdoor connecting wire • Normal. Only the unit which has the refrigerant address "0" supplies power to the remote controller. • Defective outdoor controller circuit board • Defective outdoor controller circuit board • Defective indoor controller board • Influence of electromagnetic noise • Defective outdoor power circuit board • Defective indoor power board 	<ul style="list-style-type: none"> • Fix the breaking or poor contact of the indoor/outdoor connecting wire. • Set the refrigerant address to "0". In case of the multiple grouping system, recheck the refrigerant address again. • Replace the outdoor controller circuit board. • Replace the outdoor controller circuit board. • Replace the indoor controller board of the indoor unit which does not operate. • Not abnormal. There may be the influence of electromagnetic noise. Check the transmission wire and get rid of the causes. • Replace the outdoor power circuit board. • Replace the indoor power board.

Symptoms: Nothing is displayed on the remote controller ③

LED display of the indoor controller board
 LED1 : 
 LED2 :  or 
 LED3 : 

Diagnosis flow	Cause	Inspection method and troubleshooting
<p>Check the voltage of the terminal block (TB6) of the remote controller.</p> <p>10 V DC to 16 V DC?</p> <p>YES</p> <p>NO</p> <p>Check the status of the LED2.</p> <p>Lighting</p> <p>Blinking</p> <p>Check the status of the LED2 after disconnecting the remote controller wire from the terminal block (TB5) of the indoor unit.</p> <p>Check the status of the LED2.</p> <p>Lighting</p> <p>Blinking</p>	<ul style="list-style-type: none"> Defective remote controller Breaking or poor contact of the remote controller wire The remote controller wire short-circuits Defective indoor controller board 	<ul style="list-style-type: none"> Replace the remote controller. Check if there is breaking or poor contact of the remote controller wire. Check the voltage of the terminal block (TB5) connecting the remote controller wire. If it is not between DC 10 V and 16 V DC, the indoor controller board must be defective. Check if the remote controller wire is short-circuited. Replace the indoor controller board.

• Before repair <Frequent calls from customers>

Phone Calls From Customers	How to Respond	Note	
Unit does not operate at all.	① The operating display of remote controller does not come on.	① Check if power is supplied to air conditioner. Nothing appears on the display unless power is supplied.	_____
	② Unit cannot be restarted for a while after it's stopped.	② Wait around 3 minutes to restart unit. The air conditioner is in a state of being protected by the microcomputer's directive. Once the compressor is stopped, the unit cannot be restarted for 3 minutes. This control is also applied when the unit is turned on and off by remote controller.	_____
	③ Check code appears and blinks on the display of remote controller.	③ Check code will be displayed if any protection devices of the air conditioner are actuated. What is check code? -----	Refer to "SELF-DIAGNOSIS ACTION TABLE". → Check if servicing is required for the error.
Remote controller	① "PLEASE WAIT" is displayed on the screen.	① Wait around 2 minutes. An automatic startup test will be conducted for 2 minutes when power is supplied to the air conditioner. "PLEASE WAIT" will be kept being displayed while that time.	_____
	② "FILTER" is displayed on the screen.	② This indicates that it is time to clean the air filters. Clean the air filters. Press the FILTER button on the remote controller twice to clear "FILTER" from the display. See the operation manual that came with the product for how to clean the filters.	Display time of "FILTER" depends on the model. Long life filter: 2500 hrs. Standard filter: 100 hrs.
The room cannot be cooled or sufficiently.		① Check the set temperature of remote controller. The outdoor unit cannot be operated if the set temperature is not appropriate. The outdoor unit operates in the following condition: When the set temperature is lower than the room temperature.	_____
		② Check if filters are not dirty and clogged. If filters are clogged, the airflow amount will be reduced and the unit capacity will be lowered. See the instruction manual that came with the product for how to clean the filters.	_____
		③ Check there is enough space around the air conditioner. If there are any obstacles in the air intake or air outlet of indoor/outdoor units, they block the airflow direction so that the unit capacity will be lowered.	_____
Sound comes out from the air conditioner.	① A gas escaping sound is heard sometimes.	① This is not a malfunction. This is the sound which is heard when the flow of refrigerant in the air conditioner is switched.	_____
	② A cracking sound is heard sometimes.	② This is not a malfunction. This is the sound which is heard when internal parts of units expand or contract when the temperature changes.	_____
	③ A buzzing sound is heard sometimes.	③ This is not a malfunction. This is the sound which is heard when the outdoor unit starts operating.	_____

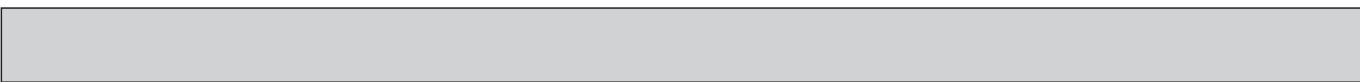

Phone Calls From Customers		How to Respond	Note
Sound comes out from the air conditioner.	④ A ticking sound is heard from the outdoor unit sometimes.	④ This is not a malfunction. This is the sound which is heard when the fan of the outdoor unit is controlling the airflow amount in order to keep the optimum operating condition.	_____
	⑤ A sound, similar to water flowing, is heard from the unit.	⑤ This is not a malfunction. This is the sound which is heard when the refrigerant is flowing inside the indoor unit.	_____
Something is wrong with the blower.....	The fan speed does not match the setting of the remote controller during DRY operation.(No air comes out sometimes during DRY operation.)	This is not a malfunction. During the DRY operation, the blower's ON/OFF is controlled by the microcomputer to prevent overcooling and to ensure efficient dehumidification. The fan speed cannot be set by the remote controller during DRY operation.	_____
Something is wrong with the airflow direction...	① The airflow direction is changed during COOL operation.	① If the up/down vane is set to downward in COOL operation, it will be automatically set to horizontal blow by the microcomputer in order to prevent water from dropping down. "1 Hr." will be displayed on the remote controller if the up/down vane is set to downward with the fan speed set to be less than "LOW".	_____
	② The airflow direction does not change. (Up/down vane, left/right louver)	② 1) Check if the vane is set to a fixed position. (Check if the vane motor connector is removed.) 2) Check if the air conditioner has a function for switching the air direction. 3) If the air conditioner does not have that function, "NOT AVAILABLE" will be displayed on the remote controller when "AIR DIRECTION" or "LOUVER" button is pressed.	_____
The air conditioner starts operating even though any buttons on the remote controller are not pressed.	① Check if you set ON/OFF timer. The air conditioner starts operating at the time designated if ON timer has been set before.	_____	
	② Check if any operations are ordered by distant control system or the central remote controller. While "CENTRALLY CONTROLLED INDICATOR" is displayed on the remote controller, the air conditioner is under the control of external directive.	There might be a case that "CENTRALLY CONTROLLED INDICATOR" will not be displayed.	
	③ Check if power is recovered from power failure (black out). The units will automatically start operating when power is recovered after power failure (black out) occurs. This function is called "auto recovery feature from power".	_____	
The air conditioner stops even though any buttons on the remote controller are not pressed.	① Check if you set ON/OFF timer. The air conditioner stops operating at the time designated if OFF timer has been set before.	There might be a case that "CENTRALLY CONTROLLED INDICATOR" will not be displayed.	
	② Check if any operations are ordered by distant control system or the central remote controller. While "CENTRALLY CONTROLLED INDICATOR" is displayed on the remote controller, the air conditioner is under the control of external directive.		

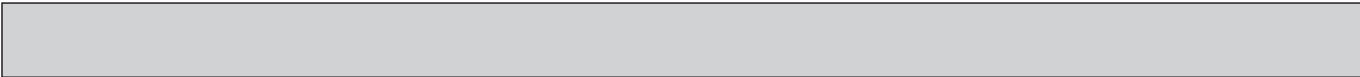

Phone Calls From Customers	How to Respond	Note
A white mist is expelled from the indoor unit.	This is not a malfunction. This may occur when the operation gets started in the room of high humidity.	_____
Water or moisture is expelled from the outdoor unit.	When pipes or piping joints are cooled, they get sweated and water drips down. Note: Make use of optional parts "Drain Socket" and "Drain pan" if these water needs to be collected and drained out for once.	_____
The display of wireless remote controller gets dim or does not come on. The indoor unit does not receive a signal from remote controller at a long distance.	Batteries are being exhausted. Replace them and press the reset button of remote controller.	_____

9-6. HOW TO CHECK THE PARTS

PUZ-M100VKA(-ET).TH PUZ-M100YKA(-ET).TH
PUZ-M125VKA(-ET).TH PUZ-M125YKA(-ET).TH
PUZ-M140VKA(-ET).TH PUZ-M140YKA(-ET).TH

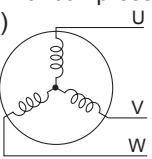
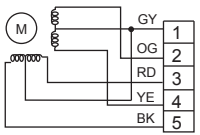
Parts name	Checkpoints														
Thermistor(TH3) <Liquid> Thermistor (TH4) <Discharge> Thermistor (TH6) <2-phase pipe> Thermistor (TH7) <Ambient> Thermistor (TH8) <Heatsink> Thermistor (TH33) <Comp. surface>	Disconnect the connector then measure the resistance with a tester. (At the ambient temperature 10°C to 30°C) <table border="1" style="margin-left: 20px;"> <thead> <tr> <th></th> <th>Normal</th> <th>Abnormal</th> </tr> </thead> <tbody> <tr> <td>TH4, TH33</td> <td>160 kΩ–410 kΩ</td> <td rowspan="3">Open or short</td> </tr> <tr> <td>TH3 TH6 TH7</td> <td>4.3 kΩ–9.6 kΩ</td> </tr> <tr> <td>TH8</td> <td>39 kΩ–105kΩ</td> </tr> </tbody> </table>		Normal	Abnormal	TH4, TH33	160 kΩ–410 kΩ	Open or short	TH3 TH6 TH7	4.3 kΩ–9.6 kΩ	TH8	39 kΩ–105kΩ				
	Normal	Abnormal													
TH4, TH33	160 kΩ–410 kΩ	Open or short													
TH3 TH6 TH7	4.3 kΩ–9.6 kΩ														
TH8	39 kΩ–105kΩ														
Fan motor(MF1,MF2)	Refer to the next page.														
Solenoid valve coil <4-way valve> (21S4)	Measure the resistance between the terminals with a tester. (At the ambient temperature –10°C to 40°C) <table border="1" style="margin-left: 20px;"> <thead> <tr> <th>Normal</th> <th>Abnormal</th> </tr> </thead> <tbody> <tr> <td>1190 to 1780 Ω</td> <td>Open or short</td> </tr> </tbody> </table>	Normal	Abnormal	1190 to 1780 Ω	Open or short										
Normal	Abnormal														
1190 to 1780 Ω	Open or short														
Motor for compressor (MC) 	Measure the resistance between the terminals with a tester. (Winding temperature 20°C) <table border="1" style="margin-left: 20px;"> <thead> <tr> <th>Normal</th> <th>Abnormal</th> </tr> </thead> <tbody> <tr> <td>Refer to “4-2. COMPRESSOR TECHNICAL DATA”.</td> <td>Open or short</td> </tr> </tbody> </table>	Normal	Abnormal	Refer to “4-2. COMPRESSOR TECHNICAL DATA”.	Open or short										
Normal	Abnormal														
Refer to “4-2. COMPRESSOR TECHNICAL DATA”.	Open or short														
Linear expansion valve (LEV-A/LEV-B) 	Disconnect the connector then measure the resistance with a tester. (Winding temperature 20°C) <table border="1" style="margin-left: 20px;"> <thead> <tr> <th colspan="4">Normal</th> <th>Abnormal</th> </tr> </thead> <tbody> <tr> <td>Gray–Black</td> <td>Gray–Red</td> <td>Gray–Yellow</td> <td>Gray–Orange</td> <td rowspan="2">Open or short</td> </tr> <tr> <td colspan="4" style="text-align: center;">46 ± 3 Ω</td> </tr> </tbody> </table>	Normal				Abnormal	Gray–Black	Gray–Red	Gray–Yellow	Gray–Orange	Open or short	46 ± 3 Ω			
Normal				Abnormal											
Gray–Black	Gray–Red	Gray–Yellow	Gray–Orange	Open or short											
46 ± 3 Ω															

Check method of DC fan motor (fan motor / outdoor controller circuit board)

① Notes

- High voltage is applied to the connector (CNF1) for the fan motor. Pay attention to the service.
- Do not pull out the connector (CNF1) for the motor with the power supply on.
(It causes trouble of the outdoor controller circuit board and fan motor.)

② Self check

Symptom : The outdoor fan cannot turn around.

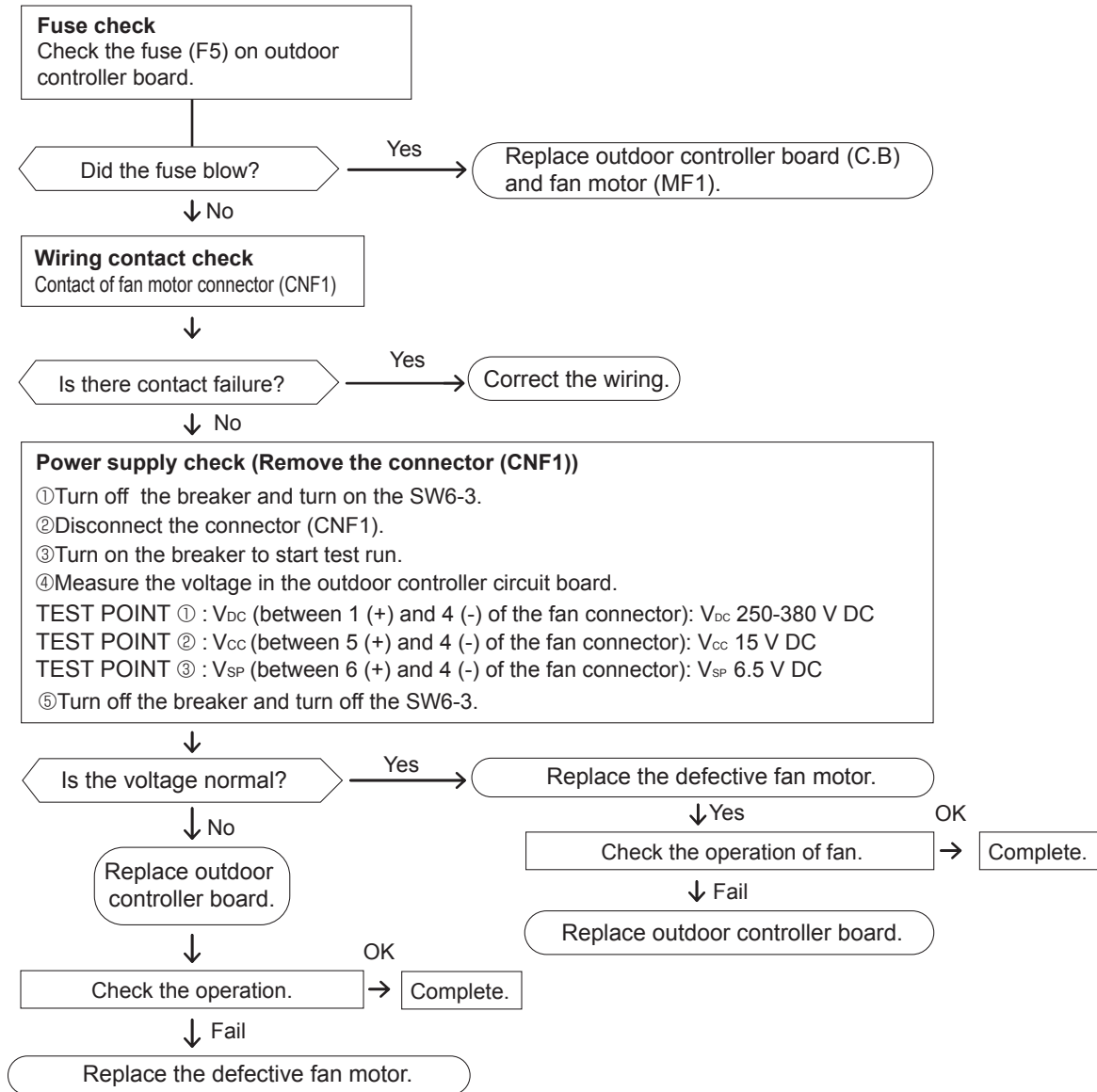

9-7. HOW TO CHECK THE COMPONENTS

<Thermistor feature chart>

Low temperature thermistors

- Thermistor <Liquid> (TH3)
- Thermistor <2-phase pipe> (TH6)
- Thermistor <Ambient> (TH7)

Thermistor R0 = 15 kΩ ± 3 %

B constant = 3480 ± 2 %

$$R_t = 15 \exp\left\{3480 \left(\frac{1}{273+t} - \frac{1}{273} \right)\right\}$$

0°C	15 kΩ	30°C	4.3 kΩ
10°C	9.6 kΩ	40°C	3.0 kΩ
20°C	6.3 kΩ		
25°C	5.2 kΩ		

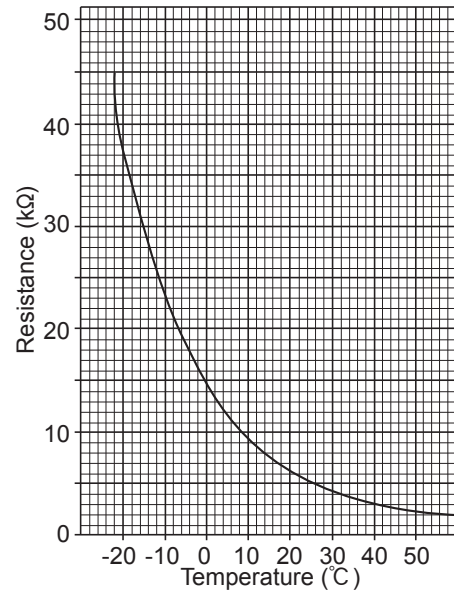

Medium temperature thermistor

- Thermistor <Heatsink> (TH8)

Thermistor R50 = 17 kΩ ± 2 %

B constant = 4150 ± 3 %

$$R_t = 17 \exp\left\{4150 \left(\frac{1}{273+t} - \frac{1}{323} \right)\right\}$$

0°C	180 kΩ
25°C	50 kΩ
50°C	17 kΩ
70°C	8 kΩ
90°C	4 kΩ

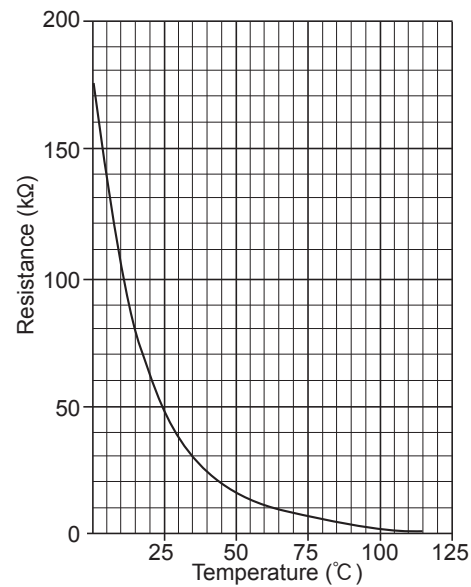

High temperature thermistor

- Thermistor <Discharge> (TH4)
- Thermistor <Comp. surface> (TH33)

Thermistor R120 = 7.465 kΩ ± 2%

B constant = 4057 ± 2%

$$R_t = 7.465 \exp\left\{4057 \left(\frac{1}{273+t} - \frac{1}{393} \right)\right\}$$

20°C	250 kΩ	70°C	34 kΩ
30°C	160 kΩ	80°C	24 kΩ
40°C	104 kΩ	90°C	17.5 kΩ
50°C	70 kΩ	100°C	13.0 kΩ
60°C	48 kΩ	110°C	9.8 kΩ

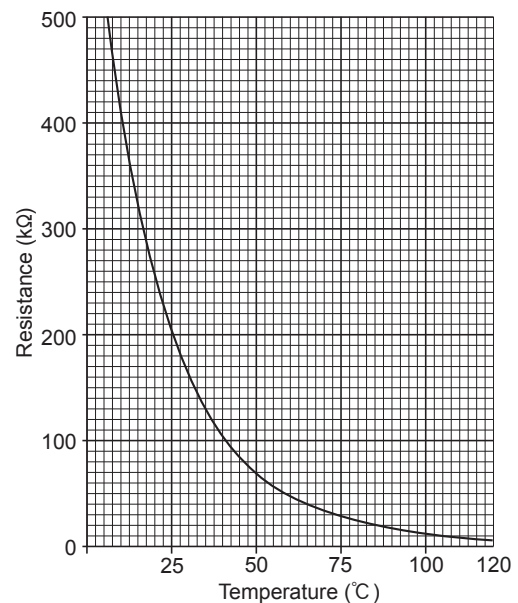

Linear expansion valve

(1) Operation summary of the linear expansion valve

- Linear expansion valve opens/closes through stepping motor after receiving the pulse signal from the outdoor controller board.
 - Valve position can be changed in proportion to the number of pulse signal.
- <Connection between the outdoor controller board and the linear expansion valve>

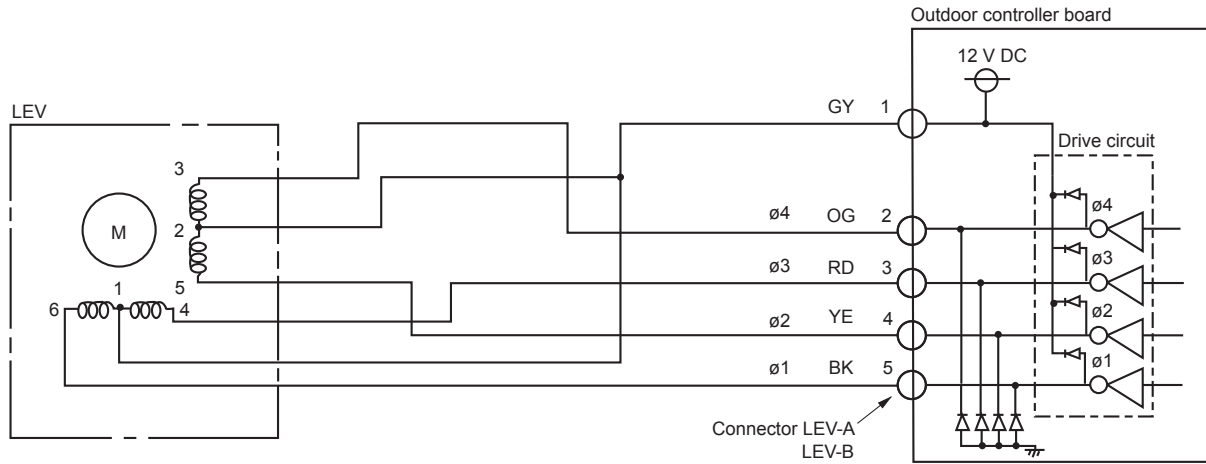

<Output pulse signal and the valve operation>

Output (Phase)	Output							
	1	2	3	4	5	6	7	8
ø1	ON	ON	OFF	OFF	OFF	OFF	OFF	ON
ø2	OFF	ON	ON	ON	OFF	OFF	OFF	OFF
ø3	OFF	OFF	OFF	ON	ON	ON	OFF	OFF
ø4	OFF	OFF	OFF	OFF	OFF	ON	ON	ON

Opening a valve : 8 → 7 → 6 → 5 → 4 → 3 → 2 → 1 → 8

Closing a valve : 1 → 2 → 3 → 4 → 5 → 6 → 7 → 8 → 1

The output pulse shifts in above order.

- When linear expansion valve operation stops, all output phase become OFF.

(2) Linear expansion valve operation

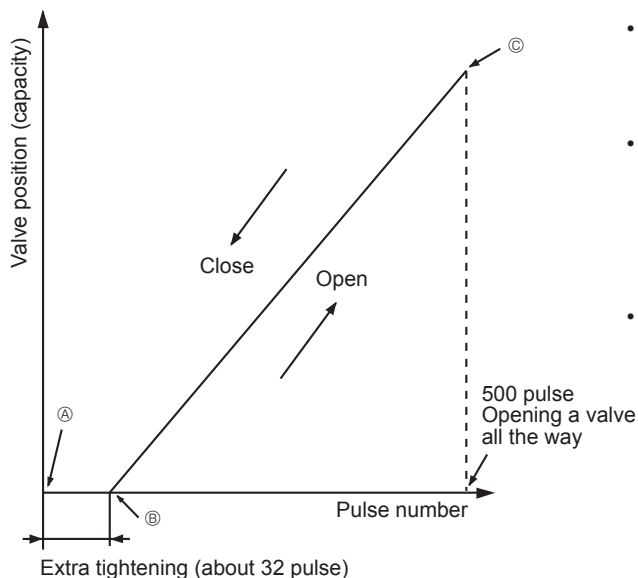

- When the power is turned on, 700 pulse closing valve signal will be sent till it goes to A point in order to define the valve position. (The pulse signal is being sent for about 20 seconds.)
- When the valve moves smoothly, there is no sound or vibration occurring from the linear expansion valve : however, when the pulse number moves from B to A or when the valve is locked, more sound can be heard.
No sound is heard when the pulse number moves from B to A in case coil is burnt out or motor is locked by open-phase.
- Sound can be detected by placing the ear against the screw driver handle while putting the screw driver to the linear expansion valve.

(3) How to attach and detach the coil of linear expansion valve

<Composition>

Linear expansion valve is separable into the main body and the coil as shown in the diagram below.

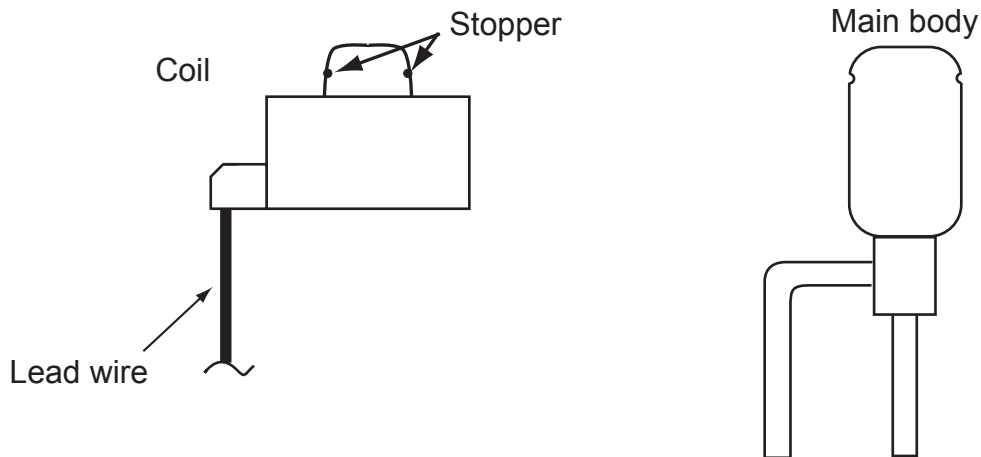

<How to detach the coil>

Hold the lower part of the main body (shown as A) firmly so that the main body does not move and detach the coil by pulling it upward.

Be sure to detach the coil holding main body firmly. Otherwise pipes can bend due to stress.

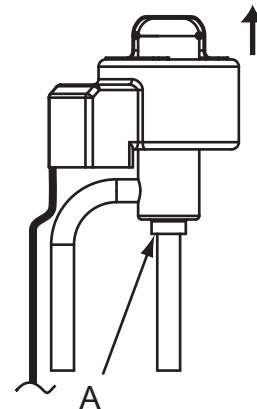

<How to attach the coil>

Hold the lower part of the main body (shown as A) firmly so that the main body does not move and attach the coil by inserting it downward into the main body. Then securely attach the coil stopper to main body. (At this time, be careful that stress is not added to lead wire and main body is not wound by lead wire.) If the stopper is not firmly attached to main body, coil may be detached from the main body and that can cause defective operation of linear expansion valve.

To prevent piping stress, be sure to attach the coil holding the main body of linear expansion valve firmly. Otherwise pipe may break.

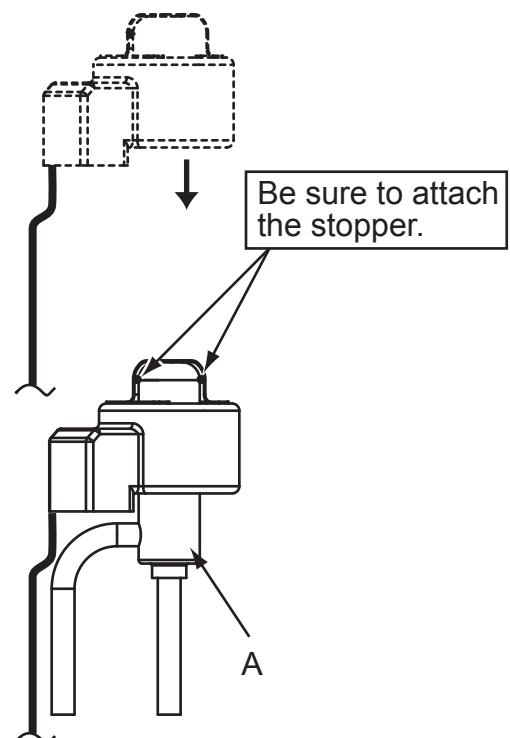

9-8. EMERGENCY OPERATION

(1) When the check codes shown below are displayed on outdoor unit or microcomputer for wired remote controller or indoor unit has a failure, but no other problems are found, emergency operation will be available by setting the emergency operation switch (SWE) on indoor controller board to ON and short-circuiting the connector (CN31) on outdoor controller board.

●When following abnormalities occur, emergency operation will be available.

Check code	Inspected content
U4	Open/short of outdoor unit thermistor (TH6/TH7/TH8)
E8	Indoor/outdoor unit communication error • Signal receiving error (Outdoor unit)
E9	Indoor/outdoor unit communication error • Transmitting error (Indoor unit)
E0 ~ E7	Communication error other than outdoor unit
Ed	Communication error between outdoor controller board and M-NET board (Serial communication error)

(2) Check the following items and cautions for emergency operation

- ① Make sure that there is no abnormality in outdoor unit other than the above abnormalities. (Emergency operation will not be available when check code other than the above are indicated.)
- ② For emergency operation, it is necessary to set the emergency operation switch (SWE) on indoor controller board. Refer to the electrical wiring diagram of indoor unit for how to set the indoor unit.
- ③ During emergency operation, the air-conditioner will continuously be operated by supplying power and stopping it: It cannot be turned on or off by remote control, and temperature control is not possible.
- ④ Do not perform emergency heating operation for an extended period of time: If the outdoor unit starts defrosting during this period, cold air will blow out from the indoor unit.
- ⑤ Do not perform emergency cooling operation for more than 10 hours: Neglecting this could result in freezing the heat exchanger in indoor unit.

(3) Emergency operation procedure

- ① Turn the main power supply off.
- ② Turn on the emergency operation switch (SWE) on indoor controller board.
- ③ Set the shorting pins of emergency operation connector (CN31) on outdoor controller board to ON.

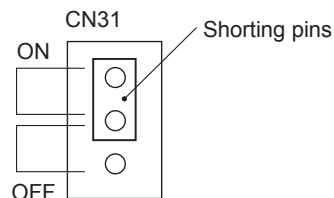

- ④ Turning the main power supply on will start the emergency operation.

(4) Releasing emergency operation

- ① Turn the main power supply off.
- ② Set the emergency operation switch (SWE) on indoor controller board to OFF.
- ③ Set the shorting pins of emergency operation connector (CN31) on outdoor controller board to OFF.

Note:

If shorting pins are not set on emergency operation connector (CN31), the setting remains OFF.

9-9. TEST POINT DIAGRAM

Outdoor controller circuit board

PUZ-M100VKA(-ET).TH **PUZ-M100YKA(-ET).TH**
PUZ-M125VKA(-ET).TH **PUZ-M125YKA(-ET).TH**
PUZ-M140VKA(-ET).TH **PUZ-M140YKA(-ET).TH**

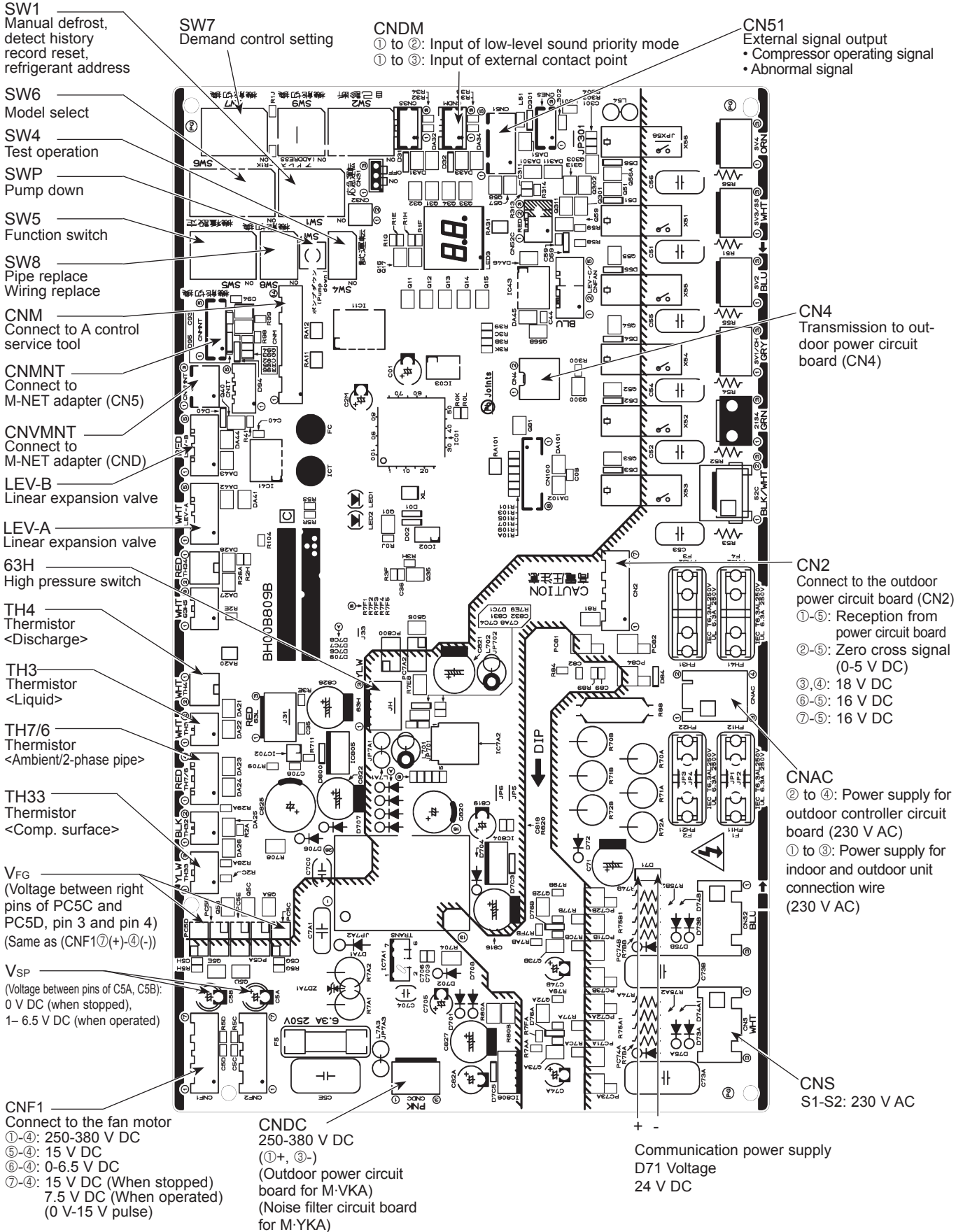

Outdoor noise filter circuit board

PUZ-M100YKA(-ET).TH

PUZ-M125YKA(-ET).TH

PUZ-M140YKA(-ET).TH

L11, L12, L13, NI
POWER SUPPLY
L11-L12/L12-L13/L13-L11 : 400 V AC input
L11-NI/L12-NI/L13-NI : 230 V AC input
(Connect to the terminal block (TB1))

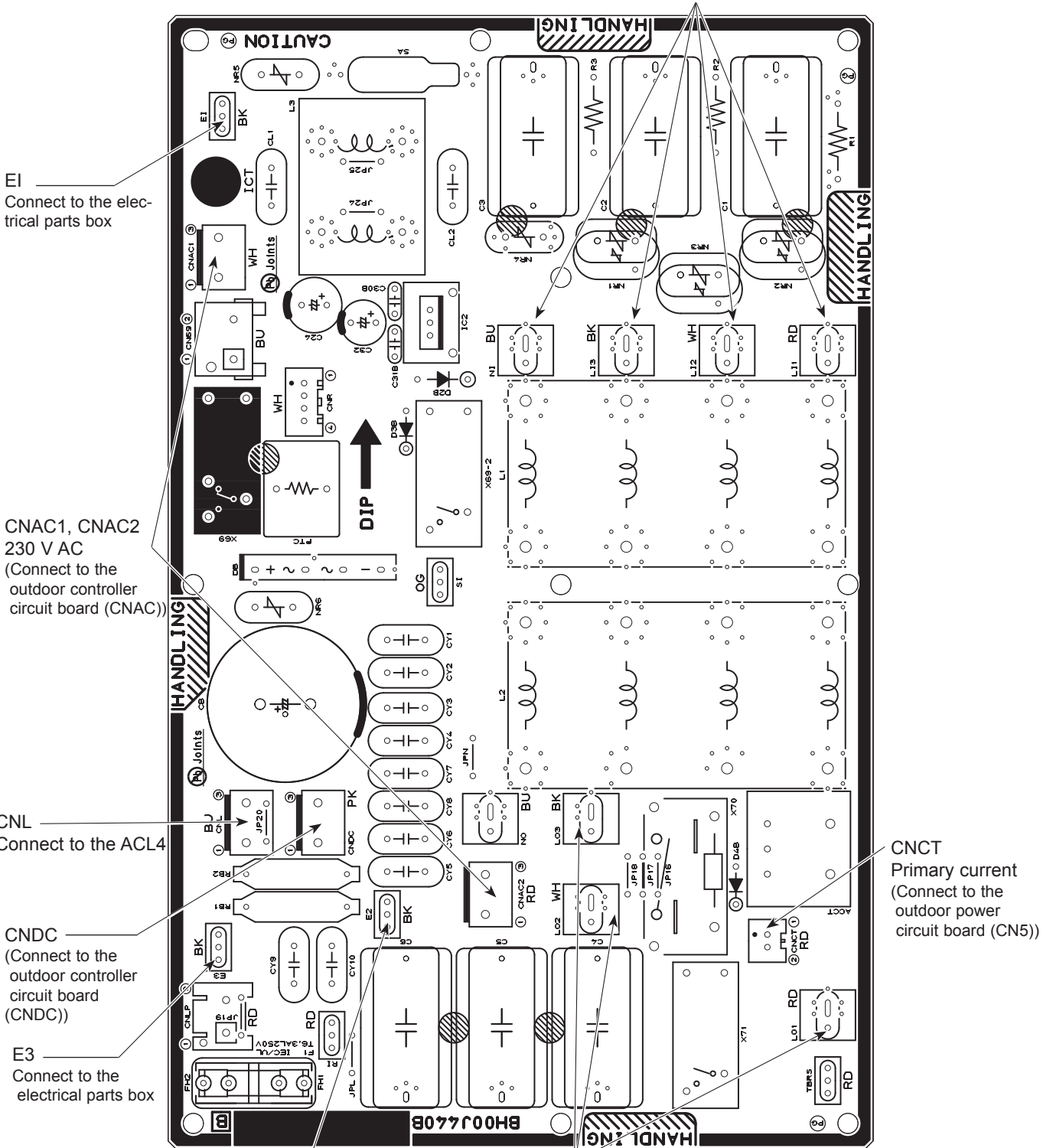

E1
Connect to the electrical parts box

CNAC1, CNAC2
230 V AC
(Connect to the outdoor controller circuit board (CNAC))

CNL
Connect to the ACL4

CNDC
(Connect to the outdoor controller circuit board (CNDC))

E3
Connect to the electrical parts box

E2
Connect to the electrical parts box

LO1, LO2, LO3
POWER SUPPLY
LO1-LO2/LO2-LO3/LO3-LO1 : 400 V AC OUTPUT
(Connect to the outdoor power circuit board (TB-L1, L2, L3))

CNCT
Primary current
(Connect to the outdoor power circuit board (CN5))

Outdoor power circuit board

PUZ-M100VKA(-ET).TH
PUZ-M125VKA(-ET).TH
PUZ-M140VKA(-ET).TH

CN2

Connect to the outdoor controller circuit board (CN2)

①-⑤: Transmitting signal to outdoor controller circuit board (0-5 V DC)

②-⑥: Zero cross signal (0-5 V DC)

③-④: 16 V DC

⑥-⑤: 16 V DC

⑦-⑥: 16 V DC

Brief Check of POWER MODULE

If they are short-circuited, it means that they are broken.

Measure the resistance in the following points (connectors, etc.).

1. Check of POWER MODULE

① Check of DIODE circuit

R-P1, S-P1, R-N1, S-N1

② Check of IGBT circuit

P2-L1, P2-L2, P2-L3, N2-L1, N2-L2, N2-L3

③ Check of INVERTER circuit

P3-U, P3-V, P3-W, N3-U, N3-V, N3-W

Note: The marks **R, S, L1, L2, L3, P1, P2, P3, N1, N2, N3, U, V** and **W** shown in the diagram are not actually printed on the board.

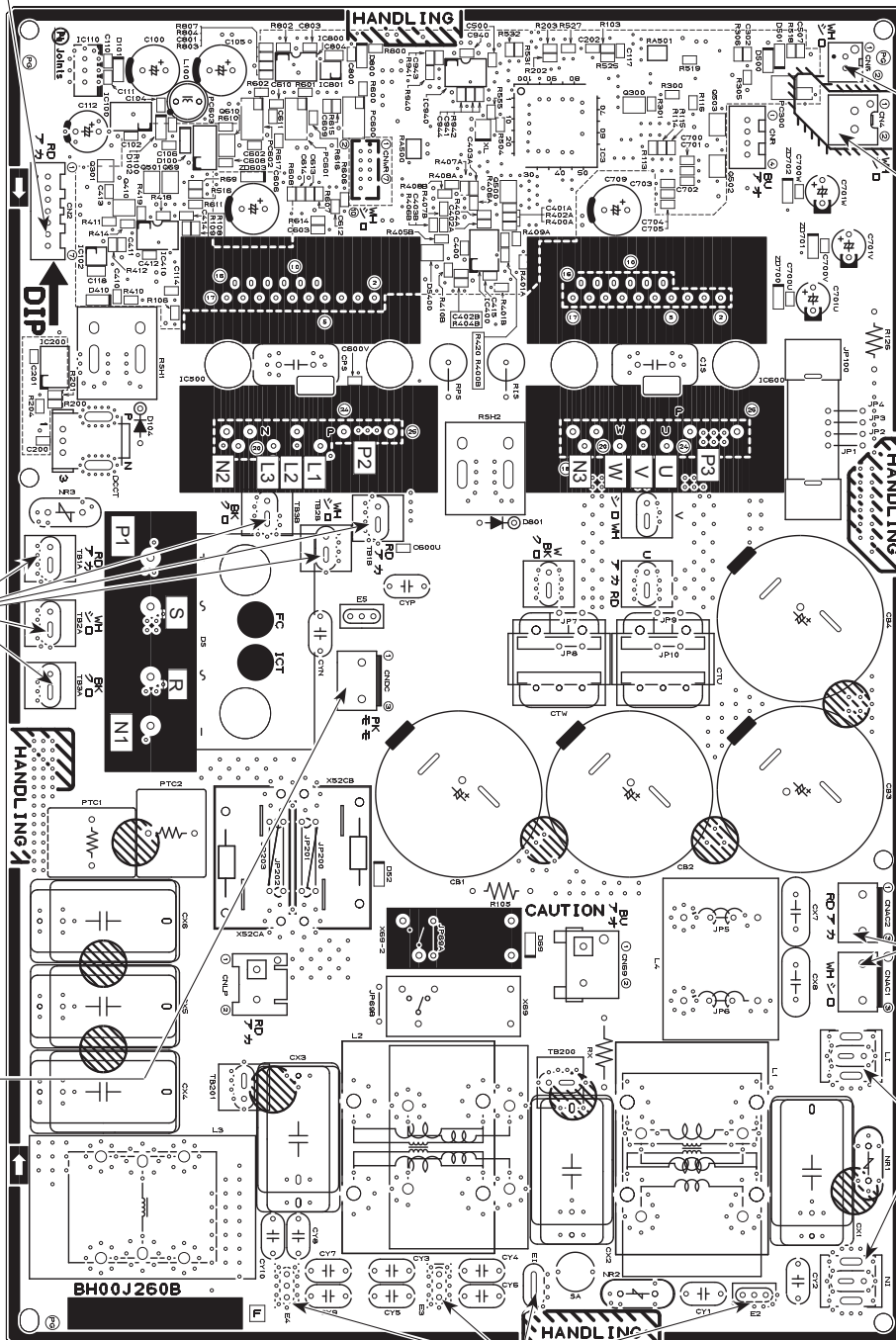

CN6
Thermistor

CN4
Connect to the outdoor controller circuit board (CN4)

TB1A, TB2A, TB3A,
TB1B, TB2B, TB3B
Connect to DCL
*TB2A and TB2B are
not mounted on board
for M100V model.

CNDC
280-380 V DC (①+, ③-)
Connect to the outdoor controller circuit board (CNDC)

CN1, CN2
230 V AC
Connect to the outdoor controller circuit board (CNAC)

NI, LI
Voltage of 230 V AC is input
(Connect to the terminal block (TB1))

E1, E2, E3, E4
Connect to the earth

Outdoor power circuit board

PUZ-M100YKA(-ET).TH
 PUZ-M125YKA(-ET).TH
 PUZ-M140YKA(-ET).TH

Brief Check of POWER MODULE
 If they are short-circuited, it means that they are broken.
 Measure the resistance in the following points (connectors, etc.).

1. Check of DIODE MODULE

L1 - P1, L2 - P1, L3 - P1, L1 - N1, L2 - N1, L3 - N1

2. Check of DIP-IPM

P2 - U, P2 - V, P2 - W, N2 - U, N2 - V, N2 - W

Note: The marks L1, L2, L3, N1, N2, P1, P2, U, V and W shown in the diagram are not actually printed on the board.

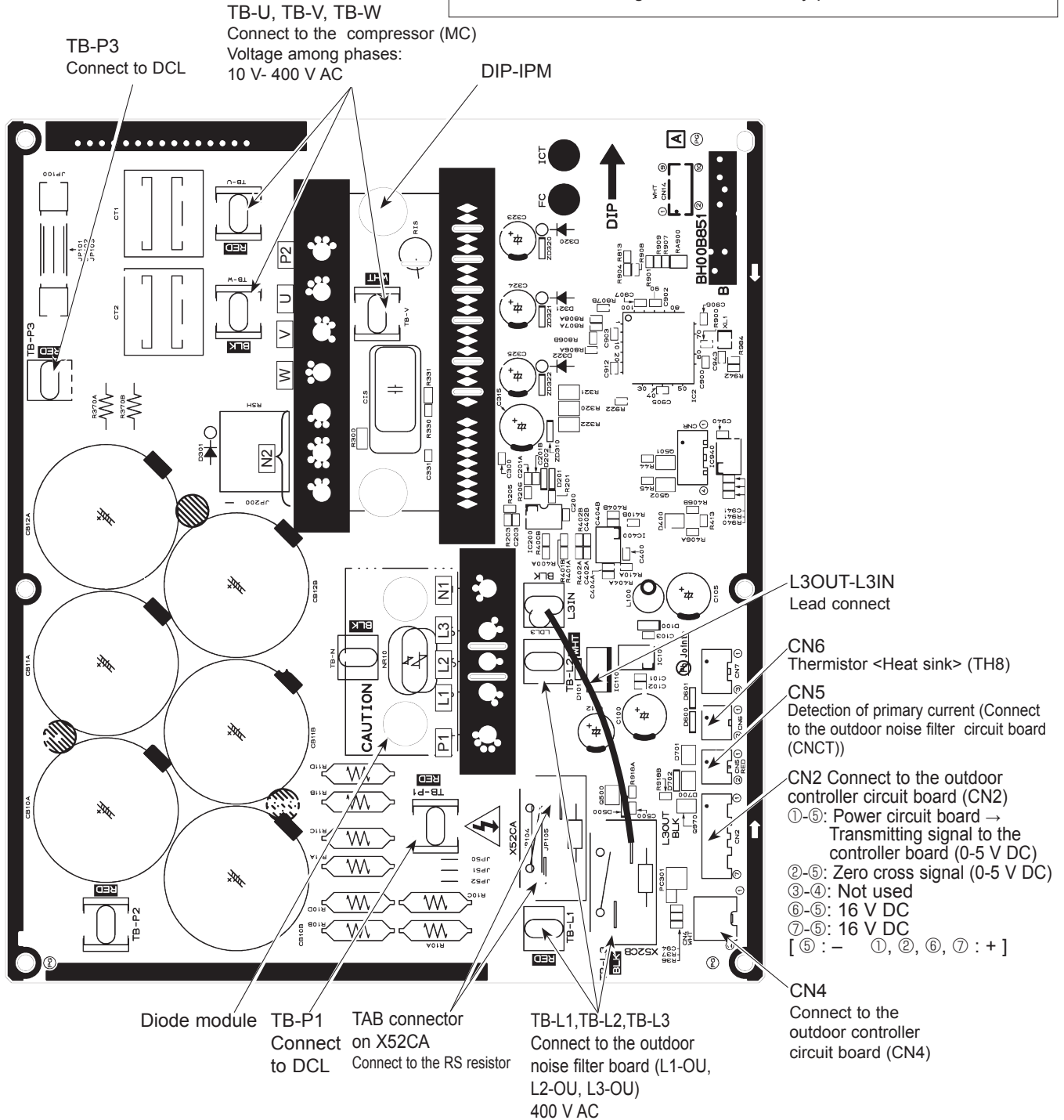

Outdoor M-NET board (optional)

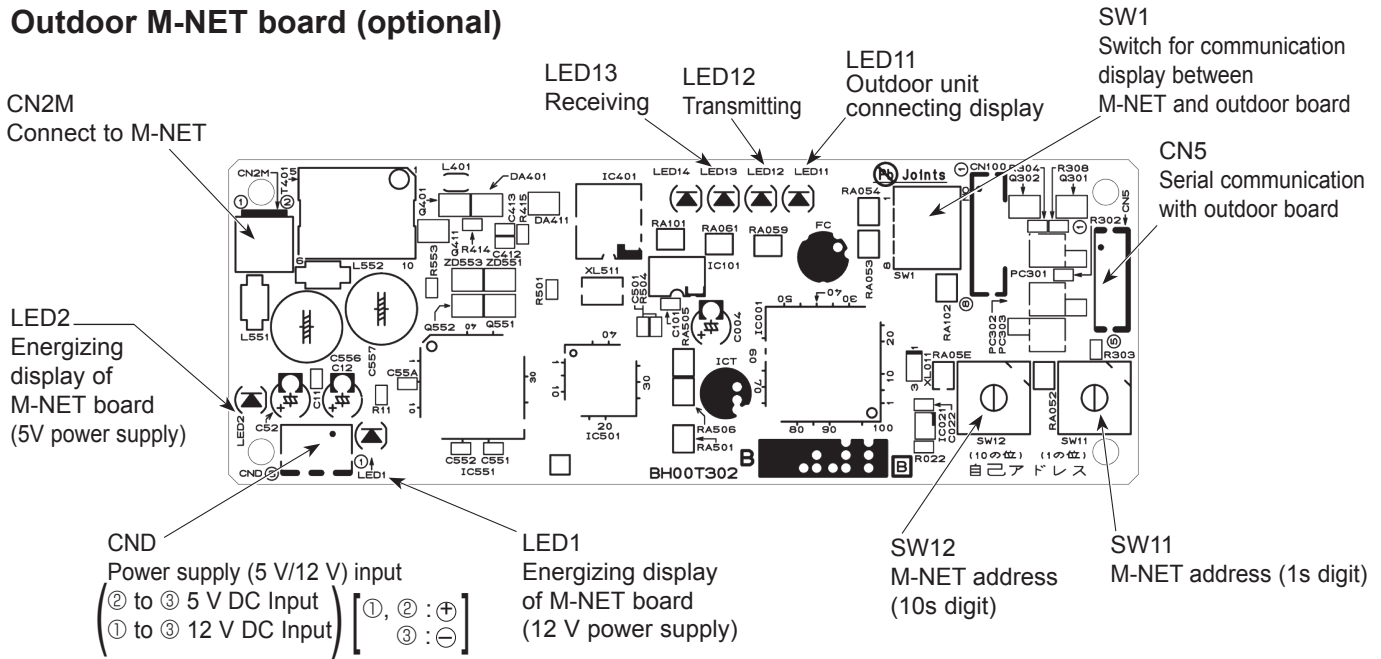

9-10. FUNCTION OF SWITCHES, CONNECTORS AND JUMPERS

(1) Function of switches

The black square (■) indicates a switch position.

Type of switch	Switch No.	Function	Action by the switch operation		Effective timing				
			ON	OFF					
DIP switch	SW1	1	Manual defrost *1	Start	Normal	When compressor is working in heating operation. *1			
		2	Abnormal history clear	Clear	Normal		off or operating		
		3	Refrigerant address setting	0					When power supply ON
				1					
				4					
				5					
				6					
				12					
				13					
				14					
				15					
				1	Test run	Operating	OFF	Under suspension	
		2	Test run mode setting	Heating	Cooling				
		Push switch	SWP	Pump down	Start	Normal	Under suspension		

*1 Manual defrost should be done as follows.

- ① Change the DIP SW1-1 on the outdoor controller board from OFF to ON.
- ② Manual defrost will start by the above operation ① if all these conditions written below are satisfied.
 - Heat mode setting
 - 10 minutes have passed since compressor started operating or previous manual defrost is finished.
 - Pipe temperature is less than or equal to 8°C.

Manual defrost will finish if certain conditions have been satisfied.

Manual defrost can be done if above conditions have been satisfied when DIP SW1-1 is changed from OFF to ON.

After DIP SW1-1 is changed from OFF to ON, there is no problem if DIP SW1-1 is left ON or changed to OFF again.

This depends on the service conditions.

Continued to the next page

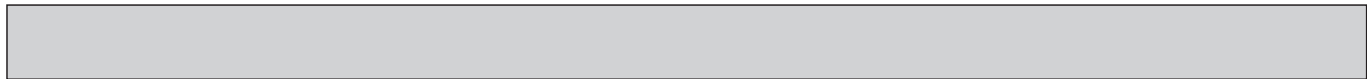

Type of Switch	Switch	No.	Function	Action by the switch operation		Effective timing																																																																																																																																																																													
				ON	OFF																																																																																																																																																																														
Dip switch	SW5	1	No function	—	—	—																																																																																																																																																																													
		2	Power failure automatic recovery *2	Auto recovery	No auto recovery	When power supply ON																																																																																																																																																																													
		3,4,5,6	No function	—	—	—																																																																																																																																																																													
	SW7 *4	1	Setting of demand control *3	<table border="1"> <tr> <td>SW7-1</td> <td>SW7-2</td> <td>Power consumption (Demand switch ON)</td> </tr> <tr> <td>OFF</td> <td>OFF</td> <td>0% (Operation stop)</td> </tr> <tr> <td>ON</td> <td>OFF</td> <td>50%</td> </tr> <tr> <td>OFF</td> <td>ON</td> <td>75%</td> </tr> </table>			SW7-1	SW7-2	Power consumption (Demand switch ON)	OFF	OFF	0% (Operation stop)	ON	OFF	50%	OFF	ON	75%																																																																																																																																																																	
				SW7-1	SW7-2	Power consumption (Demand switch ON)																																																																																																																																																																													
				OFF	OFF	0% (Operation stop)																																																																																																																																																																													
				ON	OFF	50%																																																																																																																																																																													
		OFF	ON	75%																																																																																																																																																																															
		3	Max Hz setting (cooling)	Max Hz (cooling) × 0.8	Normal	Always																																																																																																																																																																													
	4	Max Hz setting (heating)	Max Hz (heating) × 0.8	Normal	Always																																																																																																																																																																														
	5	No function	—	—	—																																																																																																																																																																														
	6	Defrost Hz setting	For high humidity	Normal	Always																																																																																																																																																																														
	SW8	1	No function	—	—	—																																																																																																																																																																													
		2	No function	—	—	—																																																																																																																																																																													
		3	No function	—	—	—																																																																																																																																																																													
	SW9	1	No function	—	—	—																																																																																																																																																																													
		2	Function switch	Valid	Normal	Always																																																																																																																																																																													
		3,4	No function	—	—	—																																																																																																																																																																													
	SW6	1	No function	—	—	—																																																																																																																																																																													
		2	No function	—	—	—																																																																																																																																																																													
		3	Fan motor check mode	ON	OFF	When power supply ON during test run																																																																																																																																																																													
		4	<table border="1"> <thead> <tr> <th>MODEL</th> <th>SW6-4, 5, 6, 7, 8*5</th> </tr> </thead> <tbody> <tr> <td>100V</td> <td> <table border="1"> <tr> <td>ON</td> <td><input type="checkbox"/></td> <td><input type="checkbox"/></td> <td><input type="checkbox"/></td> <td><input type="checkbox"/></td> <td><input type="checkbox"/></td> <td><input type="checkbox"/></td> <td><input type="checkbox"/></td> <td><input type="checkbox"/></td> </tr> <tr> <td>OFF</td> <td><input type="checkbox"/></td> <td><input type="checkbox"/></td> <td><input type="checkbox"/></td> <td><input type="checkbox"/></td> <td><input type="checkbox"/></td> <td><input type="checkbox"/></td> <td><input type="checkbox"/></td> <td><input type="checkbox"/></td> </tr> <tr> <td></td> <td>1</td> <td>2</td> <td>3</td> <td>4</td> <td>5</td> <td>6</td> <td>7</td> <td>8</td> </tr> </table> </td> </tr> <tr> <td>125V</td> <td> <table border="1"> <tr> <td>ON</td> <td><input type="checkbox"/></td> <td><input type="checkbox"/></td> <td><input type="checkbox"/></td> <td><input type="checkbox"/></td> <td><input type="checkbox"/></td> <td><input type="checkbox"/></td> <td><input type="checkbox"/></td> <td><input type="checkbox"/></td> </tr> <tr> <td>OFF</td> <td><input type="checkbox"/></td> <td><input type="checkbox"/></td> <td><input type="checkbox"/></td> <td><input type="checkbox"/></td> <td><input type="checkbox"/></td> <td><input type="checkbox"/></td> <td><input type="checkbox"/></td> <td><input type="checkbox"/></td> </tr> <tr> <td></td> <td>1</td> <td>2</td> <td>3</td> <td>4</td> <td>5</td> <td>6</td> <td>7</td> <td>8</td> </tr> </table> </td> </tr> <tr> <td>140V</td> <td> <table border="1"> <tr> <td>ON</td> <td><input type="checkbox"/></td> <td><input type="checkbox"/></td> <td><input type="checkbox"/></td> <td><input type="checkbox"/></td> <td><input type="checkbox"/></td> <td><input type="checkbox"/></td> <td><input type="checkbox"/></td> <td><input type="checkbox"/></td> </tr> <tr> <td>OFF</td> <td><input type="checkbox"/></td> <td><input type="checkbox"/></td> <td><input type="checkbox"/></td> <td><input type="checkbox"/></td> <td><input type="checkbox"/></td> <td><input type="checkbox"/></td> <td><input type="checkbox"/></td> <td><input type="checkbox"/></td> </tr> <tr> <td></td> <td>1</td> <td>2</td> <td>3</td> <td>4</td> <td>5</td> <td>6</td> <td>7</td> <td>8</td> </tr> </table> </td> </tr> <tr> <td>100Y</td> <td> <table border="1"> <tr> <td>ON</td> <td><input type="checkbox"/></td> <td><input type="checkbox"/></td> <td><input type="checkbox"/></td> <td><input type="checkbox"/></td> <td><input type="checkbox"/></td> <td><input type="checkbox"/></td> <td><input type="checkbox"/></td> <td><input type="checkbox"/></td> </tr> <tr> <td>OFF</td> <td><input type="checkbox"/></td> <td><input type="checkbox"/></td> <td><input type="checkbox"/></td> <td><input type="checkbox"/></td> <td><input type="checkbox"/></td> <td><input type="checkbox"/></td> <td><input type="checkbox"/></td> <td><input type="checkbox"/></td> </tr> <tr> <td></td> <td>1</td> <td>2</td> <td>3</td> <td>4</td> <td>5</td> <td>6</td> <td>7</td> <td>8</td> </tr> </table> </td> </tr> <tr> <td>125Y</td> <td> <table border="1"> <tr> <td>ON</td> <td><input type="checkbox"/></td> <td><input type="checkbox"/></td> <td><input type="checkbox"/></td> <td><input type="checkbox"/></td> <td><input type="checkbox"/></td> <td><input type="checkbox"/></td> <td><input type="checkbox"/></td> <td><input type="checkbox"/></td> </tr> <tr> <td>OFF</td> <td><input type="checkbox"/></td> <td><input type="checkbox"/></td> <td><input type="checkbox"/></td> <td><input type="checkbox"/></td> <td><input type="checkbox"/></td> <td><input type="checkbox"/></td> <td><input type="checkbox"/></td> <td><input type="checkbox"/></td> </tr> <tr> <td></td> <td>1</td> <td>2</td> <td>3</td> <td>4</td> <td>5</td> <td>6</td> <td>7</td> <td>8</td> </tr> </table> </td> </tr> <tr> <td>140Y</td> <td> <table border="1"> <tr> <td>ON</td> <td><input type="checkbox"/></td> <td><input type="checkbox"/></td> <td><input type="checkbox"/></td> <td><input type="checkbox"/></td> <td><input type="checkbox"/></td> <td><input type="checkbox"/></td> <td><input type="checkbox"/></td> <td><input type="checkbox"/></td> </tr> <tr> <td>OFF</td> <td><input type="checkbox"/></td> <td><input type="checkbox"/></td> <td><input type="checkbox"/></td> <td><input type="checkbox"/></td> <td><input type="checkbox"/></td> <td><input type="checkbox"/></td> <td><input type="checkbox"/></td> <td><input type="checkbox"/></td> </tr> <tr> <td></td> <td>1</td> <td>2</td> <td>3</td> <td>4</td> <td>5</td> <td>6</td> <td>7</td> <td>8</td> </tr> </table> </td> </tr> </tbody> </table>	MODEL	SW6-4, 5, 6, 7, 8*5	100V	<table border="1"> <tr> <td>ON</td> <td><input type="checkbox"/></td> <td><input type="checkbox"/></td> <td><input type="checkbox"/></td> <td><input type="checkbox"/></td> <td><input type="checkbox"/></td> <td><input type="checkbox"/></td> <td><input type="checkbox"/></td> <td><input type="checkbox"/></td> </tr> <tr> <td>OFF</td> <td><input type="checkbox"/></td> <td><input type="checkbox"/></td> <td><input type="checkbox"/></td> <td><input type="checkbox"/></td> <td><input type="checkbox"/></td> <td><input type="checkbox"/></td> <td><input type="checkbox"/></td> <td><input type="checkbox"/></td> </tr> <tr> <td></td> <td>1</td> <td>2</td> <td>3</td> <td>4</td> <td>5</td> <td>6</td> <td>7</td> <td>8</td> </tr> </table>	ON	<input type="checkbox"/>	<input type="checkbox"/>	<input type="checkbox"/>	<input type="checkbox"/>	<input type="checkbox"/>	<input type="checkbox"/>	<input type="checkbox"/>	<input type="checkbox"/>	OFF	<input type="checkbox"/>	<input type="checkbox"/>	<input type="checkbox"/>	<input type="checkbox"/>	<input type="checkbox"/>	<input type="checkbox"/>	<input type="checkbox"/>	<input type="checkbox"/>		1	2	3	4	5	6	7	8	125V	<table border="1"> <tr> <td>ON</td> <td><input type="checkbox"/></td> <td><input type="checkbox"/></td> <td><input type="checkbox"/></td> <td><input type="checkbox"/></td> <td><input type="checkbox"/></td> <td><input type="checkbox"/></td> <td><input type="checkbox"/></td> <td><input type="checkbox"/></td> </tr> <tr> <td>OFF</td> <td><input type="checkbox"/></td> <td><input type="checkbox"/></td> <td><input type="checkbox"/></td> <td><input type="checkbox"/></td> <td><input type="checkbox"/></td> <td><input type="checkbox"/></td> <td><input type="checkbox"/></td> <td><input type="checkbox"/></td> </tr> <tr> <td></td> <td>1</td> <td>2</td> <td>3</td> <td>4</td> <td>5</td> <td>6</td> <td>7</td> <td>8</td> </tr> </table>	ON	<input type="checkbox"/>	<input type="checkbox"/>	<input type="checkbox"/>	<input type="checkbox"/>	<input type="checkbox"/>	<input type="checkbox"/>	<input type="checkbox"/>	<input type="checkbox"/>	OFF	<input type="checkbox"/>	<input type="checkbox"/>	<input type="checkbox"/>	<input type="checkbox"/>	<input type="checkbox"/>	<input type="checkbox"/>	<input type="checkbox"/>	<input type="checkbox"/>		1	2	3	4	5	6	7	8	140V	<table border="1"> <tr> <td>ON</td> <td><input type="checkbox"/></td> <td><input type="checkbox"/></td> <td><input type="checkbox"/></td> <td><input type="checkbox"/></td> <td><input type="checkbox"/></td> <td><input type="checkbox"/></td> <td><input type="checkbox"/></td> <td><input type="checkbox"/></td> </tr> <tr> <td>OFF</td> <td><input type="checkbox"/></td> <td><input type="checkbox"/></td> <td><input type="checkbox"/></td> <td><input type="checkbox"/></td> <td><input type="checkbox"/></td> <td><input type="checkbox"/></td> <td><input type="checkbox"/></td> <td><input type="checkbox"/></td> </tr> <tr> <td></td> <td>1</td> <td>2</td> <td>3</td> <td>4</td> <td>5</td> <td>6</td> <td>7</td> <td>8</td> </tr> </table>	ON	<input type="checkbox"/>	<input type="checkbox"/>	<input type="checkbox"/>	<input type="checkbox"/>	<input type="checkbox"/>	<input type="checkbox"/>	<input type="checkbox"/>	<input type="checkbox"/>	OFF	<input type="checkbox"/>	<input type="checkbox"/>	<input type="checkbox"/>	<input type="checkbox"/>	<input type="checkbox"/>	<input type="checkbox"/>	<input type="checkbox"/>	<input type="checkbox"/>		1	2	3	4	5	6	7	8	100Y	<table border="1"> <tr> <td>ON</td> <td><input type="checkbox"/></td> <td><input type="checkbox"/></td> <td><input type="checkbox"/></td> <td><input type="checkbox"/></td> <td><input type="checkbox"/></td> <td><input type="checkbox"/></td> <td><input type="checkbox"/></td> <td><input type="checkbox"/></td> </tr> <tr> <td>OFF</td> <td><input type="checkbox"/></td> <td><input type="checkbox"/></td> <td><input type="checkbox"/></td> <td><input type="checkbox"/></td> <td><input type="checkbox"/></td> <td><input type="checkbox"/></td> <td><input type="checkbox"/></td> <td><input type="checkbox"/></td> </tr> <tr> <td></td> <td>1</td> <td>2</td> <td>3</td> <td>4</td> <td>5</td> <td>6</td> <td>7</td> <td>8</td> </tr> </table>	ON	<input type="checkbox"/>	<input type="checkbox"/>	<input type="checkbox"/>	<input type="checkbox"/>	<input type="checkbox"/>	<input type="checkbox"/>	<input type="checkbox"/>	<input type="checkbox"/>	OFF	<input type="checkbox"/>	<input type="checkbox"/>	<input type="checkbox"/>	<input type="checkbox"/>	<input type="checkbox"/>	<input type="checkbox"/>	<input type="checkbox"/>	<input type="checkbox"/>		1	2	3	4	5	6	7	8	125Y	<table border="1"> <tr> <td>ON</td> <td><input type="checkbox"/></td> <td><input type="checkbox"/></td> <td><input type="checkbox"/></td> <td><input type="checkbox"/></td> <td><input type="checkbox"/></td> <td><input type="checkbox"/></td> <td><input type="checkbox"/></td> <td><input type="checkbox"/></td> </tr> <tr> <td>OFF</td> <td><input type="checkbox"/></td> <td><input type="checkbox"/></td> <td><input type="checkbox"/></td> <td><input type="checkbox"/></td> <td><input type="checkbox"/></td> <td><input type="checkbox"/></td> <td><input type="checkbox"/></td> <td><input type="checkbox"/></td> </tr> <tr> <td></td> <td>1</td> <td>2</td> <td>3</td> <td>4</td> <td>5</td> <td>6</td> <td>7</td> <td>8</td> </tr> </table>	ON	<input type="checkbox"/>	<input type="checkbox"/>	<input type="checkbox"/>	<input type="checkbox"/>	<input type="checkbox"/>	<input type="checkbox"/>	<input type="checkbox"/>	<input type="checkbox"/>	OFF	<input type="checkbox"/>	<input type="checkbox"/>	<input type="checkbox"/>	<input type="checkbox"/>	<input type="checkbox"/>	<input type="checkbox"/>	<input type="checkbox"/>	<input type="checkbox"/>		1	2	3	4	5	6	7	8	140Y	<table border="1"> <tr> <td>ON</td> <td><input type="checkbox"/></td> <td><input type="checkbox"/></td> <td><input type="checkbox"/></td> <td><input type="checkbox"/></td> <td><input type="checkbox"/></td> <td><input type="checkbox"/></td> <td><input type="checkbox"/></td> <td><input type="checkbox"/></td> </tr> <tr> <td>OFF</td> <td><input type="checkbox"/></td> <td><input type="checkbox"/></td> <td><input type="checkbox"/></td> <td><input type="checkbox"/></td> <td><input type="checkbox"/></td> <td><input type="checkbox"/></td> <td><input type="checkbox"/></td> <td><input type="checkbox"/></td> </tr> <tr> <td></td> <td>1</td> <td>2</td> <td>3</td> <td>4</td> <td>5</td> <td>6</td> <td>7</td> <td>8</td> </tr> </table>	ON	<input type="checkbox"/>	<input type="checkbox"/>	<input type="checkbox"/>	<input type="checkbox"/>	<input type="checkbox"/>	<input type="checkbox"/>	<input type="checkbox"/>	<input type="checkbox"/>	OFF	<input type="checkbox"/>	<input type="checkbox"/>	<input type="checkbox"/>	<input type="checkbox"/>	<input type="checkbox"/>	<input type="checkbox"/>	<input type="checkbox"/>	<input type="checkbox"/>		1	2	3	4	5	6	7	8
		MODEL		SW6-4, 5, 6, 7, 8*5																																																																																																																																																																															
		100V		<table border="1"> <tr> <td>ON</td> <td><input type="checkbox"/></td> <td><input type="checkbox"/></td> <td><input type="checkbox"/></td> <td><input type="checkbox"/></td> <td><input type="checkbox"/></td> <td><input type="checkbox"/></td> <td><input type="checkbox"/></td> <td><input type="checkbox"/></td> </tr> <tr> <td>OFF</td> <td><input type="checkbox"/></td> <td><input type="checkbox"/></td> <td><input type="checkbox"/></td> <td><input type="checkbox"/></td> <td><input type="checkbox"/></td> <td><input type="checkbox"/></td> <td><input type="checkbox"/></td> <td><input type="checkbox"/></td> </tr> <tr> <td></td> <td>1</td> <td>2</td> <td>3</td> <td>4</td> <td>5</td> <td>6</td> <td>7</td> <td>8</td> </tr> </table>	ON	<input type="checkbox"/>	<input type="checkbox"/>	<input type="checkbox"/>	<input type="checkbox"/>	<input type="checkbox"/>	<input type="checkbox"/>	<input type="checkbox"/>	<input type="checkbox"/>	OFF	<input type="checkbox"/>	<input type="checkbox"/>	<input type="checkbox"/>	<input type="checkbox"/>	<input type="checkbox"/>	<input type="checkbox"/>	<input type="checkbox"/>	<input type="checkbox"/>		1	2	3	4	5	6	7	8																																																																																																																																																				
		ON		<input type="checkbox"/>	<input type="checkbox"/>	<input type="checkbox"/>	<input type="checkbox"/>	<input type="checkbox"/>	<input type="checkbox"/>	<input type="checkbox"/>	<input type="checkbox"/>																																																																																																																																																																								
		OFF		<input type="checkbox"/>	<input type="checkbox"/>	<input type="checkbox"/>	<input type="checkbox"/>	<input type="checkbox"/>	<input type="checkbox"/>	<input type="checkbox"/>	<input type="checkbox"/>																																																																																																																																																																								
		1		2	3	4	5	6	7	8																																																																																																																																																																									
125V	<table border="1"> <tr> <td>ON</td> <td><input type="checkbox"/></td> <td><input type="checkbox"/></td> <td><input type="checkbox"/></td> <td><input type="checkbox"/></td> <td><input type="checkbox"/></td> <td><input type="checkbox"/></td> <td><input type="checkbox"/></td> <td><input type="checkbox"/></td> </tr> <tr> <td>OFF</td> <td><input type="checkbox"/></td> <td><input type="checkbox"/></td> <td><input type="checkbox"/></td> <td><input type="checkbox"/></td> <td><input type="checkbox"/></td> <td><input type="checkbox"/></td> <td><input type="checkbox"/></td> <td><input type="checkbox"/></td> </tr> <tr> <td></td> <td>1</td> <td>2</td> <td>3</td> <td>4</td> <td>5</td> <td>6</td> <td>7</td> <td>8</td> </tr> </table>	ON		<input type="checkbox"/>	<input type="checkbox"/>	<input type="checkbox"/>	<input type="checkbox"/>	<input type="checkbox"/>	<input type="checkbox"/>	<input type="checkbox"/>	<input type="checkbox"/>	OFF	<input type="checkbox"/>	<input type="checkbox"/>	<input type="checkbox"/>	<input type="checkbox"/>	<input type="checkbox"/>	<input type="checkbox"/>	<input type="checkbox"/>	<input type="checkbox"/>		1	2	3	4	5	6	7	8																																																																																																																																																						
ON	<input type="checkbox"/>	<input type="checkbox"/>		<input type="checkbox"/>	<input type="checkbox"/>	<input type="checkbox"/>	<input type="checkbox"/>	<input type="checkbox"/>	<input type="checkbox"/>																																																																																																																																																																										
OFF	<input type="checkbox"/>	<input type="checkbox"/>	<input type="checkbox"/>	<input type="checkbox"/>	<input type="checkbox"/>	<input type="checkbox"/>	<input type="checkbox"/>	<input type="checkbox"/>																																																																																																																																																																											
	1	2	3	4	5	6	7	8																																																																																																																																																																											
140V	<table border="1"> <tr> <td>ON</td> <td><input type="checkbox"/></td> <td><input type="checkbox"/></td> <td><input type="checkbox"/></td> <td><input type="checkbox"/></td> <td><input type="checkbox"/></td> <td><input type="checkbox"/></td> <td><input type="checkbox"/></td> <td><input type="checkbox"/></td> </tr> <tr> <td>OFF</td> <td><input type="checkbox"/></td> <td><input type="checkbox"/></td> <td><input type="checkbox"/></td> <td><input type="checkbox"/></td> <td><input type="checkbox"/></td> <td><input type="checkbox"/></td> <td><input type="checkbox"/></td> <td><input type="checkbox"/></td> </tr> <tr> <td></td> <td>1</td> <td>2</td> <td>3</td> <td>4</td> <td>5</td> <td>6</td> <td>7</td> <td>8</td> </tr> </table>	ON	<input type="checkbox"/>	<input type="checkbox"/>	<input type="checkbox"/>	<input type="checkbox"/>	<input type="checkbox"/>	<input type="checkbox"/>	<input type="checkbox"/>	<input type="checkbox"/>	OFF	<input type="checkbox"/>	<input type="checkbox"/>	<input type="checkbox"/>	<input type="checkbox"/>	<input type="checkbox"/>	<input type="checkbox"/>	<input type="checkbox"/>	<input type="checkbox"/>		1	2	3	4	5	6	7	8																																																																																																																																																							
ON	<input type="checkbox"/>	<input type="checkbox"/>	<input type="checkbox"/>	<input type="checkbox"/>	<input type="checkbox"/>	<input type="checkbox"/>	<input type="checkbox"/>	<input type="checkbox"/>																																																																																																																																																																											
OFF	<input type="checkbox"/>	<input type="checkbox"/>	<input type="checkbox"/>	<input type="checkbox"/>	<input type="checkbox"/>	<input type="checkbox"/>	<input type="checkbox"/>	<input type="checkbox"/>																																																																																																																																																																											
	1	2	3	4	5	6	7	8																																																																																																																																																																											
100Y	<table border="1"> <tr> <td>ON</td> <td><input type="checkbox"/></td> <td><input type="checkbox"/></td> <td><input type="checkbox"/></td> <td><input type="checkbox"/></td> <td><input type="checkbox"/></td> <td><input type="checkbox"/></td> <td><input type="checkbox"/></td> <td><input type="checkbox"/></td> </tr> <tr> <td>OFF</td> <td><input type="checkbox"/></td> <td><input type="checkbox"/></td> <td><input type="checkbox"/></td> <td><input type="checkbox"/></td> <td><input type="checkbox"/></td> <td><input type="checkbox"/></td> <td><input type="checkbox"/></td> <td><input type="checkbox"/></td> </tr> <tr> <td></td> <td>1</td> <td>2</td> <td>3</td> <td>4</td> <td>5</td> <td>6</td> <td>7</td> <td>8</td> </tr> </table>	ON	<input type="checkbox"/>	<input type="checkbox"/>	<input type="checkbox"/>	<input type="checkbox"/>	<input type="checkbox"/>	<input type="checkbox"/>	<input type="checkbox"/>	<input type="checkbox"/>	OFF	<input type="checkbox"/>	<input type="checkbox"/>	<input type="checkbox"/>	<input type="checkbox"/>	<input type="checkbox"/>	<input type="checkbox"/>	<input type="checkbox"/>	<input type="checkbox"/>		1	2	3	4	5	6	7	8																																																																																																																																																							
ON	<input type="checkbox"/>	<input type="checkbox"/>	<input type="checkbox"/>	<input type="checkbox"/>	<input type="checkbox"/>	<input type="checkbox"/>	<input type="checkbox"/>	<input type="checkbox"/>																																																																																																																																																																											
OFF	<input type="checkbox"/>	<input type="checkbox"/>	<input type="checkbox"/>	<input type="checkbox"/>	<input type="checkbox"/>	<input type="checkbox"/>	<input type="checkbox"/>	<input type="checkbox"/>																																																																																																																																																																											
	1	2	3	4	5	6	7	8																																																																																																																																																																											
125Y	<table border="1"> <tr> <td>ON</td> <td><input type="checkbox"/></td> <td><input type="checkbox"/></td> <td><input type="checkbox"/></td> <td><input type="checkbox"/></td> <td><input type="checkbox"/></td> <td><input type="checkbox"/></td> <td><input type="checkbox"/></td> <td><input type="checkbox"/></td> </tr> <tr> <td>OFF</td> <td><input type="checkbox"/></td> <td><input type="checkbox"/></td> <td><input type="checkbox"/></td> <td><input type="checkbox"/></td> <td><input type="checkbox"/></td> <td><input type="checkbox"/></td> <td><input type="checkbox"/></td> <td><input type="checkbox"/></td> </tr> <tr> <td></td> <td>1</td> <td>2</td> <td>3</td> <td>4</td> <td>5</td> <td>6</td> <td>7</td> <td>8</td> </tr> </table>	ON	<input type="checkbox"/>	<input type="checkbox"/>	<input type="checkbox"/>	<input type="checkbox"/>	<input type="checkbox"/>	<input type="checkbox"/>	<input type="checkbox"/>	<input type="checkbox"/>	OFF	<input type="checkbox"/>	<input type="checkbox"/>	<input type="checkbox"/>	<input type="checkbox"/>	<input type="checkbox"/>	<input type="checkbox"/>	<input type="checkbox"/>	<input type="checkbox"/>		1	2	3	4	5	6	7	8																																																																																																																																																							
ON	<input type="checkbox"/>	<input type="checkbox"/>	<input type="checkbox"/>	<input type="checkbox"/>	<input type="checkbox"/>	<input type="checkbox"/>	<input type="checkbox"/>	<input type="checkbox"/>																																																																																																																																																																											
OFF	<input type="checkbox"/>	<input type="checkbox"/>	<input type="checkbox"/>	<input type="checkbox"/>	<input type="checkbox"/>	<input type="checkbox"/>	<input type="checkbox"/>	<input type="checkbox"/>																																																																																																																																																																											
	1	2	3	4	5	6	7	8																																																																																																																																																																											
140Y	<table border="1"> <tr> <td>ON</td> <td><input type="checkbox"/></td> <td><input type="checkbox"/></td> <td><input type="checkbox"/></td> <td><input type="checkbox"/></td> <td><input type="checkbox"/></td> <td><input type="checkbox"/></td> <td><input type="checkbox"/></td> <td><input type="checkbox"/></td> </tr> <tr> <td>OFF</td> <td><input type="checkbox"/></td> <td><input type="checkbox"/></td> <td><input type="checkbox"/></td> <td><input type="checkbox"/></td> <td><input type="checkbox"/></td> <td><input type="checkbox"/></td> <td><input type="checkbox"/></td> <td><input type="checkbox"/></td> </tr> <tr> <td></td> <td>1</td> <td>2</td> <td>3</td> <td>4</td> <td>5</td> <td>6</td> <td>7</td> <td>8</td> </tr> </table>	ON	<input type="checkbox"/>	<input type="checkbox"/>	<input type="checkbox"/>	<input type="checkbox"/>	<input type="checkbox"/>	<input type="checkbox"/>	<input type="checkbox"/>	<input type="checkbox"/>	OFF	<input type="checkbox"/>	<input type="checkbox"/>	<input type="checkbox"/>	<input type="checkbox"/>	<input type="checkbox"/>	<input type="checkbox"/>	<input type="checkbox"/>	<input type="checkbox"/>		1	2	3	4	5	6	7	8																																																																																																																																																							
ON	<input type="checkbox"/>	<input type="checkbox"/>	<input type="checkbox"/>	<input type="checkbox"/>	<input type="checkbox"/>	<input type="checkbox"/>	<input type="checkbox"/>	<input type="checkbox"/>																																																																																																																																																																											
OFF	<input type="checkbox"/>	<input type="checkbox"/>	<input type="checkbox"/>	<input type="checkbox"/>	<input type="checkbox"/>	<input type="checkbox"/>	<input type="checkbox"/>	<input type="checkbox"/>																																																																																																																																																																											
	1	2	3	4	5	6	7	8																																																																																																																																																																											
5																																																																																																																																																																																			
6																																																																																																																																																																																			
7																																																																																																																																																																																			
8																																																																																																																																																																																			

*2 'Power failure automatic recovery' can be set by either remote controller or this DIP SW. If one of them is set to ON, 'Auto recovery' activates. Please set "Auto recovery" basically by remote controller because not all units have DIP SW. Please refer to the indoor unit installation manual.

*3 SW7-1,2 are used for demand control. SW7-1,2 are effective only at the demand control. (Refer to the next page : Special function (b))

*4 Please do not use SW7-3 to 7-5 usually. Trouble might be caused by the usage condition.

*5 SW6-1 to 3: Function switch.

(2) Function of connector

Types	Connector	Function	Action by open/short operation		Effective timing
			Short	Open	
Connector	CN31	Emergency operation	Start	Normal	When power supply ON

(3) Special function

(a) Low-level sound priority mode (Local wiring)

By performing the following modification, operation noise of the outdoor unit can be reduced by about 3-4 dB.

The low noise mode will be activated when a commercially available timer or the contact input of an ON/OFF switch is added to the CNDM connector (option) on the control board of the outdoor unit.

• The ability varies according to the outdoor temperature and conditions, etc.

① Complete the circuit as shown when using the external input adapter (PAC-SC36NA-E). (Option)

② SW7-1 (Outdoor unit control board): OFF

③ SW1 ON: Low noise mode

SW1 OFF: Normal operation

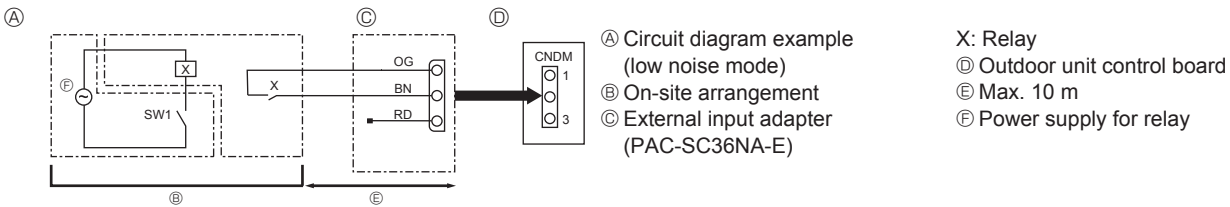

(b) On demand control (Local wiring)

By performing the following modification, energy consumption can be reduced to 0–100% of the normal consumption.

The demand function will be activated when a commercially available timer or the contact input of an ON/OFF switch is added to the CNDM connector (option) on the control board of the outdoor unit.

① Complete the circuit as shown when using the external input adapter (PAC-SC36NA-E). (Option)

② By setting SW7-1 on the control board of the outdoor unit, the energy consumption (compared to the normal consumption) can be limited as shown below.

	SW7-1	SW2	SW3	Energy consumption
Demand function	ON	OFF	OFF	100%
		ON	OFF	75%
		ON	ON	50%
		OFF	ON	0% (Stop)

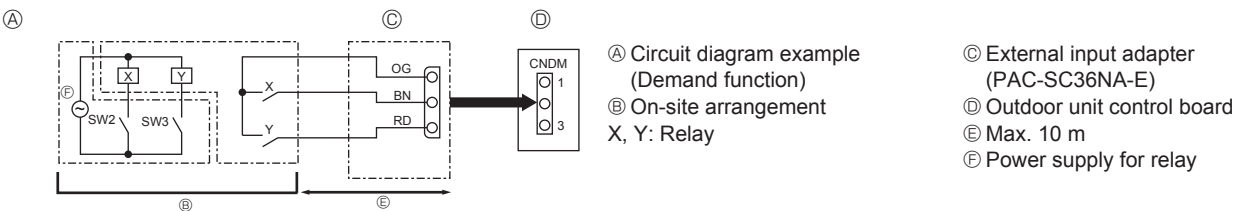

<Display function of inspection for outdoor unit>

The blinking patterns of both LED1 (green) and LED2 (red) indicate the types of abnormality when it occurs. Types of abnormality can be indicated in details by connecting an optional part 'A-Control Service Tool (PAC-SK52ST)' to connector CNM on outdoor controller board.

[Display]

(1)Normal condition

Unit condition	Outdoor controller board		A-Control Service Tool	
	LED1 (Green)	LED2 (Red)	Check code	Indication of the display
When the power is turned on	Lit	Lit	— ↔ —	Alternately blinking display
When unit stops	Lit	Not lit	00, etc.	Operation mode
When compressor is warming up	Lit	Not lit	08, etc.	
When unit operates	Lit	Lit	C5, etc.	

(2)Abnormal condition

Indication		Error			
Outdoor controller board		Contents	Check code*	Inspection method	Detailed reference page
LED1 (Green)	LED2 (Red)				
1 blinking	2 blinking	Connector (63H) is open.	F5	①Check if connector (63H) on the outdoor controller board is not disconnected. ②Check continuity of pressure switch (63H) by tester.	P.39
2 blinking	1 blinking	Miswiring of indoor/outdoor unit connecting wire, excessive number of indoor units (4 units or more)	—	①Check if indoor/outdoor connecting wire is connected correctly. ②Check if 4 or more indoor units are connected to outdoor unit. ③Check if noise entered into indoor/outdoor connecting wire or power supply. ④Re-check error by turning off power, and on again.	P.40 (EA)
		Miswiring of indoor/outdoor unit connecting wire (reverse wiring or disconnection)	—		P.40 (Eb)
		Startup time over	—		P.40 (EC)
2 blinking		Indoor/outdoor unit communication error (signal receiving error) is detected by indoor unit.	E6	①Check if indoor/outdoor connecting wire is connected correctly. ②Check if noise entered into indoor/outdoor connecting wire or power supply. ③Check if noise entered into indoor/outdoor controller board. ④Re-check error by turning off power, and on again.	P.46
		Indoor/outdoor unit communication error (transmitting error) is detected by indoor unit.	E7		P.46
		Indoor/outdoor unit communication error (signal receiving error) is detected by outdoor unit.	—		P.46 (E8)
		Indoor/outdoor unit communication error (transmitting error) is detected by outdoor unit.	—		P.47 (E9)
3 blinking		Remote controller signal receiving error is detected by remote controller.	E0	①Check if connecting wire of indoor unit or remote controller is connected correctly. ②Check if noise entered into transmission wire of remote controller. ③Re-check error by turning off power, and on again.	P.45
		Remote controller transmitting error is detected by remote controller.	E3		P.46
		Remote controller signal receiving error is detected by indoor unit.	E4		P.45
		Remote controller transmitting error is detected by indoor unit.	E5		P.46
4 blinking		Check code is not defined.	EF	①Check if remote controller is MA remote controller(PAR-21MAA). ②Check if noise entered into transmission wire of remote controller. ③Check if noise entered into indoor/outdoor connecting wire. ④Re-check error by turning off power, and on again.	P.47
			PL		①Check refrigerant pipes for disconnection or leakage. ②After the recovery of refrigerant, vacuum dry the whole refrigerant circuit. ③Refer to section "9-6 HOW TO CHECK THE PARTS". ④Check refrigerant circuit for operation.
5 blinking		Serial communication error <Communication between outdoor controller board and outdoor power board> <Communication between outdoor controller board and M-NET P.C. board>	Ed	①Check if connector (CN4) on outdoor controller board and outdoor power board is not disconnected. ②Check if there is poor connection of connector on outdoor controller board(CNMNT and CNVMNT). ③Check M-NET communication signal.	P.47
		Communication error of M-NET system	A0-A8		P.48- P.51

*Check code displayed on the remote controller.



Indication		Error					
Outdoor controller board		Contents	Check code*	Inspection method	Detailed reference page		
LED1 (Green)	LED2 (Red)						
3 blinking	1 blinking	Abnormality of comp. surface thermistor(TH33) and discharge temperature (TH4)	U2	①Check if stop valves are open. ②Check if connectors (TH4, TH33, LEV-A and LEV-B) on outdoor controller board are not disconnected.	P.41		
		Abnormality of superheat due to low discharge temperature	U7	③Check if unit is filled with specified amount of refrigerant. ④Measure resistance values among terminals on indoor valve and outdoor linear expansion valve using a tester.	P.42		
	2 blinking	Abnormal high pressure (High pressure switch 63H operated.)	U1	①Check if indoor/outdoor units have a short cycle on their air ducts. ②Check if connector (63H) on outdoor controller board is not disconnected. ③Check if heat exchanger and filter is not dirty. ④Measure resistance values among terminals on linear expansion valve using a tester.	P.41		
	3 blinking	Abnormality of outdoor fan motor rotational speed	U8	①Check the outdoor fan motor. ②Check if connector (TH3) on outdoor controller board is disconnected.	P.42		
	4 blinking		Compressor overcurrent breaking(Startup locked)	UF	①Check if stop valves are open. ②Check looseness, disconnection, and reverse connection of compressor wiring.	P.44	
			Compressor overcurrent breaking	UP	③Measure resistance values among terminals on compressor using a tester.	P.45	
			Abnormality of current sensor (P.B.)	UH	④Check if outdoor unit has a short cycle on its air duct.	P.44	
			Abnormality of power module	U6		P.42	
	5 blinking		Open/short of discharge thermistor (TH4) and comp. surface thermistor (TH33)	U3	①Check if connectors(TH3,TH4,TH6 ,TH7, TH8 and TH33) on outdoor controller board and connector (CN6) on outdoor power board are disconnected.	P.41	
			Open/short of outdoor thermistors (TH6, TH7 and TH8)	U4	②Measure resistance value of outdoor thermistors.	P.42	
	6 blinking		Abnormality of heatsink temperature	U5	①Check if indoor/outdoor units have a short cycle on their air ducts. ②Measure resistance value of outdoor thermistor(TH8).	P.42	
	7 blinking		Abnormality of voltage	U9	①Check looseness, disconnection, and reverse connection of compressor wiring. ②Measure resistance value among terminals on compressor using a tester. ③Check if power supply voltage decreases. ④Check the wiring of CN52C.	P.43 to P.44	
	4 blinking	1 blinking	Abnormality of room temperature thermistor (TH1)	P1	①Check if connectors (CN20, CN21, CN29 and CN44) on indoor controller board are not disconnected. ②Measure resistance value of indoor thermistors.		
Abnormality of pipe temperature thermistor /Liquid (TH2)			P2				
Abnormality of pipe temperature thermistor/Condenser-Evaporator			P9				
2 blinking			Abnormality of drain sensor (DS) Float switch(FS) connector open	P4	①Check if connector (CN31)(CN4F) on indoor controller board is not disconnected. ②Measure resistance value of indoor thermistors.		
			Indoor drain overflow protection	P5	③Measure resistance value among terminals on drain pump using a tester. ④Check if drain pump works. ⑤Check drain function.		
3 blinking			Freezing (cooling)	P6	①Check if indoor unit has a short cycle on its air duct. ②Check if heat exchanger and filter is not dirty. ③Measure resistance value on indoor and outdoor fan motors. ④Check if the inside of refrigerant piping is not clogged.		**
4 blinking			Abnormality of pipe temperature	P8	①Check if indoor thermistors(TH2 and TH5) are not disconnected from holder. ②Check if stop valve is open. ③Check reverse connection of extension pipe. (on plural units connection) ④Check if indoor/outdoor connecting wire is connected correctly. (on plural units connection)		

*Check code displayed on remote controller

**Refer to indoor unit's Service Manual.

<Outdoor unit operation monitor function>



[When optional part 'A-Control Service Tool (PAC-SK52ST)' is connected to outdoor controller board (CNM)]

Digital indicator LED1 displays 2 digit number or code to inform operation condition and the meaning of check code by controlling DIP SW2 on 'A-Control Service Tool'.

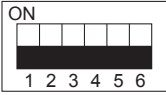
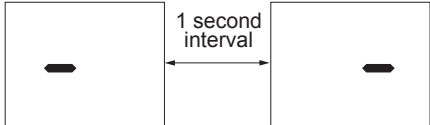
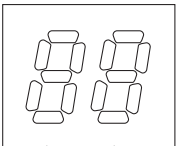
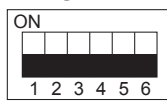

Operation indicator SW2 : Indicator change of self-diagnosis

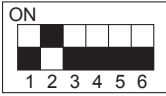
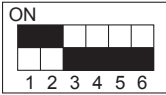
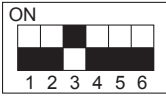
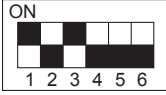
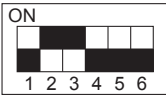
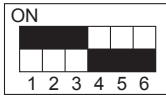
SW2 setting	Display detail	Explanation for display	Unit																																																																	
	<p><Digital indicator LED1 working details> (Be sure that the 1 to 6 in the SW2 are set to OFF.)</p> <p>(1) Display when the power supply ON When the power supply ON, blinking displays by turns. Wait for 4 minutes at the longest.</p> <p>(2) When the display lights (Normal operation)</p> <p>① Operation mode display.</p>																																																																			
	<p>(Lighting)</p>  <p>LED1</p>	 <p>SW2 (Initial setting)</p>																																																																		
	<p>The tens digit: Operation mode</p> <table border="1"> <thead> <tr> <th>Display</th> <th>Operation Model</th> </tr> </thead> <tbody> <tr> <td>O</td> <td>OFF / FAN</td> </tr> <tr> <td>C</td> <td>COOLING / DRY</td> </tr> <tr> <td>H</td> <td>HEATING</td> </tr> <tr> <td>d</td> <td>DEFROSTING</td> </tr> </tbody> </table>	Display	Operation Model	O	OFF / FAN	C	COOLING / DRY	H	HEATING	d	DEFROSTING	<p>The ones digit: Relay output</p> <table border="1"> <thead> <tr> <th>Display</th> <th>Warming-up Compressor</th> <th>Compressor</th> <th>4 - way valve</th> <th>Solenoid valve</th> </tr> </thead> <tbody> <tr> <td>0</td> <td>—</td> <td>—</td> <td>—</td> <td>—</td> </tr> <tr> <td>1</td> <td>—</td> <td>—</td> <td>—</td> <td>ON</td> </tr> <tr> <td>2</td> <td>—</td> <td>—</td> <td>ON</td> <td>—</td> </tr> <tr> <td>3</td> <td>—</td> <td>—</td> <td>ON</td> <td>ON</td> </tr> <tr> <td>4</td> <td>—</td> <td>ON</td> <td>—</td> <td>—</td> </tr> <tr> <td>5</td> <td>—</td> <td>ON</td> <td>—</td> <td>ON</td> </tr> <tr> <td>6</td> <td>—</td> <td>ON</td> <td>ON</td> <td>—</td> </tr> <tr> <td>7</td> <td>—</td> <td>ON</td> <td>ON</td> <td>ON</td> </tr> <tr> <td>8</td> <td>ON</td> <td>—</td> <td>—</td> <td>—</td> </tr> <tr> <td>A</td> <td>ON</td> <td>—</td> <td>ON</td> <td>—</td> </tr> </tbody> </table>	Display	Warming-up Compressor	Compressor	4 - way valve	Solenoid valve	0	—	—	—	—	1	—	—	—	ON	2	—	—	ON	—	3	—	—	ON	ON	4	—	ON	—	—	5	—	ON	—	ON	6	—	ON	ON	—	7	—	ON	ON	ON	8	ON	—	—	—	A	ON	—	ON	—	
Display	Operation Model																																																																			
O	OFF / FAN																																																																			
C	COOLING / DRY																																																																			
H	HEATING																																																																			
d	DEFROSTING																																																																			
Display	Warming-up Compressor	Compressor	4 - way valve	Solenoid valve																																																																
0	—	—	—	—																																																																
1	—	—	—	ON																																																																
2	—	—	ON	—																																																																
3	—	—	ON	ON																																																																
4	—	ON	—	—																																																																
5	—	ON	—	ON																																																																
6	—	ON	ON	—																																																																
7	—	ON	ON	ON																																																																
8	ON	—	—	—																																																																
A	ON	—	ON	—																																																																
	<p>② Display during error postponement Postponement code is displayed when compressor stops due to the work of protection device. Postponement code is displayed while error is being postponed.</p>																																																																			
	<p>(3) When the display blinks Inspection code is displayed when compressor stops due to the work of protection devices.</p>																																																																			
	<table border="1"> <thead> <tr> <th>Display</th> <th>Inspection unit</th> </tr> </thead> <tbody> <tr> <td>0</td> <td>Outdoor unit</td> </tr> <tr> <td>1</td> <td>Indoor unit 1</td> </tr> <tr> <td>2</td> <td>Indoor unit 2</td> </tr> <tr> <td>3</td> <td>Indoor unit 3</td> </tr> <tr> <td>4</td> <td>Indoor unit 4</td> </tr> </tbody> </table>	Display	Inspection unit	0	Outdoor unit	1	Indoor unit 1	2	Indoor unit 2	3	Indoor unit 3	4	Indoor unit 4	<table border="1"> <thead> <tr> <th>Display</th> <th>Contents to be inspected (During operation)</th> </tr> </thead> <tbody> <tr> <td>U1</td> <td>Abnormal high pressure (63H operated)</td> </tr> <tr> <td>U2</td> <td>Abnormal high discharging temperature and comp. surface, shortage of refrigerant</td> </tr> <tr> <td>U3</td> <td>Open/short circuit of discharge thermistor(TH4) and comp. surface thermistor(TH33)</td> </tr> <tr> <td>U4</td> <td>Open/short of outdoor unit thermistors(TH6, TH7 and TH8)</td> </tr> <tr> <td>U5</td> <td>Abnormal temperature of heatsink</td> </tr> <tr> <td>U6</td> <td>Abnormality of power module</td> </tr> <tr> <td>U7</td> <td>Abnormality of superheat due to low discharge temperature</td> </tr> <tr> <td>U8</td> <td>Abnormality in outdoor fan motor</td> </tr> <tr> <td>Ud</td> <td>Overheat protection</td> </tr> <tr> <td>UF</td> <td>Compressor overcurrent interruption (When Comp. locked)</td> </tr> <tr> <td>UH</td> <td>Current sensor error</td> </tr> <tr> <td>UL</td> <td>Abnormal low pressure</td> </tr> <tr> <td>UP</td> <td>Compressor overcurrent interruption</td> </tr> <tr> <td>PL</td> <td>Abnormality of refrigerant</td> </tr> <tr> <td>P1~P8</td> <td>Abnormality of indoor units</td> </tr> <tr> <td>A0~A7</td> <td>Communication error of M-NET system</td> </tr> </tbody> </table>	Display	Contents to be inspected (During operation)	U1	Abnormal high pressure (63H operated)	U2	Abnormal high discharging temperature and comp. surface, shortage of refrigerant	U3	Open/short circuit of discharge thermistor(TH4) and comp. surface thermistor(TH33)	U4	Open/short of outdoor unit thermistors(TH6, TH7 and TH8)	U5	Abnormal temperature of heatsink	U6	Abnormality of power module	U7	Abnormality of superheat due to low discharge temperature	U8	Abnormality in outdoor fan motor	Ud	Overheat protection	UF	Compressor overcurrent interruption (When Comp. locked)	UH	Current sensor error	UL	Abnormal low pressure	UP	Compressor overcurrent interruption	PL	Abnormality of refrigerant	P1~P8	Abnormality of indoor units	A0~A7	Communication error of M-NET system																				
Display	Inspection unit																																																																			
0	Outdoor unit																																																																			
1	Indoor unit 1																																																																			
2	Indoor unit 2																																																																			
3	Indoor unit 3																																																																			
4	Indoor unit 4																																																																			
Display	Contents to be inspected (During operation)																																																																			
U1	Abnormal high pressure (63H operated)																																																																			
U2	Abnormal high discharging temperature and comp. surface, shortage of refrigerant																																																																			
U3	Open/short circuit of discharge thermistor(TH4) and comp. surface thermistor(TH33)																																																																			
U4	Open/short of outdoor unit thermistors(TH6, TH7 and TH8)																																																																			
U5	Abnormal temperature of heatsink																																																																			
U6	Abnormality of power module																																																																			
U7	Abnormality of superheat due to low discharge temperature																																																																			
U8	Abnormality in outdoor fan motor																																																																			
Ud	Overheat protection																																																																			
UF	Compressor overcurrent interruption (When Comp. locked)																																																																			
UH	Current sensor error																																																																			
UL	Abnormal low pressure																																																																			
UP	Compressor overcurrent interruption																																																																			
PL	Abnormality of refrigerant																																																																			
P1~P8	Abnormality of indoor units																																																																			
A0~A7	Communication error of M-NET system																																																																			
	<table border="1"> <thead> <tr> <th>Display</th> <th>Contents to be inspected (When power is turned on)</th> </tr> </thead> <tbody> <tr> <td>F5</td> <td>63H connector(yellow) is open.</td> </tr> <tr> <td>E8</td> <td>Indoor/outdoor communication error (Signal receiving error) (Outdoor unit)</td> </tr> <tr> <td>E9</td> <td>Indoor/outdoor communication error (Transmitting error) (Outdoor unit)</td> </tr> <tr> <td>EA</td> <td>Miswiring of indoor/outdoor unit connecting wire, excessive number of indoor units (4 units or more)</td> </tr> <tr> <td>Eb</td> <td>Miswiring of indoor/outdoor unit connecting wire(converse wiring or disconnection)</td> </tr> <tr> <td>EC</td> <td>Startup time over</td> </tr> <tr> <td>E0~E7</td> <td>Communication error except for outdoor unit</td> </tr> </tbody> </table>	Display	Contents to be inspected (When power is turned on)	F5	63H connector(yellow) is open.	E8	Indoor/outdoor communication error (Signal receiving error) (Outdoor unit)	E9	Indoor/outdoor communication error (Transmitting error) (Outdoor unit)	EA	Miswiring of indoor/outdoor unit connecting wire, excessive number of indoor units (4 units or more)	Eb	Miswiring of indoor/outdoor unit connecting wire(converse wiring or disconnection)	EC	Startup time over	E0~E7	Communication error except for outdoor unit																																																			
Display	Contents to be inspected (When power is turned on)																																																																			
F5	63H connector(yellow) is open.																																																																			
E8	Indoor/outdoor communication error (Signal receiving error) (Outdoor unit)																																																																			
E9	Indoor/outdoor communication error (Transmitting error) (Outdoor unit)																																																																			
EA	Miswiring of indoor/outdoor unit connecting wire, excessive number of indoor units (4 units or more)																																																																			
Eb	Miswiring of indoor/outdoor unit connecting wire(converse wiring or disconnection)																																																																			
EC	Startup time over																																																																			
E0~E7	Communication error except for outdoor unit																																																																			

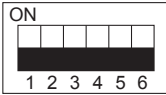

The black square (■) indicates a switch position.

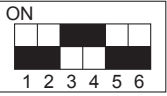
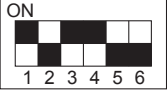
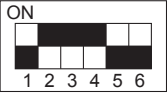
SW2 setting	Display detail	Explanation for display	Unit
	Discharge temperature (TH4) -20 to 217	-20 to 217 (When the discharge thermistor detects 100 °C or more, hundreds digit, tens digit and ones digit are displayed by turns.) (Example) When 105 °C; <div style="text-align: center;"> 0.5 s 0.5 s 2 s □1 →05 →□□ ↑ </div>	°C
	Output step of outdoor FAN 0 to 16	0 to 16	Step
	The number of ON / OFF times of compressor 0 to 9999	0 to 9999 (When the number of times is 100 or more, hundreds digit, tens digit and ones digit are displayed by turns.) (Example) When 42500 times (425 ×100 times); <div style="text-align: center;"> 0.5 s 0.5 s 2 s □4 →25 →□□ ↑ </div>	100 times
	Compressor integrating operation times 0 to 9999	0 to 9999 (When it is 100 hours or more, hundreds digit, tens digit and ones digit are displayed by turns.) (Example) When 2450 hours (245 ×10 hours); <div style="text-align: center;"> 0.5 s 0.5 s 2 s □2 →45 →□□ ↑ </div>	10 hours
	Compressor operating current 0 to 50	0 to 50 Note: Omit the figures after the decimal fractions.	A
	Compressor operating frequency 0 to 255	0 to 9999 (When it is 100 Hz or more, hundreds digit, tens digit and ones digit are displayed by turns.) (Example) When 125 Hz; <div style="text-align: center;"> 0.5 s 0.5 s 2 s 12 →50 →□□ ↑ </div>	0.1 Hz
	Error postponement code history (1) of outdoor unit	Postponement code display Blinking: During postponement Lighting: Cancellation of postponement "00" is displayed in case of no postponement.	Code display
	Operation mode on error occurring	Operation mode of when operation stops due to error is displayed by setting SW2 like below. (SW2) 	Code display

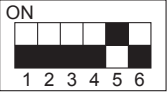

The black square (■) indicates a switch position.

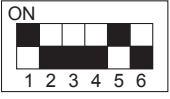
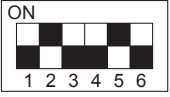
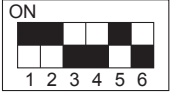
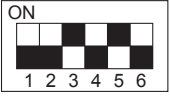
SW2 setting	Display detail	Explanation for display	Unit
	Discharge temperature (TH4) on error occurring -20 to 217	-20 to 217 (When the temperature is 100 °C or more, the hundreds digit, tens digit and ones digit are displayed by turns.) (Example) When 130 °C; 0.5 s 0.5 s 2 s □1 →30 →□□ ↑—————↓	°C
	Compressor operating current on error occurring 0 to 50	0 to 50	A
	Error history (1) (latest) Alternate display of abnormal unit number and code	When no error history, “ 0 ” and “ - ” are displayed by turns.	Code display
	Error history (2) Alternate display of error unit number and code	When no error history, “ 0 ” and “ - ” are displayed by turns.	Code display
	Thermostat ON time 0 to 999	0 to 999 (When it is 100 minutes or more, the hundreds digit, tens digit and ones digit are displayed by turns.) (Example) When 245 minutes; 0.5 s 0.5 s 2 s □2 →45 →□□ ↑—————↓	Minute
	Test run elapsed time 0 to 120	0 to 120 (When it is 100 minutes or more, the hundreds digit, tens digit and ones digit are displayed by turns.) (Example) When 105 minutes; 0.5 s 0.5 s 2 s □1 →05 →□□ ↑—————↓	Minute

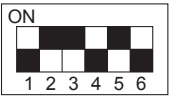
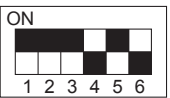
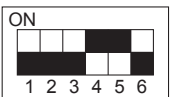
The black square (■) indicates a switch position.

SW2 setting	Display detail	Explanation for display	Unit										
	The number of connected indoor units	0 to 4 (The number of connected indoor units are displayed.)	Unit										
	Capacity setting display	Displayed as an outdoor capacity code. <table border="1" data-bbox="751 510 1002 631"> <thead> <tr> <th>Capacity</th> <th>Code</th> </tr> </thead> <tbody> <tr> <td>M100</td> <td>20</td> </tr> <tr> <td>M125</td> <td>25</td> </tr> <tr> <td>M140</td> <td>28</td> </tr> </tbody> </table>	Capacity	Code	M100	20	M125	25	M140	28	Code display		
Capacity	Code												
M100	20												
M125	25												
M140	28												
	Outdoor unit setting information	<ul style="list-style-type: none"> The tens digit (Total display for applied setting) <table border="1" data-bbox="743 759 1305 853"> <thead> <tr> <th>Setting details</th> <th>Display details</th> </tr> </thead> <tbody> <tr> <td>H·P/Cooling only</td> <td>0: H·P 1: Cooling only</td> </tr> <tr> <td>Single phase/3 phase</td> <td>0: Single phase 2: 3 phase</td> </tr> </tbody> </table> The ones digit <table border="1" data-bbox="743 920 1305 981"> <thead> <tr> <th>Setting details</th> <th>Display details</th> </tr> </thead> <tbody> <tr> <td>Defrosting switch</td> <td>0: Normal 1: For high humidity</td> </tr> </tbody> </table> <p>(Example) When heat pump, 3 phase and defrosting (normal) are set up, "20" is displayed.</p>	Setting details	Display details	H·P/Cooling only	0: H·P 1: Cooling only	Single phase/3 phase	0: Single phase 2: 3 phase	Setting details	Display details	Defrosting switch	0: Normal 1: For high humidity	Code display
Setting details	Display details												
H·P/Cooling only	0: H·P 1: Cooling only												
Single phase/3 phase	0: Single phase 2: 3 phase												
Setting details	Display details												
Defrosting switch	0: Normal 1: For high humidity												
	Indoor pipe temperature / Liquid (TH2(1)) Indoor 1 - 39 to 88	- 39 to 88 (When the temperature is 0°C or less, "-" and temperature are displayed by turns.)	°C										
	Indoor pipe temperature / Cond. / Eva. (TH5(1)) Indoor 1 - 39 to 88	- 39 to 88 (When the temperature is 0°C or less, "-" and temperature are displayed by turns.)	°C										
	Indoor pipe temperature / Liquid (TH2(2)) Indoor 2 - 39 to 88	- 39 to 88 (When the temperature is 0°C or less, "-" and temperature are displayed by turns.)	°C										
	Indoor pipe temperature / Cond. / Eva. (TH5(2)) Indoor 2 - 39 to 88	- 39 to 88 (When the temperature is 0°C or less, "-" and temperature are displayed by turns.)	°C										
	Indoor room temperature (TH1) 8 to 39	8 to 39	°C										

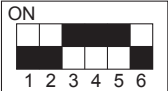

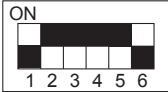
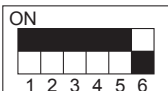
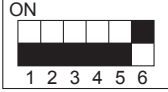
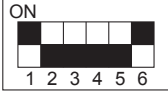
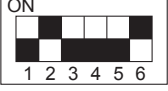
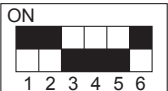
The black square (■) indicates a switch position.

SW2 setting	Display detail	Explanation for display	Unit																		
	Indoor setting temperature 17 to 30	17 to 30	°C																		
	Outdoor 2-phase pipe (TH6) - 39 to 88	- 39 to 88 (When the temperature is 0°C or less, “-” and temperature are displayed by turns.)	°C																		
	Outdoor ambient temperature (TH7) - 39 to 88	- 39 to 88 (When the temperature is 0°C or less, “-” and temperature are displayed by turns.)	°C																		
	Outdoor heatsink temperature (TH8) - 40 to 200	- 40 to 200 (When the temperature is 0°C or less, “-” and temperature are displayed by turns.) (When the thermistor detects 100°C or more, hundreds digit, tens digit and ones digit are displayed by turns.)	°C																		
	Discharge superheat SHd 0 to 255 [SHd = TH4-TH6]	0 to 255 (When the temperature is 100 °C or more, hundreds digit, tens digit and ones digit are displayed by turns.)	°C																		
	Number of defrost cycles 0 to FFFE	0 to FFFE (in hexadecimal notation) (When more than FF in hex (255 in decimal), the number is displayed in order of 16 ³ 's and 16 ² 's, and 16 ¹ 's and 16 ⁰ 's places. (Example) When 5000 cycles; <div style="text-align: center;"> <table style="margin: auto;"> <tr> <td style="padding: 0 10px;">0.5 s</td> <td style="padding: 0 10px;">0.5 s</td> <td style="padding: 0 10px;">2 s</td> </tr> <tr> <td style="text-align: center;">□9</td> <td style="text-align: center;">→ C4</td> <td style="text-align: center;">→ □□</td> </tr> <tr> <td style="text-align: center;">↑</td> <td colspan="2" style="text-align: center;">└──────────┘</td> </tr> </table> </div>	0.5 s	0.5 s	2 s	□9	→ C4	→ □□	↑	└──────────┘		2 cycles									
0.5 s	0.5 s	2 s																			
□9	→ C4	→ □□																			
↑	└──────────┘																				
	Input current of outdoor unit	0 to 500 (When it is 100 or more, hundreds digit, tens digit and ones digit are displayed by turns.)	0.1 A																		
	LEV-B opening pulse	0 to 480 (When it is 100 pulse or more, hundreds digit, tens digit and ones digit are displayed by turns.)	Pulse																		
	U9 error detail history (latest)	<table border="1" style="width: 100%; border-collapse: collapse;"> <thead> <tr> <th>Description</th> <th>Display</th> </tr> </thead> <tbody> <tr> <td>Normal</td> <td>00</td> </tr> <tr> <td>Overvoltage error</td> <td>01</td> </tr> <tr> <td>Undervoltage error</td> <td>02</td> </tr> <tr> <td>Input current sensor error</td> <td>04</td> </tr> <tr> <td>L1-phase open error</td> <td>08</td> </tr> <tr> <td>Abnormal power synchronous signal</td> <td>10</td> </tr> <tr> <td>PFC/error (PUZ-M-VKA) (Overvoltage/Undervoltage/Overcurrent)</td> <td>20</td> </tr> <tr> <td>PFC/IGBT error (PUZ-M-VKA) Undervoltage</td> <td>20</td> </tr> </tbody> </table> <p>Display examples for multiple errors: Overvoltage (01) + Undervoltage (02) = 03 Undervoltage (02) + Power-sync signal error (08) = 0A L1 phase open error (04) + PFC error (10) = 14</p>	Description	Display	Normal	00	Overvoltage error	01	Undervoltage error	02	Input current sensor error	04	L1-phase open error	08	Abnormal power synchronous signal	10	PFC/error (PUZ-M-VKA) (Overvoltage/Undervoltage/Overcurrent)	20	PFC/IGBT error (PUZ-M-VKA) Undervoltage	20	Code display
Description	Display																				
Normal	00																				
Overvoltage error	01																				
Undervoltage error	02																				
Input current sensor error	04																				
L1-phase open error	08																				
Abnormal power synchronous signal	10																				
PFC/error (PUZ-M-VKA) (Overvoltage/Undervoltage/Overcurrent)	20																				
PFC/IGBT error (PUZ-M-VKA) Undervoltage	20																				

The black square (■) indicates a switch position.

SW2 setting	Display detail	Explanation for display	Unit
	DC bus voltage 0 to 500 (PUZ-M·VKA) 0 to 1000 (PUZ-M·YKA)	0 to 500 (PUZ-M·VKA) 0 to 1000 (PUZ-M·YKA) (When it is 100 V or more, hundreds digit, tens digit and ones digit are displayed by turns.)	V
	Capacity save 0 to 100 When air conditioner is connected to M-NET and capacity save mode is demanded, "0" to "100" is displayed. [When there is no setting of capacity save "100" is displayed.]	0 to 100 (When the capacity is 100% hundreds digit, tens digit and ones digit are displayed by turns.) (Example) When 100%; 0.5 s 0.5 s 2 s □1 → 00 → □□	%
	Error postponement code history (2) of outdoor unit	Postponement code display Blinking: During postponement Lighting: Cancellation of postponement "00" is displayed in case of no postponement.	Code display
	Error postponement code history (3) of outdoor unit	Postponement code display Blinking: During postponement Lighting: Cancellation of postponement "00" is displayed in case of no postponement.	Code display
	Error history (3) (Oldest) Alternate display of abnormal unit number and code.	When no error history, "0" and "--" are displayed by turns.	Code display
	Error thermistor display [When there is no error thermistor, "-" is displayed.]	6: Outdoor 2-phase pipe (TH6) 7: Outdoor ambient temperature (TH7) 8: Outdoor heatsink (TH8)	Code display
	Operation frequency on error occurring 0 to 255	0 to 255 (When it is 100Hz or more, hundreds digit, tens digit and ones digit are displayed by turns.) (Example) When 125 Hz; 0.5 s 0.5 s 2 s □1 → 25 → □□	Hz
	Fan step on error occurring 0 to 16	0 to 16	Step
	Indoor room temperature (TH1) on error occurring 8 to 39	8 to 39	°C

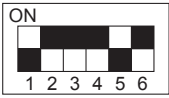
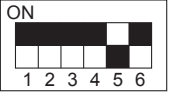
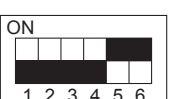
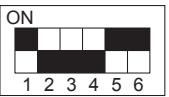
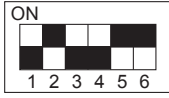
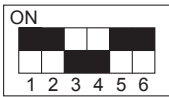
The black square (■) indicates a switch position.

SW2 setting	Display detail	Explanation for display	Unit
	Indoor pipe temperature / Liquid (TH2) on error occurring - 39 to 88	- 39 to 88 (When the temperature is 0 °C or less, “-” and temperature are displayed by turns.) (Example) When -15 °C; 0.5 s 0.5 s 2 s -□ → 15 → □□ ↑ └──────────┘	°C
	Indoor pipe temperature / Cond./ Eva. (TH5) on error occurring - 39 to 88	- 39 to 88 (When the temperature is 0 °C or less, “-” and temperature are displayed by turns.) (Example) When -15 °C; 0.5 s 0.5 s 2 s -□ → 15 → □□ ↑ └──────────┘	°C
	Outdoor 2-phase pipe (TH6) on error occurring - 39 to 88	- 39 to 88 (When the temperature is 0 °C or less, “-” and temperature are displayed by turns.) (Example) When -15 °C; 0.5 s 0.5 s 2 s -□ → 15 → □□ ↑ └──────────┘	°C
	Outdoor ambient temperature (TH7) on error occurring - 39 to 88	- 39 to 88 (When the temperature is 0 °C or less, “-” and temperature are displayed by turns.) (Example) When -15 °C; 0.5 s 0.5 s 2 s -□ → 15 → □□ ↑ └──────────┘	°C
	Outdoor heatsink temperature (TH8) on error occurring - 40 to 200	- 40 to 200 (When the temperature is 0°C or less, “-” and temperature are displayed by turns.) (When the temperature is 100°C or more, hundreds digit, tens digit and ones digit are displayed by turns.)	°C
	Discharge superheat on error occurring SHd 0 to 255 [SHd = TH4 - TH6]	0 to 255 (When the temperature is 100 °C or more, hundreds digit, tens digit and ones digit are displayed by turns.) (Example) When 150 °C; 0.5 s 0.5 s 2 s □1 → 50 → □□ ↑ └──────────┘	°C
	Thermo-on time until error stops 0 to 999	0 to 999 (When it is 100 minutes or more, hundreds digit, tens digit and ones digit are displayed by turns.) (Example) When 415 minutes; 0.5 s 0.5 s 2 s □4 → 15 → □□ ↑ └──────────┘	Minute

The black square (■) indicates a switch position.

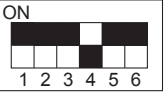
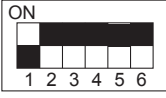
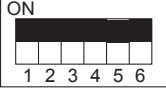
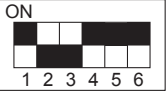
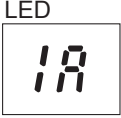
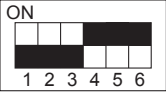
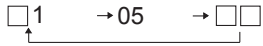
SW2 setting	Display detail	Explanation for display	Unit																
	Indoor pipe temperature / Liquid (TH2 (3)) Indoor 3 - 39 to 88	- 39 to 88 (When the temperature is 0 °C or less, “-” and temperature are displayed by turns.)	°C																
	Indoor pipe temperature / Cond./ Eva. (TH5 (3)) Indoor 3 - 39 to 88	- 39 to 88 (When the temperature is 0 °C or less, “-” and temperature are displayed by turns.) When there is no indoor unit, “00” is displayed.	°C																
	Indoor pipe temperature / Liquid (TH2 (4)) Indoor 4 - 39 to 88	- 39 to 88 (When the temperature is 0°C or less, “-” and temperature are displayed by turns.)	°C																
	Indoor pipe temperature / Cond. / Eva (TH5 (4)) Indoor 4 - 39 to 88	- 39 to 88 (When the temperature is 0°C or less, “-” and temperature are displayed by turns.) When there is no indoor unit, “00” is displayed.	°C																
	Controlling status of compressor operating frequency	<p>The following code will be a help to know the operating status of unit.</p> <ul style="list-style-type: none"> •The tens digit <table border="1" data-bbox="756 1149 1228 1240"> <thead> <tr> <th>Display</th> <th>Compressor operating frequency control</th> </tr> </thead> <tbody> <tr> <td>1</td> <td>Primary current control</td> </tr> <tr> <td>2</td> <td>Secondary current control</td> </tr> </tbody> </table> <ul style="list-style-type: none"> •The ones digit (In this digit, the total number of activated control is displayed.) <table border="1" data-bbox="756 1317 1228 1559"> <thead> <tr> <th>Display</th> <th>Compressor operating frequency control</th> </tr> </thead> <tbody> <tr> <td>1</td> <td>Preventive control for excessive temperature rise of discharge temperature</td> </tr> <tr> <td>2</td> <td>Preventive control for excessive temperature rise of condensing temperature</td> </tr> <tr> <td>4</td> <td>Frosting preventing control</td> </tr> <tr> <td>8</td> <td>Preventive control for excessive temperature rise of heatsink</td> </tr> </tbody> </table> <p>(Example) The following controls are activated.</p> <ul style="list-style-type: none"> • Primary current control • Preventive control for excessive temperature rise of condensing temperature • Preventive control for excessive temperature rise of heatsink 	Display	Compressor operating frequency control	1	Primary current control	2	Secondary current control	Display	Compressor operating frequency control	1	Preventive control for excessive temperature rise of discharge temperature	2	Preventive control for excessive temperature rise of condensing temperature	4	Frosting preventing control	8	Preventive control for excessive temperature rise of heatsink	Code display
Display	Compressor operating frequency control																		
1	Primary current control																		
2	Secondary current control																		
Display	Compressor operating frequency control																		
1	Preventive control for excessive temperature rise of discharge temperature																		
2	Preventive control for excessive temperature rise of condensing temperature																		
4	Frosting preventing control																		
8	Preventive control for excessive temperature rise of heatsink																		
	Comp. surface temperature (TH33) - 52 to 221	- 52 to 221 (When the comp. surface thermistor detects 100 °C or more, hundreds digit, tens digit and ones digit are displayed by turns.) (Example) When 105 °C; <div style="display: flex; justify-content: space-around; align-items: center;"> 0.5 s 0.5 s 2 s </div> 	°C																

10-1. UNIT FUNCTION SETTING BY THE REMOTE CONTROLLER

Each function can be set as necessary using the remote controller. The setting of function for each unit can only be done by the remote controller. Select function available from the <Table 1>.

<Table 1> Function selections

(1) Functions available when setting the unit number to 00 (Select 00 referring to ④ setting the indoor unit number.)

Function	Settings	Mode No.	Setting No.	● : Initial setting (when sent from the factory)	Remarks
Power failure automatic recovery	OFF	01	1		The setting is applied to all the units in the same refrigerant system.
	ON		2	●	
Indoor temperature detecting	Average data from each indoor unit	02	1	●	
	Data from the indoor unit with remote controller		2		
	Data from main remote controller*		3		
LOSSNAY connectivity	Not supported	03	1	●	
	Supported (Indoor unit does not intake outdoor air through LOSSNAY)		2		
	Supported (Indoor unit intakes outdoor air through LOSSNAY)		3		
Power supply voltage	240 V	04	1		
	220 V, 230 V		2	●	
Frost prevention temperature	2°C (Normal)	15	1	●	
	3°C		2		
Humidifier control	When the compressor operates, the humidifier also operates.	16	1	●	
	When the fan operates, the humidifier also operates.		2		

*The function is available only when the wired remote controller is used. The functions is not available for floor standing models.

Meaning of "Function setting"

mode02:indoor temperature detecting

No	Indoor temperature(ta)=	Diagram	Initial setting	ta=(A+B)/2	ta=A	ta=B	ta=C
No.1	Average data of the sensor on all the indoor units		Initial setting	ta=(A+B)/2	ta=A	ta=B	ta=C
No.2	The data of the sensor on the indoor unit that connected with remote controller		Initial setting	ta=A	ta=A	ta=B	ta=C
No.3	The data of the sensor on main remote controller.		Initial setting	ta=C	ta=C	ta=C	ta=C

(2) Functions available when setting the unit number to 01-02 or AL (07 in case of wireless remote controller)
Refer to the service manual that comes with each indoor unit.

10-1-1. Selecting functions using the wired remote controller <PAR-3xMAA ("x" represents 0 or later)>

<Service menu>

Maintenance password is required

① Select "Service" from the Main menu, and press the  button.

*At the main display, the menu button and select "Service" to make the maintenance setting.

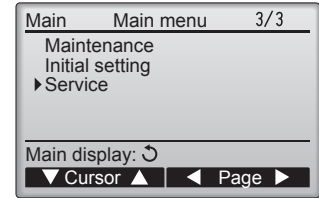

② When the Service menu is selected, a window will appear asking for the password.

To enter the current maintenance password (4 numerical digits), move the cursor to the digit you want to change with the **F1** or **F2** button.



Set each number (0 through 9) with the **F3** or **F4** button.



Then, press the  button.

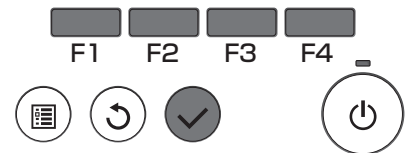
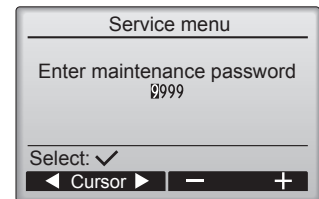

Note: The initial maintenance password is "9999". Change the default password as necessary to prevent unauthorized access. Have the password available for those who need it.

: If you forget your maintenance password, you can initialize the password to the default password "9999" by pressing and holding the **F1 and **F2** buttons simultaneously for three seconds on the maintenance password setting screen.**

③ If the password matches, the Service menu will appear.

The type of menu that appears depends on the connected indoor units' type.

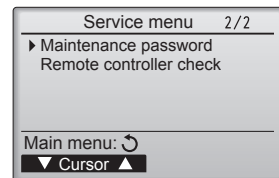
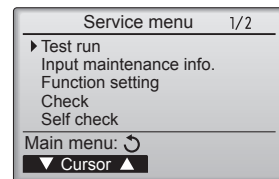



Note: Air conditioning units may need to be stopped to make certain settings. There may be some settings that cannot be made when the system is centrally controlled.



A screen will appear that indicates the setting has been saved.



Navigating through the screens

- To go back to the Service menu  button
- To return to the previous screen.....  button

<Function setting>

- ① Select "Service" from the Main menu, and press the  button.



Select "Function setting" with the **[F1]** or **[F2]** button, and press the  button.

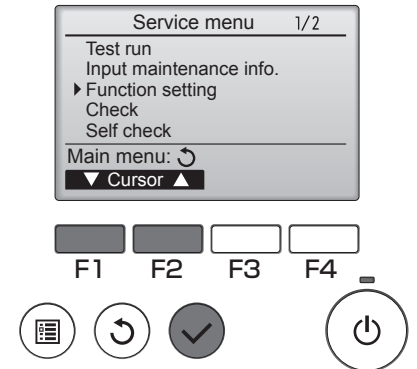

- ② Set the indoor unit refrigerant addresses and unit numbers with the **[F1]** through **[F4]** buttons, and then press the  button to confirm the current setting.

<Checking the indoor unit No.>

When the  button is pressed, the target indoor unit will start fan operation. If the unit is common or when running all units, all indoor units for the selected refrigerant address will start fan operation.

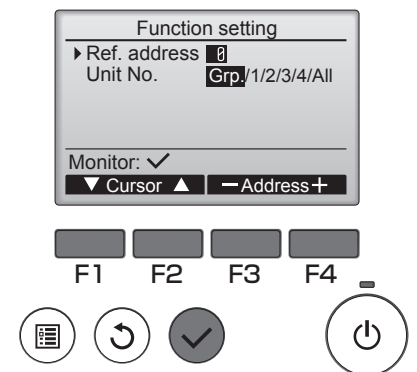

- ③ When data collection from the indoor units is completed, the current settings appears highlighted. Non-highlighted items indicate that no function settings are made. Screen appearance varies depending on the "Unit No." setting.

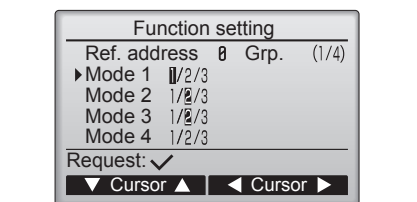

- ④ Use the **[F1]** or **[F2]** button to move the cursor to select the mode number, and change the setting number with the **[F3]** or **[F4]** button.

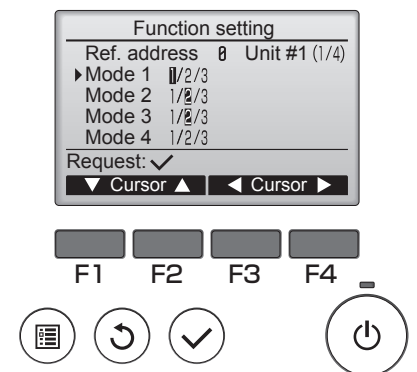

- ⑤ When the settings are completed, press the  button to send the setting data from the remote controller to the indoor units. When the transmission is successfully completed, the screen will return to the Function setting screen.

Notes:

1. Make the above settings only on Mr. Slim units as necessary.
2. The above function settings are not available for the CITY MULTI units.
3. Table 1 summarizes the setting options for each mode number. Refer to the indoor unit Installation Manual for the detailed information about initial settings, mode numbers, and setting numbers for the indoor units.
4. Be sure to write down the settings for all functions if any of the initial settings has been changed after the completion of installation work.

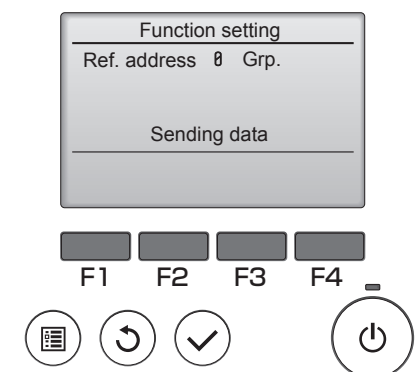

10-1-2. Selecting functions using the wired remote controller <PAR-21MAA>

First, try to familiarize yourself with the flow of the function selection procedure. In this section, an example of setting the room temperature detection position is given.

For actual operations, refer to steps ① to ⑩.

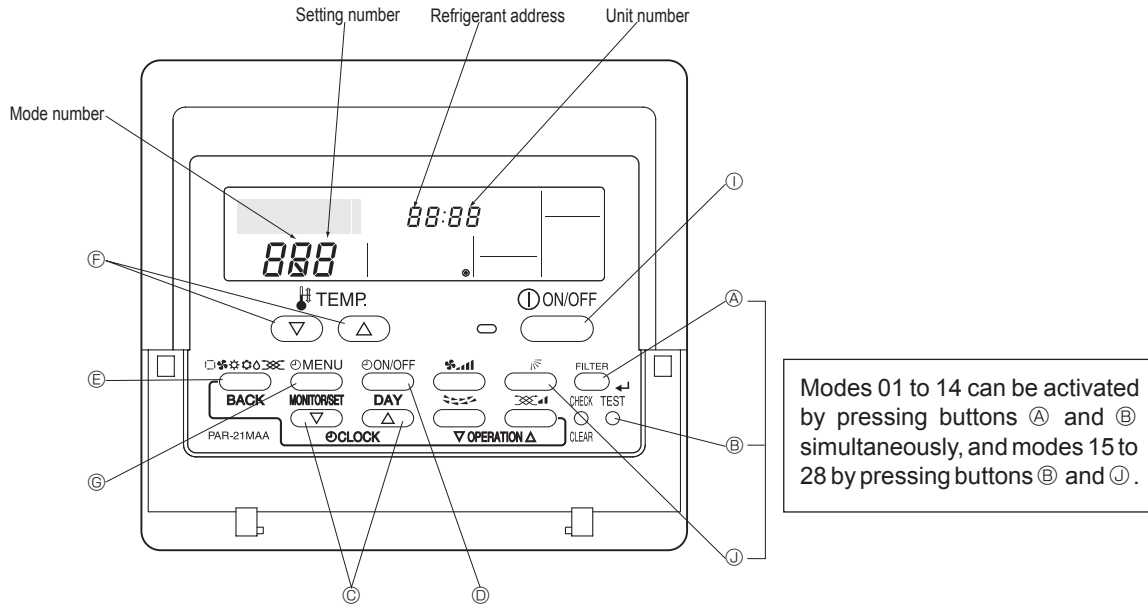

Selecting functions using the wired remote controller

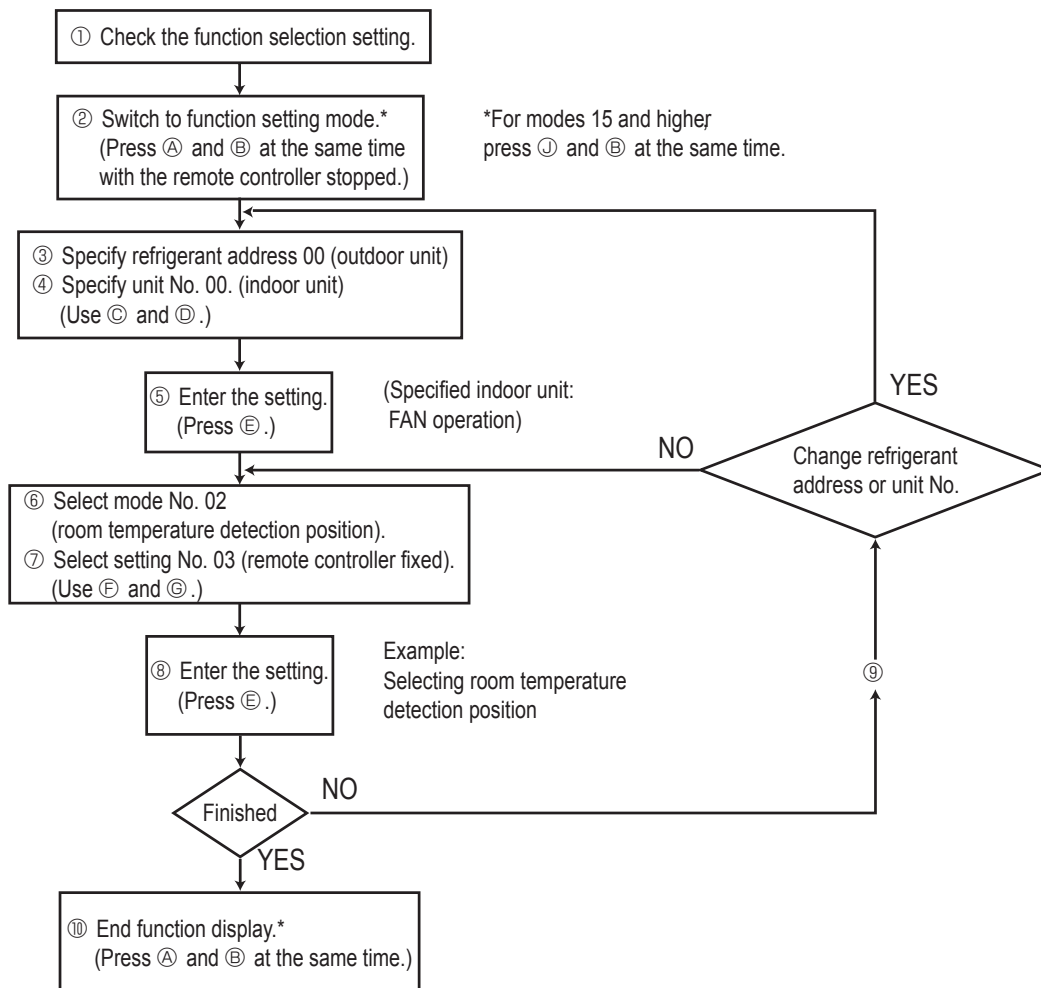

The above procedure must be carried out only if changes are necessary.

[Operating Procedure]

① Check the setting items provided by function selection.

If settings for a mode are changed by function selection, the functions of that mode will be changed accordingly. Check all the current settings according to steps ② to ⑦, fill in the "Check" column in Table 1, and then change them as necessary. For initial settings, refer to the indoor unit's installation manual.

② Switch off the remote controller.

Hold down the **FILTER** (mode is 15 to 28) and **TEST** buttons simultaneously for at least 2 seconds. **FUNCTION SELECTION** will start to blink, and then the remote controller's display content will change as shown below.

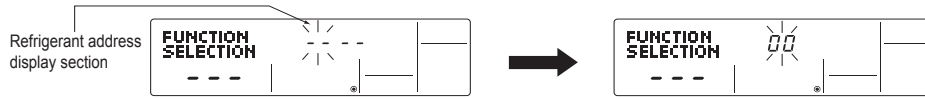

If the unit stops after **FUNCTION SELECTION** blinked for 2 seconds or "88" blinks in the room temperature display area for 2 seconds, a transmission error may have occurred. Check to see if there are any sources of noise or interference near the transmission path.

Note: If you have made operational mistakes during this procedure, exit function selection (see step ⑩), and then restart from step ②.

④ Set the indoor unit number.

Press the **ON/OFF** button so that "--" blinks in the unit number display area.



Press the **CLOCK** buttons to select the unit number of the indoor unit for which you want to perform function selection. The unit number changes to "00", "01", "02", "03", "04" and "AL" each time a button is pressed.

To set modes 01 to 06 or 15 to 22 select unit number "00".
To set modes 07 to 14 or 23 to 28 carry out as follows:

- To set each indoor unit individually, select "01" to "04".
- To set all the indoor units collectively, select "AL".

⑤ Confirm the refrigerant address and unit number.

Press the **MODE** button to confirm the refrigerant address and unit number. After a while, "--" will start to blink in the mode number display area.



"88" will blink in the room temperature display area if the selected refrigerant address does not exist in the system. Furthermore, if "F" appears and blinks in the unit number display area and the refrigerant address display area also blinks, there are no units that correspond to the selected unit number. In this case, the refrigerant address and unit number may be incorrect, so repeat steps ② and ③ to set the correct ones.

When the refrigerant address and unit number are confirmed by pressing the **MODE** button, the corresponding indoor unit will start fan operation. This helps you find the location of the indoor unit for which you want to perform function selection. However, if "00" or "AL" is selected as the unit number, all the indoor units corresponding to the specified refrigerant address will start fan operation.

Example) When the refrigerant address is set to 00 and the unit number is 02.

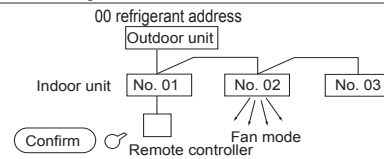

When grouping different refrigerant systems, if an indoor unit other than the one to which the refrigerant address has been set performs fan operation, there may be another refrigerant address that is the same as the specified one. In this case, check the DIP switch of the outdoor unit to see whether such a refrigerant address exists.

⑥ Select the mode number.

Press the **TEMP** buttons to set the desired mode number. (Only the selectable mode numbers can be selected.)

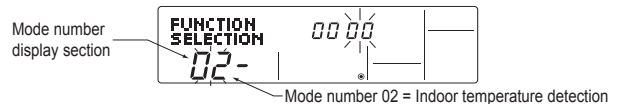

⑦ Select the setting content for the selected mode.

Press the **MENU** button. The currently selected setting number will blink, so check the currently set content.

Press the **TEMP** buttons to select the desired setting number.

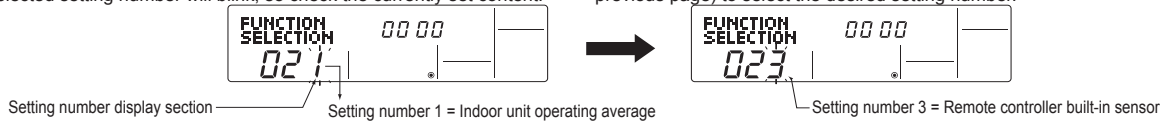

⑧ Register the settings you have made in steps ③ to ⑦.

Press the **MODE** button. The mode number and setting number will start to blink and registration starts.

The mode number and setting number will stop blinking and remain lit, indicating the end of registration.



If "--" is displayed for both the mode number and setting number and "88" blinks in the room temperature display area, a transmission error may have occurred. Check to see if there are any sources of noise or interference near the transmission path.

⑨ To make additional settings in the FUNCTION SELECTION screen, repeat the steps ③ through ⑧.

Note. After setting the modes 07 through 14, the modes 23 through 28 cannot be set continuously, or vice versa. In this case, after completing the settings for the modes 07 through 14 or 23 through 28, go to the step 10 to finish setting, and restart setting from the step 1. At this point, wait for 30 seconds or more before restarting setting. Otherwise, the temperature may indicate "88".

⑩ Complete function selection.

Hold down the **FILTER** and **TEST** buttons simultaneously for at least 2 seconds. After a while, the function selection screen will disappear and the air conditioner OFF screen will reappear.



Do not operate the remote controller for at least 30 seconds after completing function selection. (No operations will be accepted even if they are made.)

Note:

If a function of an indoor unit is changed by function selection after installation is complete, make sure that a "O" mark, etc., is given in the "Check" column of Table 1 to indicate the change.

10-1-3. Selecting functions using the wireless remote controller (Type C)

Functions can be selected with the wireless remote controller. Function selection using wireless remote controller is available only for refrigerant system with wireless function. Refrigerant address cannot be specified by the wireless remote controller.

[Flow of function selection procedure]

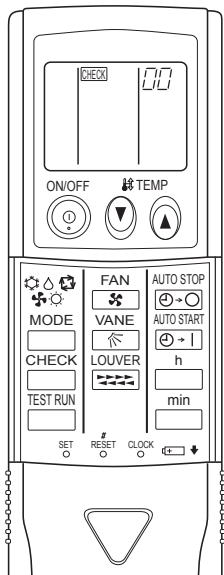

The flow of the function selection procedure is shown below. This example shows how to turn off the function that raises the set temperature by 4 degrees during HEAT operation. (Mode 24: 2)
The procedure is given after the flow chart.

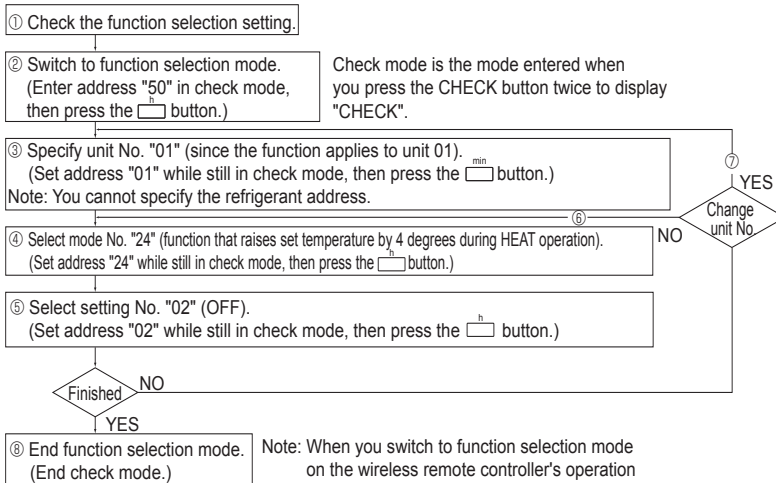

[Operating instructions]

- ① Check the function settings.
- ② Press the **CHECK** button twice continuously. → **CHECK** is lit and "00" blinks.
Press the temp **TEMP** button once to set "50". Direct the wireless remote controller toward the receiver of the indoor unit and press the **h** button.
- ③ Set the unit number.
Press the temp **TEMP** button to set the unit number. (Press "01" to specify the indoor unit whose unit number is 01.)
Direct the wireless remote controller toward the receiver of the indoor unit and press the **min** button.
(By setting unit number with the **min** button, specified indoor unit starts performing fan operation.
Detect which unit is assigned to which number using this function. If unit number is set to AL, all the indoor units in same refrigerant system start performing fan operation simultaneously.)

Notes:

1. If a unit number that cannot be recognized by the unit is entered, 3 beeps of 0.4 seconds will be heard. Reenter the unit number setting.
2. If the signal was not received by the sensor, you will not hear a beep or a "double beep" may be heard. Reenter the unit number setting.

④ Select a mode.

Press the temp **TEMP** button to set a mode. Press "24" to turn on the function that raises the set temperature by 4 °C during heat operation. Direct the wireless remote controller toward the sensor of the indoor unit and press the **h** button.
→ The sensor-operation indicator will blink and beeps will be heard to indicate the current setting number.

Current setting number: 1 = 1 beep (1 second)
2 = 2 beeps (1 second each)
3 = 3 beeps (1 second each)

Notes:

1. If a mode number that cannot be recognized by the unit is entered, 3 beeps of 0.4 seconds will be heard. Reenter the mode number.
2. If the signal was not received by the sensor, you will not hear a beep or a "double beep" may be heard. Reenter the mode number.

⑤ Select the setting number.

Press the temp **TEMP** button to select the setting number. (02: Not available)
Direct the wireless remote controller toward the receiver of the indoor unit and press the **h** button.
→ The sensor-operation indicator will blink and beeps will be heard to indicate the the setting number.

Setting number: 1 = 2 beeps (0.4 seconds each)
2 = 2 beeps (0.4 seconds each, repeated twice)
3 = 2 beeps (0.4 seconds each, repeated 3 times)

Notes:

1. If a setting number that cannot be recognized by the unit is entered, the setting will turn back to the original setting.
2. If the signal was not received by the sensor, you will not hear a beep or a "double beep" may be heard. Reenter the setting number.
- ⑥ Repeat steps ④ and ⑤ to make an additional setting without changing unit number.
- ⑦ Repeat steps ③ to ⑤ to change unit number and make function settings on it.
- ⑧ Complete the function settings.

Press **ON/OFF** button.

Note: Do not use the wireless remote controller for 30 seconds after completing the function setting.

11-1. HOW TO "MONITOR THE OPERATION DATA"

11-1-1. PAR-3xMAA ("x" represents 0 or later)

Details on the operation data including each thermistor temperature and error history can be confirmed with the remote controller.

① Select "Service" from the Main menu, and press the button.

Select "Check" with the **F1** or **F2** button, and press the button.

Select "Request code" with the **F1** or **F2** button, and press the button.

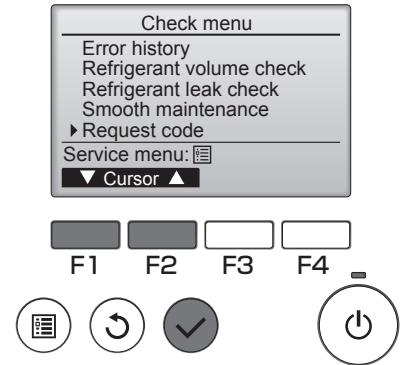

② Set the Refrigerant address and Request code.

Select the item to be changed with the **F1** or **F2** button.

Select the required setting with the **F3** or **F4** button.

- <Ref.address>setting [0] – [15]
- <Request code>setting

Press the button, Data will be collected and displayed.

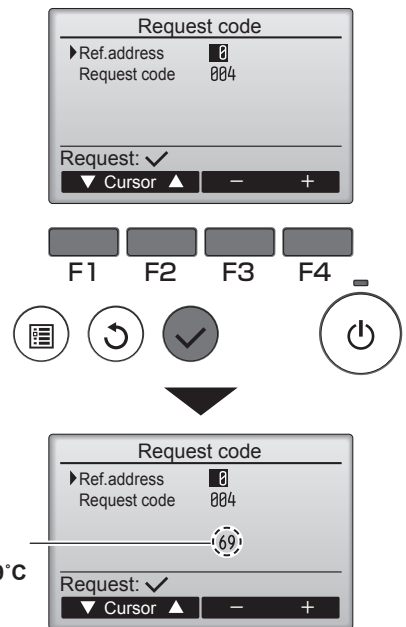

Request code: 004
Discharge temperature: 69°C

<Operation state> (Request code "0")

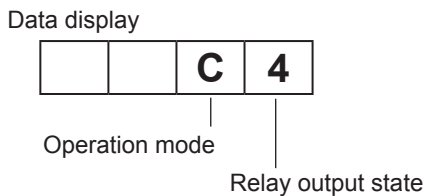

1) Operation mode

Display	Operation mode
0	STOP • FAN
C	COOL • DRY
H	HEAT
d	Defrost

2) Relay output state

Display	Power currently supplied to compressor	Compressor	Four-way valve	Solenoid valve
0	—	—	—	—
1				ON
2			ON	
3			ON	ON
4		ON		
5		ON		ON
6		ON	ON	
7		ON	ON	ON
8	ON			
A	ON		ON	

11-1-2. PAR-21MAA

- Turn on the [Monitoring the operation data]

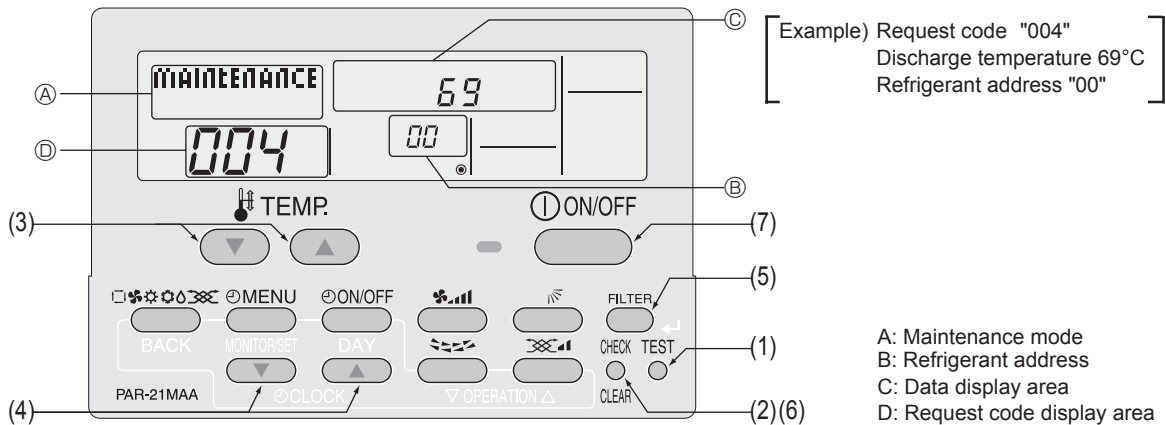

(1) Press the **TEST** button for 3 seconds so that [Maintenance mode] appears on the screen (at **A**).

(2) Press the **CHECK** button for 3 seconds to switch to [Maintenance monitor].

Note) It is not possible to switch to [Maintenance monitor] during data request in maintenance mode (i.e., while "----" is blinking) since no buttons are operative.

- Operating the service inspection monitor

[- - -] appears on the screen (at **D**) when [Maintenance monitor] is activated.

(The display (at **D**) now allows you to set a request code No.)

(3) Press the [TEMP] buttons (**▽** and **△**) to select the desired refrigerant address.

[Screen **D**] → **00** ↔ **01** ↔ ↔ **15** ←

(4) Press the [CLOCK] buttons (**▽** and **△**) to set the desired request code No.

(5) Press the **FILTER** button to perform data request.

(The requested data will be displayed at **C** in the same way as in maintenance mode.)

Data collected during operation of the remote controller will be displayed.

The collected data such as temperature data will not be updated automatically even if the data changes.

To display the updated data, carry out step (4) again.

- Canceling the Monitoring the operation data

(6) While [Maintenance monitor] is displayed, press the **CHECK** button for 3 seconds to return to maintenance mode.

(7) To return to normal mode, press the **ON/OFF** button.

11-2. Request code list

Certain indoor/outdoor combinations do not have the request code function; therefore, no request codes are displayed.

Request code	Request content	Description (Display range)	Unit	Remarks
0	Operation state	Refer to "11-2-1.Detail Contents in Request Code".	–	
1	Compressor-Operating current (rms)	0 – 50	A	
2	Compressor-Accumulated operating time	0 – 9999	10 hours	
3	Compressor-Number of operation times	0 – 9999	100 times	
4	Discharge temperature (TH4)	3 – 217	℃	
5	Outdoor unit - Liquid pipe temperature	-48 – 90	℃	
6				
7	Outdoor unit-2-phase pipe temperature (TH6)	-39 – 88	℃	
8				
9	Outdoor unit-Ambient temperature (TH7)	-39 – 88	℃	
10	Outdoor unit-Heatsink temperature (TH8)	-40 – 200	℃	
11	Comp. Surface temperature	-20 – 221	℃	
12	Discharge superheat (SHd)	0 – 255	℃	
13				
14				
15				
16	Compressor-Operating frequency	0 – 255	Hz	
17	Compressor-Target operating frequency	0 – 255	Hz	
18	Outdoor unit-Fan output step	0 – 10	Step	
19	Outdoor unit-Fan 1 speed (Only for air conditioners with DC fan motor)	0 – 9999	rpm	
20	Outdoor unit-Fan 2 speed (Only for air conditioners with DC fan motor)	0 – 9999	rpm	"0" is displayed if the air conditioner is a single-fan type.
21				
22	LEV (A) opening	0 – 500	Pulses	
23	LEV (B) opening	0 – 500	Pulses	
24				
25	Primary current	0 – 50	A	
26	DC bus voltage	180 – 370	V	
27				
28				
29	Number of connected indoor units	0 – 4	Units	
30	Indoor unit-Setting temperature	17 – 30	℃	
31	Indoor unit-Intake air temperature <Measured by thermostat>	8 – 39	℃	
32	Indoor unit-Intake air temperature (Unit No. 1) <Heat mode-4-℃ correction>	8 – 39	℃	"0" is displayed if the target unit is not present.
33	Indoor unit-Intake air temperature (Unit No. 2) <Heat mode-4-℃ correction>	8 – 39	℃	↑
34	Indoor unit-Intake air temperature (Unit No. 3) <Heat mode-4-℃ correction>	8 – 39	℃	↑
35	Indoor unit-Intake air temperature (Unit No. 4) <Heat mode-4-℃ correction>	8 – 39	℃	↑
36				
37	Indoor unit - Liquid pipe temperature (Unit No. 1)	-39 – 88	℃	"0" is displayed if the target unit is not present.
38	Indoor unit - Liquid pipe temperature (Unit No. 2)	-39 – 88	℃	↑
39	Indoor unit - Liquid pipe temperature (Unit No. 3)	-39 – 88	℃	↑
40	Indoor unit - Liquid pipe temperature (Unit No. 4)	-39 – 88	℃	↑
41				
42	Indoor unit-Cond./Eva. pipe temperature (Unit No. 1)	-39 – 88	℃	"0" is displayed if the target unit is not present.
43	Indoor unit-Cond./Eva. pipe temperature (Unit No. 2)	-39 – 88	℃	↑
44	Indoor unit-Cond./Eva. pipe temperature (Unit No. 3)	-39 – 88	℃	↑
45	Indoor unit-Cond./Eva. pipe temperature (Unit No. 4)	-39 – 88	℃	↑
46				
47				
48	Thermostat ON operating time	0 – 999	Minutes	
49	Test run elapsed time	0 – 120	Minutes	← Not possible to activate maintenance mode during the test run.



Request code	Request content	Description (Display range)	Unit	Remarks
50	Indoor unit-Control state	Refer to "11-2-1.Detail Contents in Request Code".	—	
51	Outdoor unit-Control state	Refer to "11-2-1.Detail Contents in Request Code".	—	
52	Compressor-Frequency control state	Refer to "11-2-1.Detail Contents in Request Code".	—	
53	Outdoor unit-Fan control state	Refer to "11-2-1.Detail Contents in Request Code".	—	
54	Actuator output state	Refer to "11-2-1.Detail Contents in Request Code".	—	
55	Error content (U9)	Refer to "11-2-1.Detail Contents in Request Code".	—	
56				
57				
58				
59				
60	Signal transmission demand capacity	0 – 255	%	
61	Contact demand capacity	Refer to "11-2-1.Detail Contents in Request Code".	—	
62	External input state (silent mode, etc.)	Refer to "11-2-1.Detail Contents in Request Code".	—	
63				
64				
65				
66				
67				
68				
69				
70	Outdoor unit-Capacity setting display	Refer to "11-2-1.Detail Contents in Request Code".	—	
71	Outdoor unit-Setting information	Refer to "11-2-1.Detail Contents in Request Code".	—	
72				
73	Outdoor unit-SW1 setting information	Refer to "11-2-1.Detail Contents in Request Code".	—	
74	Outdoor unit-SW2 setting information	Refer to "11-2-1.Detail Contents in Request Code".	—	
75				
76	Outdoor unit-SW4 setting information	Refer to "11-2-1.Detail Contents in Request Code".	—	
77	Outdoor unit-SW5 setting information	Refer to "11-2-1.Detail Contents in Request Code".	—	
78	Outdoor unit-SW6 setting information	Refer to "11-2-1.Detail Contents in Request Code".	—	
79	Outdoor unit-SW7 setting information	Refer to "11-2-1.Detail Contents in Request Code".	—	
80	Outdoor unit-SW8 setting information	Refer to "11-2-1.Detail Contents in Request Code".	—	
81	Outdoor unit-SW9 setting information	Refer to "11-2-1.Detail Contents in Request Code".	—	
82	Outdoor unit-SW10 setting information	Refer to "11-2-1.Detail Contents in Request Code".	—	
83				
84	M-NET adapter connection (presence/absence)	"0000": Not connected "0001": Connected	—	
85				
86				
87				
88				
89	Display of execution of replace/wash operation	"0000": Not washed "0001": Washed	—	
90	Outdoor unit-Microprocessor version information	Examples) Ver 5.01 → "0501"	Ver	
91	Outdoor unit-Microprocessor version information (sub No.)	Auxiliary information (displayed after version information) Examples) Ver 5.01 A000 → "A000"	—	
92				
93				
94				
95				
96				
97				
98				
99				
100	Outdoor unit - Error postponement history 1 (latest)	Displays postponement code. (" - - " is displayed if no postponement code is present)	Code	
101	Outdoor unit - Error postponement history 2 (previous)	Displays postponement code. (" - - " is displayed if no postponement code is present)	Code	
102	Outdoor unit - Error postponement history 3 (last but one)	Displays postponement code. (" - - " is displayed if no postponement code is present)	Code	

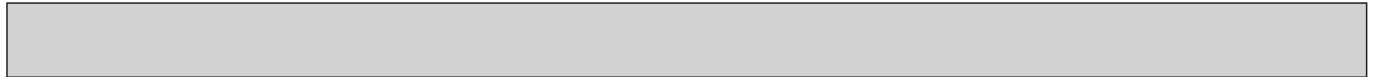

Request code	Request content	Description (Display range)	Unit	Remarks
103	Error history 1 (latest)	Displays the history ("--" is displayed if no history is present.)	Code	
104	Error history 2 (second to last)	Displays the history ("--" is displayed if no history is present.)	Code	
105	Error history 3 (third to last)	Displays the history ("--" is displayed if no history is present.)	Code	
106	Abnormal thermistor display (TH6/TH7/TH8)	6 : TH6 7 : TH7 8 : TH8 0 : No thermistor error	Sensor number	
107	Operation mode at time of error	Displayed in the same way as request code "0".	—	
108	Compressor-Operating current at time of error	0 – 50	A	
109	Compressor-Accumulated operating time at time of error	0 – 9999	10 hours	
110	Compressor-Number of operation times at time of error	0 – 9999	100 times	
111	Discharge temperature at time of error	3 – 217	°C	
112	Outdoor unit - Liquid pipe temperature	-48 – 90	°C	
113				
114	Outdoor unit-2-phase pipe temperature (TH6) at time of error	-39 – 88	°C	
115				
116	Outdoor unit-Ambient temperature (TH7) at time of error	-39 – 88	°C	
117	Outdoor unit-Heatsink temperature (TH8) at time of error	-40 – 200	°C	
118	Discharge superheat (SHd) at time of error	0 – 255	°C	
119				
120	Compressor-Operating frequency at time of error	0 – 255	Hz	
121	Outdoor unit at time of error • Fan output step	0 – 10	Step	
122	Outdoor unit at time of error • Fan 1 speed (Only for air conditioners with DC fan)	0 – 9999	rpm	
123	Outdoor unit at time of error • Fan 2 speed (Only for air conditioners with DC fan)	0 – 9999	rpm	"0" is displayed if the air conditioner is a single-fan type.
124				
125	LEV (A) opening	0 – 500	Pulses	
126	LEV (B) opening at time of error	0 – 500	Pulses	
127				
128				
129				
130	Thermostat ON time until operation stops due to error	0 – 999	Minutes	
131				
132	Indoor - Liquid pipe temperature at time of error	-39 – 88	°C	Average value of all indoor units is displayed if the air conditioner consists of 2 or more indoor units (twin, triple, quad).
133	Indoor - Cond/Eva. pipe temperature at time of error	-39 – 88	°C	Average value of all indoor units is displayed if the air conditioner consists of 2 or more indoor units (twin, triple, quad).
134	Indoor at time of error • Intake air temperature <Thermostat judge temperature>	-39 – 88	°C	
135	U9: Error history detailed codes	01 – 20	—	
136				
137				
138				
139				
140				
~				
146				
147				
148				
149				
150	Indoor - Actual intake air temperature	-39 – 88	°C	
151	Indoor - Liquid pipe temperature	-39 – 88	°C	
152	Indoor - Cond/Eva. pipe temperature	-39 – 88	°C	

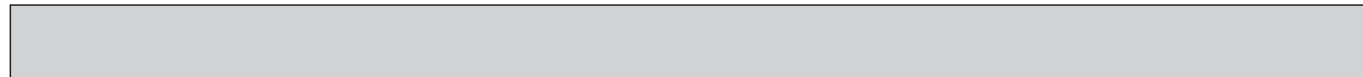

Request code	Request content	Description (Display range)	Unit	Remarks
153				
154	Indoor-Fan operating time (After filter is reset)	0 – 9999	1 hour	
155	Indoor-Total operating time (Fan motor ON time)	0 – 9999	10 hours	
156				
157	Indoor fan output value (Sj value)	0 – 255 Fan control data	–	For indoor fan phase control
158	Indoor fan output value (Pulsation ON/OFF)	"00 *** ****" indicates fan control data.	–	For indoor fan pulsation control
159	Indoor fan output value (duty value)	"00 *** ****" indicates fan control data.	–	For indoor DC brushless motor control
160				
161				
162				
163	Indoor unit-Capacity setting information	Refer to "11-2-1.Detail Contents in Request Code".	–	
164	Indoor unit-SW3 information	Undefined	–	
165	Wireless pair No. (indoor control board side) setting	Refer to "11-2-1.Detail Contents in Request Code".	–	
166	Indoor unit-SW5 information	Undefined	–	
167				
~				
189				
190	Indoor unit-Microprocessor version information	Examples) Ver 5.01 → "0501"	Ver	
191	Indoor unit-Microprocessor version information (sub No.)	Auxiliary information (displayed after version information) Examples) Ver 5.01 A000 → "A000"	–	

11-2-1. Detail Contents in Request Code

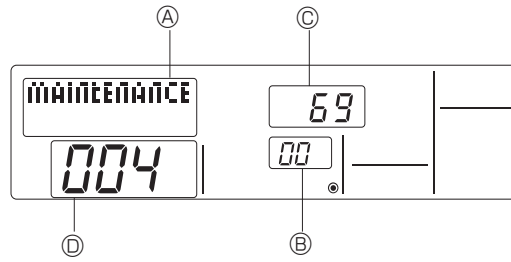

[Example) Request code "004"
Discharge temperature 69°C
Refrigerant address "00"]

- A: Maintenance mode display
- B: Refrigerant address
- C: Data display area
- D: Request code display area

[Operation state] (Request code : "0")

Data display

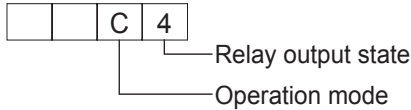

Operation mode

Display	Operation mode
0	STOP • FAN
C	COOL • DRY
H	HEAT
d	DEFROST

Relay output state

Display	Power currently supplied to compressor	Compressor	Four-way valve	Solenoid valve
0	—	—	—	—
1				ON
2			ON	
3			ON	ON
4		ON		
5		ON		ON
6		ON	ON	
7		ON	ON	ON
8	ON			
A	ON		ON	

[Indoor unit – Control state] (Request code : "50")

Data display

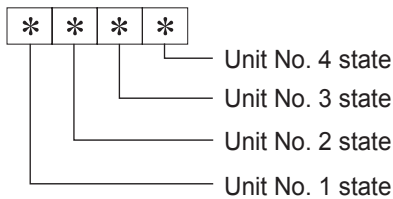

Display	State
0	Normal
1	Preparing for heat operation
2	—
3	—
4	Heater is ON.
5	Anti-freeze protection is ON.
6	Overheat protection is ON.
7	Requesting compressor to turn OFF
F	There are no corresponding units.

[Outdoor unit – Control state] (Request code : "51")

Data display	State
0 0 0 0	Normal
0 0 0 1	Preparing for heat operation
0 0 0 2	Defrost

[Compressor – Frequency control state] (Request code : "52")

Data display

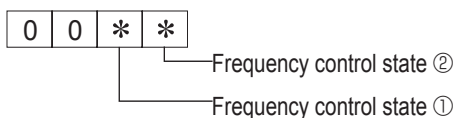

Frequency control state ①

Display	Current limit control
0	No current limit
1	Primary current limit control is ON.
2	Secondary current limit control is ON.

Frequency control state ②

Display	Discharge temperature overheat prevention	Condensation temperature overheat prevention	Anti-freeze protection control	Heatsink temperature overheat prevention
0				
1	Controlled			
2		Controlled		
3	Controlled	Controlled		
4			Controlled	
5	Controlled		Controlled	
6		Controlled	Controlled	
7	Controlled	Controlled	Controlled	
8				Controlled
9	Controlled			Controlled
A		Controlled		Controlled
b	Controlled	Controlled		Controlled
C			Controlled	Controlled
d	Controlled		Controlled	Controlled
E		Controlled	Controlled	Controlled
F	Controlled	Controlled	Controlled	Controlled

[Fan control state] (Request code : "53")

Data display

0	0	*	*
---	---	---	---

— Fan step correction value by heatsink temperature overheat prevention control
 — Fan step correction value by cool condensation temperature overheat prevention control

Display	Correction value
- (minus)	- 1
0	0
1	+1
2	+2

[Actuator output state] (Request code : "54")

Data display

0	0	*	*
---	---	---	---

— Actuator output state ①
 — Actuator output state ②

Actuator output state ①

Display	SV1	Four-way valve	Compressor	Compressor is warming up
0				
1	ON			
2		ON		
3	ON	ON		
4			ON	
5	ON		ON	
6		ON	ON	
7	ON	ON	ON	
8				ON
9	ON			ON
A		ON		ON
b	ON	ON		ON
C			ON	ON
d	ON		ON	ON
E		ON	ON	ON
F	ON	ON	ON	ON

Actuator output state ②

Display	52C	SV2	SS
0			
1	ON		
2		ON	
3	ON	ON	
4			ON
5	ON		ON
6		ON	ON
7	ON	ON	ON

[Error content (U9)] (Request code : "55") Note: Refer to "9-4. SELF-DIAGNOSIS ACTION TABLE" for more information.

Data display

0	0	*	*
---	---	---	---

— Error content ①
 — Error content ②

Error content ①

● : Detected

Display	Overvoltage error	Undervoltage error	L ₁ -phase open error	Power synchronizing signal error
0				
1	●			
2		●		
3	●	●		
4			●	
5	●		●	
6		●	●	
7	●	●	●	
8				●
9	●			●
A		●		●
b	●	●		●
C			●	●
d	●		●	●
E		●	●	●
F	●	●	●	●

Error content ②

● : Detected

Display	Converter Fo error	PAM error
0		
1	●	
2		●
3	●	●

[Contact demand capacity] (Request code : "61")

Data display

0	0	0	*
---	---	---	---

 Setting content

Setting content

Display	Setting value
0	0%
1	50%
2	75%
3	100%

[External input state] (Request code : "62")

Data display

0	0	0	*
---	---	---	---

 Input state

Input state ● : Input present

Display	Contact demand input	Silent mode input	Spare 1 input	Spare 2 input
0				
1	●			
2		●		
3	●	●		
4			●	
5	●		●	
6		●	●	
7	●	●	●	
8				●
9	●			●
A		●		●
b	●	●		●
C			●	●
d	●		●	●
E		●	●	●
F	●	●	●	●

[Outdoor unit –Capacity setting display] (Request code : "70")

Model	Data display	Capacity
M100	20	100
M125	25	125
M140	28	140

[Outdoor unit – Setting information] (Request code : "71")

Data display

0	0	*	*
---	---	---	---

 Setting information ①
Setting information ②

Setting information ①

Display	Defrost mode
0	Standard
1	For high humidity

Setting information ②

Display	Single-/3-phase	Heat pump/cooling only
0	Single-phase	Heat pump
1		Cooling only
2	3-phase	Heat pump
3		Cooling only

[Indoor unit – Capacity setting information] (Request code : "163")

Data display

0	0	*	*
---	---	---	---

See the table on the right.

Display	Capacity setting state	Display	Capacity setting state
00		10	42
01		11	
02		12	48
03		13	
04		14	
05		15	
06		16	
07		17	
08		18	
09		19	
0A		1A	
0b		1b	
0C		1C	
0d		1d	
0E		1E	
0F		1F	

[Wireless pair No. (indoor control board side) setting] (Request code : "165")

Data display

0	0	*	*
---	---	---	---

See the table on the right.

Display	Pair No. setting state
00	No. 0
01	No. 1 J41 disconnected
02	No. 2 J42 disconnected
03	No. 3 J41, J42 disconnected

12-1. SMOOTH MAINTENANCE

12-1-1. PAR-3xMAA ("x" represents 0 or later)

Maintenance data, such as the indoor/outdoor unit's heat exchanger temperature and compressor operation current can be displayed with "Smooth maintenance".

This cannot be executed during test operation.

Depending on the combination with the outdoor unit, this may not be supported by some models.

Select "Service" from the Main menu, and press the  button.



Select "Check" with the **[F1]** or **[F2]** button, and press the  button.



Select "Smooth maintenance" with the **[F1]** or **[F2]** button, and press the  button.

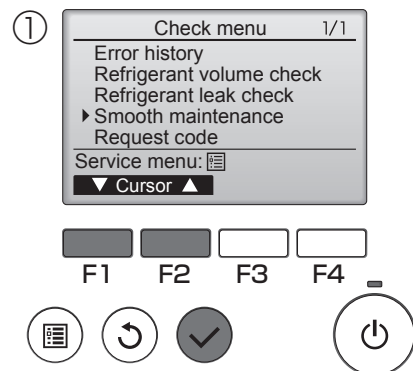

Set each item.

Select the item to be changed with the **[F1]** or **[F2]** button.

Select the required setting with the **[F3]** or **[F4]** button.

- <Ref.address>setting [0]~[15]
- <Stable mode>setting [Cool] / [Heat] / [Normal]

Press the  button, Fixed operation will start.

Note: Stable mode will take approx. 20 minutes.

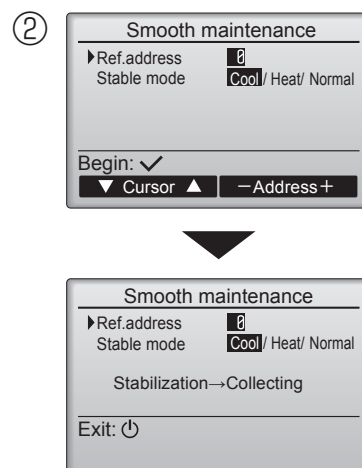

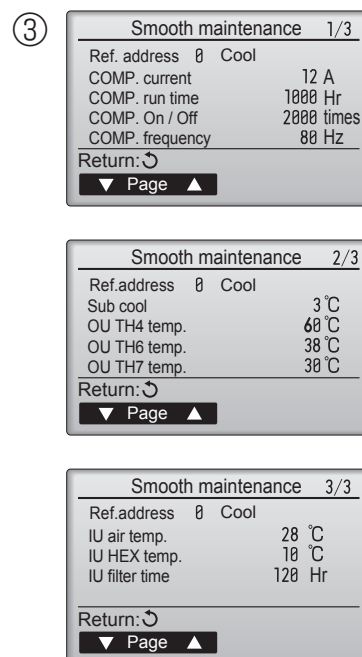

The operation data will appear.

The Compressor-Accumulated operating (COMP. run) time is 10-hour unit, and the Compressor-Number of operation times (COMP. On / Off) is a 100-time unit (fractions discarded).



Navigating through the screens

- To go back to the Service menu  button
- To return to the previous screen  button

12-1-2. PAR-21MAA

- Reduces maintenance work drastically.
- Enables you to check operation data of the indoor and outdoor units by remote controller.

Furthermore, use of maintenance stable-operation control that fixes the operating frequency, allows smooth inspection, even for inverter models.

Smooth Maintenance Function

Discharge temperature 64°C ● Conventional inspection work

Easy maintenance information (unit)

Compressor	Outdoor unit	Indoor unit
① Accumulated operating time (×10 hours)	④ Heat exchanger temperature (°C)	⑦ Intake air temperature (°C)
② Number of ON/OFF times (×10 times)	⑤ Discharge temperature (°C)	⑧ Heat exchanger temperature (°C)
③ Operating current (A)	⑥ Outside air temperature (°C)	⑨ Filter operating time* (Hours)

* The filter operating time is the time that has elapsed since the filter was reset.

<Maintenance mode operation method>

If you are going to use <GUIDE FOR OPERATION CONDITION>, set the airflow to "High" before activating maintenance mode.

● Switching to maintenance mode

Maintenance mode can be activated either when the air conditioner is operated or stopped. It cannot be activated during test run.

Note: Maintenance information can be viewed even if the air conditioner is stopped.

■ Remote controller button information

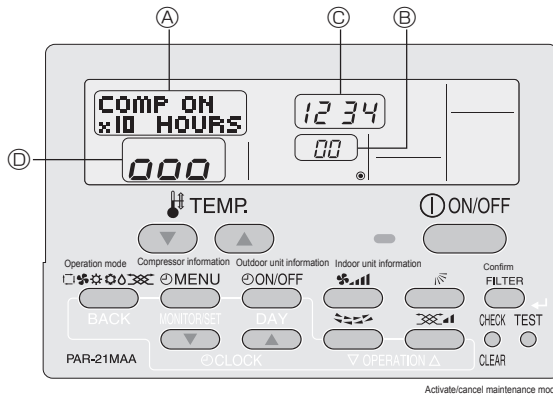

(1) Press the **TEST** button for 3 seconds to switch to maintenance mode.

[Display Ⓐ] MAINTENANCE

If stable operation is unnecessary or if you want to check the data with the air conditioner stopped, skip to step (4).

● Fixed Hz operation

The operating frequency can be fixed to stabilize operation of inverter model. If the air conditioner is currently stopped, start it by this operation.

(2) Press the **MODE** button to select the desired operation mode.

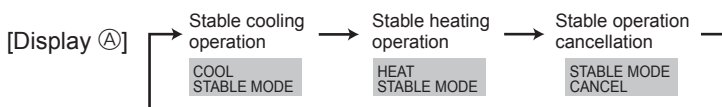

(3) Press the **FILTER** button to confirm the setting.

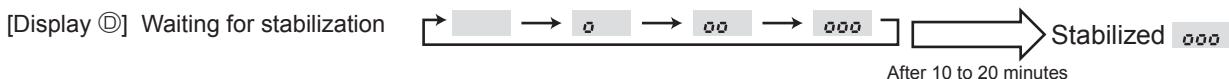

● **Data measurement**

When the operation is stabilized, measure operation data as explained below.

➤(4) Press the [TEMP] buttons ( and ) to select the desired refrigerant address.



➤(5) Select the type of data to be displayed.
After selecting, go to step (6).

Compressor information

 **MENU** button

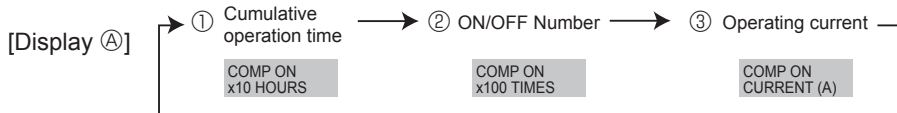

Outdoor unit information

 **ON/OFF** button

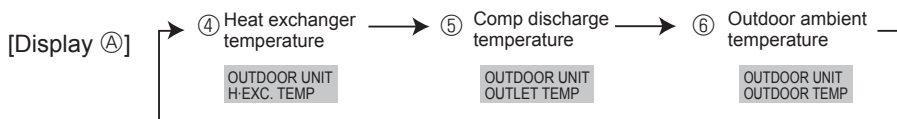

Indoor unit information

 **Filter** button

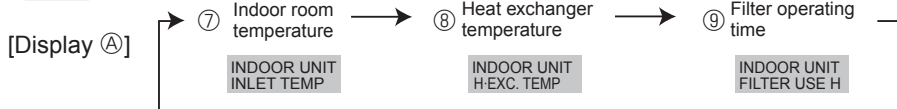

(6) Press the **FILTER** () button to confirm the setting.

[Display example for accumulated operating time]

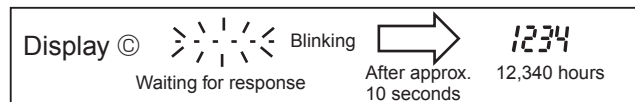

(7) Data is displayed on the display (at ⑤).

To check the data for each item, repeat steps (5) to (7).

(8) To cancel maintenance mode, press the **TEST** button for 3 seconds or press the  **ON/OFF** button.

■ **Refrigerant address**

Single refrigerant system

In the case of single refrigerant system, the refrigerant address is "00" and no operation is required. Simultaneous twin, triple units belong to this category (single refrigerant system).

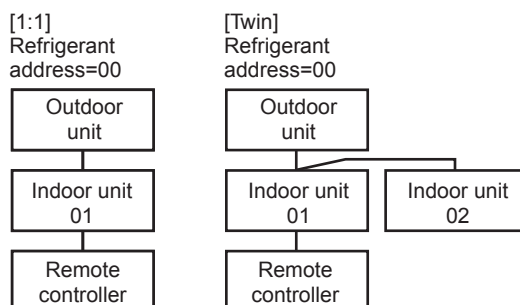

Multi refrigerant system (group control)

Up to 16 refrigerant systems (16 outdoor units) can be connected as a group by 1 remote controller. To check or set the refrigerant addresses.

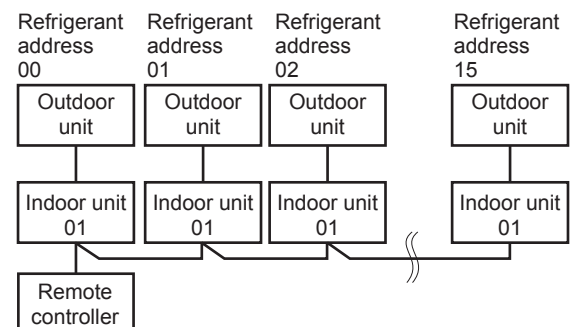

<Guide for operation condition>

Check Points

Enter the temperature differences between ⑤, ④, ⑦ and ⑧ into the graph given below.
 Operation state is determined according to the plotted areas on the graph.
 For data measurements, set the fan speed to "Hi" before activating maintenance mode.

Inspection item		Result		
Power supply	Loose connection	Breaker	Good Retightened	
		Terminal block	Good Retightened	
		Outdoor Unit	Good Retightened	
	Indoor Unit	Good Retightened		
	(Insulation resistance)		MΩ	
	(Voltage)		V	
Compressor	① Accumulated operating time		Time	
	② Number of ON/OFF times		Times	
	③ Current		A	
Outdoor Unit	Temperature	④ Refrigerant/heat exchanger temperature	COOL °C HEAT °C	
		⑤ Refrigerant/discharge temperature	COOL °C HEAT °C	
		⑥ Air/outside air temperature	COOL °C HEAT °C	
		(Air/discharge temperature)	COOL °C HEAT °C	
	Cleanliness	Appearance	Good	Cleaning required
		Heat exchanger	Good	Cleaning required
	Sound/vibration	None	Present	
Indoor Unit	Temperature	⑦ Air/intake air temperature	COOL °C HEAT °C	
		(Air/discharge temperature)	COOL °C HEAT °C	
		⑧ Refrigerant/heat exchanger temperature	COOL °C HEAT °C	
		⑨ Filter operating time*		Time
	Cleanliness	Decorative panel	Good	Cleaning required
		Filter	Good	Cleaning required
		Fan	Good	Cleaning required
		Heat exchanger	Good	Cleaning required
		Sound/vibration	None	Present

Classification	Item	Result	
Cool	Inspection	Is "D000" displayed stably on the remote controller?	Stable Unstable
	Temperature difference	(⑤ Discharge temperature) – (④ Outdoor heat exchanger temperature) (⑦ Indoor intake air temperature) – (⑧ Indoor heat exchanger temperature)	°C °C
Heat	Inspection	Is "D000" displayed stably on the remote controller?	Stable Unstable
	Temperature difference	(⑤ Discharge temperature) – (⑧ Indoor heat exchanger temperature) – (⑦ Indoor intake air temperature)	°C °C

* Fixed Hz operation may not be possible under the following temperature ranges.

A) In cool mode, outdoor intake air temperature is 40 °C or higher or indoor intake air temperature is 23 °C or lower.

B) In heat mode, outdoor intake air temperature is 20 °C or higher or indoor intake air temperature is 25 °C or lower.

* If the air conditioner is operated at a temperature range other than the ones above but operation is not stabilized after 30 minutes or more have elapsed, carry out inspection.

* In heat mode, the operation state may vary due to frost forming on the outdoor heat exchanger.

* The filter operating time is the time that has elapsed since the filter was reset.

Cool mode

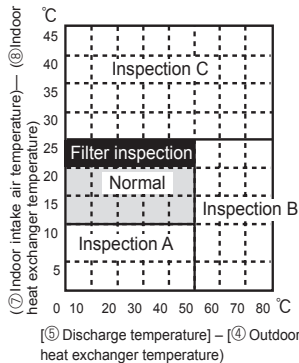

Heat mode

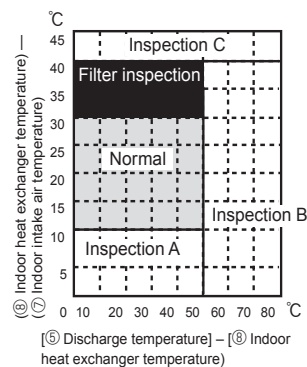

Result

Area	Check item	Judgement	
		Cool	Heat
Normal	Normal operation state		
Filter inspection	Filter may be clogged. *1		
Inspection A	Performance has dropped. Detailed inspection is necessary.		
Inspection B	Refrigerant amount is dropping.		
Inspection C	Filter or indoor heat exchanger may be clogged.		

* The above judgement is just guide based on Japanese standard conditions.

It may be changed depending on the indoor and outdoor temperature.

*1 It may be judged as "Filter inspection" due to the outdoor and indoor temperature, even though it is not clogged.

PUZ-M100VKA(-ET).TH
PUZ-M100YKA(-ET).TH

PUZ-M125VKA(-ET).TH
PUZ-M125YKA(-ET).TH

PUZ-M140VKA(-ET).TH
PUZ-M140YKA(-ET).TH

—————> : Indicates the visible parts in the photos/figures.
 - - - - -> : Indicates the invisible parts in the photos/figures.

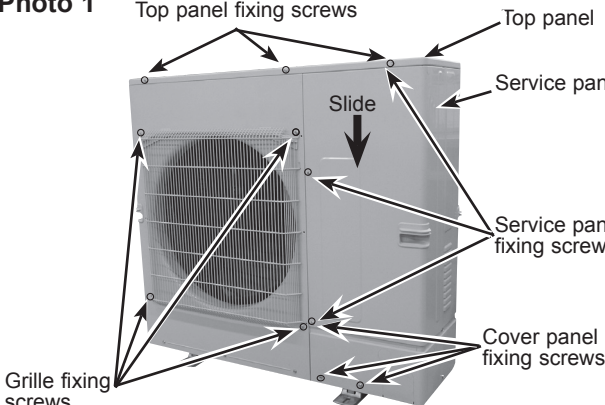
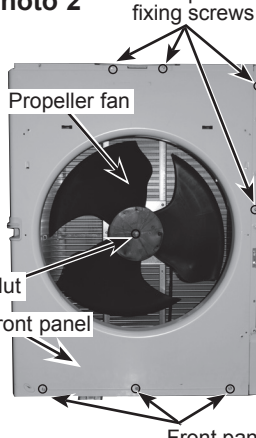
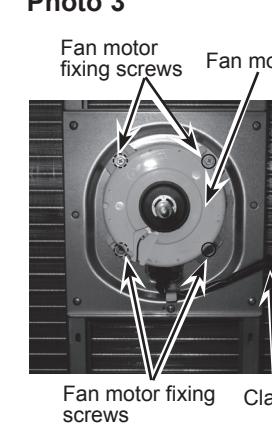
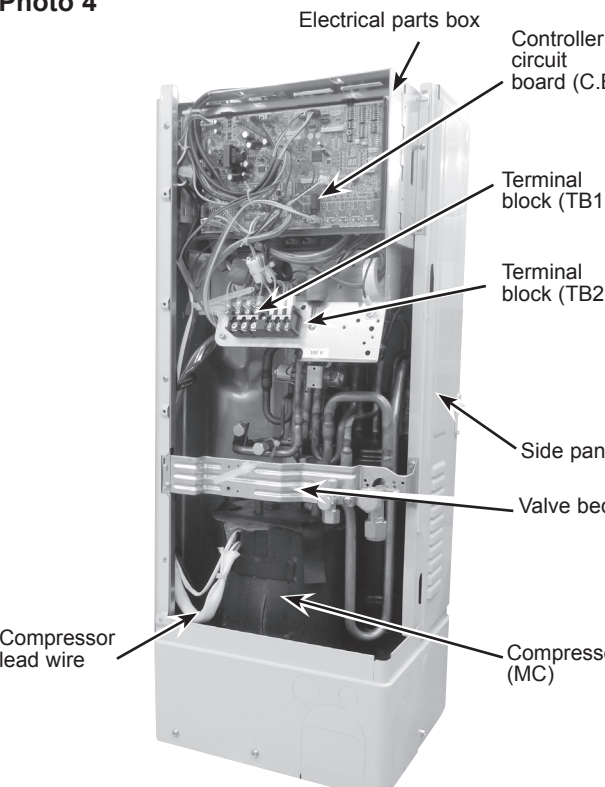
OPERATING PROCEDURE	PHOTOS/FIGURES
<p>1. Removing the service panel and top panel</p> <p>(1) Remove 3 service panel fixing screws (5 × 12) and slide the hook on the right downward to remove the service panel.</p> <p>(2) Remove screws (2 for front, 3 for rear/5 × 12) of the top panel and remove it.</p>	<p>Photo 1</p> 
<p>2. Removing the fan motor (MF1)</p> <p>(1) Remove the service panel. (See Photo 1)</p> <p>(2) Remove the top panel. (See Photo 1)</p> <p>(3) Remove 4 fan grille fixing screws (5 × 12) to detach the fan grille. (See Photo 1)</p> <p>(4) Remove a nut (for right handed screw of M6) to detach the propeller. (See Photo 2)</p> <p>(5) Disconnect the connector CNF1 on controller circuit board in electrical parts box. (See Photo 4)</p> <p>(6) Loosen a clamp on the side of the motor support. (See Photo 3)</p> <p>(7) Remove 4 fan motor fixing screws (5 × 20) to detach the fan motor. (See Photo 3)</p>	<div style="display: flex; justify-content: space-around;"> <div data-bbox="885 817 1173 1299"> <p>Photo 2</p>  </div> <div data-bbox="1189 817 1492 1299"> <p>Photo 3</p>  </div> </div>
<p>3. Removing the electrical parts box</p> <p>(1) Remove the service panel. (See Photo 1)</p> <p>(2) Remove the top panel. (See Photo 1)</p> <p>(3) Disconnect the indoor/outdoor connecting wire and power supply wire from the terminal block.</p> <p>(4) Disconnect the connector CNF1, LEV-A and LEV-B on the controller circuit board.</p> <p><Symbols on the board></p> <ul style="list-style-type: none"> • CNF1: Fan motor • LEV-A and LEV-B: LEV <p>(5) Disconnect the pipe-side connections of the following parts.</p> <ul style="list-style-type: none"> • Thermistor <Liquid> (TH3) • Thermistor <Discharge>(TH4) • Thermistor <2-phase pipe, Ambient>(TH7/6) • High pressure switch (63H) • Thermistor <Comp. surface> (TH33) • 4way valve (21S4) <p>(6) Remove a nut from the terminal cover. (See Photo16, 17)</p> <p>(7) Remove the terminal cover and disconnect the compressor lead wire.</p>	<p>Photo 4</p>  <p>*Only YKA type has TB2.</p>

From the previous page.

OPERATING PROCEDURE	PHOTOS/FIGURES
---------------------	----------------

(8) Remove 2 electrical parts box fixing screws (4 × 10) and detach the electrical parts box by pulling it upward. The electrical parts box is fixed with 2 hooks on the left and 1 hook on the right.

Photo 5 (VKA type)

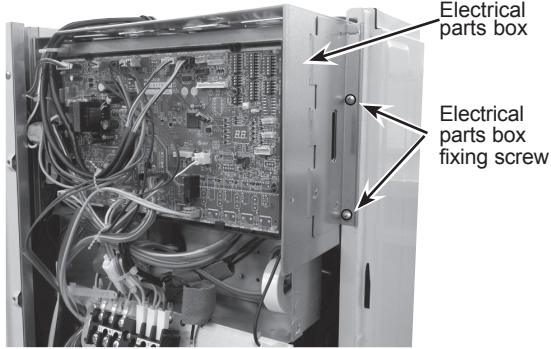

*This photo is for 100VKA type.

Photo 6 (YKA type)

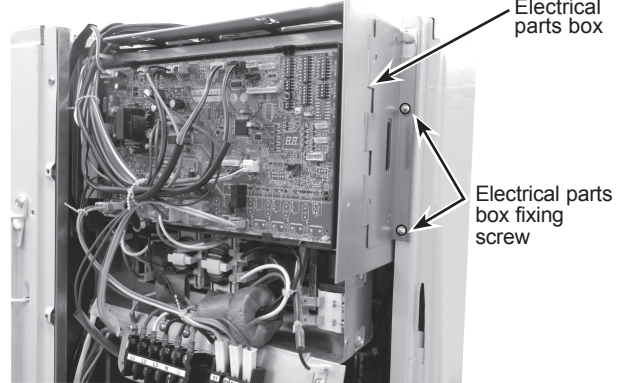

4. Disassembling the electrical parts box (VKA type)

- (1) Disconnect all the connectors on the controller circuit board.
- (2) Remove the screws ①, that fix the plate equipped with the outdoor controller circuit board, and the electrical parts box. (See Photo 7)
- (3) Remove the controller circuit board. (See Photo 7)
- (4) Disconnect the connectors of reactor on the bottom plate of the electrical parts box. (See Photos 8-1 and 8-2)
- (5) Remove 4 (100VKA) or 2 (125/140VKA) screws ② on the rear plate of the electrical parts box. (See Photos 8-1 and 8-2)
- (6) Remove the reactor(s). (See Photos 8-1 and 8-2)

Note: 1. When reassembling the electrical parts box, make sure that the wirings are correct.
 2. When exchanging the reactor, make sure to exchange all the 3 reactors.

Photo 7

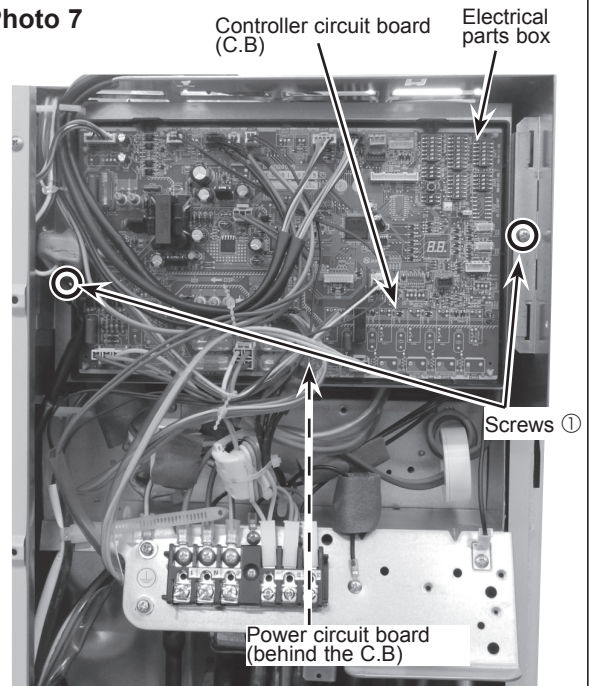

*This photo is for 100VKA type.

Photo 8-1 (125/140VKA)

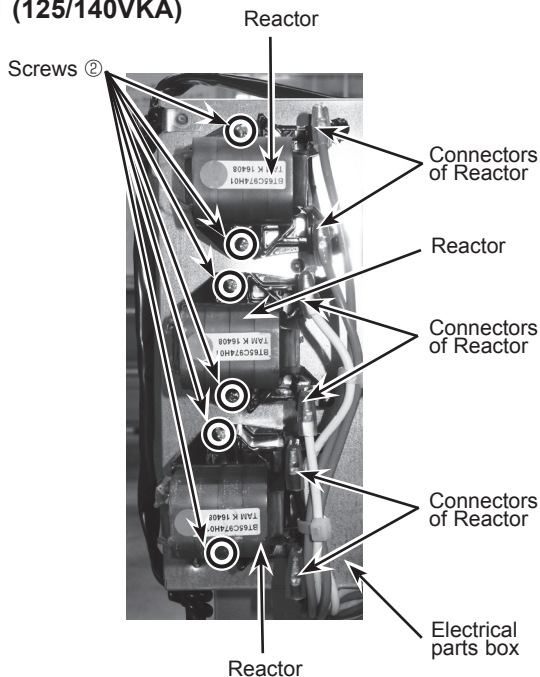
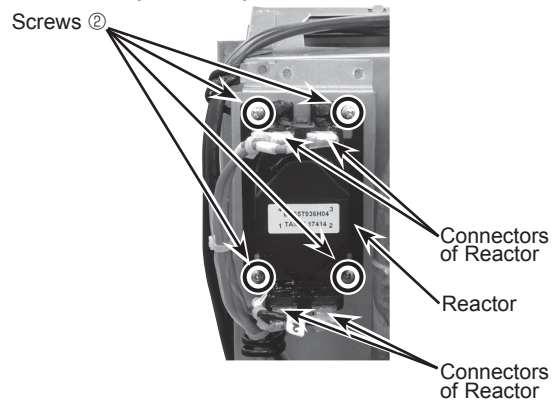

Photo 8-2 (100VKA)



From the previous page.

OPERATING PROCEDURE	PHOTOS/FIGURES
<p>4. Disassembling the electrical parts box (YKA type)</p> <ol style="list-style-type: none"> (1) Disconnect all the connectors on the controller circuit board. (2) Remove the screw ①, that fix the plate equipped with the outdoor controller circuit board, and the electrical parts box. (See Photo 9) (3) Remove the controller circuit board. (See Photo 9) (4) Disconnect all the connectors on the noise filter board. (See Photo 10) (5) Remove 9 supports on the noise filter board. (See Photo 10) (6) Remove the noise filter circuit board. (See Photo 10) (7) Remove the noise filter plate fixing screws. (See Photo 10) (8) Disconnect the connectors of reactor on the bottom plate of the electrical parts box. (See Photo 11) (9) Remove 4 screws ② on the bottom plate of the electrical parts box. (See Photo 11) (10) Remove the reactor. (See Photo 11) <p>Note: 1. When reassembling the electrical parts box, make sure that the wirings are correct.</p>	<p>Photo 9</p> <p>Electrical parts box</p> <p>Screw ①</p> <p>Noise filter circuit board (N.F.)</p> <p>Controller circuit board (C.B.)</p>
<p>Photo 10</p> <p>Noise filter circuit board (N.F.)</p> <p>Power circuit board (P.B.)</p> <p>Electrical parts box</p> <p>Supports</p> <p>Noise filter plate fixing screws</p>	<p>Photo 11</p> <p>Reactor</p> <p>Electrical parts box</p> <p>Screws ②</p> <p>Connectors of Reactor</p>
<p>5. Removing the thermistor <2-phase pipe> (TH6)</p> <ol style="list-style-type: none"> (1) Remove the service panel. (See Photo 1) (2) Remove the top panel. (See Photo 1) (3) Disconnect the connector TH7/6 (red), on the controller circuit board in the electrical parts box. (4) Loosen the 2 wire clamps on top of the electrical parts box. (5) Pull out the thermistor <2-phase pipe> (TH6) from the sensor clip. <p>Note: When replacing thermistor <2-phase pipe> (TH6), replace it together with thermistor <Ambient> (TH7) since they are combined together. Refer to procedure No.6 to remove thermistor <Ambient>.</p>	<p>Photo 12</p> <p>Electrical parts box</p> <p>Thermistor <2-phase pipe> (TH6)</p> <p>Clamp</p>

OPERATING PROCEDURE

6. Removing the thermistor <Ambient> (TH7)

- (1) Remove the service panel. (See Photo 1)
- (2) Remove the top panel. (See Photo 1)
- (3) Disconnect the connector TH7/6 (red) on the controller circuit board in the electrical parts box.
- (4) Loosen the 2 wire clamps on top of the electrical parts box. (See Photo 12)
- (5) Pull out the thermistor <Ambient> (TH7) from the sensor holder.

Note: When replacing thermistor <Ambient> (TH7), replace it together with thermistor <2- phase pipe> (TH6), since they are combined together. Refer to procedure No.5 to remove thermistor <2-phase pipe>.

7. Removing the thermistor <Liquid> (TH3), thermistor <Discharge> (TH4) and thermistor <Comp. surface> (TH33)

- (1) Remove the service panel. (See Photo 1)
 - (2) Remove the top panel. (See Photo 1)
 - (3) Remove 2 front cover panel fixing screws (5 × 12) and remove the front cover panel. (See Photo 1)
 - (4) Remove 4 back cover panel fixing screws (5 × 12) and remove the back cover panel.
 - (5) Remove 4 right side panel fixing screws (5 × 12) in the rear of the unit and remove the right side panel (See Photo 18)
 - (6) Disconnect the connectors, TH3 (white), TH4 (white) and TH33 (black) on the controller circuit board in the electrical parts box.
 - (7) Loosen the fastener for the lead wire under the electrical parts box. (See Photo 14)
 - (8) Pull out the thermistor <Liquid> (TH3) from thermistor clip.
 - (9) Pull out the thermistor <Discharge> (TH4) from the thermistor holder. (See Photo 16)
- [Removing the thermistor <Comp. surface> (TH33)]
- (10) Remove the sound proof cover (upper) for compressor. (See Photo 16)
 - (11) Pull out the thermistor <Comp. surface> (TH33) from the holder of the compressor shell. (See Photo 17)

PHOTOS/FIGURES

Photo 13 Thermistor <Ambient> (TH7)

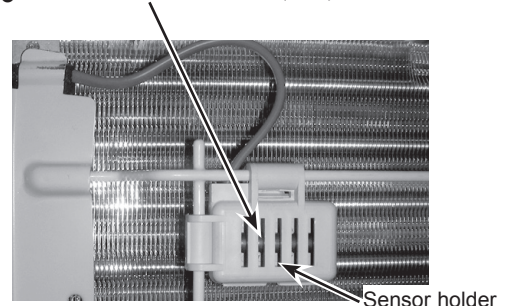

Photo 14

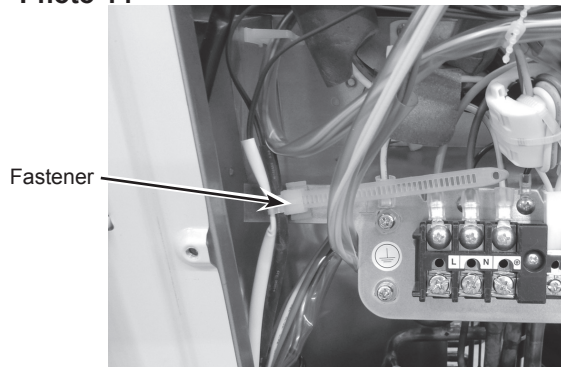

Photo 15

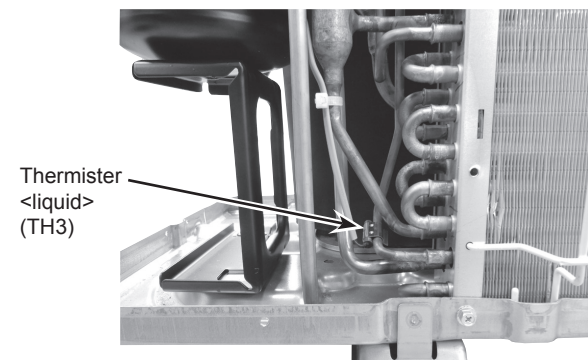

Photo 16 (100V/YKA)

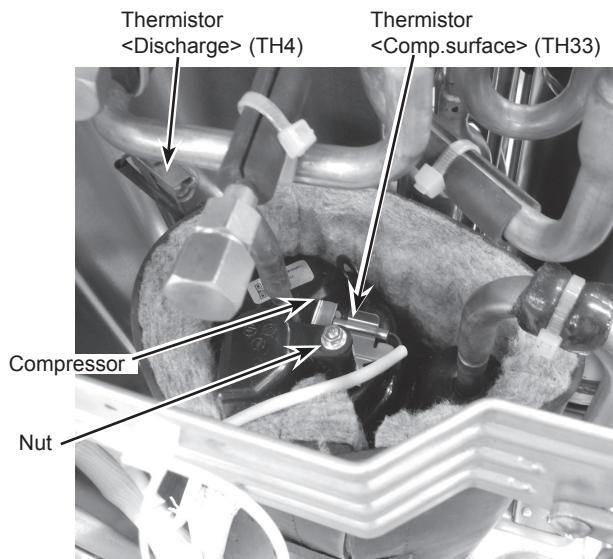
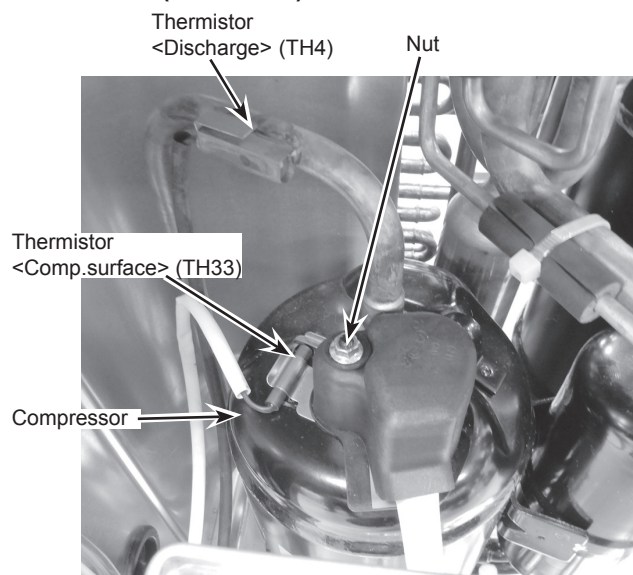

Photo 17 (140V/YKA)



OPERATING PROCEDURE

8. Removing LEV coil

- (1) Remove the service panel. (See Photo 1)
- (2) Remove the top panel. (See Photo 1)
- (3) Remove the LEV coil by sliding the coil upward. (See Photo 19)
- (4) Disconnect the connectors, LEV-B (RD) on the controller circuit board in the electrical parts box.

9. Removing LEV

- (1) Remove the service panel. (See Photo 1)
- (2) Remove the top panel. (See Photo 1)
- (3) Remove 2 front cover panel fixing screws (5 × 12) and remove the front cover panel. (See Photo 1)
- (4) Remove 4 back cover panel fixing screws (5 × 12) and remove the back cover panel.
- (5) Remove 3 valve bed fixing screws (4 × 10) and 4 stop valve fixing screws (5 × 16, 2 for gas and 2 for liquid) then remove the valve bed. (See Photo 18)
- (6) Remove 2 right side panel fixing screws (5 × 12) in the rear of the unit then remove the right side panel. (See Photo 18)
- (7) Remove the LEV coil. (See Photo 19)
- (8) Recover refrigerant.
- (9) Remove the welded part of LEV.

Note 1: Recover refrigerant without spreading it in the air.

Note 2: The welded part can be removed easily by removing the right side panel.

Note 3: When installing the LEV, cover it with a wet cloth to prevent it from heating (120°C or more), then braze the pipes so that the inside of pipes are not oxidized.

10. Removing the high pressure switch (63H)

- (1) Remove the service panel. (See Photo 1)
- (2) Remove the top panel. (See Photo 1)
- (3) Remove 2 front cover panel fixing screws (5 × 12) and remove the front cover panel. (See Photo 1)
- (4) Remove 4 back cover panel fixing screws (5 × 12) and remove the back cover panel.
- (5) Remove 4 right side panel fixing screws (5 × 12) in the rear of the unit and remove the right side panel (See Photo 18)
- (6) Pull out the lead wire of high pressure switch. (See Photo 18)
- (7) Recover refrigerant.
- (8) Remove the welded part of high pressure switch.

Note 1: Recover refrigerant without spreading it in the air.

Note 2: The welded part can be removed easily by removing the right side panel.

Note 3: When installing the high pressure switch, cover it with a wet cloth to prevent it from heating (100°C or more), then braze the pipes so that the inside of pipes are not oxidized.

PHOTOS/FIGURES

Photo 18

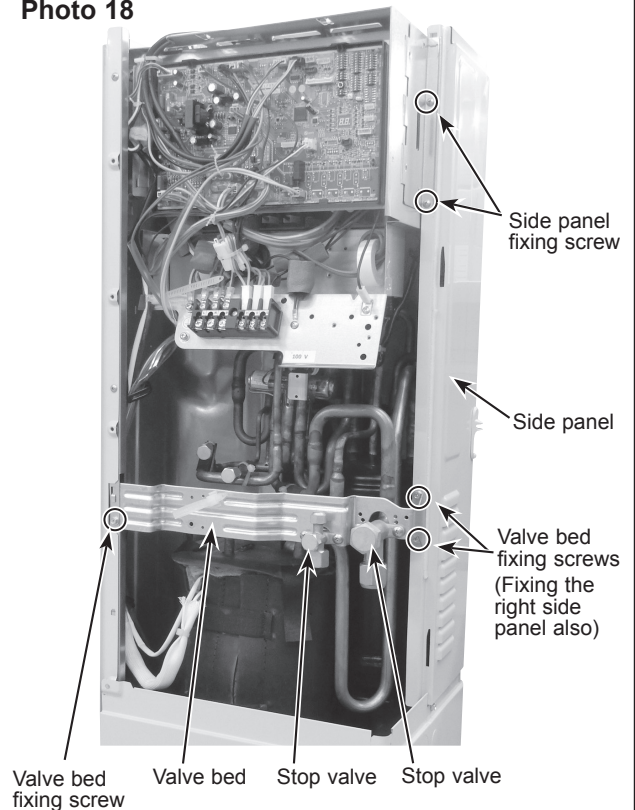
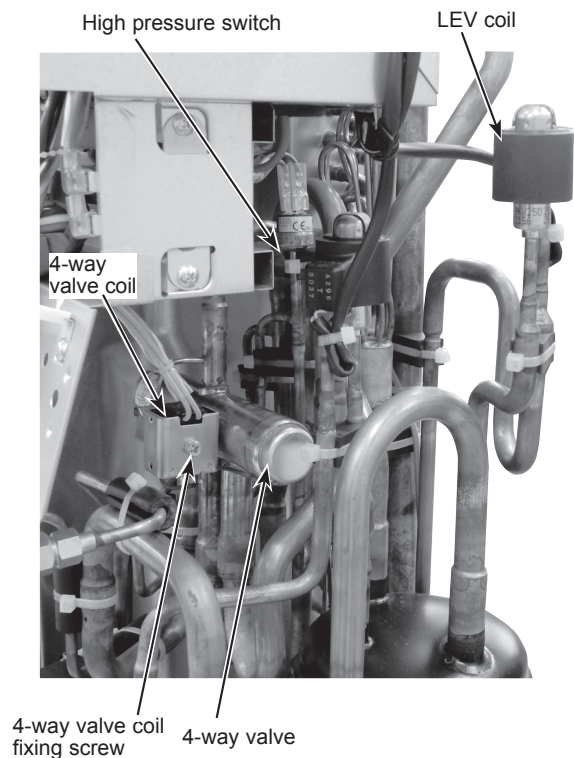

Photo 19



OPERATING PROCEDURE

11. Removing the 4-way valve coil (21S4)

- (1) Remove the service panel. (See Photo 1)

[Removing the 4-way valve coil]

- (2) Remove 4-way valve coil fixing screw (M5 × 6.5).
- (3) Remove the 4-way valve coil by sliding the coil toward you.
- (4) Disconnect the connector 21S4 (green) on the outdoor multi controller circuit board in the electrical parts box.

12. Removing the 4-way valve

- (1) Remove the service panel. (See Photo 1)
- (2) Remove the top panel. (See Photo 1)
- (3) Remove the electrical parts box (See Photo 4)
- (4) Remove 3 valve bed fixing screws (5 × 12) and 8 stop valve fixing screws (5 × 16) and then remove the valve bed. (See Photo 18)
- (5) Remove 4 right side panel fixing screw (5 × 12) in the rear of the unit and then remove the right side panel.
- (6) Remove the 4-way valve coil. (See Photo 19)
- (7) Recover refrigerant.
- (8) Remove the welded part of 4-way valve.

Note 1: Recover refrigerant without spreading it in the air.

Note 2: The welded part can be removed easily by removing the right side panel.

Note 3: When installing the 4-way valve, cover it with a wet cloth to prevent it from heating (120°C or more), then braze the pipes so that the inside of pipes are not oxidized.

13. Removing the compressor (MC)

- (1) Remove the service panel. (See Photo 1)
- (2) Remove the top panel. (See Photo 1)
- (3) Remove 2 front cover panel fixing screws (5 × 12) and remove the front cover panel. (See Photo 1)
- (4) Remove 3 valve bed fixing screws (5 × 12) and 4 stop valve fixing screws (5 × 16, 2 for gas and 2 for liquid) and then remove the valve bed.
- (5) Remove the nut from the terminal cover. (See Photo 17)
- (6) Remove the terminal cover to disconnect the compressor lead wire.
- (7) Recover refrigerant.
- (8) Remove the 3 points of the compressor fixing nut using a spanner or an adjustable wrench.
- (9) Remove the welded pipe of compressor inlet and outlet and then remove the compressor.

Note: Recover refrigerant without spreading it in the air.

PHOTOS/FIGURES

Photo 20

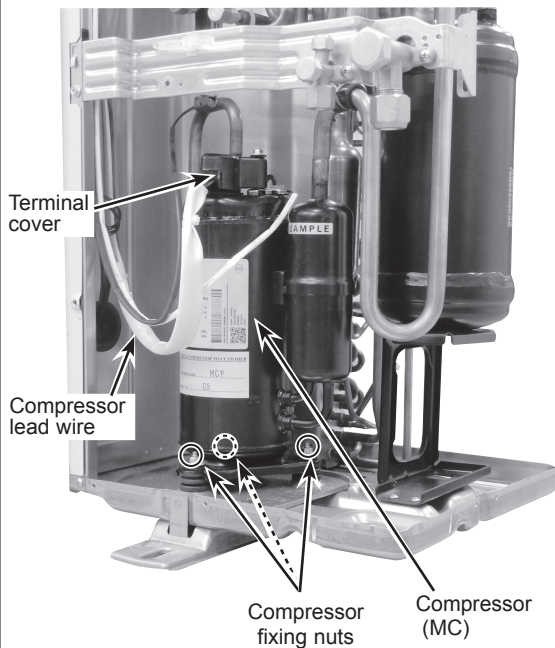

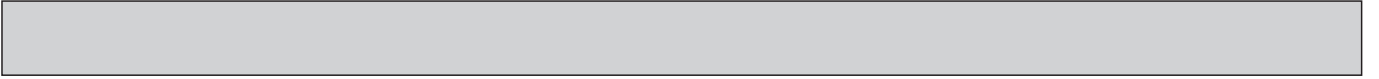

Mr. SLIM

mitsubishi electric corporation

HEAD OFFICE : TOKYO BUILDING, 2-7-3, MARUNOUCHI, CHIYODA-KU, TOKYO 100-8310, JAPAN