

# PARTS CATALOG

---

[Model Name]	[Service Ref.]
PAC-IF071B-E	<b>PAC-IF071B-E</b>
PAC-IF072B-E	<b>PAC-IF072B-E</b>
PAC-IF073B-E	<b>PAC-IF073B-E</b>

Revision:

- 1.SERVICE PARTS LIST has been changed.
- Some descriptions have been modified in REVISED EDITION-A.

OCB713 is void.

---

## CONTENTS

---

1. SERVICE PARTS LIST .....	2
2. OPTIONAL PARTS .....	4

PAC-IF071B-E

PAC-IF072B-E

PAC-IF073B-E

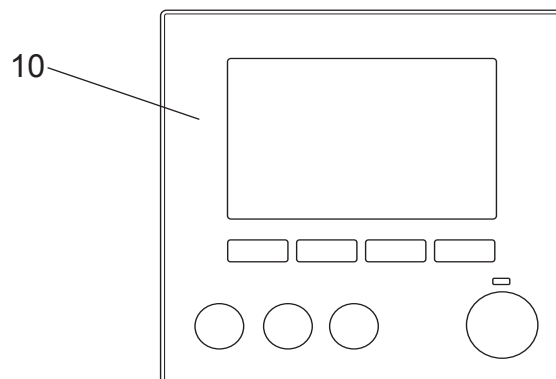
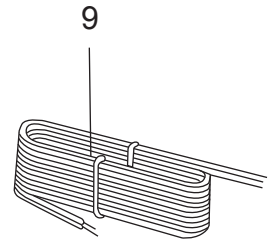
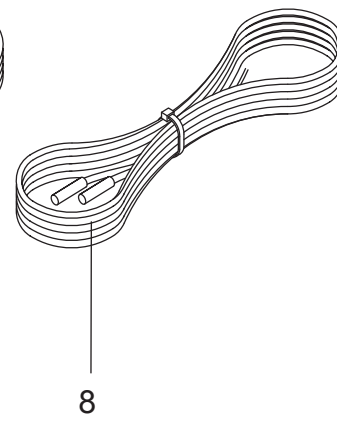
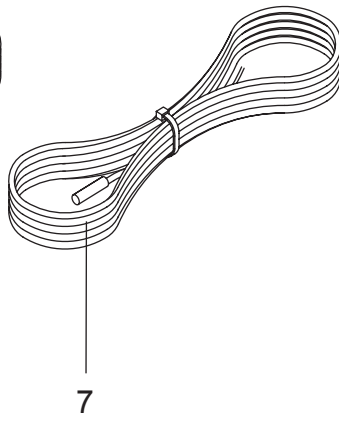
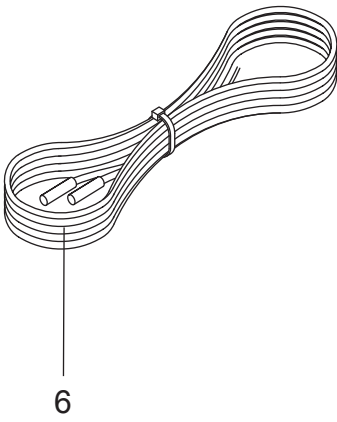
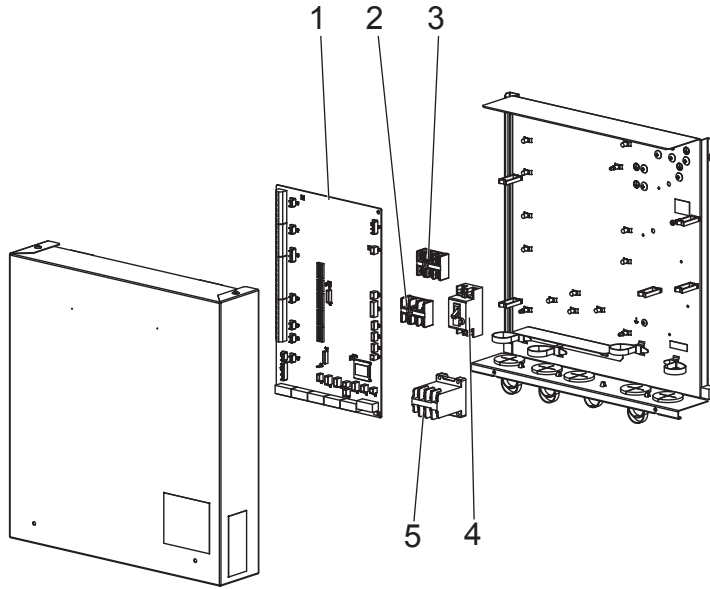

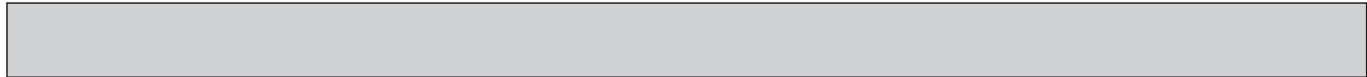

1. The part quantity below indicates the required number of pieces per unit.
2. The circled No. indicates that the part is not shown in the figure.

No	Parts No.	Parts Name	PAC-IF071B-E	PAC-IF072B-E	PAC-IF073B-E	Wiring diagram symbol	Remarks
1	S70 C66 315	ATW CONTROLLER	1	1	1		
2	S70 E08 716	TERMINAL BED	1	1	1		3P/ (#250LNE)
3	S70 C10 716	TERMINAL BED	1	1	1		3P/ (S1/S2/S3)
4	S70 C20 239	EARTH LEAKAGE BREAKER		1	1		1Ø 20 A
5	S70 C39 708	CONTACTOR		1	1		
6	S70 C90 202	THERMISTOR (Flow water temp & return water temp)	1	1		THW1/2	5 m/ 5 m
	S70 C65 202	THERMISTOR (Flow water temp & return water temp)			1	THW1/2	1.1 m/ 1.2 m
7	S70 C11 202	THERMISTOR (Liquid refrigerant temp)	1			TH2	5 m
8	S70 C68 202	THERMISTOR (Tank water temp)			1	THW5	1.8 m
9	S70 030 305	REMOCON CABLE	1	1	1		10 m
10	S70 C25 200	REMOCON ASSY	1	1	1		

**2****OPTIONAL PARTS**

<b>Parts name</b>	<b>Parts No.</b>
WIRELESS REMOTE CONTROLLER	PAR-WT50R-E
WIRELESS RECEIVER	PAR-WR51R-E
REMOTE SENSOR	PAC-SE41TS-E

**mitsubishi electric corporation**

HEAD OFFICE: TOKYO BUILDING, 2-7-3, MARUNOUCHI, CHIYODA-KU, TOKYO 100-8310, JAPAN