

# ecodan

## Wireless Remote Controller

### PAR-WT50R-E

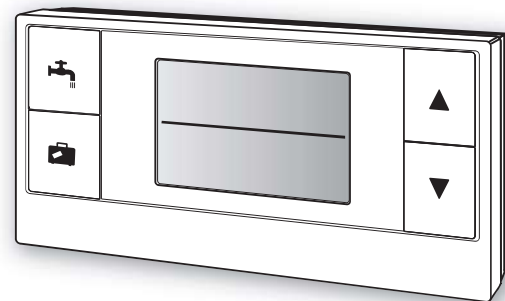

## Operation Manual

For safe and correct use, please read this operation manual thoroughly before operating the PAR-WT50R-E wireless remote controller.

FOR USER

English (EN)

## Bedienungsanleitung

Lesen Sie sich zur sicheren und korrekten Verwendung diese Bedienungsanleitung bitte sorgfältig durch, bevor Sie die drahtlose Fernbedienung PAR-WT50R-E verwenden.

FÜR NUTZER

Deutsch (DE)

## Mode d'emploi

Pour garantir une utilisation sûre et appropriée, lisez attentivement le présent mode d'emploi avant d'utiliser la télécommande sans fil PAR-WT50R-E.

POUR LES UTILISATEURS

Français (FR)

## Handleiding

Voor een veilig en juist gebruik moet u deze handleiding goed doorlezen alvorens de PAR-WT50R-E draadloze afstandsbediening in gebruik te nemen.

VOOR DE GEBRUIKER

Nederlands (NL)

## Manual de instrucciones

Para un uso correcto y seguro del control remoto inalámbrico PAR-WT50R-E, lea este manual de instrucciones antes de su utilización.

PARA EL USUARIO

Español (ES)

## Manuale di funzionamento

Per un uso corretto e sicuro del dispositivo, leggere attentamente il presente manuale di funzionamento prima di utilizzare il comando remoto senza fili PAR-WT50R-E.

PER L'UTENTE

Italiano (IT)

## Manual de Funcionamento

Para uma utilização segura e correcta, é favor ler cuidadosamente este manual de funcionamento antes de trabalhar com o controlador remoto sem fios PAR-WT50R-E.

PARA O UTILIZADOR

Português (PT)

## Brugsvejledning

Læs venligst denne brugsvejledning grundigt inden betjening af den trådløse fjernbetjening PAR-WT50R-E af hensyn til sikker og korrekt brug.

TIL BRUGER

Dansk (DA)

## Användarmanual

För säker och korrekt användning, var god läs denna användarmanual noggrant innan du använder PAR-WT50R-E-fjärrkontrollen.

FÖR ANVÄNDAREN

Svenska (SV)

## Bruksanvisning

Les denne bruksanvisningen nøye før du bruker PAR-WT50R-E-fjernkontrollen i bruk, for å sikre trygg og riktig bruk.

FOR BRUKEREN

Norsk (NO)

## Käyttöopas

Turvallisen ja asianmukaisen käytön varmistamiseksi lue tämä käyttöopas huolellisesti ennen langattoman PAR-WT50R-E-kaukosäätimen käyttöä.

KÄYTTÄJÄLLE

Suomi (FI)





Contents	
1. Safety Precautions .....	1
2. Product Outline.....	3
3. Names of Parts and Functions .....	4
4. Before Operation .....	5
5. Basic Functions .....	7
5.1.Changing Set Temperature.....	7
5.2.Forced DHW .....	8
5.3.Holiday Mode .....	9
6. F A Q .....	10
7. Specifications .....	10

# 1 Safety Precautions

Read thoroughly the following Safety Precautions before use.

- The following hazardous classification shows the likelihood and severity of hazards if a person does not follow the instructions contained on the following signs.

 <b>Warning</b>	Indicates a hazardous situation which, if a person does not follow the instructions, could result in death or serious injury.
 <b>Caution</b>	Indicates a potentially hazardous situation that, if a person does not follow the instructions, may result in bodily injury or property damage.

- Always keep this instruction manual ready at hand for quick reference. Provide this manual to the technician or installer in the event that the device is relocated or repaired. Or, if the ownership changes, hand this manual to the next owner.

 <b>Warning</b>	
Check installation location.	Ensure that the device is placed on a hard and stable place to prevent the device from falling.
The device must not be modified or repaired by the user.	Modification or improper repair could cause electrical shock or fire and the like. For repair, contact the dealer where you purchased the device.
Stop operation when the device is malfunctioning.	Operating the malfunctioning device without repairing it could cause breakdown, electrical shock, fire or the like. Should anything abnormal, such as burning smell, occur, stop operation immediately, turn off power, and contact the dealer.
The device must not be disposed of by the user.	To dispose of the device, contact the dealer.
Do not let alkaline batteries become shorted or insert with polarity reversed. Also, do not disassemble, heat, or throw batteries in fire.	Leaked strong alkaline electrolyte could get into your eye, or explode, or generate heat. Injury, burns, or breakdown of the device could result. Should strong alkaline electrolyte come in contact with the skin or clothes, flush electrolyte with clean water. If electrolyte gets into your eye, flush with clean water and seek medical attention immediately.

EN

## ⚠ Caution

Do not drop the device.	This could break the case or break down the device.
Do not wipe the device with benzine, thinner, and a chemical impregnated cloth or the like.	The device could be discolored and damaged. If the dirt is hard to remove, wipe it with a well wrung-out cloth with diluted mild detergent, and dry moisture with a dry cloth.
Do not put hazardous materials around the device.	Avoid installing the device in the place where flammable gas may leak. Should leaked gas build up around the device, fire or explosion could occur.
Do not disassemble the device.	Direct contact with the control board inside is hazardous and also could result in fire, breakdown, and reduction in operating performance.
Do not use the device in particular environments.	Do not use the device in particular environments where the following substances are present in large amounts: oil, vapour, organic solvent, corrosive gas (such as ammonia, sulphuric compounds, and acid or the like), or where acid or alkali solution, or particular sprays are used frequently. This could affect operating performance, or cause corrosion which could result in electrical shock, breakdown, smoke generation, or fire. (e.g. around kitchen sink, gas cooker, bath room, wash stand or the like)
Do not use sharp objects to press the buttons.	Electric shock or breakdown may occur.
Do not wash the device with water or solution or the like.	Electric shock or breakdown may occur.
Do not touch the device with wet hands.	Electric shock or breakdown may occur.
Always observe the operating temperature and humidity requirements.	Always observe the operating temperature and humidity requirements. Otherwise severe damage to the device could result. For more details, refer to the specification table in this manual.
<p>Observe the following and handle batteries properly. Otherwise it could result in explosion, leakage of electrolytic liquid, or heat generation.</p> <ol style="list-style-type: none"> <li>1) Do not charge the batteries.</li> <li>2) Place the batteries with correct polarities.</li> <li>3) Do not mix up new and old batteries or different types of batteries.</li> <li>4) When the batteries have run out, remove them from the device immediately.</li> </ol>	

EN

### ■ Disposal



**This symbol mark is for EU countries only.**

**This symbol mark is according to the directive 2002/96/EC Article 10 Information for users and Annex IV, and/or to the directive 2006/66/EC Article 20 Information for end-users and Annex II.**

Your MITSUBISHI ELECTRIC product is designed and manufactured with high quality materials and components which can be recycled and/or reused. This symbol means that electrical and electronic equipment, batteries and accumulators, at their end-of-life, should be disposed

of separately from your household waste. If a chemical symbol is printed beneath the symbol, this chemical symbol means that the battery or accumulator contains a heavy metal at a certain concentration.

This will be indicated as follows: Hg: mercury (0.0005%), Cd; cadmium (0.002 %), Pb: lead (0.004%)

In the European Union there are separate collection systems for used electrical and electronic products, batteries and accumulators.

Please, dispose of this equipment, batteries and accumulators correctly at your local community waste collection/recycling centre.

Please, help us to conserve the environment we live in!

## 2 Product Outline

This device is a wireless remote controller system that transmits to the indoor unit\* at a frequency of 868 MHz. The wireless remote controller allows the following settings without leaving your room: room temperature setting, forced DHW mode, and holiday mode.

Following are the features of the wireless remote controller:

- Room temperature is controlled according to the temperature monitored in a selected room.
- Up to 8 wireless remote controllers connectable.
- Holiday mode settings for up to 72 hours on hourly basis.
- Large buttons and easy-to-read LCD screen.
- Floor-to-floor wireless transmission such as from basement to floor level.

\* Each wireless remote controller requires pairing to avoid improper transmission with the unrelated wireless devices. If the wireless remote controller does not go through a pairing process, wireless transmission between the wireless remote controller and the wireless receiver does not work. For more details about pairing, contact your service contractor.

EN

The following operations are disabled when PAR-WT50/WR51R-E are connected to EH\*T20\*-\*M\*\*A, EH\*\*-\*M\*A models.

- Cancellation of Forced DHW
- 2-zone temperature control

### ■ Included parts

The following items are included in the box.

Part name	No.
① Wireless remote controller	1
② Stand	1
③ Bracket	1
④ Flat head screw 4.1 × 16	4
⑤ AA alkaline battery	2
⑥ Instruction manual	1

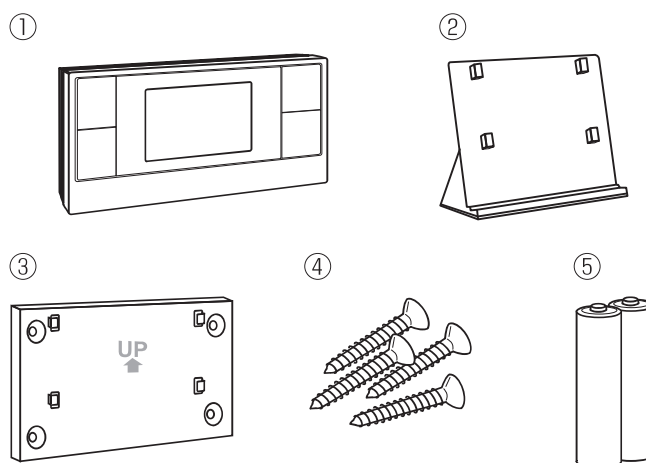

### ■ How to read the year of manufacture

The year of manufacture is indicated on the wireless remote controller and receiver as below.

L \* \* \* \* \* S   E \* \* \* \* \*

Month of manufacture : 1,2,3,4,5,6,7,8,9,X(10),Y(11),Z(12)

Year of manufacture (western calendar) 1=2021, 2=2022

### 3 Names of Parts and Functions

#### ■ Wireless remote controller buttons/displays

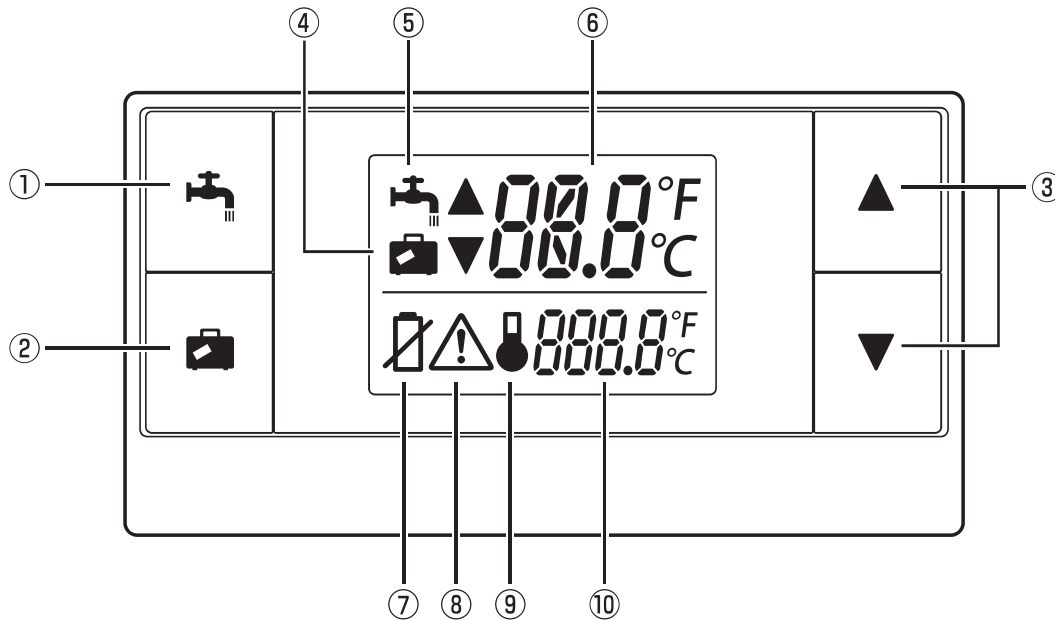

The following explains each button and operation.

\*All the items above are shown for the purpose of explanation.

Number	Name	Operation
①	Forced DHW button	To allow the ecodan system to force start of the DHW mode.
②	Holiday button	To allow the ecodan system to enter the holiday mode.
③	Up / Down button	To adjust room temperatures and set duration time in the holiday mode.
④	Holiday indicator	To indicate that the ecodan system is remaining in the holiday mode.
⑤	DHW indicator	To indicate that the ecodan system is remaining in the forced DHW mode.
⑥	Set temp. display	To display the set room temperature.
⑦	Battery replacement indicator	To indicate when to replace batteries.
⑧	Error indicator	To indicate a failure or error, such as a communication error.
⑨	Room sensor indicator	The internal temperature sensor in this wireless remote controller monitors the room temperature according to which individual room temperature is controlled.
⑩	Room temperature display	To display the room temperature measured by wireless remote controller.

## 4 Before Operation

Remove the battery case cover before placing the wireless remote controller, and place two AA alkaline batteries properly.

\* When the wireless remote controller is not paired, it has to go through a pairing process. For details about pairing, contact your service contractor.

### ■ Batteries

- When  is shown on the display, the batteries are running out. Replace both of them with two new AA alkaline batteries.
- Do not use Ni-Cd rechargeable batteries.
- The AA alkaline batteries used on the wireless remote controller last for about 1 year under normal usage.
- When not using the wireless remote controller for long periods of time, have the batteries removed.

#### ⚠ Caution

Always place batteries with correct polarities as indicated in the battery case.

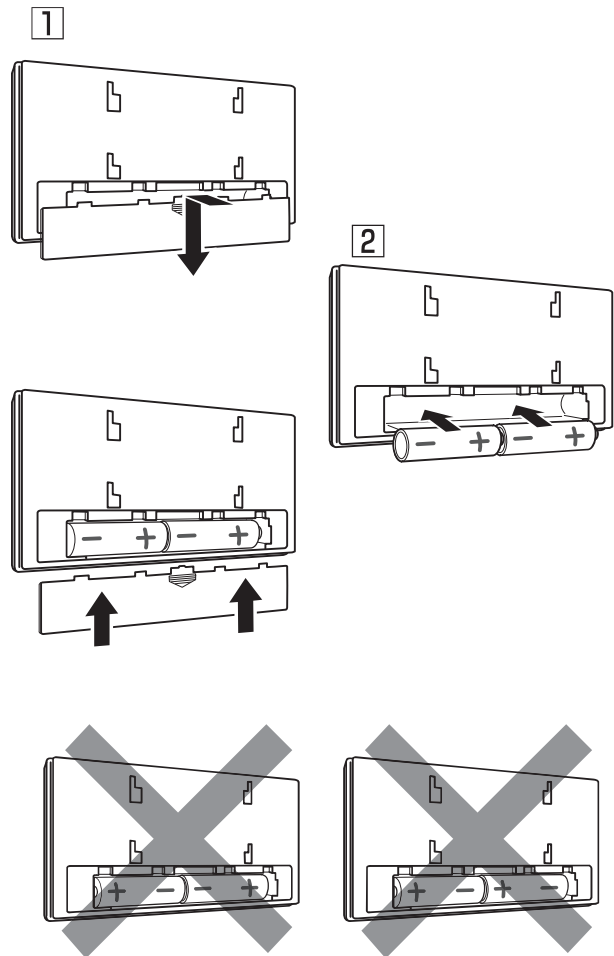

EN

### ■ Installation

The wireless remote controller has two methods of installation, using an included bracket or stand.

#### << Using a bracket >>

- 1 Determine the position to install the wireless remote controller.
- 2 Fix the bracket with flat head screws.
- 3 Mount the wireless remote controller onto the bracket.

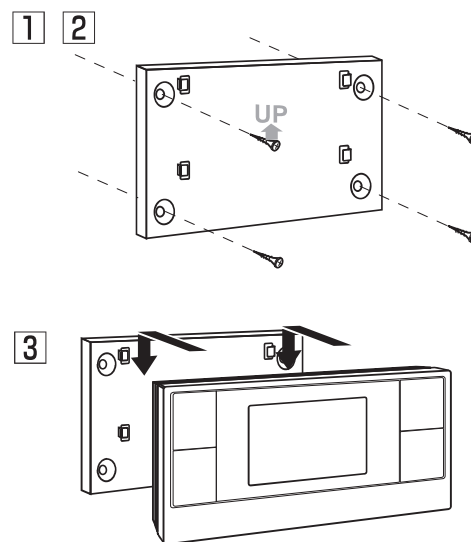

#### Note)

- Avoid over-tightening the screws, which may break or deform the bracket.
- To enhance stability, use all the four screws to secure the bracket.

## <<Using a stand >>

- 1 Place the wireless remote controller on the stand.
- 2 Place the stand in proper location.

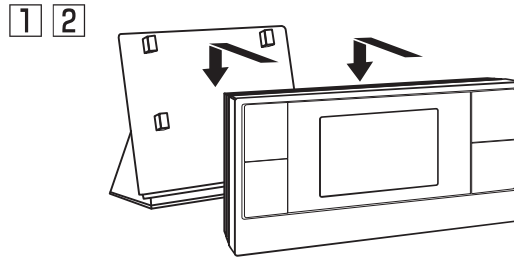

## ■ Location to place the wireless remote controller(s)

Observe the following when determining the installing location.

- 1 Do not place any other electric or electronic appliances within 1 m of the wireless remote controller. (E.g. radio, television, PC, mobile phone or the like.)
- 2 Do not place the wireless remote controller on a metal rack or the like.
- 3 Do not place the wireless remote controller in vicinity of a door or an window.
- 4 Do not place the wireless remote controller near heat or cold sources, such as a radiator or the like.
- 5 Keep the wireless remote controller away from direct sunlight.
- 6 Do not expose the remote controller to a temperature outside the required operating range of 0°C to 40°C.

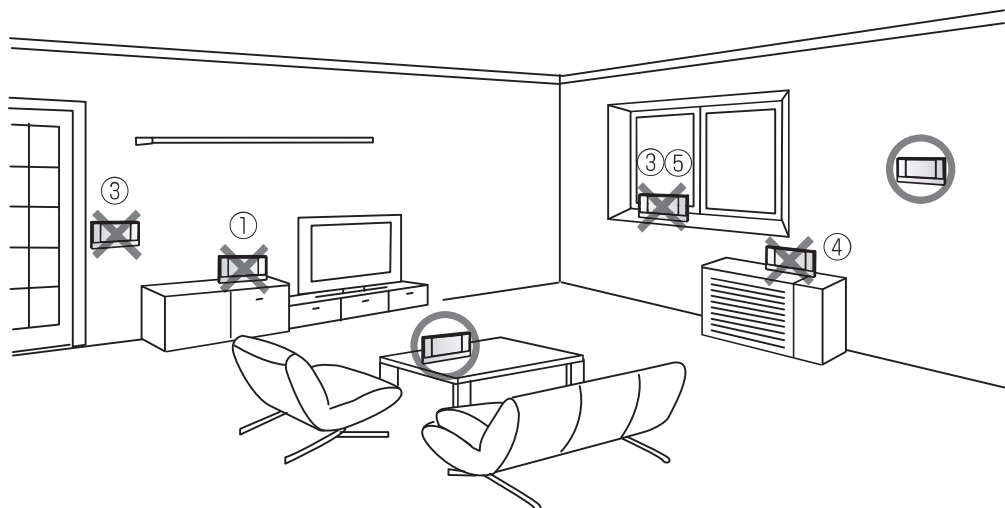

A room sensor is incorporated in each wireless remote controller. If a remote controller is set as room sensor monitoring the room temperature and the wireless remote controller is placed in an improper location, the desired temperature may not be obtained, so select the location to place the wireless remote controller with great care.



## 5 Basic Functions

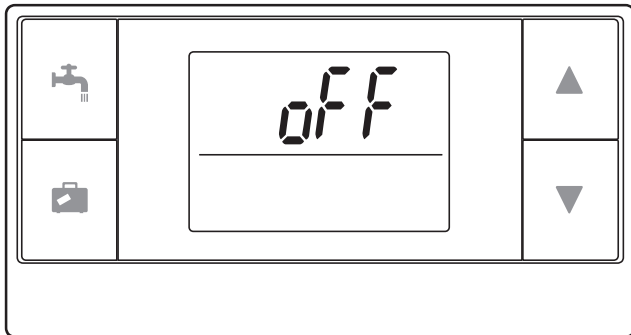

The following explains the basic functions available on the wireless remote controller.

<Ecodan system OFF>

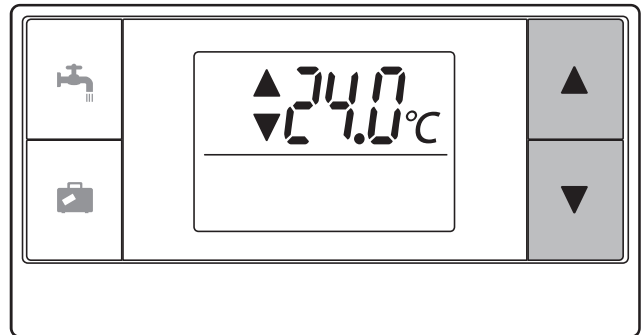

<Ecodan system ON>



- When the ecodan system is ON, hold down   buttons for 3 seconds to display a zone no. assigned to the remote controller.

- **Failure or error on the indoor unit, the outdoor unit, or the wireless system**  
When  is shown all the time, this means a failure (or error) on the indoor unit, the outdoor unit, or the wireless system. Contact your service contractor.

<Zone display>

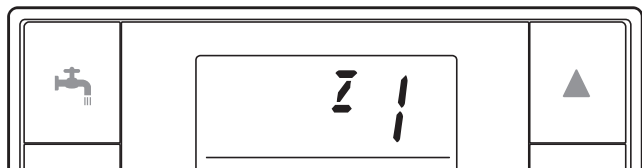

<Failure>

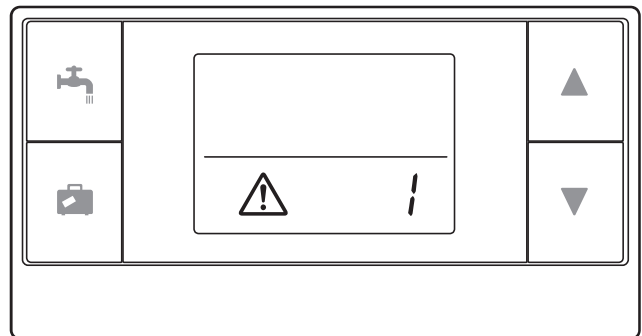

EN

### 5.1. Changing Set Temperature

To increase set temperature: Press  button.

To decrease set temperature: Press  button.

- Each press of the buttons adjusts the set temperature by 0.5°C.
- The set temperature range is from 10 to 30°C.
- When the automatic zone display is active, a zone number assigned to the remote controller is displayed for 3 seconds.

\* When “- - °C” is shown, the ecodan system cannot be operated by remote controller.

<Temperature adjustment >

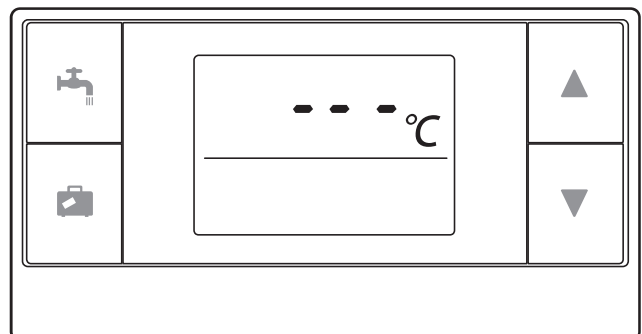
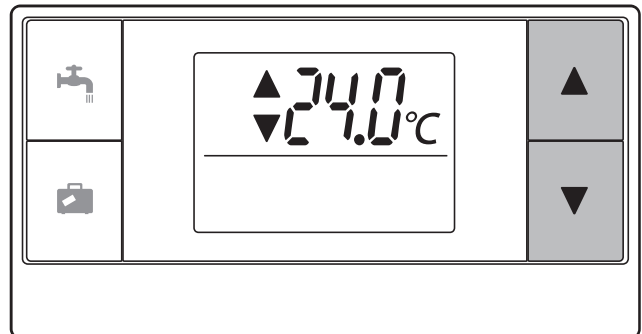

When  is shown, this indicates that the wireless remote controller is set as room sensor.

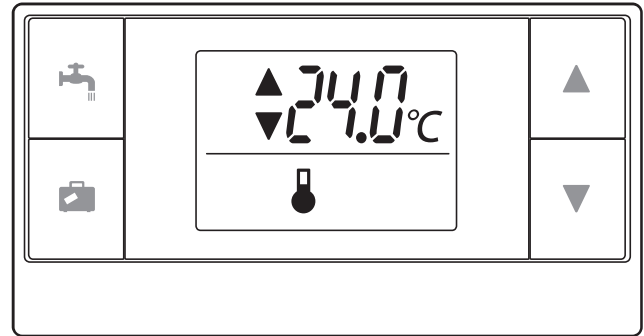

### <<2-zone temperature control>>

- A thermistor is built in the remote controller (Room RC) or the main controller (Main RC), or TH1. The indoor unit refers to temperature monitored by a selected thermistor and controls temperature for each zone.
- For 2-zone temperature control, one room sensor can be selected for Zone1 and Zone2 separately. The room sensor is used for monitoring room temperature.
- The selection of room sensor can be fixed or changed according to time, using a schedule timer.

**Note:** Room sensor can be selected by main controller only.

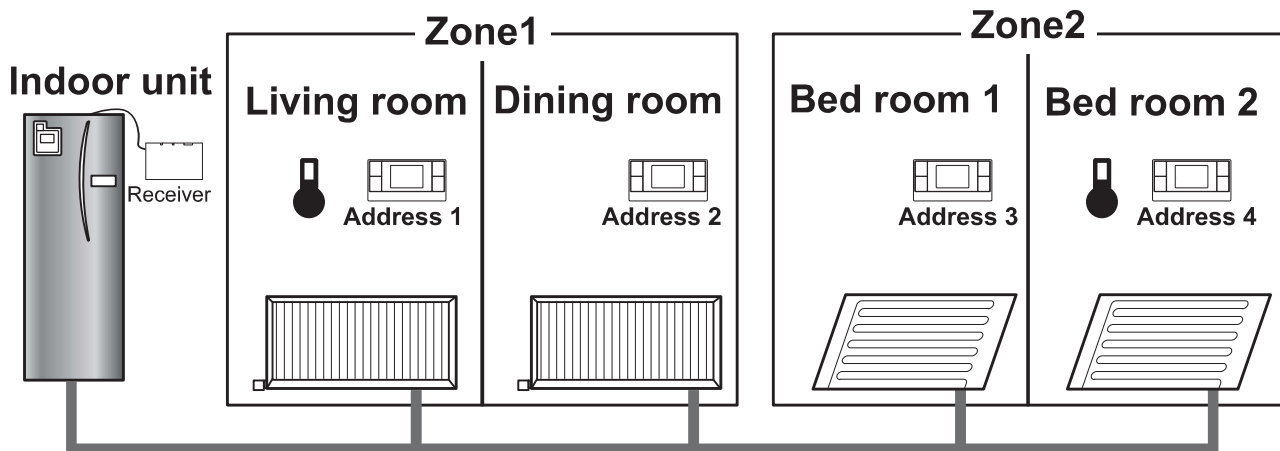



\* When  is shown on the remote controller, this indicates that the remote controller is used for monitoring the room temperature. In this example, the living room temperature monitored by remote controller 1 is regarded as the room temperature for Zone1. The bed room 2 temperature monitored by remote controller 4 is regarded as the room temperature for Zone2.

## 5.2. Forced DHW

Hold down  button for 3 seconds or more to allow the indoor unit to enter or exit the forced DHW mode.

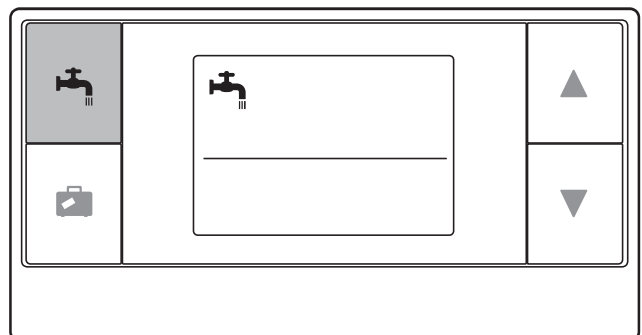
When the forced DHW mode ends,  goes out.







When  blinks after the button is held down for 3 seconds or more, this indicates that the indoor unit that you use does not support this function.



### 5.3. Holiday Mode

 button allows the indoor unit to enter the holiday mode.

- The holiday button is allowed to set duration of up to 72 hours or no-time-limit (displayed as “ --h ”).
- The duration is adjusted by 1 hour.



#### <<Setting>>

- 1 Hold down  button for 3 seconds or more.  blinks on the screen.
- 2 Press  or  button to adjust the duration, and press  button to save setting. When the set duration shows “ --h ”, this indicates that no-time-limit is set.

When transmission starts, ,  and  blink.

- 3 Once the setting is complete,  stops blinking and lights steadily.

#### <<Cancelling>>

To cancel the mode, hold down  button for 3 seconds or more while the indoor unit is operating in the holiday mode.  disappears.

#### <<Communication error>>

When  blinks during operation of the holiday mode, this means a communication error, so please try again.

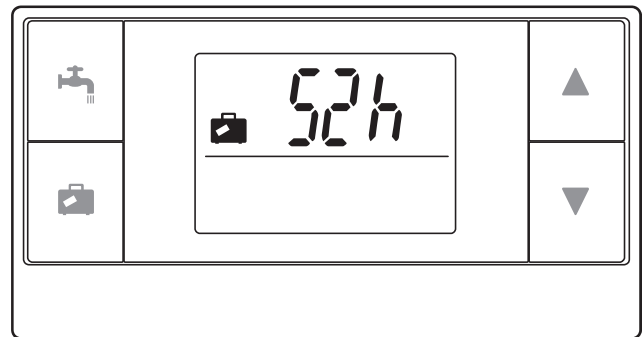
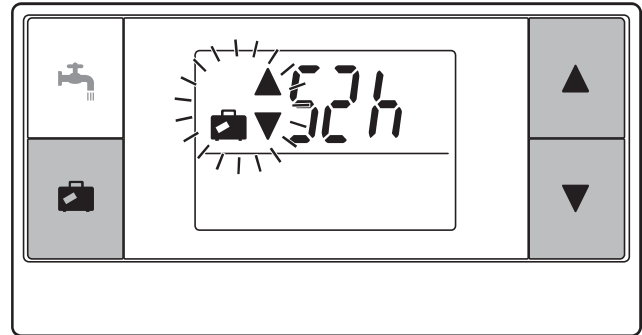
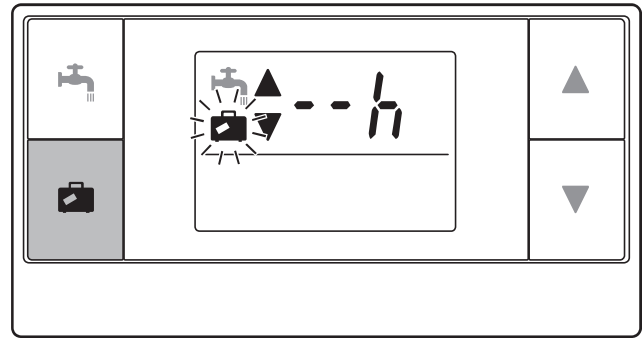

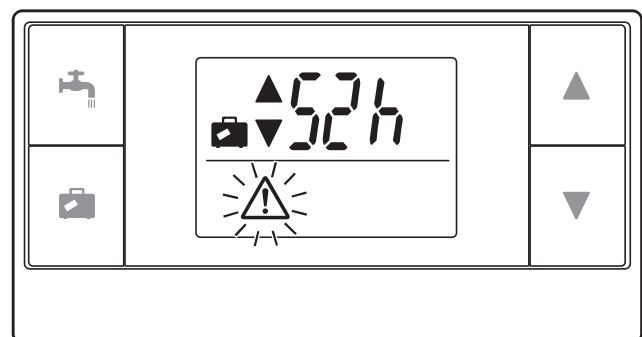

EN

#### <Communication error>



## 6 FAQ

Fault symptom	Possible causes	Solutions
The LCD is blank.	No batteries are placed.	Ensure that the batteries are placed in the battery case and no foreign objects are caught between the terminals.
	Batteries are placed incorrectly.	Check whether the batteries are placed with correct polarities as shown in the battery case.
	Batteries are running out.	Replace both with new ones.
 is shown.	The batteries are running out, and need replacement.	Replace both with new ones.
“OFF” is shown.	The ecodan system is off.	Turn on the ecodan system by main controller again.
The wireless remote controller does not work.	Batteries are running out.	Replace both with new ones.
	Signal is weak.	Find a proper location to operate the wireless remote controller.
	Failure or error on the indoor unit, the outdoor unit, or the wireless system.	Contact your service contractor.
 is shown all the time.	Failure or error on the indoor unit, the outdoor unit, or the wireless system.	Contact your service contractor.
The desired room temperature is not obtained.	Batteries are running out.	Replace both with new ones.
	The wireless remote controller is placed in an improper location.	Reposition the wireless remote controller by referring to “Location to place the wireless remote controller(s)” in “4. Before Operation” in this manual.
	The wireless remote controller is not set as room sensor.	Contact your service contractor.
	Others	Contact your service contractor.

EN

## 7 Specifications

Item	Description
Power source	3V DC (AA alkaline battery × 2)
Operating temperature and humidity requirements	Temperatures: 0 to 40°C Humidities: 30 to 90%RH (no condensation)
Net weight	200 g (batteries excluded)
Dimension (W × H × D)	140 mm × 75 mm × 18 mm
Holiday mode time setting range	1 to 72 hours or no time limit
Display	LCD digital screen
Transmitter power level (MAX)	8 dBm
Frequency	868.3 MHz

Hereby, MITSUBISHI ELECTRIC CORPORATION declares that the radio equipment type PAR-WT50R-E, PAR-WR51R-E is in compliance with Directive 2014/53/EU.

The full text of the EU declaration of conformity is available at the following internet address:

<https://www12.mitsubishielectric.com/>

Hiermit erklärt MITSUBISHI ELECTRIC CORPORATION, dass der Funkanlagentyp PAR-WT50R-E, PAR-WR51R-E der Richtlinie 2014/53/EU entspricht.

Der vollständige Text der EU-Konformitätserklärung ist unter der folgenden Internetadresse verfügbar:

<https://www12.mitsubishielectric.com/>

Le soussigné, MITSUBISHI ELECTRIC CORPORATION, déclare que l'équipement radioélectrique du type PAR-WT50R-E, PAR-WR51R-E est conforme à la directive 2014/53/UE.

Le texte complet de la déclaration UE de conformité est disponible à l'adresse internet suivante:

<https://www12.mitsubishielectric.com/>

Hierbij verklaar ik, MITSUBISHI ELECTRIC CORPORATION, dat het type radioapparatuur PAR-WT50R-E, PAR-WR51R-E conform is met Richtlijn 2014/53/EU.

De volledige tekst van de EU-conformiteitsverklaring kan worden geraadpleegd op het volgende internetadres:

<https://www12.mitsubishielectric.com/>

Por la presente, MITSUBISHI ELECTRIC CORPORATION declara que el tipo de equipo radioeléctrico PAR-WT50R-E, PAR-WR51R-E es conforme con la Directiva 2014/53/UE.

El texto completo de la declaración UE de conformidad está disponible en la dirección Internet siguiente:

<https://www12.mitsubishielectric.com/>

Il fabbricante, MITSUBISHI ELECTRIC CORPORATION, dichiara che il tipo di apparecchiatura radio PAR-WT50R-E, PAR-WR51R-E è conforme alla direttiva 2014/53/UE.

Il testo completo della dichiarazione di conformità UE è disponibile al seguente indirizzo Internet:

<https://www12.mitsubishielectric.com/>

O(a) abaixo assinado(a) MITSUBISHI ELECTRIC CORPORATION declara que o presente tipo de equipamento de rádio PAR-WT50R-E, PAR-WR51R-E está em conformidade com a Diretiva 2014/53/UE.

O texto integral da declaração de conformidade está disponível no seguinte endereço de Internet:

<https://www12.mitsubishielectric.com/>

Hermed erklærer MITSUBISHI ELECTRIC CORPORATION, at radioudstyrstypen PAR-WT50R-E, PAR-WR51R-E er i overensstemmelse med direktiv 2014/53/EU.

EU-overensstemmelseserklæringens fulde tekst kan findes på følgende internetadresse:

<https://www12.mitsubishielectric.com/>

Härmed försäkrar MITSUBISHI ELECTRIC CORPORATION att denna typ av radioutrustning PAR-WT50R-E, PAR-WR51R-E överensstämmer med direktiv 2014/53/EU.

Den fullständiga texten till EU-försäkran om överensstämmelse finns på följande webbadress:

<https://www12.mitsubishielectric.com/>

MITSUBISHI ELECTRIC CORPORATION erklærer at PAR-WT50R-E, PAR-WR51R-E er i overensstemmelse med direktiv 2014/53/EU.

Samsvarserklæringen i fulltekst er tilgjengelig på følgende internetadresse:

<https://www12.mitsubishielectric.com/>

MITSUBISHI ELECTRIC CORPORATION vakuuttaa, että radiolaitetyyppi PAR-WT50R-E, PAR-WR51R-E on direktiivin 2014/53/EU mukainen.

EU-vaatimustenmukaisuusvakuutuksen täysimittainen teksti on saatavilla seuraavassa internetosoitteessa:

<https://www12.mitsubishielectric.com/>

Hereby, MITSUBISHI ELECTRIC CORPORATION declares that the radio equipment type PAR-WT50R-E, PAR-WR51R-E is in compliance with the Radio Equipment Regulations 2017.  
The full text of the UK declaration of conformity is available at the following internet address:  
<https://www12.mitsubishielectric.com/>

This product is designed and intended for use in the residential,  
commercial and light-industrial environment.

### Importer:

Mitsubishi Electric Europe B.V.  
Capronilaan 46, 1119 NS, Schiphol Rijk, The Netherlands

French Branch  
2, Rue De L'Union, 92565 RUEIL MAISON Cedex

German Branch  
Mitsubishi-Electric-Platz 1 40882 Ratingen North Rhine-Westphalia Germany

Belgian Branch  
8210 Loppem, Autobaan 2, Belgium

Irish Branch  
Westgate Business Park, Ballymount Road, Upper Ballymount, Dublin 24, Ireland

Italian Branch  
Palazzo Sirio Ingresso 1, Via Colleoni, 7, 20864 Agrate Brianza (MI), Italy

Norwegian Branch  
Gneisveien 2D, 1914 Ytre Enebakk, Norway

Portuguese Branch  
Avda. do Forte 10, 2794-019 Carnaxide, Lisbon, Portugal

Spanish Branch  
Av. Castilla, 2 Parque Empresarial San Fernando - Ed. Europa, 28830 San Fernando de  
Henares (Madrid), Spain

Scandinavian Branch  
Hammarbacken 14, P.O. Box 750 SE-19127, Sollentuna, Sweden

UK Branch  
Travellers Lane, Hatfield, Hertfordshire, AL10 8XB, United Kingdom

Polish Branch  
Krakowska 48, PL-32-083 Balice, Poland

ООО «Мицубиси Электрик (РУС)»  
115114, Российская Федерация, г. Москва, ул. Летниковская, д. 2, стр. 1, 5 этаж

Please be sure to put the contact address/telephone number on  
this manual before handing it to the customer.



**MITSUBISHI ELECTRIC CORPORATION**

BH79R517H09

HEAD OFFICE: TOKYO BUILDING, 2-7-3, MARUNOUCHI, CHIYODA-KU, TOKYO 100-8310, JAPAN