

# SERVICE MANUAL

**[Model Name]**

<b>EHPT17X-VM2D</b>	<b>EHST20D-MED</b>	<b>ERST17D-VM2BD</b>
<b>EHPT17X-VM6D</b>	<b>EHST20D-TM9D</b>	<b>ERST17D-VM2D</b>
<b>EHPT17X-YM9D</b>	<b>EHST20D-VM2D</b>	<b>ERST17D-VM6BD</b>
<b>EHPT20X-MED</b>	<b>EHST20D-VM6D</b>	<b>ERST17D-VM6D</b>
<b>EHPT20X-MHEDW</b>	<b>EHST20D-YM9D</b>	<b>ERST17D-YM9BD</b>
<b>EHPT20X-TM9D</b>	<b>EHST20D-YM9ED</b>	<b>ERST20C-VM2D</b>
<b>EHPT20X-VM6D</b>	<b>EHST30C-MED</b>	<b>ERST20C-VM6D</b>
<b>EHPT20X-YM9D</b>	<b>EHST30C-TM9ED</b>	<b>ERST20C-YM9D</b>
<b>EHPT20X-YM9ED</b>	<b>EHST30C-VM6ED</b>	<b>ERST20D-VM2D</b>
<b>EHPT30X-MED</b>	<b>EHST30C-YM9ED</b>	<b>ERST20D-VM6D</b>
<b>EHPT30X-YM9ED</b>	<b>EHST30D-MED</b>	<b>ERST20D-YM9D</b>
<b>EHST17D-VM2D</b>	<b>EHST30D-TM9ED</b>	<b>ERST30C-VM2ED</b>
<b>EHST17D-YM9D</b>	<b>EHST30D-VM6ED</b>	<b>ERST30C-VM6ED</b>
<b>EHST20C-MED</b>	<b>EHST30D-YM9ED</b>	<b>ERST30C-YM9ED</b>
<b>EHST20C-TM9D</b>	<b>ERPT17X-VM2D</b>	<b>ERST30D-VM2ED</b>
<b>EHST20C-VM2D</b>	<b>ERPT20X-MD</b>	<b>ERST30D-VM6ED</b>
<b>EHST20C-VM6D</b>	<b>ERPT20X-VM2D</b>	<b>ERST30D-YM9ED</b>
<b>EHST20C-YM9D</b>	<b>ERPT20X-VM6D</b>	
<b>EHST20C-YM9ED</b>	<b>ERPT30X-VM2ED</b>	

**Revision:**

Connectable outdoor units have been added in REVISED-EDITION-E.

OCH714D is void.

**Note:**

This manual describes service data of cylinder unit only.

**[Service Ref.]**

Refer to page 2.

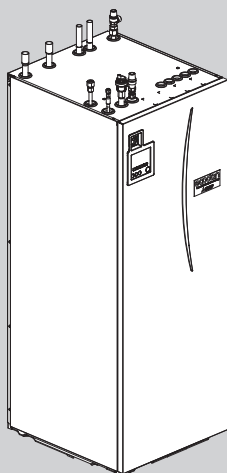

CYLINDER UNIT

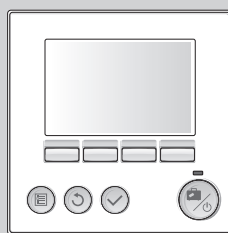

MAIN REMOTE CONTROLLER

## CONTENTS

<b>TECHNICAL CHANGES</b> .....	<b>3</b>
<b>1. REFERENCE MANUAL</b> .....	<b>4</b>
<b>2. SAFETY PRECAUTION</b> .....	<b>5</b>
<b>3. SPECIFICATIONS</b> .....	<b>7</b>
<b>4. PART NAMES AND FUNCTIONS</b> .....	<b>11</b>
<b>5. OUTLINES AND DIMENSIONS</b> .....	<b>14</b>
<b>6. WIRING DIAGRAM</b> .....	<b>16</b>
<b>7. FIELD WIRING</b> .....	<b>25</b>
<b>8. WATER SYSTEM DIAGRAM</b> .....	<b>29</b>
<b>9. CONTROLS</b> .....	<b>33</b>
<b>10. TROUBLESHOOTING</b> .....	<b>54</b>
<b>11. DISASSEMBLY PROCEDURE</b> .....	<b>72</b>
<b>12. SUPPLEMENTARY INFORMATION</b> .....	<b>96</b>
<b>13. SERVICE AND MAINTENANCE</b> .....	<b>97</b>

**PARTS CATALOG (OCB714)**

[Service Ref.]

EHPT17X-VM2D.UK	EHST20D-VM2DR1.UK	ERST20C-VM6DR1.UK
EHPT17X-VM2DR1.UK	EHST20D-VM6D.UK	ERST20C-YM9DR1.UK
EHPT17X-VM6D.UK	EHST20D-VM6DR1.UK	ERST20D-VM2D.UK
EHPT17X-VM6DR1.UK	EHST20D-YM9D.UK	ERST20D-VM2DR1.UK
EHPT17X-YM9D.UK	EHST20D-YM9DR1.UK	ERST20D-VM6DR1.UK
EHPT17X-YM9DR1.UK	EHST20D-YM9ED.UK	ERST20D-YM9DR1.UK
EHPT20X-MED.UK	EHST20D-YM9EDR1.UK	ERST30C-VM2ED.UK
EHPT20X-MEDR1.UK	EHST30C-MED.UK	ERST30C-VM2EDR1.UK
EHPT20X-MHEDW.UK	EHST30C-MEDR1.UK	ERST30C-VM6EDR1.UK
EHPT20X-MHEDWR1.UK	EHST30C-TM9ED.UK	ERST30C-YM9EDR1.UK
EHPT20X-TM9D.UK	EHST30C-TM9EDR1.UK	ERST30D-VM2ED.UK
EHPT20X-TM9DR1.UK	EHST30C-VM6ED.UK	ERST30D-VM2EDR1.UK
EHPT20X-VM6D.UK	EHST30C-VM6EDR1.UK	ERST30D-VM6EDR1.UK
EHPT20X-VM6DR1.UK	EHST30C-YM9ED.UK	ERST30D-YM9EDR1.UK
EHPT20X-YM9D.UK	EHST30C-YM9EDR1.UK	
EHPT20X-YM9DR1.UK	EHST30D-MED.UK	
EHPT20X-YM9ED.UK	EHST30D-MEDR1.UK	
EHPT20X-YM9EDR1.UK	EHST30D-TM9ED.UK	
EHPT30X-MED.UK	EHST30D-TM9EDR1.UK	
EHPT30X-MEDR1.UK	EHST30D-VM6ED.UK	
EHPT30X-YM9ED.UK	EHST30D-VM6EDR1.UK	
EHPT30X-YM9EDR1.UK	EHST30D-YM9ED.UK	
EHST17D-VM2D.UK	EHST30D-YM9EDR1.UK	
EHST17D-VM2DR1.UK	ERPT17X-VM2D.UK	
EHST17D-YM9DR1.UK	ERPT17X-VM2DR1.UK	
EHST20C-MED.UK	ERPT20X-MD.UK	
EHST20C-MEDR1.UK	ERPT20X-MDR1.UK	
EHST20C-TM9D.UK	ERPT20X-VM2D.UK	
EHST20C-TM9DR1.UK	ERPT20X-VM2DR1.UK	
EHST20C-VM2D.UK	ERPT20X-VM6D.UK	
EHST20C-VM2DR1.UK	ERPT20X-VM6DR1.UK	
EHST20C-VM6D.UK	ERPT30X-VM2ED.UK	
EHST20C-VM6DR1.UK	ERPT30X-VM2EDR1.UK	
EHST20C-YM9D.UK	ERPT30X-VM6EDR1.UK	
EHST20C-YM9DR1.UK	ERST17D-VM2BD.UK	
EHST20C-YM9ED.UK	ERST17D-VM2D.UK	
EHST20C-YM9EDR1.UK	ERST17D-VM2DR1.UK	
EHST20D-MED.UK	ERST17D-VM6BD.UK	
EHST20D-MEDR1.UK	ERST17D-VM6DR1.UK	
EHST20D-TM9D.UK	ERST17D-YM9BD.UK	
EHST20D-TM9DR1.UK	ERST20C-VM2D.UK	
EHST20D-VM2D.UK	ERST20C-VM2DR1.UK	

## TECHNICAL CHANGES

Service ref. have been changed as follows.

EHST17D-VM2D.UK	→	EHST17D-VM2DR1.UK
ERST17D-VM2D.UK	→	ERST17D-VM2DR1.UK
EHST20D-MED.UK	→	EHST20D-MEDR1.UK
EHST20D-VM2D.UK	→	EHST20D-VM2DR1.UK
EHST20D-VM6D.UK	→	EHST20D-VM6DR1.UK
EHST20D-YM9D.UK	→	EHST20D-YM9DR1.UK
EHST20D-YM9ED.UK	→	EHST20D-YM9EDR1.UK
EHST20D-TM9D.UK	→	EHST20D-TM9DR1.UK
ERST20D-VM2D.UK	→	ERST20D-VM2DR1.UK
EHST30D-MED.UK	→	EHST30D-MEDR1.UK
EHST30D-VM6ED.UK	→	EHST30D-VM6EDR1.UK
EHST30D-YM9ED.UK	→	EHST30D-YM9EDR1.UK
EHST30D-TM9ED.UK	→	EHST30D-TM9EDR1.UK
ERST30D-VM2ED.UK	→	ERST30D-VM2EDR1.UK
EHST20C-MED.UK	→	EHST20C-MEDR1.UK
EHST20C-VM2D.UK	→	EHST20C-VM2DR1.UK
EHST20C-VM6D.UK	→	EHST20C-VM6DR1.UK
EHST20C-YM9D.UK	→	EHST20C-YM9DR1.UK
EHST20C-YM9ED.UK	→	EHST20C-YM9EDR1.UK
EHST20C-TM9D.UK	→	EHST20C-TM9DR1.UK
ERST20C-VM2D.UK	→	ERST20C-VM2DR1.UK
EHST30C-MED.UK	→	EHST30C-MEDR1.UK
EHST30C-VM6ED.UK	→	EHST30C-VM6EDR1.UK
EHST30C-YM9ED.UK	→	EHST30C-YM9EDR1.UK
EHST30C-TM9ED.UK	→	EHST30C-TM9EDR1.UK
ERST30C-VM2ED.UK	→	ERST30C-VM2EDR1.UK
EHPT17X-VM2D.UK	→	EHPT17X-VM2DR1.UK
EHPT17X-VM6D.UK	→	EHPT17X-VM6DR1.UK
EHPT17X-YM9D.UK	→	EHPT17X-YM9DR1.UK
ERPT17X-VM2D.UK	→	ERPT17X-VM2DR1.UK
EHPT20X-MED.UK	→	EHPT20X-MEDR1.UK
EHPT20X-VM6D.UK	→	EHPT20X-VM6DR1.UK
EHPT20X-YM9D.UK	→	EHPT20X-YM9DR1.UK
EHPT20X-YM9ED.UK	→	EHPT20X-YM9EDR1.UK
EHPT20X-TM9D.UK	→	EHPT20X-TM9DR1.UK
EHPT20X-MHEDW.UK	→	EHPT20X-MHEDWR1.UK
ERPT20X-MD.UK	→	ERPT20X-MDR1.UK
ERPT20X-VM2D.UK	→	ERPT20X-VM2DR1.UK
ERPT20X-VM6D.UK	→	ERPT20X-VM6DR1.UK
EHPT30X-MED.UK	→	EHPT30X-MEDR1.UK
EHPT30X-YM9ED.UK	→	EHPT30X-YM9EDR1.UK
ERPT30X-VM2ED.UK	→	ERPT30X-VM2EDR1.UK

• 5 bar PRV has been added.

## OUTDOOR UNIT'S SERVICE MANUAL

	Service Ref.	Service Manual No.
Split model	SUZ-SWM40VA.TH SUZ-SWM60VA.TH SUZ-SWM80VA.TH	OCH718 OCB718
	PUHZ-FRP71VHA2 PUHZ-FRP71VHA2R1	OCH665 OCB665
	PUHZ-SW120VHAR5(-BS).UK PUHZ-SW120YHAR5(-BS).UK	OCH533 OCB533
	PUHZ-SHW140YHAR5(-BS).UK	OCH526 OCB526
	PUHZ-SHW80VAA(-BS).UK PUHZ-SHW80YAA(-BS).UK PUHZ-SHW112VAA(-BS).UK PUHZ-SHW112YAA(-BS).UK PUHZ-SW75VAA(-BS).UK PUHZ-SW75YAA(-BS).UK PUHZ-SW75VAA-SC.UK PUHZ-SW75YAA-SC.UK PUHZ-SW100VAA(-BS).UK PUHZ-SW100YAA(-BS).UK	OCH651 OCB651
	PUMY-P112VKM4R4(-BS).UK PUMY-P125VKM4R4(-BS).UK PUMY-P140VKM4R4(-BS).UK PUMY-P112YKM4R4(-BS).UK PUMY-P125YKM4R4(-BS).UK PUMY-P140YKM4R4(-BS).UK PUMY-P112YKME4R4(-BS).UK PUMY-P125YKME4R4(-BS).UK PUMY-P140YKME4R4(-BS).UK	OCH673 OCB673
	PUMY-P112VKM5(-BS) PUMY-P125VKM5(-BS) PUMY-P140VKM5(-BS) PUMY-P112VKM5-ET(BS) PUMY-P125VKM5-ET(BS) PUMY-P140VKM5-ET(BS) PUMY-P112VKM5-ER(BS) PUMY-P125VKM5-ER(BS) PUMY-P140VKM5-ER(BS)	OCH740 OCB740
	PUD-SWM60VAA(-BS).UK PUD-SWM80VAA(-BS).UK PUD-SWM80YAA(-BS).UK PUD-SWM100VAA(-BS).UK PUD-SWM100YAA(-BS).UK PUD-SWM120VAA(-BS).UK PUD-SWM120YAA(-BS).UK PUD-SHWM60VAA(-BS).UK PUD-SHWM80VAA(-BS).UK PUD-SHWM80YAA(-BS).UK PUD-SHWM100VAA(-BS).UK PUD-SHWM100YAA(-BS).UK PUD-SHWM120VAA(-BS).UK PUD-SHWM120YAA(-BS).UK PUD-SHWM140YAA(-BS).UK	OCH694 OCB694
	PXZ-4F75VG-E(T)1 PXZ-5F85VG-E(T)1	OBH923 OBB923
	Packaged model	PUZ-WM50VHA(-BS).UK PUZ-WM60VAA(-BS).UK PUZ-WM85VAA(-BS).UK PUZ-WM85YAA(-BS).UK PUZ-WM112VAA(-BS).UK PUZ-WM112YAA(-BS).UK
PUZ-HWM140VHA(-BS) PUZ-HWM140YHA(-BS)		OCH748 OCB748

Please read the following safety precautions carefully.

**⚠ WARNING:**





Precautions that must be observed to prevent injuries or death.

**⚠ CAUTION:**

Precautions that must be observed to prevent damage to unit.

- Be sure to perform periodical maintenance.
- Be sure to follow your local regulations.
- Be sure to follow the instructions provided in this manual.

### MEANINGS OF SYMBOLS DISPLAYED ON THE UNIT

	<b>WARNING</b> (Risk of fire)	This mark is for R32 refrigerant only. Refrigerant type is written on nameplate of outdoor unit. In case that refrigerant type is R32, this unit uses a flammable refrigerant. If refrigerant leaks and comes in contact with fire or heating part, it will create harmful gas and there is risk of fire.
		Read the OPERATION MANUAL carefully before operation.
		Service personnel are required to carefully read the OPERATION MANUAL and INSTALLATION MANUAL before operation.
		Further information is available in the OPERATION MANUAL, INSTALLATION MANUAL, and the like.

### ⚠ ⚠ WARNING

#### Mechanical

- The cylinder unit and outdoor unit must not be installed, disassembled, relocated, altered or repaired by the user. Ask an authorised installer or technician. If the unit is installed improperly or modified after installation by the user, water leakage, electric shock or fire may result.
- The outdoor unit should be securely fixed to a hard level surface capable of bearing its weight.
- The cylinder unit should be positioned on a hard level surface capable of supporting its filled weight to prevent excessive sound or vibration.
- Do not position furniture or electrical appliances below the outdoor unit or cylinder unit.
- The discharge pipework from the emergency devices of the cylinder unit should be installed according to local law.
- Only use accessories and replacement parts authorised by Mitsubishi Electric ask a qualified technician to fit the parts.

#### Electrical

- All electrical work should be performed by a qualified technician according to local regulations and the instructions given in this manual.
- The units must be powered by a dedicated power supply and the correct voltage and circuit breakers must be used.
- Wiring should be in accordance with national wiring regulations. Connections must be made securely and without tension on the terminals.
- Earth unit correctly.
- Discharge the condenser before the work involving the electric parts.

#### General

- Keep children and pets away from both the cylinder unit and outdoor units.
- Do not use the hot water produced by the heat pump directly for drinking or cooking. This could cause illness to the user.
- Do not stand on the units.
- Do not touch switches with wet hands.
- Annual maintenance checks on both the cylinder unit and the outdoor unit should be conducted by a qualified person.
- Do not place containers with liquids on top of the cylinder unit. If they leak or spill onto the cylinder unit, damage to the unit and/or fire could occur.
- Do not place any heavy items on top of the cylinder unit.
- When installing, relocating, or servicing the cylinder unit, use only the heat pump's specified refrigerant to charge the refrigerant lines. Do not mix it with any other refrigerant and do not allow air to remain in the lines. If air is mixed with the refrigerant, then it can be the cause of abnormal high pressure in the refrigerant line, and may result in an explosion and other hazards.
- The use of any refrigerant other than that specified for the system will cause mechanical failure or system malfunction or unit breakdown. In the worst case, this could lead to a serious impediment to securing product safety.
- In heating mode, to avoid the heat emitters being damaged by excessively hot water, set the target flow temperature to a minimum of 2°C below the maximum allowable temperature of all the heat emitters. For Zone2, set the target flow temperature to a minimum of 5°C below the maximum allowable flow temperature of all the heat emitters in Zone2 circuit.
- Do not install the unit where combustible gases may leak, be produced, flow, or accumulate. If combustible gas accumulates around the unit, fire or explosion may result.
- Do not use means to accelerate the defrosting process or to clean, other than those recommended by the manufacturer.
- The appliance shall be stored in a room without continuously operating ignition sources (for example: open flames, an operating gas appliance or an operating electric heater).
- Do not pierce or burn.
- Be aware that refrigerants may not contain an odour.
- Pipe-work shall be protected from physical damage.
- The installation of pipe-work shall be kept to a minimum.
- Compliance with national gas regulations shall be observed.
- Keep any required ventilation openings clear of obstruction.
- Do not use low temperature solder alloy in the case of brazing the refrigerant pipes.

**⚠ CAUTION**

Use clean water that meets local quality standards on the primary circuit.
The outdoor unit should be installed in an area with sufficient airflow according to the diagrams in the outdoor unit installation manual.
The cylinder unit should be located inside to minimise heat loss.
Water pipe-runs on the primary circuit between outdoor and indoor unit should be kept to a minimum to reduce heat loss.
Ensure condensate from outdoor unit is piped away from the base to avoid puddles of water.
Remove as much air as possible from the primary and DHW circuits.
Refrigerant leakage may cause suffocation. Provide ventilation in accordance with EN378-1.
Be sure to wrap insulation around the piping. Direct contact with the bare piping may result in burns or frostbite.
Never put batteries in your mouth for any reason to avoid accidental ingestion.
Battery ingestion may cause choking and/or poisoning.
Install the unit on a rigid structure to prevent excessive sound or vibration during operation.
Do not transport the cylinder unit with water inside the DHW tank. This could cause damage to the unit.
If power to the cylinder unit is to be turned off (or system switched off) for a long time, the water should be drained.
If unused for a long period, before operation is resumed, DHW tank should be flushed through with potable water.
Preventative measures should be taken against water hammer, such as installing a Water Hammer Arrestor on the primary water circuit, as directed by the manufacturer.

As for the handling of refrigerant, refer to the outdoor unit installation manual.

### [1] Cautions for service

- (1) Perform service after recovering the refrigerant left in unit completely.
- (2) Do not release refrigerant in the air.
- (3) After completing service, charge the cycle with specified amount of refrigerant.
- (4) If moisture or foreign matter might have entered the refrigerant piping during service, ensure to remove them.

### [2] Additional refrigerant charge

**When charging directly from refrigerant cylinder**

- (1) Check that cylinder for R410A or R32 on the market is syphon type.
- (2) Charging should be performed with the cylinder of syphon stood vertically. (Refrigerant is charged from liquid phase.)

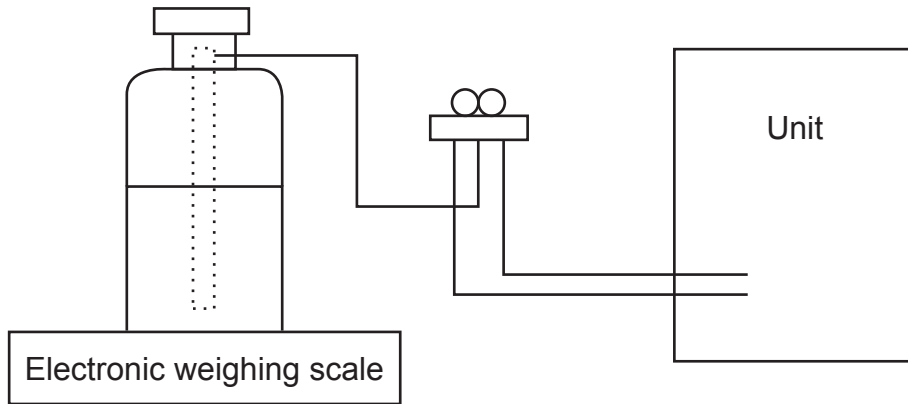

### [3] Service tools

Use the service tools below as exclusive tools for R410A or R32 refrigerant.

No.	Tool name	Specifications
1	Gauge manifold	· R410A or R32
		· Use the existing fitting specifications. (UNF1/2)
		· Use high-tension side pressure of 5.3 MPa·G or over.
2	Charge hose	· R410A or R32
		· Use pressure performance of 5.09 MPa·G or over.
3	Electronic weighing scale	—
4	Gas leak detector	· Use the detector for R134a, R407C, R410A or R32
5	Adaptor for reverse flow check	· Attach on vacuum pump.
6	Refrigerant charge base	—
7	Refrigerant cylinder	· R410A or R32 · Top of cylinder (Pink)
		· Cylinder with syphon
8	Refrigerant recovery equipment	—

Model name	EHST17D-VM2D	EHST17D-VM9D	ERST17D-VM2D	ERST17D-VM6D	EHST20D-MED	EHST20D-VM2D	EHST20D-VM6D	EHST20D-VM9D	EHST20D-YM6D	EHST20D-TM9D	ERST20D-VM2D	ERST20D-VM6D	ERST20D-VM9D
Nominal domestic hot water volume	200 L												
Overall unit dimensions (Height x Width x Depth)	170 L 1400 x 595 x 680 mm												
Weight (empty)	93 kg	96 kg	94 kg	94 kg	93 kg	99 kg	100 kg	102 kg	96 kg	102 kg	100 kg	100 kg	102 kg
Weight (full)	269 kg	274 kg	269 kg	273 kg	299 kg	305 kg	306 kg	310 kg	305 kg	310 kg	306 kg	306 kg	310 kg
Water volume of heating circuit in the unit*1	3.4 L	5.7 L	3.4 L	5.7 L	3.5 L	3.5 L	12 L	3.5 L	5.8 L	5.8 L	3.5 L	3.5 L	5.8 L
Unvented expansion vessel(Primary/ heating)	12 L												
Charge pressure	0.1 MPa												
Control thermostat	80 °C												
Pressure relief valve	0.3 MPa (3 bar)												
Flow sensor	Min. flow 5.0 L/min												
BH manual reset thermostat	90 °C												
BH thermal Cut Off	121 °C												
Control thermostat	75 °C												
IH manual reset thermostat	—												
Temperature / Pressure relief valve	1.0 MPa (10 bar)												
Water	Primary circuit DHW circuit												
Refrigerant (R32/ R410A)	Liquid Gas												
Heating	Room temperature Flow temperature												
Cooling	Room temperature Flow temperature												
Ambient	0 - 35 °C (≤ 80 %RH)												
Guaranteed operating range *2	See outdoor unit spec table.												
Outdoor temperature	Heating Cooling												
Maximum allowable hot water temperature	70 °C												
Declared load profile	L												
Average climate	A+												
Control board (including 4 pumps)	Power supply (Phase, voltage, frequency) Input Current Breaker												
Electrical data	Power supply (Phase, voltage, frequency)	~N, 230 V, 50 Hz	~N, 230 V, 50 Hz	~N, 230 V, 50 Hz	—	~N, 230 V, 50 Hz	3~ , 400 V, 50 Hz	3~ , 230 V, 50 Hz	~N, 230 V, 50 Hz	3~ , 400 V, 50 Hz	~N, 230 V, 50 Hz	3~ , 400 V, 50 Hz	3~ , 400 V, 50 Hz
	Capacity	2 kW	3 kW +6 kW	2 kW +4 kW	—	2 kW	2 kW +4 kW	3 kW +6 kW	2 kW	2 kW	2 kW +4 kW	2 kW +4 kW	3 kW +6 kW
	Heater step	1	3	1	3	—	1	3	3	1	1	3	3
	Breaker	9 A	13 A	9 A	26 A	—	9 A	26 A	13 A	9 A	23 A	9 A	26 A
Immersion heater*5	Power supply (Phase, voltage, frequency)	16 A	16 A	16 A	32 A	—	16 A	32 A	16 A	32 A	16 A	32 A	16 A
	Capacity	—	—	—	—	—	—	—	—	—	—	—	—
	Current	—	—	—	—	—	—	—	—	—	—	—	—
	Breaker	—	—	—	—	—	—	—	—	—	—	—	—
Sound power level (PWL)	41 dB(A)												

&lt;Table 3.1&gt;

\*1 Volume of sanitary water circuit, primary DHW circuit (from 3-way valve to confluent point with heating circuit), piping to expansion vessel, and expansion vessel are not included in this value.

\*2 The environment must be frost-free.

\*3 See outdoor unit spec table (min, 10 °C). Cooling mode is not available in low outdoor temperature. If you use our system in cooling mode at the low ambient temperature (10°C or below), there are some risks of plate heat exchanger damages by frozen water.

\*4 For the model without booster heater and immersion heater, the maximum allowable hot water temperature is [Maximum allowable hot water of outdoor unit -3°C]. For the maximum outlet water of outdoor unit, refer to outdoor unit data book.

\*5 Do not fit immersion heaters without thermal cut-out. Use only Mitsubishi Electric service parts as a direct replacement.

Model name	EHST30D-MED	EHST30D-VM6ED	EHST30D-VM9ED	EHST30D-TM9ED	EHST30D-VM6ED	EHST30D-VM9ED	EHST30D-VM6ED	EHST30D-VM9ED	EHST30D-TM9D	EHST30D-VM6D	EHST30D-VM9D	ERST20C-VM6D	ERST20C-VM9D
Nominal domestic hot water volume	2050 x 595 x 680 mm			300 L			1600 x 595 x 680 mm			200 L			
Overall unit dimensions (Height x Width x Depth)	2050 x 595 x 680 mm			300 L			1600 x 595 x 680 mm			200 L			
Weight (empty)	113 kg	115 kg	117 kg	115 kg	116 kg	117 kg	103 kg	110 kg	110 kg	110 kg	112 kg	110 kg	111 kg
Weight (full)	420 kg	422 kg	426 kg	422 kg	423 kg	426 kg	310 kg	317 kg	318 kg	317 kg	322 kg	317 kg	318 kg
Water volume of heating circuit in the unit *1	3.9 L	3.9 L	6.2 L	3.9 L	3.9 L	6.2 L	4.6 L	4.6 L	4.6 L	4.6 L	6.9 L	4.6 L	4.6 L
Unvented expansion vessel(Primary heating)	—	—	—	—	—	—	—	—	—	—	—	—	—
Nominal volume	—	—	—	—	—	—	—	—	—	—	—	—	—
Charge pressure	—	—	—	—	—	—	—	—	—	—	—	—	—
Control thermostat	—	—	—	—	—	—	80°C	—	—	—	—	—	—
Pressure relief valve	—	—	—	—	—	—	0.3 MPa (3 bar)	—	—	—	—	—	—
Flow sensor	—	—	—	—	—	—	Min. flow 5.0 L/min	—	—	—	—	—	—
BH manual reset thermostat	—	—	—	90°C	—	—	—	—	90°C	—	—	—	—
BH thermal Cut Off	—	—	—	121°C	—	—	—	—	121°C	—	—	—	—
Control thermostat	—	—	—	—	—	—	75°C	—	—	—	—	—	—
IH manual reset thermostat	—	—	—	—	—	—	—	—	—	—	—	—	—
DHW tank	—	—	—	—	—	—	—	—	—	—	—	—	—
Temperature / Pressure relief valve	—	—	—	—	—	—	1.0 MPa (10 bar)	—	—	—	—	—	—
Water	—	—	—	—	—	—	Primary circuit	—	—	—	—	—	—
DHW circuit	—	—	—	—	—	—	DHW circuit	—	—	—	—	—	—
Refrigerant (R32/ R410A)	—	—	—	6.35 mm	—	—	Liquid	—	—	—	9.52 mm	—	—
Gas	—	—	—	12.7 mm	—	—	Gas	—	—	—	15.88 mm	—	—
Heating	—	—	—	—	—	—	Room temperature	—	—	—	—	—	—
Flow temperature	—	—	—	—	—	—	Flow temperature	—	—	—	—	—	—
Room temperature	—	—	—	—	—	—	Room temperature	—	—	—	—	—	—
Flow temperature	—	—	—	—	—	—	Flow temperature	—	—	—	—	—	—
Ambient	—	—	—	—	—	—	5 - 25 °C	—	—	—	—	—	5 - 25°C
Outdoor temperature	—	—	—	—	—	—	0 - 35°C (≤ 80 %RH)	—	—	—	—	—	—
Maximum allowable hot water temperature	—	—	—	—	—	—	See outdoor unit spec table.	—	—	—	—	—	—
Declared load profile	—	—	—	—	—	—	XL	—	—	—	—	—	—
Average climate	—	—	—	—	—	—	A or A+	—	—	—	—	—	—
Control board (including 4 pumps)	—	—	—	—	—	—	Power supply (Phase, voltage, frequency)	—	—	—	—	—	—
Power supply (Phase, voltage, frequency)	—	—	—	—	—	—	Input	—	—	—	—	—	—
Capacity	—	—	—	—	—	—	Current	—	—	—	—	—	—
Heater step	—	—	—	—	—	—	Breaker	—	—	—	—	—	—
Current	—	—	—	—	—	—	Power supply (Phase, voltage, frequency)	—	—	—	—	—	—
Breaker	—	—	—	—	—	—	Capacity	—	—	—	—	—	—
Power supply (Phase, voltage, frequency)	—	—	—	—	—	—	Heater step	—	—	—	—	—	—
Capacity	—	—	—	—	—	—	Current	—	—	—	—	—	—
Heater step	—	—	—	—	—	—	Breaker	—	—	—	—	—	—
Current	—	—	—	—	—	—	Power supply (Phase, voltage, frequency)	—	—	—	—	—	—
Breaker	—	—	—	—	—	—	Capacity	—	—	—	—	—	—
Power supply (Phase, voltage, frequency)	—	—	—	—	—	—	Current	—	—	—	—	—	—
Capacity	—	—	—	—	—	—	Breaker	—	—	—	—	—	—
Current	—	—	—	—	—	—	Power supply (Phase, voltage, frequency)	—	—	—	—	—	—
Breaker	—	—	—	—	—	—	Capacity	—	—	—	—	—	—
Sound power level (PWL)	41 dB(A)			41 dB(A)			41 dB(A)			40 dB(A)			

<Table 3.2>

\*1 Volume of sanitary water circuit, primary DHW circuit (from 3-way valve to confluent point with heating circuit), piping to expansion vessel, and expansion vessel are not included in this value.  
 \*2 The environment must be frost-free.  
 \*3 See outdoor unit spec table (min, 10 °C). Cooling mode is not available in low outdoor temperature. If you use our system in cooling mode at the low ambient temperature (10°C or below), there are some risks of plate heat exchanger damages by frozen water.  
 \*4 For the model without booster heater and immersion heater, the maximum allowable hot water temperature is [Maximum outlet water of outdoor unit -3°C]. For the maximum outlet water of outdoor unit, refer to outdoor unit data book.  
 \*5 Do not fit immersion heaters without thermal cut-out. Use only Mitsubishi Electric service parts as a direct replacement.



Model name	EHST30C-MED	EHST30C-VM6ED	EHST30C-TM9ED	ERST30C-VM2ED	ERST30C-VM6ED	ERST30C-VM9ED	ERST17D-VM2BD	ERST17D-VM6BD	ERST17D-VM9BD		
Nominal domestic hot water volume	300 L										
Overall unit dimensions (Height x Width x Depth)	2050 x 595 x 660 mm										
Weight (empty)	120 kg	122 kg	124 kg	122 kg	122 kg	124 kg	116 kg	116 kg	118 kg		
Weight (full)	428 kg	430 kg	434 kg	429 kg	430 kg	434 kg	293 kg	293 kg	297 kg		
Water volume of heating circuit in the unit *1	5.0 L										
Unvented expansion vessel(Primary heating)	—										
Primary circuit	Charge pressure	—									
	Control thermostat	—									
	Pressure relief valve	80°C									
Safety device	Flow sensor	0.3 MPa (3 bar)									
	BH manual reset thermostat	Min. flow 5.0 L/min									
	BH thermal Cut Off	90°C									
DHW tank	Control thermostat	121°C									
	IH manual reset thermostat	75°C									
Connections	Temperature / Pressure relief valve	—									
	Water	1.0 MPa (10 bar)									
	Refrigerant (R32/R410A)	Primary circuit DHW circuit	ø28 mm ø22 mm								G1 female G3/4 female
Operating range	Heating	Liquid	ø9.52 mm								ø6.35 mm
	Cooling	Gas	ø15.88 mm								ø12.7 mm
	Ambient outdoor temperature	Room temperature	10 - 30°C								
DHW tank performance	Declared load profile	20 - 60°C									
	Average climate	—									
	Maximum allowable hot water temperature	5 - 25°C									
Electrical data	Control board (including 4 pumps)	—									
	Power supply (Phase, voltage, frequency)	~N, 230 V, 50 Hz									
	Input	0.30 kW									
Sound power level (PWL)	Current	1.95 A									
	Breaker	10 A									
	Power supply (Phase, voltage, frequency)	~N, 230 V, 50 Hz									
Guaranteed operating range *2	Capacity	~N, 230 V, 50 Hz	3~ , 400 V, 50 Hz	3~ , 230 V, 50 Hz	~N, 230 V, 50 Hz	3~ , 400 V, 50 Hz	~N, 230 V, 50 Hz	3~ , 400 V, 50 Hz	3~ , 400 V, 50 Hz		
	Heater step	2 kW +4 kW	3 kW +6 kW	2 kW	2 kW +4 kW	3 kW +6 kW	2 kW	2 kW +4 kW	3 kW +6 kW		
	Breaker	3	3	1	3	3	1	3	3		
Electrical data	Capacity	26 A	13 A	23 A	9 A	26 A	13 A	9 A	26 A		
	Heater step	32 A	16 A	32 A	16 A	32 A	16 A	32 A	16 A		
	Breaker	—	—	—	—	—	—	—	—		
Sound power level (PWL)	Power supply (Phase, voltage, frequency)	—									
	Capacity	—									
	Current	—									
Sound power level (PWL)	Breaker	—									
	Capacity	40 dB(A)									
	Current	41 dB(A)									

<Table 3.3>

\*1 Volume of sanitary water circuit, primary DHW circuit (from 3-way valve to confluent point with heating circuit), piping to expansion vessel, and expansion vessel are not included in this value.  
 \*2 The environment must be frost-free.  
 \*3 See outdoor unit spec table (min, 10 °C). Cooling mode is not available in low outdoor temperature. If you use our system in cooling mode at the low ambient temperature (10°C or below), there are some risks of plate heat exchanger damages by frozen water.  
 \*4 For the model without booster heater and immersion heater, the maximum allowable hot water temperature is [Maximum allowable hot water of outdoor unit -3°C]. For the maximum outlet water of outdoor unit, refer to outdoor unit data book.  
 \*5 Do not fit immersion heaters without thermal cut-out. Use only Mitsubishi Electric service parts as a direct replacement.

Model name	EHPT17X-VM2D	EHPT17X-VM6D	EHPT17X-VM9D	ERPT17X-VM2D	EHPT20X-MED	EHPT20X-VM6D	EHPT20X-VM9D	EHPT20X-VM6D	ERPT20X-MD	ERPT20X-VM2D	ERPT20X-VM6D	EHPT30X-MED	EHPT30X-VM9D	ERPT30X-VM2D	ERPT30X-VM6D	ERPT30X-VM9D
Nominal domestic hot water volume	170 L															
Overall unit dimensions (Height x Width x Depth)	1400 x 595 x 680 mm															
Weight (empty)	86 kg	87 kg	89 kg	86 kg	87 kg	94 kg	96 kg	94 kg	93 kg	94 kg	95 kg	106 kg	110 kg	107 kg	108 kg	108 kg
Weight (full)	262 kg	263 kg	267 kg	262 kg	293 kg	301 kg	304 kg	299 kg	299 kg	300 kg	301 kg	413 kg	419 kg	414 kg	415 kg	415 kg
Water volume of heating circuit in the unit*1	3.2 L			3.2 L	3.7 L	6.0 L	3.7 L	3.7 L	3.7 L	12 L	12 L	4.4 L	6.7 L	4.4 L	4.4 L	4.4 L
Unvented expansion vessel(Primary/ heating)	0.1 MPa															
Control thermostat	80°C															
Pressure relief valve	—															
Flow sensor	Min. flow 5.0 L/min															
BH manual reset thermostat	90°C			90°C	90°C	90°C	—	—	—	90°C	90°C	—	—	—	90°C	90°C
BH thermal Cut Off	121°C			121°C	121°C	121°C	—	—	—	121°C	121°C	—	—	—	121°C	121°C
Control thermostat	75°C															
IH manual reset thermostat	—															
Temperature/ Pressure relief valve	1.0 MPa (10 bar)															
Water	1.0 MPa (10 bar)															
Primary circuit	—															
DHW circuit	—															
Refrigerant (R32/ R410A)	Liquid															
Gas	Gas															
Room temperature	10 - 30°C															
Flow temperature	20 - 60°C															
Room temperature	—															
Flow temperature	—			5 - 25°C	—	—	—	—	—	5 - 25°C	—	—	—	—	5 - 25°C	—
Ambient	0 - 35°C (≦ 80 %RH)															
Outdoor temperature	See outdoor unit spec table.															
Heating	—			—	—	—	—	—	—	—	—	—	—	—	—	—
Cooling	—			—	—	—	—	—	—	—	—	—	—	—	—	—
Maximum allowable hot water temperature	70°C			70°C	70°C	70°C	70°C	70°C	70°C	70°C	70°C	70°C	70°C	70°C	70°C	70°C
Declared load profile	L			L	L	L	L	L	L	L	L	L	L	L	L	L
Average climate	A+			A+	A+	A+	A+	A+	A+	A+	A+	A+	A+	A+	A+	A+
Control board (including 4 pumps)	~N, 230 V, 50 Hz															
Power supply (Phase, voltage, frequency)	0.30 kW															
Input	1.95 A															
Current	0.34 kW															
Breaker	2.56 A															
Booster heater	~N, 230 V, 50 Hz	2 kW	2 kW +4 kW	3 kW +6 kW	2 kW	2 kW +4 kW	3 kW +6 kW	2 kW	2 kW	2 kW	2 kW +4 kW	3 kW +6 kW	2 kW	2 kW	2 kW +4 kW	2 kW +4 kW
Heater step	1	3	3	1	—	3	3	—	—	1	3	—	3	1	3	3
Current	9 A	26 A	13 A	9 A	—	26 A	13 A	—	—	9 A	26 A	—	13 A	9 A	26 A	26 A
Breaker	16 A	32 A	16 A	16 A	—	32 A	16 A	—	—	16 A	32 A	—	16 A	16 A	32 A	32 A
Power supply (Phase, voltage, frequency)	~N, 230 V, 50 Hz															
Capacity	3 kW															
Current	13 A															
Breaker	16 A															
Sound power level (PWL)	40 dB(A)															

<Table 3.4>

\*1 Volume of sanitary water circuit, primary DHW circuit (from 3-way valve to confluent point with heating circuit), piping to expansion vessel, and expansion vessel are not included in this value.

\*2 The environment must be frost-free.

\*3 See outdoor unit spec table (min, 10 °C). Cooling mode is not available in low outdoor temperature. If you use our system in cooling mode at the low ambient temperature (10°C or below), there are some risks of plate heat exchanger damages by frozen water.

\*4 For the model without booster heater and immersion heater, the maximum allowable hot water temperature is [Maximum outlet water of outdoor unit -3°C]. For the maximum outlet water of outdoor unit, refer to outdoor unit data book.

\*5 Do not fit immersion heaters without thermal cut-out. Use only Mitsubishi Electric service parts as a direct replacement.

# 4

# PART NAMES AND FUNCTIONS

<E\*\*T\*\*\*-M\*\*D>

(Packaged model system)

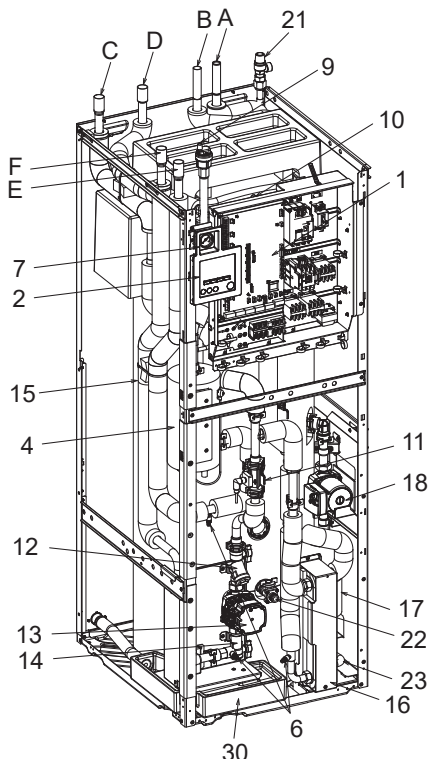

(Split model system)

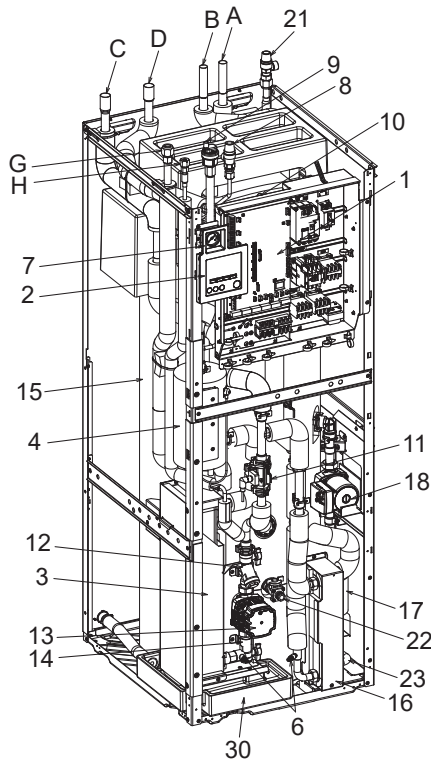

(Split model 2 zone system)

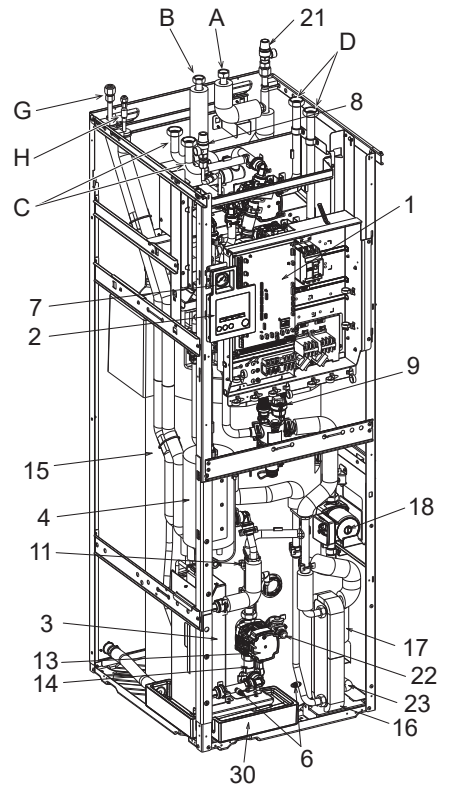

Note:

For installation of all E\*\*T\*\*\*-M\*\*ED\* models, make sure to install a suitably sized primary-side expansion vessel. (See figure 8.1 - 8.5 and 10.6.1 for further guidance)

<Figure 4.1>

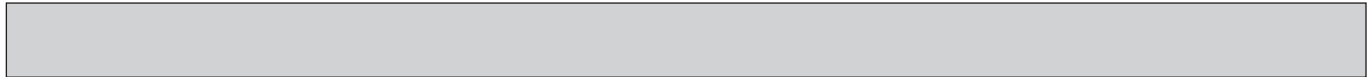

No.	Part name	EHST17/20D- *M*D	EHST20/30D- *M*ED	EHST20/30D- MED	EHST20C- *M*D	EHST20/30C- *M*ED	EHST20/30C- MED	ERST17/20D- *M*D	ERST17D- *M*BD	ERST30D- *M*ED
A	DHW outlet pipe	✓	✓	✓	✓	✓	✓	✓	✓	✓
B	Cold water inlet pipe	✓	✓	✓	✓	✓	✓	✓	✓	✓
C	Water pipe (Space heating/cooling return connection)	✓	✓	✓	✓	✓	✓	✓	✓	✓
D	Water pipe (Space heating/cooling flow connection)	✓	✓	✓	✓	✓	✓	✓	✓	✓
E	Water pipe (Flow from heat pump connection)	—	—	—	—	—	—	—	—	—
F	Water pipe (Return to heat pump connection)	—	—	—	—	—	—	—	—	—
G	Refrigerant pipe (Gas)	✓	✓	✓	✓	✓	✓	✓	✓	✓
H	Refrigerant pipe (Liquid)	✓	✓	✓	✓	✓	✓	✓	✓	✓
1	Control and electrical box	✓	✓	✓	✓	✓	✓	✓	✓	✓
2	Main remote controller	✓	✓	✓	✓	✓	✓	✓	✓	✓
3	Plate heat exchanger (Refrigerant - Water)	✓	✓	✓	✓	✓	✓	✓	✓	✓
4	Booster heater 1,2	✓	✓	—	✓	✓	—	✓	✓	✓
5	3-way valve	✓	✓	✓	✓	✓	✓	✓	✓	✓
6	Drain cock (Primary circuit)	✓	✓	✓	✓	✓	✓	✓	✓	✓
7	Manometer	✓	✓	✓	✓	✓	✓	✓	✓	✓
8	Pressure relief valve (3 bar)	✓	✓	✓ *2, 3	✓ *2	✓ *2, 3	✓ *2, 3	✓	✓	✓ *3
9	Automatic air vent	✓	✓	—	✓	✓	✓	✓	✓	✓
10	Expansion vessel (Primary circuit)	✓	—	—	✓	—	—	✓	✓	—
11	Flow sensor	✓	✓	✓	✓	✓	✓	✓	✓	✓
12	Strainer valve	✓	✓	✓	✓	✓	✓	✓	✓	✓
13	Water circulation pump 1 (Primary circuit)	✓	✓	✓	✓	✓	✓	✓	✓	✓
14	Pump valve	✓	✓	✓	✓	✓	✓	✓	✓	✓
15	DHW tank	✓	✓	✓	✓	✓	✓	✓	✓	✓
16	Plate heat exchanger (Water - Water)	✓	✓	✓	✓	✓	✓	✓	✓	✓
17	Scale trap	✓	✓	✓	✓	✓	✓	✓	✓	✓
18	Water circulation pump (Sanitary circuit)	✓	✓	✓	✓	✓	✓	✓	✓	✓
19	Immersion heater	—	—	—	—	—	—	—	—	—
20	Temperature and pressure relief valve	—	—	—	—	—	—	—	—	—
21	Pressure relief valve (10 bar) (DHW Tank)	✓	✓	✓	✓	✓	✓	✓	✓	✓
22	Drain cock (DHW tank)	✓	✓	✓	✓	✓	✓	✓	✓	✓
23	Drain cock (Sanitary circuit)	✓	✓	✓	✓	✓	✓	✓	✓	✓
24	Flow water temp. thermistor (THW1)	✓	✓	✓	✓	✓	✓	✓	✓	✓
25	Return water temp. thermistor (THW2)	✓	✓	✓	✓	✓	✓	✓	✓	✓
26	DHW tank upper water temp. thermistor (THW5A)	✓	✓	✓	✓	✓	✓	✓	✓	✓
27	DHW tank lower water temp. thermistor (THW5B)	✓	✓	✓	✓	✓	✓	✓	✓	✓
28	Refrigerant liquid temp. thermistor (TH2)	✓	✓	✓	✓	✓	✓	✓	✓	✓
29	Pressure sensor	✓	✓	✓	—	—	—	✓	✓	✓
30	Drain pan	—	—	—	—	—	—	✓	✓	✓
31	Outdoor unit	—	—	—	—	—	—	—	—	—
32	Drain pipe (Local supply)	—	—	—	—	—	—	—	—	—
33	Back flow prevention device (Local supply)	—	—	—	—	—	—	—	—	—
34	Isolating valve (Local supply)	—	—	—	—	—	—	—	—	—
35	Magnetic filter (Local supply) (Recommended)	—	—	—	—	—	—	—	—	—
36	Strainer (Local supply)	—	—	—	—	—	—	—	—	—
37	Pressure relief valve (3bar - In outdoor unit)	—	—	—	—	—	—	—	—	—
38	Inlet control group *1	—	—	—	—	—	—	—	—	—
39	Filling loop (Ball valves, check valves and flexible hose) *1	—	—	—	—	—	—	—	—	—
40	Potable expansion vessel *1	—	—	—	—	—	—	—	—	—
41	Air vent (Local supply)	—	—	—	—	—	—	—	—	—
42	Pressure relief valve (5 bar)	✓	—	—	✓	—	—	✓	✓	—
43	Water circulation pump 2 (Zone1)	—	—	—	—	—	—	—	✓	—
44	Water circulation pump 3 (Zone2)	—	—	—	—	—	—	—	✓	—
45	Mixing valve	—	—	—	—	—	—	—	✓	—
46	Magnetic filter	—	—	—	—	—	—	—	✓	—
47	Mud trap	—	—	—	—	—	—	—	✓	—
48	Flow zone1 water temp. thermistor (THW6)	—	—	—	—	—	—	—	✓	—
49	Return zone1 water temp. thermistor (THW7)	—	—	—	—	—	—	—	✓	—
50	Flow zone2 water temp. thermistor (THW8)	—	—	—	—	—	—	—	✓	—
51	Return zone2 water temp. thermistor (THW9)	—	—	—	—	—	—	—	✓	—
52	Header	—	—	—	—	—	—	—	✓	—

\*1 Supplied with UK model ONLY. Please refer to PAC-WK02UK-E Installation Manual for more information on accessories.  
 \*2 Attachment the part to the position of 3 bar PRV for E\*ST20 series. (Refer to the Figure 3,2 and 3,3 on the manual of RG79F364H01(page 8))  
 \*3 Attachment the part to the position of 3 bar PRV for E\*ST30 series. (Refer to the Figure 3,2 and 3,3 on the manual of RG79F364H01(page 8))

<Table 4.1>

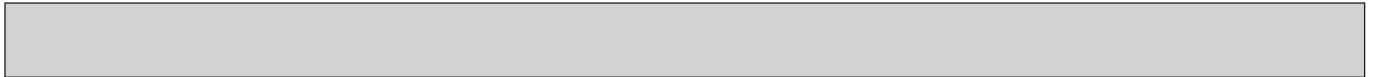

No.	Part name	ERST20C- *M*D	ERST30C- *M*ED	EHPT17/20X- *M*D	EHPT20/30X- *M*ED	EHPT20/30X- MED	ERPT17/20X- *M*D	ERPT20X- MD	ERPT30X- VM*ED	EHPT20X- MHEDW
A	DHW outlet pipe	✓	✓	✓	✓	✓	✓	✓	✓	✓
B	Cold water inlet pipe	✓	✓	✓	✓	✓	✓	✓	✓	✓
C	Water pipe (Space heating/cooling return connection)	✓	✓	✓	✓	✓	✓	✓	✓	✓
D	Water pipe (Space heating/cooling flow connection)	✓	✓	✓	✓	✓	✓	✓	✓	✓
E	Water pipe (Flow from heat pump connection)	—	—	✓	✓	✓	✓	✓	✓	✓
F	Water pipe (Return to heat pump connection)	—	—	✓	✓	✓	✓	✓	✓	✓
G	Refrigerant pipe (Gas)	✓	✓	—	—	—	—	—	—	—
H	Refrigerant pipe (Liquid)	✓	✓	—	—	—	—	—	—	—
1	Control and electrical box	✓	✓	✓	✓	✓	✓	✓	✓	✓
2	Main remote controller	✓	✓	✓	✓	✓	✓	✓	✓	✓
3	Plate heat exchanger (Refrigerant - Water)	✓	✓	—	—	—	—	—	—	—
4	Booster heater 1,2	✓	✓	✓	✓	—	✓	—	✓	—
5	3-way valve	✓	✓	✓	✓	✓	✓	✓	✓	✓
6	Drain cock (Primary circuit)	✓	✓	✓	✓	✓	✓	✓	✓	✓
7	Manometer	✓	✓	✓	✓	✓	✓	✓	✓	✓
8	Pressure relief valve (3 bar)	✓ *2	✓ *3	—	—	—	—	—	—	—
9	Automatic air vent	✓	✓	✓	✓	✓	✓	✓	✓	✓
10	Expansion vessel (Primary circuit)	✓	—	✓	—	—	✓	✓	—	—
11	Flow sensor	✓	✓	✓	✓	✓	✓	✓	✓	✓
12	Strainer valve	✓	✓	✓	✓	✓	✓	✓	✓	✓
13	Water circulation pump 1 (Primary circuit)	✓	✓	✓	✓	✓	✓	✓	✓	✓
14	Pump valve	✓	✓	✓	✓	✓	✓	✓	✓	✓
15	DHW tank	✓	✓	✓	✓	✓	✓	✓	✓	✓
16	Plate heat exchanger (Water - Water)	✓	✓	✓	✓	✓	✓	✓	✓	✓
17	Scale trap	✓	✓	✓	✓	✓	✓	✓	✓	✓
18	Water circulation pump (Sanitary circuit)	✓	✓	✓	✓	✓	✓	✓	✓	✓
19	Immersion heater	—	—	—	—	—	—	—	—	✓
20	Temperature and pressure relief valve	—	—	—	—	—	—	—	—	✓
21	Pressure relief valve (10 bar) (DHW Tank)	✓	✓	✓	✓	✓	✓	✓	✓	—
22	Drain cock (DHW tank)	✓	✓	✓	✓	✓	✓	✓	✓	✓
23	Drain cock (Sanitary circuit)	✓	✓	✓	✓	✓	✓	✓	✓	✓
24	Flow water temp. thermistor (THW1)	✓	✓	✓	✓	✓	✓	✓	✓	✓
25	Return water temp. thermistor (THW2)	✓	✓	✓	✓	✓	✓	✓	✓	✓
26	DHW tank upper water temp. thermistor (THW5A)	✓	✓	✓	✓	✓	✓	✓	✓	✓
27	DHW tank lower water temp. thermistor (THW5B)	✓	✓	✓	✓	✓	✓	✓	✓	✓
28	Refrigerant liquid temp. thermistor (TH2)	✓	✓	—	—	—	—	—	—	—
29	Pressure sensor	—	—	—	—	—	—	—	—	—
30	Drain pan	✓	✓	—	—	—	✓	✓	✓	—
31	Outdoor unit	—	—	—	—	—	—	—	—	—
32	Drain pipe (Local supply)	—	—	—	—	—	—	—	—	—
33	Back flow prevention device (Local supply)	—	—	—	—	—	—	—	—	—
34	Isolating valve (Local supply)	—	—	—	—	—	—	—	—	—
35	Magnetic filter (Local supply) (Recommended)	—	—	—	—	—	—	—	—	—
36	Strainer (Local supply)	—	—	—	—	—	—	—	—	—
37	Pressure relief valve (3bar - In outdoor unit)	—	—	✓	✓	✓	✓	✓	✓	✓
38	Inlet control group *1	—	—	—	—	—	—	—	—	—
39	Filling loop (Ball valves, check valves and flexible hose) *1	—	—	—	—	—	—	—	—	—
40	Potable expansion vessel *1	—	—	—	—	—	—	—	—	—
41	Air vent (Local supply)	—	—	—	—	—	—	—	—	—
42	Pressure relief valve (5 bar)	✓	—	✓	—	—	✓	✓	—	—
43	Water circulation pump 2 (Zone1)	—	—	—	—	—	—	—	—	—
44	Water circulation pump 3 (Zone2)	—	—	—	—	—	—	—	—	—
45	Mixing valve	—	—	—	—	—	—	—	—	—
46	Magnetic filter	—	—	—	—	—	—	—	—	—
47	Mud trap	—	—	—	—	—	—	—	—	—
48	Flow zone1 water temp. thermistor (THW6)	—	—	—	—	—	—	—	—	—
49	Return zone1 water temp. thermistor (THW7)	—	—	—	—	—	—	—	—	—
50	Flow zone2 water temp. thermistor (THW8)	—	—	—	—	—	—	—	—	—
51	Return zone2 water temp. thermistor (THW9)	—	—	—	—	—	—	—	—	—
52	Header	—	—	—	—	—	—	—	—	—

\*1 Supplied with UK model ONLY. Please refer to PAC-WK02UK-E Installation Manual for more information on accessories.

\*2 Attachment the part to the position of 3 bar PRV for E\*ST20 series. (Refer to the Figure 3,2 and 3,3 on the manual of RG79F364H01(page 8))

\*3 Attachment the part to the position of 3 bar PRV for E\*ST30 series. (Refer to the Figure 3,2 and 3,3 on the manual of RG79F364H01(page 8))

<Table 4.2>

# 5

# OUTLINES AND DIMENSIONS

## 5-1. Technical Drawings

<E\*\*T\*\*\*-M\*\*D>

(Packaged model system)

<Unit: mm>

DHW tank capacity	170L	200L	300L
①	1400	1600	2050

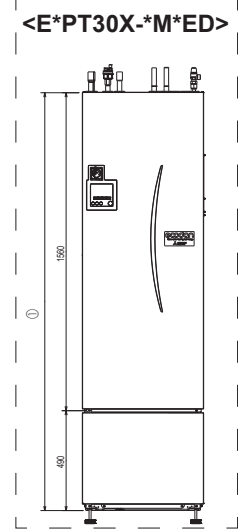
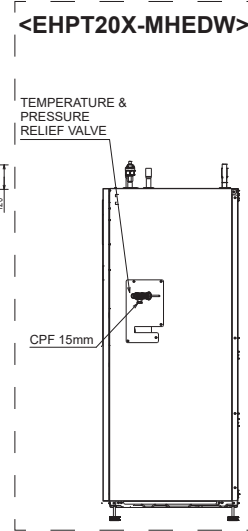
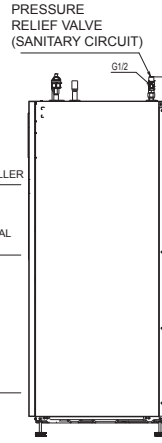
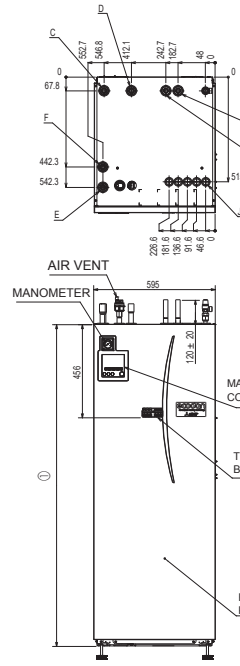
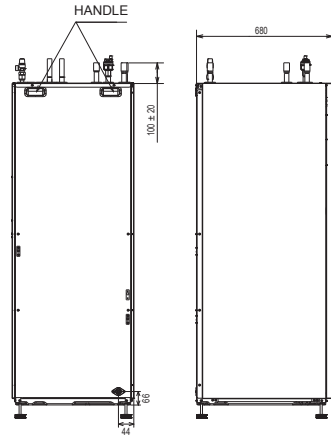

(Split model system)

DHW tank capacity	170L	200L	300L
①	1400	1600	2050

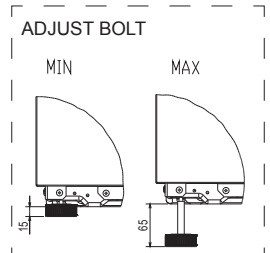
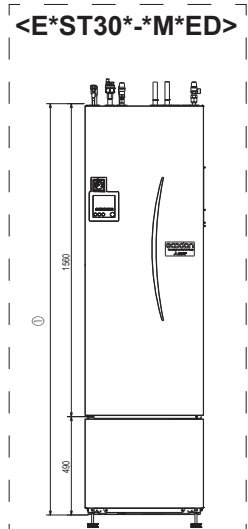
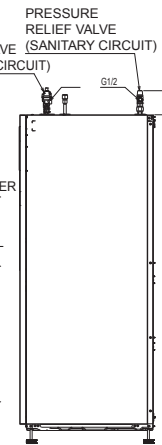
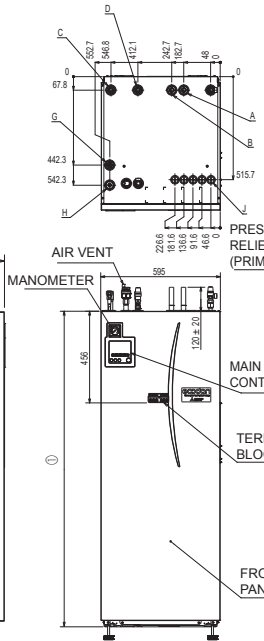
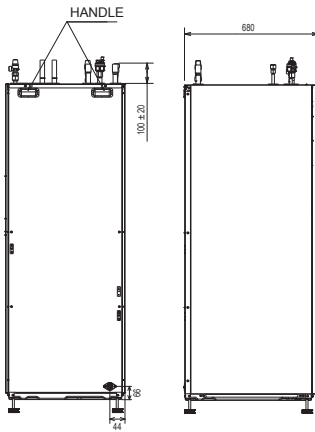

Letter	Pipe description	Connection size/type
A	DHW outlet connection	22 mm/Compression
B	Cold water inlet connection	22 mm/Compression
C	Space heating/cooling RETURN connection	28 mm/Compression
D	Space heating/cooling FLOW connection	28 mm/Compression
E	Flow connection FROM heat pump (No plate heat exchanger)	28 mm/Compression
F	Return connection TO heat pump (No plate heat exchanger)	28 mm/Compression
G	Refrigerant (GAS) (With plate heat exchanger)	12.7 mm/Flare (E*ST**D-*) 15.88 mm/Flare (E*ST**C-*)
H	Refrigerant (LIQUID) (With plate heat exchanger)	6.35 mm/Flare (E*ST**D-*) 9.52 mm/Flare (E*ST**C-*)
J	Electrical cable inlets 	For inlets ①, ② and ③, run low-voltage wires including external input wires and thermistor wires. For inlets ④ and ⑤, run high-voltage wires including power cable, indoor-outdoor cable, and external output wires. *For a wireless receiver (option) cable and ecodan Wi-Fi interface (option) cable, use inlet ①.

<Table 5.1>

**(Split model 2 zone system)**

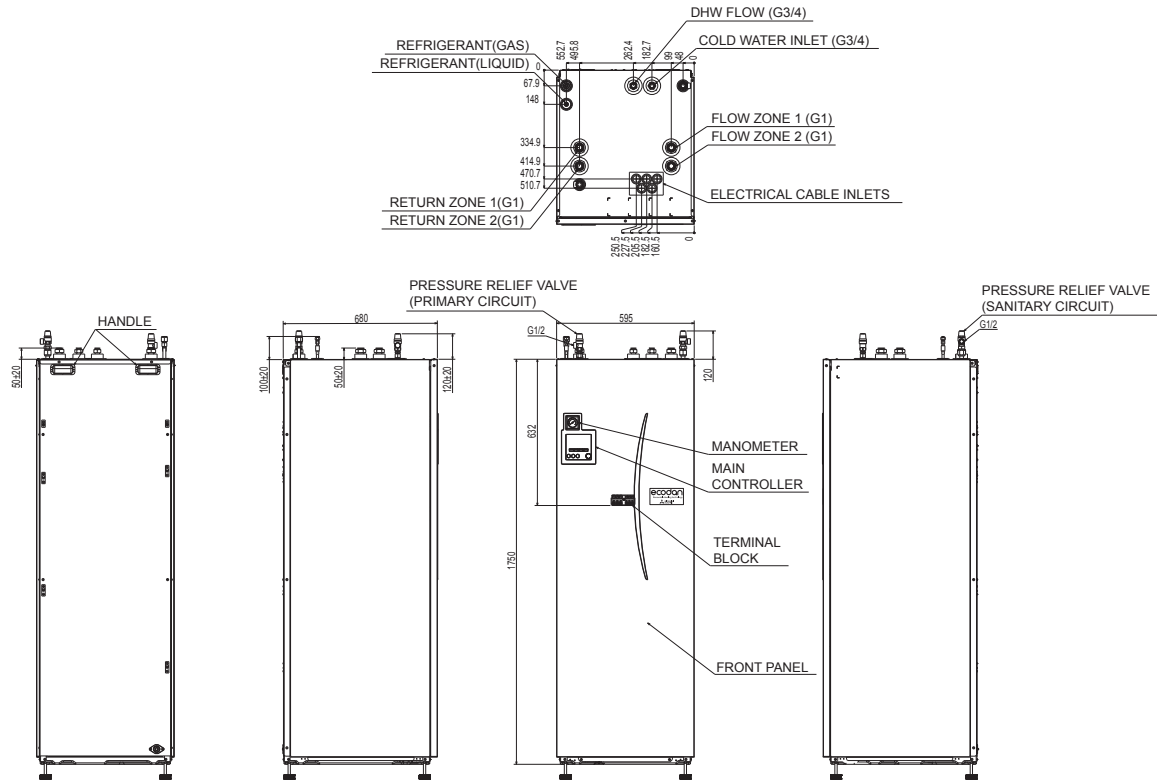

Electrical cable inlets		<p>For inlets ①, ② and ③, run low-voltage wires including external input wires and thermistor wires. For inlets ④ and ⑤, run high-voltage wires including power cable, indoor-outdoor cable, and external output wires.</p> <p>*For a wireless receiver (option) cable and ecodan Wi-Fi interface (option) cable, use inlet ①.</p>
-------------------------	--	--

**5-2. Service access diagrams**

Service access	
Parameter	Dimension (mm)
a	300*
b	150
c (distance behind unit not visible in the right figure)	10
d	500

Sufficient space MUST be left for the provision of discharge pipework as detailed in National and Local Building Regulations.

The cylinder unit must be located indoors and in a frost-free environment, for example in a utility room, to minimise heat loss from stored water.

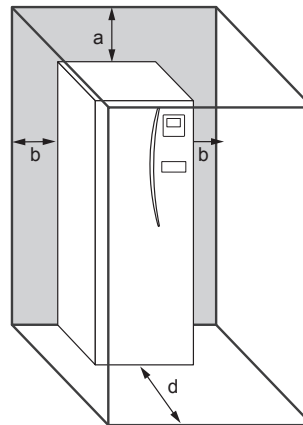

Service access

\* An additional 300 mm of space (total 600 mm) is required, when installing the optional 2-zone kit (PAC-TZ02-E) on top of the cylinder unit.

## 6-1. E\*\*T\*\*\*-VM2(E)D

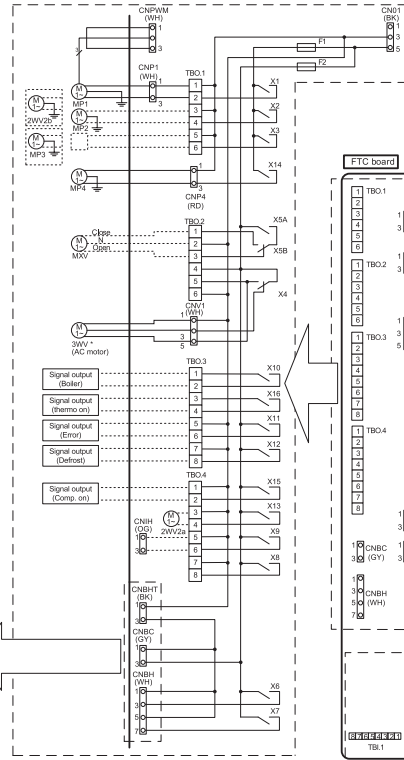
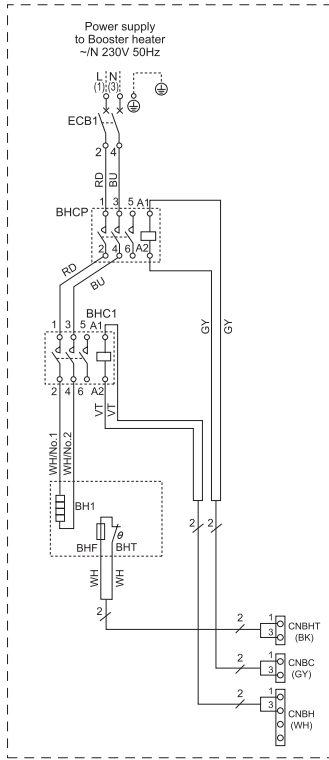

**<How to use TBO.1 to 4>**  
Connect them using either way as shown below.

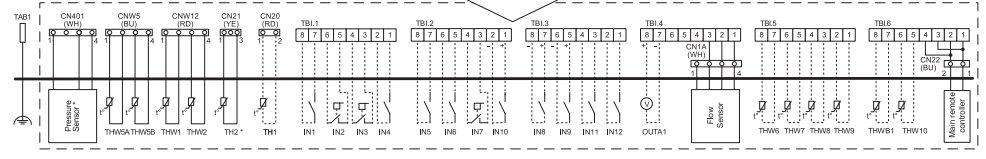
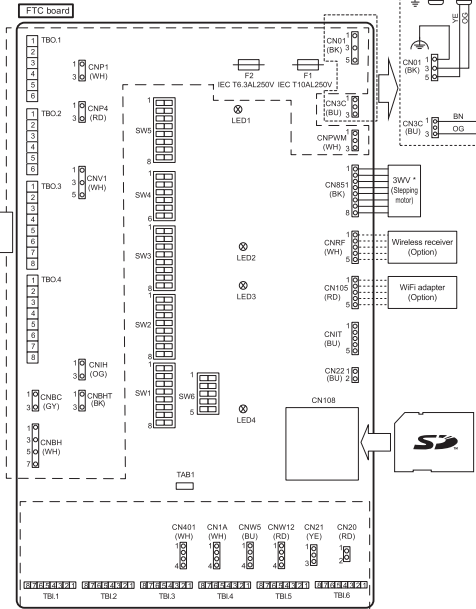
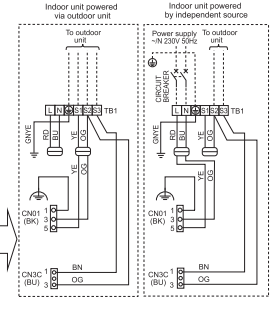

Symbol	Name
TB1	Terminal block <Power supply, Outdoor unit>
ECB1	Earth leakage circuit breaker for booster heater
ECB2	Earth leakage circuit breaker for immersion heater
MP2	Water circulation pump 1(Space heating and DHW)
MP3	Water circulation pump 2 (Local supply)
MP4	Water circulation pump 3 (Space heating for Zone2)(Local supply)
MP4	Water circulation pump 4 (DHW)
3VV	3-way valve (AC motor) (E*PT120/30X-M**D*, E*ST**C/30D-M**D) 3-way valve (Stepping motor) (E*PT17X-M**D*, E*ST17/20D-M**D)
2VV2a	2-way valve (For Zone 1)(Local supply)
2VV2b	2-way valve (For Zone 2)(Local supply)
MXV	Mixing valve (Local supply)
IHT	Thermostat (fixed temp.) for immersion heater
IH	Immersion heater
IHC	Contact for immersion heater
TH1	Thermistor (Room temp.)(Option)
TH2	Thermistor (Ref. liquid temp.)
THW1	Thermistor (Flow water temp.)
THW2	Thermistor (Return water temp.)
THWSA	Thermistor (DHW tank upper water temp.)
THWSB	Thermistor (DHW tank lower water temp.)
THW6	Thermistor (Zone1 flow temp.)(Option)
THW7	Thermistor (Zone1 return temp.)(Option)
THW8	Thermistor (Zone2 flow temp.)(Option)
THW9	Thermistor (Zone2 return temp.)(Option)
THW10	Thermistor (Mixing tank temp.)(Option)
THWB1	Thermistor (Boiler flow temp.)(Option)
IN1	Room thermostat 1 (Local supply)
IN2	Flow switch 1 (Local supply)
IN3	Flow switch 2 (Local supply)
IN4	Demand control (Local supply)
IN5	Outdoor thermostat (Local supply)
IN6	Room thermostat 2 (Local supply)
IN7	Flow switch 3 (Local supply)
IN8	Electric energy meter 1 (Local supply)
IN9	Electric energy meter 2 (Local supply)
IN10	Heat meter (Local supply)
IN11	Smart grid ready input (Local supply)
IN12	—
INA1	Flow sensor
FLOW TEMP. CONTROLLER (FTC)	
TBO.1-4	Terminal block <Outputs>
TB1.1-6	Terminal block <Signal Inputs, Thermistor>
F1	Fuse (IEC T10AL250V)
F2	Fuse (IEC T6.3AL250V)
SW1-6	DIP switch *See Table 6.9.1
X1-16	Relay
LED1	Power supply (FTC)
LED2	Power supply (Main remote controller)
LED3	Communication (FTC-Outdoor unit)
LED4	Reading or writing data to SD card
CNPWM	Pump speed control signal for MP1
CN108	SD card connector

1. Symbols used in wiring diagram are, □ : connector, □□ : terminal block. Function with asterisk (\*) may not be available depending on model types.
2. Indoor unit and outdoor unit connecting wires have polarities, make sure to match terminal numbers (S1, S2, S3) for correct wiring.
3. Since the outdoor unit side electric wiring may change, be sure to check the outdoor unit electric wiring diagram for service.
4. Refer to the installation manual for the water circulation diagrams of the models other than shown below.

**Table 1 Signal Inputs**

Name	Terminal block	Connector	Item	OFF (Open)	ON (Short)
IN1	TB1.1 7-8	—	Room thermostat 1 input *1	Refer to SW2-1 in < Table 6.9.1. DIP Switch Functions>.	
IN2	TB1.1 5-6	—	Flow switch 1 input	Refer to SW2-2 in < Table 6.9.1. DIP Switch Functions>.	
IN3	TB1.1 3-4	—	Flow switch 2 input (Zone1)	Refer to SW3-2 in < Table 6.9.1. DIP Switch Functions>.	
IN4	TB1.1 1-2	—	Demand control input	Normal	Heat source OFF/Boiler operation *3
IN5	TB1.2 7-8	—	Outdoor thermostat input *2	Standard operation	Heater operation/Boiler operation *3
IN6	TB1.2 5-6	—	Room thermostat 2 input *1	Refer to SW3-1 in < Table 6.9.1. DIP Switch Functions>.	
IN7	TB1.2 3-4	—	Flow switch 3 input (Zone2)	Refer to SW3-2 in < Table 6.9.1. DIP Switch Functions>.	
IN8	TB1.3 7-8	—	Electric energy meter 1		
IN9	TB1.3 5-6	—	Electric energy meter 2		
IN10	TB1.2 1-2	—	Heat meter	Refer to installation manual.	
IN11	TB1.3 3-4	—	Smart grid ready input		
IN12	TB1.3 1-2	—	input		
INA1	TB1.4 1-3	CN1A	Flow sensor		

- \*1. Set the ON/OFF cycle time of the room thermostat for 10 minutes or more; otherwise the compressor may be damaged.
- \*2. If using outdoor thermostat for controlling operation of heaters, the lifetime of the heaters and related parts may be reduced.
- \*3. To turn on the boiler operation, use the main remote controller to select "Boiler" in "External input setting" screen in the service menu.

**Table 2 Outputs**

Name	Terminal block	Connector	Item	OFF	ON
OUT1	TBO.1 1-2	CNP1	Water circulation pump 1 output (Space heating/cooling & DHW)	OFF	ON
OUT2	TBO.1 3-4	—	Water circulation pump 2 output (Space heating/cooling for Zone1)	OFF	ON
OUT3	TBO.1 5-6	—	Water circulation pump 3 output (Space heating/cooling for Zone2) *1	OFF	ON
OUT4	TBO.2 4-6	CNV1	3-way valve (2-way valve) output	Heating	DHW
OUT5	TBO.2 1-2	—	Mixing valve output *1	Stop	Close Open
OUT6	TBO.2 2-3	CNH13	Booster heater 1 output	OFF	ON
OUT7	—	CNH15	Booster heater 2 output	OFF	ON
OUT8	TBO.4 7-8	—	Cooling signal output	OFF	ON
OUT9	TBO.4 5-6	CNIH	Immersion heater output	OFF	ON
OUT10	TBO.3 1-2	—	Boiler output	OFF	ON
OUT11	TBO.3 5-6	—	Error output	Normal	Error
OUT12	TBO.3 7-8	—	Defrost output	Normal	Defrost
OUT13	TBO.4 3-4	—	2-way valve 2a output *2	OFF	ON
OUT14	—	CNP4	Water circulation pump 4 output (DHW)	OFF	ON
OUT15	TBO.4 1-2	—	Comp. ON signal	OFF	ON
OUT16	TBO.3 3-4	—	Thermo ON signal	OFF	ON
OUTA1	TB1.4 7-8	—	Analog output	0V-10V	

Do not connect to the terminals that are indicated as "—" in the "Terminal block" field.  
\*1. For 2-zone temperature control.  
\*2. For 2-zone valve ON/OFF control.



## 6-2. E\*\*T\*\*\*-VM6(E)D

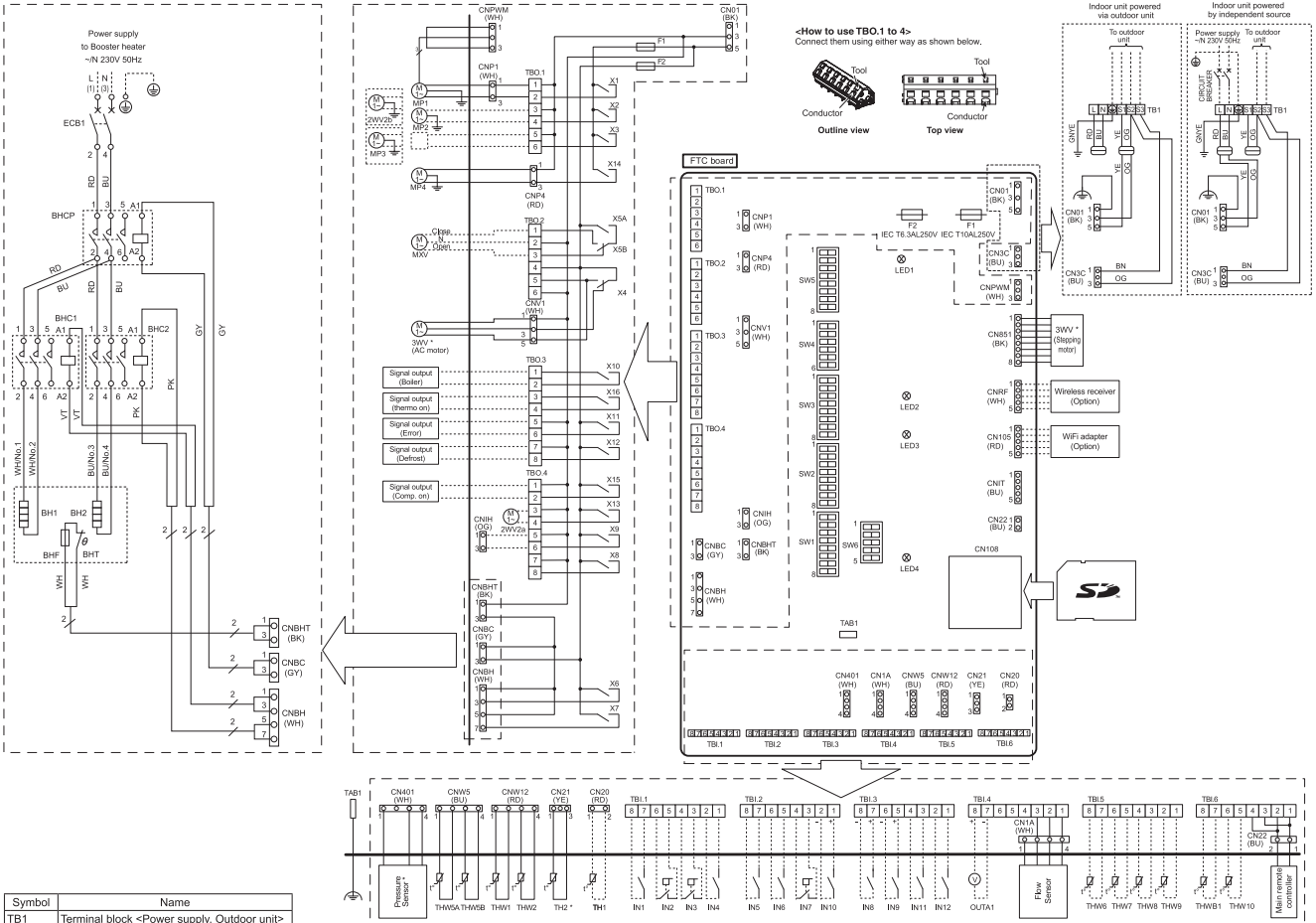

Symbol	Name
TB1	Terminal block <Power supply, Outdoor unit>
ECB1	Earth leakage circuit breaker for booster heater
ECB2	Earth leakage circuit breaker for immersion heater
MP1	Water circulation pump 1(Space heating and DHW)
MP2	Water circulation pump 2 (Space heating for Zone1)(Local supply)
MP3	Water circulation pump 3 (Space heating for Zone2)(Local supply)
MP4	Water circulation pump 4 (DHW)
3WV	3-way valve (AC motor) (E*P120/30X-M**D, E-ST**C30D-M**D) 3-way valve (Stepping motor) (E*P17X-M**D, E-ST17/20D-M**D)
2WV2a	2-way valve (For Zone 1)(Local supply)
2WV2b	2-way valve (For Zone 2)(Local supply)
MXV	Mixing valve (Local supply)
IHT	Thermostat (fixed temp.) for immersion heater
IH	Immersion heater
IHC	Contact for immersion heater
TH1	Thermistor (Room temp.)(Option)
TH2	Thermistor (Ref. liquid temp.)
THW1	Thermistor (Flow water temp.)
THW2	Thermistor (Return water temp.)
THW5A	Thermistor (DHW tank upper water temp.)
THW5B	Thermistor (DHW tank lower water temp.)
THW6	Thermistor (Zone1 flow temp.)(Option)
THW7	Thermistor (Zone1 return temp.)(Option)
THW8	Thermistor (Zone2 flow temp.)(Option)
THW9	Thermistor (Zone2 return temp.)(Option)
THW10	Thermistor (Mixing tank temp.)(Option)
THWB1	Thermistor (Boiler flow temp.)(Option)
IN1	Room thermostat 1 (Local supply)
IN2	Flow switch 1 (Local supply)
IN3	Flow switch 2 (Local supply)
IN4	Demand control (Local supply)
IN5	Outdoor thermostat (Local supply)
IN6	Room thermostat 2 (Local supply)
IN7	Flow switch 3 (Local supply)
IN8	Electric energy meter 1 (Local supply)
IN9	Electric energy meter 2 (Local supply)
IN10	Heat meter (Local supply)
IN11	Smart grid ready input (Local supply)
IN12	Smart grid ready input (Local supply)
INA1	Flow sensor
FLOW TEMP. CONTROLLER (FTC)	
TBO.1-4	Terminal block <Outputs>
TBI.1-6	Terminal block <Signal Inputs, Thermistor>
F1	Fuse (IEC T10AL250V)
F2	Fuse (IEC T6.3AL250V)
SW1-6	DIP switch *See Table 6.9.1
X1-16	Relay
LED1	Power supply (FTC)
LED2	Power supply (Main remote controller)
LED3	Communication (FTC-Outdoor unit)
LED4	Reading or writing data to SD card
CNPWM	Pump speed control signal for MP1
CN108	SD card connector

- Symbols used in wiring diagram are, : connector, : terminal block. Function with asterisk (\*) may not be available depending on model types.
- Indoor unit and outdoor unit connecting wires have polarities, make sure to match terminal numbers (S1, S2, S3) for correct wirings.
- Since the outdoor unit side electric wiring may change, be sure to check the outdoor unit electric wiring diagram for service.

4. Refer to the installation manual for the water circulation diagrams of the models other than shown below.

**Table 1 Signal Inputs**

Name	Terminal block	Connector	Item	OFF (Open)	ON (Short)
IN1	TBI.1	7-8	Room thermostat 1 input *1	Refer to SW2-1 in <Table 6.9.1 DIP Switch Functions>	
IN2	TBI.1	5-6	Flow switch 1 input	Refer to SW2-2 in <Table 6.9.1 DIP Switch Functions>	
IN3	TBI.1	3-4	Flow switch 2 input (Zone1)	Refer to SW3-2 in <Table 6.9.1 DIP Switch Functions>	
IN4	TBI.1	1-2	Demand control input	Normal	Heat source OFF/Boiler operation *3
IN5	TBI.2	7-8	Outdoor thermostat input *2	Standard operation	Boiler operation *3
IN6	TBI.2	5-6	Room thermostat 2 input *1	Refer to SW3-1 in <Table 6.9.1 DIP Switch Functions>	
IN7	TBI.2	3-4	Flow switch 3 input (Zone2)	Refer to SW3-2 in <Table 6.9.1 DIP Switch Functions>	
IN8	TBI.3	7-8	Electric energy meter 1		
IN9	TBI.3	5-6	Electric energy meter 2		
IN10	TBI.2	1-2	Heat meter		
IN11	TBI.3	3-4	Smart grid ready input		
IN12	TBI.3	1-2	Smart grid ready input		
INA1	TBI.4	1-3	CN1A Flow sensor		

- Set the ON/OFF cycle time of the room thermostat for 10 minutes or more; otherwise the compressor may be damaged.
- If using outdoor thermostat for controlling operation of heaters, the lifetime of the heaters and related parts may be reduced.
- To turn on the boiler operation, use the main remote controller to select "Boiler" in "External input setting" screen in the service menu.

**Table 2 Outputs**

Name	Terminal block	Connector	Item	OFF	ON
OUT1	TBO.1	1-2	CNP1 Water circulation pump 1 output (Space heating/cooling & DHW)	OFF	ON
OUT2	TBO.1	3-4	Water circulation pump 2 output (Space heating/cooling for Zone1)	OFF	ON
OUT3	TBO.1	5-6	Water circulation pump 3 output (Space heating/cooling for Zone2) *1	OFF	ON
OUT4	TBO.2	4-6	CNV1 3-way valve (2-way valve) output	Heating	DHW
OUT5	TBO.2	1-2, 2-3	CN8S1 3-way valve output	Stop	Close Open
OUT6	—	DI8:1-3	Booster heater 1 output	OFF	ON
OUT7	—	DI8:5-7	Booster heater 2 output	OFF	ON
OUT8	TBO.4	7-8	Cooling signal output	OFF	ON
OUT9	TBO.4	5-6	CNIH Immersion heater output	OFF	ON
OUT10	TBO.3	1-2	Boiler output	OFF	ON
OUT11	TBO.3	5-6	Error output	Normal	Error
OUT12	TBO.3	7-8	Defrost output	Normal	Defrost
OUT13	TBO.4	3-4	2-way valve 2a output *2	OFF	ON
OUT14	—	CNP4	Water circulation pump 4 output (DHW)	OFF	ON
OUT15	TBO.4	1-2	Comp. ON signal	OFF	ON
OUT16	TBO.3	3-4	Thermo ON signal	OFF	ON
OUTA1	TBI.4	7-8	Analog output	0V-10V	

Do not connect to the terminals that are indicated as "—" in the "Terminal block" field.  
\*1. For 2-zone temperature control.  
\*2. For 2-zone valve ON/OFF control.

### 6-3. E\*\*T\*\*\*-YM9(E)D

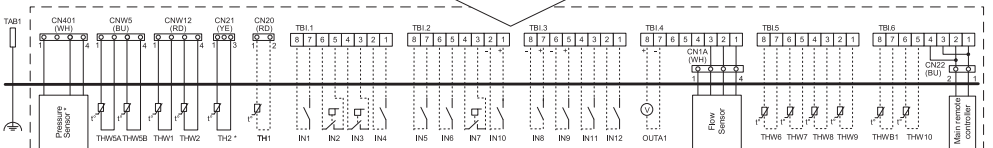
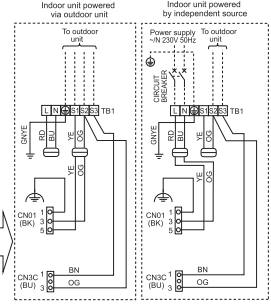
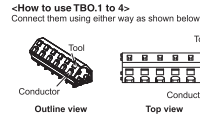
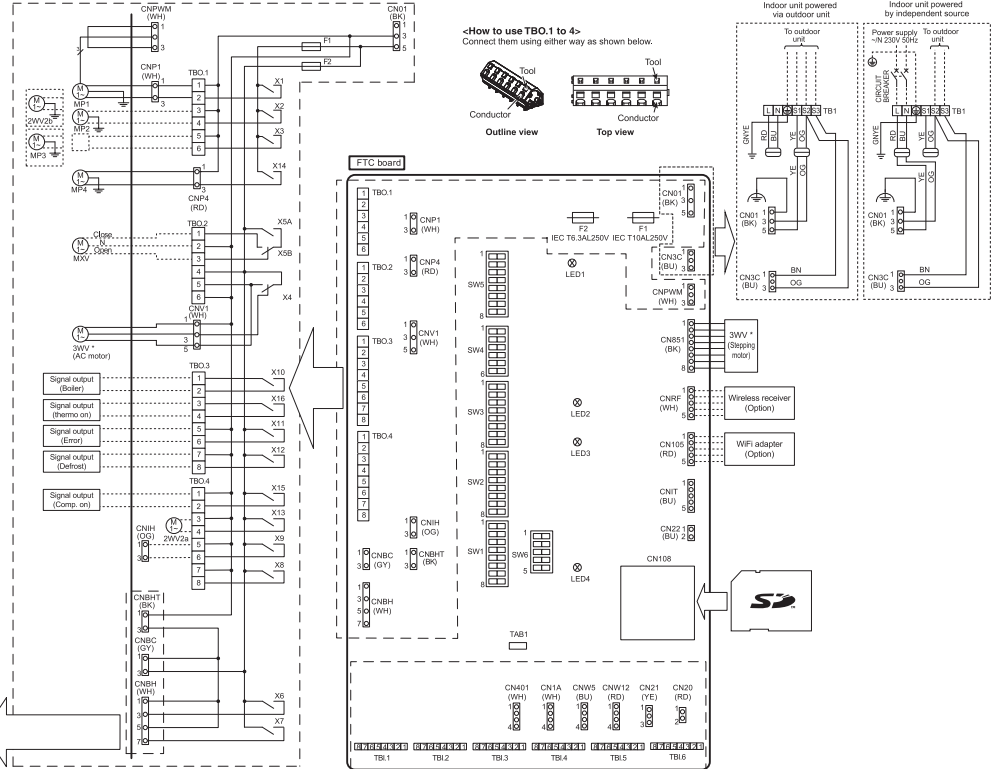
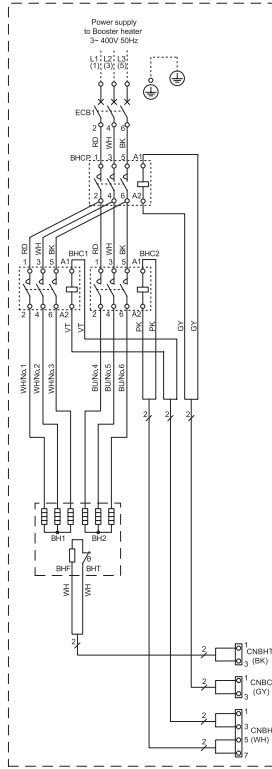

Symbol	Name
TB1	Terminal block <Power supply, Outdoor unit>
ECB1	Earth leakage circuit breaker for booster heater
ECB2	Earth leakage circuit breaker for immersion heater
MP1	Water circulation pump 1(Space heating and DHW)
MP2	Water circulation pump 2 (Space heating for Zone1)(Local supply)
MP3	Water circulation pump 3 (Space heating for Zone2)(Local supply)
MP4	Water circulation pump 4 (DHW)
3WV	3-way valve (AC motor) (E*P120/30X-M**D, E*ST**C/30D-M**D) 3-way valve (Stepping motor) (E*P17X-M**D, E*ST17/20D-M**D)
2WV2a	2-way valve (For Zone 1)(Local supply)
2WV2b	2-way valve (For Zone 2)(Local supply)
MXV	Mixing valve (Local supply)
IHT	Thermostat (fixed temp.) for immersion heater
IH	Immersion heater
IHC	Contactor for immersion heater
TH1	Thermistor (Room temp.)(Option)
TH2	Thermistor (Ref. liquid temp.)
THW1	Thermistor (Flow water temp.)
THW2	Thermistor (Return water temp.)
THW5A	Thermistor (DHW tank upper water temp.)
THW5B	Thermistor (DHW tank lower water temp.)
THW6	Thermistor (Zone1 flow temp.)(Option)
THW7	Thermistor (Zone1 return temp.)(Option)
THW8	Thermistor (Zone2 flow temp.)(Option)
THW9	Thermistor (Zone2 return temp.)(Option)
THW10	Thermistor (Mixing tank temp.)(Option)
THWB1	Thermistor (Boiler flow temp.)(Option)
IN1	Room thermostat 1 (Local supply)
IN2	Flow switch 1 (Local supply)
IN3	Flow switch 2 (Local supply)
IN4	Demand control (Local supply)
IN5	Outdoor thermostat (Local supply)
IN6	Room thermostat 2 (Local supply)
IN7	Flow switch 3 (Local supply)
IN8	Electric energy meter 1 (Local supply)
IN9	Electric energy meter 2 (Local supply)
IN10	Heat meter (Local supply)
IN11	Smart grid ready input (Local supply)
IN12	Flow sensor
IN1A	Flow sensor
FLOW TEMP. CONTROLLER (FTC)	
TBO.1-4	Terminal block <Outputs>
TBI.1-6	Terminal block <Signal Inputs, Thermistor>
F1	Fuse (IEC T10AL250V)
F2	Fuse (IEC T6.3AL250V)
SW1-6	DIP switch *See Table 6.9.1
X1-16	Relay
LED1	Power supply (FTC)
LED2	Power supply (Main remote controller)
LED3	Communication (FTC-Outdoor unit)
LED4	Reading or writing data to SD card
CNPWM	Pump speed control signal for MP1
CN108	SD card connector

1. Symbols used in wiring diagram are: : connector, : terminal block. Function with asterisk (\*) may not be available depending on model types.
2. Indoor unit and outdoor unit connecting wires have polarities, make sure to match terminal numbers (S1, S2, S3) for correct wirings.
3. Since the outdoor unit side electric wiring may change, be sure to check the outdoor unit electric wiring diagram for service.
4. Refer to the installation manual for the water circulation diagrams of the models other than shown below.

**Table 1 Signal Inputs**

Name	Terminal block	Connector	Item	OFF (Open)	ON (Short)
IN1	TBI.1	7-8	Room thermostat 1 input *1	Refer to SW2-1 in <Table 6.9.1 DIP Switch Functions>.	
IN2	TBI.1	5-6	Flow switch 1 input	Refer to SW2-2 in <Table 6.9.1 DIP Switch Functions>.	
IN3	TBI.1	3-4	Flow switch 2 input (Zone1)	Refer to SW3-1 in <Table 6.9.1 DIP Switch Functions>.	
IN4	TBI.1	1-2	Demand control input	Normal	Heat source OFF/Boiler operation *3
IN5	TBI.2	7-8	Outdoor thermostat input *2	Standard operation	Heater operation/Boiler operation *3
IN6	TBI.2	5-6	Room thermostat 2 input *1	Refer to SW3-1 in <Table 6.9.1 DIP Switch Functions>.	
IN7	TBI.2	3-4	Flow switch 3 input (Zone2)	Refer to SW3-2 in <Table 6.9.1 DIP Switch Functions>.	
IN8	TBI.3	7-8	Electric energy meter 1		
IN9	TBI.3	5-6	Electric energy meter 2		
IN10	TBI.2	1-2	Heat meter	Refer to installation manual.	
IN11	TBI.3	3-4	Smart grid ready input		
IN12	TBI.3	1-2	Flow sensor		
IN1A	TBI.4	1-3	CN1A Flow sensor		

- \*1. Set the ON/OFF cycle time of the room thermostat for 10 minutes or more, otherwise the compressor may be damaged.
- \*2. If using outdoor thermostat for controlling operation of heaters, the lifetime of the heaters and related parts may be reduced.
- \*3. To turn on the boiler operation, use the main remote controller to select "Boiler" in "External input setting" screen in the service menu.

**Table 2 Outputs**

Name	Terminal block	Connector	Item	OFF	ON
OUT1	TBO.1	1-2	Water circulation pump 1 output (Space heating/cooling & DHW)	OFF	ON
OUT2	TBO.1	3-4	Water circulation pump 2 output (Space heating/cooling for Zone1)	OFF	ON
OUT3	TBO.1	5-6	Water circulation pump 3 output (Space heating/cooling for Zone2) *1	OFF	ON
OUT4	TBO.2	4-6	3-way valve (2-way valve) output	Heating	DHW
OUT5	TBO.2	1-2	3-way valve output		
OUT5	TBO.2	2-3	Mixing valve output *1	Stop	Close Open
OUT6		CNH13	Booster heater 1 output	OFF	ON
OUT7		CNH57	Booster heater 2 output	OFF	ON
OUT8	TBO.4	7-8	Cooling signal output	OFF	ON
OUT9	TBO.4	5-6	Immersion heater output	OFF	ON
OUT10	TBO.3	1-2	Boiler output	OFF	ON
OUT11	TBO.3	5-6	Error output	Normal	Error
OUT12	TBO.3	7-8	Defrost output	Normal	Defrost
OUT13	TBO.4	3-4	2-way valve 2a output *2	OFF	ON
OUT14		CNP4	Water circulation pump 4 output (DHW)	OFF	ON
OUT15	TBO.4	1-2	Comp. ON signal	OFF	ON
OUT16	TBO.3	3-4	Thermo ON signal	OFF	ON
OUTA1	TBI.4	7-8	Analog output	0V-10V	

- Do not connect to the terminals that are indicated as "-" in the "Terminal block" field.
- \*1. For 2-zone temperature control.
  - \*2. For 2-zone valve ON/OFF control.

## 6-4. E\*\*T\*\*\*-M(E)D

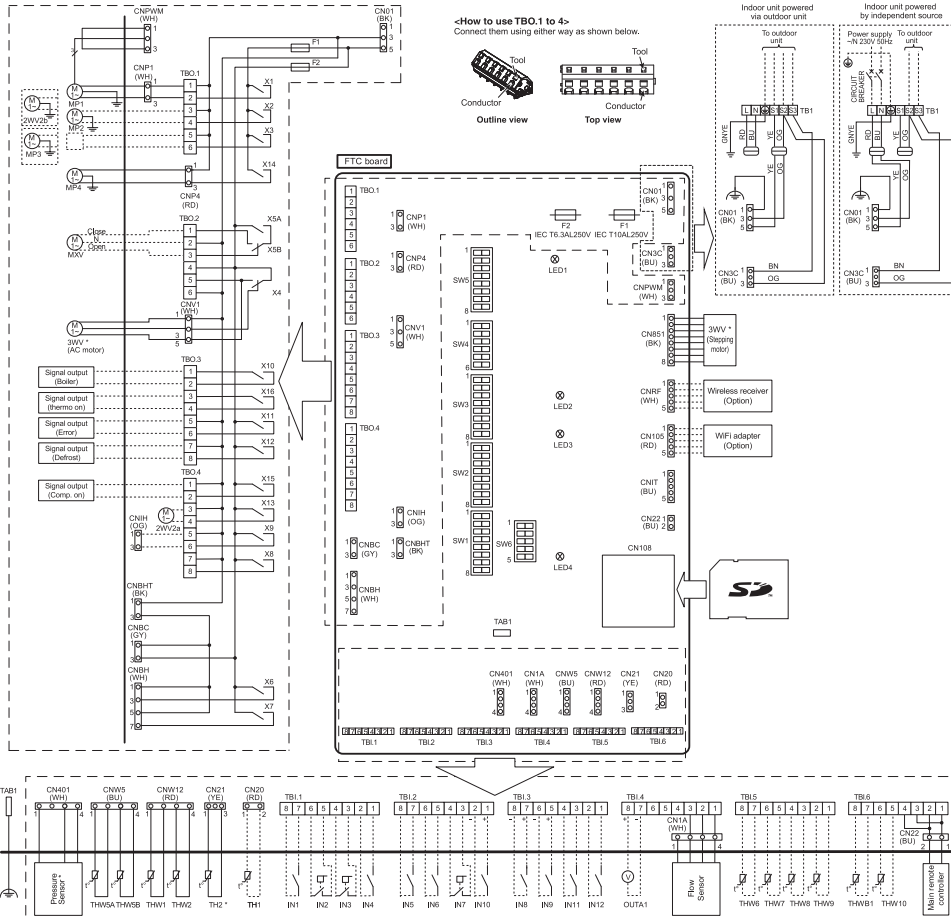

Symbol	Name
TB1	Terminal block <Power supply, Outdoor unit>
ECB1	Earth leakage circuit breaker for booster heater
ECB2	Earth leakage circuit breaker for immersion heater
MP1	Water circulation pump 1(Space heating and DHW)
MP2	Water circulation pump 2 (Space heating for Zone1)(Local supply)
MP3	Water circulation pump 3 (Space heating for Zone2)(Local supply)
MP4	Water circulation pump 4 (DHW)
3WV	3-way valve (AC motor) (E*P20/30X-M**D*, E*ST**C/30D-M**D) 3-way valve (Stepping motor) (E*P117X-M**D*, E*ST117/20D-M**D)
2WV2a	2-way valve (For Zone 1)(Local supply)
2WV2b	2-way valve (For Zone 2)(Local supply)
MXV	Mixing valve (Local supply)
IHT	Thermostat (fixed temp.) for immersion heater
IH	Immersion heater
IHC	Contact for immersion heater
TH1	Thermistor (Room temp.)(Option)
TH2	Thermistor (Ref. liquid temp.)
THW1	Thermistor (Flow water temp.)
THW2	Thermistor (Return water temp.)
THW5A	Thermistor (DHW tank upper water temp.)
THW5B	Thermistor (DHW tank lower water temp.)
THW6	Thermistor (Zone1 flow temp.)(Option)
THW7	Thermistor (Zone1 return temp.)(Option)
THW8	Thermistor (Zone2 flow temp.)(Option)
THW9	Thermistor (Zone2 return temp.)(Option)
THW10	Thermistor (Mixing tank temp.)(Option)
THWB1	Thermistor (Boiler flow temp.)(Option)
IN1	Room thermostat 1 (Local supply)
IN2	Flow switch 1 (Local supply)
IN3	Flow switch 2 (Local supply)
IN4	Demand control (Local supply)
IN5	Outdoor thermostat (Local supply)
IN6	Room thermostat 2 (Local supply)
IN7	Flow switch 3 (Local supply)
IN8	Electric energy meter 1 (Local supply)
IN9	Electric energy meter 2 (Local supply)
IN10	Heat meter (Local supply)
IN11	Smart grid ready input (Local supply)
IN12	Smart grid ready input (Local supply)
INA1	Flow sensor
FLOW TEMP. CONTROLLER (FTC)	
TBO.1-4	Terminal block <Outputs>
TBI.1-6	Terminal block <Signal Inputs, Thermistor>
F1	Fuse (IEC T10AL250V)
F2	Fuse (IEC T6.3AL250V)
SW1-6	DIP switch *See Table 6.9.1
X1-16	Relay
LED1	Power supply (FTC)
LED2	Power supply (Main remote controller)
LED3	Communication (FTC-Outdoor unit)
LED4	Reading or writing data to SD card
CNPWM	Pump speed control signal for MP1
CN108	SD card connector

- Symbols used in wiring diagram are, [ ] : connector, [ ] : terminal block. Function with asterisk (\*) may not be available depending on model types.
- Indoor unit and outdoor unit connecting wires have polarities, make sure to match terminal numbers (S1, S2, S3) for correct wirings.
- Since the outdoor unit side electric wiring may change, be sure to check the outdoor unit electric wiring diagram for service.
- Refer to the installation manual for the water circulation diagrams of the models other than shown below.

**Table 1 Signal Inputs**

Name	Terminal block	Connector	Item	OFF (Open)	ON (Short)
IN1	TBI.1	7-8	Room thermostat 1 input *1	Refer to SW2-1 in <Table 6.9.1 DIP Switch Functions>	
IN2	TBI.1	5-6	Flow switch 1 input	Refer to SW2-2 in <Table 6.9.1 DIP Switch Functions>	
IN3	TBI.1	3-4	Flow switch 2 input (Zone1)	Refer to SW3-2 in <Table 6.9.1 DIP Switch Functions>	
IN4	TBI.1	1-2	Demand control input	Normal	Heat source OFF/Boiler operation *3
IN5	TBI.2	7-8	Outdoor thermostat input *2	Standard operation	Heater operation/Boiler operation *3
IN6	TBI.2	5-6	Room thermostat 2 input *1	Refer to SW3-1 in <Table 6.9.1 DIP Switch Functions>	
IN7	TBI.2	3-4	Flow switch 3 input (Zone2)	Refer to SW3-2 in <Table 6.9.1 DIP Switch Functions>	
IN8	TBI.3	7-8	Electric energy meter 1		
IN9	TBI.3	5-6	Electric energy meter 2		
IN10	TBI.2	1-2	Heat meter	Refer to installation manual.	
IN11	TBI.3	3-4	Smart grid ready input		
IN12	TBI.3	1-2	input		
INA1	TBI.4	1-3	CN1A Flow sensor		

- Set the ON/OFF cycle time of the room thermostat for 10 minutes or more; otherwise the compressor may be damaged.
- If using outdoor thermostat for controlling operation of heaters, the lifetime of the heaters and related parts may be reduced.
- To turn on the boiler operation, use the main remote controller to select "Boiler" in "External input setting" screen in the service menu.

**Table 2 Outputs**

Name	Terminal block	Connector	Item	OFF	ON
OUT1	TBO.1	1-2	CNP1 Water circulation pump 1 output (Space heating/cooling & DHW)	OFF	ON
OUT2	TBO.1	3-4	Water circulation pump 2 output (Space heating/cooling for Zone1)	OFF	ON
OUT3	TBO.1	5-6	Water circulation pump 3 output (Space heating/cooling for Zone2) *1	OFF	ON
OUT4	TBO.2	4-6	CNV1 3-way valve (2-way valve) output	Heating	DHW
OUT5	TBO.2	1-2	CN851 3-way valve output		
OUT6	TBO.2	2-3	Mixing valve output *1	Stop	Close Open
OUT7		CN813	Booster heater 1 output	OFF	ON
OUT8		CN853	Booster heater 2 output	OFF	ON
OUT9	TBO.4	7-8	CN1H Cooling signal output	OFF	ON
OUT10	TBO.4	5-6	CN1H Immersion heater output	OFF	ON
OUT11	TBO.3	1-2	Boiler output	OFF	ON
OUT12	TBO.3	5-6	Error output	Normal	Error
OUT13	TBO.3	7-8	Defrost output	Normal	Defrost
OUT14	TBO.4	3-4	2-way valve 2a output *2	OFF	ON
OUT15		CNP4	Water circulation pump 4 output (DHW)	OFF	ON
OUT16	TBO.4	1-2	Comp. ON signal	OFF	ON
OUT17	TBO.3	3-4	Thermo ON signal	OFF	ON
OUTA1	TBI.4	7-8	Analog output	0V-10V	

Do not connect to the terminals that are indicated as "-" in the "Terminal block" field.  
\*1. For 2-zone temperature control.  
\*2. For 2-zone valve ON/OFF control.

## 6-5. EH\*T\*\*\*-TM9(E)D

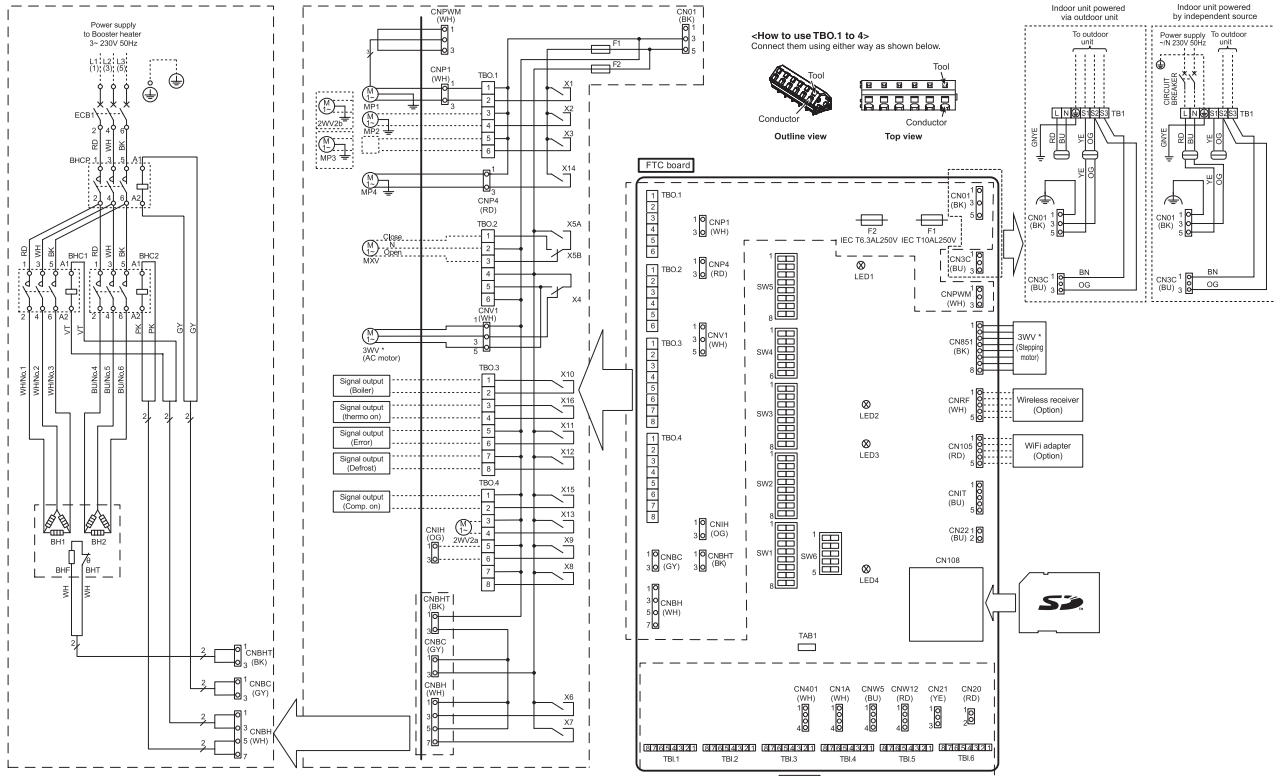

Symbol	Name
TB1	Terminal block <Power supply, Outdoor unit>
ECB1	Earth leakage circuit breaker for booster heater
ECB2	Earth leakage circuit breaker for immersion heater
MP1	Water circulation pump 1(Space heating and DHW)
MP2	Water circulation pump 2 (Space heating for Zone1)(Local supply)
MP3	Water circulation pump 3 (Space heating for Zone2)(Local supply)
MP4	Water circulation pump 4 (DHW)
3WV	3-way valve (AC motor) (E*PT20/30X-M**D*, E-ST**C/30D-M**D) 3-way valve (Stepping motor) (E*PT17X-M**D*, E-ST17/20D-M**D)
2WV2a	2-way valve (For Zone 1)(Local supply)
2WV2b	2-way valve (For Zone 2)(Local supply)
MXV	Mixing valve (Local supply)
IHT	Thermostat (fixed temp.) for immersion heater
IH	Immersion heater
IHC	Contactor for immersion heater
TH1	Thermistor (Room temp.)(Option)
TH2	Thermistor (Ref. liquid temp.)
THW1	Thermistor (Flow water temp.)
THW2	Thermistor (Return water temp.)
THW5A	Thermistor (DHW tank upper water temp.)
THW5B	Thermistor (DHW tank lower water temp.)
THW6	Thermistor (Zone1 flow temp.)(Option)
THW7	Thermistor (Zone1 return temp.)(Option)
THW8	Thermistor (Zone2 flow temp.)(Option)
THW9	Thermistor (Zone2 return temp.)(Option)
THW10	Thermistor (Mixing tank temp.)(Option)
THWB1	Thermistor (Boiler flow temp.)(Option)
IN1	Room thermostat 1 (Local supply)
IN2	Flow switch 1 (Local supply)
IN3	Flow switch 2 (Local supply)
IN4	Demand control (Local supply)
IN5	Outdoor thermostat (Local supply)
IN6	Room thermostat 2 (Local supply)
IN7	Flow switch 3 (Local supply)
IN8	Electric energy meter 1 (Local supply)
IN9	Electric energy meter 2 (Local supply)
IN10	Heat meter (Local supply)
IN11	Smart grid ready input (Local supply)
IN12	input
INA1	Flow sensor
FLOW TEMP. CONTROLLER (FTC)	
TBO.1-4	Terminal block <Outputs>
TBI.1-6	Terminal block <Signal Input, Thermistor>
F1	Fuse (IEC T10AL250V)
F2	Fuse (IEC T6.3AL250V)
SW1-6	DIP switch *See Table 6.9.1
X1-16	Relay
LED1	Power supply (FTC)
LED2	Power supply (Main remote controller)
LED3	Communication (FTC-Outdoor unit)
LED4	Reading or writing data to SD card
CNPWM	Pump speed control signal for MP1
CN108	SD card connector

1. Symbols used in wiring diagram are. : connector, : terminal block. Function with asterisk (\*) may not be available depending on model types.
2. Indoor unit and outdoor unit connecting wires have polarities, make sure to match terminal numbers (S1, S2, S3) for correct wirings.
3. Since the outdoor unit side electric wiring may change, be sure to check the outdoor unit electric wiring diagram for service.
4. Refer to the installation manual for the water circulation diagrams of the models other than shown below.

**Table 1 Signal Inputs**

Name	Terminal block	Connector	Item	OFF (Open)	ON (Short)
IN1	TBI.1 7-8	—	Room thermostat 1 input *1	Refer to SW2-1 in < Table 6.9.1 DIP Switch Functions >.	
IN2	TBI.1 5-6	—	Flow switch 1 input	Refer to SW2-2 in < Table 6.9.1 DIP Switch Functions >.	
IN3	TBI.1 3-4	—	Flow switch 2 input (Zone1)	Refer to SW3-2 in < Table 6.9.1 DIP Switch Functions >.	
IN4	TBI.1 1-2	—	Demand control input	Normal	Heat source OFF/Boiler operation *3
IN5	TBI.2 7-8	—	Outdoor thermostat input *2	Standard operation	Heater operation/Boiler operation *3
IN6	TBI.2 5-6	—	Room thermostat 2 input *1	Refer to SW3-1 in < Table 6.9.1 DIP Switch Functions >.	
IN7	TBI.2 3-4	—	Flow switch 3 input (Zone2)	Refer to SW3-2 in < Table 6.9.1 DIP Switch Functions >.	
IN8	TBI.3 7-8	—	Electric energy meter 1		
IN9	TBI.3 5-6	—	Electric energy meter 2		
IN10	TBI.2 1-2	—	Heat meter	Refer to installation manual.	
IN11	TBI.3 3-4	—	Smart grid ready		
IN12	TBI.3 1-2	—	input		
INA1	TBI.4 1-3	CN1A	Flow sensor		

- \*1. Set the ON/OFF cycle time of the room thermostat for 10 minutes or more; otherwise the compressor may be damaged.
- \*2. If using outdoor thermostat for controlling operation of heaters, the lifetime of the heaters and related parts may be reduced.
- \*3. To turn on the boiler operation, use the main remote controller to select "Boiler" in "External input setting" screen in the service menu.

**Table 2 Outputs**

Name	Terminal block	Connector	Item	OFF	ON
OUT1	TBO.1 1-2	CNP1	Water circulation pump 1 output (Space heating/cooling & DHW)	OFF	ON
OUT2	TBO.1 3-4	—	Water circulation pump 2 output (Space heating/cooling for Zone1)	OFF	ON
OUT3	TBO.1 5-6	—	Water circulation pump 3 output (Space heating/cooling for Zone2) *1	OFF	ON
OUT4	TBO.2 4-6	CNV1 CN851	2-way valve 2b output *2 3-way valve (2-way valve) output 3-way valve output	Heating	DHW
OUT5	TBO.2 1-2	—	Mixing valve output *1	Stop	Close Open
OUT6	—	CNH13	Booster heater 1 output	OFF	ON
OUT7	—	CNH57	Booster heater 2 output	OFF	ON
OUT8	TBO.4 7-8	—	Cooling signal output	OFF	ON
OUT9	TBO.4 5-6	CNIH	Immersion heater output	OFF	ON
OUT10	TBO.3 1-2	—	Boiler output	OFF	ON
OUT11	TBO.3 5-6	—	Error output	Normal	Error
OUT12	TBO.3 7-8	—	Defrost output	Normal	Defrost
OUT13	TBO.4 3-4	—	2-way valve 2a output *2	OFF	ON
OUT14	—	CNP4	Water circulation pump 4 output (DHW)	OFF	ON
OUT15	TBO.4 1-2	—	Comp. ON signal	OFF	ON
OUT16	TBO.3 3-4	—	Thermo ON signal	OFF	ON
OUTA1	TBI.4 7-8	—	Analog output	0V-10V	

Do not connect to the terminals that are indicated as "—" in the "Terminal block" field.  
 \*1. For 2-zone temperature control.  
 \*2. For 2-zone valve ON/OFF control.

## 6-6. ERST17D-VM2BD

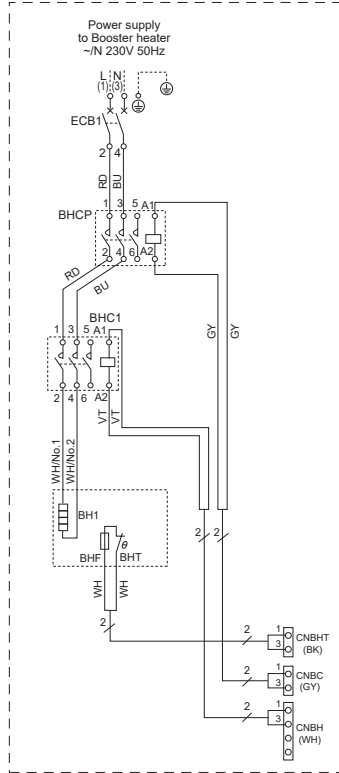

### [LEGEND]

Symbol	Name
TB1	Terminal block <Power supply, Outdoor unit>
ECB1	Earth leakage circuit breaker for booster heater
ECB2	Earth leakage circuit breaker for immersion heater (Option)
MP1	Water circulation pump 1 (Space heating and DHW)
MP2	Water circulation pump 2 (Space heating for Zone1)
MP3	Water circulation pump 3 (Space heating for Zone2)
MP4	Water circulation pump 4 (DHW)
3WV	3-way valve (AC motor) (E*PT20/30X*M*D*, E*ST*C/30D*M*D) 3-way valve (Stepping motor) (E*PT17X*M*D*, E*ST17/20D*M*D)
MXV	Mixing valve
IHT	Thermostat (fixed temp.) for immersion heater (Option)
IH	Immersion heater (Option)
IHC	Contact for immersion heater (Option)
TH1	Thermistor (Room temp.) (Option)
TH2	Thermistor (Ref. liquid temp.)
THW1	Thermistor (Flow water temp.)
THW2	Thermistor (Return water temp.)
THW5A	Thermistor (DHW tank upper water temp.)
THW5B	Thermistor (DHW tank lower water temp.)
THW6	Thermistor (Zone1 flow temp.)
THW7	Thermistor (Zone1 return temp.)
THW8	Thermistor (Zone2 flow temp.)
THW9	Thermistor (Zone2 return temp.)
THW10	Thermistor (Mixing tank temp.) (Option)
THWB1	Thermistor (Boiler flow temp.) (Option)
IN1	Room thermostat 1 (Local supply)
IN2	Flow switch 1 (Local supply)
IN3	Flow switch 2 (Local supply)
IN4	Demand control (Local supply)
IN5	Outdoor thermostat (Local supply)
IN6	Room thermostat 2 (Local supply)
IN7	Flow switch 3 (Local supply)
IN8	Electric energy meter 1 (Local supply)
IN9	Electric energy meter 2 (Local supply)
IN10	Heat meter (Local supply)
IN11	Smart grid ready input (Local supply)
IN12	Flow sensor
INA1	Flow sensor
<b>FLOW TEMP. CONTROLLER (FTC)</b>	
TBO.1-4 Terminal block <Outputs>	
TBI.1-6	Terminal block <Signal Inputs, Thermistor>
F1	Fuse (IEC T10AL250V)
F2	Fuse (IEC T6.3AL250V)
SW1-6	DIP switch *See Table 6.9.1
X1-16	Relay
LED1	Power supply (FTC)
LED2	Power supply (Main remote controller)
LED3	Communication (FTC-Outdoor unit)
LED4	Reading or writing data to SD card
CNPWM	Pump speed control signal for MP1
CN108	SD card connector

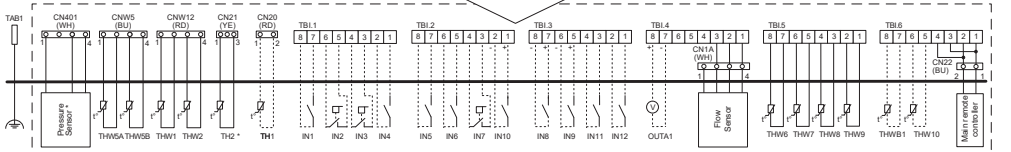
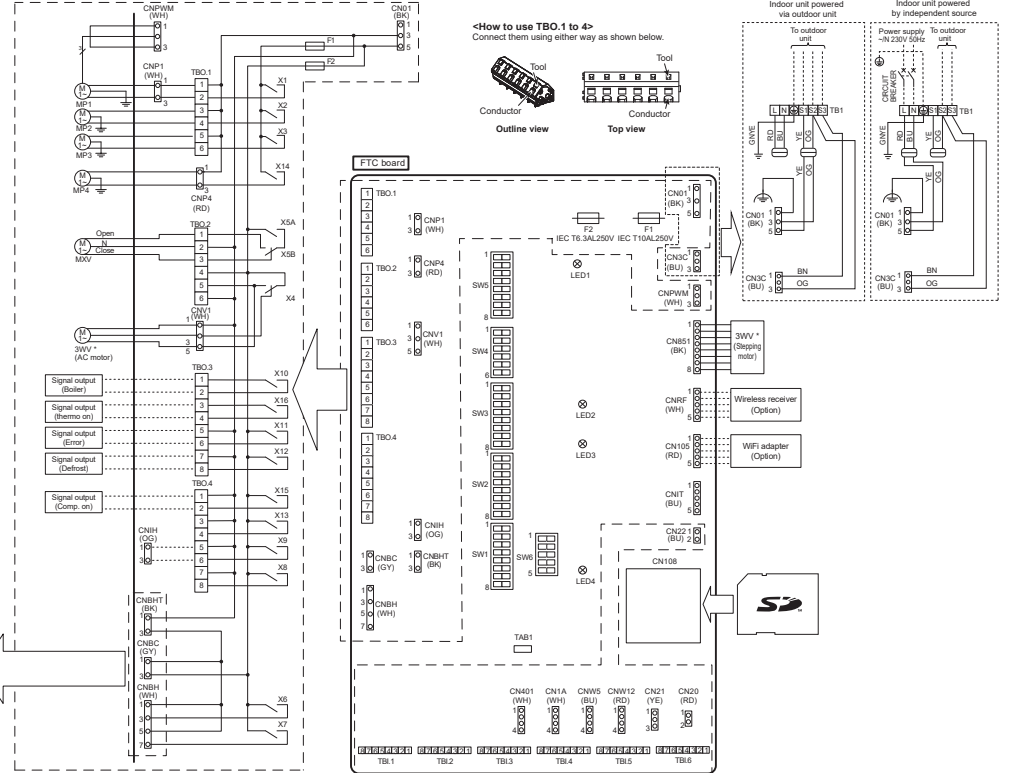

- Symbols used in wiring diagram are: : connector, : terminal block. Function with asterisk (\*) may not be available depending on model types.
- Indoor unit and outdoor unit connecting wires have polarities, make sure to match terminal numbers (S1, S2, S3) for correct wirings.
- Since the outdoor unit side electric wiring may change, be sure to check the outdoor unit electric wiring diagram for service.
- Refer to the installation manual for the water circulation diagrams of the models other than shown below.

**Table 1 Signal Inputs**

Name	Terminal block	Connector	Item	OFF (Open)	ON (Short)
IN1	TBI.1 7-8	—	Room thermostat 1 input *1	Refer to SW2-1 in < Table 6.9.1 DIP Switch Functions >	
IN2	TBI.1 5-6	—	Flow switch 1 input	Refer to SW2-2 in < Table 6.9.1 DIP Switch Functions >	
IN3	TBI.1 3-4	—	Flow switch 2 input (Zone1)	Refer to SW3-2 in < Table 6.9.1 DIP Switch Functions >	
IN4	TBI.1 1-2	—	Demand control input	Normal	Heat source OFF/ Boiler operation *3
IN5	TBI.2 7-8	—	Outdoor thermostat input *2	Standard operation	Boiler operation/ Boiler operation *3
IN6	TBI.2 5-6	—	Room thermostat 2 input *1	Refer to SW3-1 in < Table 6.9.1 DIP Switch Functions >	
IN7	TBI.2 3-4	—	Flow switch 3 input (Zone2)	Refer to SW3-2 in < Table 6.9.1 DIP Switch Functions >	
IN8	TBI.3 7-8	—	Electric energy meter 1	Refer to installation manual.	
IN9	TBI.3 5-6	—	Electric energy meter 2		
IN10	TBI.2 1-2	—	Heat meter		
IN11	TBI.3 3-4	—	Smart grid ready input		
IN12	TBI.3 1-2	—	input		
INA1	TBI.4 1-3	CN1A	Flow sensor		

- Set the ON/OFF cycle time of the room thermostat for 10 minutes or more; otherwise the compressor may be damaged.
- If using outdoor thermostat for controlling operation of heaters, the lifetime of the heaters and related parts may be reduced.
- To turn on the boiler operation, use the main remote controller to select "Boiler" in "External input setting" screen in the service menu.

**Table 2 Outputs**

Name	Terminal block	Connector	Item	OFF	ON
OUT1	TBO.1 1-2	CNP1	Water circulation pump 1 output (Space heating/cooling & DHW)	OFF	ON
OUT2	TBO.1 3-4	—	Water circulation pump 2 output (Space heating/cooling for Zone1)	OFF	ON
OUT3	TBO.1 5-6	—	Water circulation pump 3 output (Space heating/cooling for Zone2) *1	OFF	ON
OUT4	TBO.2 4-6	CNV1	3-way valve 2b output *2	Heating	DHW
OUT5	TBO.2 1-2	—	Mixing valve output *1	Stop	Close
OUT6	TBO.2 2-3	—	Booster heater 1 output	OFF	Open
OUT7	—	CNH5	Booster heater 2 output	OFF	ON
OUT8	TBO.4 7-8	—	Cooling signal output	OFF	ON
OUT9	TBO.4 5-6	CNIH	Immersion heater output	OFF	ON
OUT10	TBO.3 1-2	—	Boiler output	OFF	ON
OUT11	TBO.3 5-6	—	Error output	Normal	Error
OUT12	TBO.3 7-8	—	Defrost output	Normal	Defrost
OUT13	TBO.4 3-4	—	2-way valve 2a output *2	OFF	ON
OUT14	—	CNP4	Water circulation pump 4 output (DHW)	OFF	ON
OUT15	TBO.4 1-2	—	Comp. ON signal	OFF	ON
OUT16	TBO.3 3-4	—	Thermo ON signal	OFF	ON
OUTA1	TBI.4 7-8	—	Analog output	0V-10V	

Do not connect to the terminals that are indicated as "—" in the "Terminal block" field.

\*1. For 2-zone temperature control. \*2. For 2-zone valve ON/OFF control.

## 6-7. ERST17D-VM6BD

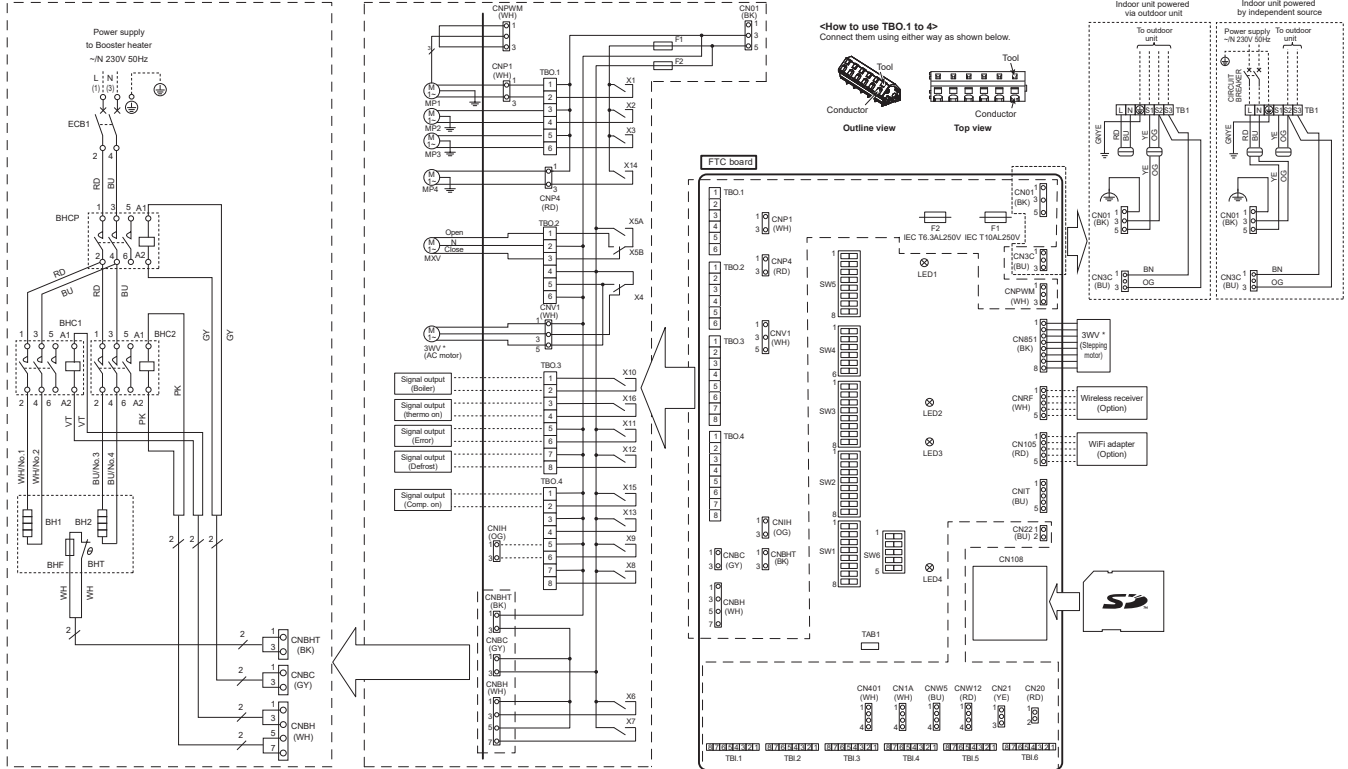

Symbol	Name
TB1	Terminal block <Power supply, Outdoor unit>
ECB1	Earth leakage circuit breaker for booster heater
ECB2	Earth leakage circuit breaker for immersion heater (Option)
MP1	Water circulation pump 1 (Space heating and DHW)
MP2	Water circulation pump 2 (Space heating for Zone1)
MP3	Water circulation pump 3 (Space heating for Zone2)
MP4	Water circulation pump 4 (DHW)
3WV	3-way valve (AC motor) (E*PT20/30X-M**D, E*ST**C/30D-M**D) 3-way valve (Stepping motor) (E*PT17X-M**D, E*ST17/20D-M**D)
MXV	Mixing valve
IHT	Thermostat (fixed temp.) for immersion heater (Option)
IH	Immersion heater (Option)
IHC	Contact for immersion heater (Option)
TH1	Thermistor (Room temp.) (Option)
TH2	Thermistor (Ref. liquid temp.)
THW1	Thermistor (Flow water temp.)
THW2	Thermistor (Return water temp.)
THW5A	Thermistor (DHW tank upper water temp.)
THW5B	Thermistor (DHW tank lower water temp.)
THW6	Thermistor (Zone1 flow temp.)
THW7	Thermistor (Zone1 return temp.)
THW8	Thermistor (Zone2 flow temp.)
THW9	Thermistor (Zone2 return temp.)
THW10	Thermistor (Mixing tank temp.) (Option)
THWB1	Thermistor (Boiler flow temp.) (Option)
IN1	Room thermostat 1 (Local supply)
IN2	Flow switch 1 (Local supply)
IN3	Flow switch 2 (Local supply)
IN4	Demand control (Local supply)
IN5	Outdoor thermostat (Local supply)
IN6	Room thermostat 2 (Local supply)
IN7	Flow switch 3 (Local supply)
IN8	Electric energy meter 1 (Local supply)
IN9	Electric energy meter 2 (Local supply)
IN10	Heat meter (Local supply)
IN11	Smart grid ready input (Local supply)
IN12	Smart grid ready input (Local supply)
INA1	Flow sensor
<b>FLOW TEMP. CONTROLLER (FTC)</b>	
TBO.1-4	Terminal block <Outputs>
TB1.1-6	Terminal block <Signal Inputs, Thermistor>
F1	Fuse (IEC T10AL250V)
F2	Fuse (IEC T6.3AL250V)
SW1-6	DIP switch *See Table 6.9.1
X1-16	Relay
LED1	Power supply (FTC)
LED2	Power supply (Main remote controller)
LED3	Communication (FTC-Outdoor unit)
LED4	Reading or writing data to SD card
CNPWM	Pump speed control signal for MP1
CN108	SD card connector

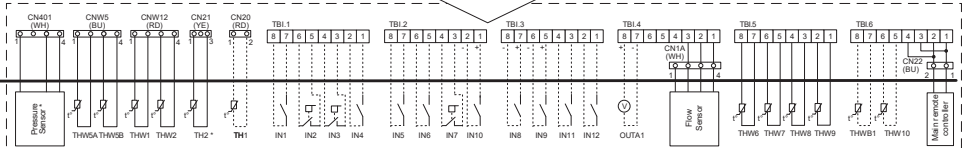

1. Symbols used in wiring diagram are, : connector, : terminal block. Function with asterisk (\*) may not be available depending on model types.
2. Indoor unit and outdoor unit connecting wires have polarities, make sure to match terminal numbers (S1, S2, S3) for correct wirings.
3. Since the outdoor unit side electric wiring may change, be sure to check the outdoor unit electric wiring diagram for service.
4. Refer to the installation manual for the water circulation diagrams of the models other than shown below.

**Table 1 Signal Inputs**

Name	Terminal block	Connector	Item	OFF (Open)	ON (Short)
IN1	TB1.1	7-8	Room thermostat 1 input *1	Refer to SW2-1 in < Table 6.9.1 DIP Switch Functions>.	
IN2	TB1.1	5-6	Flow switch 1 input	Refer to SW2-2 in < Table 6.9.1 DIP Switch Functions>.	
IN3	TB1.1	3-4	Flow switch 2 input (Zone1)	Refer to SW3-2 in < Table 6.9.1 DIP Switch Functions>.	
IN4	TB1.1	1-2	Demand control input	Normal	Heat source OFF/Boiler operation *3
IN5	TB1.2	7-8	Outdoor thermostat input *2	Standard operation	Heater operation/Boiler operation *3
IN6	TB1.2	5-6	Room thermostat 2 input *1	Refer to SW3-1 in < Table 6.9.1 DIP Switch Functions>.	
IN7	TB1.2	3-4	Flow switch 3 input (Zone2)	Refer to SW3-2 in < Table 6.9.1 DIP Switch Functions>.	
IN8	TB1.3	7-8	Electric energy meter 1	Refer to installation manual.	
IN9	TB1.3	5-6	Electric energy meter 2		
IN10	TB1.2	1-2	Heat meter		
IN11	TB1.3	3-4	Smart grid ready input		
IN12	TB1.3	1-2	Smart grid ready input		
INA1	TB1.4	1-3	CN1A Flow sensor		

- \*1. Set the ON/OFF cycle time of the room thermostat for 10 minutes or more; otherwise the compressor may be damaged.
- \*2. If using outdoor thermostat for controlling operation of heaters, the lifetime of the heaters and related parts may be reduced.
- \*3. To turn on the boiler operation, use the main remote controller to select "Boiler" in "External input setting" screen in the service menu.

**Table 2 Outputs**

Name	Terminal block	Connector	Item	OFF	ON
OUT1	TBO.1	1-2	CNP1 Water circulation pump 1 output (Space heating/cooling & DHW)	OFF	ON
OUT2	TBO.1	3-4	Water circulation pump 2 output (Space heating/cooling for Zone1)	OFF	ON
OUT3	TBO.1	5-6	Water circulation pump 3 output (Space heating/cooling for Zone2) *1	OFF	ON
OUT4	TBO.2	4-6	CNV1 3-way valve (2-way valve) output	Heating	DHW
OUT5	TBO.2	2-3	CN851 3-way valve output	Stop	Close
OUT6	—	—	—	—	—
OUT7	—	—	—	—	—
OUT8	TBO.4	7-8	DN13 DN857 Booster heater 1 output	OFF	ON
OUT9	TBO.4	5-6	CNIH Cooling signal output	OFF	ON
OUT10	TBO.3	1-2	—	Normal	Error
OUT11	TBO.3	5-6	—	Normal	Error
OUT12	TBO.3	7-8	—	Normal	Defrost
OUT13	TBO.4	3-4	—	OFF	ON
OUT14	—	—	—	—	—
OUT15	TBO.4	1-2	CNP4 2-way valve 2a output *2 (DHW)	OFF	ON
OUT16	TBO.3	3-4	—	OFF	ON
OUT17	TBO.3	3-4	—	OFF	ON
OUT18	TBO.3	3-4	—	OFF	ON
OUT19	TBO.3	3-4	—	OFF	ON
OUT20	TBO.3	3-4	—	OFF	ON
OUT21	TB1.4	7-8	—	OV-10V	

Do not connect to the terminals that are indicated as "—" in the "Terminal block" field.  
 \*1. For 2-zone temperature control. \*2. For 2-zone valve ON/OFF control.

## 6-8. ERST17D-YM9BD

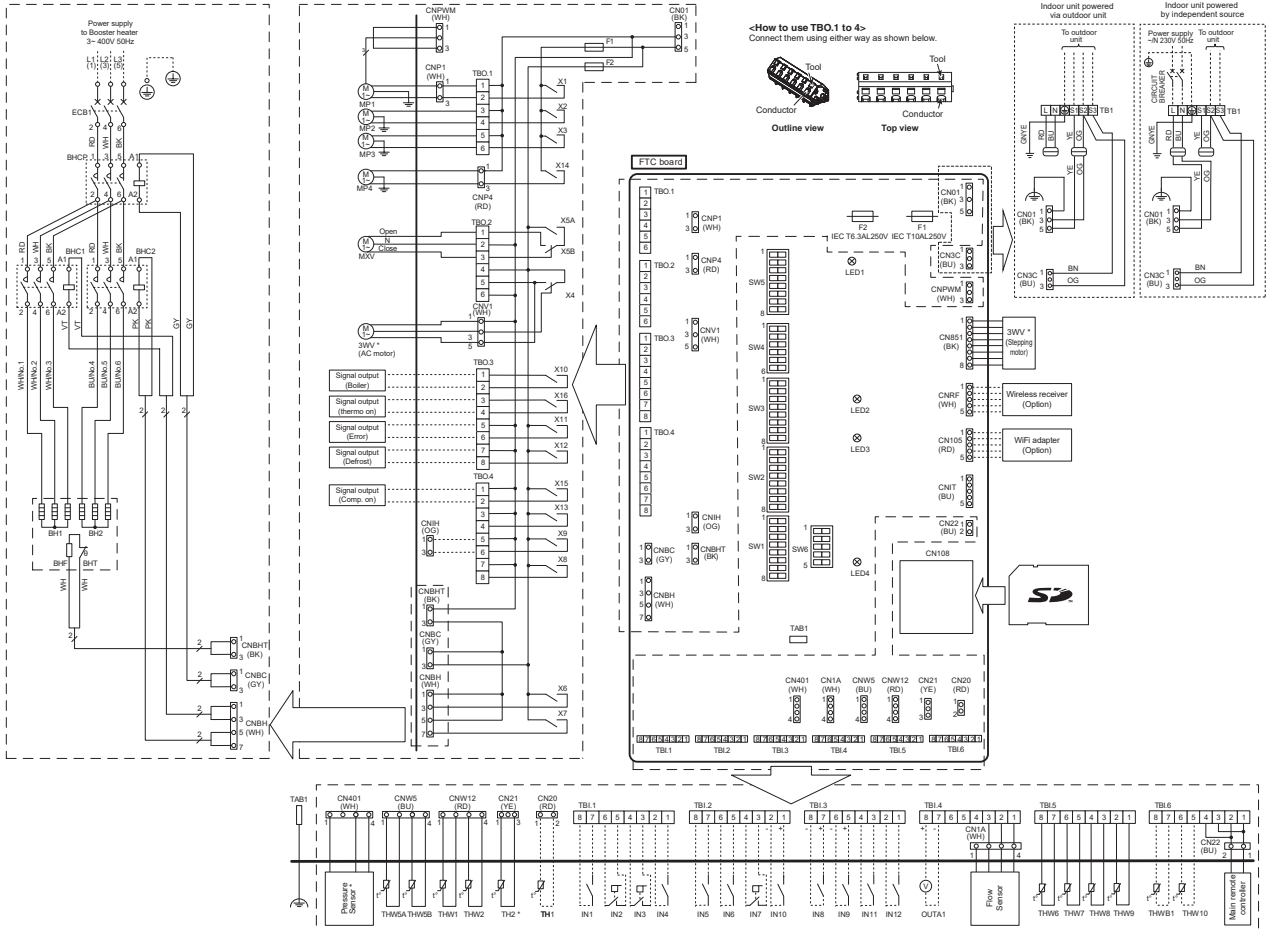

### LEGEND

Symbol	Name
TB1	Terminal block <Power supply, Outdoor unit>
ECB1	Earth leakage circuit breaker for booster heater
ECB2	Earth leakage circuit breaker for immersion heater (Option)
MP1	Water circulation pump 1 (Space heating and DHW)
MP2	Water circulation pump 2 (Space heating for Zone1)
MP3	Water circulation pump 3 (Space heating for Zone2)
MP4	Water circulation pump 4 (DHW)
3WV	3-way valve (AC motor) (E*P1T20/30X-M*D*, E*ST17C/30D-M*D) 3-way valve (Stepping motor) (E*P1T17X-M*D*, E*ST17/20D-M*D)
MXV	Mixing valve
IHT	Thermostat (fixed temp.) for immersion heater (Option)
IH	Immersion heater (Option)
IHC	Contactor for immersion heater (Option)
TH1	Thermistor (Room temp.) (Option)
TH2	Thermistor (Ref. liquid temp.)
THW1	Thermistor (Flow water temp.)
THW2	Thermistor (Return water temp.)
THW5A	Thermistor (DHW tank upper water temp.)
THW5B	Thermistor (DHW tank lower water temp.)
THW6	Thermistor (Zone1 flow temp.)
THW7	Thermistor (Zone1 return temp.)
THW8	Thermistor (Zone2 flow temp.)
THW9	Thermistor (Zone2 return temp.)
THW10	Thermistor (Mixing tank temp.) (Option)
THWB1	Thermistor (Boiler flow temp.) (Option)
IN1	Room thermostat 1 (Local supply)
IN2	Flow switch 1 (Local supply)
IN3	Flow switch 2 (Local supply)
IN4	Demand control (Local supply)
IN5	Outdoor thermostat (Local supply)
IN6	Room thermostat 2 (Local supply)
IN7	Flow switch 3 (Local supply)
IN8	Electric energy meter 1 (Local supply)
IN9	Electric energy meter 2 (Local supply)
IN10	Heat meter (Local supply)
IN11	Smart grid ready input (Local supply)
IN12	—
INA1	Flow sensor
FLOW TEMP. CONTROLLER (FTC)	
TBO.1-4	Terminal block <Outputs>
TB1.1-6	Terminal block <Signal Inputs, Thermistor>
F1	Fuse (IEC T10AL250V)
F2	Fuse (IEC T6.3AL250V)
SW1-6	DIP switch *See Table 6.9.1
X1-16	Relay
LED1	Power supply (FTC)
LED2	Power supply (Main remote controller)
LED3	Communication (FTC-Outdoor unit)
LED4	Reading or writing data to SD card
CNPWM	Pump speed control signal for MP1
CN108	SD card connector

1. Symbols used in wiring diagram are,  $\square$  : connector,  $\square$  : terminal block. Function with asterisk (\*) may not be available depending on model types.
2. Indoor unit and outdoor unit connecting wires have polarities, make sure to match terminal numbers (S1, S2, S3) for correct wirings.
3. Since the outdoor unit side electric wiring may change, be sure to check the outdoor unit electric wiring diagram for service.
4. Refer to the installation manual for the water circulation diagrams of the models other than shown below.

Table 1 Signal Inputs

Name	Terminal block	Connector	Item	OFF (Open)	ON (Short)
IN1	TB1.1	7-8	Room thermostat 1 input *1	Refer to SW2-1 in < Table 6.9.1 DIP Switch Functions >	
IN2	TB1.1	5-6	Flow switch 1 input	Refer to SW2-2 in < Table 6.9.1 DIP Switch Functions >	
IN3	TB1.1	3-4	Flow switch 2 input (Zone1)	Refer to SW3-2 in < Table 6.9.1 DIP Switch Functions >	
IN4	TB1.1	1-2	Demand control input	Normal	Heat source OFF/Boiler operation *3
IN5	TB1.2	7-8	Outdoor thermostat input *2	Standard operation	Heater operation/Boiler operation *3
IN6	TB1.2	5-6	Room thermostat 2 input *1	Refer to SW3-1 in < Table 6.9.1 DIP Switch Functions >	
IN7	TB1.2	3-4	Flow switch 3 input (Zone2)	Refer to SW3-2 in < Table 6.9.1 DIP Switch Functions >	
IN8	TB1.3	7-8	Electric energy meter 1		
IN9	TB1.3	5-6	Electric energy meter 2		
IN10	TB1.2	1-2	Heat meter		
IN11	TB1.3	3-4	Smart grid ready input		
IN12	TB1.3	1-2	—		
INA1	TB1.4	1-3	CN1A Flow sensor		

\*1. Set the ON/OFF cycle time of the room thermostat for 10 minutes or more; otherwise the compressor may be damaged.

\*2. If using outdoor thermostat for controlling operation of heaters, the lifetime of the heaters and related parts may be reduced.

\*3. To turn on the boiler operation, use the main remote controller to select "Boiler" in "External input setting" screen in the service menu.

Table 2 Outputs

Name	Terminal block	Connector	Item	OFF	ON
OUT1	TBO.1	1-2	CNP1 Water circulation pump 1 output (Space heating/cooling & DHW)	OFF	ON
OUT2	TBO.1	3-4	Water circulation pump 2 output (Space heating/cooling for Zone1)	OFF	ON
OUT3	TBO.1	5-6	Water circulation pump 3 output (Space heating/cooling for Zone2) *1	OFF	ON
OUT4	TBO.2	4-6	CNV1 3-way valve (2-way valve) output	Heating	DHW
			CN851 3-way valve output		
OUT5	TBO.2	1-2	—	Stop	Close
			TBO.2 2-3	Open	
OUT6	—	DN81	1-3 Booster heater 1 output	OFF	ON
OUT7	—	DN85	7-8 Booster heater 2 output	OFF	ON
OUT8	TBO.4	7-8	CN1H Cooling signal output	OFF	ON
OUT9	TBO.4	5-6	CN1H Immersion heater output	OFF	ON
OUT10	TBO.3	1-2	Boiler output	OFF	ON
OUT11	TBO.3	5-6	Error output	Normal	Error
OUT12	TBO.3	7-8	Defrost output	Normal	Defrost
OUT13	TBO.4	3-4	2-way valve 2a output *2	OFF	ON
OUT14	—	CNP4	Water circulation pump 4 output (DHW)	OFF	ON
OUT15	TBO.4	1-2	Comp. ON signal	OFF	ON
OUT16	TBO.3	3-4	Thermo ON signal	OFF	ON
OUTA1	TB1.4	7-8	CN1A Analog output	0V-10V	

Do not connect to the terminals that are indicated as "—" in the "Terminal block" field.

\*1. For 2-zone temperature control. \*2. For 2-zone valve ON/OFF control.

## 6-9. DIP Switch Functions

The DIP switch number is printed on the circuit board next to the relevant switches. The word ON is printed on the circuit board and on the DIP switch block itself. To move the switch you need to use a pin or the corner of a thin metal ruler or similar.

DIP switch settings are listed below in Table 6.6.1.

Only an authorised installer can change DIP switch setting under one's own responsibility according to the installation condition.

Make sure to turn off both indoor unit and outdoor unit power supplies before changing the switch settings.

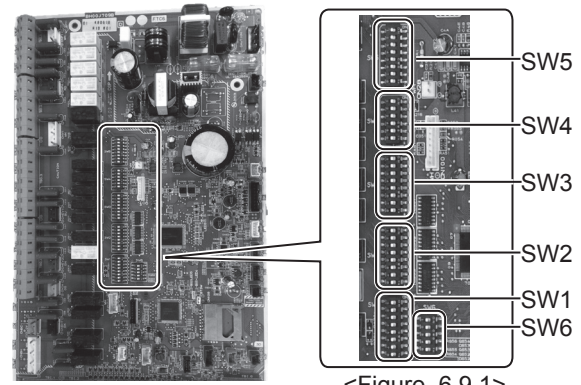

<Figure 6.9.1>

DIP switch	Function	OFF	ON	Default settings: Indoor model name			
SW1	SW1-1 Boiler	WITHOUT Boiler	WITH Boiler	OFF			
	SW1-2 Heat pump maximum outlet water temperature	55°C	60°C	ON *1			
	SW1-3 DHW tank	WITHOUT DHW tank	WITH DHW tank	ON			
	SW1-4 Immersion heater	WITHOUT Immersion heater	WITH Immersion heater	OFF: Except EHPT20X-MHEDW ON : EHPT20X-MHEDW			
	SW1-5 Booster heater	WITHOUT Booster heater	WITH Booster heater	OFF: E**T***-M**D* ON : E**T***-M 2/6/9*D			
	SW1-6 Booster heater function	For heating only	For heating and DHW	OFF: E**T***-M**D* ON : E**T***-M 2/6/9*D			
	SW1-7 Outdoor unit type	Split type	Packaged type	OFF: E*ST***-M**D ON : E*PT**X-*M**D*			
	SW1-8 Wireless remote controller	WITHOUT Wireless remote controller	WITH Wireless remote controller	OFF			
SW2	SW2-1 Room thermostat1 input (IN1) logic change	Zone1 operation stop at thermostat short	Zone1 operation stop at thermostat open	OFF			
	SW2-2 Flow switch1 input (IN2) logic change	Failure detection at short	Failure detection at open	OFF			
	SW2-3 Booster heater capacity restriction	Inactive	Active	OFF: Except E**T***-VM2*D ON : E**T***-VM2*D			
	SW2-4 Cooling mode function	Inactive	Active	OFF: EH*T***-M**D* ON : ER*T***-M**D			
	SW2-5 Automatic switch to backup heat source operation (When outdoor unit stops by error)	Inactive	Active *2	OFF			
	SW2-6 Mixing tank	WITHOUT Mixing tank	WITH Mixing tank	OFF: Except E*ST***-M*BD ON : E*ST***-M*BD			
	SW2-7 2-zone temperature control	Inactive	Active *3				
	SW2-8 Flow sensor	WITHOUT Flow sensor	WITH Flow sensor	ON			
SW3	SW3-1 Room thermostat 2 input (IN6) logic change	Zone2 operation stop at thermostat short	Zone2 operation stop at thermostat open	OFF			
	SW3-2 Flow switch 2 and 3 input logic change	Failure detection at short	Failure detection at open	OFF			
	SW3-3 3-way valve type	AC motor	Stepping motor	OFF: E*PT20/30X-M**D* E*ST**C/30D-*M**D ON : E*PT17X-*M**D* E*ST17/20D-*M**D			
	SW3-4 Electric energy meter	WITHOUT Electric energy meter	WITH Electric energy meter	OFF			
	SW3-5 Heating mode function *4	Inactive	Active	ON			
	SW3-6 2-zone valve ON/OFF control	Inactive	Active	OFF			
	SW3-7 Heat exchanger for DHW	Coil in tank	External plate HEX	ON			
	SW3-8 Heat meter	WITHOUT Heat meter	WITH Heat meter	OFF			
SW4	SW4-1	—	—	OFF			
	SW4-2	—	—	OFF			
	SW4-3	—	—	OFF			
	SW4-4 Indoor unit only operation (during installation work) *5	Inactive	Active	OFF			
	SW4-5 Emergency mode (Heater only operation)	Normal	Emergency mode (Heater only operation)	OFF *6			
	SW4-6 Emergency mode (Boiler operation)	Normal	Emergency mode (Boiler operation)	OFF *6			
SW5	SW5-1	—	—	OFF			
	SW5-2 Advanced auto adaptation	Inactive	Active	ON			
	SW5-3	Capacity code					
	SW5-4						
	SW5-5	E*ST**C-*M**D	ON	ON	ON	ON	OFF
	SW5-6	E*ST**D-*M**D	ON	OFF	OFF	ON	OFF
	SW5-7	E**T***-M**D*	OFF	OFF	OFF	OFF	OFF
	SW5-8	—	—	—	—	—	OFF
SW6	SW6-1	—	—	OFF			
	SW6-2	—	—	OFF			
	SW6-3 Pressure sensor	Inactive	Active	OFF: Except E*ST**D-*M**D ON : E*ST**D-*M**D			
	SW6-4 Analog output signal	Inactive	Active	OFF			
	SW6-5	—	—	—	OFF		

<Table 6.9.1>

- Notes:
- \*1. When the cylinder unit is connected with a PUMY-P and PXZ outdoor unit of which maximum outlet water temperature is 55°C, DIP SW1-2 must be changed to OFF.
  - \*2. External output (OUT11) will be available. For safety reasons, this function is not available for certain errors. (In that case, system operation must be stopped and only the water circulation pump keeps running.)
  - \*3. Active only when SW3-6 is set to OFF.
  - \*4. This switch functions only when the cylinder unit is connected with a PUHZ-FRP outdoor unit. When another type of outdoor unit is connected, the heating mode function is active regardless of the fact that this switch is ON or OFF.
  - \*5. Space heating and DHW can be operated only in indoor unit, like an electric heater. (Refer to "5.4 Indoor unit only operation" on the manual of RG79F364H01 (page 19).)
  - \*6. If emergency mode is no longer required, return the switch to OFF position.



Breaker abbreviation	Meaning
ECB1	Earth leakage circuit breaker for booster heater
ECB2	Earth leakage circuit breaker for immersion heater
TB1	Terminal block 1

### Option 1: Cylinder unit powered via outdoor unit

(If you want to use independent source, go to the Mitsubishi website.)

PXZ model is not available.

The model is Cylinder unit powered by independent source ONLY.

#### <1 phase>

Affix label A that is included with the manuals near each wiring diagram for cylinder unit and outdoor units.

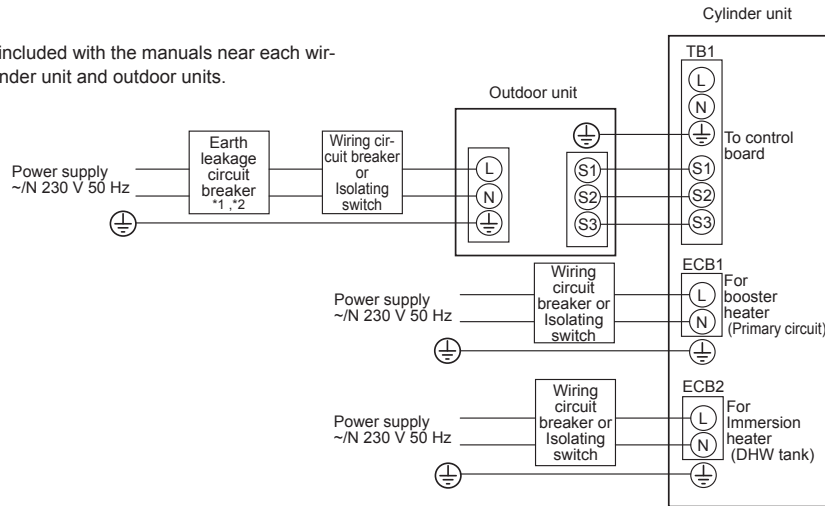

- \*1. If the installed earth leakage circuit breaker does not have an over-current protection function, install a breaker with that function along the same power line.
- \*2. A breaker with at least 3.0 mm contact separation in each pole shall be provided. Use earth leakage breaker (NV). The breaker shall be provided to ensure disconnection of all active phase conductors of the supply.

<Figure 7.1>  
Electrical connections 1 phase

Description	Power supply	Capacity	Breaker	Wiring
Booster heater (Primary circuit)	~N 230 V 50 Hz	2 kW	16 A *2	2.5 mm <sup>2</sup>
		6 kW	32 A *2	6.0 mm <sup>2</sup>
Immersion heater (DHW tank)	~N 230 V 50 Hz	3 kW	16 A *2	2.5 mm <sup>2</sup>

Wiring No. x size (mm <sup>2</sup> )	Cylinder unit - Outdoor unit	*3	3 × 1.5 (polar)
	Cylinder unit - Outdoor unit earth	*3	1 × Min. 1.5
Circuit rating	Cylinder unit - Outdoor unit S1 - S2	*4	230 VAC
	Cylinder unit - Outdoor unit S2 - S3	*4	24 VDC

\*3. Max. 45 m  
If 2.5 mm<sup>2</sup> used, Max. 50 m  
If 2.5 mm<sup>2</sup> used and S3 separated, Max. 80 m

\*4. The values given in the table above are not always measured against the ground value.

- Notes:**
1. Wiring size must comply with the applicable local and national codes.
  2. Indoor unit/outdoor unit connecting cords shall not be lighter than polychloroprene sheathed flexible cord. (Design 60245 IEC 57)  
Indoor unit power supply cords shall not be lighter than polychloroprene sheathed flexible cord. (Design 60227 IEC 53)
  3. Install an earth line longer than power cables.
  4. Please keep enough output capacity of power supply for each heater. Insufficient power supply capacity might cause chattering.

### <3 phase>

Affix label A that is included with the manuals near each wiring diagram for cylinder unit and outdoor units.

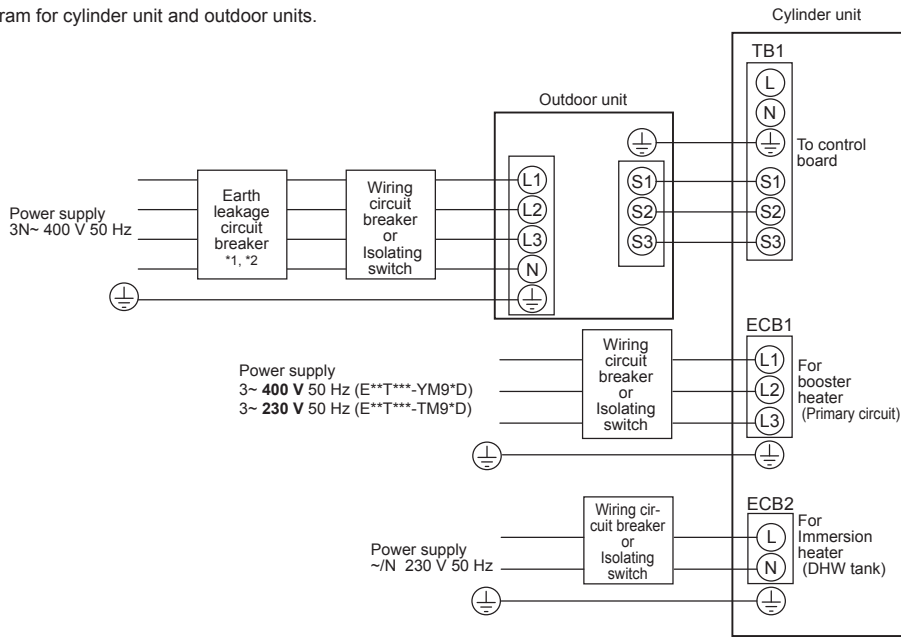

- \*1. If the installed earth leakage circuit breaker does not have an over-current protection function, install a breaker with that function along the same power line.
- \*2. A breaker with at least 3.0 mm contact separation in each pole shall be provided. Use earth leakage breaker (NV). The breaker shall be provided to ensure disconnection of all active phase conductors of the supply.

<Figure 7.2>  
Electrical connections 3 phase

Description	Power supply	Capacity (Indoor unit Ref.)	Breaker	Wiring
Booster heater (Primary circuit)	3~ 400 V 50 Hz	9 kW	16 A *2	2.5 mm <sup>2</sup>
	3~ 230 V 50 Hz	9 kW	32 A *2	6.0 mm <sup>2</sup>
Immersion heater (DHW tank)	~/N 230 V 50 Hz	3 kW	16 A *2	2.5 mm <sup>2</sup>

Wiring No. x size (mm <sup>2</sup> )	Cylinder unit - Outdoor unit *3	3 × 1.5 (polar)
	Cylinder unit - Outdoor unit earth *3	1 × Min. 1.5
Circuit rating	Cylinder unit - Outdoor unit S1 - S2 *4	230 VAC
	Cylinder unit - Outdoor unit S2 - S3 *4	24 VDC

- \*3. Max. 45 m  
If 2.5 mm<sup>2</sup> used, Max. 50 m  
If 2.5 mm<sup>2</sup> used and S3 separated, Max. 80 m
- \*4. The values given in the table above are not always measured against the ground value.

- Notes:**
1. Wiring size must comply with the applicable local and national codes.
  2. Indoor unit/outdoor unit connecting cords shall not be lighter than polychloroprene sheathed flexible cord. (Design 60245 IEC 57)  
Indoor unit power supply cords shall not be lighter than polychloroprene sheathed flexible cord. (Design 60227 IEC 53)
  3. Install an earth line longer than power cables.
  4. Please keep enough output capacity of power supply for each heater. Insufficient power supply capacity might cause chattering.

## Option 2: Cylinder unit powered by independent source.

If the cylinder unit and outdoor unit have separate power supplies, the following requirements MUST be carried out:

- Change the interconnected wiring in the control and electrical box of the cylinder unit (see Figure 7-3).
- Turn the outdoor unit DIP switch SW8-3 to ON.
- Turn on the outdoor unit BEFORE the cylinder unit.
- Power by independent source is not available for particular models of outdoor model name. For more detail, refer to the connecting outdoor unit Installation Manual.

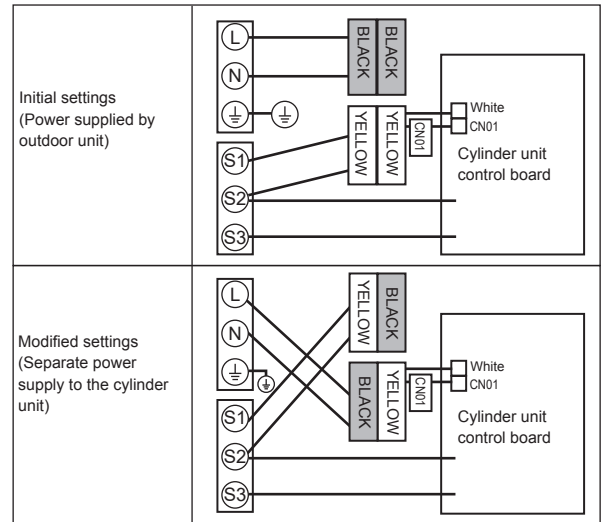

<Figure 7-3>

### <1 phase>

Affix label B that is included with the manuals near each wiring diagram for cylinder unit and outdoor units.

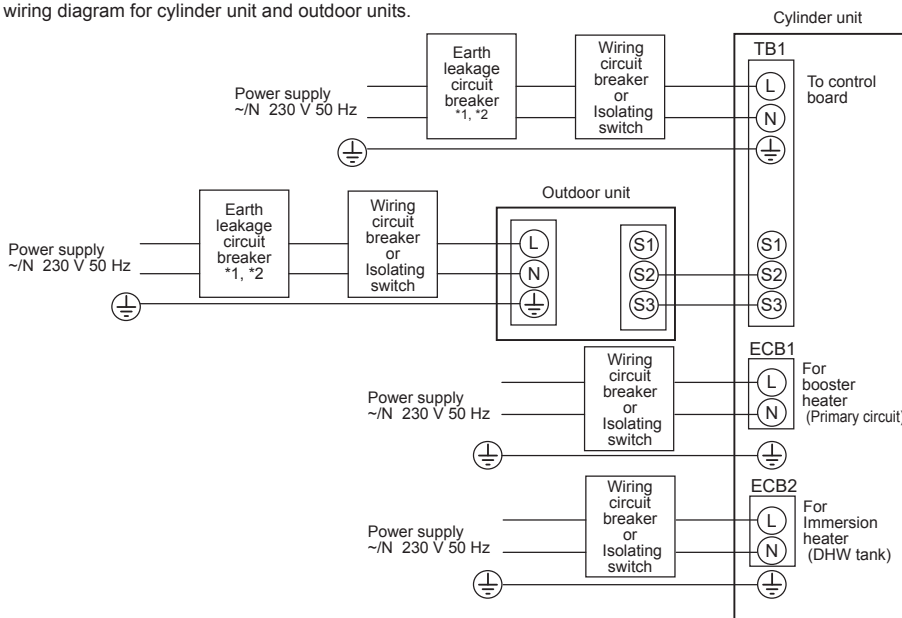

<Figure 7-4>  
Electrical connections 1 phase

- \*1. If the installed earth leakage circuit breaker does not have an over-current protection function, install a breaker with that function along the same power line.
- \*2. A breaker with at least 3.0 mm contact separation in each pole shall be provided. Use earth leakage breaker (NV). The breaker shall be provided to ensure disconnection of all active phase conductors of the supply.

Description	Power supply	Capacity	Breaker	Wiring
Booster heater (Primary circuit)	~N 230 V 50 Hz	2 kW	16 A *2	2.5 mm <sup>2</sup>
		6 kW	32 A *2	6.0 mm <sup>2</sup>
Immersion heater (DHW tank)	~N 230 V 50 Hz	3 kW	16 A *2	2.5 mm <sup>2</sup>

Cylinder unit power supply		~N 230 V 50 Hz
Cylinder unit input capacity		
Main switch (Breaker)		*2 16 A
Wiring No. x size (mm <sup>2</sup> )	Cylinder unit power supply	2 x Min. 1.5
	Cylinder unit power supply earth	1 x Min. 1.5
	Cylinder unit - Outdoor unit	*3 2 x Min. 0.3
	Cylinder unit - Outdoor unit earth	—
Circuit rating	Cylinder unit L - N	*4 230 VAC
	Cylinder unit - Outdoor unit S1 - S2	*4 —
	Cylinder unit - Outdoor unit S2 - S3	*4 24 VDC

\*3. Maximum 120 m

\*4. The values given in the table above are not always measured against the ground value.

- Notes:**
1. Wiring size must comply with the applicable local and national codes.
  2. Indoor unit/outdoor unit connecting cords shall not be lighter than polychloroprene sheathed flexible cord. (Design 60245 IEC 57)  
Indoor unit power supply cords shall not be lighter than polychloroprene sheathed flexible cord. (Design 60227 IEC 53)
  3. Install an earth line longer than power cables.
  4. Please keep enough output capacity of power supply for each heater. Insufficient power supply capacity might cause chattering.

### <3 phase>

Affix label B that is included with the manuals near each wiring diagram for cylinder unit and outdoor units.

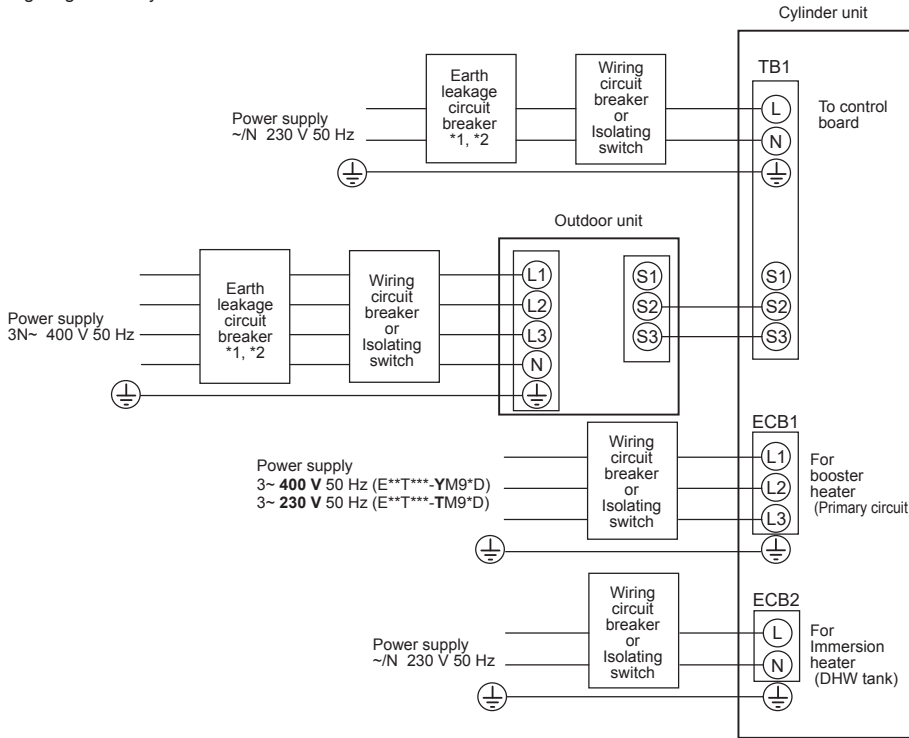

- \*1. If the installed earth leakage circuit breaker does not have an over-current protection function, install a breaker with that function along the same power line.
- \*2. A breaker with at least 3.0 mm contact separation in each pole shall be provided. Use earth leakage breaker (NV). The breaker shall be provided to ensure disconnection of all active phase conductors of the supply.

<Figure 7-5>  
Electrical connections 3 phase

Description	Power supply	Capacity (Indoor unit Ref.)	Breaker	Wiring
Booster heater (Primary circuit)	3~ 400 V 50 Hz	9 kW	16 A *2	2.5 mm <sup>2</sup>
	3~ 230 V 50 Hz	9 kW	32 A *2	6.0 mm <sup>2</sup>
Immersion heater (DHW tank)	~N 230 V 50 Hz	3 kW	16 A *2	2.5 mm <sup>2</sup>

Cylinder unit power supply		~N 230 V 50 Hz
Cylinder unit input capacity		*2
Main switch (Breaker)		16 A
Wiring No. x size (mm <sup>2</sup> )	Cylinder unit power supply	2 x Min. 1.5
	Cylinder unit power supply earth	1 x Min. 1.5
	Cylinder unit - Outdoor unit	*3
	Cylinder unit - Outdoor unit earth	—
Circuit rating	Cylinder unit L - N	*4
	Cylinder unit - Outdoor unit S1 - S2	*4
	Cylinder unit - Outdoor unit S2 - S3	*4
		24 VDC

\*3. Maximum 120 m

\*4. The values given in the table above are not always measured against the ground value.

- Notes:**
1. Wiring size must comply with the applicable local and national codes.
  2. Indoor unit/outdoor unit connecting cords shall not be lighter than polychloroprene sheathed flexible cord. (Design 60245 IEC 57)  
Indoor unit power supply cords shall not be lighter than polychloroprene sheathed flexible cord. (Design 60227 IEC 53)
  3. Install an earth line longer than power cables.
  4. Please keep enough output capacity of power supply for each heater. Insufficient power supply capacity might cause chattering.

<E\*PT17X-\*M\*D> (Packaged model system)

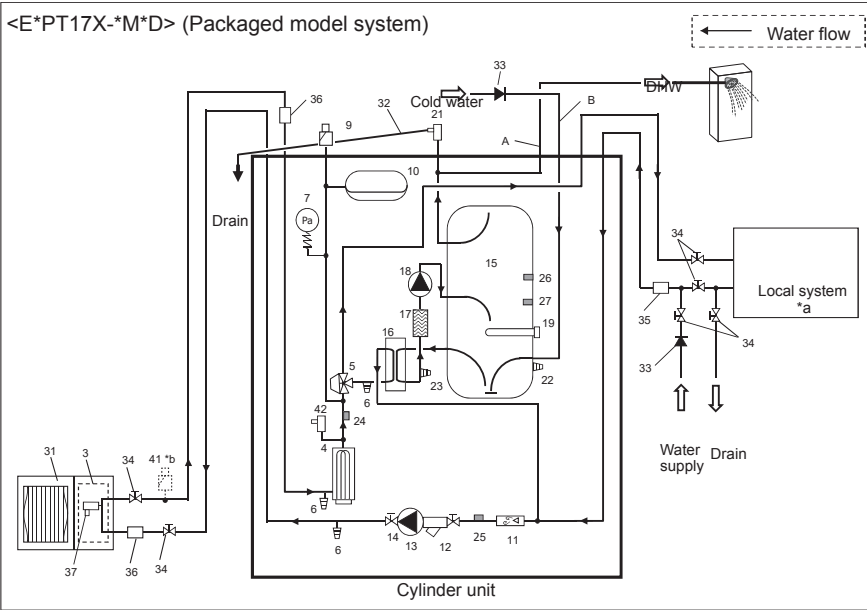

<Figure 8.1>

- \*a. Refer to the following section [Local system].
- \*b. If the outdoor unit is higher than the indoor unit, or if there is a location where air gets trapped in the upper part of the water pipe, consider adding this part.

Notes

- To enable draining of the cylinder unit, an isolating valve should be positioned on both the inlet and outlet pipework.
- Be sure to install a strainer on the inlet pipework to the cylinder unit.
- Suitable drain pipework should be attached to all relief valves in accordance with your country's regulations.
- A backflow prevention device must be installed on the cold water supply pipework (IEC 61770)
- When using components made from different metals or connecting pipes made of different metals, insulate the joints to prevent any corrosive reaction taking place which may damage the pipework.)

<E\*ST17/20D-\*M\*\*D> (Split model system)

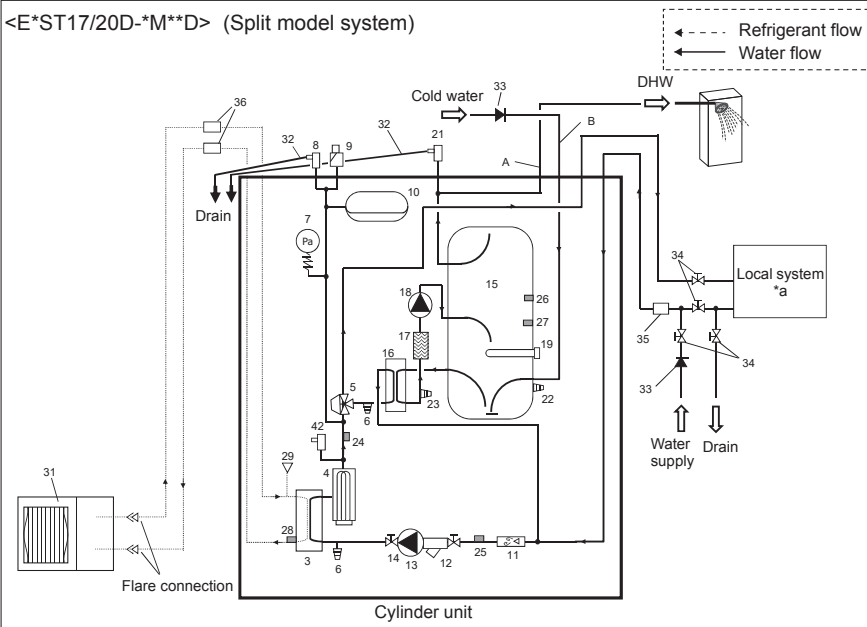

<Figure 8.2>

- \*a. Refer to the following section [Local system].

Notes

- To enable draining of the cylinder unit, an isolating valve should be positioned on both the inlet and outlet pipework.
- Be sure to install a strainer on the inlet pipework to the cylinder unit.
- Suitable drain pipework should be attached to all relief valves in accordance with your country's regulations.
- A backflow prevention device must be installed on the cold water supply pipework (IEC 61770)
- When using components made from different metals or connecting pipes made of different metals, insulate the joints to prevent any corrosive reaction taking place which may damage the pipework.)

<EHPT20X-MHEDW> (UK model system) <Example>

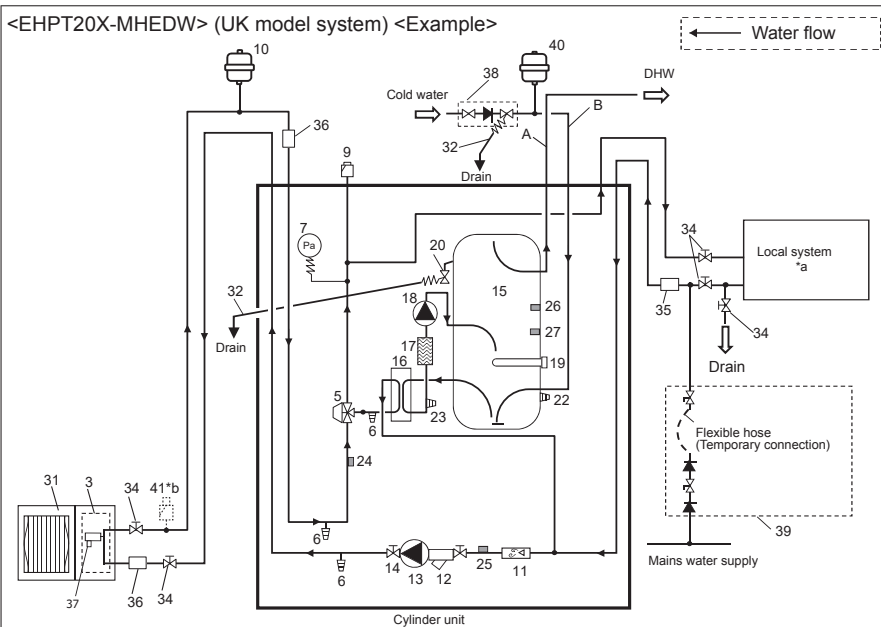

<Figure 8.3>

- \*a. Refer to the following section 'Local system' on the 'Paper-based manual'.

Note

- To enable draining of the cylinder unit, an isolating valve should be positioned on both the inlet and outlet pipework. No valve should be fitted between the expansion valve (item 38) and the cylinder unit (safety matter).
- For space heating (primary) circuit a suitable expansion vessel **MUST** be supplied and fitted by installer.
- Be sure to install a strainer on the inlet pipework to the cylinder unit.
- Suitable drain pipework should be attached to all relief valves in accordance with your country's regulations.
- When using components made from different metals or connecting pipes made of different metals, insulate the joints to prevent any corrosive reaction taking place which may damage any pipework.
- Filling loop's flexible hose must be removed following the filling procedure. Item provided with unit as loose accessory.
- Install the inlet control group (item 38) above the level of the T&P relief valve (item 20). This will ensure DHW tank will not require drain down to service/maintain the inlet control group.

<E\*PT20/30X-\*M\*\*D> (Packaged model system)

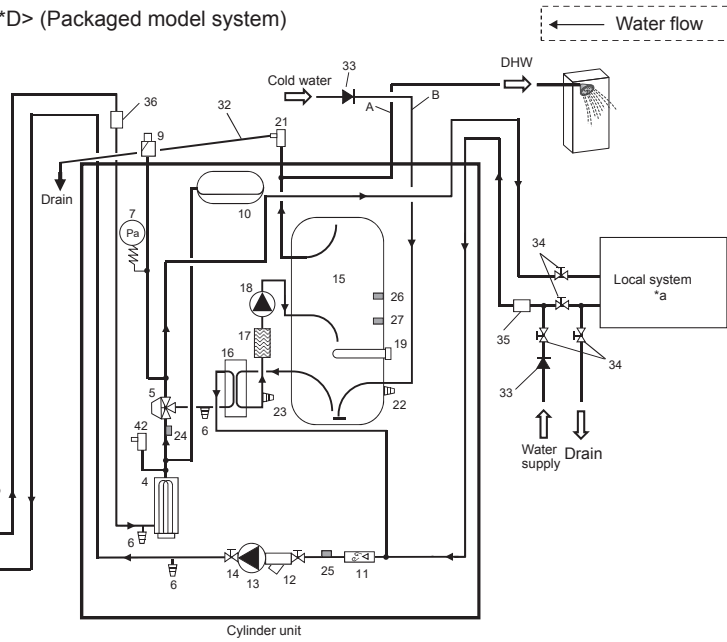

<Figure 8.4>

Go to the Mitsubishi website to check the component parts of each unit.

- \*a. Refer to the following section [Local system].
- \*b. If the outdoor unit is higher than the indoor unit, or if there is a location where air gets trapped in the upper part of the water pipe, consider adding this part.

Notes

- To enable draining of the cylinder unit, an isolating valve should be positioned on both the inlet and outlet pipework.
- Be sure to install a strainer on the inlet pipework to the cylinder unit.
- Suitable drain pipework should be attached to all relief valves in accordance with your country's regulations.
- A backflow prevention device must be installed on the cold water supply pipework (IEC 61770)
- When using components made from different metals or connecting pipes made of different metals, insulate the joints to prevent any corrosive reaction taking place which may damage the pipework.

<E\*ST20C/30C/30D-\*M\*\*D> (Split model system)

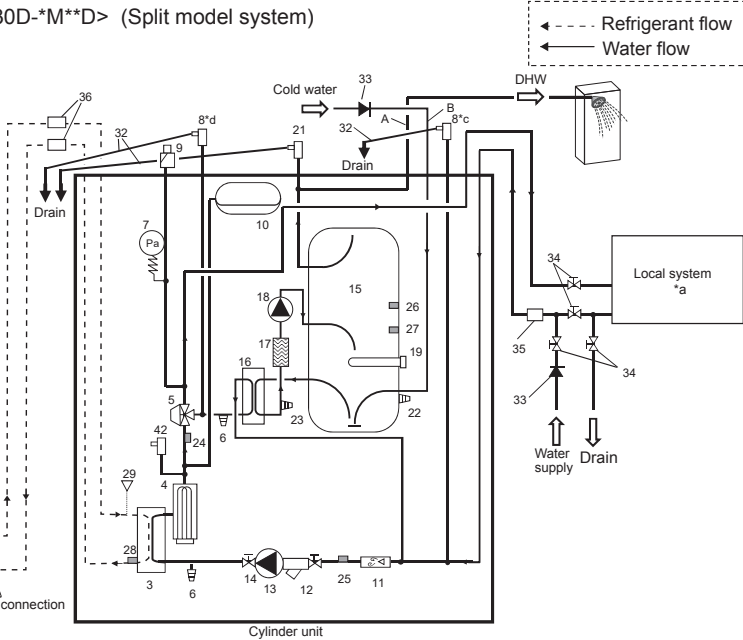

<Figure 8.5>

Go to the Mitsubishi website to check the component parts of each unit.

- \*a. Refer to the following section [Local system].
- \*c, d. Refer to the component parts table of the Mitsubishi website.

Notes

- To enable draining of the cylinder unit, an isolating valve should be positioned on both the inlet and outlet pipework.
- Be sure to install a strainer on the inlet pipework to the cylinder unit.
- Suitable drain pipework should be attached to all relief valves in accordance with your country's regulations.
- A backflow prevention device must be installed on the cold water supply pipework (IEC 61770)
- When using components made from different metals or connecting pipes made of different metals, insulate the joints to prevent any corrosive reaction taking place which may damage the pipework.

<ERST17D-\*\*\*BD> (Split model 2-zone system)

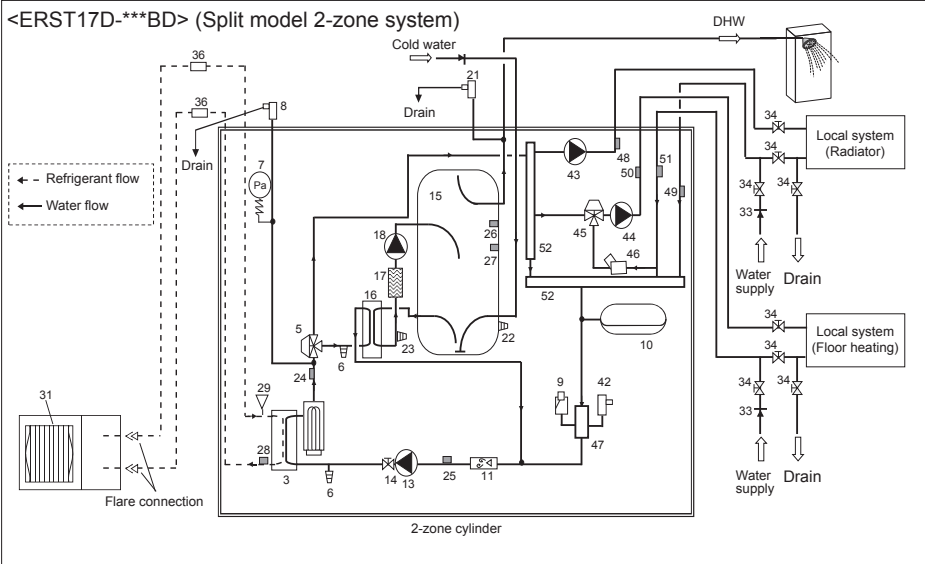

<Figure 8.6>

## Local system

### 1-zone temperature control

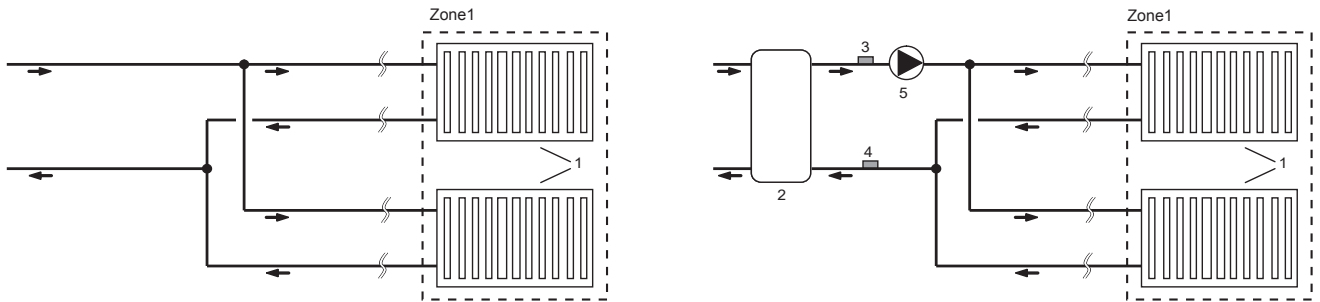

### 2-zone temperature control

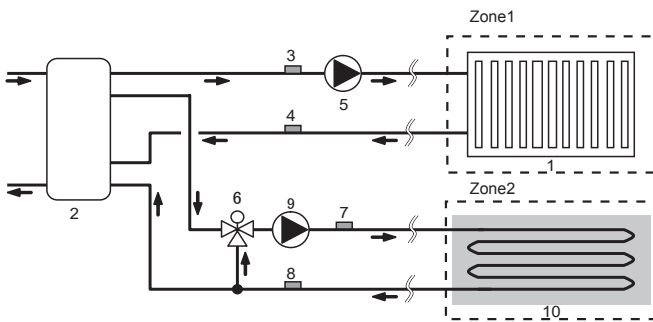

### 1-zone temperature control with boiler

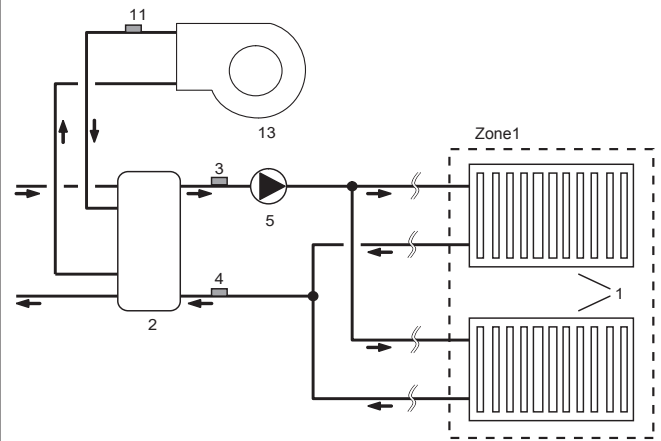

### 2-zone temperature control & Buffer tank control

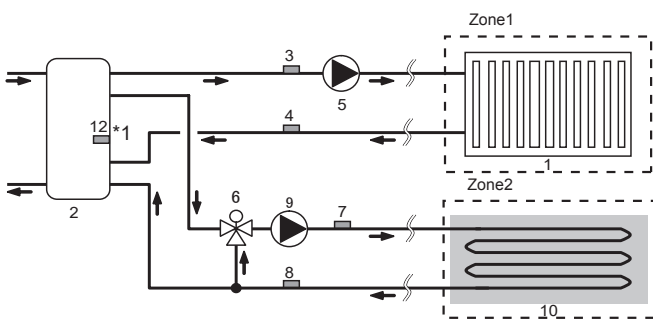

### 1-zone temperature control (2-zone valve ON/OFF control)

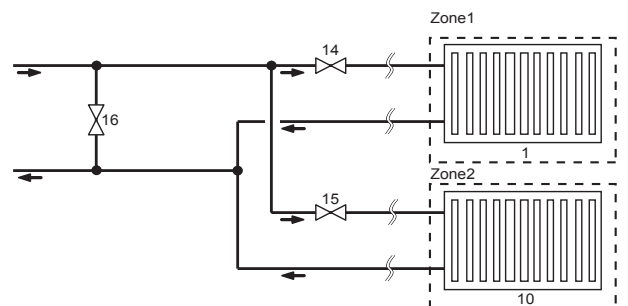

1. Zone1 heat emitters (e.g. radiator, fan coil unit) (local supply)
2. Mixing tank (local supply)
3. Zone1 flow water temp. thermistor (THW6)
4. Zone1 return water temp. thermistor (THW7) } Optional part : PAC-TH011-E
5. Zone1 water circulation pump (local supply)
6. Motorized mixing valve (local supply)
7. Zone2 flow water temp. thermistor (THW8)
8. Zone2 return water temp. thermistor (THW9) } Optional part : PAC-TH011-E
9. Zone2 water circulation pump (local supply)

10. Zone2 heat emitters (e.g. underfloor heating) (local supply)
11. Boiler flow water temp. thermistor (THWB1) } Optional part : PAC-TH012HT(L)-E
12. Mixing tank thermistor (THW10) \*1
13. Boiler (local supply)
14. Zone1 2-way valve (local supply)
15. Zone2 2-way valve (local supply)
16. Bypass valve (local supply)

\*1 ONLY Buffer tank control (heating/cooling) applies to "Smart grid ready".

## Filling the cylinder unit (Primary circuit)

1. Check and charge expansion vessel.
2. Check all connections including factory fitted ones are tight.
3. Insulate pipework between cylinder unit and outdoor unit.
4. Thoroughly clean and flush system of all debris. (Refer to 4.2 in the installation manual.)
5. Fill cylinder unit with potable water. Fill primary heating circuit with water and suitable anti-freeze and inhibitor as necessary. **Always use a filling loop with double check valve when filling the primary circuit to avoid back flow contamination of water supply.**

- Anti-freeze should always be used for packaged model systems. It is the responsibility of the installer to decide if anti-freeze solution should be used in split model systems depending on each site's conditions. Corrosion inhibitor should be used in both split model and packaged model systems. Figure below shows freezing temperature against anti-freeze concentration. This figure is an example for FERNOX ALPHI-11. For other anti-freeze, please refer to relevant manual.
- When connecting metal pipes of different materials, insulate the joints to prevent a corrosive reaction taking place which will damage the pipework.
- If there are thermostatic or motorized valves on the installation, at least one of the valves on each zone must be fully open (preferably on the largest emitter).

6. Check for leakages. If leakage is found, retighten the nut onto the connections.
7. Pressurise system to 1 bar.
8. Release all trapped air using air vents during and following heating period.
9. Top up with water as necessary. (If pressure is below 1 bar)

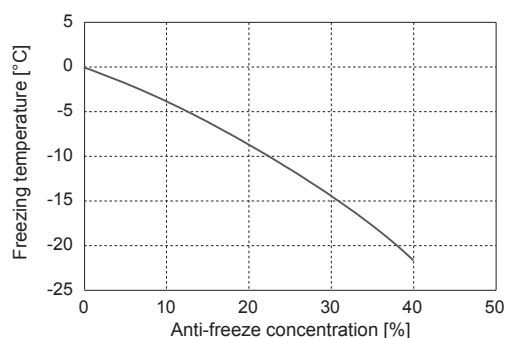

## Filling the cylinder unit (Potable/DHW circuit)

Initial fill procedure:

1. Ensure all pipe joints and fittings are tight and secure.
2. Open the most distant DHW tap/outlet.
3. Slowly/gradually open the mains water supply to begin filling unit and DHW pipework.
4. Allow most distant tap to run free and release/purge residual air from installation.
5. Close tap/outlet to retain fully charged system.

Initial flush procedure:

1. Energise system to heat-up cylinder contents to a temperature of approx. 30 to 40°C.
2. Flush/drain the water contents to remove any residue/impurities resulting from the installation works. Use the cylinder drain cock to safely discharge the warmed water to drain via a suitable hose.
3. On completion, close drain cock, re-fill system and resume system commissioning.

## Draining the cylinder unit

### WARNING: DRAINED WATER MAY BE VERY HOT

1. Before attempting to drain the cylinder unit, isolate from the electrical supply to prevent the immersion and booster heaters burning out.
2. Isolate cold water feed to DHW tank.
3. Attach a hose to the DHW tank drain cock (No. 23 and 24 on Figure 4-1 and 4-2). The hose should be able to withstand heat as the draining water could be very hot. The hose should drain to a place lower than the DHW tank bottom to encourage siphoning. Open a hot water tap to start draining without a vacuum.
4. When the DHW tank is drained, close drain cock and hot tap.
5. Attach hose to water circuit drain cock (No. 7 on Figure 4-1 and 4-2). The hose should be able to withstand heat as the draining water could be very hot. The hose should drain to a place lower than the booster heater drain cock to encourage siphoning. Open the pump valve and the strainer valve.
6. Water remains in the strainer still after the cylinder unit was drained. Drain the strainer by removing the strainer cover.



9-1. Main remote controller

To change the settings of your heating/cooling system please use the main remote controller located on the front panel of the cylinder unit or hydrobox. The following is a guide to viewing the main settings. Should you require more information please contact your installer or local Mitsubishi Electric dealer. Cooling mode is available for ERS series only. However, Cooling mode is not available when the indoor unit is connected to PUAZ-FRP.

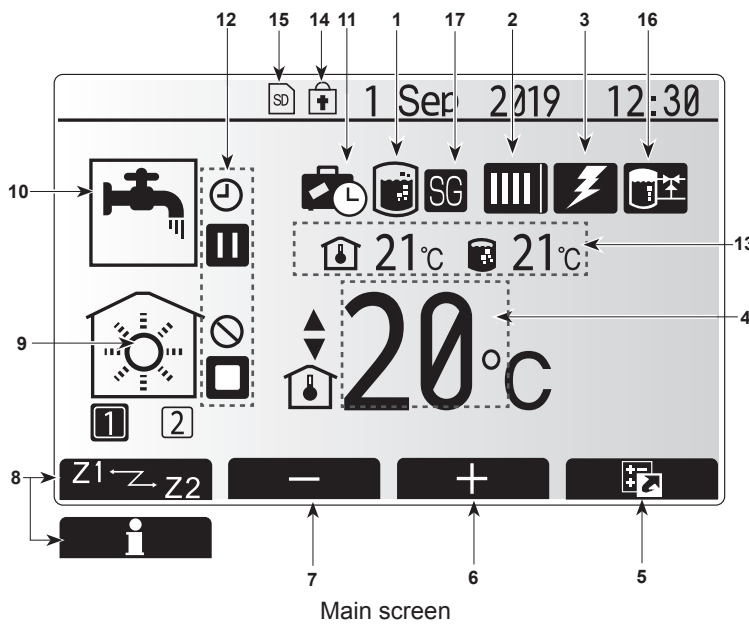
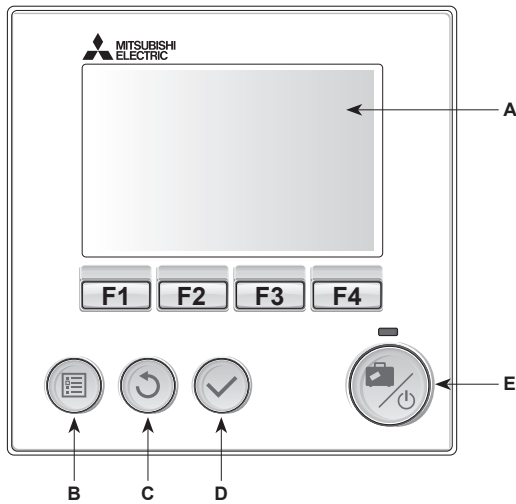

<Main remote controller parts>

Letter	Name	Function
A	Screen	Screen in which all information is displayed
B	Menu	Access to system settings for initial set up and modifications.
C	Back	Return to previous menu.
D	Confirm	Used to select or save. (Enter key)
E	Power/Holiday	If system is switched off pressing once will turn system ON. Pressing again when system is switched on will enable Holiday Mode. Holding the button down for 3 seconds will turn the system off. (*1)
F1-4	Function keys	Used to scroll through menu and adjust settings. Function is determined by the menu screen visible on screen A.

\*1

When the system is switched off or the power supply is disconnected, the cylinder unit protection functions (e.g. freeze stat. function) will NOT operate. Please beware that without these safety functions enabled the cylinder unit may potentially become exposed to damage.

<Main screen icons>

Icon	Description
1 Legionella prevention	When this icon is displayed, 'Legionella prevention mode' is active.
2 Heat pump	'Heat pump' is running. Defrosting Emergency heating 'Quiet mode' is activated.
3 Electric heater	When this icon is displayed, the 'Electric heaters' (booster or immersion heater) are in use.
4 Target temperature	Target flow temperature Target room temperature Compensation curve
5 OPTION	Pressing the function button below, this icon will display the option screen.
6 +	Increase set temperature.
7 -	Decrease set temperature.
8 Z1 Z2	Pressing the function button below, this icon switches between Zone1 and Zone2. Information Pressing the function button below, this icon displays the information screen.
9 Space heating/cooling mode	Heating mode Zone1 or Zone2 Cooling mode Zone1 or Zone2
10 DHW mode	Normal or ECO mode
11 Holiday mode	When this icon is displayed, 'Holiday mode' activated.
12	Timer Prohibited Server control Stand-by Stand-by (*2) Stop Operating
13 Current temperature	Current room temperature Current water temperature of DHW tank
14	The Menu button is locked or the switching of the operation modes between DHW and Heating operations are disabled in the Option screen. (*3)
15	SD memory card is inserted. Normal operation. SD memory card is inserted. Abnormal operation.
16 Buffer tank control	When this icon is displayed, 'Buffer tank control' is active.
17 Smart grid ready	When this icon is displayed, 'Smart grid ready' is active.

\*2 This unit is in Stand-by whilst other indoor unit(s) is in operation by priority.

\*3 To lock or unlock the Menu, press the BACK and CONFIRM keys simultaneously for 3 seconds.

## 9-2. Setting the Main remote controller

After the power has been connected to the outdoor and cylinder units (See "7. FIELD WIRING"), the initial system settings can be entered via the main remote controller.

1. Check all breakers and other safety devices are correctly installed and turn on power to the system.
2. When the main remote controller is switched on for the first time, the screen automatically goes to Initial settings menu, Language setting screen and Date/Time setting screen in order.
3. Main remote controller will automatically start up. Wait approximately 6 minutes whilst the control menus load.
4. When the controller is ready, a blank screen with a line running across the top will be displayed.
5. Press button E (Power) to turn on the system. Before turning on the system, perform initial settings as instructed below.

## 9-3. Initial setting wizard

When the main remote controller is switched on for the first time, the screen automatically goes to Language setting screen , Date/Time setting screen and Main settings menu screen in order. Enter the desired number using the function keys and press CONFIRM.

### Note:

<HEATER CAPACITY RESTRICTION>

This setting restricts the booster heater capacity. It is NOT possible to change the setting after starting up. If you do not have any special requirements (such as building regulations) in your country, skip this setting (select "No").

- Hot water (DHW/Legionella)
- Heating/Cooling
- Operation (ON/Prohibited/Timer)
- Pump speed
- Heat pump flow rate range
- Mixing valve control
- HEATER CAPACITY RESTRICTION

\*1 The screen goes to the next setting screen. Changes have not been saved.

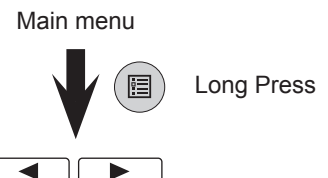
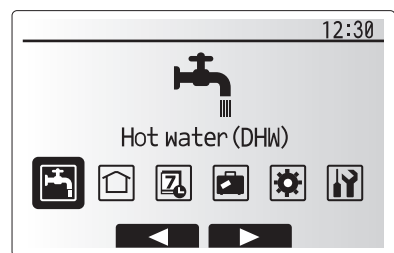
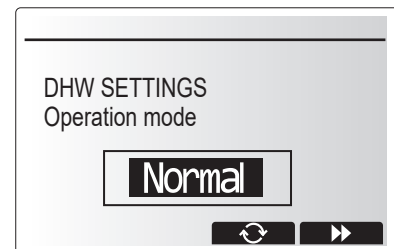
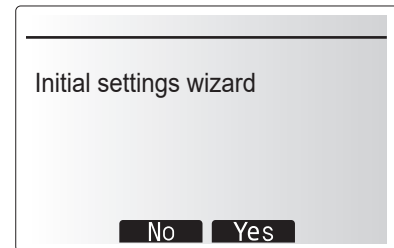

## 9-4. Main Settings Menu

The main settings menu can be accessed by pressing the MENU button. To reduce the risk of untrained end users altering the settings accidentally, there are 2 access levels to the main settings; and the service section menu is password protected.

### User Level – Short press

If the MENU button is pressed once for a short time, the main settings will be displayed but without the edit function. This will enable the user to view current settings but **NOT** change the parameters.

### Installer Level – Long press

If the MENU button is pressed down for 3 seconds the main settings will be displayed with all functionality available.

The colour of ▼▼ buttons is inverted as per right figure.

The following items can be viewed and/or edited (dependent on access level).

- Domestic Hot water (DHW)
- Heating/Cooling
- Schedule timer
- Holiday mode
- Initial settings
- Service (Password protected)

## General Operation

- To find the icon that you wish to set, use the F2 and F3 buttons to move between the icons.
- The highlighted icon will appear as a larger version of the centre of the screen.
- Press CONFIRM to select and edit the highlighted mode.
- Follow the <Main remote controller Menu Tree> for further setting, using ◀▶ buttons for scrolling or F1 to F4 for selecting.

<Main Remote Controller Menu Tree>

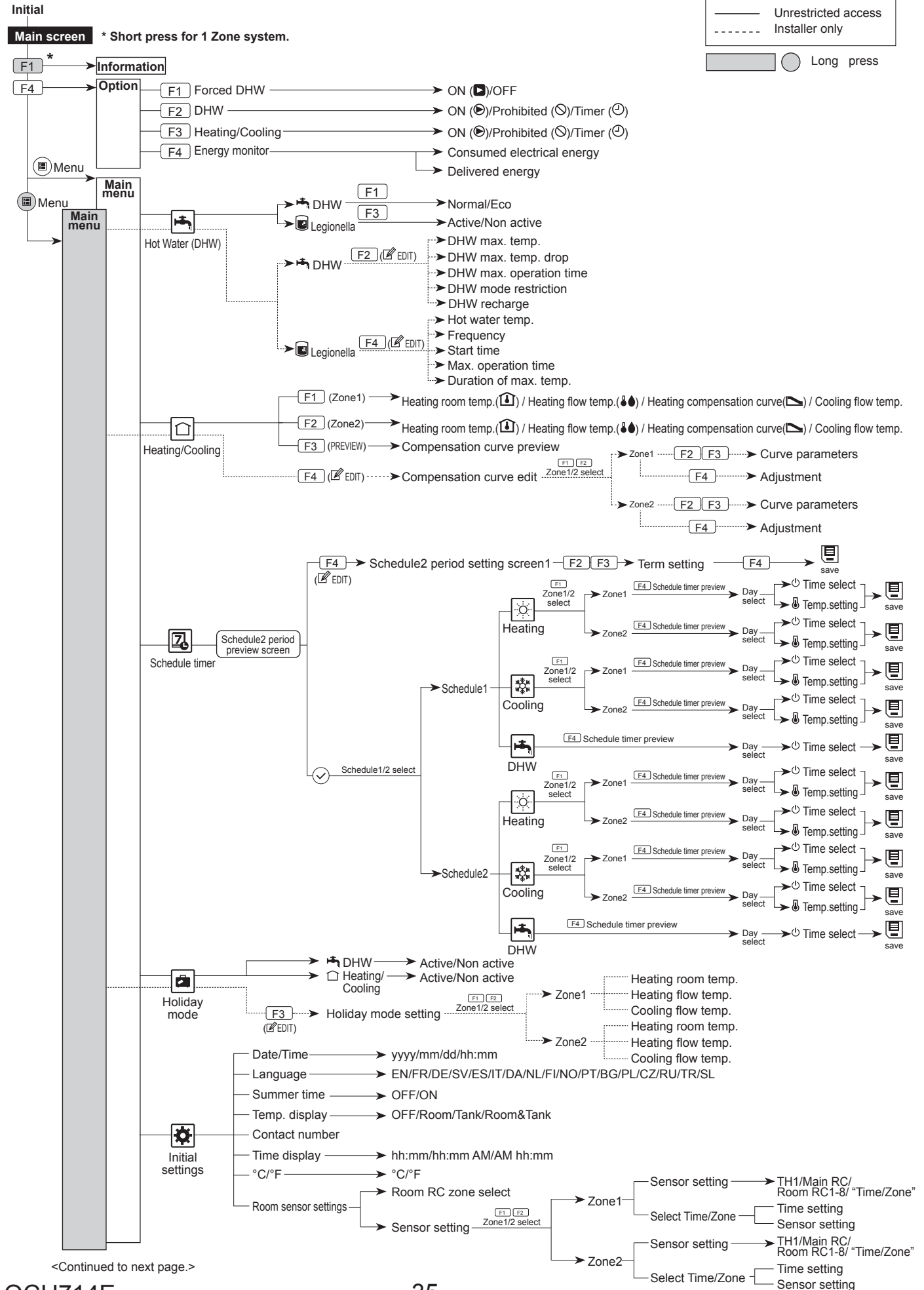

<Continued to next page.>

<Continued from the previous page.>

<Main Controller Menu Tree>

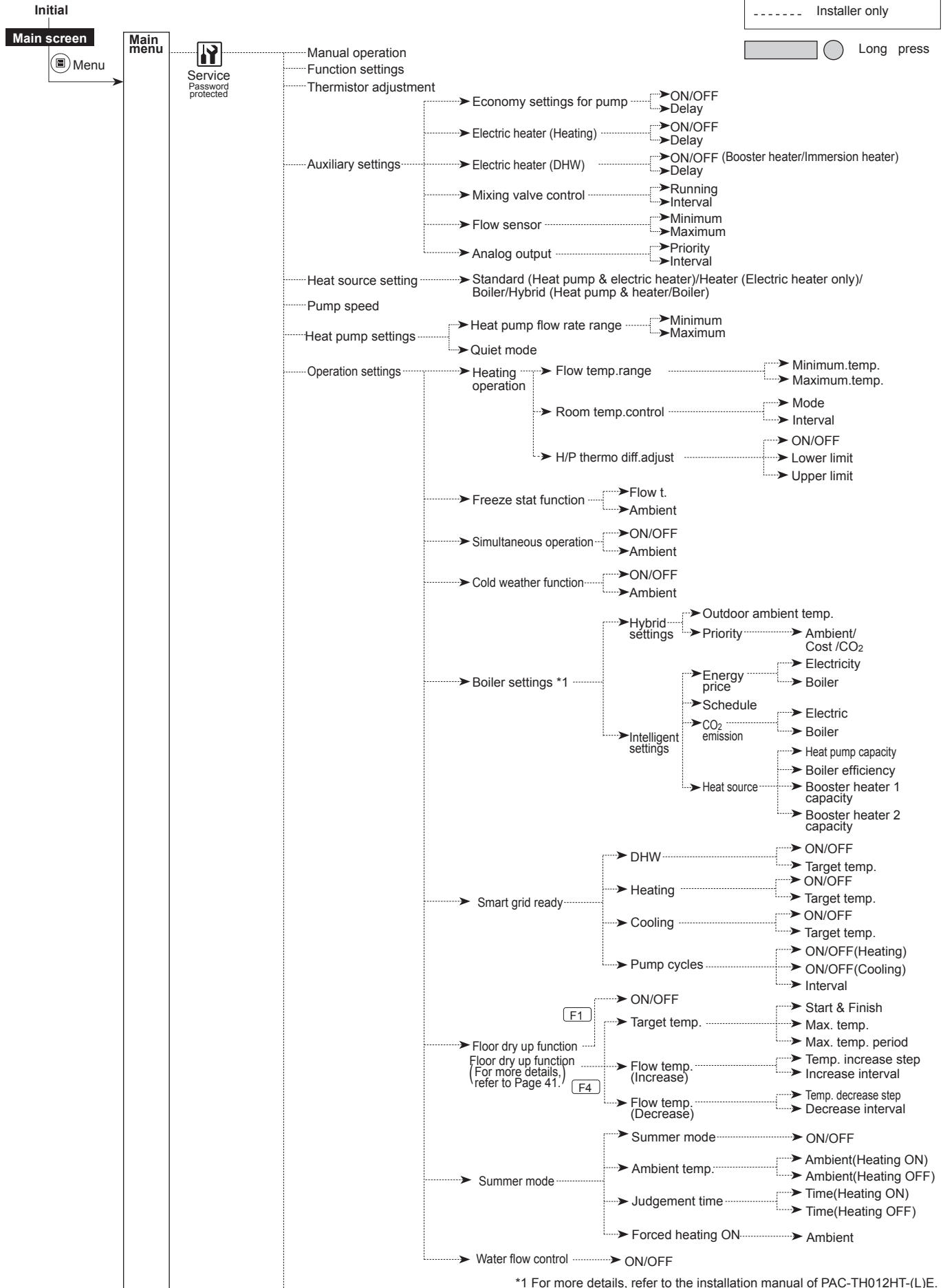
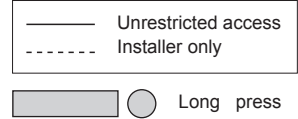

\*1 For more details, refer to the installation manual of PAC-TH012HT-(L)E.

<Continued to next page.>

<Continued from the previous page.>

<Main Controller Menu Tree>

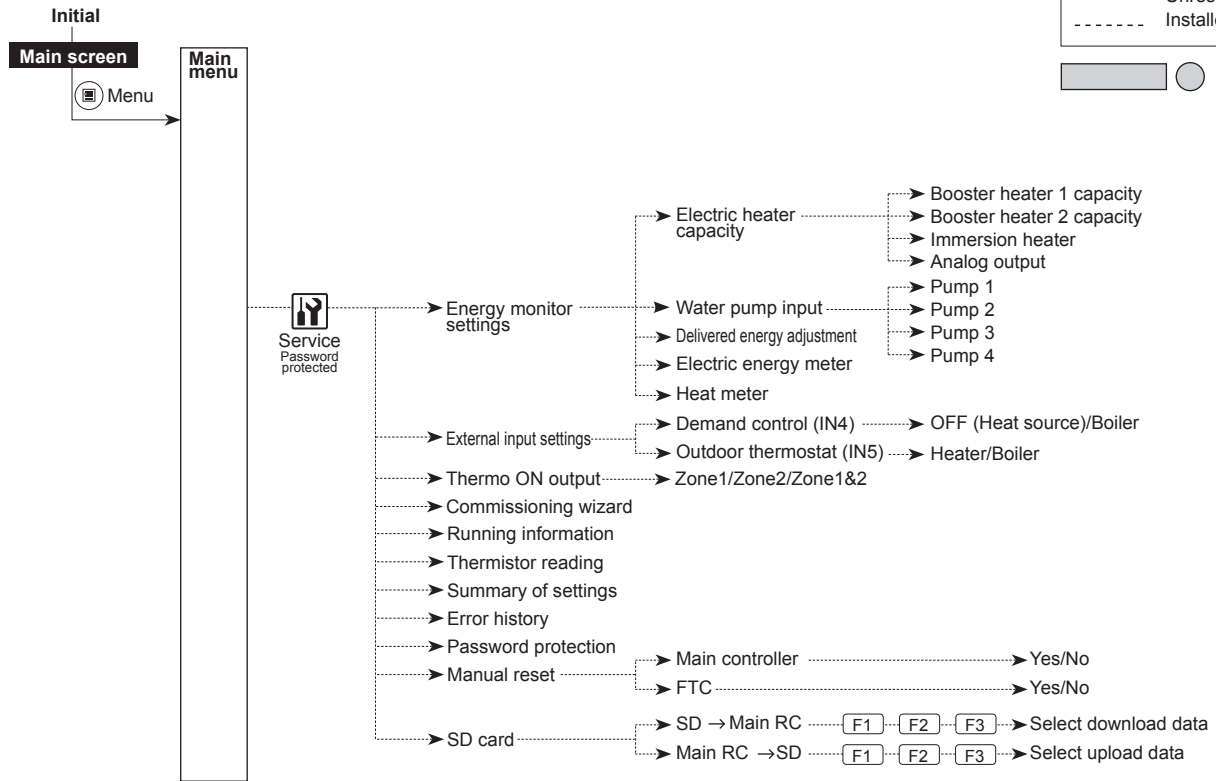
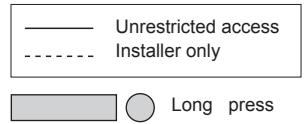

## 9-5. Service Menu

The service menu provides functions for use by installer or service engineer. It is NOT intended the home owner alters settings within this menu. It is for this reason password protection is required to prevent unauthorised access to the service settings.

The factory default password is "0000".

Follow the procedure described in General Operation for the set up operation.

The service menu is navigated using the F1 and F2 buttons to scroll through the functions. The menu is comprised of the following functions;

1. Manual operation
2. Function settings
3. Thermistor adjustment
4. Auxiliary settings
5. Heat source setting
6. Pump speed
7. Heat pump settings
8. Operation settings
9. Energy monitor settings
10. External input settings
11. Thermo ON output
12. Commissioning wizard
13. Running information
14. Thermistor reading
15. Summary of settings
16. Error history
17. Password protection
18. Manual reset
19. SD card

Many functions cannot be set whilst the indoor unit is running. The installer should turn off the unit before trying to set these functions. If the installer attempts to change the settings whilst the unit is running the main remote controller will display a reminder message prompting the installer to stop operation before continuing. By selecting "Yes" the unit will cease operation.

### <Manual operation>

During the filling of the system the water circulation pump and 3-way valve can be manually overridden using manual operation mode.

When manual operation is selected a small timer icon appears in the screen.

The function selected will only remain in manual operation for a maximum of 2 hours. This is to prevent accidental permanent override of the FTC.

#### ▶ Example

Pressing F3 button will switch manual operation mode ON for the main 3-way valve. When filling of the DHW tank is complete the installer should access this menu again and press F3 to deactivate manual operation of the part.

Alternatively after 2 hours manual operation mode will no longer be active and FTC will resume control of the part.

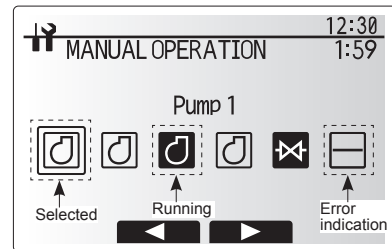

Manual operation menu screen

Manual operation and heat source setting cannot be selected if the system is running. A screen will be displayed asking the installer to stop the system before these modes can be activated. The system automatically stops 2 hours after the last operation.

### <Function settings>

Function Setting allows the setting of auto recovery after power failure.

1. From the service menu use F1 and F2 to highlight Function Setting.
2. Press CONFIRM.
3. Ensure the Ref address and unit number are displayed to the right.
4. Press CONFIRM.
5. Use F3 and F4 to highlight either 1/2/3 (see below).
6. Press CONFIRM.

Setting	Unit	Mode	Number
Auto recovery after power failure	Grp	Mode1	1 - Inactive 2 - Active *1 3 - NO FUNCTION

\*1 Approx. 4-minute delay after power is restored.

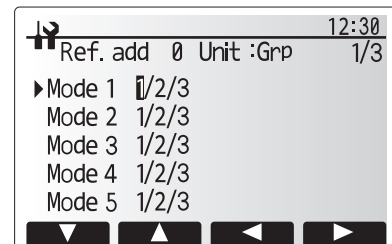
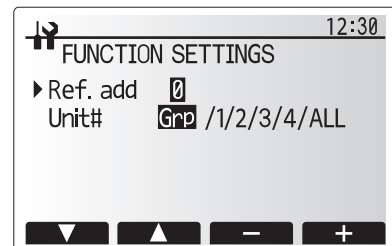

### <Thermistor adjustment>

This function allows adjustments to be made to the thermistor readings from -10 to 10°C in 0.5°C intervals.

- THW1: Thermistor (Flow water temp.)
- THW2: Thermistor (Return water temp.)
- THW5: Thermistor (DHW tank water temp.)
- THW6: Thermistor (Zone1 flow temp.)(Option)
- THW7: Thermistor (Zone1 return temp.)(Option)
- THW8: Thermistor (Zone2 flow temp.)(Option)
- THW9: Thermistor (Zone2 return temp.)(Option)
- THW10: Thermistor (Mixing tank temp.)(Option)
- THWB1: Thermistor (Boiler flow temp.)(Option)

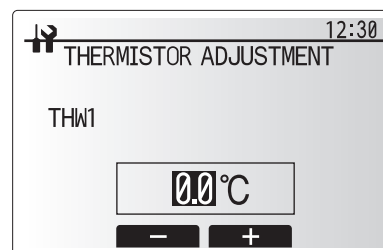

### <Auxiliary settings>

This function is used to set the parameters for any auxiliary parts used in the system

Menu subtitle	Function/ Description
Economy settings for pump	Water pump stops automatically in certain period of time from when operation is finished.
Delay	Time before pump switched off *1
Electric heater (Heating)	To select "WITH booster heater (ON)" or "WITHOUT booster heater (OFF)" in Heating mode.
Delay	The minimum time required for the booster heater to turn ON from after Heating mode has started.
Electric heater (DHW)	To select "WITH (ON)" or "WITHOUT (OFF)" booster heater or immersion heater individually in DHW mode.
Delay	The minimum time required for the booster heater or immersion heater to turn ON from after DHW mode has started. (This setting is applied for both booster and immersion heater.)
Mixing valve control *2	Period from valve fully open (at a hot water mixing ratio of 100%) to valve fully closed (at a cold water mixing ratio of 100%)
Running	Interval (min.) to control the Mixing valve.
Interval	
Flow sensor *3	The minimum flow rate to be detected at Flow sensor.
Minimum	
Maximum	The maximum flow rate to be detected at Flow sensor.

\*1 Decreasing "time before pump switched off" may increase the duration of stand-by in Heating/Cooling mode.

\*2 Set the Running time according to the specifications of the actuator of each mixing valve. It is recommended to set the interval to 2 minutes that is a default value. With the interval set longer, it could take longer to warm up a room.

\*3 Do not change the setting since it is set according to the specification of Flow sensor attached to the cylinder unit.

#### Economy settings for pump

- From the Auxiliary settings menu highlight Economy Settings for water circulation pump.
- Press CONFIRM.
- The economy settings for water circulation pump screen is displayed.
- Use button F1 to switch the economy settings ON/OFF.
- Use buttons F3 and F4 to adjust the time the water circulation pump will run. (3 to 60 minutes)

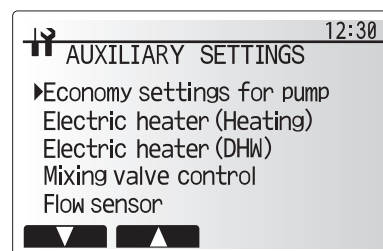

Auxiliary settings menu screen

#### Electric heater (Heating)

- From the Auxiliary settings menu highlight Electric heater (Heating).
- Press CONFIRM.
- The Electric heater (Heating) screen is displayed.
- Press F1 button to switch the function ON/OFF.
- Use F3 and F4 buttons to adjust the time period of heat pump only operation before the booster heater will assist in space heating. (5 to 180 minutes)

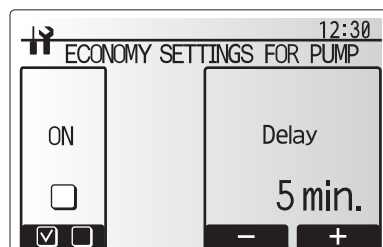

Economy settings for pump screen

#### Electric heater (DHW)

- From the Auxiliary settings menu highlight Electric heater (DHW).
- Press CONFIRM.
- The Electric heater (DHW) screen is displayed.
- Press F1 and F2 buttons to switch the function ON/OFF. (F1: booster heater, F2: immersion heater)
- Use F3 and F4 buttons to adjust the time period of heat pump only operation before the booster heater and the immersion heater (if present) will assist in DHW heating. (15 to 30 minutes)

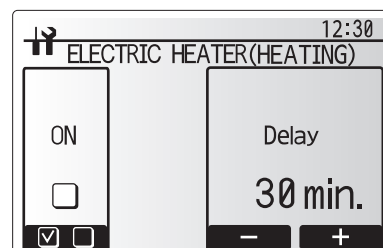

Electric heater (Heating) screen

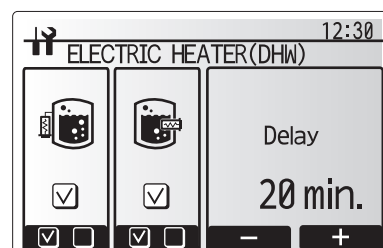

Electric heater (DHW) screen

### Mixing valve control

1. From the Auxiliary settings menu highlight Mixing valve control.
2. Press CONFIRM.
3. The Mixing valve control screen is displayed.
4. Use F1 and F2 buttons to set Running time between 10 to 240 seconds. The Running time equals to a period from full open of the valve (at a hot water mixing ratio of 100%) to full close (at a cold water mixing ratio of 100%).

**Note: Set the Running time according to the specifications of the actuator of each mixing valve.**

1. From the Auxiliary settings menu highlight Mixing valve control.
2. Press CONFIRM.
3. The Mixing valve control screen is displayed.
4. Press F3 and F4 buttons to set the interval between 2-zone temperature controls of the mixing valve between 1 to 30 minutes.

**Note: It is recommended to set the interval to 2 minutes that is a default value. With the interval set longer, it could take longer to warm up a room.**

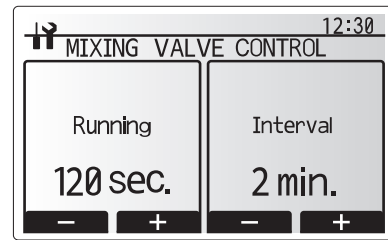

Mixing valve control setting screen

### Flow sensor

1. From the Auxiliary settings menu highlight Flow sensor.
2. Press CONFIRM.
3. Press F3 or F4 buttons to select a refrigerant address of which you wish to configure or check the settings, and press CONFIRM. \*1
4. The Flow sensor screen is displayed.
5. Use F1 and F2 buttons to set the minimum flow rate of flow sensor between 0 to maximum L/min.
6. Use F3 and F4 buttons to set the maximum flow rate of flow sensor between minimum to 100L/min.

\*1 For multiple outdoor units control system only.

**Note: Do not change the setting since it is set according to the specification of Flow sensor attached to the cylinder unit.**

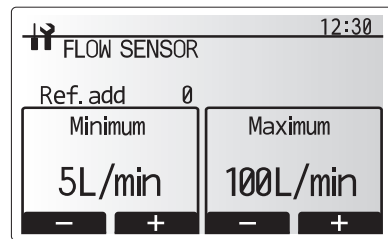

Flow sensor setting screen

### <Heat source setting>

The default heat source setting is heat pump and all electric heaters present in the system to be operational. This is referred to as Standard operation on the menu.



Heat source setting screen

### <Pump speed>

1. From the Service menu, highlight Pump speed.
  2. Press CONFIRM.
  3. Press F3 and F4 buttons to select a refrigerant address of which you wish to configure or check the settings, and press CONFIRM. \*1
  4. The Pump speed screen is displayed.
  5. Use F1 and F2 buttons to set the pump speed (1 to 5) of DHW operation.
  6. Use F3 and F4 buttons to set the pump speed (1 to 5) of space heating(cooling) operation.
- \*1 For multiple outdoor units control system only.

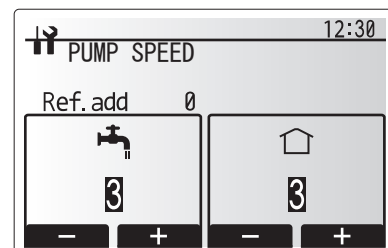

Pump speed setting screen



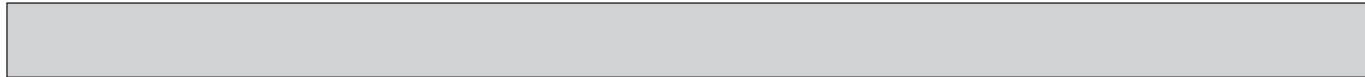

**<Operation settings>**

**Heating operation**

This function allows operational setting of flow temperature range from the Ecodan and also the time interval at which the FTC collects and processes data for the auto adaptation mode.

Menu subtitle		Function	Range	Unit	Default
Flow temp. range	Minimum temp.	To minimize the loss by frequent ON and OFF in mild outdoor ambient temperature seasons.	20 to 45	°C	30
	Maximum temp.	To set max. possible flow temperature according to the type of heat emitters.	35 to 60	°C	50
Room temp. control	Mode	Setting for Room temp. control At Fast mode, target outlet water temperature is set higher than the one set at normal mode. This reduces the time to reach the target room temperature when the room temperature is relatively low.*	Normal/ Fast	—	Normal
	Interval	Selectable according to the heat emitter type and the materials of floor (i.e. radiators, floor heating-thick, -thin concrete, wood, etc.)	10 to 60	min	10
Heat pump thermo diff.adjust	ON/OFF	To minimize the loss by frequent ON and OFF in mild outdoor ambient temperature seasons.	ON/OFF	—	ON
	Lower limit	Prohibits heat pump operation until the flow temperature drops below the target flow temperature plus lower limit value.	-9 to -1	°C	-5
	Upper limit	Allows heat pump operation until the flow temperature rises above the target flow temperature plus upper limit value.	+3 to +5	°C	+5

< Heating operation (Room temp. control table) >

**Notes:**

1. The minimum flow temperature that prohibits heat pump operation is 20°C.
  2. The maximum flow temperature that allows heat pump operation equals to the maximum temperature set in the Flow temp. range menu.
- \* Fast mode is not efficient and will increase running cost compared to normal mode.

**Freeze stat function**

Menu subtitle	Function/ Description
Freeze stat function *1	An operational function to prevent the water circuit from freezing when outdoor ambient temperature drops.
Flow t.	The target outlet water temperature at water circuit when operating in Freeze stat function. *2
Outdoor ambient temp.	Minimum outdoor ambient temperature which freeze stat function will begin to operate, (3-20°C) or choose**. If asterisk (**) is chosen freeze stat function is deactivated. (i.e. primary water freeze risk)*

- \*1. When the system is turned off, freeze stat function is not enabled.  
 \*2. Flow t. is fixed to 20°C and unchangeable.

**Simultaneous Operation**

For periods of very low outdoor ambient temperature this mode can be used. Simultaneous operation allows both DHW and space heating to run together by using the heat pump and/or booster heater to provide space heating whilst only the immersion heater provides heating for DHW. This operation is only available if BOTH a DHW tank AND immersion heater are present on the system.

- Range of outdoor ambient temperature at which simultaneous operation starts is -30 to 10°C (default -15°C).
- System shall automatically return to routine operation. This will happen when the outdoor ambient temperature rises above the selected temperature for this specific mode of operation.

**Cold weather function**

For extremely low outdoor ambient temperature conditions when the heat pump's capacity is restricted, the heating or DHW is provided only by the electric booster heater (and immersion if present). This function is intended for use during extreme cold periods only. Extensive use of direct electrical heaters ONLY will result in higher power consumption and may reduce working life of heaters and related parts.

- Range of outdoor ambient temperature at which cold weather function starts is -30 to -10°C (default -15°C).
- System shall automatically return to routine operation. This will happen when the outdoor ambient temperature rises above the selected temperature for this specific mode of operation.

**Floor dry up function**

The Floor dry up function automatically changes the target hot water temperature in stages to gradually dry concrete when this particular type of underfloor heating system is installed.

Upon completion of the operation the system stops all the operations except the Freeze stat.  
 For Floor dry up function, the target flow temp. of Zone1 is the same as that of Zone2.

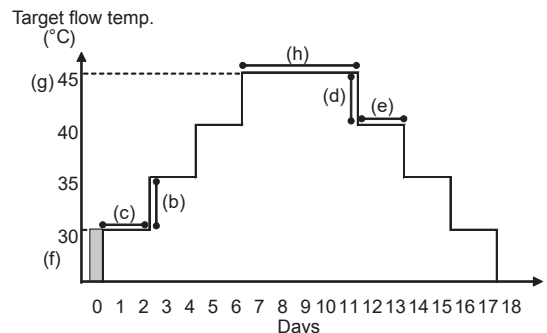

- This function is not available when a PUHZ-FRP outdoor unit is connected.
- Disconnect wiring to external inputs of room thermostat, demand control, and outdoor thermostat, or the target flow temperature may not be maintained.

Functions	Symbol	Description	Option/Range	Unit	Default
Floor dry up function	a	Sets the function to ON and power on the system using the main remote controller, and the dry up heating operation will start.	ON/OFF	—	OFF
Flow temp. (increase)	Flow temp. increase step	Sets the increase step of the target flow temperature.	+1 to +10	°C	+5
	Increase interval	Sets the period for which the same target flow temperature is maintained.	1 to 7	day	2
Flow temp. (decrease)	Flow temp. decrease step	Sets the decrease step of the target flow temperature.	-1 to -10	°C	-5
	Decrease interval	Sets the period for which the same target flow temperature is maintained.	1 to 7	day	2
Target temperature	Start & Finish	Sets the target flow temperature at the start and the finish of the operation.	20 to 60	°C	30
	Max. target temp.	Sets the maximum target flow temperature.	20 to 60	°C	45
	Max. temp. period	Sets the period for which the maximum target flow temperature is maintained.	1 to 20	day	5

## <Energy monitor settings>

### 1. General description

End user can monitor accumulated(\*1) 'Consumed electrical energy' and 'Delivered heat energy' in each operation mode(\*2) on the main remote controller.

\*1 Monthly and Year to date

\*2 - DHW operation

- Space heating
- Space cooling

Refer to the menu tree in "9-4. Main Settings Menu" for how to check the energy, and "6-9. DIP switch functions" for the details on DIP-SW setting.

Either one of the following 2 methods is used for monitoring.

**Note: Method 1 should be used as a guide. If a certain accuracy is required, the 2nd method should be used.**

	Booster heater1	Booster heater2	Immersion heater *1	Pump1 *2
Default	2 kW	4 kW	0 kW	*** (factory fitted pump)
EHST17D-VM2D	2 kW	0 kW	0 kW	***
EHST17D-YM9D	3 kW	6 kW	0 kW	***
ERST17D-VM2D	2 kW	0 kW	0 kW	***
ERST17D-VM2BD	2 kW	0 kW	0 kW	***
ERST17D-VM6D	2 kW	4 kW	0 kW	***
ERST17D-VM6BD	2 kW	4 kW	0 kW	***
ERST17D-YM9BD	3 kW	6 kW	0 kW	***
EHST20D-MED	0 kW	0 kW	0 kW	***
EHST20D-VM2D	2 kW	0 kW	0 kW	***
EHST20D-VM6D	2 kW	4 kW	0 kW	***
EHST20D-YM9D	3 kW	6 kW	0 kW	***
EHST20D-YM9ED	3 kW	6 kW	0 kW	***
EHST20D-TM9D	3 kW	6 kW	0 kW	***
ERST20D-VM2D	2 kW	0 kW	0 kW	***
ERST20D-VM6D	2 kW	4 kW	0 kW	***
ERST20D-YM9D	3 kW	6 kW	0 kW	***
EHST30D-MED	0 kW	0 kW	0 kW	***
EHST30D-VM6ED	2 kW	4 kW	0 kW	***
EHST30D-YM9ED	3 kW	6 kW	0 kW	***
EHST30D-TM9ED	3 kW	6 kW	0 kW	***
ERST30D-VM2ED	2 kW	0 kW	0 kW	***
ERST30D-VM6ED	2 kW	4 kW	0 kW	***
ERST30D-YM9ED	3 kW	6 kW	0 kW	***
EHST20C-MED	0 kW	0 kW	0 kW	***
EHST20C-VM2D	2 kW	0 kW	0 kW	***
EHST20C-VM6D	2 kW	4 kW	0 kW	***
EHST20C-YM9D	3 kW	6 kW	0 kW	***
EHST20C-YM9ED	3 kW	6 kW	0 kW	***
EHST20C-TM9D	3 kW	6 kW	0 kW	***

<Table 9.5.1>

#### (1) Calculation internally

Electricity consumption is calculated internally based on the energy consumption of outdoor unit, electric heater, water pump(s) and other auxiliaries.\*3

Delivered heat is calculated internally by multiplying delta T (Flow and Return temp.) and flow rate measured by the factory fitted sensors.

Set the electric heater capacity and water pump(s) input according to indoor model name and specs of additional pump(s) supplied locally. (Refer to the menu tree in "9-4. Main Settings Menu")

\*1 Change setting to 3kW when connecting optional immersion heater "PAC-IH03V2-E".

\*2 "\*\*\*\*" displayed in the energy monitor setting mode means the factory fitted pump is connected as Pump 1 so that the input is automatically calculated.

\*3 When the cylinder unit is connected with a PUHZ-FRP or PUMY models, electricity consumption is not calculated internally. To display the electricity consumption, conduct the 2nd method.

When additional pumps supplied locally are connected as Pump2/3, change setting according to specs of the pumps.

When anti-freeze solution (propylene glycol) is used for primary water circuit, set the delivered energy adjustment if necessary.

For further detail of above, refer to "5.7 Main remote controller".

#### (2) Actual measurement by external meter (locally supplied)

FTC has external input terminals for 2 'Electric energy meters' and a 'Heat meter'.

If two 'Electric energy meters' are connected, the 2 recorded values will be combined at the FTC and shown on the main remote controller.

(e.g. Meter 1 for H/P power line, Meter 2 for heater power line)

Refer to the [Signal inputs] in section "6. WIRING DIAGRAM" for more information on connectable electric energy meter and heat meter.

#### ● Connectable electric energy meter and heat meter

- Pulse meter type Voltage free contact for 12VDC detection by FTC (TBI.3 1, 3 and 5 pin have a positive voltage.)
- Pulse duration Minimum ON time: 40 ms  
Minimum OFF time: 100 ms
- Possible unit of pulse 0.1 pulse/kWh 1 pulse/kWh 10 pulse/kWh  
100 pulse/kWh 1000 pulse/kWh

Those values can be set by the main remote controller. (Refer to the menu tree in "9-4. Main Settings Menu".)

	Booster heater1	Booster heater2	Immersion heater *1	Pump1 *2
ERST20C-VM2D	2 kW	0 kW	0 kW	***
ERST20C-VM6D	2 kW	4 kW	0 kW	***
ERST20C-YM9D	3 kW	6 kW	0 kW	***
EHST30C-MED	0 kW	0 kW	0 kW	***
EHST30C-VM6ED	2 kW	4 kW	0 kW	***
EHST30C-YM9ED	3 kW	6 kW	0 kW	***
EHST30C-TM9ED	3 kW	6 kW	0 kW	***
ERST30C-VM2ED	2 kW	0 kW	0 kW	***
ERST30C-VM6ED	2 kW	4 kW	0 kW	***
ERST30C-YM9ED	3 kW	6 kW	0 kW	***
EHPT17X-VM2D	2 kW	0 kW	0 kW	***
EHPT17X-VM6D	2 kW	4 kW	0 kW	***
EHPT17X-YM9D	3 kW	6 kW	0 kW	***
ERPT17X-VM2D	2 kW	0 kW	0 kW	***
EHPT20X-MED	0 kW	0 kW	0 kW	***
EHPT20X-VM6D	2 kW	4 kW	0 kW	***
EHPT20X-YM9D	3 kW	6 kW	0 kW	***
EHPT20X-YM9ED	3 kW	6 kW	0 kW	***
EHPT20X-TM9D	3 kW	6 kW	0 kW	***
EHPT20X-MHEDW	0 kW	0 kW	3 kW	***
ERPT20X-MD	0 kW	0 kW	0 kW	***
ERPT20X-VM2D	2 kW	0 kW	0 kW	***
ERPT20X-VM6D	2 kW	4 kW	0 kW	***
EHPT30X-MED	0 kW	0 kW	0 kW	***
EHPT30X-YM9ED	3 kW	6 kW	0 kW	***
ERPT30X-VM2ED	2 kW	0 kW	0 kW	***
ERPT30X-VM6ED	2 kW	4 kW	0 kW	***

<Table 9.5.2>

## 2. Settings using the main remote controller

In this menu, all parameters required to record the consumed electrical energy and the delivered heat energy which is displayed on the main remote controller can be set. The parameters are an electric heater capacity, supply power of water pump and heat meter pulse.

Follow the procedure described in General Operation for the set up operation.

For Pump 1, \*\*\* can be also set besides this setting.

In the case \*\*\* is selected, the system acknowledges "factory fitted pump" is selected.

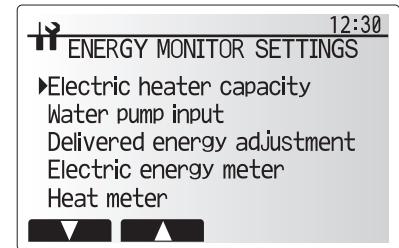

Energy monitor settings menu screen

### <External input settings>

#### Demand control (IN4)

The selection of "OFF", whilst a signal is being sent to IN4, forcefully stops all the heat source operations and the selection of "Boiler" stops operations of heat pump and electric heater and performs boiler operation.

#### Outdoor thermostat (IN5)

The selection of "Heater", whilst a signal is being sent to IN5, performs only electric heater operation and the selection of "Boiler" performs boiler operation.

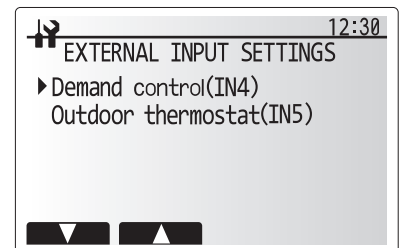

External input settings menu screen

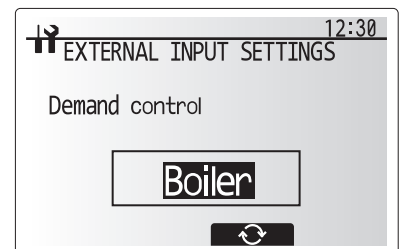

Demand control screen

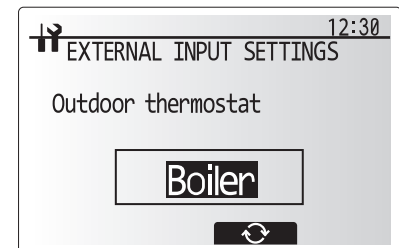

Outdoor thermostat setting screen

### <Running information>

This function shows current temperature and other data of main component parts of both the indoor and outdoor units.

1. From the Service menu highlight Running information.
2. Press CONFIRM.
3. Press F3 and F4 buttons to set the Ref. address. \*1
4. Use the function buttons to enter index code for the component to be viewed.  
(See the Table 9.5.1 for component index codes.)
5. Press CONFIRM.

\*1 For multiple outdoor units control system only.

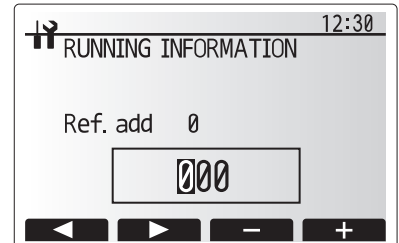

### <Thermistor reading>

This function shows the current readings of thermistors located on the water and refrigerant circuit

Thermistor	Description	Thermistor	Description
TH1A	Zone1 room temperature	TH7	Ambient (outdoor) temperature
TH1B	Zone2 room temperature	THW6	Zone1 flow temperature
TH2	Refrigerant return temperature	THW7	Zone1 return temperature
THW1	Flow water temperature	THW8	Zone2 flow temperature
THW2	Return water temperature	THW9	Zone2 return temperature
THW5A	DHW tank upper water temperature	THW10	Mixing tank temperature
THW5B	DHW tank lower water temperature	THWB1	Boiler flow temperature

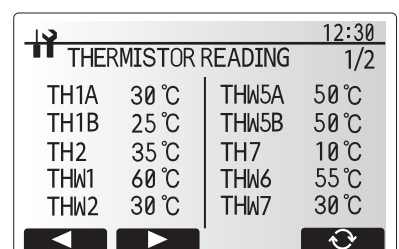

### <Summary of settings>

This function shows the current installer/user entered settings.

Abbreviation	Explanation	Abbreviation	Explanation
<b>HWtemp</b>	DHW max. temperature	<b>Z2 mode</b>	Operation mode
<b>HWdrop</b>	DHW temperature drop		- HER (Heating room temperature)
<b>HWtime</b>	DHW max. operation time		- HE (Heating flow temperature)
<b>NO HW</b>	DHW mode restriction		- HCC (Heating compensation curve)
<b>HWset</b>	DHW operation mode (Normal/Eco)		- COR (—)
<b>Ltemp</b>	Legionella hot water temperature		- CO (Cooling flow temperature)
<b>Lfreq</b>	Legionella operation Frequency	<b>Hroom 1</b>	Heating target room temperature
<b>Lstart</b>	Legionella mode start time	<b>Hroom 2</b>	Heating target room temperature
<b>Ltime</b>	Legionella max. operation time	<b>Hflow 1</b>	Heating target flow temperature
<b>Lkeep</b>	Duration of max. (Legionella) hot water temperature	<b>Hflow 2</b>	Heating target flow temperature
<b>Z1 mode</b>	Operation mode	<b>Croom 1</b>	Cooling target room temperature
	- HER (Heating room temperature)	<b>Croom 2</b>	Cooling target room temperature
	- HE (Heating flow temperature)	<b>Cflow 1</b>	Cooling target flow temperature
	- HCC (Heating compensation curve)	<b>Cflow 2</b>	Cooling target flow temperature
	- COR (—)	<b>FSflow</b>	Freeze stat function flow temperature
	- CO (Cooling flow temperature)	<b>FSout</b>	Freeze stat function ambient temperature

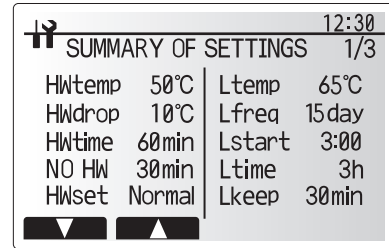

### <Error history>

Error history allows the service engineer to view previous check codes, the unit address and the date on which they occurred. Up to 16 check codes can be stored in the history the most recent Error event is displayed at the top of the list.

1. From the service menu select Error history
2. Press CONFIRM.

Please see "10-4. Self-diagnosis and action" for check code diagnosis and actions.

To delete an Error history item;

1. From Error history screen press F4 button (Rubbish bin icon)
2. Then press F3 button (Yes).

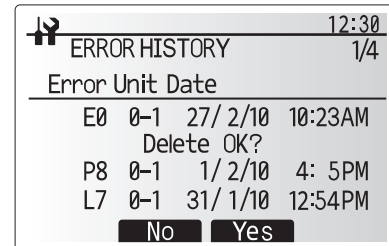
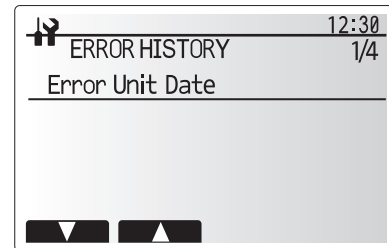

### <Password protection>

Password protection is available to prevent unauthorised access to the service menu by untrained persons.

#### Resetting the password

If you forget the password you entered, or have to service a unit somebody else installed, you can reset the password to the factory default of **0000**.

1. From the main settings menu scroll down the functions until Service Menu is highlighted.
2. Press CONFIRM.
3. You will be prompted to enter a password.
4. Hold down buttons F3 and F4 together for 3 seconds
5. You will be asked if you wish to continue and reset the password to default setting.
6. To reset press button F3.
7. The password is now reset to **0000**.

#### <Manual reset>

Should you wish to restore the initial settings at any time you should use the manual reset function. Please note this will reset ALL functions to the factory default settings.



Password input screen



Password verify screen

### Resetting the password

If you forget the password you entered, or have to service a unit somebody else installed, you can reset the password to the factory default of **0000**.

1. From the main settings menu scroll down the functions until Service Menu is highlighted.
2. Press CONFIRM.
3. You will be prompted to enter a password.
4. Hold down buttons F3 and F4 together for 3 seconds.
5. You will be asked if you wish to continue and reset the password to default setting.
6. To reset press button F3.
7. The password is now reset to **0000**.

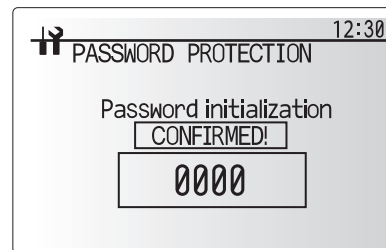

Completion screen

### <Manual reset>

Should you wish to restore the initial settings at any time you should use the manual reset function. Please note this will reset ALL functions to the factory default settings.

1. From the service menu use F1 and F2 buttons to scroll through list until Manual Reset is highlighted.
2. Press CONFIRM.
3. The Manual reset screen is displayed.
4. Choose either Manual Reset for FTC or Main remote controller.
5. Press F3 button to confirm manual reset of chosen device.

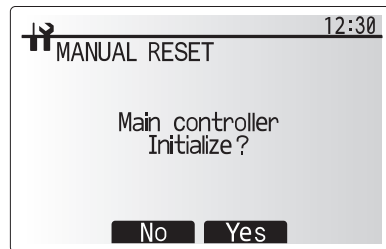
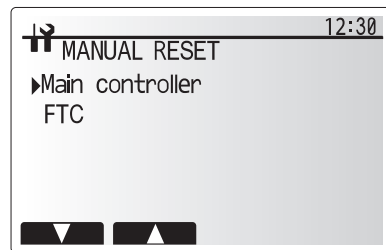

### <SD card>

The use of an SD memory card simplifies the main remote controller settings in the field.

\*Ecodan service tool (for use with PC tool) is necessary for the setting.

#### SD → Main RC

1. From the SD card setting use F1 and F2 buttons to scroll through list until "SD → Main RC" is highlighted.
  2. Press CONFIRM.
  3. Press F3 and F4 buttons to set the Ref. address. \*1
  4. Use F1, F2 and F3 buttons to select a menu to write to the main remote controller.
  5. Press CONFIRM to start downloading.
  6. Wait for a few minutes until "Complete!" appears.
- \*1 For multiple outdoor units control system only.

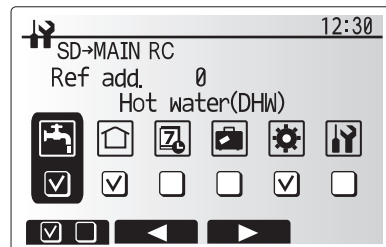
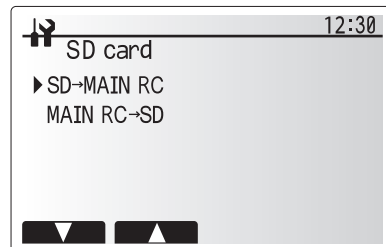

#### Main RC → SD

1. From the SD card setting use F1 and F2 buttons to scroll through list until Main RC → SD is highlighted.
  2. Press CONFIRM.
  3. Press F3 and F4 buttons to set the Ref. address. \*1
  4. Use F1, F2 and F3 buttons to select a menu to write to the SD memory card.
  5. Press CONFIRM to start uploading.
  6. Wait for a few minutes until "Complete!" appears.
- \*1 For multiple outdoor units control system only.

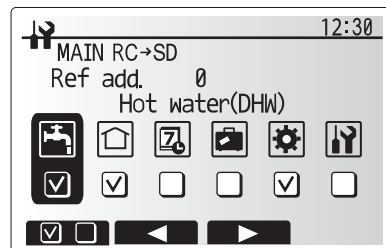

<Table 9.5.3>

Request code	Request content	Range	Unit
103	Error history 1 (latest)	Displays error history. ("--" is displays if no history is present.)	Code
104	Error history 2 (second to last)	Displays error history. ("--" is displays if no history is present.)	—
105	Error history 3 (third to last)	Displays error history. ("--" is displays if no history is present.)	—
154	Water circulation pump 1 - Accumulated operating time (after reset)	0 to 9999	10 hours
156	Water circulation pump 2 - Accumulated operating time (after reset)	0 to 9999	10 hours
157	Water circulation pump 3 - Accumulated operating time (after reset)	0 to 9999	10 hours
158	Water circulation pump 4 - Accumulated operating time (after reset)	0 to 9999	10 hours
162	Indoor unit - DIP SW1 setting information	Refer to detail contents described hereinafter.	—
163	Indoor unit - DIP SW2 setting information	Refer to detail contents described hereinafter.	—
164	Indoor unit - DIP SW3 setting information	Refer to detail contents described hereinafter.	—
165	Indoor unit - DIP SW4 setting information	Refer to detail contents described hereinafter.	—
166	Indoor unit - DIP SW5 setting information	Refer to detail contents described hereinafter.	—
175	Indoor unit - Output signal information	Refer to detail contents described hereinafter.	—
176	Indoor unit - Input signal information	Refer to detail contents described hereinafter.	—
177	Mixing valve opening step	0 to 10	Step
190	Indoor unit - Software version 1st 4 digits	Refer to Note below.	—
191	Indoor unit - Software version last 4 digits	Refer to Note below.	—
200	Initialisation of Function Setting	—	—
340	Water circulation pump 1 - Accumulated operating time reset	—	—
342	Water circulation pump 2 - Accumulated operating time reset	—	—
343	Water circulation pump 3 - Accumulated operating time reset	—	—
344	Water circulation pump 4 - Accumulated operating time reset	—	—
504	Indoor unit - Zone1 room temp. (TH1A)	-39 to 88	°C
505	Indoor unit - Ref. liquid temp. (TH2)	-39 to 88	°C
506	Indoor unit - Return water temp. (THW2)	-39 to 88	°C
507	Indoor unit - Zone2 room temp. (TH1B)	-39 to 88	°C
508	Indoor unit - DHW tank lower water temp. (THW5B)	-39 to 88	°C
509	Indoor unit - Zone1 flow water temp. (THW6)	-39 to 88	°C
510	Indoor unit - Outside air temp. (TH7)	-39 to 88	°C
511	Indoor unit - Flow water temp. (THW1)	-39 to 88	°C
512	Indoor unit - Zone1 return water temp. (THW7)	-39 to 88	°C
513	Indoor unit - Zone2 flow water temp. (THW8)	-39 to 88	°C
514	Indoor unit - Zone2 return water temp. (THW9)	-39 to 88	°C
515	Indoor unit - Boiler flow water temp. (THWB1)	-40 to 140	°C
534	Indoor unit - DHW tank upper water temp. (THW5A)	-39 to 88	°C
535	Indoor unit - Mixing tank water temp. (THW10)	-40 to 140	°C
540	Flow rate of the primary circuit	0 to 100	L/min
550	Indoor unit - Error postponement history 1 (latest)	Displays postponement code. ("--" is displays if no postponement code is present.)	—
551	Indoor unit - Operation control at time of error	0 Standard, 1 Heater, 2 Boiler	—
552	Indoor unit - Operation mode at time of error	0: OFF, 1: DHW, 2: Heating, 3: Cooling, 4: Legionella prevention, 5: Freeze protection, 6: Operation stop, 7: Defrost	—
553	Indoor unit - Output signal information at time of error	Refer to detail contents described hereinafter.	—
554	Indoor unit - Input signal information at time of error	Refer to detail contents described hereinafter.	—
555	Indoor unit - Zone1 room temp. (TH1A) at time of error	-39 to 88	°C
556	Indoor unit - Zone2 room temp. (TH1B) at time of error	-39 to 88	°C
557	Indoor unit - Ref. liquid temp. (TH2) at time of error	-39 to 88	°C
558	Indoor unit - Flow water temp. (THW1) at time of error	-39 to 88	°C
559	Indoor unit - Return water temp. (THW2) at time of error	-39 to 88	°C
560	Indoor unit - DHW tank water temp. (THW5) at time of error	-39 to 88	°C
561	Indoor unit - Zone1 flow water temp. (THW6) at time of error	-39 to 88	°C
562	Indoor unit - Zone1 return water temp. (THW7) at time of error	-39 to 88	°C
563	Indoor unit - Zone2 flow water temp. (THW8) at time of error	-39 to 88	°C
564	Indoor unit - Zone2 return water temp. (THW9) at time of error	-39 to 88	°C
565	Indoor unit - Boiler flow water temp. (THWB1) at time of error	-40 to 140	°C
567	Indoor unit - Failure (P1/P2/L5/L8/Ld) thermistor	0: Failure thermistor is none, 1: TH1A, 2: TH2, 3: THW1, 4: THW2, 5: THWB1, 6: THW5B, 8: TH1B, A: THW6, B: THW7, C: THW8, D: THW9	—
568	Mixing valve opening step at time of error	0 to 10	Step
569	Operated Flow switch at time of failure (L9)	0: No operated flow switch, 1: Flow switch 1, 2: Flow switch 2, 3: Flow switch 3	—
571	Flow rate at time of error	0 to 100	L/min

**Note:**

Refer to outdoor unit service manual for request code 0 to 102, 106 to 149.

Request codes 103 to 105 indicate error histories of both indoor and outdoor units.

As only 4 digits can be displayed at one time, the software version number is displayed in two halves.

Enter code 190 to see the first 4 digits and code 191 to see the last 4 digits.

For example software version No. 5.01 A000, when code 190 is entered 0501 is displayed, when code 191 is entered A000 is displayed.

Request code 200 resets all Function Setting to the factory default settings.

**Indoor unit switch setting display (Request code: 162 to 166)**

0: OFF 1: ON

SW1, SW2, SW3, SW4, SW5								Display
1	2	3	4	5	6	7	8	
0	0	0	0	0	0	0	0	00 00
1	0	0	0	0	0	0	0	00 01
0	1	0	0	0	0	0	0	00 02
1	1	0	0	0	0	0	0	00 03
0	0	1	0	0	0	0	0	00 04
1	0	1	0	0	0	0	0	00 05
0	1	1	0	0	0	0	0	00 06
1	1	1	0	0	0	0	0	00 07
0	0	0	1	0	0	0	0	00 08
1	0	0	1	0	0	0	0	00 09
0	1	0	1	0	0	0	0	00 0A
1	1	0	1	0	0	0	0	00 0B
0	0	1	1	0	0	0	0	00 0C
1	0	1	1	0	0	0	0	00 0D
0	1	1	1	0	0	0	0	00 0E
1	1	1	1	0	0	0	0	00 0F
0	0	0	0	1	0	0	0	00 10
1	0	0	0	1	0	0	0	00 11
0	1	0	0	1	0	0	0	00 12
1	1	0	0	1	0	0	0	00 13
0	0	1	0	1	0	0	0	00 14
1	0	1	0	1	0	0	0	00 15
0	1	1	0	1	0	0	0	00 16
1	1	1	0	1	0	0	0	00 17
0	0	0	1	1	0	0	0	00 18
1	0	0	1	1	0	0	0	00 19
0	1	0	1	1	0	0	0	00 1A
1	1	0	1	1	0	0	0	00 1B
0	0	1	1	1	0	0	0	00 1C
1	0	1	1	1	0	0	0	00 1D
0	1	1	1	1	0	0	0	00 1E
1	1	1	1	1	0	0	0	00 1F
0	0	0	0	0	1	0	0	00 20
1	0	0	0	0	1	0	0	00 21
0	1	0	0	0	1	0	0	00 22
1	1	0	0	0	1	0	0	00 23
0	0	1	0	0	1	0	0	00 24
1	0	1	0	0	1	0	0	00 25
0	1	1	0	0	1	0	0	00 26
1	1	1	0	0	1	0	0	00 27
0	0	0	1	0	1	0	0	00 28
1	0	0	1	0	1	0	0	00 29
0	1	0	1	0	1	0	0	00 2A
1	1	0	1	0	1	0	0	00 2B
0	0	1	1	0	1	0	0	00 2C
1	0	1	1	0	1	0	0	00 2D
0	1	1	1	0	1	0	0	00 2E
1	1	1	1	0	1	0	0	00 2F
0	0	0	0	1	1	0	0	00 30
1	0	0	0	1	1	0	0	00 31
0	1	0	0	1	1	0	0	00 32
1	1	0	0	1	1	0	0	00 33
0	0	1	0	1	1	0	0	00 34
1	0	1	0	1	1	0	0	00 35
0	1	1	0	1	1	0	0	00 36
1	1	1	0	1	1	0	0	00 37
0	0	0	1	1	1	0	0	00 38
1	0	0	1	1	1	0	0	00 39
0	1	0	1	1	1	0	0	00 3A
1	1	0	1	1	1	0	0	00 3B
0	0	1	1	1	1	0	0	00 3C
1	0	1	1	1	1	0	0	00 3D
0	1	1	1	1	1	0	0	00 3E
1	1	1	1	1	1	0	0	00 3F

0: OFF 1: ON

SW1, SW2, SW3, SW4, SW5								Display
1	2	3	4	5	6	7	8	
0	0	0	0	0	0	1	0	00 40
1	0	0	0	0	0	1	0	00 41
0	1	0	0	0	0	1	0	00 42
1	1	0	0	0	0	1	0	00 43
0	0	1	0	0	0	1	0	00 44
1	0	1	0	0	0	1	0	00 45
0	1	1	0	0	0	1	0	00 46
1	1	1	0	0	0	1	0	00 47
0	0	0	1	0	0	1	0	00 48
1	0	0	1	0	0	1	0	00 49
0	1	0	1	0	0	1	0	00 4A
1	1	0	1	0	0	1	0	00 4B
0	0	1	1	0	0	1	0	00 4C
1	0	1	1	0	0	1	0	00 4D
0	1	1	1	0	0	1	0	00 4E
1	1	1	1	0	0	1	0	00 4F
0	0	0	0	1	0	1	0	00 50
1	0	0	0	1	0	1	0	00 51
0	1	0	0	1	0	1	0	00 52
1	1	0	0	1	0	1	0	00 53
0	0	1	0	1	0	1	0	00 54
1	0	1	0	1	0	1	0	00 55
0	1	1	0	1	0	1	0	00 56
1	1	1	0	1	0	1	0	00 57
0	0	0	1	1	0	1	0	00 58
1	0	0	1	1	0	1	0	00 59
0	1	0	1	1	0	1	0	00 5A
1	1	0	1	1	0	1	0	00 5B
0	0	1	1	1	0	1	0	00 5C
1	0	1	1	1	0	1	0	00 5D
0	1	1	1	1	0	1	0	00 5E
1	1	1	1	1	0	1	0	00 5F
0	0	0	0	0	1	1	0	00 60
1	0	0	0	0	1	1	0	00 61
0	1	0	0	0	1	1	0	00 62
1	1	0	0	0	1	1	0	00 63
0	0	1	0	0	1	1	0	00 64
1	0	1	0	0	1	1	0	00 65
0	1	1	0	0	1	1	0	00 66
1	1	1	0	0	1	1	0	00 67
0	0	0	1	0	1	1	0	00 68
1	0	0	1	0	1	1	0	00 69
0	1	0	1	0	1	1	0	00 6A
1	1	0	1	0	1	1	0	00 6B
0	0	1	1	0	1	1	0	00 6C
1	0	1	1	0	1	1	0	00 6D
0	1	1	1	0	1	1	0	00 6E
1	1	1	1	0	1	1	0	00 6F
0	0	0	0	1	1	1	0	00 70
1	0	0	0	1	1	1	0	00 71
0	1	0	0	1	1	1	0	00 72
1	1	0	0	1	1	1	0	00 73
0	0	1	0	1	1	1	0	00 74
1	0	1	0	1	1	1	0	00 75
0	1	1	0	1	1	1	0	00 76
1	1	1	0	1	1	1	0	00 77
0	0	0	1	1	1	1	0	00 78
1	0	0	1	1	1	1	0	00 79
0	1	0	1	1	1	1	0	00 7A
1	1	0	1	1	1	1	0	00 7B
0	0	1	1	1	1	1	0	00 7C
1	0	1	1	1	1	1	0	00 7D
0	1	1	1	1	1	1	0	00 7E
1	1	1	1	1	1	1	0	00 7F

**Indoor unit switch setting display (Request code: 162 to 166)**

0: OFF 1: ON

SW1, SW2, SW3, SW4, SW5								Display
1	2	3	4	5	6	7	8	
0	0	0	0	0	0	0	1	00 80
1	0	0	0	0	0	0	1	00 81
0	1	0	0	0	0	0	1	00 82
1	1	0	0	0	0	0	1	00 83
0	0	1	0	0	0	0	1	00 84
1	0	1	0	0	0	0	1	00 85
0	1	1	0	0	0	0	1	00 86
1	1	1	0	0	0	0	1	00 87
0	0	0	1	0	0	0	1	00 88
1	0	0	1	0	0	0	1	00 89
0	1	0	1	0	0	0	1	00 8A
1	1	0	1	0	0	0	1	00 8B
0	0	1	1	0	0	0	1	00 8C
1	0	1	1	0	0	0	1	00 8D
0	1	1	1	0	0	0	1	00 8E
1	1	1	1	0	0	0	1	00 8F
0	0	0	0	1	0	0	1	00 90
1	0	0	0	1	0	0	1	00 91
0	1	0	0	1	0	0	1	00 92
1	1	0	0	1	0	0	1	00 93
0	0	1	0	1	0	0	1	00 94
1	0	1	0	1	0	0	1	00 95
0	1	1	0	1	0	0	1	00 96
1	1	1	0	1	0	0	1	00 97
0	0	0	1	1	0	0	1	00 98
1	0	0	1	1	0	0	1	00 99
0	1	0	1	1	0	0	1	00 9A
1	1	0	1	1	0	0	1	00 9B
0	0	1	1	1	0	0	1	00 9C
1	0	1	1	1	0	0	1	00 9D
0	1	1	1	1	0	0	1	00 9E
1	1	1	1	1	0	0	1	00 9F
0	0	0	0	0	1	0	1	00 A0
1	0	0	0	0	1	0	1	00 A1
0	1	0	0	0	1	0	1	00 A2
1	1	0	0	0	1	0	1	00 A3
0	0	1	0	0	1	0	1	00 A4
1	0	1	0	0	1	0	1	00 A5
0	1	1	0	0	1	0	1	00 A6
1	1	1	0	0	1	0	1	00 A7
0	0	0	1	0	1	0	1	00 A8
1	0	0	1	0	1	0	1	00 A9
0	1	0	1	0	1	0	1	00 AA
1	1	0	1	0	1	0	1	00 AB
0	0	1	1	0	1	0	1	00 AC
1	0	1	1	0	1	0	1	00 AD
0	1	1	1	0	1	0	1	00 AE
1	1	1	1	0	1	0	1	00 AF
0	0	0	0	1	1	0	1	00 B0
1	0	0	0	1	1	0	1	00 B1
0	1	0	0	1	1	0	1	00 B2
1	1	0	0	1	1	0	1	00 B3
0	0	1	0	1	1	0	1	00 B4
1	0	1	0	1	1	0	1	00 B5
0	1	1	0	1	1	0	1	00 B6
1	1	1	0	1	1	0	1	00 B7
0	0	0	1	1	1	0	1	00 B8
1	0	0	1	1	1	0	1	00 B9
0	1	0	1	1	1	0	1	00 BA
1	1	0	1	1	1	0	1	00 BB
0	0	1	1	1	1	0	1	00 BC
1	0	1	1	1	1	0	1	00 BD
0	1	1	1	1	1	0	1	00 BE
1	1	1	1	1	1	0	1	00 BF

0: OFF 1: ON

SW1, SW2, SW3, SW4, SW5								Display
1	2	3	4	5	6	7	8	
0	0	0	0	0	0	1	1	00 C0
1	0	0	0	0	0	1	1	00 C1
0	1	0	0	0	0	1	1	00 C2
1	1	0	0	0	0	1	1	00 C3
0	0	1	0	0	0	1	1	00 C4
1	0	1	0	0	0	1	1	00 C5
0	1	1	0	0	0	1	1	00 C6
1	1	1	0	0	0	1	1	00 C7
0	0	0	1	0	0	1	1	00 C8
1	0	0	1	0	0	1	1	00 C9
0	1	0	1	0	0	1	1	00 CA
1	1	0	1	0	0	1	1	00 CB
0	0	1	1	0	0	1	1	00 CC
1	0	1	1	0	0	1	1	00 CD
0	1	1	1	0	0	1	1	00 CE
1	1	1	1	0	0	1	1	00 CF
0	0	0	0	1	0	1	1	00 D0
1	0	0	0	1	0	1	1	00 D1
0	1	0	0	1	0	1	1	00 D2
1	1	0	0	1	0	1	1	00 D3
0	0	1	0	1	0	1	1	00 D4
1	0	1	0	1	0	1	1	00 D5
0	1	1	0	1	0	1	1	00 D6
1	1	1	0	1	0	1	1	00 D7
0	0	0	1	1	0	1	1	00 D8
1	0	0	1	1	0	1	1	00 D9
0	1	0	1	1	0	1	1	00 DA
1	1	0	1	1	0	1	1	00 DB
0	0	1	1	1	0	1	1	00 DC
1	0	1	1	1	0	1	1	00 DD
0	1	1	1	1	0	1	1	00 DE
1	1	1	1	1	0	1	1	00 DF
0	0	0	0	0	1	1	1	00 E0
1	0	0	0	0	1	1	1	00 E1
0	1	0	0	0	1	1	1	00 E2
1	1	0	0	0	1	1	1	00 E3
0	0	1	0	0	1	1	1	00 E4
1	0	1	0	0	1	1	1	00 E5
0	1	1	0	0	1	1	1	00 E6
1	1	1	0	0	1	1	1	00 E7
0	0	0	1	0	1	1	1	00 E8
1	0	0	1	0	1	1	1	00 E9
0	1	0	1	0	1	1	1	00 EA
1	1	0	1	0	1	1	1	00 EB
0	0	1	1	0	1	1	1	00 EC
1	0	1	1	0	1	1	1	00 ED
0	1	1	1	0	1	1	1	00 EE
1	1	1	1	0	1	1	1	00 EF
0	0	0	0	1	1	1	1	00 F0
1	0	0	0	1	1	1	1	00 F1
0	1	0	0	1	1	1	1	00 F2
1	1	0	0	1	1	1	1	00 F3
0	0	1	0	1	1	1	1	00 F4
1	0	1	0	1	1	1	1	00 F5
0	1	1	0	1	1	1	1	00 F6
1	1	1	0	1	1	1	1	00 F7
0	0	0	1	1	1	1	1	00 F8
1	0	0	1	1	1	1	1	00 F9
0	1	0	1	1	1	1	1	00 FA
1	1	0	1	1	1	1	1	00 FB
0	0	1	1	1	1	1	1	00 FC
1	0	1	1	1	1	1	1	00 FD
0	1	1	1	1	1	1	1	00 FE
1	1	1	1	1	1	1	1	00 FF



**Output signal display (Request code: 175/553)**

Please refer to Table 2 on relevant wiring diagram whilst using the following.

0: OFF 1: ON

OUT								Display
1	2	3	4	5A	5B	6	7	
0	0	0	0	0	0	0	0	xx 00
1	0	0	0	0	0	0	0	xx 01
0	1	0	0	0	0	0	0	xx 02
1	1	0	0	0	0	0	0	xx 03
0	0	1	0	0	0	0	0	xx 04
1	0	1	0	0	0	0	0	xx 05
0	1	1	0	0	0	0	0	xx 06
1	1	1	0	0	0	0	0	xx 07
0	0	0	1	0	0	0	0	xx 08
1	0	0	1	0	0	0	0	xx 09
0	1	0	1	0	0	0	0	xx 0A
1	1	0	1	0	0	0	0	xx 0B
0	0	1	1	0	0	0	0	xx 0C
1	0	1	1	0	0	0	0	xx 0D
0	1	1	1	0	0	0	0	xx 0E
1	1	1	1	0	0	0	0	xx 0F
0	0	0	0	1	0	0	0	xx 10
1	0	0	0	1	0	0	0	xx 11
0	1	0	0	1	0	0	0	xx 12
1	1	0	0	1	0	0	0	xx 13
0	0	1	0	1	0	0	0	xx 14
1	0	1	0	1	0	0	0	xx 15
0	1	1	0	1	0	0	0	xx 16
1	1	1	0	1	0	0	0	xx 17
0	0	0	1	1	0	0	0	xx 18
1	0	0	1	1	0	0	0	xx 19
0	1	0	1	1	0	0	0	xx 1A
1	1	0	1	1	0	0	0	xx 1B
0	0	1	1	1	0	0	0	xx 1C
1	0	1	1	1	0	0	0	xx 1D
0	1	1	1	1	0	0	0	xx 1E
1	1	1	1	1	0	0	0	xx 1F
0	0	0	0	0	1	0	0	xx 20
1	0	0	0	0	1	0	0	xx 21
0	1	0	0	0	1	0	0	xx 22
1	1	0	0	0	1	0	0	xx 23
0	0	1	0	0	1	0	0	xx 24
1	0	1	0	0	1	0	0	xx 25
0	1	1	0	0	1	0	0	xx 26
1	1	1	0	0	1	0	0	xx 27
0	0	0	1	0	1	0	0	xx 28
1	0	0	1	0	1	0	0	xx 29
0	1	0	1	0	1	0	0	xx 2A
1	1	0	1	0	1	0	0	xx 2B
0	0	1	1	0	1	0	0	xx 2C
1	0	1	1	0	1	0	0	xx 2D
0	1	1	1	0	1	0	0	xx 2E
1	1	1	1	0	1	0	0	xx 2F
0	0	0	0	1	1	0	0	xx 30
1	0	0	0	1	1	0	0	xx 31
0	1	0	0	1	1	0	0	xx 32
1	1	0	0	1	1	0	0	xx 33
0	0	1	0	1	1	0	0	xx 34
1	0	1	0	1	1	0	0	xx 35
0	1	1	0	1	1	0	0	xx 36
1	1	1	0	1	1	0	0	xx 37
0	0	0	1	1	1	0	0	xx 38
1	0	0	1	1	1	0	0	xx 39
0	1	0	1	1	1	0	0	xx 3A
1	1	0	1	1	1	0	0	xx 3B
0	0	1	1	1	1	0	0	xx 3C
1	0	1	1	1	1	0	0	xx 3D
0	1	1	1	1	1	0	0	xx 3E
1	1	1	1	1	1	0	0	xx 3F

0: OFF 1: ON

OUT								Display
1	2	3	4	5A	5B	6	7	
0	0	0	0	0	0	1	0	xx 40
1	0	0	0	0	0	1	0	xx 41
0	1	0	0	0	0	1	0	xx 42
1	1	0	0	0	0	1	0	xx 43
0	0	1	0	0	0	1	0	xx 44
1	0	1	0	0	0	1	0	xx 45
0	1	1	0	0	0	1	0	xx 46
1	1	1	0	0	0	1	0	xx 47
0	0	0	1	0	0	1	0	xx 48
1	0	0	1	0	0	1	0	xx 49
0	1	0	1	0	0	1	0	xx 4A
1	1	0	1	0	0	1	0	xx 4B
0	0	1	1	0	0	1	0	xx 4C
1	0	1	1	0	0	1	0	xx 4D
0	1	1	1	0	0	1	0	xx 4E
1	1	1	1	0	0	1	0	xx 4F
0	0	0	0	1	0	1	0	xx 50
1	0	0	0	1	0	1	0	xx 51
0	1	0	0	1	0	1	0	xx 52
1	1	0	0	1	0	1	0	xx 53
0	0	1	0	1	0	1	0	xx 54
1	0	1	0	1	0	1	0	xx 55
0	1	1	0	1	0	1	0	xx 56
1	1	1	0	1	0	1	0	xx 57
0	0	0	1	1	0	1	0	xx 58
1	0	0	1	1	0	1	0	xx 59
0	1	0	1	1	0	1	0	xx 5A
1	1	0	1	1	0	1	0	xx 5B
0	0	1	1	1	0	1	0	xx 5C
1	0	1	1	1	0	1	0	xx 5D
0	1	1	1	1	0	1	0	xx 5E
1	1	1	1	1	0	1	0	xx 5F
0	0	0	0	0	1	1	0	xx 60
1	0	0	0	0	1	1	0	xx 61
0	1	0	0	0	1	1	0	xx 62
1	1	0	0	0	1	1	0	xx 63
0	0	1	0	0	1	1	0	xx 64
1	0	1	0	0	1	1	0	xx 65
0	1	1	0	0	1	1	0	xx 66
1	1	1	0	0	1	1	0	xx 67
0	0	0	1	0	1	1	0	xx 68
1	0	0	1	0	1	1	0	xx 69
0	1	0	1	0	1	1	0	xx 6A
1	1	0	1	0	1	1	0	xx 6B
0	0	1	1	0	1	1	0	xx 6C
1	0	1	1	0	1	1	0	xx 6D
0	1	1	1	0	1	1	0	xx 6E
1	1	1	1	0	1	1	0	xx 6F
0	0	0	0	1	1	1	0	xx 70
1	0	0	0	1	1	1	0	xx 71
0	1	0	0	1	1	1	0	xx 72
1	1	0	0	1	1	1	0	xx 73
0	0	1	0	1	1	1	0	xx 74
1	0	1	0	1	1	1	0	xx 75
0	1	1	0	1	1	1	0	xx 76
1	1	1	0	1	1	1	0	xx 77
0	0	0	1	1	1	1	0	xx 78
1	0	0	1	1	1	1	0	xx 79
0	1	0	1	1	1	1	0	xx 7A
1	1	0	1	1	1	1	0	xx 7B
0	0	1	1	1	1	1	0	xx 7C
1	0	1	1	1	1	1	0	xx 7D
0	1	1	1	1	1	1	0	xx 7E
1	1	1	1	1	1	1	0	xx 7F

**Output signal display (Request code: 175/553)**

Please refer to Table 2 on relevant wiring diagram whilst using the following.

0: OFF 1: ON

OUT								Display
1	2	3	4	5A	5B	6	7	
0	0	0	0	0	0	0	1	xx 80
1	0	0	0	0	0	0	1	xx 81
0	1	0	0	0	0	0	1	xx 82
1	1	0	0	0	0	0	1	xx 83
0	0	1	0	0	0	0	1	xx 84
1	0	1	0	0	0	0	1	xx 85
0	1	1	0	0	0	0	1	xx 86
1	1	1	0	0	0	0	1	xx 87
0	0	0	1	0	0	0	1	xx 88
1	0	0	1	0	0	0	1	xx 89
0	1	0	1	0	0	0	1	xx 8A
1	1	0	1	0	0	0	1	xx 8B
0	0	1	1	0	0	0	1	xx 8C
1	0	1	1	0	0	0	1	xx 8D
0	1	1	1	0	0	0	1	xx 8E
1	1	1	1	0	0	0	1	xx 8F
0	0	0	0	1	0	0	1	xx 90
1	0	0	0	1	0	0	1	xx 91
0	1	0	0	1	0	0	1	xx 92
1	1	0	0	1	0	0	1	xx 93
0	0	1	0	1	0	0	1	xx 94
1	0	1	0	1	0	0	1	xx 95
0	1	1	0	1	0	0	1	xx 96
1	1	1	0	1	0	0	1	xx 97
0	0	0	1	1	0	0	1	xx 98
1	0	0	1	1	0	0	1	xx 99
0	1	0	1	1	0	0	1	xx 9A
1	1	0	1	1	0	0	1	xx 9B
0	0	1	1	1	0	0	1	xx 9C
1	0	1	1	1	0	0	1	xx 9D
0	1	1	1	1	0	0	1	xx 9E
1	1	1	1	1	0	0	1	xx 9F
0	0	0	0	0	1	0	1	xx A0
1	0	0	0	0	1	0	1	xx A1
0	1	0	0	0	1	0	1	xx A2
1	1	0	0	0	1	0	1	xx A3
0	0	1	0	0	1	0	1	xx A4
1	0	1	0	0	1	0	1	xx A5
0	1	1	0	0	1	0	1	xx A6
1	1	1	0	0	1	0	1	xx A7
0	0	0	1	0	1	0	1	xx A8
1	0	0	1	0	1	0	1	xx A9
0	1	0	1	0	1	0	1	xx AA
1	1	0	1	0	1	0	1	xx AB
0	0	1	1	0	1	0	1	xx AC
1	0	1	1	0	1	0	1	xx AD
0	1	1	1	0	1	0	1	xx AE
1	1	1	1	0	1	0	1	xx AF
0	0	0	0	1	1	0	1	xx B0
1	0	0	0	1	1	0	1	xx B1
0	1	0	0	1	1	0	1	xx B2
1	1	0	0	1	1	0	1	xx B3
0	0	1	0	1	1	0	1	xx B4
1	0	1	0	1	1	0	1	xx B5
0	1	1	0	1	1	0	1	xx B6
1	1	1	0	1	1	0	1	xx B7
0	0	0	1	1	1	0	1	xx B8
1	0	0	1	1	1	0	1	xx B9
0	1	0	1	1	1	0	1	xx BA
1	1	0	1	1	1	0	1	xx BB
0	0	1	1	1	1	0	1	xx BC
1	0	1	1	1	1	0	1	xx BD
0	1	1	1	1	1	0	1	xx BE
1	1	1	1	1	1	0	1	xx BF

0: OFF 1: ON

OUT								Display
1	2	3	4	5A	5B	6	7	
0	0	0	0	0	0	1	1	xx C0
1	0	0	0	0	0	1	1	xx C1
0	1	0	0	0	0	1	1	xx C2
1	1	0	0	0	0	1	1	xx C3
0	0	1	0	0	0	1	1	xx C4
1	0	1	0	0	0	1	1	xx C5
0	1	1	0	0	0	1	1	xx C6
1	1	1	0	0	0	1	1	xx C7
0	0	0	1	0	0	1	1	xx C8
1	0	0	1	0	0	1	1	xx C9
0	1	0	1	0	0	1	1	xx CA
1	1	0	1	0	0	1	1	xx CB
0	0	1	1	0	0	1	1	xx CC
1	0	1	1	0	0	1	1	xx CD
0	1	1	1	0	0	1	1	xx CE
1	1	1	1	0	0	1	1	xx CF
0	0	0	0	1	0	1	1	xx D0
1	0	0	0	1	0	1	1	xx D1
0	1	0	0	1	0	1	1	xx D2
1	1	0	0	1	0	1	1	xx D3
0	0	1	0	1	0	1	1	xx D4
1	0	1	0	1	0	1	1	xx D5
0	1	1	0	1	0	1	1	xx D6
1	1	1	0	1	0	1	1	xx D7
0	0	0	1	1	0	1	1	xx D8
1	0	0	1	1	0	1	1	xx D9
0	1	0	1	1	0	1	1	xx DA
1	1	0	1	1	0	1	1	xx DB
0	0	1	1	1	0	1	1	xx DC
1	0	1	1	1	0	1	1	xx DD
0	1	1	1	1	0	1	1	xx DE
1	1	1	1	1	0	1	1	xx DF
0	0	0	0	0	1	1	1	xx E0
1	0	0	0	0	1	1	1	xx E1
0	1	0	0	0	1	1	1	xx E2
1	1	0	0	0	1	1	1	xx E3
0	0	1	0	0	1	1	1	xx E4
1	0	1	0	0	1	1	1	xx E5
0	1	1	0	0	1	1	1	xx E6
1	1	1	0	0	1	1	1	xx E7
0	0	0	1	0	1	1	1	xx E8
1	0	0	1	0	1	1	1	xx E9
0	1	0	1	0	1	1	1	xx EA
1	1	0	1	0	1	1	1	xx EB
0	0	1	1	0	1	1	1	xx EC
1	0	1	1	0	1	1	1	xx ED
0	1	1	1	0	1	1	1	xx EE
1	1	1	1	0	1	1	1	xx EF
0	0	0	0	1	1	1	1	xx F0
1	0	0	0	1	1	1	1	xx F1
0	1	0	0	1	1	1	1	xx F2
1	1	0	0	1	1	1	1	xx F3
0	0	1	0	1	1	1	1	xx F4
1	0	1	0	1	1	1	1	xx F5
0	1	1	0	1	1	1	1	xx F6
1	1	1	0	1	1	1	1	xx F7
0	0	0	1	1	1	1	1	xx F8
1	0	0	1	1	1	1	1	xx F9
0	1	0	1	1	1	1	1	xx FA
1	1	0	1	1	1	1	1	xx FB
0	0	1	1	1	1	1	1	xx FC
1	0	1	1	1	1	1	1	xx FD
0	1	1	1	1	1	1	1	xx FE
1	1	1	1	1	1	1	1	xx FF

**Output signal display (Request code: 175/553)**

Please refer to Table 2 on relevant wiring diagram whilst using the following.

0: OFF 1: ON

OUT								Display
8 *	9	10	11	12	13	14	15	
0	0	0	0	0	0	0	0	00 xx
1	0	0	0	0	0	0	0	01 xx
0	1	0	0	0	0	0	0	02 xx
1	1	0	0	0	0	0	0	03 xx
0	0	1	0	0	0	0	0	04 xx
1	0	1	0	0	0	0	0	05 xx
0	1	1	0	0	0	0	0	06 xx
1	1	1	0	0	0	0	0	07 xx
0	0	0	1	0	0	0	0	08 xx
1	0	0	1	0	0	0	0	09 xx
0	1	0	1	0	0	0	0	0A xx
1	1	0	1	0	0	0	0	0B xx
0	0	1	1	0	0	0	0	0C xx
1	0	1	1	0	0	0	0	0D xx
0	1	1	1	0	0	0	0	0E xx
1	1	1	1	0	0	0	0	0F xx
0	0	0	0	1	0	0	0	10 xx
1	0	0	0	1	0	0	0	11 xx
0	1	0	0	1	0	0	0	12 xx
1	1	0	0	1	0	0	0	13 xx
0	0	1	0	1	0	0	0	14 xx
1	0	1	0	1	0	0	0	15 xx
0	1	1	0	1	0	0	0	16 xx
1	1	1	0	1	0	0	0	17 xx
0	0	0	1	1	0	0	0	18 xx
1	0	0	1	1	0	0	0	19 xx
0	1	0	1	1	0	0	0	1A xx
1	1	0	1	1	0	0	0	1B xx
0	0	1	1	1	0	0	0	1C xx
1	0	1	1	1	0	0	0	1D xx
0	1	1	1	1	0	0	0	1E xx
1	1	1	1	1	0	0	0	1F xx
0	0	0	0	0	1	0	0	20 xx
1	0	0	0	0	1	0	0	21 xx
0	1	0	0	0	1	0	0	22 xx
1	1	0	0	0	1	0	0	23 xx
0	0	1	0	0	1	0	0	24 xx
1	0	1	0	0	1	0	0	25 xx
0	1	1	0	0	1	0	0	26 xx
1	1	1	0	0	1	0	0	27 xx
0	0	0	1	0	1	0	0	28 xx
1	0	0	1	0	1	0	0	29 xx
0	1	0	1	0	1	0	0	2A xx
1	1	0	1	0	1	0	0	2B xx
0	0	1	1	0	1	0	0	2C xx
1	0	1	1	0	1	0	0	2D xx
0	1	1	1	0	1	0	0	2E xx
1	1	1	1	0	1	0	0	2F xx
0	0	0	0	1	1	0	0	30 xx
1	0	0	0	1	1	0	0	31 xx
0	1	0	0	1	1	0	0	32 xx
1	1	0	0	1	1	0	0	33 xx
0	0	1	0	1	1	0	0	34 xx
1	0	1	0	1	1	0	0	35 xx
0	1	1	0	1	1	0	0	36 xx
1	1	1	0	1	1	0	0	37 xx
0	0	0	1	1	1	0	0	38 xx
1	0	0	1	1	1	0	0	39 xx
0	1	0	1	1	1	0	0	3A xx
1	1	0	1	1	1	0	0	3B xx
0	0	1	1	1	1	0	0	3C xx
1	0	1	1	1	1	0	0	3D xx
0	1	1	1	1	1	0	0	3E xx
1	1	1	1	1	1	0	0	3F xx

\* Displayed only when the request code is 553.

0: OFF 1: ON

OUT								Display
8	9	10	11	12	13	14	15	
0	0	0	0	0	0	1	0	40 xx
1	0	0	0	0	0	1	0	41 xx
0	1	0	0	0	0	1	0	42 xx
1	1	0	0	0	0	1	0	43 xx
0	0	1	0	0	0	1	0	44 xx
1	0	1	0	0	0	1	0	45 xx
0	1	1	0	0	0	1	0	46 xx
1	1	1	0	0	0	1	0	47 xx
0	0	0	1	0	0	1	0	48 xx
1	0	0	1	0	0	1	0	49 xx
0	1	0	1	0	0	1	0	4A xx
1	1	0	1	0	0	1	0	4B xx
0	0	1	1	0	0	1	0	4C xx
1	0	1	1	0	0	1	0	4D xx
0	1	1	1	0	0	1	0	4E xx
1	1	1	1	0	0	1	0	4F xx
0	0	0	0	1	0	1	0	50 xx
1	0	0	0	1	0	1	0	51 xx
0	1	0	0	1	0	1	0	52 xx
1	1	0	0	1	0	1	0	53 xx
0	0	1	0	1	0	1	0	54 xx
1	0	1	0	1	0	1	0	55 xx
0	1	1	0	1	0	1	0	56 xx
1	1	1	0	1	0	1	0	57 xx
0	0	0	1	1	0	1	0	58 xx
1	0	0	1	1	0	1	0	59 xx
0	1	0	1	1	0	1	0	5A xx
1	1	0	1	1	0	1	0	5B xx
0	0	1	1	1	0	1	0	5C xx
1	0	1	1	1	0	1	0	5D xx
0	1	1	1	1	0	1	0	5E xx
1	1	1	1	1	0	1	0	5F xx
0	0	0	0	0	1	1	0	60 xx
1	0	0	0	0	1	1	0	61 xx
0	1	0	0	0	1	1	0	62 xx
1	1	0	0	0	1	1	0	63 xx
0	0	1	0	0	1	1	0	64 xx
1	0	1	0	0	1	1	0	65 xx
0	1	1	0	0	1	1	0	66 xx
1	1	1	0	0	1	1	0	67 xx
0	0	0	1	0	1	1	0	68 xx
1	0	0	1	0	1	1	0	69 xx
0	1	0	1	0	1	1	0	6A xx
1	1	0	1	0	1	1	0	6B xx
0	0	1	1	0	1	1	0	6C xx
1	0	1	1	0	1	1	0	6D xx
0	1	1	1	0	1	1	0	6E xx
1	1	1	1	0	1	1	0	6F xx
0	0	0	0	1	1	1	0	70 xx
1	0	0	0	1	1	1	0	71 xx
0	1	0	0	1	1	1	0	72 xx
1	1	0	0	1	1	1	0	73 xx
0	0	1	0	1	1	1	0	74 xx
1	0	1	0	1	1	1	0	75 xx
0	1	1	0	1	1	1	0	76 xx
1	1	1	0	1	1	1	0	77 xx
0	0	0	1	1	1	1	0	78 xx
1	0	0	1	1	1	1	0	79 xx
0	1	0	1	1	1	1	0	7A xx
1	1	0	1	1	1	1	0	7B xx
0	0	1	1	1	1	1	0	7C xx
1	0	1	1	1	1	1	0	7D xx
0	1	1	1	1	1	1	0	7E xx
1	1	1	1	1	1	1	0	7F xx

**Mixing valve state**

OUT		Mixing valve state
5A	5B	
0	0	Stop
0	1	Stop
1	0	Open
1	1	Close

**Input signal display (Request code: 176/554)**

Please refer to Table 1 on relevant wiring diagram whilst using the following.

0: OFF (open)      1: ON (short)

IN								Display
1	2	3	4	5	6	7	8	
0	0	0	0	0	0	0	0	00 00
1	0	0	0	0	0	0	0	00 01
0	1	0	0	0	0	0	0	00 02
1	1	0	0	0	0	0	0	00 03
0	0	1	0	0	0	0	0	00 04
1	0	1	0	0	0	0	0	00 05
0	1	1	0	0	0	0	0	00 06
1	1	1	0	0	0	0	0	00 07
0	0	0	1	0	0	0	0	00 08
1	0	0	1	0	0	0	0	00 09
0	1	0	1	0	0	0	0	00 0A
1	1	0	1	0	0	0	0	00 0B
0	0	1	1	0	0	0	0	00 0C
1	0	1	1	0	0	0	0	00 0D
0	1	1	1	0	0	0	0	00 0E
1	1	1	1	0	0	0	0	00 0F
0	0	0	0	1	0	0	0	00 10
1	0	0	0	1	0	0	0	00 11
0	1	0	0	1	0	0	0	00 12
1	1	0	0	1	0	0	0	00 13
0	0	1	0	1	0	0	0	00 14
1	0	1	0	1	0	0	0	00 15
0	1	1	0	1	0	0	0	00 16
1	1	1	0	1	0	0	0	00 17
0	0	0	1	1	0	0	0	00 18
1	0	0	1	1	0	0	0	00 19
0	1	0	1	1	0	0	0	00 1A
1	1	0	1	1	0	0	0	00 1B
0	0	1	1	1	0	0	0	00 1C
1	0	1	1	1	0	0	0	00 1D
0	1	1	1	1	0	0	0	00 1E
1	1	1	1	1	0	0	0	00 1F
0	0	0	0	0	1	0	0	00 20
1	0	0	0	0	1	0	0	00 21
0	1	0	0	0	1	0	0	00 22
1	1	0	0	0	1	0	0	00 23
0	0	1	0	0	1	0	0	00 24
1	0	1	0	0	1	0	0	00 25
0	1	1	0	0	1	0	0	00 26
1	1	1	0	0	1	0	0	00 27
0	0	0	1	0	1	0	0	00 28
1	0	0	1	0	1	0	0	00 29
0	1	0	1	0	1	0	0	00 2A
1	1	0	1	0	1	0	0	00 2B
0	0	1	1	0	1	0	0	00 2C
1	0	1	1	0	1	0	0	00 2D
0	1	1	1	0	1	0	0	00 2E
1	1	1	1	0	1	0	0	00 2F
0	0	0	0	1	1	0	0	00 30
1	0	0	0	1	1	0	0	00 31
0	1	0	0	1	1	0	0	00 32
1	1	0	0	1	1	0	0	00 33
0	0	1	0	1	1	0	0	00 34
1	0	1	0	1	1	0	0	00 35
0	1	1	0	1	1	0	0	00 36
1	1	1	0	1	1	0	0	00 37
0	0	0	1	1	1	0	0	00 38
1	0	0	1	1	1	0	0	00 39
0	1	0	1	1	1	0	0	00 3A
1	1	0	1	1	1	0	0	00 3B
0	0	1	1	1	1	0	0	00 3C
1	0	1	1	1	1	0	0	00 3D
0	1	1	1	1	1	0	0	00 3E
1	1	1	1	1	1	0	0	00 3F

0: OFF (open)      1: ON (short)

IN								Display
1	2	3	4	5	6	7	8	
0	0	0	0	0	0	1	0	00 40
1	0	0	0	0	0	1	0	00 41
0	1	0	0	0	0	1	0	00 42
1	1	0	0	0	0	1	0	00 43
0	0	1	0	0	0	1	0	00 44
1	0	1	0	0	0	1	0	00 45
0	1	1	0	0	0	1	0	00 46
1	1	1	0	0	0	1	0	00 47
0	0	0	1	0	0	1	0	00 48
1	0	0	1	0	0	1	0	00 49
0	1	0	1	0	0	1	0	00 4A
1	1	0	1	0	0	1	0	00 4B
0	0	1	1	0	0	1	0	00 4C
1	0	1	1	0	0	1	0	00 4D
0	1	1	1	0	0	1	0	00 4E
1	1	1	1	0	0	1	0	00 4F
0	0	0	0	1	0	1	0	00 50
1	0	0	0	1	0	1	0	00 51
0	1	0	0	1	0	1	0	00 52
1	1	0	0	1	0	1	0	00 53
0	0	1	0	1	0	1	0	00 54
1	0	1	0	1	0	1	0	00 55
0	1	1	0	1	0	1	0	00 56
1	1	1	0	1	0	1	0	00 57
0	0	0	1	1	0	1	0	00 58
1	0	0	1	1	0	1	0	00 59
0	1	0	1	1	0	1	0	00 5A
1	1	0	1	1	0	1	0	00 5B
0	0	1	1	1	0	1	0	00 5C
1	0	1	1	1	0	1	0	00 5D
0	1	1	1	1	0	1	0	00 5E
1	1	1	1	1	0	1	0	00 5F
0	0	0	0	0	1	1	0	00 60
1	0	0	0	0	1	1	0	00 61
0	1	0	0	0	1	1	0	00 62
1	1	0	0	0	1	1	0	00 63
0	0	1	0	0	1	1	0	00 64
1	0	1	0	0	1	1	0	00 65
0	1	1	0	0	1	1	0	00 66
1	1	1	0	0	1	1	0	00 67
0	0	0	1	0	1	1	0	00 68
1	0	0	1	0	1	1	0	00 69
0	1	0	1	0	1	1	0	00 6A
1	1	0	1	0	1	1	0	00 6B
0	0	1	1	0	1	1	0	00 6C
1	0	1	1	0	1	1	0	00 6D
0	1	1	1	0	1	1	0	00 6E
1	1	1	1	0	1	1	0	00 6F
0	0	0	0	1	1	1	0	00 70
1	0	0	0	1	1	1	0	00 71
0	1	0	0	1	1	1	0	00 72
1	1	0	0	1	1	1	0	00 73
0	0	1	0	1	1	1	0	00 74
1	0	1	0	1	1	1	0	00 75
0	1	1	0	1	1	1	0	00 76
1	1	1	0	1	1	1	0	00 77
0	0	0	1	1	1	1	0	00 78
1	0	0	1	1	1	1	0	00 79
0	1	0	1	1	1	1	0	00 7A
1	1	0	1	1	1	1	0	00 7B
0	0	1	1	1	1	1	0	00 7C
1	0	1	1	1	1	1	0	00 7D
0	1	1	1	1	1	1	0	00 7E
1	1	1	1	1	1	1	0	00 7F

## ■ Indoor unit only operation

In indoor unit only operation, an operation without connecting outdoor unit is possible.  
When in Indoor unit only operation, the main control has control functions.

### <Heater>

Heating for DHW and space heating is provided by the heater.

- Activating indoor unit only operation mode

To activate indoor unit only operation see the following:

1. Switch OFF the breaker for the outdoor unit (or both breakers if cylinder powered independently).
2. Change DIP switch SW4-4 and SW4-5 to ON.
3. Switch ON the breaker(s).
4. Indoor unit only operation is now activated.

- Deactivating indoor unit only operation mode

To deactivate indoor unit only operation see the following:

1. Switch OFF the breaker for the outdoor unit (or both breakers if cylinder powered independently).
2. Change DIP switch SW4-4 and SW4-5 to OFF.
3. Switch ON the breaker(s).
4. Indoor unit only operation is now deactivated.

### <Boiler>

Heating for space heating is provided by the boiler.

- Activating indoor unit only operation mode

To activate indoor unit only operation see the following:

1. Switch OFF the breaker for the outdoor unit (or both breakers if cylinder powered independently).
2. Change DIP switch SW4-4 and SW4-6 to ON.
3. Switch ON the breaker(s).
4. Indoor unit only operation is now activated.

- Deactivating indoor unit only operation mode

To deactivate indoor unit only operation see the following:

1. Switch OFF the breaker for the outdoor unit (or both breakers if cylinder powered independently).
2. Change DIP switch SW4-4 and SW4-6 to OFF.
3. Switch ON the breaker(s).
4. Indoor unit only operation is now deactivated.

## ■ Emergency operation

In emergency operation, an operation without connecting outdoor unit and main remote controller is possible.

When in Emergency operation, the main control has NO control functions.

Space heating flow temp. is restarted 40°C and DHW tank temp. is restricted 50°C. \*1

### <Heater>

Heating for DHW and space heating is provided by the heater.

- Activating emergency operation mode

To activate emergency operation see the following:

1. Switch OFF the breaker for the outdoor unit (or both breakers if cylinder powered independently).
2. Change DIP switch SW4-5 to ON.
3. Switch ON the breaker(s).
4. Emergency operation is now activated.

- Deactivating emergency operation mode

To deactivate emergency operation see the following:

1. Switch OFF the breaker for the outdoor unit (or both breakers if cylinder powered independently).
2. Change DIP switch SW4-5 to OFF.
3. Switch ON the breaker(s).
4. Emergency operation is now deactivated.

### <Boiler>

Heating for space heating is provided by the boiler.

- Activating emergency operation mode

To activate emergency operation see the following:

1. Switch OFF the breaker for the outdoor unit (or both breakers if cylinder powered independently).
2. Change DIP switch SW4-6 to ON.
3. Switch ON the breaker(s).
4. Emergency operation is now activated.

- Deactivating emergency operation mode

To deactivate emergency operation see the following:

1. Switch OFF the breaker for the outdoor unit (or both breakers if cylinder powered independently).
2. Change DIP switch SW4-6 to OFF.
3. Switch ON the breaker(s).
4. Emergency operation is now deactivated.

### ⚠ WARNING

Do not attempt to change the DIP switches whilst the breaker(s) are ON as this could result in electric shock.

	Indoor unit only operation
Indoor unit	Necessary
Heat pump	Not necessary
Main remote controller	Necessary
DIP switch setting	Electric heater SW4-4 ON, SW4-5 ON
	Boiler SW4-4 ON, SW4-6 ON
Setting range for flow temp.	20 to 60°C Selectable
Setting range for tank temp.	40 to 60°C Selectable

	Emergency operation
Indoor unit	Necessary
Heat pump	Not necessary
Main remote controller	Not necessary
DIP switch setting	Electric heater SW4-5 ON
	Boiler SW4-6 ON
Setting range for flow temp.	Fixed at 40°C
Setting range for tank temp.	Fixed at 50°C *1

\*1 Default setting is 50°C. Once system has started running, emergency operation runs at the latest set temp.

**10-1. Troubleshooting**

**<Summary of self-diagnosis based on Check codes and Service Procedures>**

Present and past Check codes are logged, and they can be displayed on the main remote controller or control board of the outdoor unit. Please refer to the table below and subsequent explanations to diagnose and remedy typical problems that may occur in the field.

Unit Condition	Check code	Action
Reoccurring problem	Displayed	Use table "10-4. Self-diagnosis and action" to identify fault and correct.
	Not Displayed	Use table "10-5. Troubleshooting by inferior phenomena" to identify fault and correct.
Non reoccurring problem	Logged	1. Check temporary causes of defects such as the operation of safety devices on the refrigerant/water circuit including compressor, poor wiring, electrical noise, etc. Re-check the symptom and the installation environment, refrigerant amount (Split systems only), weather conditions at time of fault, etc. 2. Reset Check code logs, Service the unit and restart system.
	Not Logged	1. Recheck the abnormal symptom.
		2. Identify cause of problem and take corrective action according to Table "10-5. Troubleshooting by inferior phenomena". 3. If no obvious problem can be found, continue to operate the unit.

**Note:**  
Electrical components should only be replaced as a final option. Please follow instructions in "10-4. Self-diagnosis and action" and "10-5. Troubleshooting by inferior phenomena" fully before resorting to replacing parts.

**10-2. Test Run**

Before a test run

- After installation of outdoor unit, pipework and electrical wiring, recheck that there is no water leakage, loosened connections or miswiring.
- Measure impedance between the ground and the power supply terminal block (L,N) on the outdoor and indoor units with suitable (500V) ohmmeter. Resistance should be  $\geq 1.0M\Omega$ .
- Read the Installation and Operation Manuals fully especially the safety requirements before carrying out any test runs.

**10-3. Malfunction diagnosis method by main remote controller**

If during start up or operation a malfunction occurs, the check code screen may be displayed on the main remote controller. The check code screen shows the following; code, unit, ref. address, and telephone number of installer (only if previously entered by the installer) Please note in the case of some malfunctions an check code is not generated please refer to table "10-5. Troubleshooting by inferior phenomena" for more details.

To reset

1. To reset the main remote controller press F4 button (Reset).
2. Then press F3 (Yes) to confirm.

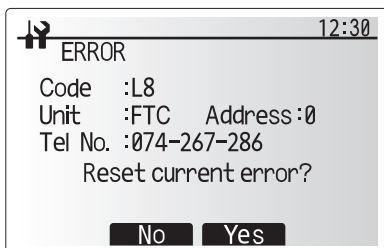
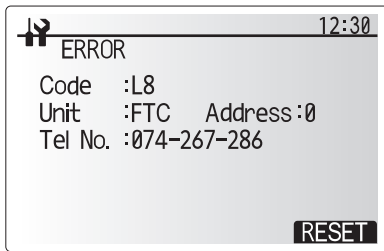

## 10-4. Self-diagnosis and action

Check if DIP SW is set correctly. (Refer to "6-9. DIP switch functions".)

Check code	Title and display conditions	Possible Cause	Diagnosis and action
L3	<p><b>Circulation water temperature overheat protection</b> &lt;DHW/Heating/Cooling/LP/FS/OS&gt; Check code displayed when THW1 detects a temp. <math>\geq 80^{\circ}\text{C}</math> for 10 consecutive seconds or THW2 detects a temp. <math>\geq 80^{\circ}\text{C}</math> for 10 consecutive seconds.</p> <p>DHW: Domestic hot water mode Heating: Heating mode Cooling: Cooling mode LP: Legionella prevention mode FS: Freeze stat OS: Operation stop TH1A/B: Room temp. thermistor TH2: Liquid refrigerant temp. thermistor THW1: Flow water temp. thermistor THW2: Return water temp. thermistor THW5B: DHW tank lower water temp. thermistor THW6: Zone1 flow water temperature thermistor THW7: Zone1 return water temperature thermistor THW8: Zone2 flow water temperature thermistor THW9: Zone2 return water temperature thermistor THWB1: Boiler flow water temperature thermistor</p>	<ol style="list-style-type: none"> <li>Insufficient system head</li> <li>Reduced flow in primary water circuit Due to 1 or more of the following; Faulty pump, insufficient air purge, blocked strainer, leak in water circuit.</li> <li>Valve operation fault</li> <li>2-way valve (local supply) actuator fault</li> <li>3-way valve actuator fault</li> <li>Booster heater relay (BHC1, BHC2, BHCP) operating fault</li> <li>Power supply voltage increase</li> <li>THW1 or THW5 has become detached from its holder.</li> <li>THW1 or THW2 fault</li> <li>FTC board failure</li> </ol>	<ol style="list-style-type: none"> <li>Refer to table in "10-6. Checking Component Parts' Function" to determine if system pump meets requirements. If more head required either add a pump of the same size or replace existing pump with capacity model. See "11. DISASSEMBLY PROCEDURE" for how to replace pump.</li> <li>Check circulation pump (See "10-6. Checking Component Parts' Function" for how to check). Open purge valve to remove trapped air. Check the strainer for blockages. Check the primary water circuit for leaks. Check that the flow amount is within the recommended range.</li> <li>Check valves on primary water circuit are installed level.</li> <li>Electrically test to determine fault</li> <li>1) Electrically test to determine fault. 2) Operate 3-way valve manually using the main remote controller. (Refer to &lt;Manual operation&gt; in "9-5. Service menu".) 3) Replace 3-way valve coil. 4) Replace 3-way valve. (Refer to Procedure 6 in "11. DISASSEMBLY PROCEDURE."</li> <li>Electrically test the relays (BHC1, BHC2, BHCP) to determine fault. See "10-6. Checking Component Parts' Function" for how to check.</li> <li>Check the supply voltage.</li> <li>Visually inspect location and reattach as necessary.</li> <li>Check resistance of thermistor against table in "10-6. Checking Component Parts' Function". Compare FTC detected temperature to hand held detector.</li> <li>Replace board.</li> </ol>
L4	<p><b>Tank water temperature overheat protection</b> &lt;DHW/Heating/Cooling/LP/FS/OS&gt; Check code display when THW5B detects a temp. <math>\geq 75^{\circ}\text{C}</math> for 10 consecutive seconds.</p>	<ol style="list-style-type: none"> <li>3-way valve actuator fault</li> <li>Immersion heater relay (IHC) operating fault</li> <li>THW5B fault</li> <li>FTC board failure</li> </ol>	<ol style="list-style-type: none"> <li>1) Electrically test to determine fault. 2) Operate 3-way valve manually using the main remote controller. (Refer to &lt;Manual operation&gt; in "9-5. Service menu".) 3) Replace 3-way valve coil. 4) Replace 3-way valve. (Refer to Procedure 6 in "11. DISASSEMBLY PROCEDURE."</li> <li>Check immersion heater relay (IHC).</li> <li>Check resistance of thermistor against table in "10-6. Checking Component Parts' Function". Compare FTC detected temperature to hand held detector.</li> <li>Replace board.</li> </ol>



Check code	Title and display conditions	Possible Cause	Diagnosis and action																																																			
P1/P2/L5/LD	<p><b>Indoor unit temperature thermistor failure</b>            Note: The thermistors subject to failure can be checked in "Request code: 567" in "Running information."</p> <p>&lt;DHW/Heating/Cooling/LP/FS/OS&gt;            Check code displayed when thermistor is at open or short (see table).</p> <p><u>Exceptions</u>            Check code will not be displayed for TH2; During defrost and for 10 minutes after defrost operation.</p>	<ol style="list-style-type: none"> <li>Connector/terminal wire has become detached or loose wiring.</li> <li>Thermistor fault</li> <li>FTC board failure</li> <li>The thermistor on the wireless remote controller or the main remote controller may be defective. (when Room temp. is chosen for the Heating operation and when Main remote controller or Room RC 1-8 is chosen for the Room Sensor setting in the Initial setting)</li> <li>Incorrect setting of the DIP switch(es)</li> </ol>	<ol style="list-style-type: none"> <li>Visually check the terminals and connections and reattaches appropriate.</li> <li>Check resistance of thermistor against table in "10-6. Checking Component Parts' Function". Compare FTC detected temperature to hand held detector.</li> <li>Replace board.</li> <li>Replace wireless remote controller or main remote controller.</li> <li>Check the DIP switch setting(s).</li> </ol>																																																			
	<table border="1"> <thead> <tr> <th rowspan="2">Check code</th> <th colspan="2">Thermistor</th> <th rowspan="2">Open detection</th> <th rowspan="2">Short detection</th> </tr> <tr> <th>Symbol</th> <th>Name</th> </tr> </thead> <tbody> <tr> <td>P1</td> <td>TH1A/TH1B</td> <td>Room temperature thermistor</td> <td>-39°C or below</td> <td>88.5°C or above</td> </tr> <tr> <td>P2</td> <td>TH2</td> <td>Liquid temperature thermistor</td> <td>-39°C or below</td> <td>88.5°C or above</td> </tr> <tr> <td rowspan="7">L5</td> <td>THW1</td> <td>Flow water temperature thermistor</td> <td>-39°C or below</td> <td>88.5°C or above</td> </tr> <tr> <td>THW2</td> <td>Return water temperature thermistor</td> <td>-39°C or below</td> <td>88.5°C or above</td> </tr> <tr> <td>THW5B</td> <td>DHW tank water temperature thermistor</td> <td>-39°C or below</td> <td>88.5°C or above</td> </tr> <tr> <td>THW6</td> <td>Zone1 flow water temperature thermistor</td> <td>-39°C or below</td> <td>88.5°C or above</td> </tr> <tr> <td>THW7</td> <td>Zone1 return water temperature thermistor</td> <td>-39°C or below</td> <td>88.5°C or above</td> </tr> <tr> <td>THW8</td> <td>Zone2 flow water temperature thermistor</td> <td>-39°C or below</td> <td>88.5°C or above</td> </tr> <tr> <td>THW9</td> <td>Zone2 return water temperature thermistor</td> <td>-39°C or below</td> <td>88.5°C or above</td> </tr> <tr> <td>LD</td> <td>THWB1</td> <td>Boiler flow water temperature thermistor</td> <td>-40°C or below</td> <td>140°C or above</td> </tr> </tbody> </table>	Check code	Thermistor		Open detection	Short detection	Symbol	Name	P1	TH1A/TH1B	Room temperature thermistor	-39°C or below	88.5°C or above	P2	TH2	Liquid temperature thermistor	-39°C or below	88.5°C or above	L5	THW1	Flow water temperature thermistor	-39°C or below	88.5°C or above	THW2	Return water temperature thermistor	-39°C or below	88.5°C or above	THW5B	DHW tank water temperature thermistor	-39°C or below	88.5°C or above	THW6	Zone1 flow water temperature thermistor	-39°C or below	88.5°C or above	THW7	Zone1 return water temperature thermistor	-39°C or below	88.5°C or above	THW8	Zone2 flow water temperature thermistor	-39°C or below	88.5°C or above	THW9	Zone2 return water temperature thermistor	-39°C or below	88.5°C or above	LD	THWB1	Boiler flow water temperature thermistor	-40°C or below	140°C or above		
Check code	Thermistor		Open detection	Short detection																																																		
	Symbol	Name																																																				
P1	TH1A/TH1B	Room temperature thermistor	-39°C or below	88.5°C or above																																																		
P2	TH2	Liquid temperature thermistor	-39°C or below	88.5°C or above																																																		
L5	THW1	Flow water temperature thermistor	-39°C or below	88.5°C or above																																																		
	THW2	Return water temperature thermistor	-39°C or below	88.5°C or above																																																		
	THW5B	DHW tank water temperature thermistor	-39°C or below	88.5°C or above																																																		
	THW6	Zone1 flow water temperature thermistor	-39°C or below	88.5°C or above																																																		
	THW7	Zone1 return water temperature thermistor	-39°C or below	88.5°C or above																																																		
	THW8	Zone2 flow water temperature thermistor	-39°C or below	88.5°C or above																																																		
	THW9	Zone2 return water temperature thermistor	-39°C or below	88.5°C or above																																																		
LD	THWB1	Boiler flow water temperature thermistor	-40°C or below	140°C or above																																																		
L6	<p><b>Circulation water freeze protection</b>            &lt;DHW/Heating/Cooling/LP/FS/OS&gt;            Check code displayed when THW1 detects a temp. ≤ 1°C for 10 consecutive seconds or THW2 detects a temp. ≤ 3°C for 10 consecutive seconds.</p> <p><u>Exception</u>            Check code will not be displayed if; FS function is disabled, For 10 minutes after water circulation pump1 is switched on.</p>	<ol style="list-style-type: none"> <li>Insufficient system head</li> <li>Reduced flow in primary water circuit            Due to 1 or more of the following;            Faulty pump, insufficient air purge, blocked strainer, leak in water circuit</li> <li>Valve operation fault</li> <li>2-way valve (local supply) actuator fault</li> <li>3-way valve actuator fault</li> <li>THW1 has become detached from its holder.</li> <li>THW1 or THW2 fault</li> <li>FTC board failure</li> </ol>	<ol style="list-style-type: none"> <li>Refer to table in "10-6. Checking Component Parts' Function" to determine if system pump meets requirements. If more head required either add a pump of the same size or replace existing pump with capacity model. See "11. DISASSEMBLY PROCEDURE" for how to replace pump.</li> <li>Check circulation pump (See "10-6. Checking Component Parts' Function" for how to check).            Open purge valve to remove trapped air. Check the strainer for blockages. Check the primary water circuit for leaks. Check that the flow amount is within the recommended range.</li> <li>Check valves on primary water circuit are installed level.</li> <li>Electrically test to determine fault.</li> <li>1) Electrically test to determine fault.            2) Operate 3-way valve manually using the main remote controller. (Refer to &lt;Manual operation&gt; in "9-5. Service menu".)            3) Replace 3-way valve coil.            4) Replace 3-way valve. (Refer to Procedure 6 in "11. DISASSEMBLY PROCEDURE".)</li> <li>Visually inspect location and reattach as necessary.</li> <li>Check resistance of thermistor against table in "10-6. Checking Component Parts' Function". Compare FTC detected temperature to hand held detector.</li> <li>Replace board.</li> </ol>																																																			



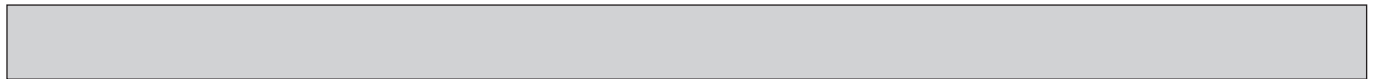

Check code	Title and display conditions	Possible Cause	Diagnosis and action
L8	<p><b>Heating operation error</b> Note: "3" is displayed in "Request code: 567" in "Running information". &lt;Heating/FS&gt; If a), b) and c) occur, L8 is displayed; a) No change on THW1 and THW5B (under 1°C for 20 minutes from unit starts operation) b) No change on THW1 (under 1°C for 10 minutes from booster heater starts operation) c) THW1-THW2 &lt; -5°C (for 10 minutes continuously)</p>	<ol style="list-style-type: none"> <li>THW1 has become detached from its holder.</li> <li>Booster heater fault</li> <li>THW1 or THW2 or THW5B fault</li> <li>FTC board failure</li> </ol>	<ol style="list-style-type: none"> <li>Visually inspect location and reattach as necessary.</li> <li>Electrically test to determine fault. See "10-6. Checking Component Parts' Function" for how to check.</li> <li>Check resistance of thermistor against table in "10-6. Checking Component Parts' Function". Compare FTC detected temperature to hand held detector.</li> <li>Replace board.</li> </ol>
	<p><b>Heating operation error</b> Note: "A" is displayed in "Request code: 567" in "Running information".</p>	<ol style="list-style-type: none"> <li>THW6 has become detached from its holder.</li> <li>THW6 or THW7 fault</li> <li>FTC board failure</li> </ol>	<ol style="list-style-type: none"> <li>Visually inspect location and reattach as necessary.</li> <li>Check resistance of thermistor against table in "10-6. Checking Component Parts' Function". Compare FTC detected temperature to hand held detector.</li> <li>Replace board.</li> </ol>
	<p><b>Heating operation error</b> Note: "C" is displayed in "Request code: 567" in "Running information".</p>	<ol style="list-style-type: none"> <li>THW8 has become detached from its holder.</li> <li>THW8 or THW9 fault</li> <li>FTC board failure</li> </ol>	<ol style="list-style-type: none"> <li>Visually inspect location and reattach as necessary.</li> <li>Check resistance of thermistor against table in "10-6. Checking Component Parts' Function" Compare FTC detected temperature to hand held detector.</li> <li>Replace board.</li> </ol>
L9	<p><b>Low primary circuit (Heat source side) flow rate detected by flow sensor</b> Note: "1" is displayed in "Request code: 569" in "Running information". &lt;DHW/Heating/LP/FS&gt; Check code displayed when flow sensor detects low flow rate for 10 seconds.  <u>Exception</u> For 1 minute after water circulation pump1 is switched on.</p>	<ol style="list-style-type: none"> <li>Insufficient system head</li> <li>Reduced flow in primary water circuit Due to 1 or more of the following; Faulty pump, insufficient air purge, blocked strainer, leak in water circuit.</li> <li>Valve operation fault</li> <li>2-way valve (local supply) actuator fault</li> <li>Connector/terminal wire has become detached or loose wiring.</li> <li>Flow sensor fault</li> <li>Incorrect setting of the SW2-2</li> <li>FTC board failure</li> </ol>	<ol style="list-style-type: none"> <li>Refer to table in "10-6. Checking Component Parts' Function" to determine if system pump meets requirements. If more head required either add a pump of the same size or replace existing pump with capacity model. See "11. DISASSEMBLY PROCEDURE" for how to replace pump.</li> <li>Check circulation pump (See "10-6. Checking Component Parts' Function" for how to check). Open purge valve to remove trapped air. Check the strainer for blockages. Check the primary water circuit for leaks. Check that the flow amount is within the recommended range.</li> <li>Check valves on primary water circuit are installed level.</li> <li>Electrically test to determine fault.</li> <li>Visually check the CN1A connector and IN2 terminal and reattach if necessary.</li> <li>Electrically test to determine fault. See "10-6. Checking Component Parts' Function" for how to check.</li> <li>Check the SW2-2 setting.</li> <li>Replace board.</li> </ol>
	<p><b>Low primary circuit (Zone1 side) flow rate detected by flow switch</b> Note: "2" is displayed in "Request code: 569" in "Running information".</p>	<ol style="list-style-type: none"> <li>Insufficient system head</li> <li>Reduced flow in primary water circuit Due to 1 or more of the following; Faulty pump, insufficient air purge, blocked strainer, leak in water circuit.</li> <li>Terminal wire has become detached or loose wiring.</li> <li>Flow switch fault</li> <li>Incorrect setting of the SW3-2</li> <li>FTC board failure</li> </ol>	<ol style="list-style-type: none"> <li>If more head required either add a pump of the same size or replace existing pump .</li> <li>Check circulation pump (See "10-6. Checking Component Parts' Function" for how to check). Open purge valve to remove trapped air. Check the strainer for blockages. Check the primary water circuit for leaks. Check that the flow amount is within the recommended range.</li> <li>Visually check the IN3 terminal and reattach if necessary.</li> <li>Electrically test to determine fault</li> <li>Check the SW3-2 setting.</li> <li>Replace board.</li> </ol>

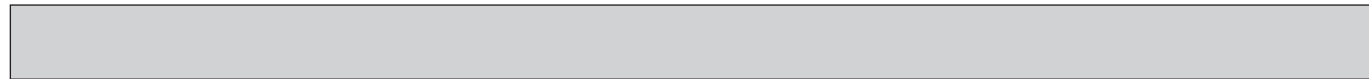

Check code	Title and display conditions	Possible Cause	Diagnosis and action
L9	<b>Low primary circuit (Zone2 side) flow rate detected by flow switch</b> Note: "3" is displayed in "Request code: 569" in "Running information".	<ol style="list-style-type: none"> <li>Insufficient system head</li> <li>Reduced flow in primary water circuit Due to 1 or more of the following; Faulty pump, insufficient air purge, blocked strainer, leak in water circuit</li> <li>Terminal wire has become detached or loose wiring.</li> <li>Flow switch fault</li> <li>Incorrect setting of the SW3-3</li> <li>FTC board failure</li> </ol>	<ol style="list-style-type: none"> <li>If more head required either add a pump of the same size or replace existing pump.</li> <li>Check circulation pump (See "10-6. Checking Component Parts' Function" for how to check). Open purge valve to remove trapped air. Check the strainer for blockages. Check the primary water circuit for leaks. Check that the flow amount is within the recommended range.</li> <li>Visually check the IN7 terminal and reattach if necessary.</li> <li>Electrically test to determine fault.</li> <li>Check the SW3-3 setting.</li> <li>Replace board.</li> </ol>
LA	Pressure sensor failure	<ol style="list-style-type: none"> <li>Connector/terminal wire has become detached or loose wiring.</li> <li>Pressure sensor fault</li> <li>FTC board failure</li> </ol>	<ol style="list-style-type: none"> <li>Check pressure sensor cable for damage or loose connections.</li> <li>Electrically test to determine fault. See "10-6. Checking Component Parts' Function" for how to check.</li> <li>Replace board.</li> </ol>
LB	High pressure protection	<ol style="list-style-type: none"> <li>Flow rate of the heating circuit may be reduced.</li> <li>Plate heat exchanger may be clogged.</li> <li>Outdoor unit failure.</li> </ol>	<ol style="list-style-type: none"> <li>Check water circuit.</li> <li>Check the plate heat exchanger.</li> <li>Check refrigerant volume, valve, LEV coil and pipe crushing of outdoor unit.</li> </ol>
LC	Boiler circulation water temperature overheat protection <DHW/Heating/LP/FS/OS> Check code displayed when THWB1 detects a temp. ≥80°C for 10 consecutive seconds or THWB2 detects a temp. ≥80°C for 10 consecutive seconds	<ol style="list-style-type: none"> <li>The set temperature for Boiler is too high.</li> <li>Flow rate of the heating circuit from the boiler may be reduced.</li> </ol>	<ol style="list-style-type: none"> <li>Check if the set temperature for Boiler for heating exceeds the restriction. (See the manual for the thermistors "PAC-TH011HT-E")</li> <li>Check for <ul style="list-style-type: none"> <li>water leakage</li> <li>strainer blockage</li> <li>water circulation pump function.</li> </ul> </li> </ol>
LD	Boiler temperature thermistor (THWB1, THWB2) failure	Refer to check codes (P1/P2/L5/LD).	
LE	Boiler operation error <Heating> Boiler is running and THW6 detects a temperature <30°C for consecutive 60 minutes.	<ol style="list-style-type: none"> <li>THW6 has become detached from its holder.</li> <li>Incorrect wiring between FTC (OUT10) and the boiler.</li> <li>Boiler fuel has run out or the system is OFF.</li> <li>Boiler failure</li> <li>FTC board failure</li> </ol>	<ol style="list-style-type: none"> <li>Visually inspect location and reattach as necessary.</li> <li>See the manual of the thermistors "PAC-TH011HT-E".</li> <li>Check the status of the boiler.</li> <li>Check the status of the boiler.</li> <li>Replace board.</li> </ol>
LF	Flow sensor failure	Disconnection or loose connection of flow sensor	Check flow sensor cable for damage or loose connections.
LH	Boiler circulation water freeze protection	Flow rate of the heating circuit from the boiler may be reduced.	Check for <ul style="list-style-type: none"> <li>water leakage</li> <li>strainer blockage</li> <li>water circulation pump function.</li> </ul>
LJ	DHW operation error (type of external plate HEX)	<ol style="list-style-type: none"> <li>DHW tank water temp. thermistor (THW5B) has become detached from its holder.</li> <li>Flow rate of the sanitary circuit may be reduced.</li> </ol>	<ol style="list-style-type: none"> <li>Check for disconnection of DHW tank water temp. thermistor (THW5B).</li> <li>Check for water circulation pump function.</li> </ol>
LL	Setting errors of DIP switches on FTC control board	Incorrect setting of DIP switches <ol style="list-style-type: none"> <li>Boiler operation</li> <li>2-zone temperature control</li> </ol>	<ol style="list-style-type: none"> <li>For boiler operation, check that DIP SW1-1 is set to ON (With Boiler) and DIP SW2-6 is set to ON (With Mixing Tank).</li> <li>For 2-zone temperature control, check DIP SW2-7 is set to ON (2-zone) and DIP SW2-6 is set to ON (With Mixing Tank).</li> </ol>
P1	Indoor unit temperature thermistor (TH1) failure	Refer to check codes (P1/P2/L5/LD).	
P2	Indoor unit temperature thermistor (TH2) failure	Refer to check codes (P1/P2/L5/LD).	
P6	Anti-freeze protection of plate heat exchanger <Cooling> The check code displayed when Ref. liquid temp. (TH2) stays at -5°C or lower for 10 seconds after compressor operates for 6 minutes.	<Cooling> <ol style="list-style-type: none"> <li>Reduced water flow <ul style="list-style-type: none"> <li>Clogged filter</li> <li>Leakage of water</li> </ul> </li> <li>Low temperature <ul style="list-style-type: none"> <li>Low load</li> <li>Inlet water is too cold.</li> </ul> </li> <li>Defective water pump</li> <li>Defective outdoor fan control.</li> <li>Overcharge of refrigerant</li> <li>Defective refrigerant circuit (clogs)</li> <li>Malfunction of linear expansion valve</li> </ol>	<ol style="list-style-type: none"> <li>Check water piping.</li> <li>Check water pump.</li> <li>Check outdoor fan motor.</li> <li>Check operating condition of refrigerant circuit.</li> <li>Check linear expansion valve.</li> </ol>

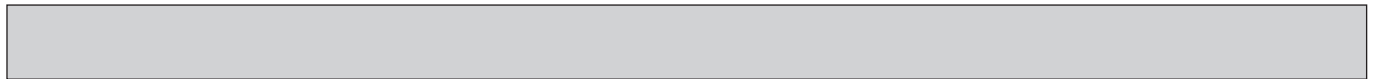

Check code	Title and display conditions	Possible Cause	Diagnosis and action
P6	<Defrosting> THW2 detects a temperature ≤15°C and TH2 detects a temperature ≤-16°C for consecutive 10 seconds.	<Defrosting> 1. Reduced water flow • Clogged filter • Leakage of water 2. Low temperature • Low load • Inlet water is cold. 3. Defective water pump 4. Leakage or shortage of refrigerant 5. Malfunction of linear expansion valve	1., 2. Check water piping.  3. Check water pump. 4. Correct to proper amount of refrigerant. 5. Check linear expansion valve.
E0/E4	<b>Main remote controller communication failure (Reception error)</b> Check code E0 is displayed if main remote controller does not receive any signal from the indoor unit for ref. address "0" for 3 minutes. Check code E4 is displayed if indoor unit does not receive any data from the main remote controller for 3 minutes or indoor unit does not receive any signal from the main remote controller for 2 minutes.	1. Contact failure with transmission cable  2. Wiring procedure not observed. (Cable length/cable diameter/number of indoor units/number of main remote controllers)  3. Fault on the indoor unit FTC board section controlling Ref. address "0"  4. Fault with the main remote controller circuit board  5. Electrical noise causes interference with transmission/reception of data for main remote controller.	1. Check connection cable for damage or loose connections at the FTC and main remote controller terminals. 2. Check main remote controller and FTC common wiring max cable length 500 m. Only use 2-core cable. Only connect 1 main remote controller to 1 FTC indoor unit board. 3. to 5. If the problem is not solved by the above measures then: Turn the power to the indoor unit OFF and then ON. Power to both the indoor unit and outdoor units should be switched OFF then ON. (This may require switching 1 or 2 breakers depending if the unit is powered independently from the outdoor unit). If the E4 code is still displayed the FTC and/or the main remote controller circuit board should be replaced.
E3/E5	<b>Main remote controller communication failure (Transmission error)</b> Check code E3 is displayed if the main remote controller cannot find an empty transmission path and thus fails to transmit for 6 seconds or the data received by the main remote controller is different to what was sent (by the main remote controller) 30 consecutive times.  Check code E5 is displayed if the FTC cannot find an empty transmission path for 3 minutes and thus cannot transmit or the data sent by the FTC is different to what was expected 30 consecutive times.	1. 2 or more main remote controllers have been connected to the FTC. 2. Fault with main remote controller transmission/receiving circuit board 3. Fault with the main remote controller circuit board 4. Electrical noise causes interference with transmission/reception of data for main remote controller.	1. Only connect 1 main remote controller to 1 FTC indoor unit board. 2. to 4. Turn the power to the indoor unit OFF and then ON. Power to both the indoor unit and outdoor units should be switched OFF then ON. (This may require switching 1 or 2 breakers depending if the unit is powered independently from the outdoor unit). If the E3/E5 code is still displayed the FTC and/or the main remote controller circuit board should be replaced.
E6	<b>Indoor/outdoor communication failure (Reception error)</b> Check code E6 is displayed if after the power is switched ON to the indoor unit, the FTC board does not receive any signal or the signal received is not complete for 6 minutes, or after a period of operation the FTC board does not receive any signal or the signal received is not complete for 3 minutes.	1. Contact failure/short circuit/miswiring  2. Fault with outdoor unit transmission/receiving circuit board 3. Fault with FTC transmission/receiving circuit board 4. Electrical noise causes interference with FTC-Outdoor unit transmission cable.	* Check the LED display on the outdoor unit circuit board. (Connect the A-control service tool, PAC-SK52ST to test.) Refer to the outdoor unit service manual for explanation of EA-EC codes. 1. Check the connections on the indoor and outdoor units have not become loose and that the connecting cable is not damaged. 2. to 4. Turn the power to the indoor unit OFF and then ON. Power to both the indoor unit and outdoor units should be switched OFF then ON. (This may require switching 1 or 2 breakers depending if the unit is powered independently from the outdoor unit). If the E6 code is still displayed the FTC and/or the outdoor unit circuit board should be replaced.
E7	<b>Indoor/outdoor communication failure (Transmission error)</b> Check code E7 is displayed if despite the FTC board sending signal "0", signal "1" is received 30 consecutive times.	1. Fault with FTC transmission/receiving circuit board 2. Electrical noise causes interference with power supply. 3. Electrical noise causes interference with FTC-outdoor unit transmission cable.	1. to 3. Turn the power to the indoor unit OFF and then ON. Power to both the indoor unit and outdoor units should be switched OFF then ON. (This may require switching 1 or 2 breakers depending if the unit is powered independently from the outdoor unit). If the E7 code is still displayed the FTC circuit board should be replaced.

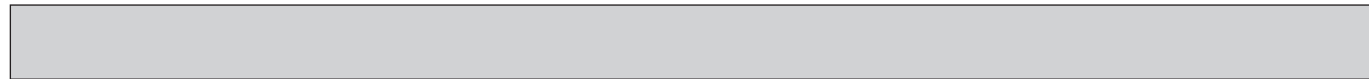

Check code	Title and display conditions	Possible Cause	Diagnosis and action
E1/E2	<b>Main remote controller control board failure</b> Check code E1 displayed if main remote controller cannot access it is non volatile (non power dependent) memory. Check code E2 is displayed when there is a fault with the main remote controller's internal clock.	1. Fault with the main remote controller circuit board	1. Replace main remote controller circuit board.
J0	<b>Indoor unit/wireless receiver communication failure</b> Check code J0 is displayed when the FTC cannot receive data from the wireless receiver for 1 minute.	1. Connection fault with wireless receiver-FTC connection 2. Fault with FTC receiving circuit board 3. Fault with wireless receiver's transmission circuit board 4. Electrical noise causes interference with wireless receiver communication cable.	1. Check the connections to the wireless receiver and FTC have not become loose and that the connecting cable is not damaged. 2. to 4. Turn the power to the indoor unit OFF and then ON. Power to both the indoor unit and outdoor units should be switched OFF then ON. (This may require switching 1 or 2 breakers depending if the unit is powered independently from the outdoor unit). If the J0 code is still displayed the FTC and/or the wireless receiver circuit board should be replaced.
J1 to J8	<b>Wireless remote controller/wireless receiver communication failure (Reception error)</b> Check code displayed if wireless receiver receives no/incomplete data from the wireless remote controller for 15 consecutive minutes.  The digit after the J refers to the address of the wireless remote controller that has the error. E.g. Check code "J3" refers to a communication fault between the wireless receiver and wireless remote control with address 3.	1. Battery on wireless remote control may be flat. 2. The wireless remote controller is out of range of the wireless receiver. 3. Fault with wireless remote controller transmission circuit board 4. Fault with wireless receiver's reception circuit board	1 Check and replace the battery if necessary the wireless remote controller battery. 2. to 4. Reposition the wireless remote control closer to the receiver and perform a communication test. For procedure refer to wireless remote controller installation manual. If "OK" is displayed then the cause of the J1 to J8 error was the controller was out of range of the receiver. The wireless remote controller should be installed within range of the receiver. If "Err" is displayed replace wireless remote controller with a new controller and perform the pairing procedure. If after this procedure the "Err" code is still displayed the fault is with the receiver unit (attached to the indoor unit). The receiver unit should be replaced with a new part and the original remote control can be reconnected. If "OK" is displayed then the fault is with the remote control and this should be replaced.
EE	Combination error between FTC and outdoor unit	R410A outdoor unit is combined incorrectly.	Check combination of FTC and outdoor unit.
U*, F*, A*	Outdoor unit failure	Outdoor unit failure	Refer to outdoor unit service manual.

Note: To cancel check codes, please switch system off (press button F4 (RESET) on main remote controller).

## 10-5. Troubleshooting by inferior phenomena

No.	Fault symptom	Possible cause	Explanation - Solution
1	Main remote controller display is blank.	<ol style="list-style-type: none"> <li>There is no power supply to main remote controller.</li> <li>Power is supplied to main remote controller, however, the display on the main remote controller does not appear.</li> </ol>	<ol style="list-style-type: none"> <li>Check LED2 on FTC. (See "6. WIRING DIAGRAM".)               <ol style="list-style-type: none"> <li>When LED2 is lit. Check for damage or contact failure of the main remote controller wiring.</li> <li>When LED2 is blinking. Refer to No. 5 below.</li> <li>When LED2 is not lit. Refer to No. 4 below.</li> </ol> </li> <li>Check the following:               <ul style="list-style-type: none"> <li>Disconnection between the main remote controller cable and the FTC control board</li> <li>Failure of the main remote controller if "Please Wait" is not displayed.</li> <li>Refer to No. 2 below if "Please Wait" is displayed.</li> </ul> </li> </ol>
2	"Please Wait" remains displayed on the main remote controller.	<ol style="list-style-type: none"> <li>"Please Wait" is displayed for up to 6 minutes.</li> <li>Communication failure between the main remote controller and FTC</li> <li>Communication failure between FTC and outdoor unit</li> </ol>	<ol style="list-style-type: none"> <li>Normal operation</li> <li>3. Main remote controller start up checks/procedure.               <ol style="list-style-type: none"> <li>If "0%" or "50 to 99%" is displayed below "Please Wait" there is a communication error between the main remote controller and the FTC control board.                   <ul style="list-style-type: none"> <li>Check wiring connections on the main remote controller.</li> <li>Replace the main remote controller or the FTC control board.</li> </ul> </li> <li>If "1 to 49%" is displayed there is a communication error between the outdoor unit's and FTC's control boards.                   <ul style="list-style-type: none"> <li>Check the wiring connections on the outdoor unit control board and the FTC control board. (Ensure S1 and S2 are not cross-wired and S3 is securely wired with no damage. (See "7. FIELD WIRING".))</li> <li>Replace the outdoor unit's and/or the FTC's control boards.</li> </ul> </li> </ol> </li> </ol>
3	The main screen appears with a press of the "ON" button, but disappears in a second.	The main remote controller operations do not work for a while after the settings are changed in the service menu. This is because the system takes time to apply the changes.	Normal operation The indoor unit is applying updated settings made in the service menu. Normal operation will start shortly.
4	LED2 on FTC is off. (See "6. WIRING DIAGRAM".)	<p>When LED1 on FTC is also off. (See "6. WIRING DIAGRAM".) &lt;FTC powered via outdoor unit.&gt;</p> <ol style="list-style-type: none"> <li>The outdoor unit is not supplied at the rated voltage.</li> <li>Defective outdoor controller circuit board</li> <li>FTC is not supplied with 220 to 240 VAC.</li> <li>FTC failure</li> <li>Faulty connector wiring</li> </ol>	<ol style="list-style-type: none"> <li>Check the voltage across the terminals L and N or L3 and N on the outdoor power board. (See "7. FIELD WIRING".)               <ul style="list-style-type: none"> <li>When the voltage is not 220 to 240 VAC, check wiring of the outdoor unit and of the breaker.</li> <li>When the voltage is at 220 to 240 VAC, go to "2." below.</li> </ul> </li> <li>Check the voltage across the outdoor unit terminals S1 and S2. (See "7. FIELD WIRING".)               <ul style="list-style-type: none"> <li>When the voltage is not 220 to 240 VAC, check the fuse on the outdoor control board and check for faulty wiring.</li> <li>When the voltage is 220 to 240 VAC, go to "3." below.</li> </ul> </li> <li>Check the voltage across the indoor unit terminals S1 and S2. (See "7. FIELD WIRING".)               <ul style="list-style-type: none"> <li>When the voltage is not 220 to 240 VAC, check FTC-outdoor unit wiring for faults.</li> <li>When the voltage is 220 to 240 VAC, go to "4." below.</li> </ul> </li> <li>Check the FTC control board.               <ul style="list-style-type: none"> <li>Check the fuse on FTC control board.</li> <li>Check for faulty wiring.</li> <li>If no problem found with the wiring, the FTC control board is faulty.</li> </ul> </li> <li>Check the connector wiring.               <ul style="list-style-type: none"> <li>When the connectors are wired incorrectly, re-wire the connectors referring to below. (See "7. FIELD WIRING".)</li> </ul> </li> </ol>

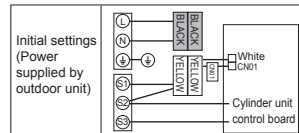

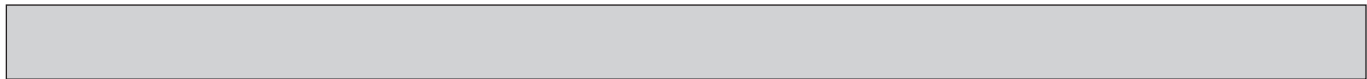

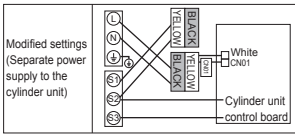
No.	Fault symptom	Possible cause	Explanation - Solution
4	LED2 on FTC is off. (See "6. WIRING DIAGRAM".)	<p>&lt;FTC powered on independent source&gt;</p> <ol style="list-style-type: none"> <li>1. FTC is not supplied with 220 to 240 VAC.</li> <li>2. There are problems in the method of connecting the connectors.</li> <li>3. FTC failure</li> </ol>	<ol style="list-style-type: none"> <li>1. Check the voltage across the L and N terminals on the indoor power supply terminal block. (See "7. FIELD WIRING".) <ul style="list-style-type: none"> <li>• When the voltage is not 220 to 240 VAC, check for faulty wiring to power supply.</li> <li>• When the voltage is 220 to 240 VAC, go to 2. below.</li> </ul> </li> <li>2. Check for faulty wiring between the connectors. <ul style="list-style-type: none"> <li>• When the connectors are wired incorrectly re-wire them correctly referring to below. (See "7. FIELD WIRING" and a wiring diagram on the control and electrical box cover.)</li> </ul> </li> </ol>  <ul style="list-style-type: none"> <li>• If no problem found with the wiring, go to 3. below.</li> </ul> <ol style="list-style-type: none"> <li>3. Check the FTC control board. <ul style="list-style-type: none"> <li>• Check the fuse on FTC control board.</li> <li>• Check for faulty wiring.</li> <li>• If no problem found with the wiring, the FTC control board is faulty.</li> </ul> </li> </ol>
		<p>When LED1 on FTC is lit. Incorrect setting of refrigerant address for outdoor unit (None of the refrigerant address is set to "0".)</p>	<p>Recheck the refrigerant address setting on the outdoor unit. Set the refrigerant address to "0". (Set refrigerant address using SW1(3-6) on outdoor controller circuit board.)</p>
5	LED2 on FTC is blinking. (See "6. WIRING DIAGRAM".)	<p>When LED1 is also blinking on FTC . Faulty wiring between FTC and outdoor unit</p>	<p>Check for faulty wiring between FTC and outdoor unit.</p>
		<p>When LED1 on FTC is lit.</p> <ol style="list-style-type: none"> <li>1. Faulty wiring in main remote controller Multiple indoor units have been wired to a single outdoor unit.</li> <li>2. Short-circuited wiring in main remote controller</li> <li>3. Main remote controller failure</li> </ol>	<ol style="list-style-type: none"> <li>1. Check for faulty wiring in main remote controller. The number of indoor units that can be wired to a single outdoor unit is one. Additional indoor units must be wired individually to a single outdoor unit.</li> <li>2,3. Remove main remote controller wires and check LED2 on FTC. (See "6. WIRING DIAGRAM".) <ul style="list-style-type: none"> <li>• If LED2 is blinking check for short circuits in the main remote controller wiring.</li> <li>• If LED2 is lit, wire the main remote controller again and: <ul style="list-style-type: none"> <li>- if LED2 is blinking, the main remote controller is faulty;</li> <li>- if LED2 is lit, faulty wiring of the main remote controller has been corrected.</li> </ul> </li> </ul> </li> </ol>
6	LED4 on FTC is off. (See "6. WIRING DIAGRAM".)	<ol style="list-style-type: none"> <li>1. SD memory card is NOT inserted into the memory card slot with correct orientation.</li> <li>2. Not an SD standards compliant memory card.</li> </ol>	<ol style="list-style-type: none"> <li>1. Correctly insert SD memory card in place until a click is heard.</li> <li>2. Use an SD standards compliant memory card. (Refer to installation manual, "5.8 Using SD memory card".)</li> </ol>
	LED4 on FTC is blinking. (See "6. WIRING DIAGRAM".)	<ol style="list-style-type: none"> <li>1. Full of data</li> <li>2. Write-protected</li> <li>3. NOT formatted</li> <li>4. Formatted in NTFS file system</li> </ol>	<ol style="list-style-type: none"> <li>1. Move or delete data, or replace SD memory card with a new one.</li> <li>2. Release the write-protect switch.</li> <li>3. Refer to installation manual, "5.8 Using SD memory card".</li> <li>4. FTC is Not compatible with NTFS file system. Use an SD memory card formatted in FAT file system.</li> </ol>
7	No water at hot tap.	<ol style="list-style-type: none"> <li>1. Cold main off</li> <li>2. Strainer (local supply) blocked.</li> </ol>	<ol style="list-style-type: none"> <li>1. Check and open stop cock.</li> <li>2. Isolate water supply and clean strainer.</li> </ol>
8	Cold water at tap.	<ol style="list-style-type: none"> <li>1. Hot water run out.</li> <li>2. Prohibit, schedule timer or holiday mode selected or demand control input (IN4) or smart grid ready (switch-off command).</li> <li>3. Heat pump not working.</li> <li>4. Booster heater cut-out tripped.</li> <li>5. The earth leakage circuit breaker for booster heater breaker (ECB1) tripped.</li> <li>6. The booster heater thermal cut-out has tripped and cannot be reset using the manual reset button.</li> <li>7. Immersion heater cut-out tripped.</li> <li>8. Immersion heater breaker (ECB2) tripped.</li> <li>9. 3-way valve fault</li> </ol>	<ol style="list-style-type: none"> <li>1. Ensure DHW mode is operating and wait for DHW tank to re-heat.</li> <li>2. Check settings and change as appropriate.</li> <li>3. Check heat pump – consult outdoor unit service manual.</li> <li>4. Check booster heater thermostat and press reset button if safe. Reset button is located on the side of booster heater, covered with white rubber cap. See "4. PART NAMES AND FUNCTIONS" to find out its position.</li> <li>5. Check the cause and reset if safe.</li> <li>6. Check resistance across the thermal cut-out, if open then the connection is broken and the booster heater will have to be replaced. Contact your Mitsubishi Electric dealer.</li> <li>7. Check immersion heater thermostat and press reset button, located on immersion heater boss, if safe. If the heater has been operated with no water inside it may have failed, so please replace it with a new one.</li> <li>8. Check the cause and reset if safe.</li> <li>9. Check plumbing/wiring to 3-way valve. <ol style="list-style-type: none"> <li>(i) Manually override 3-way valve using the main remote controller. (Refer to &lt;Manual operation&gt; in "9-5. Service menu") If the valve does not still function, go to (ii) below.</li> <li>(ii) Replace 3-way valve coil. If the valve does not still function, go to (iii) below.</li> <li>(iii) Replace 3-way valve. (Refer to "11. DISASSEMBLY PROCEDURE".)</li> </ol> </li> </ol>



No.	Fault symptom	Possible cause	Explanation - Solution
9	Water heating takes longer.	<ol style="list-style-type: none"> <li>1. Heat pump not working.</li> <li>2. Booster heater cut-out tripped.</li> <li>3. Booster heater breaker (ECB1) tripped.</li> <li>4. The booster heater thermal cut-out has tripped and cannot be reset using the manual reset button.</li> <li>5. Immersion heater cut-out has been triggered.</li> <li>6. Immersion heater breaker (ECB2) tripped.</li> <li>7. Flow rate of the sanitary circuit may be reduced.</li> </ol>	<ol style="list-style-type: none"> <li>1. Check heat pump – consult outdoor unit service manual.</li> <li>2. Check booster heater thermostat and press reset button if safe. Reset button is located on the side of booster heater, covered with white rubber cap. See "4. PART NAMES AND FUNCTIONS" to find out its position.</li> <li>3. Check the cause and reset if safe.</li> <li>4. Check resistance across the thermal cut-out, if open then connection is broken and the booster heater will have to be replaced. Contact your Mitsubishi Electric dealer.</li> <li>5. Check immersion heater thermostat and press reset button located on immersion heater boss, if safe. If the heater kept running with no water inside, this may have resulted in failure, so replace it with a new one.</li> <li>6. Check the cause and reset if safe.</li> <li>7. Check the following items <ul style="list-style-type: none"> <li>• Check for trapped air in water pump (sanitary circuit).</li> <li>• Check if the speed of water pump (sanitary circuit) is set to 2.</li> <li>• Check water pump (sanitary circuit) for malfunction. (Refer to "10-6. Checking Component Parts' Function".)</li> <li>• Replace plate heat exchanger (water - water) or scale trap, if there are a blockage which blocks the sanitary circuit.</li> </ul> </li> </ol>
10	Temperature of DHW tank water dropped.	<p>When DHW operation is not running, the DHW tank emits heat and the water temperature decreases to a certain level. If water in the DHW tank is reheated frequently because of a significant drop in water temperature, check for the following.</p> <ol style="list-style-type: none"> <li>1. Water leakage in the pipes that connect to the DHW tank</li> <li>2. Insulation material coming loose or off.</li> <li>3. 3-way valve failure</li> <li>4. Water pump (sanitary circuit) speed setting failure</li> </ol>	<ol style="list-style-type: none"> <li>1. Take the following measures. <ul style="list-style-type: none"> <li>• Retighten the nuts holding the pipes onto the DHW tank.</li> <li>• Replace seal materials.</li> <li>• Replace the pipes.</li> </ul> </li> <li>2. Fix insulation.</li> <li>3. Check plumbing/wiring to 3-way valve. <ol style="list-style-type: none"> <li>(i) Manually override 3-way valve using the main remote controller. (Refer to &lt;Manual operation&gt; in "9-5. Service menu".) If the valve does not still function, go to (ii) below.</li> <li>(ii) Replace 3-way valve motor. If the valve does not still function, go to (iii) below.</li> <li>(iii) Replace 3-way valve. (Refer to "11. DISASSEMBLY PROCEDURE".)</li> </ol> </li> <li>4. Water pump (sanitary circuit) MUST be set to speed 2. When it set to speed 1, hot water would be mixed with cold water due to circulation.</li> </ol>
11	Hot or warm water from cold tap.	Heat of hot water pipe is transferred to cold water pipe.	Insulate/re-route pipework.
12	Water leakage	<ol style="list-style-type: none"> <li>1. Poorly sealed connections of water circuit components</li> <li>2. Water circuit components reaching the end of life</li> </ol>	<ol style="list-style-type: none"> <li>1. Tighten connections as required.</li> <li>2. Refer to PARTS CATALOG for expected part lifetimes and replace them as necessary.</li> </ol>
13	Heating system does not reach the set temperature.	<ol style="list-style-type: none"> <li>1. Prohibit, schedule timer or holiday mode selected or demand control input (IN4) or smart grid ready (switch-off command).</li> <li>2. Check settings and change as appropriate.</li> <li>3. The temperature sensor is located in a room that has a different temperature relative to that of the rest of the house.</li> <li>4. Heat pump not working.</li> <li>5. Booster heater cut-out tripped.</li> <li>6. Booster heater breaker (ECB1) tripped.</li> <li>7. The booster heater thermal cut-out tripped and cannot be reset using the manual reset button.</li> <li>8. Incorrectly sized heat emitter</li> <li>9. 3-way valve failure</li> <li>10. Battery problem (wireless control only)</li> <li>11. If a mixing tank is installed, the flow rate between the mixing tank and the cylinder unit is less than that between the mixing tank and the local system.</li> </ol>	<ol style="list-style-type: none"> <li>1. Check settings and change as appropriate.</li> <li>2. Check the battery power and replace if flat.</li> <li>3. Relocate the temperature sensor to a more suitable room.</li> <li>4. Check heat pump – consult outdoor unit service manual.</li> <li>5. Check booster heater thermostat and press reset button if safe. Reset button is located on the side of booster heater, covered with white rubber cap. (See "4. PART NAMES AND FUNCTIONS" for position.)</li> <li>6. Check the cause of the trip and reset if safe.</li> <li>7. Check resistance across the thermal cut-out, if open then the connection is broken and the booster heater will have to be replaced. Contact your Mitsubishi Electric dealer.</li> <li>8. Check the heat emitter surface area is adequate. Increase size if necessary.</li> <li>9. Check plumbing/wiring to 3-way valve. <ol style="list-style-type: none"> <li>(i) Manually override 3-way valve using the main remote controller. (Refer to &lt;Manual operation&gt; in "9-5. Service menu".) If the 3-way valve does not function, go to (ii) below.</li> <li>(ii) Replace 3-way valve motor. If the 3-way valve coil is replaced but the 3-way valve does not function go to (iii) below.</li> <li>(iii) Replace 3-way valve. (Refer to "11. DISASSEMBLY PROCEDURE".)</li> </ol> </li> <li>10. Check the battery power and replace if flat.</li> <li>11. Increase the flow rate between the mixing tank and the cylinder unit decrease that between the mixing tank and the local system.</li> </ol>

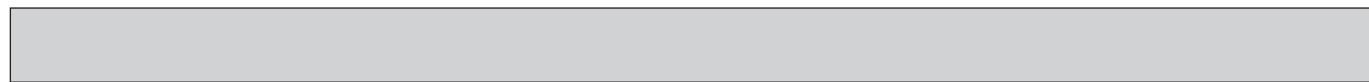

No.	Fault symptom	Possible cause	Explanation - Solution
14	Heating system does not reach the set lower temperature.	Heating system operates depending on the heating load to prevent low-load heating system from the frequent switching (ON/OFF) of the compressor.	Normal operation, no action necessary.
15	In 2-zone temperature control, Zone1 or Zone2 does not reach the set temperature.	<ol style="list-style-type: none"> <li>When Zone1 and Zone2 are both in heating mode, the hot water temperature in Zone2 does not exceed that in Zone1.</li> <li>Faulty wiring of motorized mixing valve</li> <li>Faulty installation of motorized mixing valve</li> <li>Incorrect setting of Running time</li> <li>Motorized mixing valve failure</li> <li>Pump2(Zone1 pump) or Pump3(Zone2 pump) failure</li> <li>Valves on heating system are closed</li> </ol>	<ol style="list-style-type: none"> <li>Normal action no action necessary.</li> <li>Refer to installation manual, "5.3 Wiring for 2-zone temperature control".</li> <li>Check for correct installation. (Refer to the manual included with each motorized mixing valve.)</li> <li>Check for correct setting of Running time.</li> <li>Inspect the mixing valve. (Refer to the manual included with each motorized mixing valve.)</li> <li>Inspect the pumps</li> <li>Check the valves</li> </ol>
16	When a PUHZ-FRP outdoor unit is connected, DHW or Heating operation cannot run.	The outdoor unit is set to have operation of the indoor unit of air conditioner take precedence over that of the cylinder unit, and in the main remote controller settings "Electric heater (Heating)" or "Electric heater (DHW)" is turned off.	Turn ON Electric heater (Heating) or Electric heater (DHW) using the main remote controller.
17	When a PUHZ-FRP outdoor unit is connected and is in heat recovery operation, the set temperature is not reached.	When the outdoor unit is set to have cooling operation of the indoor unit of air conditioner take precedence over that of the cylinder unit, the outdoor unit controls the frequency of the compressor according to the load of air conditioner. The DHW and heating run according to that frequency.	Normal operation no action necessary. If Air-to-Water system is given priority in operation, comp Hz can be regulated depending on the load of DHW or Heating. For more details, refer to the PUHZ-FRP installation manual.
18	After DHW operation room temperature rises slightly.	At the end of the DHW mode operation the 3-way valve diverts hot water away from the DHW circuit into space heating circuit. This is done to prevent the cylinder unit components from overheating. The amount of hot water directed into the space heating circuit varies according to the type of the system and of the pipe run between the plate heat exchanger and the cylinder unit.	Normal operation no action necessary.
19	The room temperature rises during DHW operation.	3-way valve failure	<p>Check the 3-way valve.</p> <p>(i) Manually override 3-way valve using the main remote controller. (Refer to &lt;Manual operation&gt; in "9-5. Service menu".) If the 3-way valve does not function, go to (ii) below.</p> <p>(ii) Replace 3-way valve coil. If the 3-way valve coil is replaced but the 3-way valve does not function go to (iii) below.</p> <p>(iii) Replace 3-way valve. (Refer to "11. DISASSEMBLY PROCEDURE".)</p>
20	Water discharges from pressure relief valve. (Primary circuit)	<ol style="list-style-type: none"> <li>If continual – pressure relief valve could bite foreign objects and the valve seat may be damaged.</li> <li>If intermittent – expansion vessel charge may have reduced/bladder perished.</li> </ol>	<ol style="list-style-type: none"> <li>Turn the handle on the pressure relief valve several turns. If leakage persists, replace the pressure relief valve with a new one.</li> <li>Check pressure in expansion vessel. Recharge to 1 bar if necessary. If bladder perished replace expansion vessel with a new one.</li> </ol>
21	Water discharges from pressure relief valve. (Sanitary circuit)	<ol style="list-style-type: none"> <li>If continual – field supplied pressure reducing valve not working.</li> <li>If continual – pressure relief valve could bite foreign objects and the valve seat may be damaged.</li> <li>If intermittent – expansion vessel charge may have reduced/bladder perished.</li> <li>DHW tank may have subjected to backflow.</li> </ol>	<ol style="list-style-type: none"> <li>Check function of pressure reducing valve and replace if necessary.</li> <li>Turn the handle on the pressure relief valve several turns. If leakage persists, replace the pressure relief valve with a new one.</li> <li>Check gas-side pressure in expansion vessel. Recharge to correct precharge pressure if necessary. If bladder perished replace expansion vessel with a new one with appropriate pre-charge.</li> <li>Check the pressure in DHW tank. If pressure in DHW tank is similar to that in the incoming mains, cold water supply that merges with incoming mains water supply could flow back to DHW tank. Investigate source of back-feed and rectify error in pipework/fitting configuration. Adjust pressure in cold supply.</li> </ol>
22	Water discharges from temperature and pressure relief valve (EHPT20X-MHEDW only) (Sanitary circuit)	<ol style="list-style-type: none"> <li>If continual – field supplied pressure reducing valve not working.</li> <li>If continual – temperature and pressure relief valve could bite foreign objects and the valve seat may be damaged.</li> <li>If intermittent – expansion vessel charge may have reduced/bladder perished.</li> <li>DHW tank may have subjected to backflow.</li> <li>Unit has overheated – thermal controls have failed.</li> </ol>	<ol style="list-style-type: none"> <li>Check function of pressure reducing valve and replace if necessary.</li> <li>Turn the handle on the temperature and pressure relief valve several turns. If leakage persists, replace the temperature and pressure relief valve with a new one.</li> <li>Check gas-side pressure in expansion vessel. Recharge to correct precharge pressure if necessary. If bladder perished replace expansion vessel with a new one with appropriate pre-charge.</li> <li>Check pressure in DHW tank. If pressure in DHW tank is similar to that in the incoming mains, cold water supply that merges with incoming mains water supply could flow back to DHW tank. Investigate source of back-feed and rectify error in pipework/fitting configuration. Adjust pressure in cold supply.</li> <li>Switch off power to the heat pump and immersion heaters. Leave water running. Wait until discharge stops. Isolate water supply and replace if faulty.</li> </ol>



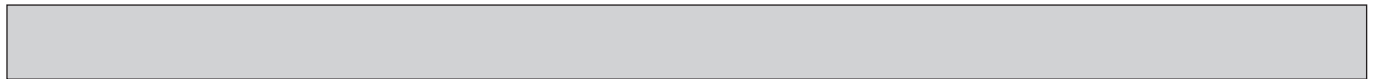

No.	Fault symptom	Possible cause	Explanation - Solution						
23	Water discharges from expansion relief valve - part of Inlet Control Group (EHPT20X-MHEDW only) (sanitary circuit)	<ol style="list-style-type: none"> <li>1. If continual – field supplied pressure reducing valve not working.</li> <li>2. If continual – expansion relief valve may be damaged.</li> <li>3. If intermittent – expansion vessel charge may have reduced/bladder perished.</li> <li>4. DHW tank may have subjected to backflow.</li> <li>5. Unit has overheated – thermal controls have failed.</li> </ol>	<ol style="list-style-type: none"> <li>1. Check function of pressure reducing valve and replace if necessary.</li> <li>2. Turn the handle on the expansion relief valve to check for foreign objects inside. If the problem is not still solved, replace the expansion relief valve with a new one.</li> <li>3. Check gas-side pressure in expansion vessel. Recharge to correct precharge pressure if necessary. If bladder perished replace expansion vessel with a new one with appropriate precharge.</li> <li>4. Check pressure in DHW tank. If pressure in DHW tank is similar to that in the incoming mains, cold water supply that merges with incoming mains water supply could flow back to DHW tank. Investigate source of back-feed and rectify error in pipework/fitting configuration. Adjust pressure in cold supply.</li> <li>5. Switch off power to the heat pump and immersion heaters. Leave water running. Wait until discharge stops. Isolate water supply and replace if faulty.</li> </ol>						
24	Noisy water circulation pump	Air in water circulation pump	Use manual and automatic air vents to remove air from system. Top up water if necessary to achieve 1 bar on primary circuit.						
25	Noise during hot water draw off typically worse in the morning.	<ol style="list-style-type: none"> <li>1. Loose airing cupboard pipework</li> <li>2. Heaters switching on/off</li> </ol>	<ol style="list-style-type: none"> <li>1. Install extra pipe fastening clips.</li> <li>2. Normal operation no action necessary.</li> </ol>						
26	Mechanical noise heard coming from the cylinder unit.	<ol style="list-style-type: none"> <li>1. Heaters switching on/off</li> <li>2. 3-way valve changing position between DHW and heating mode</li> </ol>	Normal operation no action necessary.						
27	Water circulation pump runs for a short time unexpectedly.	Water circulation pump jam prevention mechanism (routine) to inhibit the build-up of scale	Normal operation no action necessary.						
28	Milky/Cloudy water (Sanitary circuit)	Oxygenated water	Water from any pressurised system will release oxygen bubbles when water is running. The bubbles will settle out.						
29	Heating mode has been on standby for a long time (does not start operation smoothly.)	The time of "Delay" set in "Economy settings for pump" is too short. (Go to "Service menu" → "Auxiliary settings" → "Economy settings for pump").	Increase the time of "Delay" in "Economy settings for pump" .						
30	The cylinder unit that was running in the heating mode before power failure is running in the DHW mode after power recovery.	The cylinder unit is designed to run in an operation mode with a higher priority (i.e. DHW mode in this case) at power recovery.	<ul style="list-style-type: none"> <li>• Normal operation</li> <li>• After the DHW max. operation time has elapsed or the DHW max. temperature has been reached, the DHW mode switches to the other mode (ex. Heating mode).</li> </ul>						
31	Cooling mode is NOT available.	DIP SW2-4 is OFF.	Turn DIP SW2-4 to ON. (Refer to "6-9. DIP switch functions".)						
32	The cooling system does not cool down to the set temperature.	<ol style="list-style-type: none"> <li>1. When the water in the circulation circuit is unduly hot, Cooling mode starts with a delay for the protection of the outdoor unit.</li> <li>2. When the outdoor ambient temperature is lower than the preset temperature that activates the freeze stat function, Cooling mode does not start running.</li> </ol>	<ol style="list-style-type: none"> <li>1. Normal operation</li> <li>2. To run Cooling mode overriding the freeze stat function, adjust the preset temperature that activates the freeze stat function. (Refer to "&lt;Freeze stat function&gt;" on Page 37.)</li> </ol>						
33	The electric heaters are activated shortly after DHW or LP mode starts running after Cooling mode.	The setting time period of Heat-pump-only operation is short.	Adjust the setting time period of Heat-pump only operation. (Refer to "<Electric heater (DHW)>" on Page 35.)						
34	During DHW or LP mode following the cooling mode, error L6 (circulation water freeze protection error) occurs and the system stops all the operations.	The unit runs in Cooling mode when the outdoor ambient temperature is lower than 10°C (outside of the guaranteed operating range). (When defrosting operation is running at such a low outdoor ambient temperature after Cooling mode is switched to DHW or LP mode, the water temperature in the cooling circuit drops too low, which could result in L6 error to stop all the operations.	<p>Do not run Cooling operation when the outdoor ambient temperature is lower than 10°C.</p> <p>To automatically stop or recover only Cooling operation and keep other operations running, the freeze stat function can be used. Set the preset temperature that activates the freeze stat function to adjust the outdoor ambient temperature as follows. (Refer to "&lt;Freeze stat function&gt;" on Page 41.)</p> <table border="1"> <thead> <tr> <th>Outdoor ambient temperature</th> <th>Cooling operation</th> </tr> </thead> <tbody> <tr> <td>3°C higher than the preset temperature</td> <td>Stop</td> </tr> <tr> <td>5°C higher than the preset temperature</td> <td>Recover</td> </tr> </tbody> </table>	Outdoor ambient temperature	Cooling operation	3°C higher than the preset temperature	Stop	5°C higher than the preset temperature	Recover
Outdoor ambient temperature	Cooling operation								
3°C higher than the preset temperature	Stop								
5°C higher than the preset temperature	Recover								

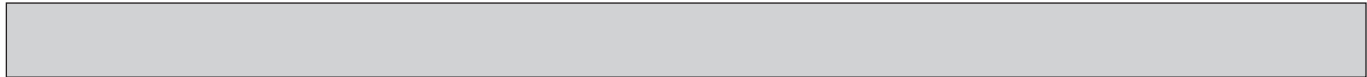

No.	Fault symptom	Possible cause	Explanation - Solution																
35	<p>The energy monitor value seems not correct.</p> <p>Note: There could be some discrepancies between the actual and the calculated values. If you seek for accuracy, please make sure to connect power meter(s) and heat meter to FTC board. Both should be locally supplied.</p>	<ol style="list-style-type: none"> <li>Incorrect setting of the energy monitor</li> <li>Non-connectable type of external meter (local supply) is connected.</li> <li>External meter (local supply) failure</li> <li>FTC board failure</li> </ol>	<ol style="list-style-type: none"> <li>Check the setting by following the procedure below. (1) Check if the DIP switch is set as the table below.  <table border="1"> <thead> <tr> <th colspan="2">Consumed electric energy</th> <th colspan="2">Delivered heat energy</th> </tr> <tr> <th>SW3-4</th> <th>Electric energy meter (Local supply)</th> <th>SW3-8</th> <th>Heat meter (Local supply)</th> </tr> </thead> <tbody> <tr> <td>OFF</td> <td>Without</td> <td>OFF</td> <td>Without</td> </tr> <tr> <td>ON</td> <td>With</td> <td>ON</td> <td>With</td> </tr> </tbody> </table>                       (2) In the case external electric energy meter and/or heat meter is not used, check if the setting for electric heater and water pump(s) input is correct by referring to &lt;Energy monitor setting&gt; in "9-5. Service menu".                      (3) In the case external electric energy meter and/or heat meter is used, check if the unit of output pulse on external meter matches with the one set at the main remote controller by referring to &lt;Energy monitor setting&gt; in "9-5. Service menu".                 </li> <li>Check if the external meter (local supply) is connectable type by referring to &lt;Energy monitor setting&gt;" in "9-5. Service menu".</li> <li>Check if signal is sent to IN8 to IN10 properly. (Refer to section 6. WIRING DIAGRAM) Replace the external heat meter if defective.</li> <li>Check the FTC control board.                     <ul style="list-style-type: none"> <li>Check for faulty wiring.</li> <li>If no problem found with the wiring, the FTC control board is faulty. Replace the board.</li> </ul> </li> </ol>	Consumed electric energy		Delivered heat energy		SW3-4	Electric energy meter (Local supply)	SW3-8	Heat meter (Local supply)	OFF	Without	OFF	Without	ON	With	ON	With
Consumed electric energy		Delivered heat energy																	
SW3-4	Electric energy meter (Local supply)	SW3-8	Heat meter (Local supply)																
OFF	Without	OFF	Without																
ON	With	ON	With																
36	Heat pump is forced to turn ON and OFF.	Smart grid ready input (IN11 and IN12) is used, and switch-on and off commands are input.	Normal operation no action necessary.																

## Annual Maintenance

It is essential that the cylinder unit is serviced at least once a year by a qualified individual. Any spare parts required should be purchased from Mitsubishi Electric. NEVER bypass safety devices or operate the unit without them being fully operational.



### <Annual maintenance points>

Use the Annual Maintenance Log Book as a guide to carrying out the necessary checks on the cylinder unit and outdoor unit.

## 10-6. Checking Component Parts' Function

Part Name	Checkpoints																																																																																
<p><b>Water circulation pump (primary circuit)</b></p>	<p><b>&lt;Water circulation pump (primary circuit) characteristics&gt;</b></p> <p><b>E*PT17X series</b></p> <p><b>&lt;Figure 10.6.1&gt;</b></p> <p><b>E*PT20/30X series</b></p> <p><b>&lt;Figure 10.6.2&gt;</b></p>																																																																																
<p><b>&lt;Recommended water flow rate range&gt;</b></p> <table border="1"> <thead> <tr> <th colspan="2">Outdoor heat pump unit</th> <th>Water flow rate range [L/min]</th> </tr> </thead> <tbody> <tr> <td rowspan="5">Packaged model</td> <td>PUZ-WM50</td> <td>6.5 – 14.3</td> </tr> <tr> <td>PUZ-WM60</td> <td>8.6 – 17.2</td> </tr> <tr> <td>PUZ-WM85</td> <td>10.8 – 24.4</td> </tr> <tr> <td>PUZ-WM112</td> <td>14.4 – 32.1</td> </tr> <tr> <td>PUZ-HWM140</td> <td>17.9 – 36.9</td> </tr> <tr> <td rowspan="13">Split SUZ series</td> <td>SUZ-SWM40VA</td> <td>6.5 – 11.4</td> </tr> <tr> <td>SUZ-SWM60VA</td> <td>7.2 – 17.2</td> </tr> <tr> <td>SUZ-SWM80VA</td> <td>7.8 – 21.5</td> </tr> <tr> <td>SUZ-SWM30VA</td> <td>7.2 – 17.2</td> </tr> <tr> <td>SUZ-SWM40VA2</td> <td>7.2 – 17.2</td> </tr> <tr> <td>SUZ-SWM60VA2</td> <td>7.2 – 17.2</td> </tr> <tr> <td>SUZ-SWM80VA(H)2</td> <td>10.9 – 21.5</td> </tr> <tr> <td>SUZ-SWM100VA(H)</td> <td>10.9 – 27.2</td> </tr> <tr> <td>SUZ-SHWM30VAH</td> <td>7.2 – 17.2</td> </tr> <tr> <td>SUZ-SHWM40VAH</td> <td>7.2 – 17.2</td> </tr> <tr> <td>SUZ-SHWM60VAH</td> <td>10.9 – 21.5</td> </tr> <tr> <td rowspan="5">Split PUD series</td> <td>PUD-S(H)WM60</td> <td>9.0 – 22.9</td> </tr> <tr> <td>PUD-S(H)WM80</td> <td>9.0 – 22.9</td> </tr> <tr> <td>PUD-S(H)WM100</td> <td>14.3 – 34.4</td> </tr> <tr> <td>PUD-S(H)WM120</td> <td>14.3 – 34.4</td> </tr> <tr> <td>PUD-SHWM140</td> <td>14.3 – 34.4</td> </tr> <tr> <td rowspan="10">Split PUHZ series</td> <td>PUHZ-SW75</td> <td>10.2 – 22.9</td> </tr> <tr> <td>PUHZ-SW100</td> <td>14.4 – 32.1</td> </tr> <tr> <td>PUHZ-SW120</td> <td>20.1 – 36.9</td> </tr> <tr> <td>PUHZ-SHW80</td> <td>10.2 – 22.9</td> </tr> <tr> <td>PUHZ-SW160</td> <td>23.0 – 63.1</td> </tr> <tr> <td>PUHZ-SW200</td> <td>28.7 – 71.7</td> </tr> <tr> <td>PUHZ-SHW112</td> <td>14.4 – 32.1</td> </tr> <tr> <td>PUHZ-SHW140</td> <td>17.9 – 36.9</td> </tr> <tr> <td>PUHZ-SHW230</td> <td>28.7 – 65.9</td> </tr> <tr> <td rowspan="5">Split Multi series</td> <td>PUHZ-FRP71</td> <td>11.5 – 22.9</td> </tr> <tr> <td>PUMY-P112</td> <td>17.9 – 35.8</td> </tr> <tr> <td>PUMY-P125</td> <td>17.9 – 35.8</td> </tr> <tr> <td>PUMY-P140</td> <td>17.9 – 35.8</td> </tr> <tr> <td>PXZ-4F75VG</td> <td>11.5 – 21.7</td> </tr> <tr> <td>PXZ-5F85VG</td> <td>11.5 – 24.6</td> </tr> </tbody> </table> <p><b>&lt;Table 10.6.1&gt;</b></p>	Outdoor heat pump unit		Water flow rate range [L/min]	Packaged model	PUZ-WM50	6.5 – 14.3	PUZ-WM60	8.6 – 17.2	PUZ-WM85	10.8 – 24.4	PUZ-WM112	14.4 – 32.1	PUZ-HWM140	17.9 – 36.9	Split SUZ series	SUZ-SWM40VA	6.5 – 11.4	SUZ-SWM60VA	7.2 – 17.2	SUZ-SWM80VA	7.8 – 21.5	SUZ-SWM30VA	7.2 – 17.2	SUZ-SWM40VA2	7.2 – 17.2	SUZ-SWM60VA2	7.2 – 17.2	SUZ-SWM80VA(H)2	10.9 – 21.5	SUZ-SWM100VA(H)	10.9 – 27.2	SUZ-SHWM30VAH	7.2 – 17.2	SUZ-SHWM40VAH	7.2 – 17.2	SUZ-SHWM60VAH	10.9 – 21.5	Split PUD series	PUD-S(H)WM60	9.0 – 22.9	PUD-S(H)WM80	9.0 – 22.9	PUD-S(H)WM100	14.3 – 34.4	PUD-S(H)WM120	14.3 – 34.4	PUD-SHWM140	14.3 – 34.4	Split PUHZ series	PUHZ-SW75	10.2 – 22.9	PUHZ-SW100	14.4 – 32.1	PUHZ-SW120	20.1 – 36.9	PUHZ-SHW80	10.2 – 22.9	PUHZ-SW160	23.0 – 63.1	PUHZ-SW200	28.7 – 71.7	PUHZ-SHW112	14.4 – 32.1	PUHZ-SHW140	17.9 – 36.9	PUHZ-SHW230	28.7 – 65.9	Split Multi series	PUHZ-FRP71	11.5 – 22.9	PUMY-P112	17.9 – 35.8	PUMY-P125	17.9 – 35.8	PUMY-P140	17.9 – 35.8	PXZ-4F75VG	11.5 – 21.7	PXZ-5F85VG	11.5 – 24.6	<p><b>E*ST17/20D series (Except for 2-zone cylinder)</b></p> <p><b>&lt;Figure 10.6.3&gt;</b></p> <p><b>E*ST30D series</b></p> <p><b>&lt;Figure 10.6.4&gt;</b></p> <p><b>E*ST20/30C series</b></p> <p><b>&lt;Figure 10.6.5&gt;</b></p> <p><b>2-zone cylinder</b></p> <p><b>&lt;Figure 10.6.6&gt;</b></p>
Outdoor heat pump unit		Water flow rate range [L/min]																																																																															
Packaged model	PUZ-WM50	6.5 – 14.3																																																																															
	PUZ-WM60	8.6 – 17.2																																																																															
	PUZ-WM85	10.8 – 24.4																																																																															
	PUZ-WM112	14.4 – 32.1																																																																															
	PUZ-HWM140	17.9 – 36.9																																																																															
Split SUZ series	SUZ-SWM40VA	6.5 – 11.4																																																																															
	SUZ-SWM60VA	7.2 – 17.2																																																																															
	SUZ-SWM80VA	7.8 – 21.5																																																																															
	SUZ-SWM30VA	7.2 – 17.2																																																																															
	SUZ-SWM40VA2	7.2 – 17.2																																																																															
	SUZ-SWM60VA2	7.2 – 17.2																																																																															
	SUZ-SWM80VA(H)2	10.9 – 21.5																																																																															
	SUZ-SWM100VA(H)	10.9 – 27.2																																																																															
	SUZ-SHWM30VAH	7.2 – 17.2																																																																															
	SUZ-SHWM40VAH	7.2 – 17.2																																																																															
	SUZ-SHWM60VAH	10.9 – 21.5																																																																															
	Split PUD series	PUD-S(H)WM60	9.0 – 22.9																																																																														
		PUD-S(H)WM80	9.0 – 22.9																																																																														
PUD-S(H)WM100		14.3 – 34.4																																																																															
PUD-S(H)WM120		14.3 – 34.4																																																																															
PUD-SHWM140		14.3 – 34.4																																																																															
Split PUHZ series	PUHZ-SW75	10.2 – 22.9																																																																															
	PUHZ-SW100	14.4 – 32.1																																																																															
	PUHZ-SW120	20.1 – 36.9																																																																															
	PUHZ-SHW80	10.2 – 22.9																																																																															
	PUHZ-SW160	23.0 – 63.1																																																																															
	PUHZ-SW200	28.7 – 71.7																																																																															
	PUHZ-SHW112	14.4 – 32.1																																																																															
	PUHZ-SHW140	17.9 – 36.9																																																																															
	PUHZ-SHW230	28.7 – 65.9																																																																															
	Split Multi series	PUHZ-FRP71	11.5 – 22.9																																																																														
PUMY-P112		17.9 – 35.8																																																																															
PUMY-P125		17.9 – 35.8																																																																															
PUMY-P140		17.9 – 35.8																																																																															
PXZ-4F75VG		11.5 – 21.7																																																																															
PXZ-5F85VG	11.5 – 24.6																																																																																

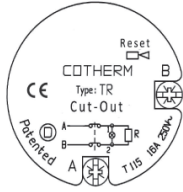
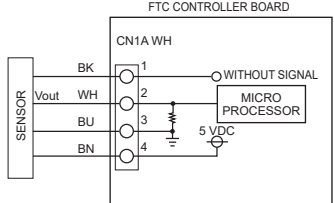
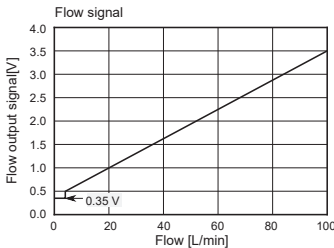
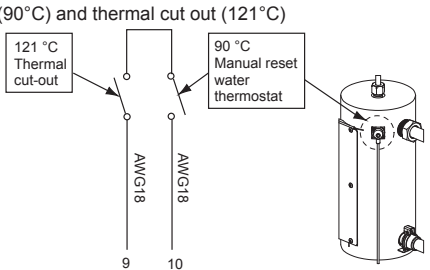
Note: For installation of E\*PT series, set its pump speed with a pressure drop between the cylinder unit and the outdoor unit factored into the external static pressure.

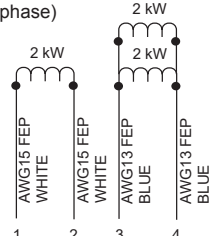
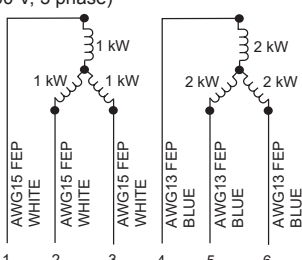
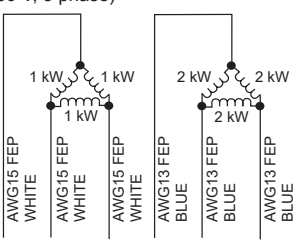
Part Name	Checkpoints									
<p><b>Water circulation pump (sanitary circuit)</b></p> 	<p>Measure the resistance between the terminals with a multimeter. (Winding temperature 20°C)</p> <table border="1" data-bbox="774 190 1388 257"> <thead> <tr> <th>Terminal</th> <th>Normal (speed 2)</th> <th>Abnormal</th> </tr> </thead> <tbody> <tr> <td>L-N</td> <td>211 Ω</td> <td>Open or Short</td> </tr> </tbody> </table> <p>DHW circulation pump MUST be set to speed 2.</p>	Terminal	Normal (speed 2)	Abnormal	L-N	211 Ω	Open or Short			
Terminal	Normal (speed 2)	Abnormal								
L-N	211 Ω	Open or Short								
<p><b>Immersion heater</b></p> 	<p>Measure the resistance between the terminals with a multimeter. (Winding temperature 20°C)</p> <table border="1" data-bbox="774 380 1388 448"> <thead> <tr> <th>Terminal</th> <th>Normal</th> <th>Abnormal</th> </tr> </thead> <tbody> <tr> <td>A-B</td> <td>19.2 Ω</td> <td>Open or Short</td> </tr> </tbody> </table> <p>To reset the immersion heater use a pin or similar to press the reset button located on the top of the immersion boss. See diagram on the left.</p>	Terminal	Normal	Abnormal	A-B	19.2 Ω	Open or Short			
Terminal	Normal	Abnormal								
A-B	19.2 Ω	Open or Short								
<p><b>Flow sensor</b></p>  <p>①-③ : 5 V (DC) ②-③ : Output Vout (DC)</p>										
<p><b>Booster heater</b></p> <p>Thermostat (90°C) and thermal cut out (121°C)</p> 	<p>Measure the resistance between the terminals with a multimeter.</p> <table border="1" data-bbox="821 851 1396 907"> <thead> <tr> <th>Terminal</th> <th>Normal</th> <th>Abnormal</th> </tr> </thead> <tbody> <tr> <td>9-10</td> <td>110(±35) mΩ</td> <td>Open or Short</td> </tr> </tbody> </table>	Terminal	Normal	Abnormal	9-10	110(±35) mΩ	Open or Short			
Terminal	Normal	Abnormal								
9-10	110(±35) mΩ	Open or Short								
<p>2 kW heater (230 V, 1 phase)</p> 	<table border="1" data-bbox="821 1131 1388 1187"> <thead> <tr> <th>Terminal</th> <th>Normal</th> <th>Abnormal</th> </tr> </thead> <tbody> <tr> <td>1-2</td> <td>26.5(+3/-1.3) Ω</td> <td>Open or Short</td> </tr> </tbody> </table>	Terminal	Normal	Abnormal	1-2	26.5(+3/-1.3) Ω	Open or Short			
Terminal	Normal	Abnormal								
1-2	26.5(+3/-1.3) Ω	Open or Short								
<p>2 + 4 kW heater (230 V, 1 phase)</p> 	<table border="1" data-bbox="821 1344 1396 1422"> <thead> <tr> <th>Terminal</th> <th>Normal</th> <th>Abnormal</th> </tr> </thead> <tbody> <tr> <td>1-2</td> <td>26.5(+3/-1.3) Ω</td> <td>Open or Short</td> </tr> <tr> <td>3-4</td> <td>13.3(+1.5/-0.6) Ω</td> <td>Open or Short</td> </tr> </tbody> </table>	Terminal	Normal	Abnormal	1-2	26.5(+3/-1.3) Ω	Open or Short	3-4	13.3(+1.5/-0.6) Ω	Open or Short
Terminal	Normal	Abnormal								
1-2	26.5(+3/-1.3) Ω	Open or Short								
3-4	13.3(+1.5/-0.6) Ω	Open or Short								
<p>3 + 6 kW heater (400 V, 3 phase)</p> 	<table border="1" data-bbox="821 1601 1388 1680"> <thead> <tr> <th>Terminal</th> <th>Normal</th> <th>Abnormal</th> </tr> </thead> <tbody> <tr> <td>1-2=2-3=1-3</td> <td>105.8(+11.8/-5) Ω</td> <td>Open or Short</td> </tr> <tr> <td>4-5=5-6=4-6</td> <td>52.9(+5.8/-2.5) Ω</td> <td>Open or Short</td> </tr> </tbody> </table>	Terminal	Normal	Abnormal	1-2=2-3=1-3	105.8(+11.8/-5) Ω	Open or Short	4-5=5-6=4-6	52.9(+5.8/-2.5) Ω	Open or Short
Terminal	Normal	Abnormal								
1-2=2-3=1-3	105.8(+11.8/-5) Ω	Open or Short								
4-5=5-6=4-6	52.9(+5.8/-2.5) Ω	Open or Short								
<p>3 + 6 kW heater (230 V, 3 phase)</p> 	<table border="1" data-bbox="821 1892 1388 1971"> <thead> <tr> <th>Terminal</th> <th>Normal</th> <th>Abnormal</th> </tr> </thead> <tbody> <tr> <td>1-2=2-3=3-1</td> <td>35.3(+3.9/-1.8) Ω</td> <td>Open or Short</td> </tr> <tr> <td>4-5=5-6=6-4</td> <td>17.6(+1.9/-0.9) Ω</td> <td>Open or Short</td> </tr> </tbody> </table>	Terminal	Normal	Abnormal	1-2=2-3=3-1	35.3(+3.9/-1.8) Ω	Open or Short	4-5=5-6=6-4	17.6(+1.9/-0.9) Ω	Open or Short
Terminal	Normal	Abnormal								
1-2=2-3=3-1	35.3(+3.9/-1.8) Ω	Open or Short								
4-5=5-6=6-4	17.6(+1.9/-0.9) Ω	Open or Short								

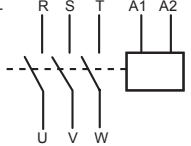
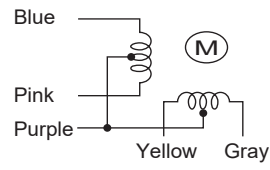
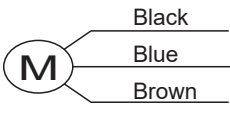
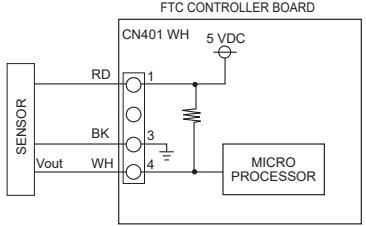
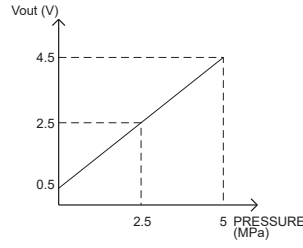
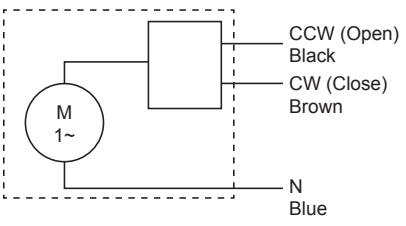
Part Name	Checkpoints																			
<b>Earth leakage circuit breaker for heater</b>	If a short circuit occurs on the booster heater, immersion heater, or each power line, a short-circuit breaker will trip and power source will be blocked. Eliminate the causes of short circuit and then turn on the breaker again.																			
<b>Relay for heater</b> 	When the applied voltage is not 230 VAC across the terminals A1-A2, check the terminals R-U, S-V, and T-W are open. When the applied voltage is 230 VAC across the terminals A1-A2, check the terminals R-U, S-V, and T-W are short.																			
<b>3-way valve (Stepping motor)</b> 	Measure the resistance between the terminals with a multimeter. (Winding temperature 20°C) <table border="1" data-bbox="858 448 1513 526"> <thead> <tr> <th colspan="4">Normal</th> <th rowspan="2">Abnormal</th> </tr> <tr> <th>Purple-Yellow</th> <th>Purple-Blue</th> <th>Purple Gray</th> <th>Purple-Pink</th> </tr> </thead> <tbody> <tr> <td colspan="4" style="text-align: center;">35 Ω</td> <td>Open or Short</td> </tr> </tbody> </table>	Normal				Abnormal	Purple-Yellow	Purple-Blue	Purple Gray	Purple-Pink	35 Ω				Open or Short					
Normal				Abnormal																
Purple-Yellow	Purple-Blue	Purple Gray	Purple-Pink																	
35 Ω				Open or Short																
<b>3-way valve (AC motor)</b> 	Measure the resistance between the terminals with a multimeter. (Winding temperature 20°C) <table border="1" data-bbox="858 627 1449 705"> <thead> <tr> <th>Terminal</th> <th>Normal</th> <th>Abnormal</th> </tr> </thead> <tbody> <tr> <td>Blue-Black or Blue-Brown*</td> <td>11 Ω</td> <td>Open or Short</td> </tr> </tbody> </table> <p>*One will be 11Ω and the other will be open.</p>	Terminal	Normal	Abnormal	Blue-Black or Blue-Brown*	11 Ω	Open or Short													
Terminal	Normal	Abnormal																		
Blue-Black or Blue-Brown*	11 Ω	Open or Short																		
<b>Pressure sensor</b>  <p>①-③ : 5 V (DC) ④-⑤ : Output Vout (DC)</p>																				
<b>Mixing valve</b> 	<ol style="list-style-type: none"> <li>Check if wirings are correct.            TBO.2-1: Black            TBO.2-2: Blue            TBO.2-3: Brown</li> <li>Remove the motor part from the mixing valve and check if it functions properly as follows:           <ul style="list-style-type: none"> <li>The motor dial rotates in a CW direction when 230 V is applied between brown and blue.</li> <li>The motor dial rotates in a CCW direction when 230 V is applied between black and blue.</li> </ul> </li> <li>If the motor functions properly, the valve may be locked by some cause: Remove the valve to check for clogging inside.</li> </ol>																			
<b>Thermistors</b>	Disconnect the connector then measure the resistance with a multimeter. (At ambient temperatures of 10 to 30°C.) <table border="1" data-bbox="869 1444 1460 1736"> <thead> <tr> <th>Thermistor</th> <th>Normal</th> <th>Abnormal</th> </tr> </thead> <tbody> <tr> <td>TH1</td> <td rowspan="10">4.3 - 9.5 kΩ</td> <td rowspan="10">Open or short</td> </tr> <tr> <td>TH2</td> </tr> <tr> <td>THW1</td> </tr> <tr> <td>THW2</td> </tr> <tr> <td>THW5A</td> </tr> <tr> <td>THW5B</td> </tr> <tr> <td>THW6</td> </tr> <tr> <td>THW7</td> </tr> <tr> <td>THW8</td> </tr> <tr> <td>THW9</td> </tr> <tr> <td>THW10</td> <td rowspan="2">40 - 100 kΩ</td> <td rowspan="2">Open or short</td> </tr> <tr> <td>THWB1</td> </tr> </tbody> </table>	Thermistor	Normal	Abnormal	TH1	4.3 - 9.5 kΩ	Open or short	TH2	THW1	THW2	THW5A	THW5B	THW6	THW7	THW8	THW9	THW10	40 - 100 kΩ	Open or short	THWB1
Thermistor	Normal	Abnormal																		
TH1	4.3 - 9.5 kΩ	Open or short																		
TH2																				
THW1																				
THW2																				
THW5A																				
THW5B																				
THW6																				
THW7																				
THW8																				
THW9																				
THW10	40 - 100 kΩ	Open or short																		
THWB1																				

<Thermistor Characteristics Charts>

- Room temperature thermistor (TH1)
- Liquid refrigerant temperature thermistor (TH2)
- Flow water temperature thermistor (THW1)
- Return water temperature thermistor (THW2)
- DHW tank temperature thermistor (THW5)
- Zone1 flow water temperature thermistor (THW6)
- Zone1 return water temperature thermistor (THW7)
- Zone2 flow water temperature thermistor (THW8)
- Zone2 return water temperature thermistor (THW9)

Thermistor R0 = 15kΩ ± 3%

B constant = 3480 ± 2%

$$R_t = 15 \exp \left\{ 3480 \left( \frac{1}{273+t} - \frac{1}{273} \right) \right\}$$

0°C	15 kΩ
10°C	9.6 kΩ
20°C	6.3 kΩ
25°C	5.2 kΩ
30°C	4.3 kΩ
40°C	3.0 kΩ

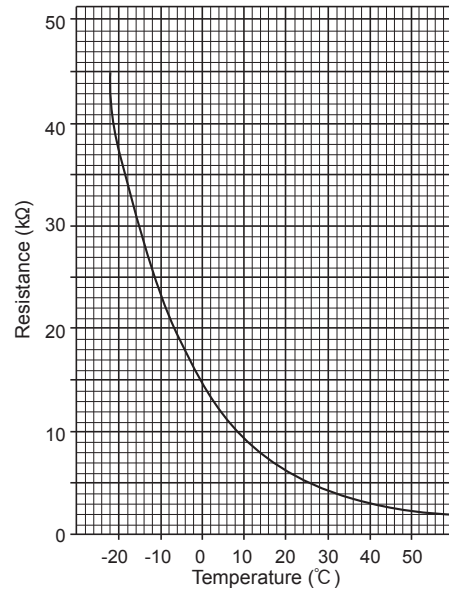

- Boiler flow water temperature thermistor (THWB1)
- Mixing tank temperature thermistor (THW10)

Thermistor R100 = 3.3kΩ ± 2%

B constant = 3970 ± 1%

$$R_t = 3.3 \exp \left\{ 3970 \left( \frac{1}{273+t} - \frac{1}{273} \right) \right\}$$

0°C	162.8 kΩ
10°C	97.4 kΩ
20°C	60.3 kΩ
25°C	48.1 kΩ
30°C	38.6 kΩ
40°C	25.4 kΩ
50°C	17.1 kΩ
60°C	11.9 kΩ
70°C	8.4 kΩ
80°C	6.0 kΩ

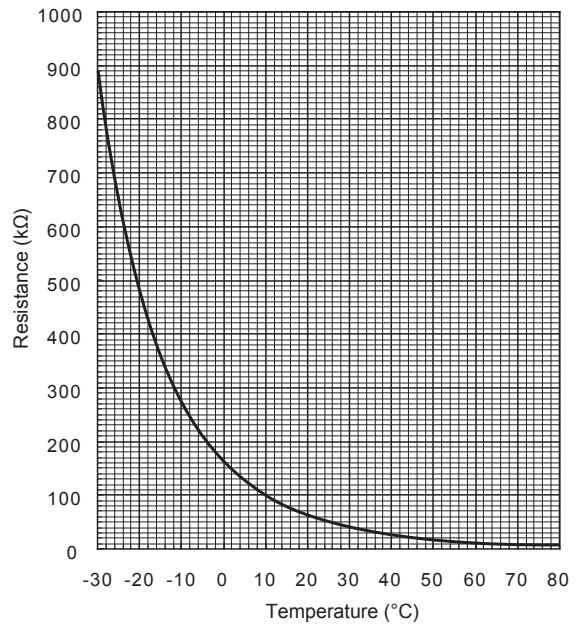

## 10-7. Test point diagram

### FTC (Controller board)

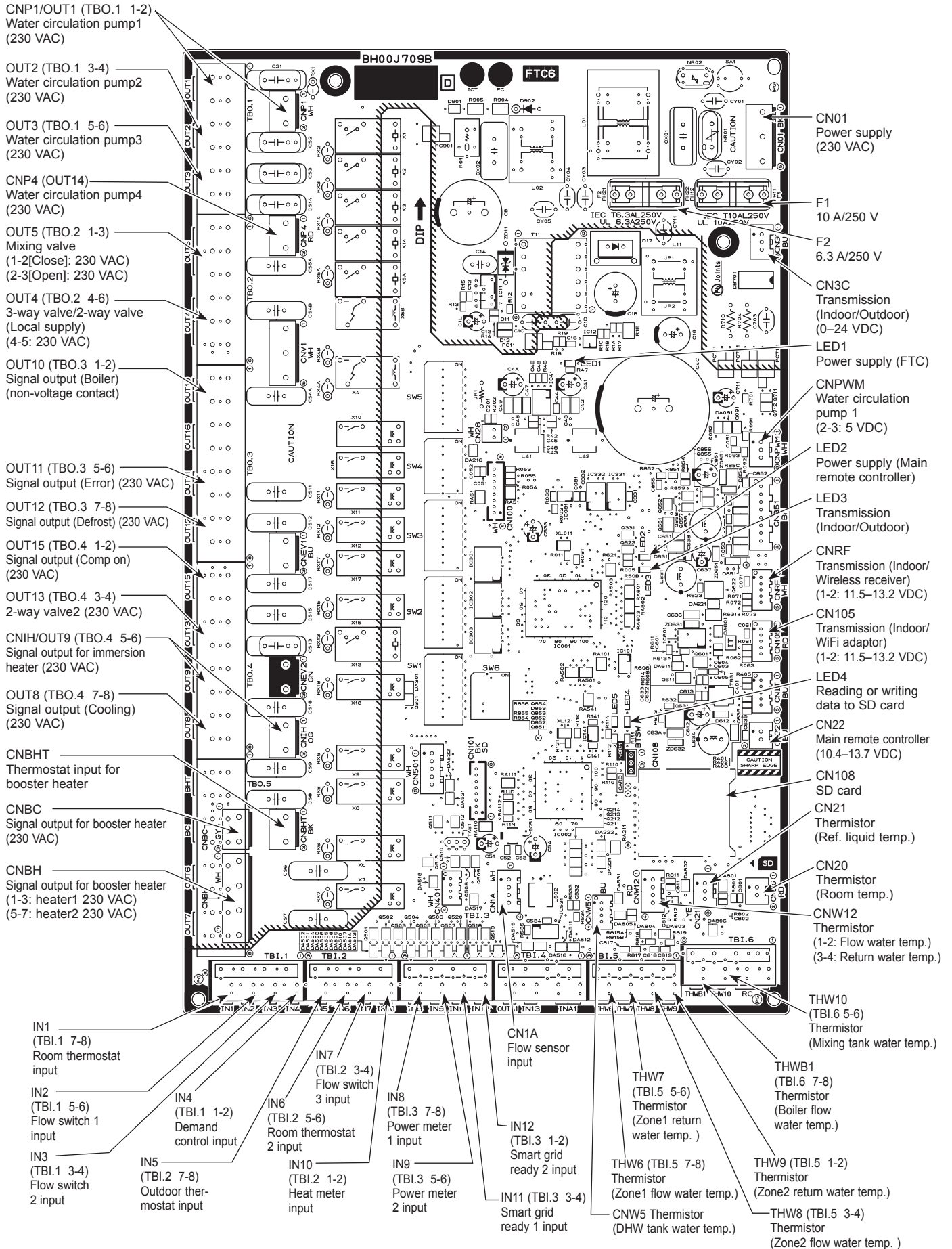

**<Preparation for the repair service>**



- Prepare the proper tools.
- Prepare the proper protectors.
- Provide adequate ventilation.
- After stopping the operation of the cylinder and outdoor unit, turn off all the power-supply breaker.
- Discharge the condenser before the work involving the electric parts.
- Allow parts to cool.
- Do not expose the electric parts to water.
- When replacing or servicing water circuit parts, drain system first.

Check individual illustrations and positions of the parts by referring to the parts catalogue.

Some lead wires and pipes are bundled with bands. Cut the bands to undo the fastened pipes and lead wires if necessary. When bundling the lead wires and pipes again, use new commercially available bands.

When removing the parts associated with water pipe work, drain the cylinder unit as necessary. Refer to "Draining the cylinder unit" on page 28. When draining the cylinder unit, keep water from splashing on the internal parts (mainly electric parts and insulations).

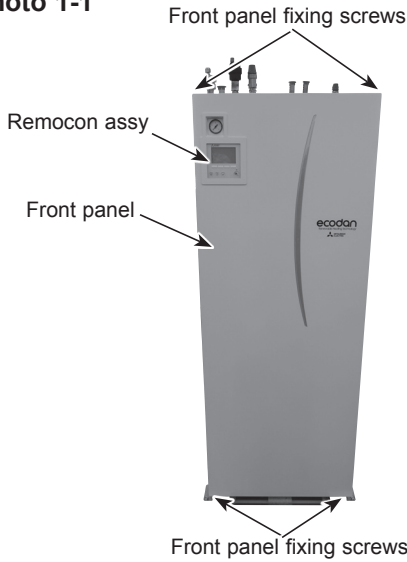
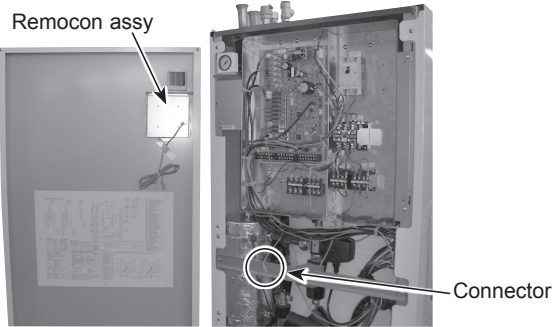
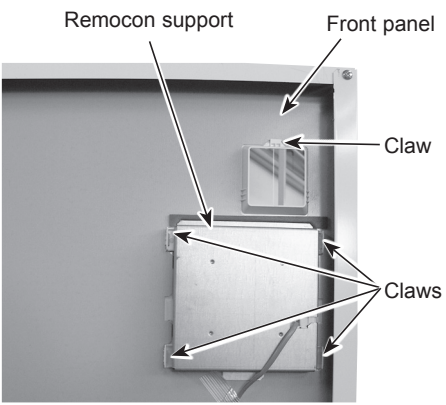
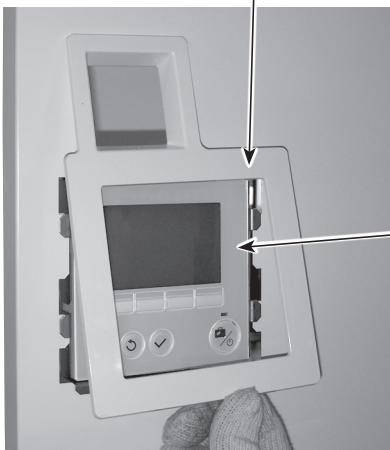
—————> : Indicates the visible parts in the photos/figures.  
 - - - - -> : Indicates the invisible parts in the photos/figures.

DISASSEMBLY PROCEDURE	PHOTOS/FIGURES
<p><b>1. How to remove the front panel</b></p> <p>(1) Remove the 2 screws at the bottom of the cylinder unit. Remove the 2 screws at the top of the cylinder unit. (Only ERST17D-***BD series) (Photo 1-1)</p> <p>(2) Slightly lift and pull out the front panel from the cylinder unit. (Photo 1-1)</p> <p>(3) Disconnect the relay connector connecting from the remocon assy. (Photo 1-2)</p>	<p><b>Photo 1-1</b></p>  <p>Front panel fixing screws</p> <p>Remocon assy</p> <p>Front panel</p> <p>Front panel fixing screws</p>
<p><b>Photo 1-2</b></p>  <p>Remocon assy</p> <p>Connector</p>	<p><b>2. How to remove the remocon assy</b></p> <p>(1) Remove the front panel. (Refer to Procedure 1.)</p> <p>(2) Turn the front panel over and remove the remocon holder by removing the 5 claws. (Photos 2-1 and 2-2)</p> <p>(3) Slide the main remote controller support upward, then remove it together with the remocon assy. (Photo 2-2)</p> <p>(4) Separate the remocon assy from the remocon support. (Photos 2-1 and 2-3)</p>
<p><b>Photo 2-1</b></p>  <p>Remocon support</p> <p>Front panel</p> <p>Claw</p> <p>Claws</p>	<p><b>Photo 2-2</b></p>  <p>Remocon holder</p> <p>Remocon assy</p>
<p><b>Photo 2-3</b></p> 	



## DISASSEMBLY PROCEDURE

### 3. How to remove the electrical parts

(Step (1) is applied to all the following parts.)

(1) Remove the front panel. (Refer to Procedure 1.)

#### <Earth leakage circuit breaker> (Photo 3-1)

(2) Disconnect all the lead wires from the earth leakage circuit breaker.

(3) Remove the 2 screws on the earth leakage circuit breaker.

Note:

To avoid dropping of the breaker, hold the breaker by hand when removing the last screws.

#### <Contactor> (Photo 3-1)

(2) Disconnect all the lead wires from the contactors.

(3) Remove the 2 screws on each contactor.

Note:

To avoid dropping of the contactors, hold the contactors by hand when removing the last screws.

To prevent an electrical shock, wait until all the LED lamps on the FTC control board are turned off.

#### <Terminal block> (Photo 3-1)

(2) Disconnect all the lead wires from the terminal block. (To disconnect the S1, S2 and S3 lead wires, disengage the locks by pressing on the claws.)

(3) Remove the screw on the terminal block.

Note:

To avoid dropping of the terminal block, hold the terminal block by hand when removing the screw.

#### <Controller board> (Photo 3-2)

(2) Disconnect all the lead wires from the controller board.

(3) Remove the controller board from the 4 board supports.

#### <Reactor> (Photo 3-3)

(2) Disconnect the relay connector from the reactor.

(3) Remove the 2 screws on the reactor.

Note:

To avoid dropping of the reactor, hold the reactor by hand when removing the last screws.

Photo 3-3

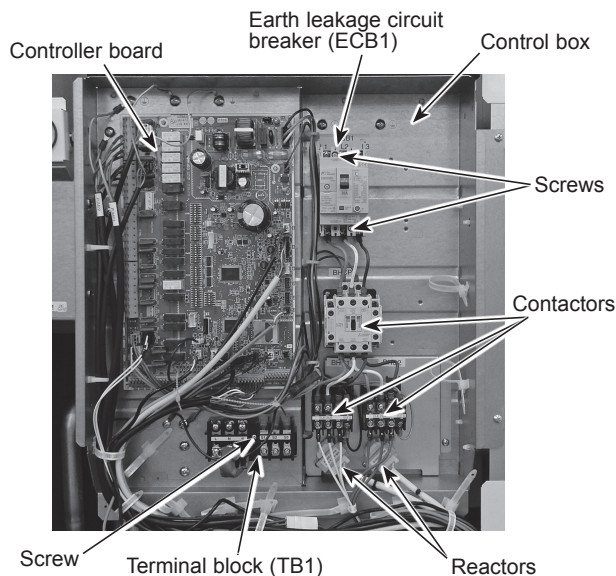

Note: The photos shown are of the ERST17D-YM9BD model.

## PHOTOS/FIGURES

Photo 3-1

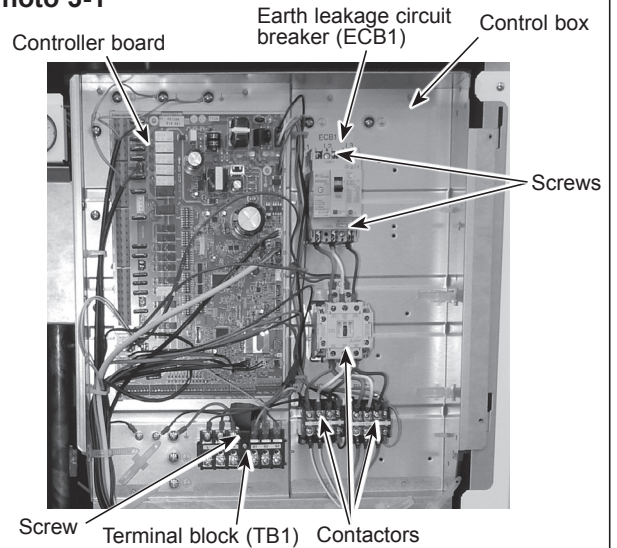

Note: The photos shown are of the EHST20C-YM9D model.

Photo 3-2

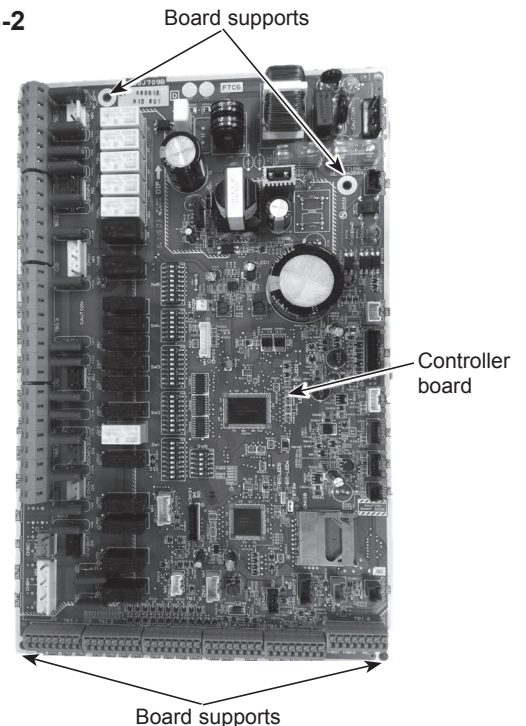

## DISASSEMBLY PROCEDURE

### 4. How to remove the control box

- (1) Remove the front panel. (Refer to Procedure 1.)
- (2) Disconnect only the lead wires in the control box that connect to the components in the cylinder unit. Photo 4-2 and 4-4 shows the control box before the related lead wires are disconnected.
- (3) Remove the 4 screws on the bracket (L and R) and disengage the tab on the control box bracket from the front frame (L). (Photo 4-1)
- (4) Disengage the 2 tabs on the control box bracket (R) from the front frame (R). (Photo 4-1)
- (5) Slightly lift and pull out the control box from the cylinder unit while tilting the control box backward.

#### <When swinging the control box to the front>

- (2) Remove the 4 screws on the bracket (L and R). (Photo 4-1)
- (3) Disengage the tab on the control box bracket (L) from the front frame (L) and pull the control box by lifting the left-hand side to swing the control box. (Photo 4-3)

Note: Disconnect the field wiring as necessary.

## PHOTOS/FIGURES

**Photo 4-1**

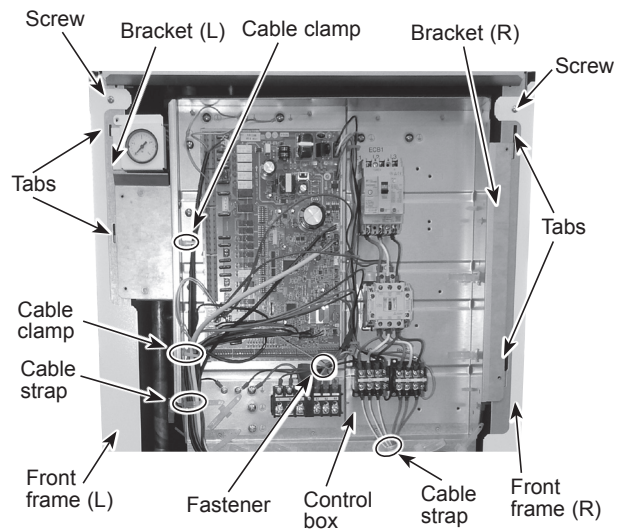

Note: The photos shown are of the EHST20C-YM9D model.

**Photo 4-2**

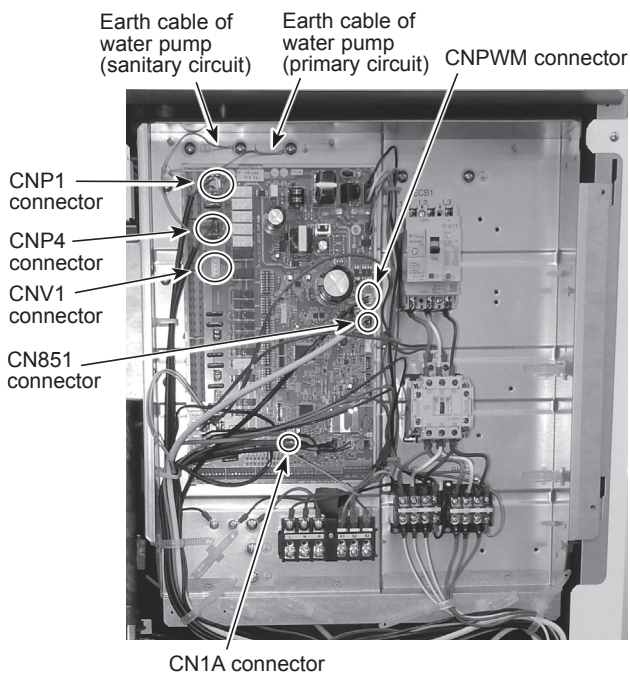

Note: The photos shown are of the EHST20C-YM9D model.

**Photo 4-3**

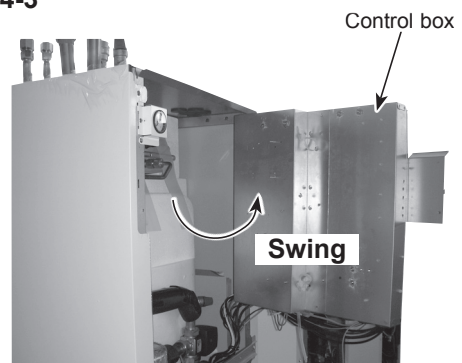

**Photo 4-4**

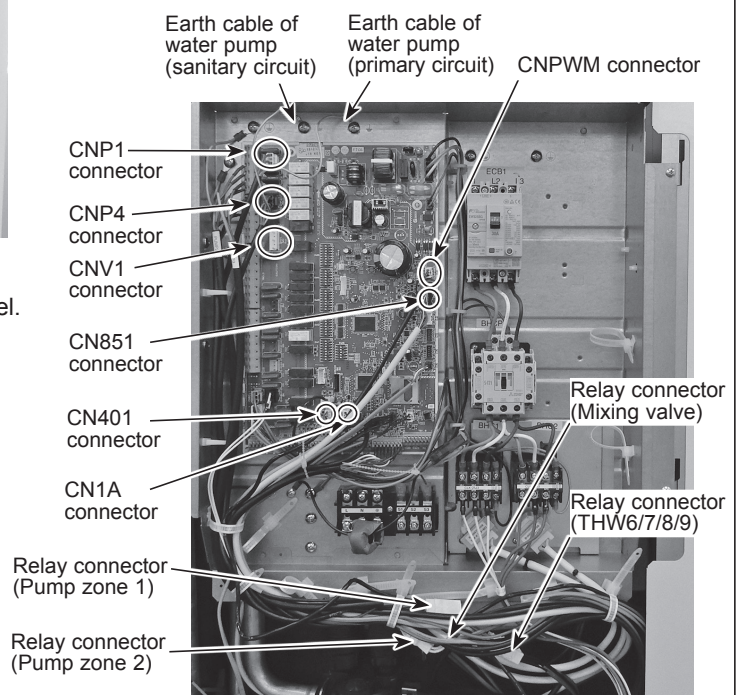

Note: The photos shown are of the ERST17D-YM9BD model.

## DISASSEMBLY PROCEDURE

### 5. How to remove water pump (primary circuit)/pump valve/strainer valve

#### <Water pump>

Close the pump valve (OFF) before removing the water pump, and open the valves (ON) after reinstalling the water pump.

- (1) Remove the front panel. (Refer to Procedure 1.)
- (2) Disconnect the CNP1 connector, the earth cable and the CNPWM connector on the controller board. (Photo 4-2)
- (3) Release the water pump lead wire from the cable clamp, the fastener and the cable strap in the control box, and the cable strap, the fastener and the band below the control box. (Photos 4-1, 10-1 and 10-6)
- (4) Close (OFF) the pump valve and the strainer valve (Except for ERST17D-\*\*\*BD model) (Photo 5-1)
  - When either of the pump valve handle or the strainer valve handle is stiff, use a tool to grip the handle and turn it carefully.
  - When opening or closing the pump valve and the strainer valve, ensure to do so fully, not halfway.
- (5) Remove the water pump by removing the two G1" nuts using the 2 spanners: one to hold the G1" nut and the other to turn the other side of G1" nut. Remove the water pump by sliding it horizontally. (Photo 5-1)
  - When reinstalling the G1" nuts, use new G1" gaskets. (Photos 5-2 and 5-3)
  - Set the water pump in the way that the die stamped arrow facing down, and the lead wire connectors to the left. (Photo 5-1)
  - Be sure to change the pump and the water pump lead wire together.
  - Be sure to wipe water around the surface of the pump and the water pump lead wire thoroughly.

#### <Pump valve>

- (6) Remove the 2 screws on the pump valve stay. (Photo 5-1)
- (7) <E\*\*T\*\*C/X series>  
Remove the pump valve by detaching the quick connection.  
<E\*\*T\*\*D series>  
Detach the quick connection from pump valve and P-HEX. Remove the pipe (pump-wc) and the elbows. Remove the pump valve.
  - When reinstalling the quick connection, use new O-ring.
  - Refer to Procedure 25 for how to attach and detach the quick connection.
- (8) Remove the pump valve stay by removing the 2 screws, and remove the drain cock (primary circuit). (Photo 5-4)
  - Reuse the removed pump valve stay and the pump valve stay fixing screws.
  - When reinstalling the drain cock (primary circuit), use a new one.

Note: Skip Steps (2) and (3) above when replacing the pump valve only.

## PHOTOS/FIGURES

Photo 5-1

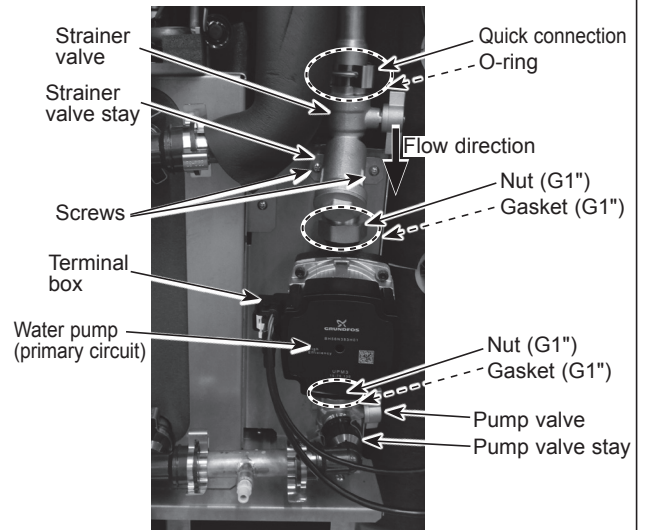

Photo 5-2

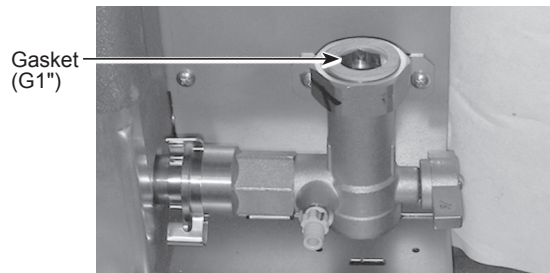

Photo 5-3

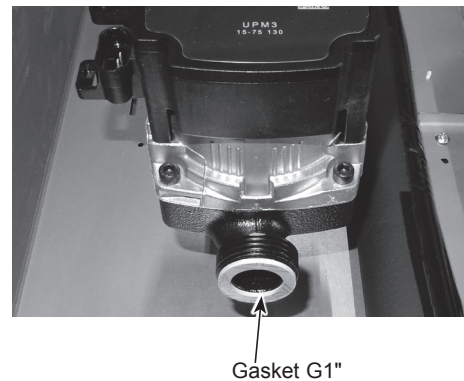
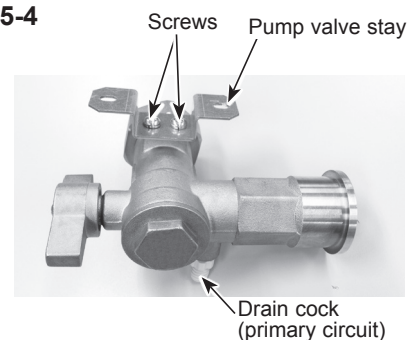
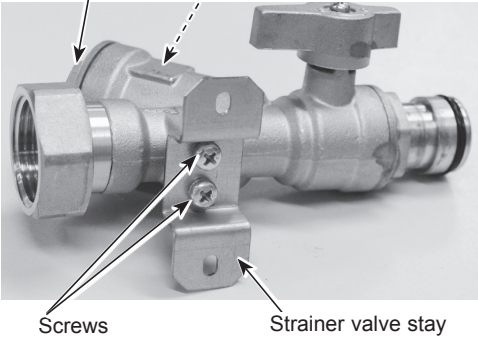
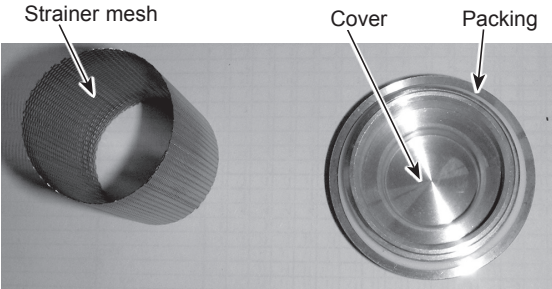
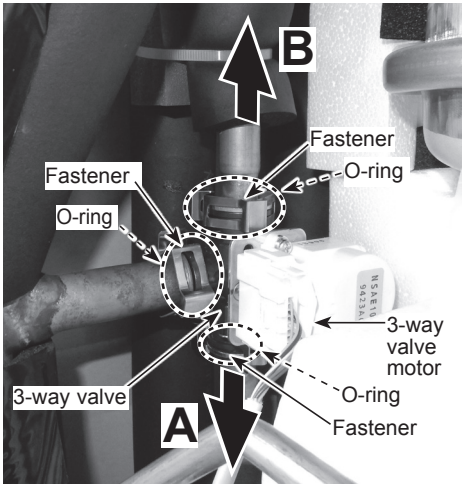
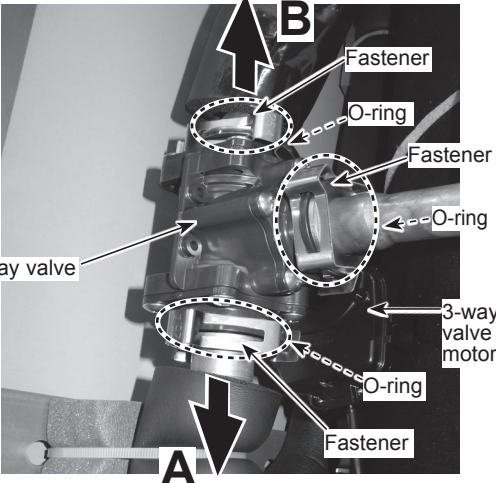

Photo 5-4



From the previous page.

DISASSEMBLY PROCEDURE	PHOTOS/FIGURES
<p><b>&lt;Strainer valve&gt;</b></p> <p>(6) Remove the 2 screws on the strainer valve stay. (Photo 5-1)</p> <p>(7) Remove the strainer valve by detaching the quick connection.</p> <ul style="list-style-type: none"> <li>• When reinstalling the quick connection, use a new O-ring.</li> <li>• Refer to Procedure 25 for how to attach and detach the quick connection.</li> </ul> <p>(8) Remove the strainer valve stay by removing the 2 screws. (Photo 5-5)</p> <ul style="list-style-type: none"> <li>• Reuse the removed strainer valve stay and the strainer valve stay fixing screws.</li> </ul> <p>Note: Skip steps (2) and (3) when replacing the strainer valve only.</p> <p><b>&lt;Strainer cover (debris recovery)&gt;</b></p> <p>(5) Remove the cover using 2 spanners: one to hold the strainer valve and the other to turn the cover. (Photo 5-5)</p> <ul style="list-style-type: none"> <li>• Be sure to reattach the mesh after washing it. (Photo 5-6)</li> <li>• When reinstalling the cover, use a new packing. (Photo 5-6)</li> </ul> <p>Note: Skip Steps (2) and (3) above when washing the strainer mesh only.</p>	<p><b>Photo 5-5</b></p>  <p><b>Photo 5-6</b></p> 
<p><b>6. How to remove the 3-WAY VALVE/3-WAY VALVE MOTOR</b></p> <p>(1) Remove the front panel. (Refer to Procedure 1.)</p> <p>(2) &lt;E**T17*/20D series&gt; Disconnect the CNV1 connector on the controller board. (Photo 4-2)</p> <p>&lt;E**T20C/20X/30* series&gt; Disconnect the CN851 connector on the controller board. (Photo 4-2)</p> <p>(3) Release the 3-way valve motor lead wire from the cable clamp, the fastener and the cable strap in the control box, and the cable strap, the fastener and the band below the control box. (Photos 4-1 and 10-1)</p> <p>(4) Remove the 3-way valve by removing the fastener.</p> <ul style="list-style-type: none"> <li>• When reinstalling the fastener, use new O-ring. A and B shown represent the bottom and the top directions of the 3-way valve, respectively.</li> </ul> <p>Note: Before replacing the motor, be sure to power off the cylinder unit. Failure to do so may cause electric shock or cause the 3-way valve to malfunction.</p>	<p><b>Photo 6-1 (E**T17*/20D series)</b></p>  <p><b>Photo 6-2 (E**T20C/20X/30* series)</b></p> 

## DISASSEMBLY PROCEDURE

### 7. How to remove the flow sensor

- (1) Remove the front panel. (Refer to Procedure 1)
- (2) Disconnect the CN1A connector on the controller board. (Photo 4-2)
- (3) Release the flow sensor lead wire from the fastener and the cable strap in the control box, and the cable strap, the fastener and the band below the control box. (Photos 4-1 and 10-1)
- (4) Close (OFF) the strainer valve. (Except for ERST17D-\*\*\*BD model) (Photo 5-1)
  - When the strainer valve handle is stiff, use a tool to grip the handle and turn it carefully.
  - When opening or closing the strainer valve, ensure to do so fully, not halfway.
- (5) Remove the flow sensor by detaching the same diameter quick connection. (Photos 7-1 and 7-2)
  - When reinstalling the flow sensor, use new O-rings. (Photos 7-1 and 7-2)
  - Refer to Procedure 25 for how to attach and detach the quick connection.

Note: Set the flow sensor in the direction of the arrow printed on the flow sensor, and in the way that the sensor part faces to the left. (Photo 7-1)

### 8. How to remove the booster heater

- (1) Remove the front panel. (Refer to Procedure 1.)
- (2) Disconnect the CNBHT connector on the controller board, and the booster heater lead wires wired to the BHC1 (Lead wire No.1, No.2 and No.3) and BHC2 (Lead wire No.4, No.5 and No.6) contactors respectively and release the lead wires from the fastener, the cable strap, and the band. (Photos 8-1 and 10-1)

Note: Do not mix up the lead wire numbers when re-connecting the lead wires to the contactors as the lead wire numbers are different depending on the models.

Model	Lead wire No.	Contactors
ERST17D-VM6D	No.1	BHC1-U
EHST20D-VM6D		BHC1-V
ERST20D-VM6D	No.4	BHC2-U
EHST30D-VM6ED		BHC2-V
ERST30D-VM6ED	No.5	BHC2-V
EHST20C-VM6D		BHC2-W
EHST30C-VM6ED	No.6	BHC2-W
EHST17D-VM6BD		BHC2-W
EHST17D-VM9D	No.1	BHC1-U
EHST20D-VM9D		BHC1-V
EHST20D-VM9ED	No.3	BHC1-W
EHST20D-TM9D		BHC2-U
ERST20D-VM9D	No.4	BHC2-U
EHST30D-VM9ED		BHC2-V
EHST30D-VM9ED	No.5	BHC2-V
ERST30D-TM9D		BHC2-W
ERST30D-VM9ED	No.6	BHC2-W
EHST20C-VM9D		BHC2-W
EHST20C-VM9ED	No.1	BHC1-U
ERST20C-TM9D		BHC1-V
ERST20C-VM9D	No.2	BHC1-U
EHST17D-VM2D		BHC1-V
ERST17D-VM2D	No.1	BHC1-U
EHST20D-VM2D		BHC1-V
ERST20D-VM2D	No.2	BHC1-U
ERST30D-VM2ED		BHC1-V
ERST30D-VM2ED	No.1	BHC1-U
ERST17D-VM2BD		BHC1-V
EHST20C-VM2D	No.2	BHC1-U
ERST20C-VM2D		BHC1-V
ERST30C-VM2ED	No.1	BHC1-U
ERST17D-VM2BD		BHC1-V

Refer to 6. WIRING DIAGRAM

## PHOTOS/FIGURES

Photo 7-1

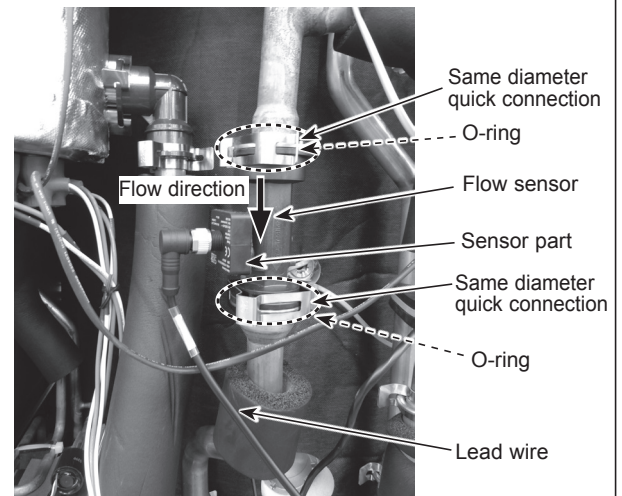

Photo 7-2

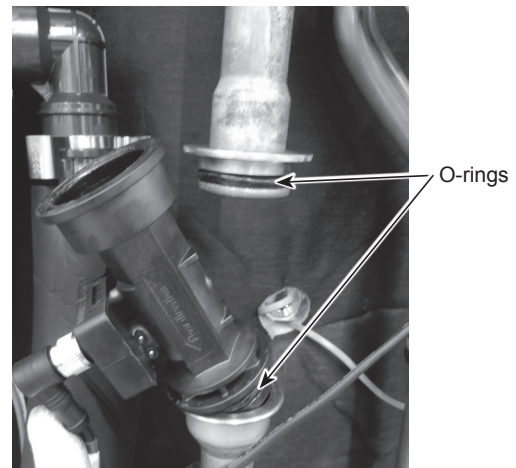
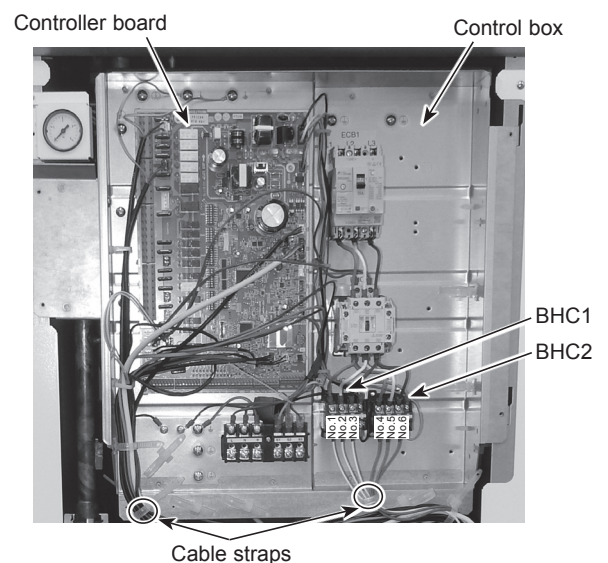

Photo 8-1



Note: The photos shown are of the EHST20C-VM6D model.

From the previous page.

### DISASSEMBLY PROCEDURE

- (3) Remove the DIV frame by removing the 2 screws on it. (Photo 8-2) (Only E\*\*T20/30\* series)  
Remove the DIV frame by cutting the band and removing the 4 screws on it. (Photo 10-6) (Only ERST17D-\*\*\*BD model)
- (4) Close (OFF) the pump valve. (Photo 8-2)
  - When the pump valve handle is stiff, use a tool to grip the handle and turn it carefully.
  - When opening or closing the pump valve, ensure to do so fully, not halfway.
- (5) Detach the 2 quick connections. (Inlet of booster heater and outlet of P-HEX) (Photos 8-2 and 8-3)
  - When reinstalling the quick connections, use new O-rings.
  - Refer to Procedure 25 for how to attach and detach the quick connection.
- (6) Remove the pipe (W.C. - B.H.) by carefully pulling it to the right. (Photo 8-2)
- (7) Remove the pipe (B.H. - D.V.) by carefully pulling it to the top. (Photo 8-2)
- (8) Detach the quick connection (upper F.S.) to make the connection part of pipe (to F.S.) free. (Photo 8-2)
  - When reinstalling the quick connections, use a new O-ring.
  - Refer to Procedure 25 for how to attach and detach the quick connection.

### PHOTOS/FIGURES

**Photo 8-3**

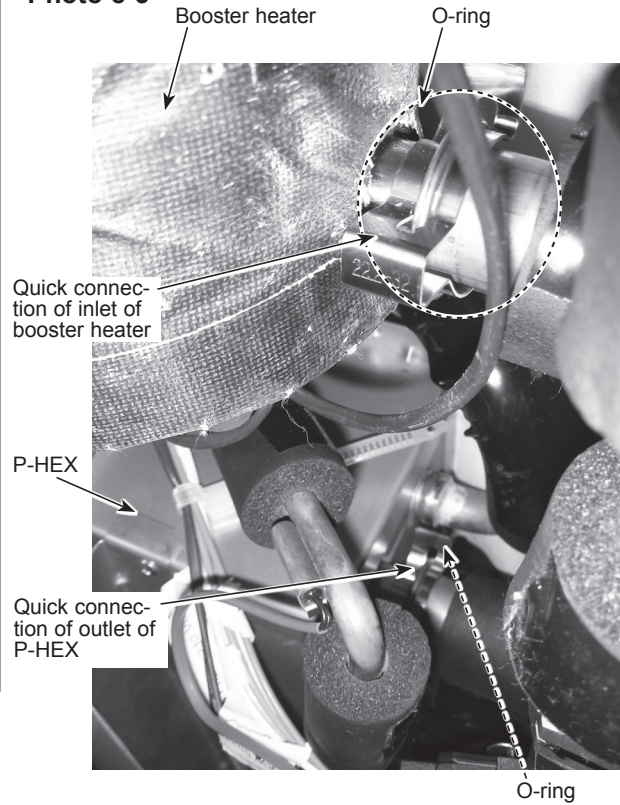

**Photo 8-2**

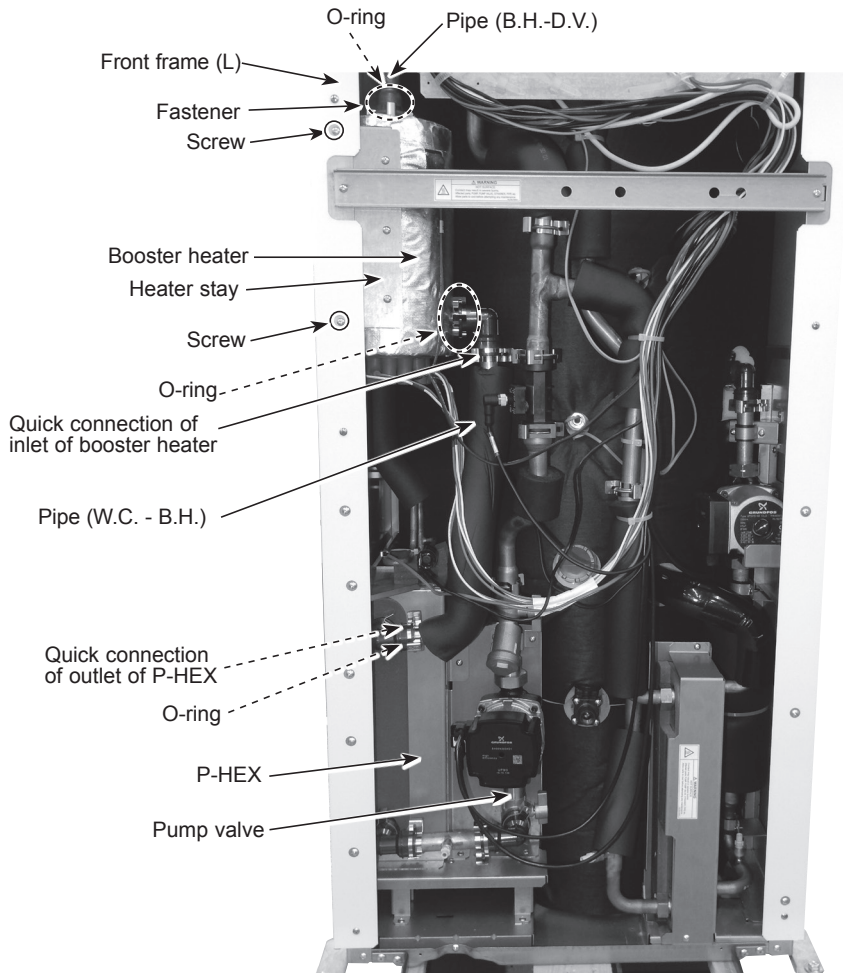

From the previous page.

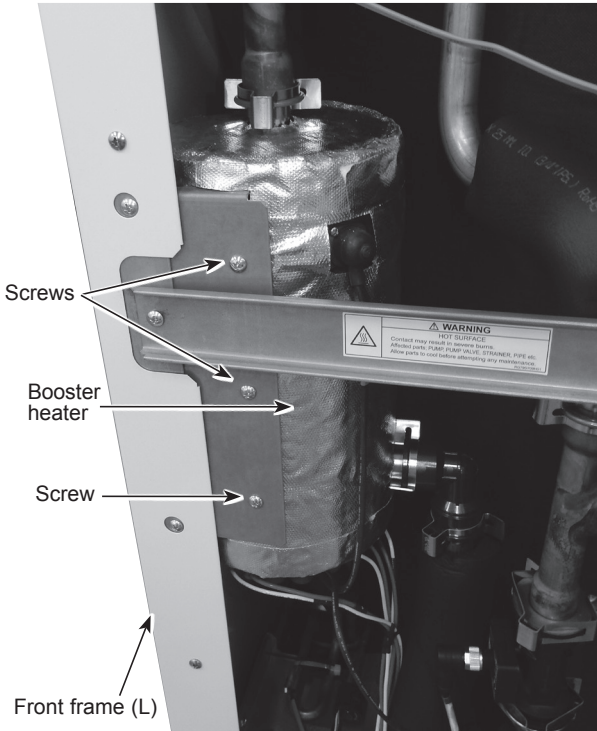
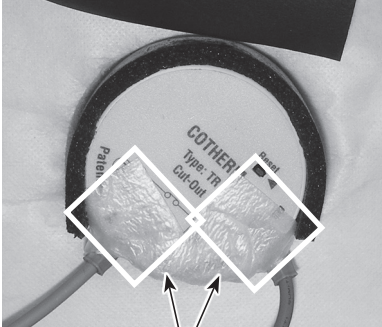
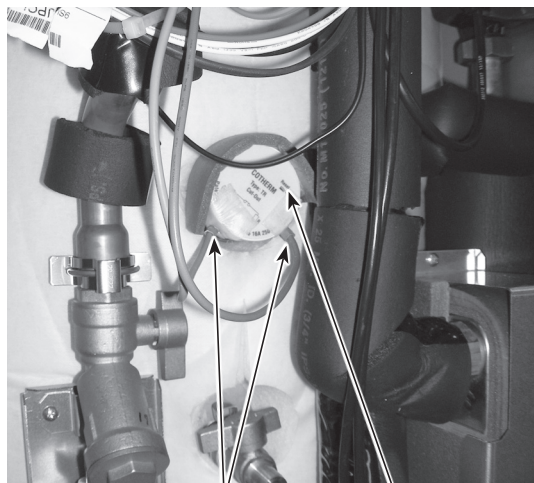
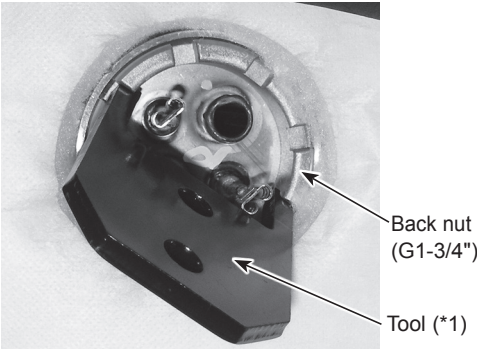
DISASSEMBLY PROCEDURE	PHOTOS/FIGURES
<p>(9) Remove the 2 screws that hold the heater stay onto the front frame (L). Lift the booster heater slightly and remove the booster heater with the heater stay from the front frame (L). (Photos 8-2)</p> <p>(10) Remove the 3 screws that hold the heater stay onto the booster heater, and remove the heater stay from the booster heater. (Photo 8-4)</p>	<p><b>Photo 8-4</b></p> 
<p><b>9. How to remove the thermostat/immersion heater</b></p> <p><b>&lt;Thermostat&gt;</b></p> <p>(1) Remove the front panel. (Refer to Procedure 1.)</p> <p>(2) Peel off the water-proof tapes on the plastic head of the thermostat in order to reveal the thermostat terminals, and disconnect the lead wires from the terminals. (Photos 9-1 and 9-2)</p> <ul style="list-style-type: none"> <li>• Use new commercially available water-proof tapes to cover the terminals again.</li> </ul> <p>(3) Pull out the thermostat.</p> <p><b>&lt;Immersion heater&gt;</b></p> <p>(4) Remove the tab cover and remove the back nut (G1-3/4") using the tool included with the immersion heater. (Photo 9-3)</p> <p>(5) Pull out the immersion heater.</p> <ul style="list-style-type: none"> <li>• When reinstalling the immersion heater, use a new G1-3/4" gasket.</li> </ul> <p><b>Note:</b></p> <p>When replacing the immersion heater only, skip Step (2). After reinstalling the back nut with the tab cover onto the tank, insert the immersion heater straight into the tank through the back nut in order to provide adequate sealing. Failure to do so may cause water leakage. Always check for water leakage after installation.</p>	<p><b>Photo 9-2</b></p> 
<p><b>Photo 9-1</b></p> 	<p><b>Photo 9-3</b></p> 
<p>(*1) When the model is the cylinder unit including immersion heater, the tool is included with the unit. The tool is also included with the immersion heater of optional parts.</p>	

## DISASSEMBLY PROCEDURE

### 10. How to remove the plate heat exchanger (P-HEX) (Refrigerant - Water) <E\*ST\*\*C/D series>

- <E\*ST\*\*C/D series>
- (1) Pump down the refrigerant circuit and close the stop valve at the outdoor unit side.  
(Refer to 12. SUPPLEMENTARY INFORMATION.)
  - (2) Remove the front panel. (Refer to Procedure 1.)  
Remove the left side panel. (Refer to Procedure 22.)
  - (3) Remove the control box. (Refer to Procedure 4.)
  - (4) Remove the DIV frame by cutting the band and removing 2 screws on it. (Photo 10-1) (E\*ST20/30\* series)  
Remove the DIV frame by cutting the band and removing 4 screws on it. (Photo 10-6) (ERST17D-\*\*\*BD series)
  - (5) Cut the bands bundling the pipes. (Photos 10-1, 10-2 and 10-6)
  - (6) Remove the 2 flare nuts on the refrigerant piping on top of the cylinder unit. (Photo 10-3)

## PHOTOS/FIGURES

Photo 10-1

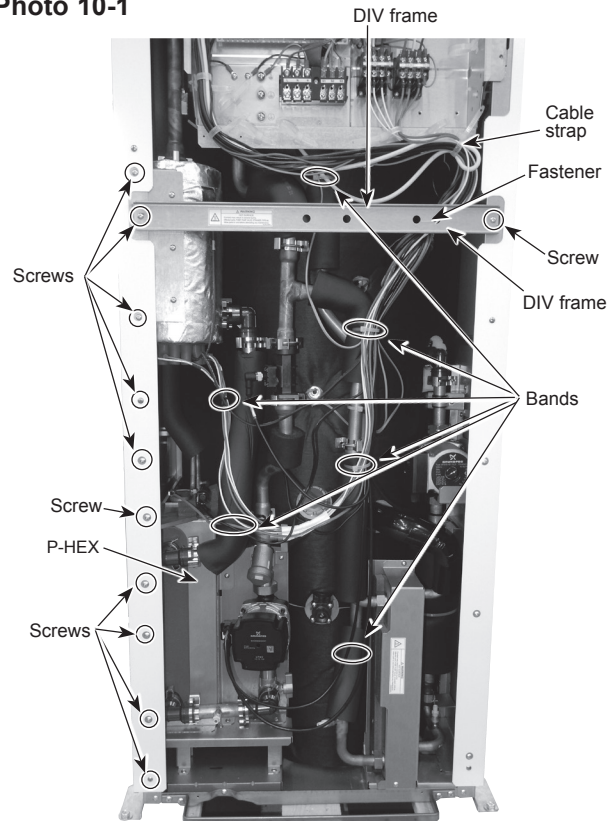

Note: The photos shown are of the EHST20D-VM6D model with optional immersion heater.

Photo 10-2

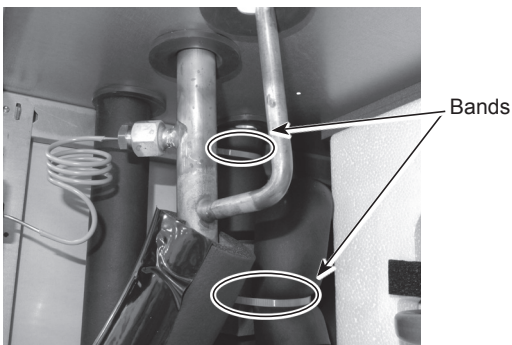
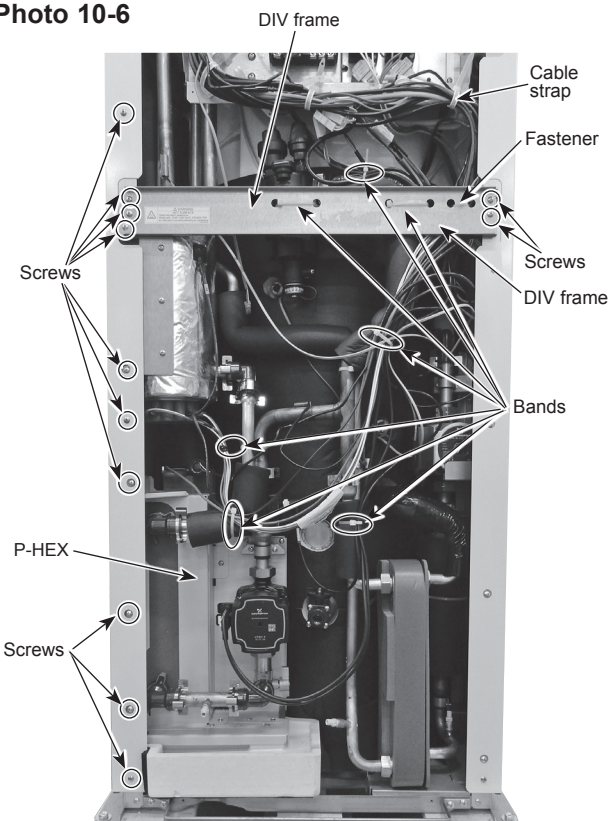
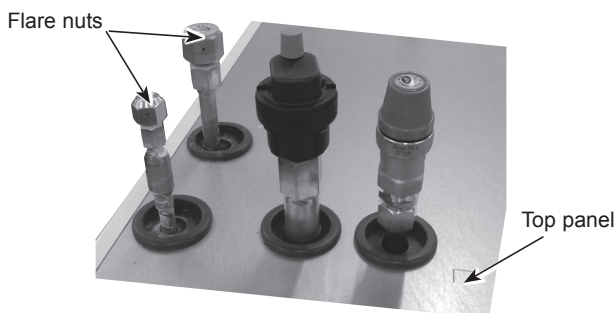

Photo 10-6



Note: The photos shown are of the ERST17D-YM9BD model.

Photo 10-3



Continue to the next page.



From the previous page.

## DISASSEMBLY PROCEDURE

### 10. How to remove the plate heat exchanger (P-HEX) (Refrigerant - Water)

- (7) Remove the thermistor (TH2) from the thermistor holder.  
(Refer to Procedure 21.)
- (8) Remove the manometer with the manometer cover.  
(Refer to Procedure 12.)
- (9) Loosen the flare nuts for Air vent (automatic) and pressure relief valve (3 bar), and remove the Air vent (automatic) and pressure relief valve (3 bar) together with the flare joints. (Refer to Procedure 12.)
- (10) Loosen and remove the flare nut which connects the expansion vessel. (Photo 13-1)
- (11) Loosen and remove the flare nut on booster heater, then remove the pipe. (over B.H.) (Photo 10-4)
- (12) Remove the strainer valve, the water pump and the pump valve. (Refer to Procedure 5.)
- (13) Remove the quick connection on 3-way valve to make the connection part free. (Photo 6-1 and 6-2)
  - When reinstalling the quick connection, use a new O-ring.
  - Refer to Procedure 25 for how to attach and detach the quick connection.
- (14) Remove the booster heater. (Refer to Procedure 8.)
- (15) Remove the water coil cover, the W.C. top cover (Only E\*\*T\*\*C series) and the pump stay by removing the screws. (Photo 10-5)
  - Reuse these 3 plates and fixing screws.
- (16) Pull out the P-HEX.

### 11. How to remove the pressure sensor <Only E\*ST\*\*D series>

- (1) Remove the plate heat exchanger. (Refer to Procedure 10.)
  - (2) Remove the welded part of the pressure sensor.  
Be sure not to burn the pipe cover. (Photo 11.)
- Note: The temperature of the pressure sensor must be 100 °C or below when welding.

## PHOTOS/FIGURES

Photo 10-4

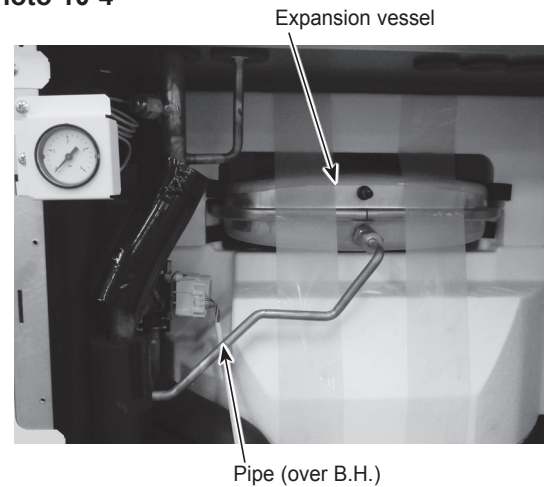

Photo 10-5

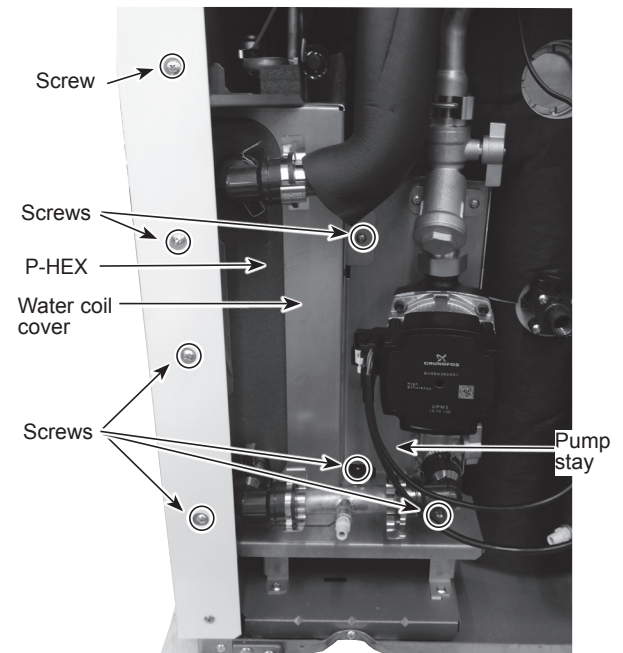
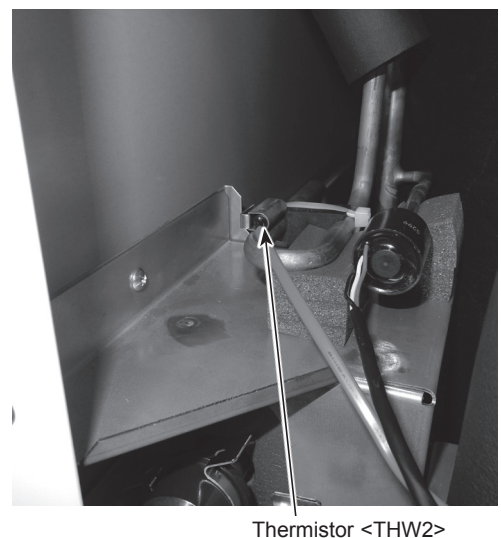

Photo 11



## DISASSEMBLY PROCEDURE

### 12. How to remove the pressure relief valve/manometer/air vent (automatic)

- (1) Remove the front panel. (Refer to Procedure 1.)
- (2) Swing the control box to the front. (Refer to Procedure 4.)

#### <Manometer>

- (3) Remove the G1/4" nut from the pressure relief valve using 2 spanners: one to hold the joint (G1/4") and the other to turn the manometer connection. (Photo 12-1)
  - When reinstalling the G1/4" nut, use a new G1/4" gasket. (Photo 12-1)
- (4) Remove the 2 screws and remove the manometer stay with the manometer from the front frame (L) by sliding it upward. (Photos 12-1)
- (5) Remove the manometer from the manometer stay while pressing on the 2 claws. (Photo 12-2)
  - When reinstalling the manometer assembly on the unit, beware not to put strain on the root of the capillary tube as the capillary tube is easy to break at the root. (Photo 12-3)

## PHOTOS/FIGURES

Photo 12-1

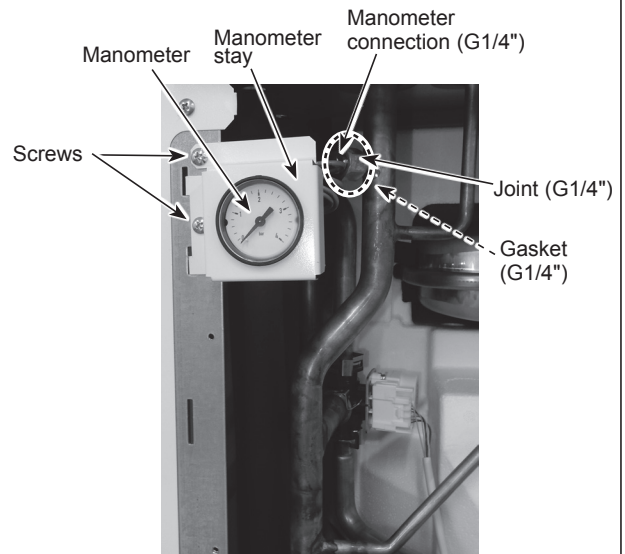

Photo 12-2

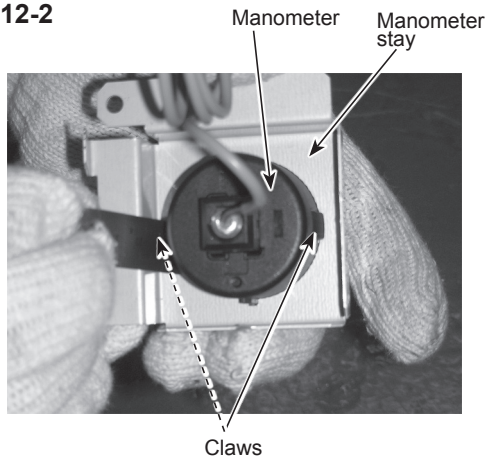
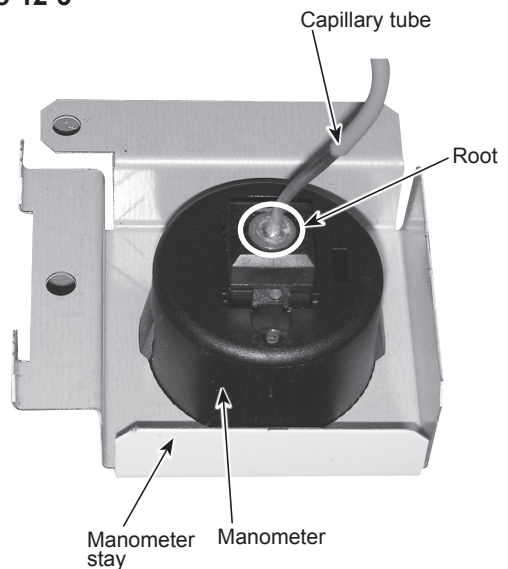

Photo 12-3



From the previous page.

## DISASSEMBLY PROCEDURE

### 12. How to remove the pressure relief valve/manometer/air vent (automatic)

#### <Pressure relief valve (3 bar)>

- (3) Remove the field piping from the pressure relief valve (3 bar). (Photo 12-4)
- (4) Remove the pressure relief valve (3 bar) with the flare joint using 2 spanners: one to hold the flare joint and the other to turn the flare nut. (Photo 12-4)
- (5) Remove the pressure relief valve (3 bar) using 2 spanners: one to hold the flare joint and the other to turn the pressure relief valve (3 bar). (Photo 12-5)
- (6) Eliminate loctite on the thread surfaces using remover.
  - Before reinstallation, apply loctite over the thread surface on the pressure relief valve.
  - For more details about the loctite and the remover, refer to Page 95.

#### <Air vent (automatic) (Except for ERST17D-\*\*\*BD model)>

- (3) Remove the air vent (automatic) using 2 spanners: one to hold the flare joint and the other to turn the flare nut. (Photos 12-4)

#### <Pressure relief valve (10 bar) (Except for EHPT20X-MHEDW model)>

- (3) Remove the field piping from the pressure relief valve (10 bar). (Photo 12-6)
- (4) Remove the pressure relief valve (10 bar) with the flare joint using 2 spanners: one to hold the flare joint and the other to turn the flare nut. (Photo 12-7)
- (5) Remove the pressure relief valve (10 bar) using 2 spanners: one to hold the flare joint and the other to turn the pressure relief valve (10 bar). (Photo 12-8)
- (6) Eliminate loctite on the thread surfaces using remover.
  - Before reinstallation, apply loctite over the thread surface on the pressure relief valve.
  - For more details about the loctite and the remover, refer to Page 95.

#### <Pressure relief valve (5 bar) (Except for ERST17D-\*\*\*BD model)>

- (3) Remove the pressure relief valve with a flare joint using 2 spanners: one to hold the flare joint and the other to turn the flare nut. (Photo 12-9)
- (4) Remove the flare joint from the pressure relief valve using 2 spanners: one to hold the flare joint and the other to turn the pressure relief valve. (Photo 12-9)
- (5) Eliminate loctite on the thread surfaces using remover.
  - Before reinstallation, apply loctite over the thread surface on the pressure relief valve.
  - For more details about the loctite and the remover, refer to page 95.
  - The outlet for the pressure relief valve (5bar) should be open ended and facing the rear panel.

## PHOTOS/FIGURES

Photo 12-4

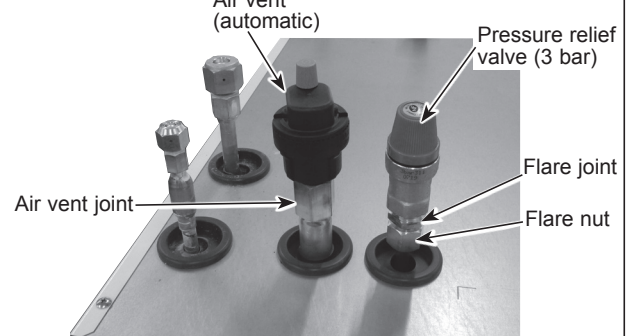

Photo 12-5

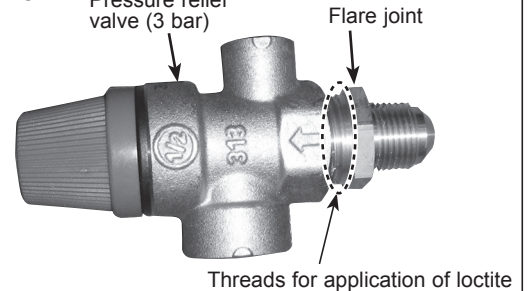

Photo 12-6 (Except for EHPT20X-MHEDW model)

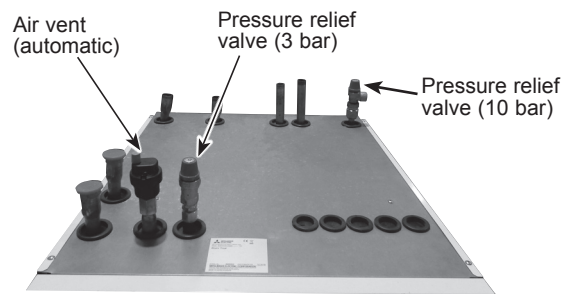

Photo 12-7

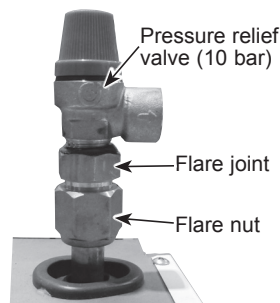

Photo 12-8

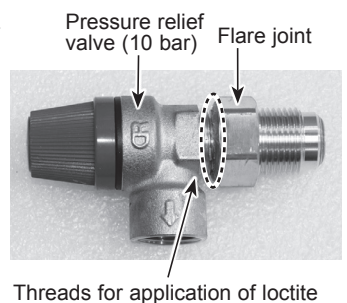
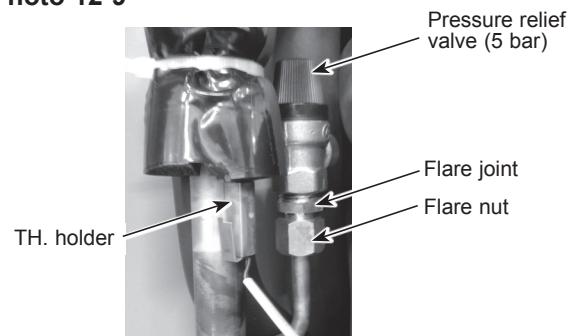

Photo 12-9



## DISASSEMBLY PROCEDURE

### 13. How to remove the expansion vessel

- (1) Remove the front panel. (Refer to Procedure 1.)
  - (2) Swing the control box to the front. (Refer to Procedure 4.)
  - (3) Remove 2 tapes. (Photo 13-1)
    - The removed tape can be disposed of.
  - (4) Remove the flare nut using 2 spanners: one to hold the flare joint and the other to turn the flare nut. (Photo 13-1)
  - (5) Displace the pipe slightly downward and pull out the expansion vessel. (Photo 13-1)
  - (6) Remove the flare joint from the expansion vessel. (Photo 13-2)
    - When reinstalling the flare joint, use a new G3/8" gasket.
- Note: To avoid dropping of the expansion vessel, hold it by hand when removing it.

## PHOTOS/FIGURES

Photo 13-1

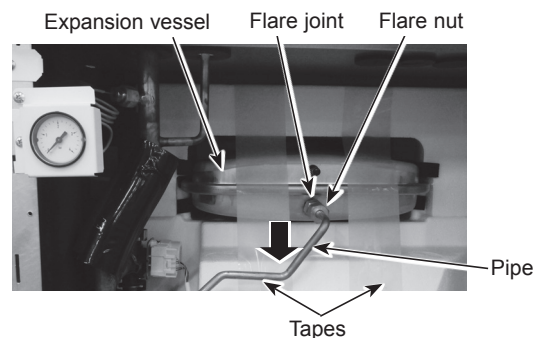
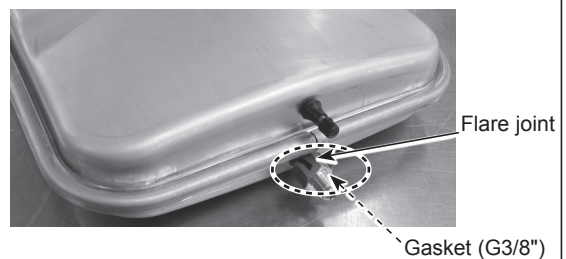

Photo 13-2



### 14. How to remove the temperature and pressure (T&P) relief valve (EHPT20X-MHEDW model)

- (1) Remove the front panel. (Refer to Procedure 1.)
- (2) Swing the control box to the front. (Refer to Procedure 4.)
- (3) Remove the field piping from the T&P relief valve.
- (4) Detach the quick connection. (Photo 14-1)
  - When reinstalling the quick connection, use a new O-ring.
  - Refer to Procedure 25 for how to attach and detach the quick connection.
- (5) Remove the T&P relief valve using 2 spanners: one to hold the T&P joint and the other to turn the T&P relief valve. (Photo 14-2)
- (6) Eliminate loctite on the thread surfaces using remover. (Photo 14-2)
  - Before reinstallation, apply loctite over the thread surface on the T&P relief valve and install the T&P relief valve with the T&P joint.
  - When reinstalling the T&P relief valve, point the nut to the bottom as specified. (Photo 14-1)
  - For more details about the loctite and the remover, refer to Page 95.

Photo 14-1

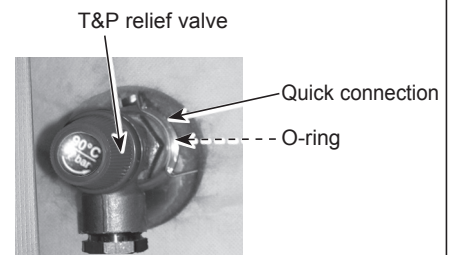
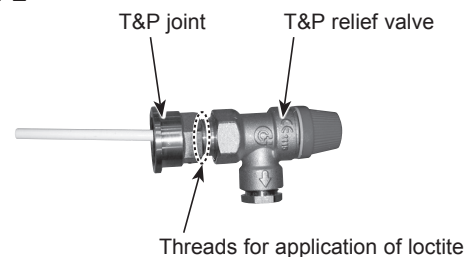

Photo 14-2



### 15. How to remove the air vent (manual)

- (1) Remove the front panel. (Refer to Procedure 1.)
- (2) Remove the air vent (manual) by turning the air vent (manual).

Photo 15

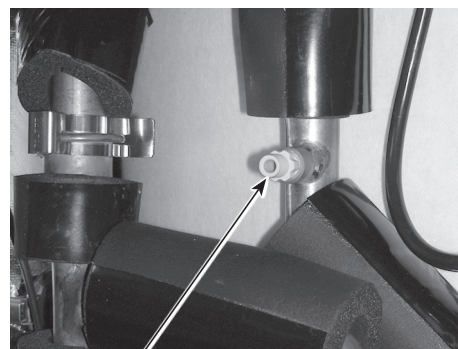

Air vent (manual)

## DISASSEMBLY PROCEDURE

### 16. How to remove the drain cock (primary circuit)

(1) Remove the front panel. (Refer to Procedure 1.)

#### <Pump valve side>

(2) Remove the drain cock from the pump valve by turning the drain cock. (Photo 16-1)

#### <Pipe side (for P-HEX)>

(2) Remove the drain cock from the pipe by turning the drain cock. (Photo 16-1)

#### <Pipe side (Only EHPT20X series)>

(2) Remove the drain cock from the pipe by turning the drain cock. (Photo 16-2)

## PHOTOS/FIGURES

Photo 16-1

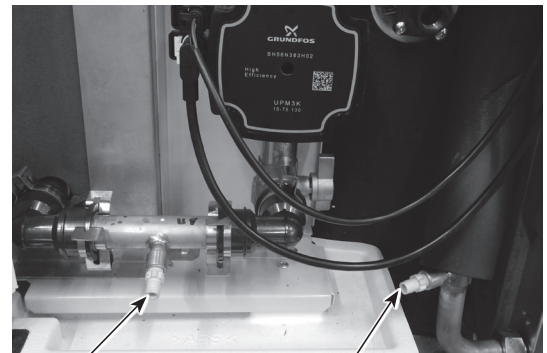

Drain cock  
(Pump valve side)

Drain cock for P-HEX  
(Pipe side)

Photo 16-2

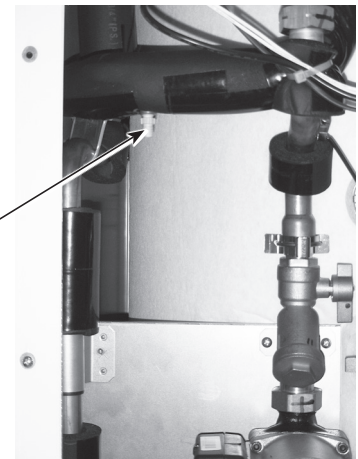

Drain cock  
(Pipe side)

### 17. How to remove the drain cock (sanitary circuit)

(1) Remove the front panel. (Refer to Procedure 1.)

#### <DHW tank side>

(2) Remove the drain cock by detaching the quick connection. (Photo 17-1)

- When reinstalling the quick connection, use a new O-ring.
- Refer to Procedure 25 for how to attach and detach the quick connection.

#### <P-HEX (Water-Water) side>

(2) Remove the drain cock from the P-HEX (Water-Water) by turning the drain cock. (Photo 17-2)

Photo 17-1

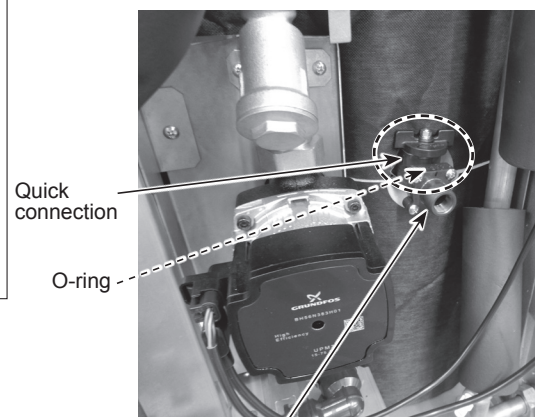

Quick connection

O-ring

Drain cock (DHW tank side)

Photo 17-2

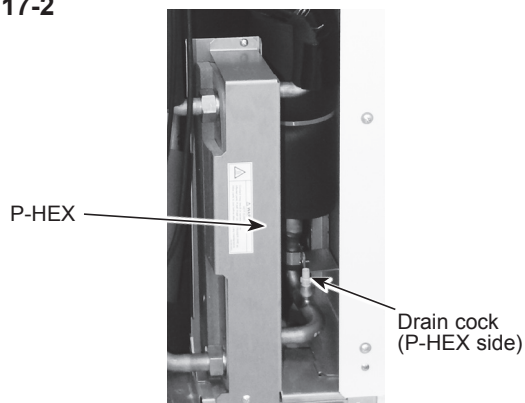

P-HEX

Drain cock  
(P-HEX side)

## DISASSEMBLY PROCEDURE

### 18. How to remove the plate heat exchanger (P-HEX) <Water - Water>

- (1) Remove the front panel. (Refer to Procedure 1.)
- (2) Drain water in the P-HEX (Water-Water) using the drain cock (Primary circuit) and the drain cock (Sanitary circuit). (Photo 18-1)
- (3) Remove the 4 G3/4" nuts.
  - When reinstalling the nuts, use new G3/4" gaskets.
- (4) Remove the P-HEX (Water-Water). (Photo 18-2)
- (5) Remove the drain cock (sanitary circuit). (Photo 18-1)
  - When reinstalling the drain cock
  - When reinstalling the drain cock (sanitary circuit), use a new one.

Photo 18-2



P-HEX (Water-Water)

P-HEX (Water-Water) (inside)

Drain cock (Primary circuit)

Nut (G3/4")

Gasket (G3/4")

## PHOTOS/FIGURES

Photo 18-1

Gasket (G3/4")

Nut (G3/4")

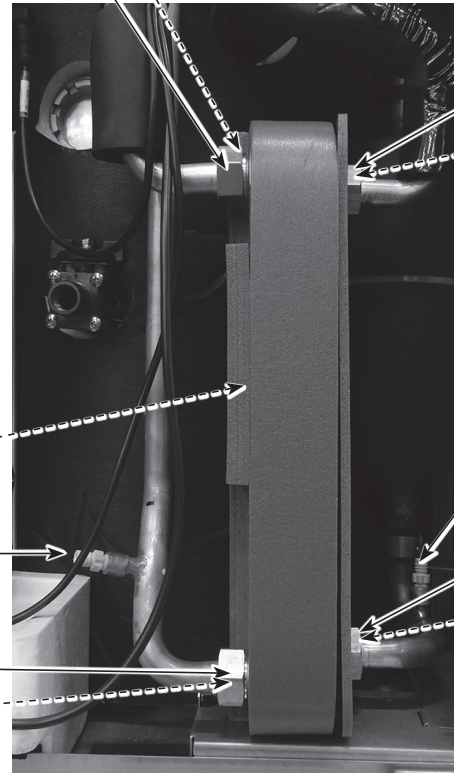

Nut (G3/4")

Gasket (G3/4")

Drain cock (Sanitary circuit)

Nut (G3/4")

Gasket (G3/4")

### 19. How to remove the water pump (sanitary circuit)

- (1) Remove the front panel. (Refer to Procedure 1.)
- (2) Disconnect the CNP4 connector and the earth cable in the control box. (Photo 4-2)
- (3) Release the water pump lead wire from the cable clamp and the cable strap in the control box, the cable strap, the fastener and the band below the control box. (Photos 4-1, 10-1 and 10-6)
- (4) Remove the pipe (tank-W.C.) by remove the 2 G3/4" nuts. (Photo 19)
  - When reinstalling the G3/4" nuts, use a new G3/4" gaskets.
- (5) Remove the 2 screws to remove the st band. (Photo 19)
- (6) Remove the 2 screws to remove the W.P. support. (Photo 19)
- (7) Remove the water pump (sanitary circuit) by removing the two G1" nuts using the 2 spanners, one to hold the G1" nut and the other to turn the other side of G1" nut. (Photo 19)
  - When reinstalling the G1" nuts, use a new G1" gaskets.
  - Set the water pump in the orientation of the arrow printed on the water pump and in the way that the terminal box faces to the left. (Photo 19)
  - Set the pump speed of the newly installed water pump to " II ". (Photo 19)

Photo 19

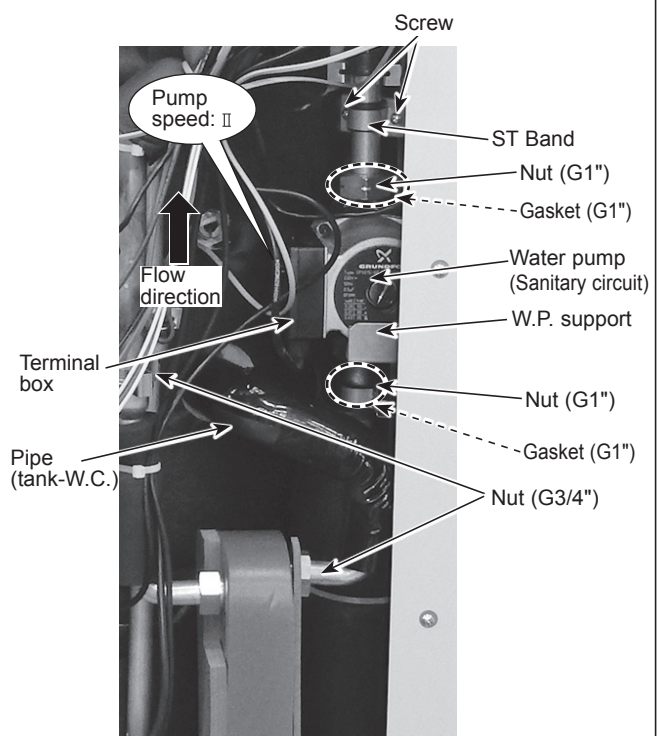

Screw

ST Band

Nut (G1")

Gasket (G1")

Water pump (Sanitary circuit)

W.P. support

Nut (G1")

Gasket (G1")

Nut (G3/4")

Terminal box

Pipe (tank-W.C.)

Pump speed: II

Flow direction

## DISASSEMBLY PROCEDURE

### 20. How to remove the scale trap (sanitary circuit)

- (1) Remove the front panel. (Refer to Procedure 1.)
- (2) Disconnect the CNP4 connector and the earth cable in the control box. (Photo 4-1)
- (3) Release the water pump lead wire from the cable clamp and the cable strap in the control box, the cable strap, the fastener and the band below the control box. (Photos 4-1, 10-1 and 10-6)
- (4) Remove the P-HEX (Water-Water). (Refer to Procedure 18.)
- (5) Remove the water pump. (Refer to Procedure 19.)
- (6) Rotate pipe (W.P. - Tank) side up.
- (7) Remove the 3 screws (Right side) and screw (fixing the S.T.-W.P. support). (Photos 20-1 and 20-2)
- (8) Remove the scale trap with the S.T.-W.P. support. (Photo 20-2)
- (9) Remove the screws and the saddle band, then remove the scale trap. (Photo 20-2)
  - When reinstalling the G1" nut, use a new G1" gasket.
  - Reuse the saddle band and the screws.

## PHOTOS/FIGURES

Photo 20-1

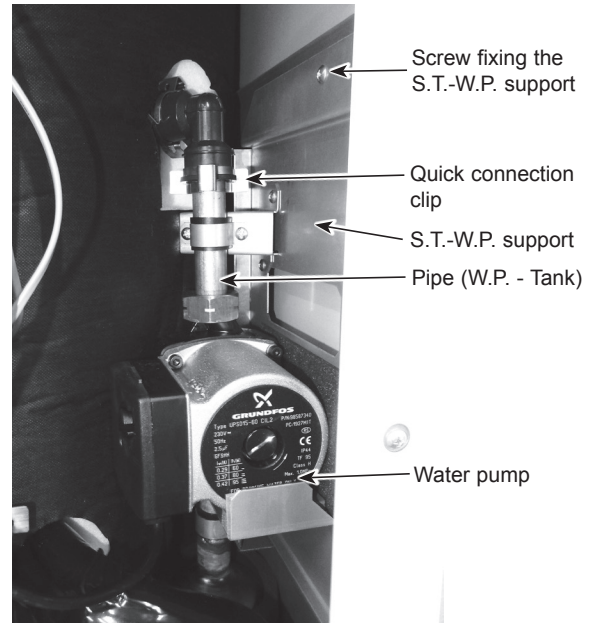
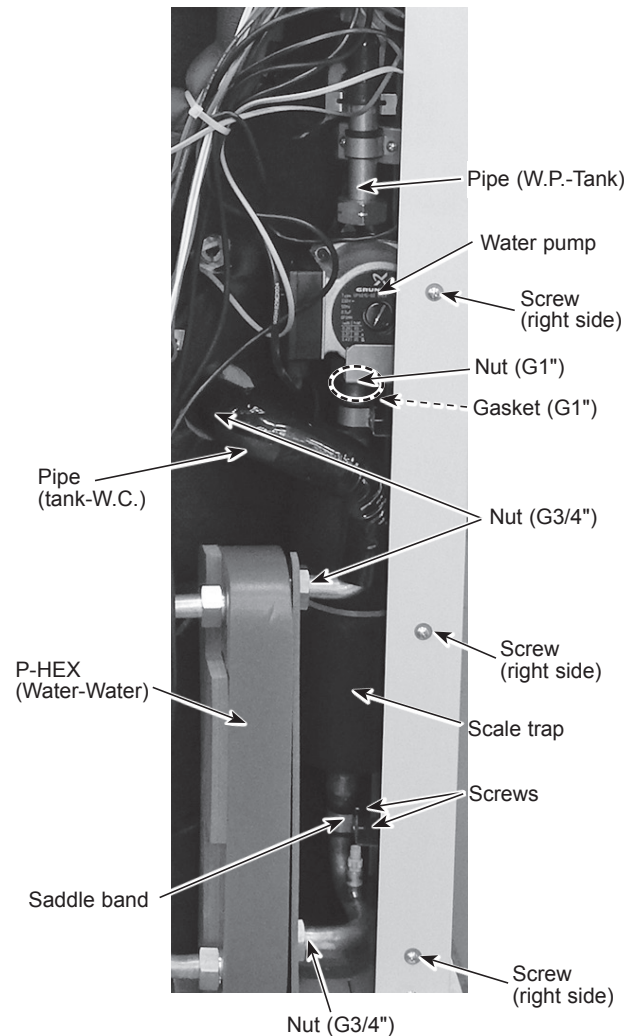

Photo 20-2



## DISASSEMBLY PROCEDURE

### 21. How to remove the liquid refrigerant temp. thermistor (TH2) /flow water temp. & return water temp. thermistors (THW1,THW2) /tank water temp. thermistor (THW5)

- (1) Remove the front panel. (Refer to Procedure 1)
- (2) Disconnect the following thermistor connectors on the controller board and release the lead wires from cable clamps and bands. (Photos 21-1 and 21-3)
  - TH2 (CN21) (cable clamp, cable strap, coated clamp and band)
  - THW1, THW2 (CNW12) (cable clamp, cable strap, coated clamp and band)
  - THW5A, THW5B (CNW5) (cable clamp, cable strap, coated clamp and band)
- (3) Remove the thermistors from the thermistor holders. (Photos 21-1 and 21-2)

## PHOTOS/FIGURES

Photo 21-1

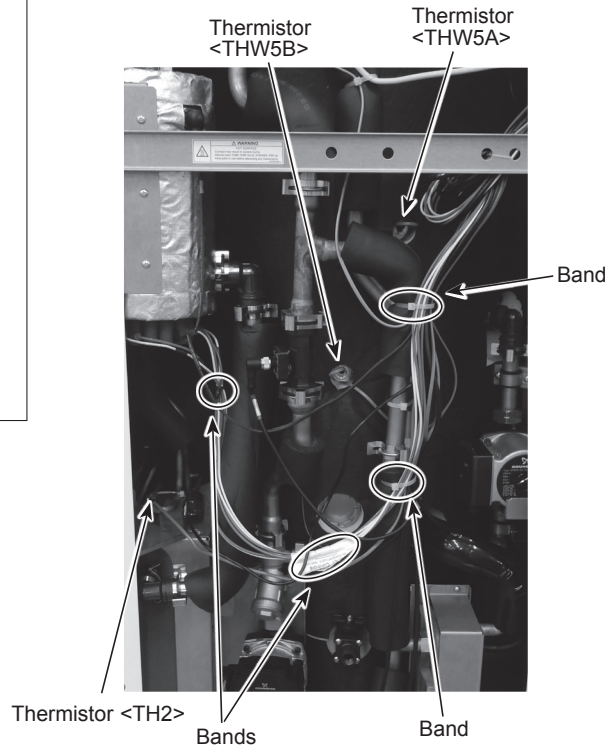
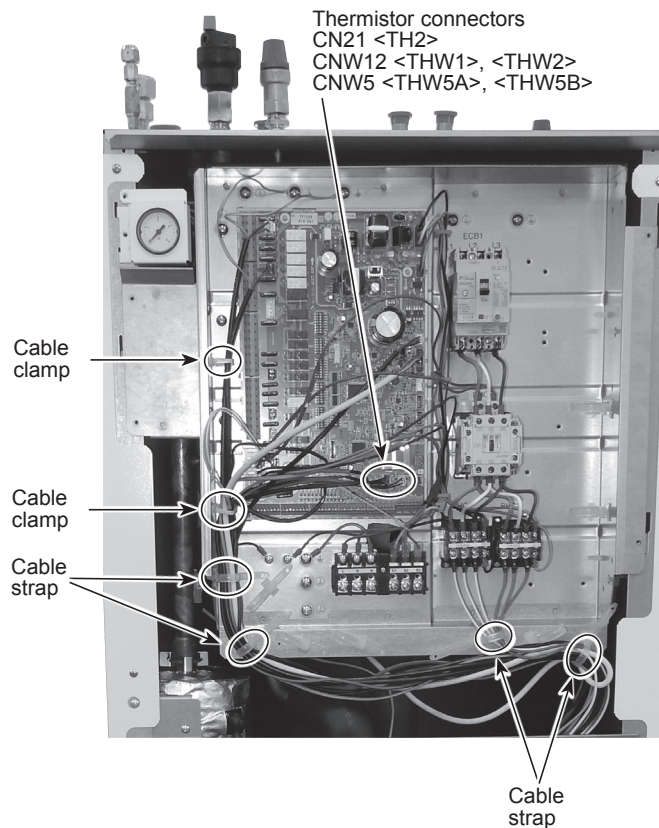

Photo 21-2



Thermistor <THW2>

Photo 21-3





## DISASSEMBLY PROCEDURE

### 22. How to remove the side panels

- (1) Remove the front panel. (Refer to Procedure 1.)
- (2) Remove the 4 screws on the top panel, and remove the 2 screws that hold the top panel onto the back panel. (Photos 22-2 and 24-1)
- (3) Remove the side panel (right) by removing the screw fixing the side panel (right). (Photo 22-1)
- (4) Remove the side panel (left) by removing the screw fixing the side panel (left). (the front side and the back side.)

#### <V/M plate (Only EHPT20X-MHEDW model)>

- (1) Remove the V/M plate by removing 5 screws fixing on the side panel (Right). (Photo 22-1)

#### <Only E\*\*T30\* series>

- (1) Remove the front panel top and under.
- (2) Remove the side panel top.
- (3) Remove the side panel under.

## PHOTOS/FIGURES

Photo 22-1

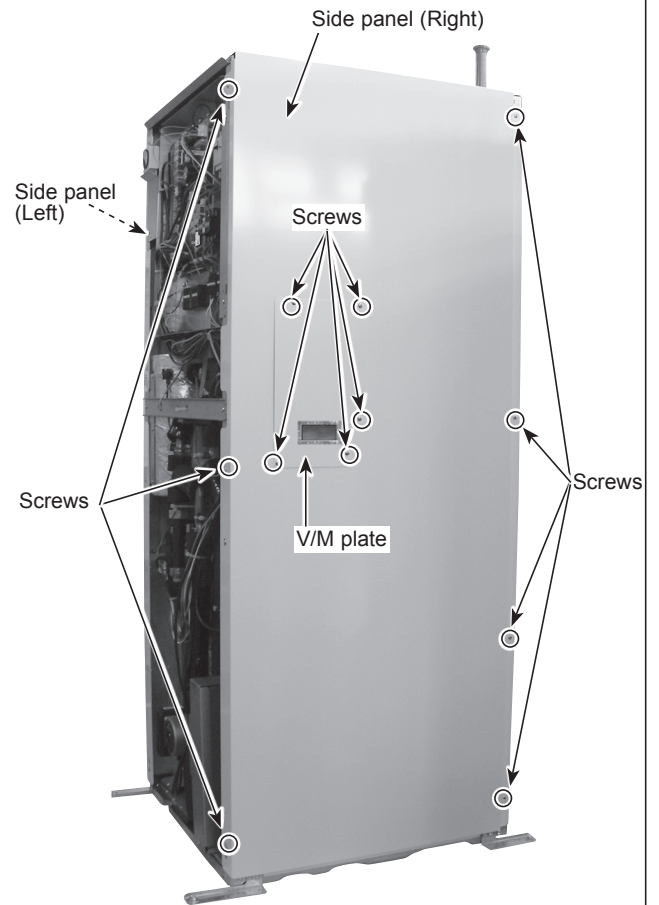
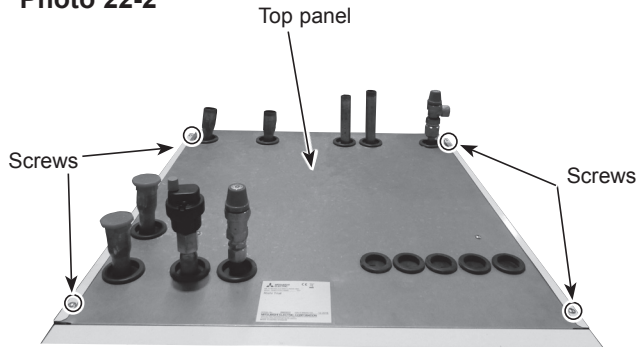

Photo 22-2



### 23. How to remove the drain pan

- (1) Remove the front panel. (Refer to Procedure 1.)  
(Remove the front panel under only for ER\*T30\* series.)
- (2) Remove the side panel left. (Refer to Procedure 22.)  
(Remove the side panel left under only for ER\*T30\* series.)
- (3) Remove the water pump (primary circuit) / pump valve / strainer valve. (Refer to Procedure 5.)

#### <ER\*T\*\*X series>

- (4) Remove the pump stay.

#### <ER\*T\*\*C/D series>

- (4) Remove the plate heat exchanger (P-HEX). (Refer to Procedure 10.)
- (5) Cut the band at the end of the hose connected to the drain pan. (Photo 23)
- (6) Remove the hose from drain pan. (Photo 23)
- (7) Lift up and remove the drain pan. (Photo 23)

#### <CAUTION>

Do not let the drain hose curve upwards.

Photo 23

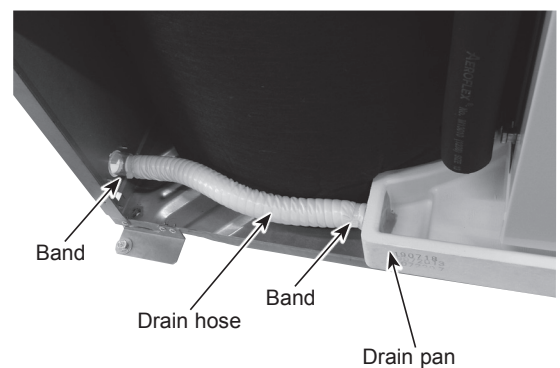

## DISASSEMBLY PROCEDURE

### 24. How to remove the back panel

- (1) Remove the front panel. (Refer to Procedure 1.)
- (2) Remove the side panels. (Refer to Procedure 22.)
- (3) Remove the 4 screws on the back panel, and remove the 2 screws that hold the back panel onto the frame. Then pull out the back panel while lifting the top panel. (Photos 24-1 and 24-2)

Note:

The handles are removed by pushing them up.

## PHOTOS/FIGURES

Photo 24-1



Photo 24-2

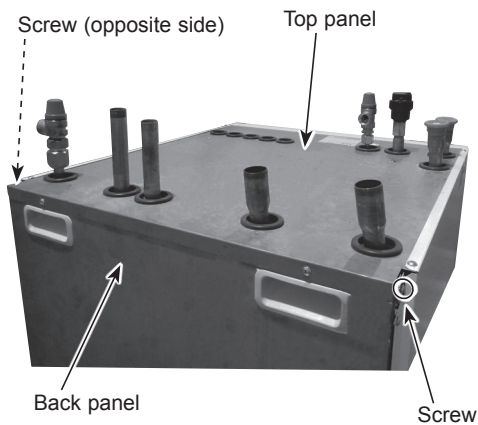

Note: The photo shows the left side.

The opposite side also has the screw to be removed on the same position.

## DISASSEMBLY PROCEDURE

### 25. How to detach and attach the quick connection

Refer to the following steps when detaching and attaching the quick connection.

- (1) Remove the clip. (Photos 25-1 and 25-2)
- (2) Separate the connected parts to remove the O-ring. (Photo 25-3)
  - Do not reuse the removed O-ring.
  - Wipe off if dirt or foreign matters are found on the sealing surface where the O-ring touches.
- (3) Apply grease on the O-ring using a plastic bag, etc. (Photo 25-4)
- (4) Attach the O-ring to the male part of quick connection. (Photo 25-5)
  - Keep the O-ring free from dirt or foreign matters.
- (5) Connect the male and female parts of the quick connection. (Photo 25-6)
- (6) Attach the clip. (Photo 25-7)
  - Ensure to attach the wider diameter of the clip to the female side. Failure to do so it may cause water leak at the connected part. (Photo 25-8) (For the same diameter quick connection, following this note is not necessary.)

## PHOTOS/FIGURES

Photo 25-1

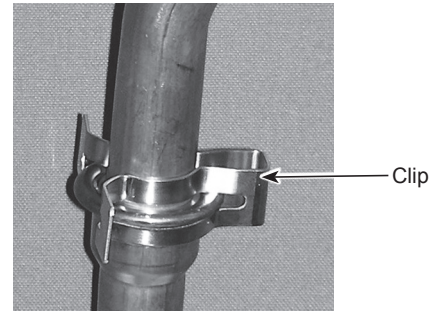

Photo 25-2

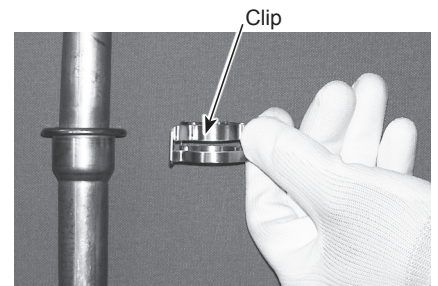

Photo 25-3

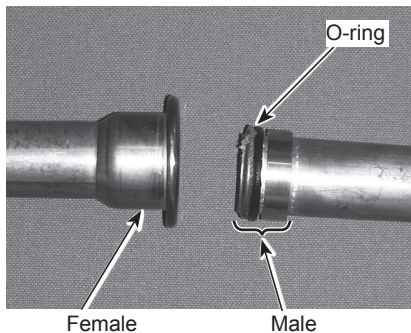

Photo 25-4

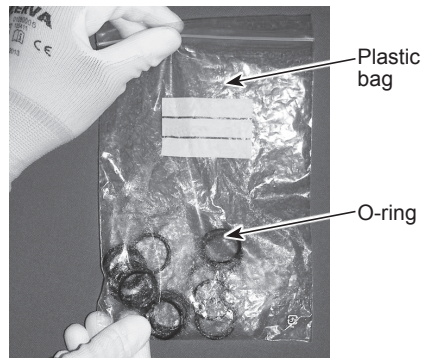

Photo 25-5



Photo 25-6

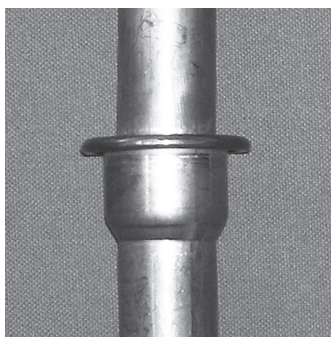

Photo 25-7

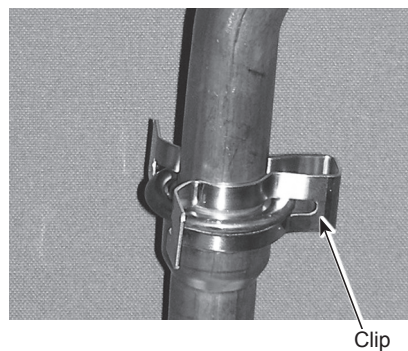
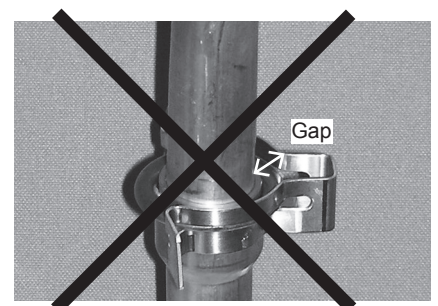

Photo 25-8





**DISASSEMBLY PROCEDURE**

**26. How to remove the multi function group (ERST17D-\*\*\*BD model)**

- (1) Remove the front panel. (Refer to Procedure 1.)
- (2) Remove the DIV frame by cutting the band and removing the 4 screws on it.(Photo 10-6)
- (3) Remove the multi function group by detaching the same diameter quick connection. (Photos 26)
  - When reinstalling the multi function group, use new O-rings. (Photos 26)
  - Refer to Procedure 25 for how to attach and detach the quick connection.

Note: Set the multi function group in the direction of the arrow printed on the multi function group. (Photo 26)

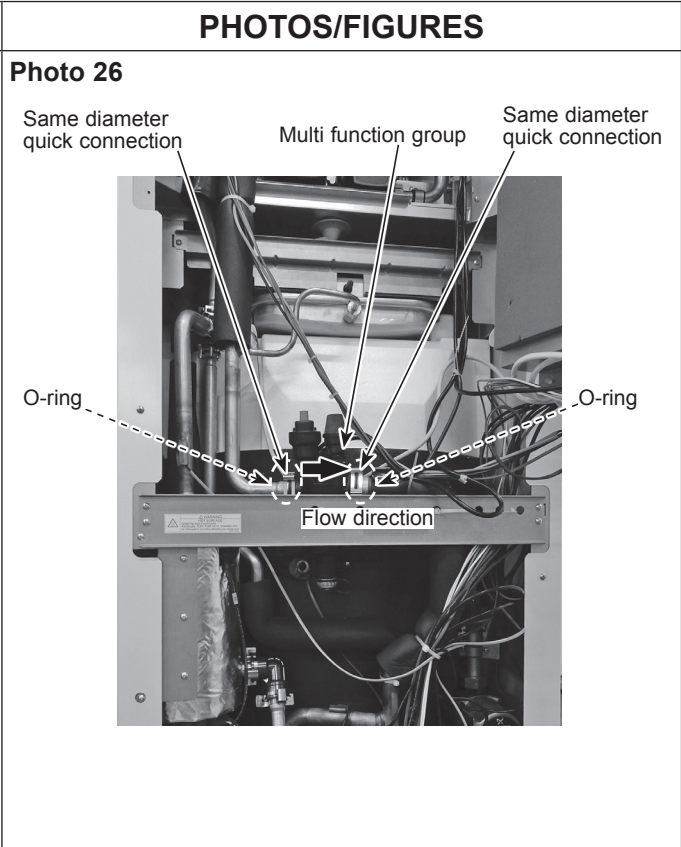

**27. How to remove the water pump (zone 1 and zone 2) (ERST17D-\*\*\*BD model)**

- (1) Remove the front panel. (Refer to Procedure 1.)
- (2) Disconnect the relay connector (Pump zone1 and Pump zone2) under the control box. (Photo 4-4)
- (3) Release the water pump lead wire from the cable clamp, the fastener and the cable strap in the control box, and the cable strap, the fastener and the band below the control box. (Photos 4-1, 10-6 and 27)
- (4) Remove the water pump by removing the two G1" nuts using the 2 spanners: one to hold the G1" nut and the other to turn the other side of G1" nut. Remove the water pump by sliding it vertical. (Photo 27)
  - When reinstalling the G1" nuts, use new G1" gaskets.
  - Set the water pump in the way that the die stamped arrow facing right, and the lead wire connectors to the top. (Photo 27)
  - Be sure to change the pump and the water pump lead wire together.
  - Be sure to wipe water around the surface of the pump and the water pump lead wire thoroughly.

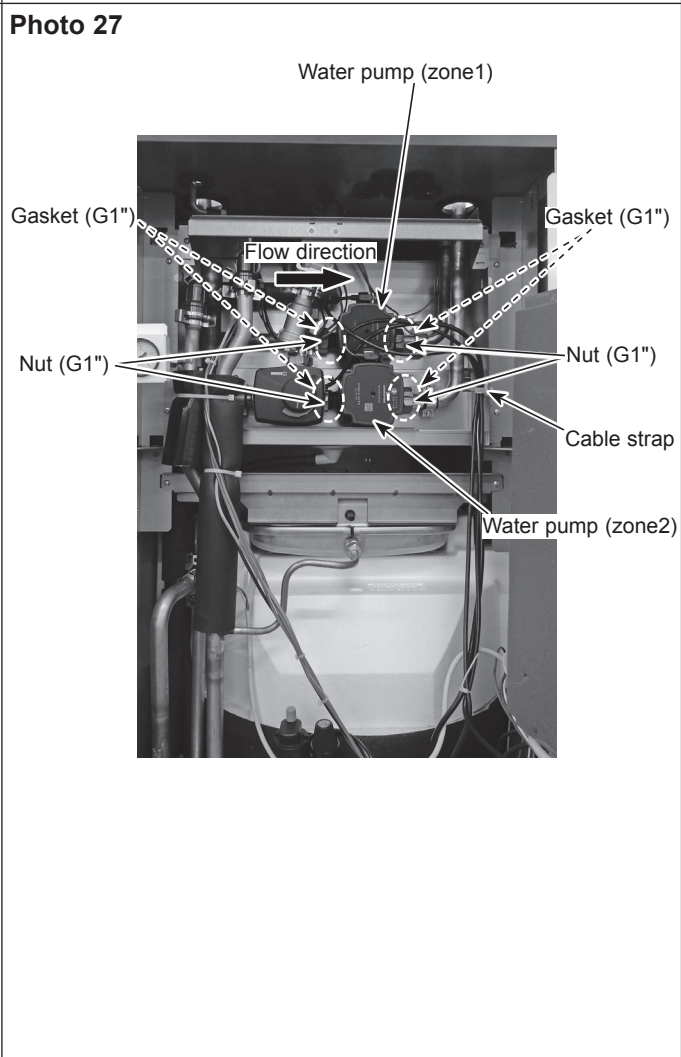

## DISASSEMBLY PROCEDURE

### 28. How to remove the mixing valve (ERST17D-\*\*\*BD model)

- (1) Remove the front panel. (Refer to Procedure 1.)
- (2) Disconnect the relay connector (Mixing valve) under the control box. (Photo 4-4)
- (3) Release the water pump lead wire from the cable clamp, the fastener and the cable strap in the control box, and the cable strap, the fastener and the band below the control box. (Photos 4-1, 10-6 and 28-1)
- (4) Pull the mixing valve motor and remove it.
- (5) Remove the mixing valve body by removing the three G1" nuts using the 2 spanners: one to hold the G1" nut and the other to turn the other side of G1" nut. Remove the mixing valve by sliding it vertical. (Photo 28-2)
  - When reinstalling the G1" nuts, use new G1" gaskets.
  - Be sure to change the pump and the mixing valve lead wire together.
  - Be sure to wipe water around the surface of the pump and the water pump lead wire thoroughly.

**Note:**

Before replacing the mixing valve, be sure to power off the cylinder unit.  
Failure to do so may cause electric shock or cause the mixing valve to malfunction.

## PHOTOS/FIGURES

Photo 28-1

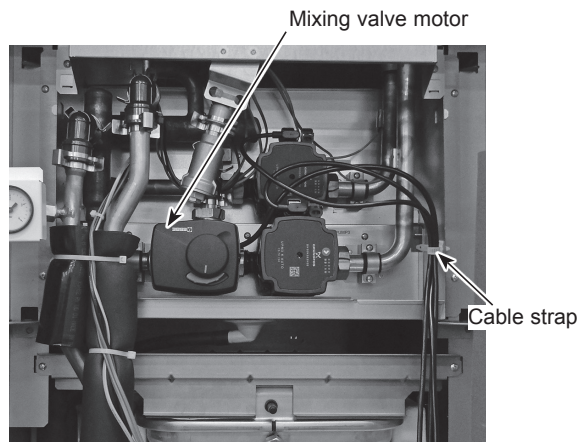
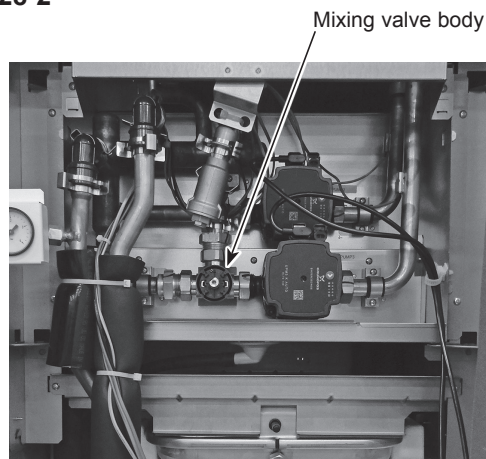

Photo 28-2



### 29. How to remove the magnetic filter (ERST17D-\*\*\*BD model)

- (1) Remove the front panel. (Refer to Procedure 1.)
- (2) Detach the 2 quick connections. (Photos 29)
  - When reinstalling the quick connections, use new O-rings.
  - Refer to Procedure 25 for how to attach and detach the quick connection.
- (3) Remove the Magnetic filter by carefully pulling it. (Photo 29)

Photo 29

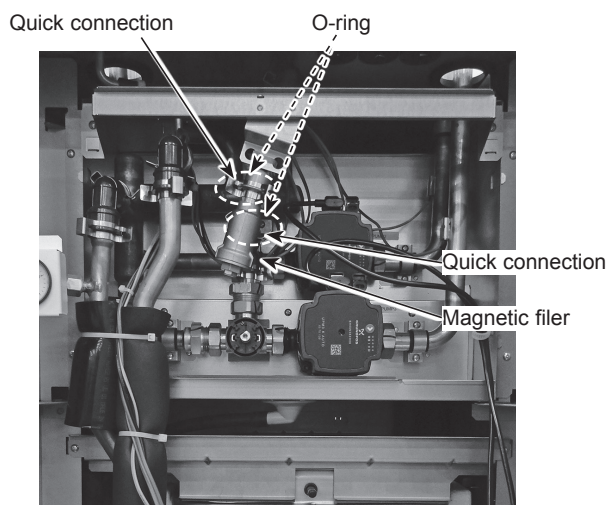



## Notes on replacing the parts

Replacement of the parts listed below requires the following procedure.

After the parts are removed, eliminate loctite on threads by applying loctite remover, apply new loctite, and then install and tighten the parts to the specified tightening torques below. For details about recommended loctite and loctite remover, refer to Table 11-1, and for details about the replacement parts and their tightening torques, refer to Table 11-2.

**Table 11-1**

Recommended	Manufacturer	No.	Applied parts	Note
Loctite	Henkel	Loctite 5400	PRESSURE RELIEF VALVE (3 bar and 10 bar)	Apply loctite all over from the end of external thread to the second ridge. After installing the parts, fix the parts for at least 30 minutes
		Loctite 5776	TEMPERATURE AND PRESSURE RELIEF VALVE	
Loctite remover	Henkel	Loctite 7200 Gasket Remover	PRESSURE RELIEF VALVE (3 bar and 10 bar) and TEMPERATURE AND PRESSURE RELIEF VALVE	Spray loctite remover over sealant on the threads, let the sealant sit until soft, and then eliminate it with a wire brush.

Note: When using the products above, refer to the appropriate manuals that come with the individual products.

**Table 11-2**

Part name *1	Recommended tightening torque [Nm] *2
PRESSURE RELIEF VALVE 3 bar	15 ± 1
PRESSURE RELIEF VALVE 5 bar	15 ± 1
PRESSURE RELIEF VALVE 10 bar	15 ± 1
TEMPERATURE AND PRESSURE RELIEF VALVE	15 ± 1

\*1. For more details about the listed parts refer to the parts catalogue.

\*2. Undertightening and overtightening the parts affect water seal life. Tighten the parts to the appropriate tightening torques.

When installing the parts that are not listed above, observe the tightening torques in accordance with Table 11-3.

Always use a new O-ring or gasket.

**Table 11-3**

Size [inch]		Recommended tightening torque [Nm]
Gasket	G1/4"	8 ± 1
	G3/8"	15 ± 1
	G3/4"	42 ± 2
	G1"	42 ± 2
	G1 3/4"	10 ± 1
Packing	Strainer cover	40 ± 2
	Flow sensor	30 ± 2
O-ring	Air vent (Automatic)	3.5 ± 1
Attached packing	Drain cock (primary circuit)	0.25 ± 0.05
	Drain cock (P-HEX sanitary circuit)	0.25 ± 0.05
	Air vent (manual)	0.25 ± 0.05
Flare joint (for water circuit parts)		35 ± 2

After the procedure is complete, ensure that no water leaks.

**■ Refrigerant collecting (pumpdown) for split model systems only**

Refer to "Refrigerant collection" in the outdoor unit installation manual or service manual.

**■ Back-up operation of boiler**

Heating operation is backed up by boiler.

For more details, refer to the installation manual of PAC-TH012HT(L)-E.

**<Installation & System set up>**

1. Set DIP-SW1-1 to ON "With boiler" and SW2-6 to ON "With Mixing tank".
2. Install the thermistors THWB1 (Flow temp.) \*1 on the boiler circuit.
3. Connect the output wire (OUT10: Boiler operation) to the input (room thermostat input) on the boiler. \*2
4. Install one of the following room temperature thermostats. \*3

- Wireless remote controller (option)
- Room temp. thermostat (local supply)
- Main remote controller (remote position)

\*1 The boiler temperature thermistor is an optional part.

\*2 OUT10 has no voltage across it.

\*3 Boiler heating is controlled on/off by the Room temp. thermostat.

**<Remote controller settings>**

1. Go to Service menu > Heat source setting and choose "Boiler" or "Hybrid". \*4
2. Go to Service menu > Operation settings > Boiler settings to make detailed settings for "Hybrid" above.

\*4 The "Hybrid" automatically switches heat sources between Heat pump (and Electric heater) and boiler.



## Engineers Forms

Should settings be changed from default, please enter and record new setting in 'Field Setting' column. This will ease resetting in the future should the system use change or the circuit board need to be replaced.

## Commissioning/Field settings record sheet

Main remote controller screen		Parameters	Default setting	Field setting	Notes	
Main	Zone1 heating room temp.		10°C to 30°C	20°C		
	Zone2 heating room temp. *1		10°C to 30°C	20°C		
	Zone1 heating flow temp.		20°C to 60°C	45°C		
	Zone2 heating flow temp. *2		20°C to 60°C	35°C		
	Zone1 cooling flow temp. *3		5°C to 25°C	15°C		
	Zone2 cooling flow temp. *3		5°C to 25°C	20°C		
	Zone1 heating compensation curve		-9°C to +9°C	0°C		
	Zone2 heating compensation curve *2		-9°C to +9°C	0°C		
Option	Holiday mode		Active/Non active/Set time	—		
	Forced DHW operation		On/Off	—		
	DHW		On/Off/Timer	On		
	Heating/Cooling *3		On/Off/Timer	On		
Setting	DHW	Energy monitor		Consumed electrical energy/Delivered energy	—	
		Operation mode		Normal/Eco *4	Normal	
		DHW max. temp.		40°C to 60°C *5	50°C	
		DHW temp. drop		5°C to 30°C	10°C	
		DHW max. operation time		30 to 120 min	60 min	
		DHW mode restriction		30 to 120 min	30 min	
	Legionella prevention	DHW recharge		Large/Standard	Standard	
		Active		Yes/No	Yes	
		Hot water temp.		60°C to 70°C *5	65°C	
		Frequency		1 to 30 days	15 days	
		Start time		00.00 to 23.00	03.00	
		Max. operation time		1 to 5 hours	3 hours	
	Heating/Cooling *3	Duration of maximum temp.		1 to 120 min	30 min	
		Zone1 operation mode		Heating room temp./ Heating flow temp./ Heating compensation curve/ Cooling flow temp.	Room temp.	
	Compensation curve	Hi flow temp. set point	Zone2 operation mode *2		Heating room temp./ Heating flow temp./ Heating compensation curve/ Cooling flow temp.	Compensation curve
			Zone1 outdoor ambient temp.		-30°C to +33°C *6	-15°C
			Zone1 flow temp.		20°C to 60°C	50°C
			Zone2 outdoor ambient temp. *2		-30°C to +33°C *6	-15°C
		Lo flow temp. set point	Zone2 flow temp. *2		20°C to 60°C	40°C
			Zone1 outdoor ambient temp.		-28°C to +35°C *7	35°C
			Zone1 flow temp.		20°C to 60°C	25°C
			Zone2 outdoor ambient temp. *2		-28°C to +35°C *7	35°C
		Adjust	Zone2 flow temp. *2		20°C to 60°C	25°C
			Zone1 outdoor ambient temp.		-29°C to +34°C *8	—
			Zone1 flow temp.		20°C to 60°C	—
			Zone2 outdoor ambient temp. *2		-29°C to +34°C *8	—
	Holiday	Zone2 flow temp. *2		20°C to 60°C	—	
		DHW		Active/Non active	Non active	
		Heating/Cooling *3		Active/Non active	Active	
		Zone1 heating room temp.		10°C to 30°C	15°C	
		Zone2 heating room temp. *1		10°C to 30°C	15°C	
		Zone1 heating flow temp.		20°C to 60°C	35°C	
Zone2 heating flow temp. *2		20°C to 60°C	25°C			
Zone1 cooling flow temp. *3		5°C to 25°C	25°C			
Initial settings	Zone2 cooling flow temp. *3		5°C to 25°C	25°C		
	Language		EN/FR/DE/SV/ES/IT/DA/NL/FI/NO/PT/BG/PL/CZ/RU/TR/SL	EN		
	°C/°F		°C/°F	°C		
	Summer time		On/Off	Off		
	Temp. display		Room/DHW tank/Room&DHW tank /Off	Off		
	Time display		hh:mm/hh:mm AM/AM hh:mm	hh:mm		
	Room sensor settings for Zone1		TH1/Main RC/Room RC1 to 8/"Time/Zone"	TH1		
	Room sensor settings for Zone2 *2		TH1/Main RC/Room RC1 to 8/"Time/Zone"	TH1		
Service menu	Room RC zone select *2		Zone1/Zone2	Zone1		
	Thermistor adjustment	THW1	-10°C to +10°C	0°C		
		THW2	-10°C to +10°C	0°C		
		THW5A	-10°C to +10°C	0°C		
		THW5B	-10°C to +10°C	0°C		
		THW6	-10°C to +10°C	0°C		
		THW7	-10°C to +10°C	0°C		
		THW8	-10°C to +10°C	0°C		
		THW9	-10°C to +10°C	0°C		
		THW10	-10°C to +10°C	0°C		
		THWB1	-10°C to +10°C	0°C		
	Auxiliary settings	Economy settings for pump.		On/Off *9	On	
		Electric heater (Heating)		Delay (3 to 60 min)	10 min	
		Electric heater (DHW)		Space heating: On (used)/Off (not used)	On	
		Electric heater (DHW)		Electric heater delay timer (5 to 180 min)	30 min	
		Electric heater (DHW)		Booster heater DHW: On (used)/Off (not used)	On	
		Electric heater (DHW)		Immersion heater DHW: On (used)/Off (not used)	On	
		Mixing valve control		Electric heater delay timer (15 to 30 min)	15 min	
		Flow sensor *10		Running (10 to 240 sec)	120 sec	
		Flow sensor *10		Interval (1 to 30 min)	2 min	
Flow sensor *10		Minimum (0 to 100L/min)	5 L/min			
Flow sensor *10		Maximum (0 to 100L/min)	100 L/min			
Analog output		Interval (1 to 30 min)	5 min			
Analog output		Priority (Normal/High)	Normal			

Commissioning/Field settings record sheet (continued from the previous page)

Main remote controller screen			Parameters	Default setting	Field setting	Notes		
Setting	Service menu	Pump speed	DHW	Pump speed (1 to 5)	5			
			Heating/Cooling	Pump speed (1 to 5)	5			
		Heat source setting			Standard/Heater/Boiler/Hybrid *11	Standard		
			Heat pump setting	Heat pump flow rate range	Minimum(0 to 100L/min)	5 L/min		
		Maximum(0 to 100L/min)			100 L/min			
		Quiet mode		Day (Mon to Sun)	—			
				Time	0:00 - 23:45			
		Operation settings	Heating operation	Flow temp.range *12	Minimum.temp.(20 to 45°C)	30°C		
					Maximum.temp.(35 to 60°C)	50°C		
				Room temp.control *13	Mode (Normal/Fast)	Normal		
					Interval (10 to 60min)	10min		
				Heat pump thermo diff.adjust	On/Off *9	On		
					Lower limit (-9 to -1°C)	-5°C		
			Upper limit (+3 to +5°C)		5°C			
			Freeze stat function *14	Outdoor ambient temp. (3 to 20°C) / **		5°C		
			Simultaneous operation (DHW/Heating)	On/Off *9		Off		
				Outdoor ambient temp. (-30 to +10°C) *6		-15°C		
			Cold weather function	On/Off *9		Off		
				Outdoor ambient temp. (-30 to -10°C) *6		-15°C		
			Boiler operation	Hybrid settings	Outdoor ambient temp. (-30 to +10°C) *6		-15°C	
					Priority mode (Ambient/Cost/CO <sub>2</sub> ) *15	Ambient		
					Outdoor ambient temp. rise (+1 to +5 °C)	+3 °C		
				Intelligent settings	Energy price *16	Electricity (0.001 to 999 */kWh)	0.5 */kWh	
						Boiler (0.001 to 999 */kWh)	0.5 */kWh	
					CO <sub>2</sub> emission	Electricity (0.001 to 999 kg -CO <sub>2</sub> / kWh)	0.5 kg -CO <sub>2</sub> /kWh	
						Boiler (0.001 to 999 kg -CO <sub>2</sub> / kWh)	0.5 kg -CO <sub>2</sub> /kWh	
		Heat source		Heat pump capacity (1 to 40 kW)		11.2 kW		
				Boiler efficiency (25 to 150%)		80%		
				Booster heater 1 capacity (0 to 30 kW)		2 kW		
			Booster heater 2 capacity (0 to 30 kW)		4 kW			
		Smart grid ready	DHW	On/Off		Off		
				Target temp (+1 to +20°C) / -- (Non active)		--		
			Heating	On/Off		Off		
				Target temp.	Switch-on recommendation(20 to 60°C)	50°C		
					Switch-on command(20 to 60°C)	55°C		
			Cooling	On/Off		Off		
				Target temp.	Switch-on recommendation(5 to 25°C)	15°C		
					Switch-on command(5 to 25°C)	10°C		
		Pump cycles	Heating (On/Off)		On			
			Cooling (On/Off)		On			
				Interval(10 to 120 min)	10 min			
		Floor dry up function	On/Off *9		Off			
			Target temp.	Start&Finish (20 to 60°C)		30°C		
				Max. temp. (20 to 60°C)		45°C		
				Max. temp. period (1 to 20 days)		5 days		
			Flow temp. (Increase)	Temp. increase step (+1 to +10°C)		+5°C		
				Increase interval (1 to 7 days)		2 days		
			Flow temp. (Decrease)	Temp. decrease step (-1 to -10°C)		-5°C		
		Decrease interval (1 to 7 days)		2 days				
		Summer mode	On/Off		Off			
Outdoor ambient temp.	Heating ON (4 to 19°C)		10°C					
	Heating OFF (5 to 20°C)		15°C					
Judgement time	Heating ON (1 to 48 hours)		6 hours					
	Heating OFF (1 to 48 hours)		6 hours					
		Forced heating ON (-30 to 10°C)	5 °C					
Water flow control	On/Off		Off					

(Continued to next page.)

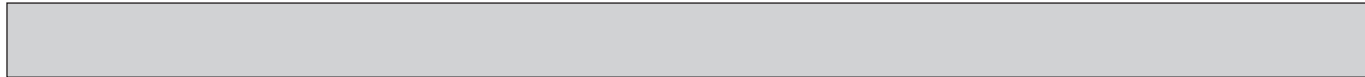

Commissioning/Field settings record sheet (continued from the previous page)

Main remote controller screen				Parameters	Default setting	Field setting	Notes		
Service menu	Energy monitor settings	Electric heater capacity	Booster heater 1 capacity	0 to 30 kW	2 kW				
			Booster heater 2 capacity	0 to 30 kW	4 kW				
			Immersion heater capacity	0 to 30 kW	0 kW				
			Analog output	0 to 30 kW	0 kW				
		Delivered energy adjustment			-50 to +50%	0%			
		Water pump input	Pump 1	0 to 200 W or *(factory fitted pump)		*			
			Pump 2	0 to 200 W		0 W			
			Pump 3	0 to 200 W		0 W			
			Pump 4	0 to 200 W		72 W			
		Electric energy meter *17		0.1/1/10/100/1000 pulse/kWh		1000 pulse/kWh			
		Heat meter *17		0.1/1/10/100/1000 pulse/kWh		1000 pulse/kWh			
		External input settings	Demand control (IN4)		Heat source OFF/Boiler operation		Boiler operation		
			Outdoor thermostat (IN5)		Heater operation/Boiler operation		Boiler operation		
		Thermo ON output		Zone1/Zone2/Zone1&2		Zone1&2			

- \*1 The settings related to Zone2 can be switched only when 2-zone temperature control or 2-Zone valve ON/OFF control is active.
- \*2 The settings related to Zone2 can be switched only when 2 zone temperature control is enabled (when DIP SW2-6 and SW2-7 are ON).
- \*3 Cooling mode settings are available for ER model only.
- \*4 When the cylinder unit is connected with a PUMY-P outdoor unit, the mode is fixed to "Normal".
- \*5 For the model without both booster and immersion heater, it may not reach the set temperature depending on the outside ambient temperature.
- \*6 The lower limit is -15°C depending on the connected outdoor unit.
- \*7 The lower limit is -13°C depending on the connected outdoor unit.
- \*8 The lower limit is -14°C depending on the connected outdoor unit.
- \*9 On: the function is active; Off: the function is inactive.
- \*10 Do not change the setting since it is set according to the specification of flow sensor attached to the cylinder unit.
- \*11 When DIP SW1-1 is set to OFF "WITHOUT Boiler" or SW2-6 is set to OFF "WITHOUT Mixing tank", neither Boiler nor Hybrid can be selected.
- \*12 Valid only when operating in Heating room temperature.
- \*13 When DIP SW5-2 is set to OFF, the function is active.
- \*14 If asterisk (\*\*) is chosen freeze stat function is deactivated. (i.e. primary water freeze risk)
- \*15 When the cylinder unit is connected with a PUMY-P outdoor unit, the mode is fixed to "Ambient".
- \*16 "\*" of "\*/kWh" represents currency unit (e.g. € or £ or the like)
- \*17 The default setting is 1 pulse/kWh depending on the connected indoor unit.

## Annual Maintenance Log Book

Contractor name		Engineer name	
Site name		Site number	
Cylinder unit maintenance record sheet			
Warranty number		Model number	
		Serial number	
No.	Mechanical	Frequency	Notes
1	Turn OFF water supply, drain DHW tank, remove mesh from strainer clean and replace in strainer. *1		
2	Keep water supply OFF, open hot water taps and check the primary-side expansion vessel charge pressure. Top up if necessary (1 bar).		
3	Keep water supply OFF and check the potable vessel charge pressure. Top up if necessary (3.5 bar).		
4	Keep water supply OFF. In hard water areas de-scaling of the immersion heaters may be required.		
5	Drop the primary/heating system pressure to zero check and if necessary top up the expansion vessel (1 bar). Air valve of expansion vessel is TR-412.		
6	Turn water supply ON, open the pressure relief valve and then the expansion relief valve in turn. Check for unrestricted discharge to the tundish and that the valves reseat correctly. Check there are no blockages in the tundish and associated pipework.		
7	Check and if necessary top up the concentration of anti-freeze/inhibitor (if used in the system).		
8	Top up the primary/heating system using a temporary backflow prevention filling loop and re-pressurise to 1 bar.		
9	Heat system and check pressure does not rise above 3 bar and no water is released from the safety valves.		
10	Release any air from the system.		
11	To check the 3-way valve for inside leaks, confirm that the temperature of the heat emitter does not rise when running the DHW mode.		
Refrigerant models only [except EHPT20 series]		Frequency	Notes
1	Refer to outdoor unit manual.		
Electrical		Frequency	Notes
1	Check condition of cables.		
2	Check rating and fuse fitted on the electricity supply.		
Controller		Frequency	Notes
1	Check field settings against factory recommendations.		
2	Check operation of motorized valves ensure they reseat correctly.		
3	Check battery power of wireless thermostat and replace if necessary.		
Outdoor heat pump unit maintenance record sheet			
Model number		Serial number	
	Mechanical	Frequency	Notes
1	Inspect grill and air inlet for trapped debris/damage.		
2	Check condensate drain provision.		
3	Check integrity of water pipework and insulation.		
4	Check all electrical connections.		
5	Check and record the operation voltage.		

\* Checks should be carried out once a year.

\*1 Be sure to reattach the mesh after washing.

**Note: Within the first couple of months of installation, remove and clean the cylinder unit's strainer mesh plus any that are fitted external to the cylinder unit. This is especially important when installing on an existing system.**

In addition to annual servicing, it is necessary to replace or inspect some parts after a certain period of system operation. Please see tables below for detailed instructions. Replacement and inspection of parts should always be done by a competent person with relevant training and qualifications.

### Parts which require regular replacement

Parts	Replace every	Possible failures
Pressure relief valve (3 bar) Air vent (Auto/Manual) Drain cock (Primary/Sanitary circuit) Manometer Inlet control group (ICG)* Mud trap	6 years	Water leakage

\* OPTIONAL PARTS for UK

### Parts which require regular inspection

Parts	Check every	Possible failures
Pressure relief valve (3bar) Temperature and pressure relief valve	1 year (turning the knob manually)	PRV could seize and risk burst of expansion vessel
Immersion heater	2 years	Earth leakage causing circuit breaker to activate (Heater is always OFF)
Water circulation pump (Primary circuit)	20,000 hrs (3 years)	Water circulation pump failure
Magnetic filter	3 years	Flow rate decrease due to clogging
Mud trap	1 year	Flow rate decrease due to clogging

### Parts which must NOT be re-used when servicing

\* O-ring

\* Gasket

**Note:**

- Always replace the gasket for pump with a new one at each regular maintenance (every 20,000 hours of use or every 3 years).



**<Draining particles from the magnetic filter>**

**WARNING: DRAINED WATER MAY BE VERY HOT**

1. Turn OFF the unit via the user interface.
2. Turn OFF the circuit breaker.
3. Check if body of the magnet filter is still screwed tight (a).
4. Close the isolating valves.
5. Hold the motor of mixing valve and pull hard to remove it from the valve.
6. Put a suitable bottle below the magnetic filter.
7. Open the cap of the filter with 2 spanners (b).
8. Collect the water and particles in the bottle.
9. Wash the inside mesh and magnet and remove particles from them.
10. Put the inside mesh and magnet back into the filter.
11. Screw the cap with 2 spanners.
12. Reattach the motor on the mixing valve.
13. Open the isolating valves.
14. Check the pressure of the water circuit.

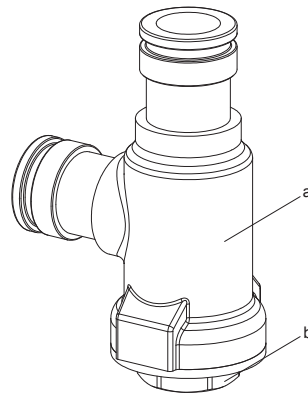

a body  
b cap

**<Draining dirt from the mud trap>**

**WARNING: DRAINED WATER MAY BE VERY HOT**

1. Turn OFF the unit via the user interface.
2. Turn OFF the circuit breaker.
3. Check if upper and lower parts of the mud trap are still screwed tight (a, c).
4. Take off the magnetic sleeve (b).
5. Unscrew the drain cap (e).
6. Connect a drain hose to the bottom of the mud trap so that the water and dirt can be collected in a suitable bottle.
7. Open the drain valve for a couple of seconds (d).
8. After dirt drained, close the drain valve.
9. Screw the drain cap back on.
10. Reattach the magnetic sleeve.
11. Check the pressure of the water circuit.

**Notes:**

- When checking the mud trap for tightness, hold it firmly, so as NOT to apply stress to the water piping.
- To prevent dirt from remaining in the mud trap, take off the magnetic sleeve.
- Always first unscrew the drain cap, and connect a drain hose to the bottom of the water filter, then open the drain valve.

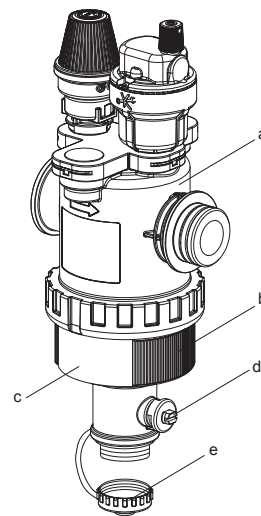

a upper part  
b magnetic sleeve  
c lower part  
d drain valve  
e drain cap

# MITSUBISHI ELECTRIC CORPORATION

HEAD OFFICE: TOKYO BUILDING, 2-7-3, MARUNOUCHI, CHIYODA-KU, TOKYO 100-8310, JAPAN

---

©Copyright 2019 MITSUBISHI ELECTRIC CORPORATION  
Issued: Mar. 2022 No. OCH714 REVISED EDITION-E  
Issued: Nov. 2021 No. OCH714 REVISED EDITION-D  
Issued: Jun. 2021 No. OCH714 REVISED EDITION-C  
Issued: Oct. 2020 No. OCH714 REVISED EDITION-B  
Issued: Mar. 2020 No. OCH714 REVISED EDITION-A  
Published: Nov. 2019 No. OCH714  
Made in Japan

Specifications are subject to change without notice.