

DIRECT EXPANSION COIL UNIT FOR LOSSNAY

MODELS:

GUG-01SL-E

GUG-02SL-E

GUG-03SL-E

Operating Instructions

DIRECT EXPANSION COIL UNIT FOR LOSSNAY

MODELS:

GUG-01SL-E

GUG-02SL-E

GUG-03SL-E

R410A only

Operating Instructions

(For the user)

Please read this manual carefully before use for proper and safe use.

Do not attempt to install the product by yourself.





Contents

Safety precautions.....	1
Names of the parts	3
System configuration	4
Remote controller (PZ-01RC).....	6
Maintenance	10
Specifications	11
Relocation, installation place	11
Maintenance and lifetime.....	11
After-sales servicing	11

Safety precautions

The following signs indicate that death or serious injury may be caused by failure to heed the precautions described below.

WARNING



 Prohibited	<p>Do not turn the unit on or off when flammable gas has leaked. (It could catch fire or cause explosion with sparks released from electric contractor.) Open windows to ventilate.</p>
 Do not disassemble	<p>Do not modify or disassemble. (It could cause fire, electric shock or injury.)</p>
 Do not wet	<p>Do not apply water to the unit and remote controller. (Electrical shock can result.)</p>
 Do not touch	<p>Do not poke your fingers or sticks into the air intake and outlet while the product is operating. (Failure to heed this warning may result in injury.)</p>
 Wet hands Prohibited	<p>Do not operate with wet hands. (Electrical shock can result.)</p>

Safety precautions (continued)

WARNING

 <p>The instructions given must be followed.</p>	<p>Use the specified power supply and voltage. (Use of incorrect power supply could cause fire or electric shock.)</p> <p>Make sure the power supply isolator is turned off on the power distribution panel before starting maintenance. (It could cause electric shock or injury if it is turned on.)</p> <p>When any abnormal conditions (burning smell, or others) are observed, stop operation, turn off the power supply isolator on the power distribution panel and consult your dealer. (Continuing operation under such conditions could cause electric shock, fire, or damage.)</p> <p>If the supply cord is damaged, it must be replaced by the manufacturer, its service agent or similarly qualified persons in order to avoid a hazard.</p>
---	---

CAUTION

 <p>Prohibited</p>	<p>Do not use at a place where exposed to high temperatures (40°C or higher), naked flames, or in environment with heavy fumes. (It could cause fire.)</p> <p>When installing or relocating, or servicing the unit, use only the specified refrigerant (R410A) to charge the refrigerant lines. Do not mix it with any other refrigerant and do not allow air to remain in the lines. If air is mixed with the refrigerant, then it can be the cause of abnormal high pressure in the refrigerant line, and may result in an explosion and other hazards. The use of any refrigerant other than that specified for the system will cause mechanical failure or system malfunction or unit breakdown. In the worst case, this could lead to a serious impediment to securing product safety.</p> <p>Do not install objects under the unit that cause trouble when they get wet. (Drain blockage due to dust, high humidity (80 % or higher) or prolonged operation during air conditioning may cause water to drip and get household belongings wet or dirty.)</p> <p>In winter, do not operate the unit in bypass mode when heating. (This may cause dew condensation water to drip and dirty the ceiling surface.)</p> <p>Do not touch the refrigerant pipes with your bare hands during operation. (Failure to heed this warning may cause frostbite or burns.)</p> <p>Never use chemical substances such as detergents during cleaning and maintenance. (Failure to heed this warning may deform or split the unit.)</p>
 <p>The instructions given must be followed.</p>	<p>Securely install parts after maintenance. (It could cause injury if parts fall.)</p> <p>Put on gloves during maintenance. (It could cause injury.)</p> <p>Make sure the power supply isolator is turned off when the unit is not used for a long period of time. (It could cause electric shock, power leakage, or fire as a result of deteriorated insulation.)</p> <p>After disinfecting indoors with chemicals, be sure to ventilate to fully discharge chemicals and gases emitted from chemicals before starting the unit. (Chemicals or gases emitted from chemicals adhering to or being sucked into the unit may corrode or deform the unit.)</p> <p>When disinfecting indoors with chemicals, stop operation and cover the unit with a sheet to prevent the unit from being splashed with chemicals. (Chemicals or gases emitted from the chemicals adhering to the unit may deform the unit. Chemicals also fly in all directions, which is dangerous.)</p>

Safety precautions (continued)

CAUTION

Refrigerant (Freon gas) warning

If the refrigerant leaks and comes into contact with a naked flame, toxic gas may be generated. Since this coolant is heavier than the specific gravity of air, it is prone to build up at floor level in rooms. This may lead to a lack of oxygen.

Corrective action if refrigerant leaks

If coolant leaks, turn the stove off and extinguish other flames. Ventilate the room fully by opening doors and windows. Then, contact your dealer.

Avoid installation at the following sites

Installation at the following sites may corrode the unit, cause gas leaks, impair performance significantly, or break parts.

- Locations where inflammable gas may leak
- Locations where substances that affect equipment such as sulfur-based gas, chlorine-based gas, acid, alkali
- On moving objects such as vehicles and ships
- Locations where equipment that generates high frequency is located
- Locations where cosmetics and special sprays are frequently used
- Locations where large amounts of powder and moisture are generated
- Locations where there is soot in the air
- Locations where there is a large amount of salt such as seaside
- Locations where the outdoor unit can be blocked by accumulated snow
- Locations where sparks fly, for example, near flames or from spatter when welding

This appliance is not intended for use by persons (including children) with reduced physical sensory or mental capabilities, or lack of experience and knowledge, unless they have been given supervision or instruction concerning use of the appliance by a person responsible for their safety. Children should be supervised to ensure that they do not play with the appliance.

(This appliance can be used by children aged from 8 years and above and persons with reduced physical, sensory or mental capabilities or lack of experience and knowledge if they have been given supervision or instruction concerning use of the appliance in a safe way and understand the hazards involved. Children shall not play with the appliance. Cleaning and user maintenance shall not be made by children without supervision.)



The instructions given must be followed.

Names of the parts

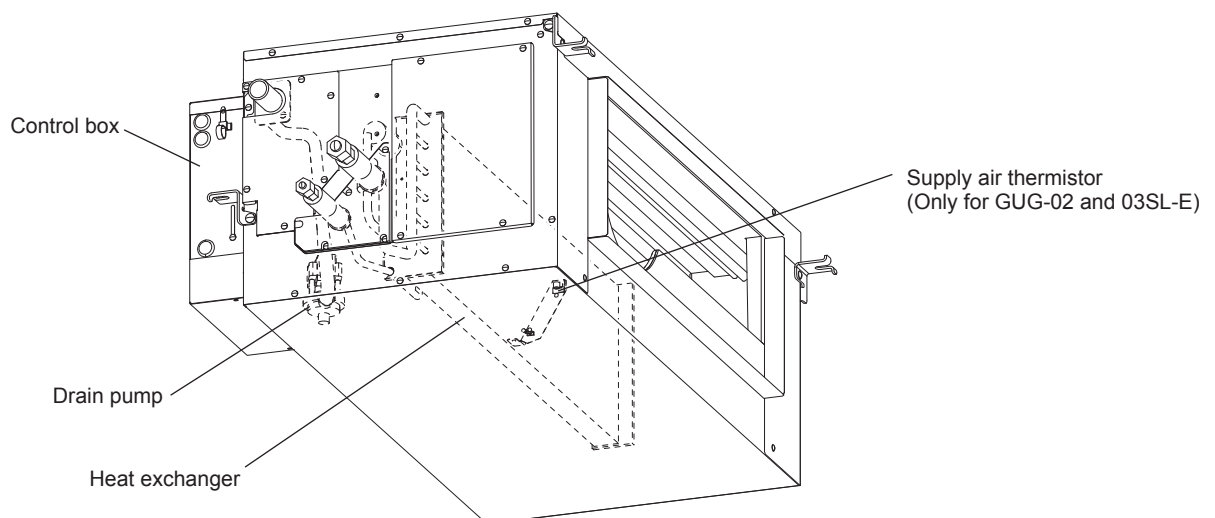

Note

- The drain pump always runs in the cooling mode and continues to run for six minutes after the unit stops.

System configuration

System pattern X [One remote controller]

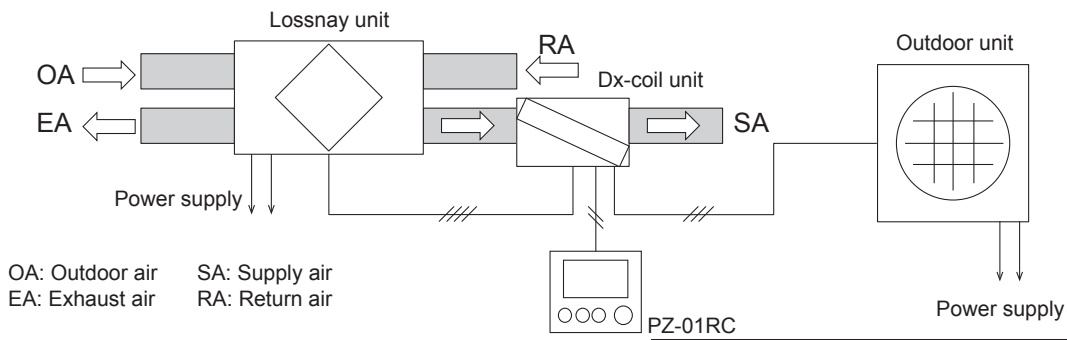

The dedicated remote controller for the Dx-coil unit is described as "PZ-01RC" in this manual. It is not an official model name.

System pattern Y [Two remote controllers]

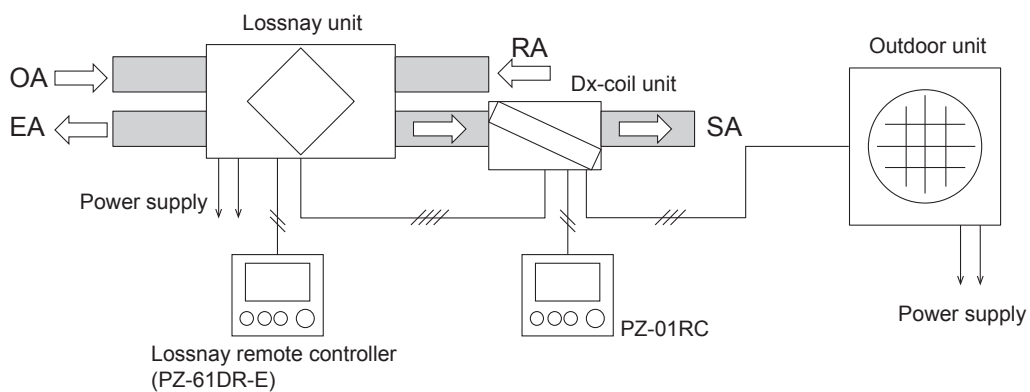

System pattern Z [Interlocked with City Multi indoor unit (M-NET connection)]

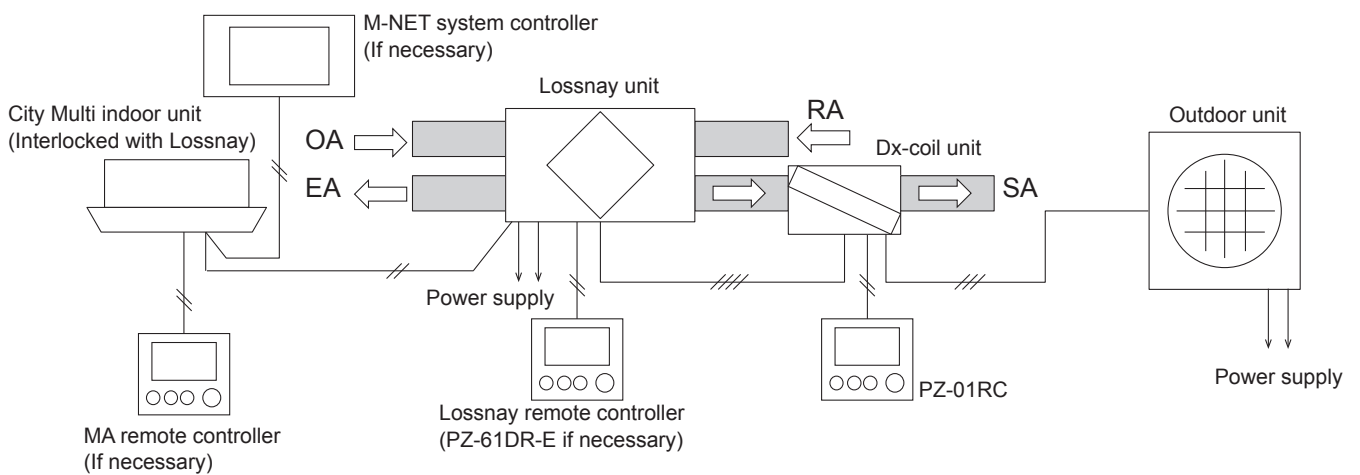

Basic function of the system

[RA (Return Air) temperature control]

The system of the Lossnay unit and Dx-coil unit is designed to maintain the return air temperature close to the setting temperature.

[SA (Supply Air) temperature control]

The system of the Lossnay unit and Dx-coil unit is designed to maintain the supply air temperature close to the setting temperature.

*The setting temperature is recommended to be the same as or close to the setting temperature of the air conditioning unit.

System configuration (continued)

Operation from remote controllers

	System pattern X	System pattern Y	System pattern Z
ON/OFF	From PZ-01RC	From PZ-01RC or PZ-61DR-E *1	From one of the remote controllers or when the indoor unit is switched ON/OFF *2
Operation mode [Heating/Cooling/Fan]	From PZ-01RC	From PZ-01RC	Only from PZ-01RC *3
Temp. setting	From PZ-01RC	From PZ-01RC	Only from PZ-01RC *3
Fan speed [FS1 / FS2 / FS3 / FS4]	Fixed at FS4 *4	Can be changed from PZ-61DR-E.	Can be changed from PZ-61DR-E, M-NET system controller or MA remote controller (for the indoor unit). The selectable fan speeds depend on the model of remote controller.
Ventilation mode [Heat recovery / Bypass / Auto]	Fixed at automatic mode *5	Can be changed from PZ-61DR-E.	Can be changed from PZ-61DR-E or M-NET system controller.
Remarks	-	-	Dx-coil unit cannot be monitored nor operated from M-NET system controller.

*1: When one of the two remote controllers is switched ON/OFF, the other remote controller switches ON/OFF synchronously.

*2: When one of the three remote controllers is switched ON/OFF, the other remote controllers switch ON/OFF synchronously.

















Or when the indoor unit is switched ON/OFF, the system of the Lossnay unit and Dx-coil unit switches ON/OFF synchronously.

*3: Cannot be controlled by M-NET system controller nor MA remote controller of the indoor unit.

*4: Fan speeds can be changed by 0-10VDC input or a volt free contact and can be fixed at the fan speed 3 if necessary.

*5: The ventilation mode is set to the heat recovery mode during the heating and fan modes.

The ventilation mode can be set to the bypass ventilation mode by a volt-free contact if necessary.

Basic operation	System pattern X	System pattern Y		Unit status	
	Dx-coil unit remote controller (PZ-01RC)	Lossnay unit remote controller (PZ-61DR-E)	Dx-coil unit remote controller (PZ-01RC)	Lossnay unit	Dx-coil unit
ON				ON	ON
		When one of the two remote controllers is switched ON, the other remote controller switches ON synchronously.			
Heating Cooling Fan Auto				Ventilating	Heating and Cooling: Thermo-ON or thermo-OFF depending on temperature conditions Fan: Always thermo-OFF (ventilation only) Auto: Only available at RA temp. control
		Cannot be changed by PZ-61DR-E.	Heating/Cooling/Fan/Auto		
Temperature setting					
		Cannot be changed by PZ-61DR-E.			
Fan speed	Fixed at fan speed 4 (Fan speed can be changed by the external input to Lossnay and be fixed at fan speed 3 if necessary.)			Operating at selected fan speed	When Lossnay unit goes to fan speed 1 or 2 during thermo-ON, Dx-coil unit becomes thermo-OFF forcibly.
		Fan speed 1, 2, 3 or 4	Cannot be changed by PZ-01RC.		
Ventilation mode	Fixed at automatic mode (The ventilation mode is always the heat recovery mode during the heating and fan mode.)			Operating at selected ventilation mode	The Dx-coil unit can be switched thermo-ON in any ventilation mode depending on temperature conditions.
		Heat recovery/Bypass/Auto	Cannot be changed by PZ-01RC.		
OFF				OFF	OFF
		When one of the two remote controllers is switched OFF, the other remote controller switches OFF synchronously.			

For system pattern Z, the functions that can be used depend on the model of remote controllers.

Remote controller (PZ-01RC)

1. Names and functions of controller components

Display

The main display can be displayed in two different modes: "Full" and "Basic."
The factory setting is "Full."

Full mode

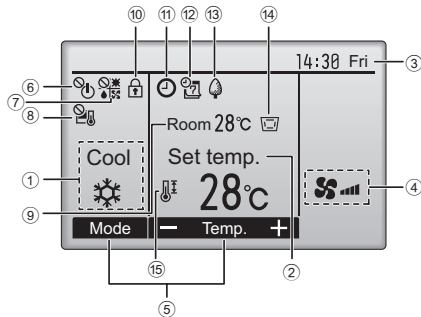

Basic mode

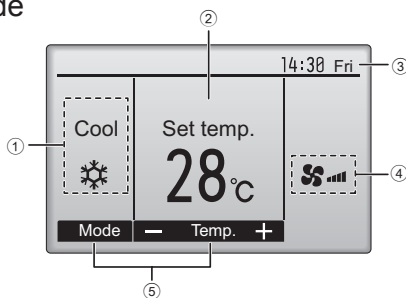

* All icons are displayed for explanation.

- ① Operation mode**
Dx-coil unit operation mode appears here.
- ② Preset temperature**
Preset temperature appears here.
- ③ Clock**
Current time appears here.
- ④ Fan speed**
This function is not available.
- ⑤ Button function guide**
Functions of the corresponding buttons appear here.
- ⑥**
Appears when the ON/OFF operation is centrally controlled.
- ⑦**
Appears when the operation mode is centrally controlled.
- ⑧**
Appears when the preset temperature is centrally controlled.
- ⑨ Room temperature**
Current room temperature appears here. Please erase room temperatures in the initial setting when the SA temp. control is selected.
- ⑩**
Appears when the buttons are locked.
- ⑪**
Appears when the ON/OFF timer function is enabled.
- ⑫**
Appears when the Weekly timer is enabled.
- ⑬**
Appears while power is ON.
- ⑭**
Appears with room temperature.
- ⑮**
Appears when the preset temperature range is restricted.

Controller interface

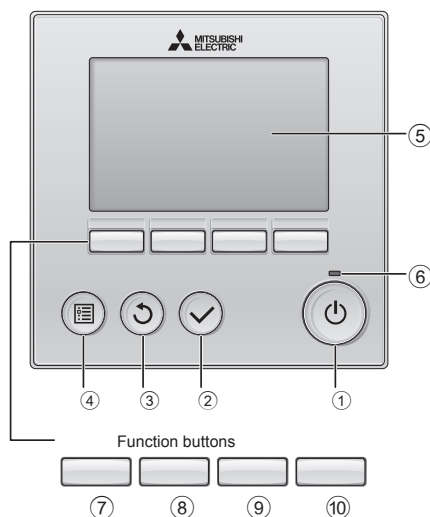

- When the backlight is off, pressing any button turns the backlight on and does not perform its function. (except for the ON/OFF button)
- Most settings (except ON/OFF, mode, temperature) can be made from the Menu screen.

- ① ON/OFF button**
Press to turn ON/OFF the Dx-coil unit.
 - ② SELECT button**
Press to save the setting.
 - ③ RETURN button**
Press to return to the previous screen.
 - ④ MENU button**
Press to bring up the Main menu.
 - ⑤ Backlit LCD**
Operation settings will appear. When the backlight is off, pressing any button turns the backlight on and it will stay lit for a certain period of time depending on the screen.
 - ⑥ ON/OFF lamp**
This lamp lights up in green while the unit is in operation. It blinks while the remote controller is starting up or when there is an error.
- The functions of the function buttons change depending on the screen. Refer to the button function guide that appears at the bottom of the LCD for the functions they serve on a given screen. When the system is centrally controlled, the button function guide that corresponds to the locked button will not appear.
- Main display**

Main menu
- Function guide
- ⑦ Function button [F1]**
Main display: Press to change the operation mode.
Main menu: Press to move the cursor down.
 - ⑧ Function button [F2]**
Main display: Press to decrease temperature.
Main menu: Press to move the cursor up.
 - ⑨ Function button [F3]**
Main display: Press to increase temperature.
Main menu: Press to go to the previous page.
 - ⑩ Function button [F4]**
Main display: Not available.
Main menu: Press to go to the next page.

Note

- For more information on how to use PZ-61DR-E, refer to the instruction book of PZ-61DR-E.

Remote controller (PZ-01RC) (continued)

2. Initial settings

From the Main display, press "MENU" button, select "Initial setting", and make the remote controller settings on the screen that appears.

- Main/Sub
- Clock
- Main display
- Contrast
- Display details
 - Clock
 - Temperature
 - Room temp.
 - Auto mode (Auto cooling/heating operation)
- Auto mode (Auto cooling/heating operation)
- Administrator password
- Language selection

(1) Main/Sub setting

Please do not change from the factory setting.

Using two remote controllers connecting to one Dx-coil unit is prohibited.

(2) Clock setting

Clock setting is necessary for time display, weekly timer, timer setting and error history.

Make sure to perform clock setting when the unit is used for the first time or has not used for a long time.

(3) Main display setting

Use the F3 or F4 button to select the display mode "Full" or "Basic." (The factory setting is "Full.")

(4) Remote controller display details setting

Make the settings for the remote-controller-related items as necessary.

Press the SELECT button to save the changes.

[1] Clock display

[2] Temperature unit setting

[3] Room temperature display

Please set to "No" for the SA temp. control. Refer to the installation manual.

[4] Auto mode (Auto cooling/heating operation) display setting (RA temp. control only)

(The factory setting is "Yes".)

- Yes: "AUTO COOL" or "AUTO HEAT" is displayed during Auto mode (Auto cooling/heating operation).
- No: Only "AUTO" is displayed during Auto mode (Auto cooling/heating operation).

(5) Auto mode (Auto cooling/heating operation) setting (RA temp. control only)

- Yes: The Auto mode (Auto cooling/heating operation) can be selected in the operation mode setting.
- No: The Auto mode (Auto cooling/heating operation) cannot be selected in the operation mode setting.
(The factory setting is "Yes".)

(6) Administrator password setting

- The initial administrator password is "0000." Change the default password as necessary to prevent unauthorized access. Have the password available for those who need it.
- If you forget your administrator password, you can initialize the password to the default password "0000" by pressing and holding the F1 and F2 buttons simultaneously for three seconds on the administrator password setting screen.
- The administrator password is required to make the settings for the following items.
 - Timer setting
 - Weekly timer setting
 - Restriction setting

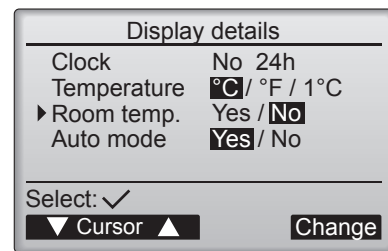

Remote controller (PZ-01RC) (continued)

3. Basic operations

■ Operation mode icons

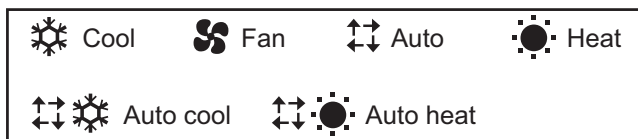

■ Turning ON and selecting operation mode

- 1 Press button ① (**[ON/OFF]**).
 - 2 Press button ⑦ (**[F1]**) to go through the operation modes.
- The ON/OFF lamp and the LCD will light up.

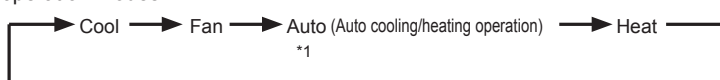

*1 Operation mode is available when the RA temperature control is selected.

■ Preset temperature setting

- Press button ⑧ (**[F2]**) to decrease the preset temperature.
 Press button ⑨ (**[F3]**) to increase the preset temperature.
 * Pressing once changes the value by 1°C (1°F).

Operation mode	Preset temperature range
Cool (Supply air temp. control)	12 – 30 °C (54 – 87 °F)
Cool (Return air temp. control)	19 – 30 °C (67 – 87 °F)
Heat	17 – 28 °C (63 – 83 °F)
Auto cooling/heating operation	19 – 28 °C (67 – 83 °F)
Fan	Not settable

* The temperature range restriction setting will be applied preferentially, if any. If the setting value is outside of the range, a message "Temp. range locked" will appear.

■ Automatic cooling/heating operation

- 1 Press button ① (**[ON/OFF]**).
- 2 Press button ⑦ (**[F1]**) to display the operation mode "Auto".

When the room temperature is higher than the preset temperature, cooling operation starts.
 When the room temperature is lower than the preset temperature, heating operation starts.

* The current operation mode ("Auto cool" or "Auto heat") will be displayed after the mode is determined.
 If "Display/non-display of COOL/HEAT during AUTO mode" has been set to "Non-display" while making the initial settings, only "Auto" will be displayed.

4. Troubleshooting

**When an error occurs, the following screen will appear.
 Check the error status, stop the operation, and consult your dealer.**

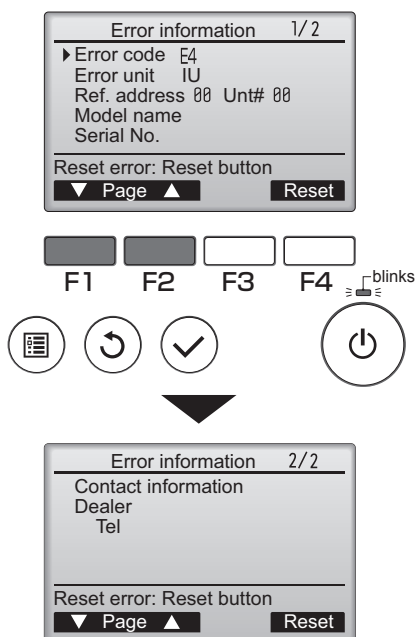

Error code, error unit, refrigerant address, unit model name, and serial number will appear.
 The model name and serial number will appear only if the information have been registered.

Press button ⑦ (**[F1]**) or ⑧ (**[F2]**) to go to the next page.

Contact information (dealer's phone number) will appear if the information have been registered.

Remote controller (PZ-01RC) (continued)

5. Timer and Weekly timer

The settings for Timer and Weekly timer operation can be made from the remote controller.

Press button ④ (**MENU**) to go to the Main menu, and move the cursor to the desired setting with button ⑦ (**F1**) or ⑧ (**F2**).

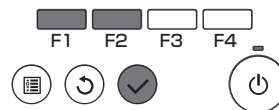
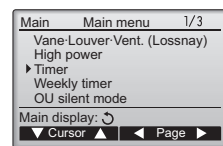

■ Timer

- ON/OFF timer
Operation ON/OFF times can be set in 5-minute increments.
- Auto-Off timer
Auto-Off time can be set to a value from 30 to 240 in 10-minute increments.

■ Weekly timer

Operation ON/OFF times for a week can be set.
Up to eight operation patterns can be set for each day.

Note;

- Please see the table below for the timer and the weekly timer functions.

Timer & Weekly timer	PZ-01RC	PZ-61DR-E	M-NET system controller
System X	Available	-	-
System Y	Do not use	Available	-
System Z	Do not use	Available	Available
Settable contents	ON/OFF Setting temp. Mode	ON/OFF Fan speed Night-purge	Depends on the type of controllers

6. Service

■ Maintenance password setting

- The initial administrator password is "9999". Change the default password as necessary to prevent unauthorized access. Have the password available for those who need it.
- If you forget your administrator password, you can initialize the password to default password "9999" by pressing and holding the F1 and F2 buttons simultaneously for three seconds on the maintenance password setting screen.

7. Others

The following functions are NOT available.

- (1) In main menu (Press button ④ (MENU), main menu appears.)
- "Vane Louver Vent (Lossnay)"
 - "High power"
 - "OU silent mode"
 - In "Energy saving" menu, "schedule" function is NOT available.
 - "Filter information"
 - "Maintenance"
 - In "Service" menu, "Drain pump test run", "Check" functions are NOT available, except for "Request code" in "Check" function.

Note

- Operating instructions for the remote controller PZ-01RC has basically the same contents as PAR-31MAA.
Refer to the appendix in the instruction book of PAR-31MAA when necessary.

Maintenance

For prolonged use, ask your dealer to perform the following inspections about once per year. When the unit is used for several years, its inside becomes dirty and the performance impairs. This often causes foul odors as well as water leakage from and malfunctions on the unit, and clogging in the drain hose due to dirt and dust.

Before performing inspection and maintenance, turn the unit's main power supply OFF by the circuit breaker. (This prevents the protective mode from being activated during inspection.)

Inspected parts	Maintenance and inspection		If maintenance is neglected
	Inspection items	Corrective action	
Drain pump	Water drainage performance. Pump inlet port for dirt or dust.	If dirt or dust is found, wipe the recess on the drain pan surface, suction area, and pump inlet port clean. If the drain pump is particularly dirty, replace parts. If water drainage performance has been impaired after cleaning, replace parts.	Defective water drainage

Precautions When Cleaning Drain Pan and Drain Pump

- Do not use solvents such as thinner, acidic, alkaline detergents or nylon scrubbing brushes. (Failure to heed this warning will degrade the plastic.)
- If cutting oil or other oil is adhering, wash off with sufficient water. If the drain pan is particularly dirty, clean with a neutral detergent. Then thoroughly wash off the detergent. (Remaining detergent will degrade the plastic.)
- Do not use detergent or water with 40 °C or higher. (Failure to heed this warning may lead to deformation.)

How to Clean around Drain Pump

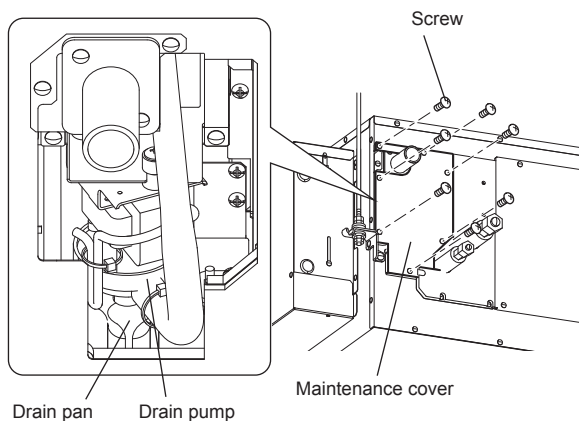

1. Remove the maintenance cover.
(7 screws for GUG-01, 02SL-E, 6 screws for GUG-03SL-E)
 2. Wipe off any dirt or dust adhering to the recess on the drain pan surface, suction area, and pump inlet port or for drain blockage.
 3. After wiping clean, rinse with sufficient water (approx. 1,000 cc). Turn the unit power supply ON. Check if water is drained by controlling the drain pump trial operation switch (set unit circuit SW11-1 to ON).
- * Do not to lose removed screws.

Replacement of the Drain pump

- The drain pump is a consumable part and must be replaced.
 - Replace the drain pump when stopping operation due to the shortage of pumping. (Expenses must be borne by the customer.)
 - After operating the unit in cooling mode for 2,100 hours (approximately five years), the LED on the circuit board blinks. Perform inspection and replace the drain pump, if necessary. For details on work procedures, see the Installation Manual.
 - When assembling, do not twist the hose.
- Consider the indicated operation hours as a guide for the replacement.
It is based on the use of ten hours per day or 420 hours per year, which is the equivalent of two months, in the cooling mode.

Note: The above hours does not indicate the term of guarantee.

Consider for early replacements if operating the unit at the following sites:

- Locations with high temperature/humidity or the change of it is severe
- Locations where the power fluctuates (such as voltage, frequency or wave form distortion) severely. Never use the unit outside the tolerance.
- Locations where oscillation or impulse is severe
- Locations with a large amount of dust or salt
- Locations where power supply starts/stops frequently, or for prolonged operation (e.g. 24 hours of air conditioning)

Specifications

Model name	Running current (A)	Input power (W)	Dimension (mm)			Weight (kg)
			Width	Depth	Height	
GUG-01SL-E	Less than 0.1 A	2.5 W (Heating / Fan) 12.4 W (Cooling)	492	812	330	21
GUG-02SL-E			492	1034	394	26
GUG-03SL-E			461	1130	404	28

* The running current and the input power are based on 230V/50Hz.

Relocation, installation place

■ Moving the Unit

- (1) When removing and re-installing the unit for extension and reconstruction or for moving to another site, contact your dealer in advance. Specialised skills for moving the unit will be required. Construction expenses will be incurred.
- (2) When the unit is filled with refrigerant during installation or when it is moved, do not use refrigerants other than designated.
- (3) Handling of freon gas or abandonment of this unit, follow local regulations or standards.

■ Installation Site

- (1) When installing or moving the unit, contact your dealer or specialist vendor.
- (2) Avoid installation at the following sites: described in **CAUTION** (page 2, 3)
- (3) Install the unit so that it is horizontal or a drain discharge port is attached below (within 1 °). Otherwise, water may drip.
- (4) When installing the unit in places such as hospitals or communications service stations, take necessary measures to shield noise generating sources.

Maintenance and lifetime



The parts listed below are service parts. It is necessary that the regular check and the regular replacement or the replacement when it is broken. In addition, expenses for parts and replacement work is charged to customers.

- Drain pump
- Printed circuit board

After-sales servicing

Consult with your dealer about the after-sales services provided for this product.

If you hear strange sounds, if no air is blown out or if some other trouble occurs, switch off the power and contact your dealer. Consult with your dealer concerning the cost of inspection or repair work.

Attentive inspection	Inspect your unit of good service!	
	<p>Have you noticed?</p> <ul style="list-style-type: none"> ● Fan do not run when the unit is turned on. ● Abnormal noises or vibrations while the unit is running. ● Retarded or irregular rotations. (Motors are component which requires maintenance.) ● Burnt odor. ● Corroded or damaged installation section. 	 <div style="background-color: black; color: white; padding: 5px; display: inline-block;">Stop running.</div>
		<p>Turn off the unit. Then, contact your dealer for prevention of failure or hazard. The dealer should appraise the possible cost.</p>

MITSUBISHI ELECTRIC CORPORATION

mitsubishi electric corporation

Manufactured by: MITSUBISHI ELECTRIC CORPORATION

TOKYO BLDG. 2-7-3, MARUNOUCHI, CHIYODA-KU, TOKYO, 100-8310 JAPAN

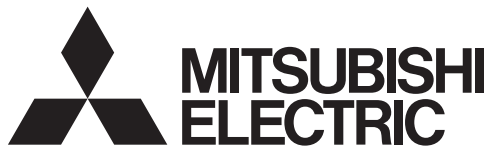

CITY MULTI Control System
and Mitsubishi Mr. Slim Air Conditioners

MA Remote Controller PAR-31MAA

Instruction Book

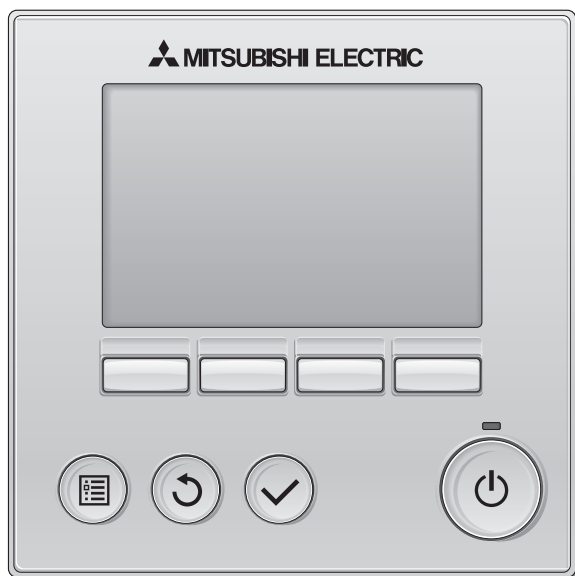

Prior to use, thoroughly read the instructions in this manual to use the product correctly.
Retain for future reference.

Make sure that this CD-ROM and the Installation Manual are passed on to any future users.
To ensure safety and proper operation of the remote controller, the remote controller should
only be installed by qualified personnel.

English

Deutsch

Français

Español

Italiano

Nederlands

Português

Ελληνικά

Русский

Türkçe

Český

Slovenský

Magyar

Polski

Slovenščina

Svenska

Hrvatski

Български

Română

Dansk

Product features

Feature 1

Large, easy-to-see display

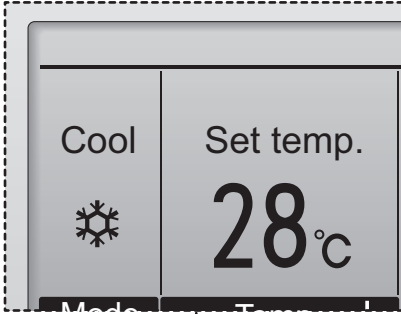

Full-dot LCD display with large characters for easy viewing

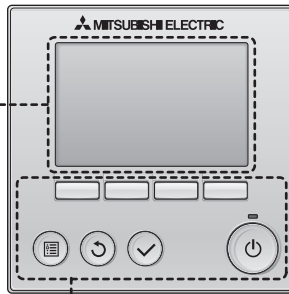

Feature 2

Simple button arrangement

Feature 3

Large, easy-to-press buttons

Buttons are arranged according to usage to allow for intuitive navigation.

Frequently used buttons are larger than other buttons to prevent unintended pressing of other buttons.

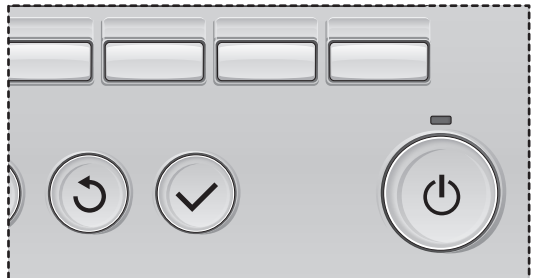



Contents

Safety precautions	4
Names and functions of controller components.....	6
Controller interface	6
Display.....	8
Read before operating the controller	10
Menu structure.....	10
Icon explanations.....	11
Basic operations.....	12
Power ON/OFF	12
Operation mode, temperature, and fan speed settings.....	14
Navigating through the menu	18
Main menu list	18
Restrictions for the sub remote controller.....	19
Navigating through the Main menu.....	20
Controller operation-Function settings	22
Vane•Louver•Vent. (Lossnay).....	22
High power	24
Clock.....	25
Timer (On/Off timer).....	26
(Auto-Off timer).....	28
Weekly timer	30
OU silent mode.....	32
Restriction.....	34
Energy saving.....	38
Night setback.....	42
Manual vane angle	44
Main display.....	46
Contrast	47
Language selection	48
Function setting	50
Maintenance	52
Filter information.....	52
Troubleshooting	54
Error information.....	54
Specifications.....	56

Safety precautions

- Thoroughly read the following safety precautions before using the unit.
- Observe these precautions carefully to ensure safety.

 WARNING	Indicates a risk of death or serious injury.
 CAUTION	Indicates a risk of serious injury or structural damage.

- After reading this manual, pass it on to the end user to retain for future reference.
- Keep this manual for future reference and refer to it as necessary. This manual should be made available to those who repair or relocate the controller. Make sure that the manual is passed on to any future users.

General precautions

WARNING

Do not install the unit in a place where large amounts of oil, steam, organic solvents, or corrosive gases, such as sulfuric gas, are present or where acidic/alkaline solutions or sprays are used frequently. These substances can compromise the performance of the unit or cause certain components of the unit to corrode, which can result in electric shock, malfunctions, smoke, or fire.

To reduce the risk of shorting, current leakage, electric shock, malfunctions, smoke, or fire, do not wash the controller with water or any other liquid.

To reduce the risk of electric shock, malfunctions, smoke or fire, do not operate the switches/buttons or touch other electrical parts with wet hands.

When disinfecting the unit using alcohol, ventilate the room adequately. The fumes of the alcohol around the unit may cause a fire or explosion when the unit is turned on.

To reduce the risk of injury or electric shock, before spraying a chemical around the controller, stop the operation and cover the controller.

To reduce the risk of injury or electric shock, stop the operation and switch off the power supply before cleaning, maintaining, or inspecting the controller.

If any abnormality (e.g., burning smell) is noticed, stop the operation, turn off the power switch, and consult your dealer. Continued use of the product may result in electric shock, malfunctions, or fire.

Properly install all required covers to keep moisture and dust out of the controller. Dust accumulation and water can cause electric shock, smoke, or fire.

CAUTION

To reduce the risk of fire or explosion, do not place flammable materials or use flammable sprays around the controller.

To reduce the risk of damage to the controller, do not directly spray insecticide or other flammable sprays on the controller.

To reduce the risk of environmental pollution, consult an authorized agency for proper disposal of remote controller.

To reduce the risk of electric shock or malfunctions, do not touch the touch panel, switches, or buttons with a pointy or sharp object.

To reduce the risk of injury and electric shock, avoid contact with sharp edges of certain parts.

To reduce the risk of injury, wear protective gear when working on the controller.

To avoid injury from broken glass, do not apply excessive force on the glass parts.

Precautions for moving or repairing the controller

WARNING

The controller should be repaired or moved only by qualified personnel. Do not disassemble or modify the controller.
Improper installation or repair may cause injury, electric shock, or fire.

CAUTION

To reduce the risk of shorting, electric shock, fire, or malfunction, do not touch the circuit board with tools or with your hands, and do not allow dust to accumulate on the circuit board.

Additional precautions

To avoid damage to the controller, use appropriate tools to install, inspect, or repair the controller.

This controller is designed for exclusive use with the Building Management System by Mitsubishi Electric. The use of this controller for with other systems or for other purposes may cause malfunctions.

To avoid discoloration, do not use benzene, thinner, or chemical rag to clean the controller. To clean the controller, wipe with a soft cloth soaked in water with mild detergent, wipe off the detergent with a wet cloth, and wipe off water with a dry cloth.

To avoid damage to the controller, provide protection against static electricity.

Names and functions of controller components

Controller interface

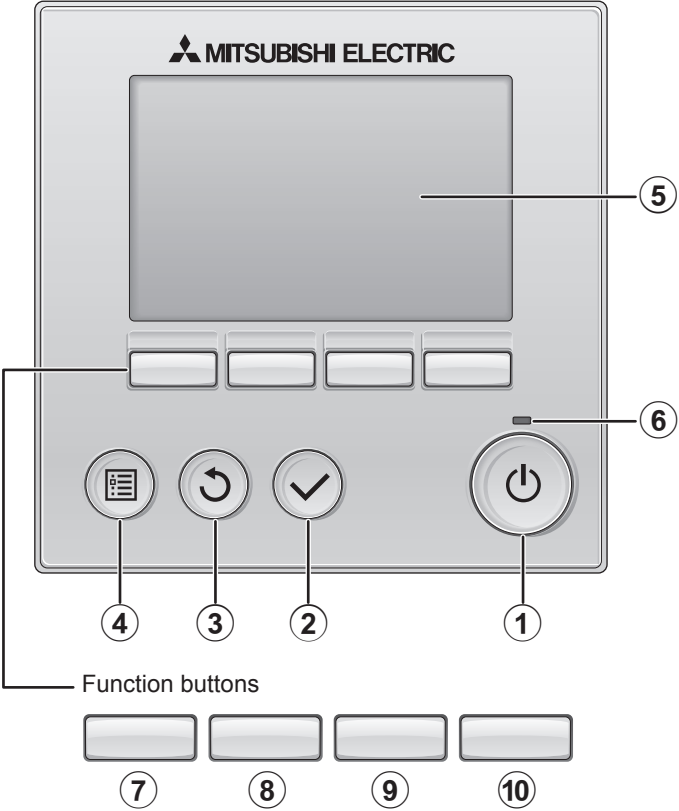

① **ON/OFF** button

Press to turn ON/OFF the indoor unit.

② **SELECT** button

Press to save the setting.

③ **RETURN** button

Press to return to the previous screen.

④ **MENU** button

Page 20

Press to bring up the Main menu.

⑤ **Backlit LCD**

Operation settings will appear.
When the backlight is off, pressing any button turns the backlight on and it will stay lit for a certain period of time depending on the screen.

When the backlight is off, pressing any button turns the backlight on and does not perform its function. (except for the **ON/OFF** button)

⑥ **ON/OFF lamp**

This lamp lights up in green while the unit is in operation. It blinks while the remote controller is starting up or when there is an error.

The functions of the function buttons change depending on the screen. Refer to the button function guide that appears at the bottom of the LCD for the functions they serve on a given screen.

When the system is centrally controlled, the button function guide that corresponds to the locked button will not appear.

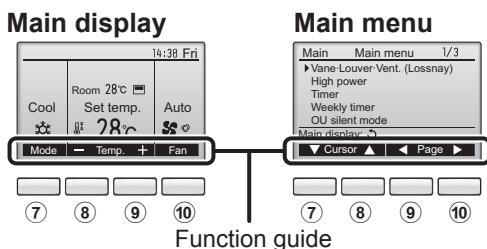

⑦ **Function button F1**

Main display: Press to change the operation mode.

Main menu: Press to move the cursor down.

⑧ **Function button F2**

Main display: Press to decrease temperature.

Main menu: Press to move the cursor up.

⑨ **Function button F3**

Main display: Press to increase temperature.

Main menu: Press to go to the previous page.

⑩ **Function button F4**

Main display: Press to change the fan speed.

Main menu: Press to go to the next page.

Names and functions of controller components

Display

The main display can be displayed in two different modes: "Full" and "Basic." The factory setting is "Full." To switch to the "Basic" mode, change the setting on the Main display setting. (Refer to page 46.)

Full mode

* All icons are displayed for explanation.

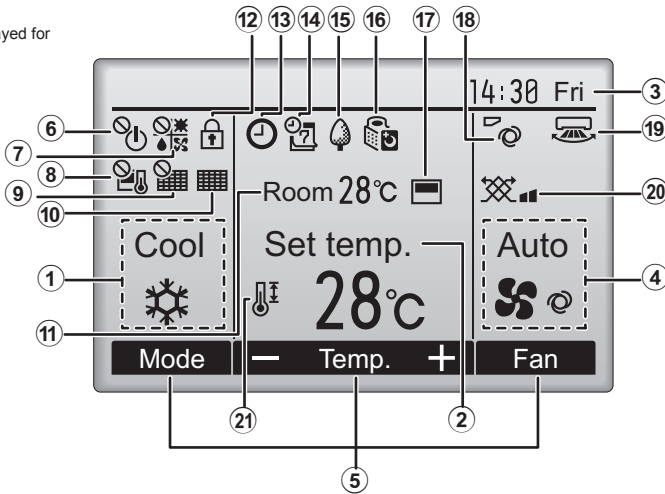

Basic mode

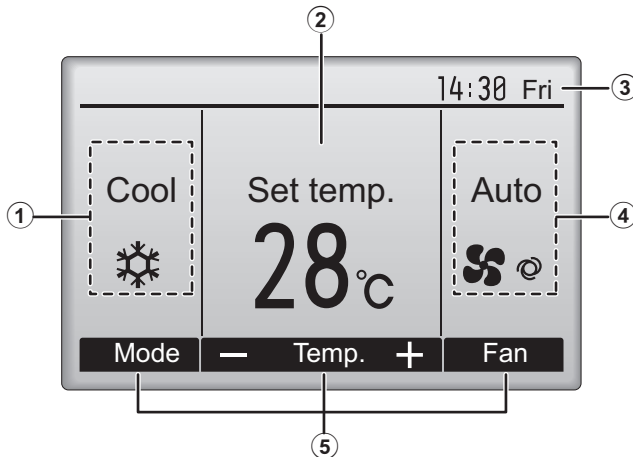

① Operation mode **Page 14**

Indoor unit operation mode appears here.

② Preset temperature **Page 15**

Preset temperature appears here.

③ Clock
(See the Installation Manual.)

Current time appears here.

④ Fan speed **Page 16**

Fan speed setting appears here.

⑤ Button function guide

Functions of the corresponding buttons appear here.



Appears when the ON/OFF operation is centrally controlled.



Appears when the operation mode is centrally controlled.



Appears when the preset temperature is centrally controlled.



Appears when the filter reset function is centrally controlled.



Indicates when filter needs maintenance.

⑪ Room temperature
(See the Installation Manual.)

Current room temperature appears here.



Appears when the buttons are locked.

Most settings (except ON/OFF, mode, fan speed, temperature) can be made from the Menu screen. (Refer to page 20.)

⑬  **Page 26, 28, 42**

Appears when the On/Off timer (Page 26), Night setback (Page 42), or Auto-off timer (Page 28) function is enabled.

 appears when the timer is disabled by the centralized control system.

⑭  **Page 30**

Appears when the Weekly timer is enabled.

⑮  **Page 40**

Appears while the units are operated in the energy-save mode. (Will not appear on some models of indoor units)

⑯  **Page 32**

Appears while the outdoor units are operated in the silent mode.



Appears when the built-in thermistor on the remote controller is activated to monitor the room temperature (⑪).

 appears when the thermistor on the indoor unit is activated to monitor the room temperature.

⑱  **Page 22**

Indicates the vane setting.

⑲  **Page 23**

Indicates the louver setting.

⑳  **Page 23**

Indicates the ventilation setting.

㉑  **Page 34**

Appears when the preset temperature range is restricted.

Read before operating the controller

Menu structure

Main menu	
Press the MENU button.	→ Vane•Louver•Vent. (Lossnay) Page 22
	→ High power Page 24
Move the cursor to the desired item with the F1 and F2 buttons, and press the SELECT button.	→ Timer
	→ On/Off timer Page 26
	→ Auto-Off timer Page 28
	→ Weekly timer Page 30
	→ OU silent mode Page 32
	→ Restriction
	→ Temp. range Page 34
	→ Operation lock Page 36
	→ Energy saving
	→ Auto return Page 38
	→ Schedule Page 40
	→ Night setback Page 42
	→ Filter information Page 52
	→ Error information Page 54
	→ Maintenance
	→ Auto descending panel Refer to the Instructions Manual that came with the automatic elevating panel.
	→ Manual vane angle Page 44
	→ Initial setting
	→ Main/Sub Refer to the Installation Manual.
	→ Clock Page 25
	→ Main display Page 46
	→ Contrast Page 47
	→ Display details Refer to the Installation Manual.
	→ Auto mode Refer to the Installation Manual.
	→ Administrator password Refer to the Installation Manual.
	→ Language selection Page 48

Service	
→ Test run	Refer to the indoor unit Installation Manual.
→ Input maintenance info.	Refer to the indoor unit Installation Manual.
→ Function setting (Mr. Slim)	Refer to the Installation Manual.
→ Function setting (City Multi)	Refer to page 50.
→ Lossnay (City Multi only)	Refer to the Installation Manual.
→ Check	Refer to the indoor unit Installation Manual.
→ Self check	Refer to the Installation Manual.
→ Maintenance password	Refer to the Installation Manual.
→ Remote controller check	Refer to the Installation Manual.

Not all functions are available on all models of indoor units.

Icon explanations

Controller operation

Timer



The table below summarizes the square icons used in this manual.

	<p>The administrator or maintenance user password must be entered on the password input screen to change settings. There is no settings that can skip this process.</p> <div data-bbox="171 1018 424 1182" data-label="Image"> </div> <div data-bbox="171 1201 424 1251" data-label="Image"> </div> <div data-bbox="476 1062 869 1179" data-label="List-Group"> <ul style="list-style-type: none"> F1 : Press to move the cursor left. F2 : Press to move the cursor right. F3 : Press to decrease the value by 1. F4 : Press to increase the value by 1. </div> <p>*Changes cannot be made unless the correct password is entered.</p>	<div data-bbox="922 954 987 1023" data-label="Image"> </div> <p>Indicates settings that can be made only from the main remote controller.</p>	
	<p>Indicates settings that can be changed only while the units are in operation.</p>		<p>Indicates settings that can be changed only while the units are not in operation.</p>
	<p>Indicates settings that can be changed only while the units are operated in the Cool, Heat, or Auto mode.</p>		<p>Indicates functions that are not available when the buttons are locked or the system is centrally controlled.</p>

Basic operations

Power ON/OFF



Button operation

ON

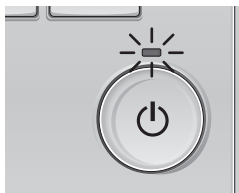

Press the **ON/OFF** button.

The ON/OFF lamp will light up in green, and the operation will start.

OFF

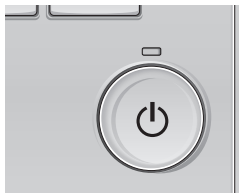

Press the **ON/OFF** button again.

The ON/OFF lamp will come off, and the operation will stop.

Operation status memory

	Remote controller setting
Operation mode	Operation mode before the power was turned off
Preset temperature	Preset temperature before the power was turned off
Fan speed	Fan speed before the power was turned off

Settable preset temperature range

Operation mode	Preset temperature range
Cool/Dry	19 ~ 30 °C (67 ~ 87 °F)
Heat	17 ~ 28 °C (63 ~ 83 °F)
Auto (Single set point)	19 ~ 28 °C (67 ~ 83 °F)
Auto (Dual set points)	[Cool] Preset temperature range for the Cool mode [Heat] Preset temperature range for the Heat mode
Fan/Ventilation	Not settable

The settable temperature range varies with the model of indoor units.

Basic operations

Operation mode, temperature, and fan speed settings



Button operation

Operation mode

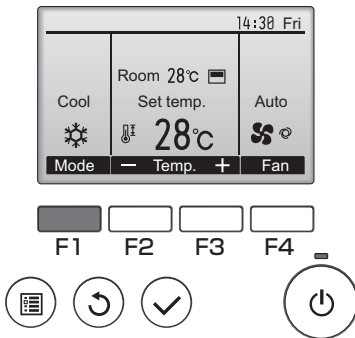

Press the **[F1]** button to go through the operation modes in the order of "Cool, Dry, Fan, Auto, and Heat." Select the desired operation mode.

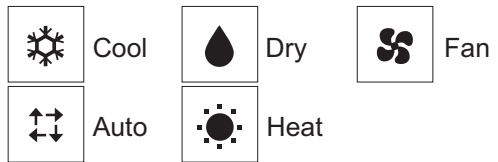

• Operation modes that are not available to the connected indoor unit models will not appear on the display.

What the blinking mode icon means

The mode icon will blink when other indoor units in the same refrigerant system (connected to the same outdoor unit) are already operated in a different mode. In this case, the rest of the unit in the same group can only be operated in the same mode.

<AUTO (dual set point) mode>

When the operation mode is set to the Auto (dual set point) mode, two preset temperatures (one each for cooling and heating) can be set. Depending on the room temperature, indoor unit will automatically operate in either the Cool or Heat mode and keep the room temperature within the preset range.

The graph below shows the operation pattern of indoor unit operated in the Auto (dual set point) mode.

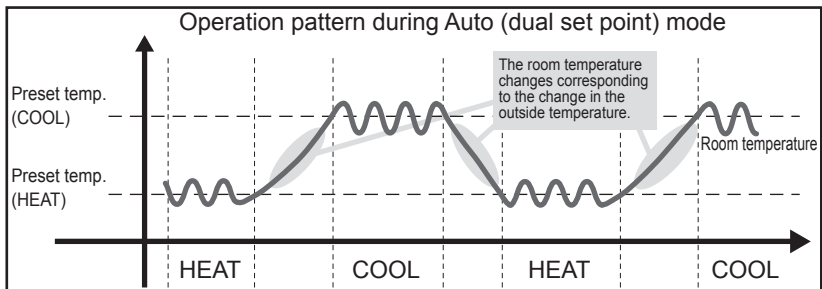

Preset temperature

<Cool, Dry, Heat, and Auto (single set point)>

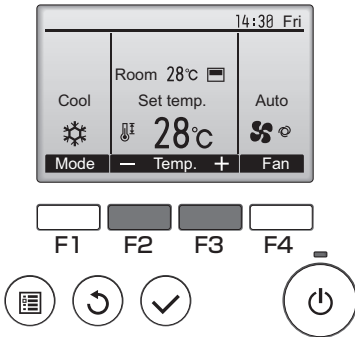

Press the **[F2]** button to decrease the preset temperature, and press the **[F3]** button to increase.

- Refer to the table on page 13 for the settable temperature range for different operation modes.
- Preset temperature range cannot be set for Fan/Ventilation operation.
- Preset temperature will be displayed either in Centigrade in 0.5- or 1-degree increments, or in Fahrenheit, depending on the indoor unit model and the display mode setting on the remote controller.

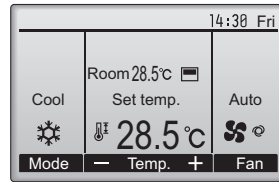

Example display
(Centigrade in 0.5-degree increments)

<Auto (dual set point) mode>

1

Preset temperature for cooling

Preset temperature for heating

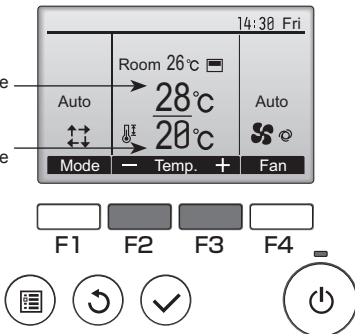

The current preset temperatures will appear. Press the **[F2]** or **[F3]** button to display the Settings screen.

Basic operations

2

Preset temperature for cooling
Preset temperature for heating

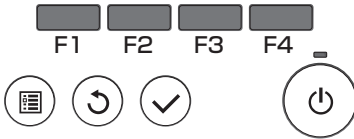
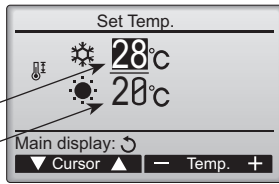

Press the **[F1]** or **[F2]** button to move the cursor to the desired temperature setting (cooling or heating).

Press the **[F3]** button to decrease the selected temperature, and **[F4]** to increase.

- Refer to the table on page 13 for the settable temperature range for different operation modes.
- The preset temperature settings for cooling and heating in the Auto (dual set point) mode are also used by the Cool/Dry and Heat modes.
- The preset temperatures for cooling and heating in the Auto (dual set point) mode must meet the conditions below:
 - Preset cooling temperature is higher than preset heating temperature.
 - The minimum temperature difference requirement between cooling and heating preset temperatures (varies with the models of indoor units connected) is met.
 - If preset temperatures are set in a way that does not meet the minimum temperature difference requirement, both preset temperatures will automatically be changed within the allowable setting ranges.

Navigating through the screens

- To return to the Main screen **[RETURN]** button

Fan speed

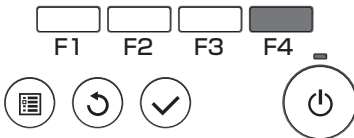
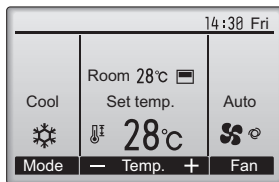

Press the **[F4]** button to go through the fan speeds in the following order.

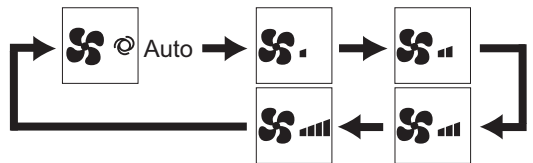

- The available fan speeds depend on the models of connected indoor units.



Navigating through the menu

Main menu list

Setting and display items		Setting details	Reference page
Vane•Louver•Vent. (Lossnay)		<p>Use to set the vane angle.</p> <ul style="list-style-type: none"> •Select a desired vane setting from five different settings. <p>Use to turn ON/OFF the louver.</p> <ul style="list-style-type: none"> •Select a desired setting from "ON" and "OFF." <p>Use to set the amount of ventilation.</p> <ul style="list-style-type: none"> •Select a desired setting from "Off," "Low," and "High." 	22
High power		<p>Use to reach the comfortable room temperature quickly.</p> <ul style="list-style-type: none"> •Units can be operated in the High-power mode for up to 30 minutes. 	24
Timer	On/Off timer	<p>Use to set the operation On/Off times.</p> <ul style="list-style-type: none"> •Time can be set in 5-minute increments. * Clock setting is required. 	26
	Auto-Off timer	<p>Use to set the Auto-Off time.</p> <ul style="list-style-type: none"> •Time can be set to a value from 30 to 240 in 10-minute increments. 	28
Weekly timer		<p>Use to set the weekly operation On/Off times.</p> <ul style="list-style-type: none"> •Up to eight operation patterns can be set for each day. * Clock setting is required. * Not valid when the On/Off timer is enabled. 	30
OU silent mode		<p>Use to set the time periods in which priority is given to quiet operation of outdoor units over temperature control. Set the Start/Stop times for each day of the week.</p> <ul style="list-style-type: none"> •Select the desired silent level from "Normal," "Middle," and "Quiet." * Clock setting is required. 	32
Restriction	Temp. range	<p>Use to restrict the preset temperature range.</p> <ul style="list-style-type: none"> •Different temperature ranges can be set for different operation modes. 	34
	Operation lock	<p>Use to lock selected functions.</p> <ul style="list-style-type: none"> •The locked functions cannot be operated. 	36
Energy saving	Auto return	<p>Use to get the units to operate at the preset temperature after performing energy-save operation for a specified time period.</p> <ul style="list-style-type: none"> •Time can be set to a value from 30 and 120 in 10-minute increments. * This function will not be valid when the preset temperature ranges are restricted. 	38
	Schedule	<p>Set the start/stop times to operate the units in the energy-save mode for each day of the week, and set the energy-saving rate.</p> <ul style="list-style-type: none"> •Up to four energy-save operation patterns can be set for each day. •Time can be set in 5-minute increments. •Energy-saving rate can be set to a value from 0% and 50 to 90% in 10% increments. * Clock setting is required. 	40

Setting and display items		Setting details	Reference page
Night setback		Use to make Night setback settings. •Select "Yes" to enable the setting, and "No" to disable the setting. The temperature range and the start/stop times can be set. * Clock setting is required.	42
Filter information		Use to check the filter status. •The filter sign can be reset.	52
Error information		Use to check error information when an error occurs. •Error code, error source, refrigerant address, unit model, manufacturing number, contact information (dealer's phone number) can be displayed. * The unit model, manufacturing number, and contact information need to be registered in advance to be displayed.	54
Maintenance	Manual vane angle	Use to set the vane angle for each vane to a fixed position.	44
Initial setting	Clock	Use to set the current time.	25
	Main display	Use to switch between "Full" and "Basic" modes for the Main display. •The default setting is "Full."	46
	Contrast	Use to adjust screen contrast.	47
	Language selection	Use to select the desired language.	48
Service	Function setting (City Multi)	Use to make settings for indoor unit's functions.	50

Restrictions for the sub remote controller

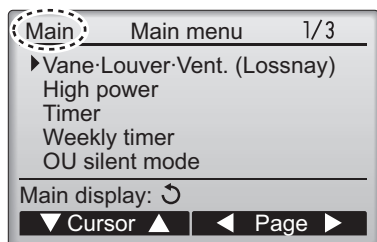

The following settings cannot be made from the sub remote controller. Make these settings from the main remote controller. "Main" is displayed in the title of the Main menu on the main remote controller.

- Timer
(On/Off timer, Auto-Off timer)
- Weekly timer
- OU silent mode
- Energy saving
(Auto return, Schedule)
- Night setback
- Maintenance
(Manual vane angle)

Navigating through the menu

Navigating through the Main menu

Button operation

Accessing the Main menu

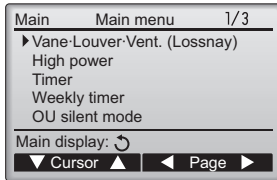

Press the **MENU** button.

The Main menu will appear.

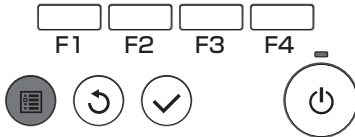

Item selection

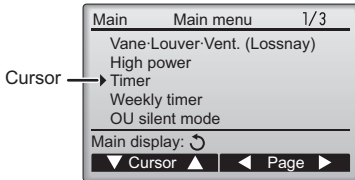

Press **F1** to move the cursor down.

Press **F2** to move the cursor up.

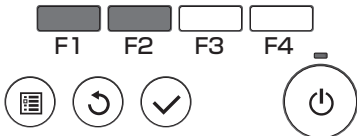

Navigating through the pages

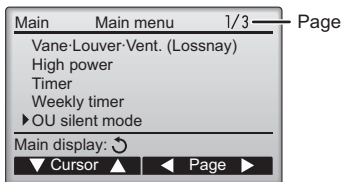

Press **F3** to go to the previous page.

Press **F4** to go to the next page.

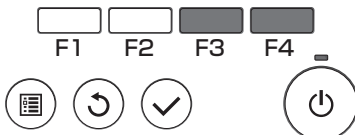

Saving the settings

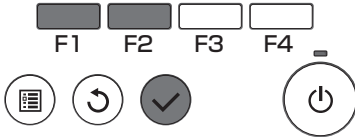

Select the desired item, and press the **SELECT** button.

The screen to set the selected item will appear.

Exiting the Main menu screen

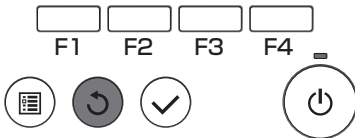
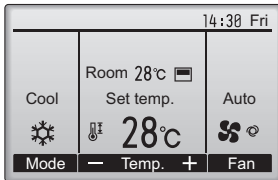

Press the **RETURN** button to exit the Main menu and return to the Main display.

If no buttons are touched for 10 minutes, the screen will automatically return to the Main display. Any settings that have not been saved will be lost.

Display of unsupported functions

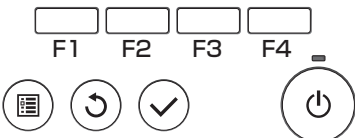

The message at left will appear if the user selects a function not supported by the corresponding indoor unit model.

Controller operation-Function settings

Vane•Louver•Vent. (Lossnay)

ON

Button operation

Accessing the menu

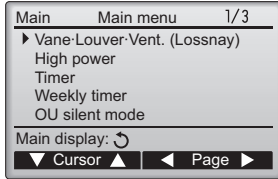

Select "Vane•Louver•Vent. (Lossnay)" from the Main menu (refer to page 20), and press the **SELECT** button.

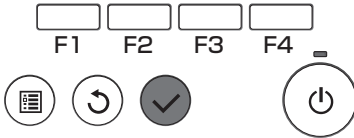

Vane setting

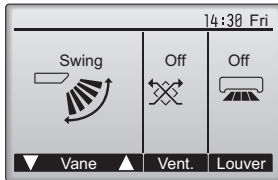

Press the **F1** or **F2** button to go through the vane setting options: "AUTO," "Step 1," "Step 2," "Step 3," "Step 4," "Step 5," and "Swing." Select the desired setting.

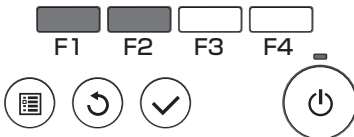

(Sample screen on City Multi)

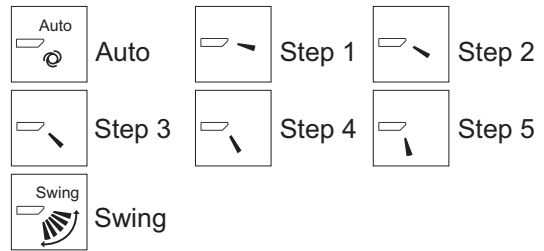

Select "Swing" to move the vanes up and down automatically.

When set to "Step 1" through "Step 5", the vane will be fixed at the selected angle.

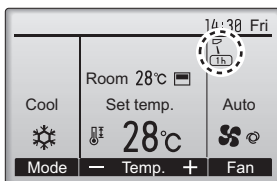

- **1h** under the vane setting icon
 This icon will appear when the vane is set to "Step 5" and the fan operates at low speed during cooling or dry operation (depends on the model). The icon will go off in an hour, and the vane setting will automatically change.

Louver setting

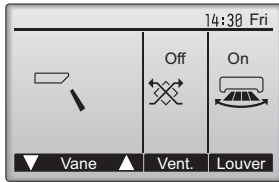

(Sample screen on City Multi)

Press the **F4** button to turn the louver swing ON and OFF.



Off



On

Vent. setting

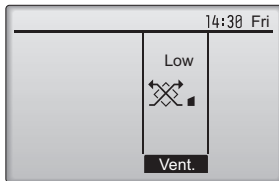

(Sample screen on Mr. Slim)

Press the **F3** button to go through the ventilation setting options in the order of "Off," "Low," and "High."

* Settable only when LOSSNAY unit is connected.



Off



Low



High

• The fan on some models of indoor units may be interlocked with certain models of ventilation units.

Returning to the Main menu

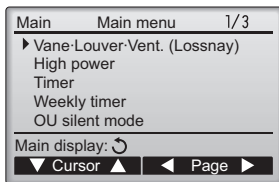

Press the **RETURN** button to go back to the Main menu.

Controller operation-Function settings

High power



Function description

High-power operation function allows the units to operate at higher-than-normal capacity so that the room air can be conditioned to an optimum temperature quickly. This operation will last for up to 30 minutes, and the unit will return to the normal operation mode at the end of the 30 minutes or when the room temperature reaches the preset temperature, whichever is earlier. The units will return to the normal operation when the operation mode or fan speed is changed.

Button operation

1

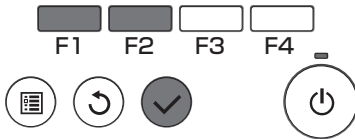
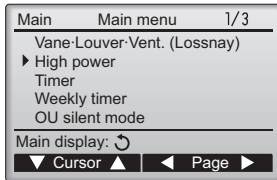

Select "High power" from the Main menu during Cooling, Heating, or AUTO operation (refer to page 20), and press the **SELECT** button.

"High power" function is available only on the models that support the function.

2

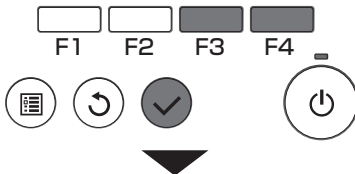
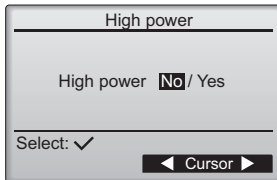

Move the cursor to "YES" with the **F3** or **F4** button, and press the **SELECT** button.

A confirmation screen will appear.

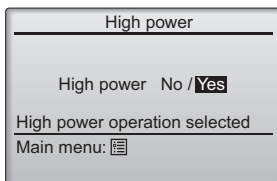

Navigating through the screens

- To go back to the Main menu **MENU** button
- To return to the previous screen **RETURN** button

Button operation

1

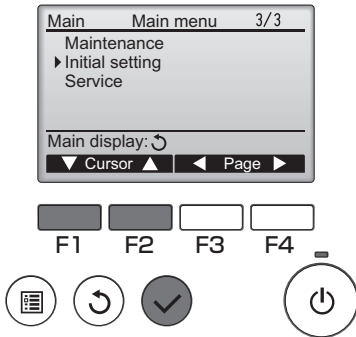

Select "Initial setting" from the Main menu (refer to page 20), and press the **SELECT** button.

Clock setting is required before making the following settings.

- On/Off timer
- Weekly timer
- OU silent mode
- Energy saving
- Night setback

2

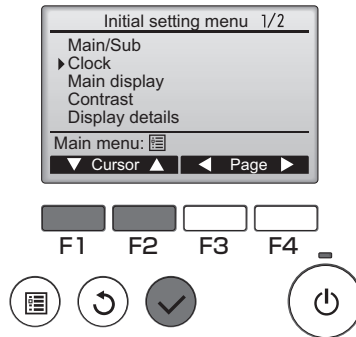

Move the cursor to the "Clock" with the **F1** or **F2** button, and press the **SELECT** button.

3

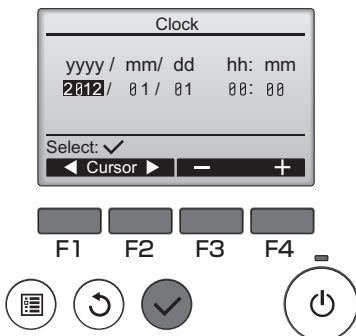

Move the cursor to the desired item with the **F1** or **F2** button out of year, month, date, hour, or minute.

Increase or decrease the value for the selected item with the **F3** or **F4** button, and press the **SELECT** button.

A confirmation screen will appear.

Navigating through the screens

- To go back to the Main menu **MENU** button
- To return to the previous screen **RETURN** button

Controller operation-Function settings

Timer

Main

P

On/Off timer

Button operation

1

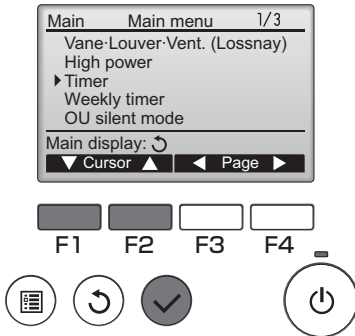

Select "Timer" from the Main menu (refer to page 20), and press the **SELECT** button.

The On/Off timer will not work in the following cases:
when On/Off timer is disabled, during an error, during check (in the service menu), during test run, during remote controller diagnosis, when the clock is not set, during Function setting, when the system is centrally controlled (when On/Off operation or Timer operation from local remote controller is prohibited).

2

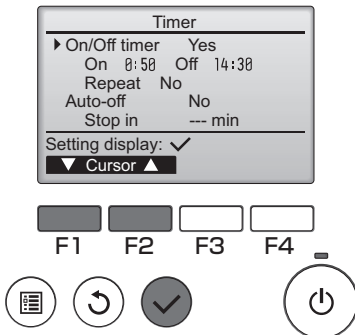

The current settings will appear.

Move the cursor to the On/Off timer, and press the **SELECT** button.

3

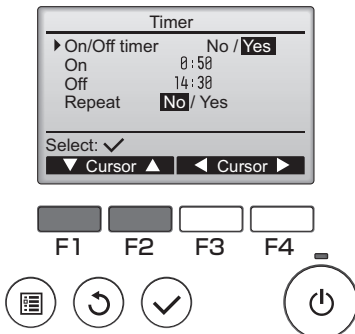

The screen to set the timer will appear.

Select the desired item with the **F1** or **F2** button out of "On/Off timer," "On," "Off," or "Repeat."

4

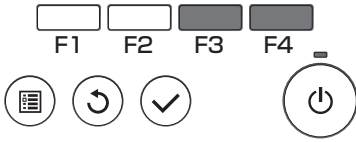
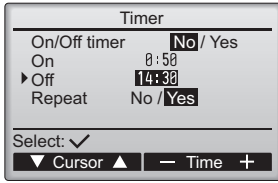

Change the setting with the **[F3]** or **[F4]** button.

- On/Off timer: No (disable)/Yes (enable)
- On: Operation start time (settable in 5-minute increments)
 - * Press and hold the button to rapidly advance the numbers.
- Off: Operation stop time (settable in 5-minute increments)
 - * Press and hold the button to rapidly advance the numbers.
- Repeat: No (once)/Yes (repeat)

5

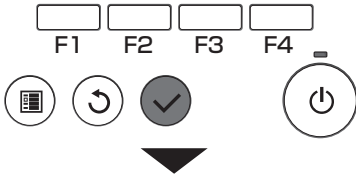
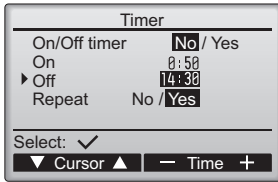

Press the **[SELECT]** button to save the settings.

A confirmation screen will appear.

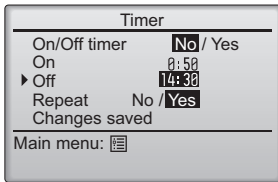

Navigating through the screens

- To go back to the Main menu **[MENU]** button
- To return to the previous screen **[RETURN]** button

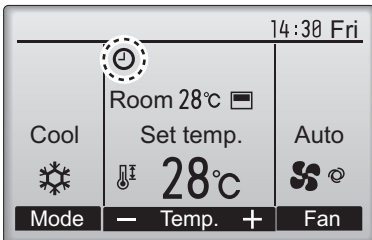

will appear on the Main display in the Full mode when the On/Off timer is enabled.

appears when the timer is disabled by the centralized control system.

Controller operation-Function settings

Timer

Main

P

Auto-Off timer

Button operation

1

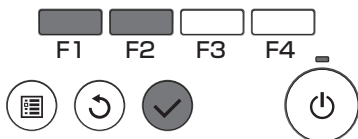
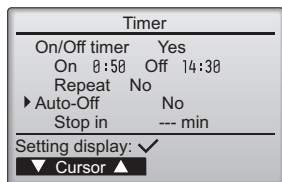

Bring up the Timer setting screen.
(Refer to page 26.)

Select "Auto-Off", and press the **SELECT** button.

The Auto-Off timer will not work in the following cases:
when Auto-Off timer is disabled, during an error, during check (in the service menu), during test run, during remote controller diagnosis, during Function setting, when the system is centrally controlled (when On/Off operation or Timer operation from local controller is prohibited).

2

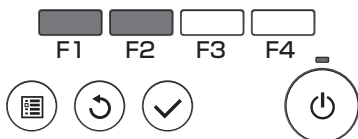
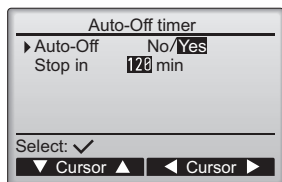

The current settings will appear.

Move the cursor to the "Auto-Off" or "Stop in --- min" with the **F1** or **F2** button.

3

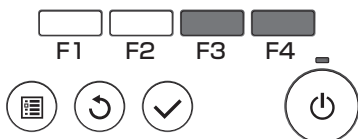
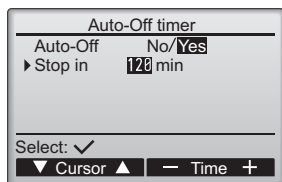

Change the setting with the **F3** or **F4** button.

- Auto-Off: No (disable)/Yes (enable)
- Stop in --- min: Timer setting (The settable range is 30 to 240 minutes in 10-minute increments.)

4

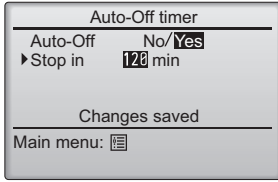
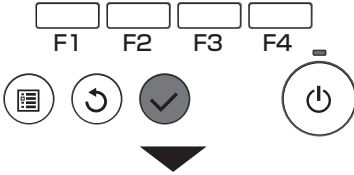
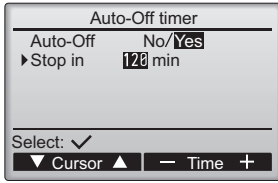



Press the **SELECT** button to save the settings.

A confirmation screen will appear.

Navigating through the screens

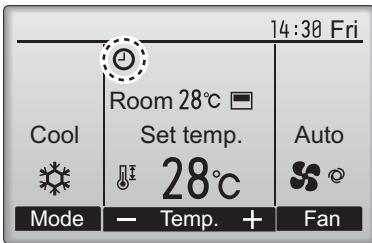
- To go back to the Main menu **MENU** button
- To return to the previous screen **RETURN** button



 will appear on the Main display in the Full mode when the Auto-Off timer is enabled.

 appears when the timer is disabled by the centralized control system.

Controller operation-Function settings

Weekly timer

Main

P

Button operation

1

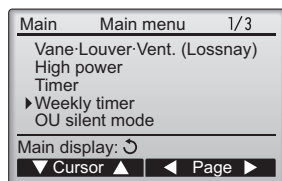

Select "Weekly timer" from the Main menu (refer to page 20), and press the **SELECT** button.

The Weekly timer will not work in the following cases: when the On/Off timer is enabled, when the weekly timer is disabled, during an error, during check (in the service menu), during test run, during remote controller diagnosis, when the clock is not set, during Function setting, when the system is centrally controlled (On/Off operation, temperature setting, or Timer operation from local remote controller is prohibited).

2

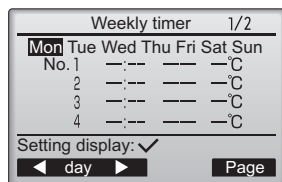

The current settings will appear.

Press the **F1** or **F2** button to see the settings for each day of the week.

Press the **F4** button to see patterns 5 through 8.

Press the **SELECT** button to go to the setting screen.

3

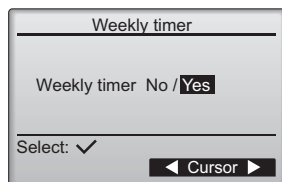

The screen to enable (Yes) and disable (No) the weekly timer will appear.

To enable the setting, move the cursor to "Yes" with the **F3** or **F4** button, and press the **SELECT** button.

4

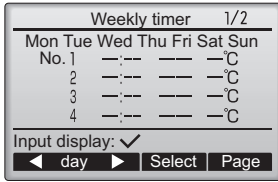

The weekly timer setting screen will appear and the current settings will be displayed.

Up to eight operation patterns can be set for each day.

Move the cursor to the desired day of the week with the **F1** or **F2** button, and press the **F3** button to select it. (Multiple days can be selected.)

Press the **SELECT** button.

5

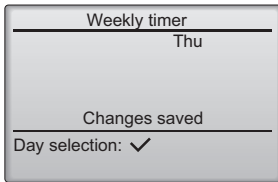
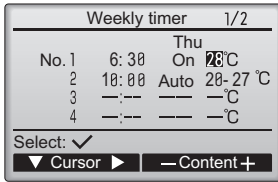

Operation pattern setting screen will appear.

Press the **F1** button to move the cursor to the desired pattern number.

Move the cursor to the time, On/Off, or temperature with the **F2** button.

Change the settings with the **F3** or **F4** button.

- Time: settable in 5-minute increments
 - * Press and hold the button to rapidly advance the numbers.
- On/Off/Auto: Selectable settings depend on the model of connected indoor unit. (When an Auto pattern is executed, the system will operate in the Auto (dual set point) mode.)
- Temperature: The settable temperature range depends on the connected indoor units. (1°C increments)
 - When the Auto (dual set point) mode is selected, two preset temperatures can be set. If an operation pattern with a single preset temperature setting is executed during the Auto (dual set point) mode, its setting will be used as the cooling temperature setting in the Cool mode.

Press the **SELECT** button to save the settings.

A confirmation screen will appear.

Navigating through the screens

- To go back to the setting change/day of the week selection screen **SELECT** button
- To go back to the Main menu **MENU** button
- To return to the previous screen **RETURN** button

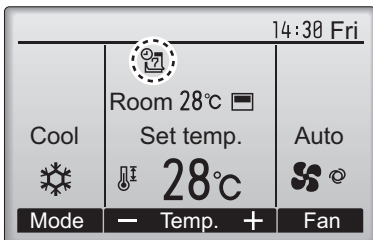

 will appear on the Main display in the Full mode when the weekly timer setting for the current day exists.

The icon will not appear while the On/Off timer is enabled or the system is under centralized control (Timer operation from local remote controller is prohibited).

Controller operation-Function settings

OU silent mode

Main

P

Function description

This function allows the user to set the time periods in which priority is given to quiet operation of outdoor units over temperature control. Set the start and stop times each day of the week for the quiet operation. Select the desired silent level from "Middle" and "Quiet".

Button operation

1

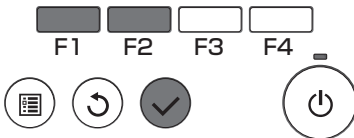
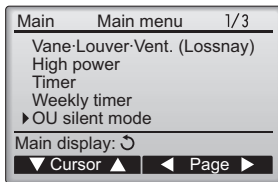

Select "OU silent mode" from the Main menu (refer to page 20), and press the **SELECT** button.

"OU silent mode" function is available only on the models that support the function.

2

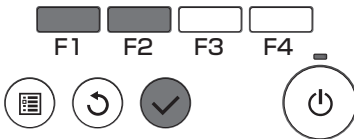

The current settings will appear.

Press the **F1** or **F2** button to see the settings for each day of the week.

Press the **SELECT** button to go to the setting screen.

3

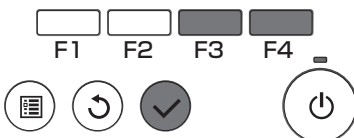
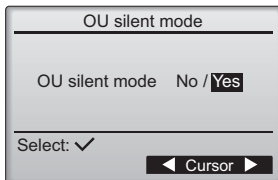

The screen to enable (Yes) and disable (No) the silent mode will appear.

To enable this setting, move the cursor to "Yes" with the **F3** or **F4** button, and press the **SELECT** button.

4



The OU silent mode setting screen will appear.

To make or change the setting, move the cursor to the desired day of the week with the **[F1]** or **[F2]** button, and press the **[F3]** button to select it. (Multiple days can be selected.)

Press the **[SELECT]** button.

5

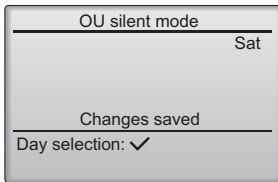
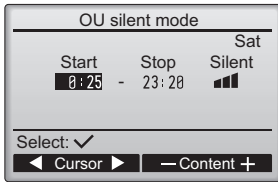

The setting screen will appear.

Move the cursor to the desired item with the **[F1]** or **[F2]** button out of Start time, Stop time, or Silent level.

Change the settings with the **[F3]** or **[F4]** button.

- Start/Stop time: settable in 5-minute increments
- * Press and hold the button to rapidly advance the numbers.
- Silent level: Normal, Middle, Quiet



Normal



Middle





Quiet

Press the **[SELECT]** button to save the settings. A confirmation screen will appear.

Navigating through the screens

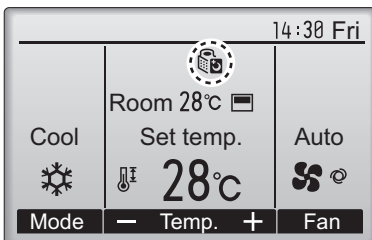
- To go back to the setting change/day of the week selection screen **[SELECT]** button
- To go back to the Main menu **[MENU]** button
- To return to the previous screen **[RETURN]** button



 will appear on the Main display in the Full mode during the OU silent mode.

Controller operation-Function settings

Restriction



Setting the temperature range restriction

Button operation

1

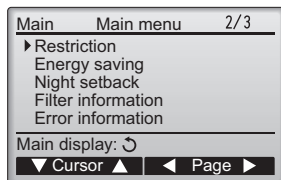

Select "Restriction" from the Main menu (refer to page 20), and press the **SELECT** button.

2

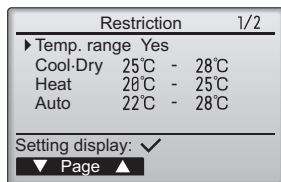

The current settings will appear.

Move the cursor to "Temp. range" with the **F1** or **F2** button, and press the **SELECT** button.

3

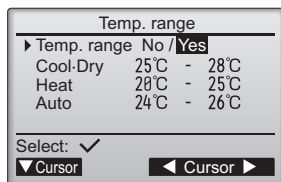

The screen to set the temperature range will appear.

Move the cursor to the desired item with the **F1** button out of "Temp. range," "Cool-Dry," "Heat," or "Auto."

4

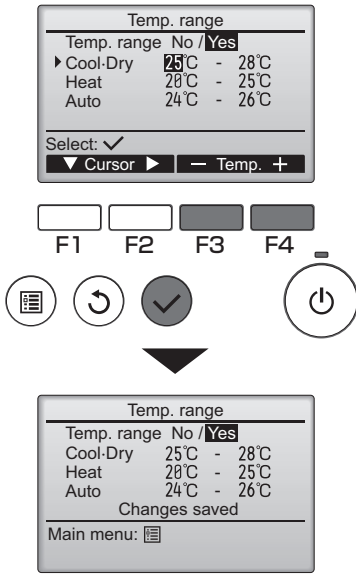

Change the settings with the **[F3]** or **[F4]** button.

- Temp. range: No (unrestricted) or Yes (restricted)
- Cool•Dry: Upper and lower limit temperature (1°C increments)
- Heat: Upper and lower limit temperature (1°C increments)
- Auto: Upper and lower limit temperature (1°C increments)

Temperature setting ranges

Mode		Lower limit	Upper limit
Cool•Dry	*1 *3	19 ~ 30°C (67 ~ 87°F)	30 ~ 19°C (87 ~ 67°F)
Heat	*2 *3	17 ~ 28°C (63 ~ 83°F)	28 ~ 17°C (83 ~ 63°F)
Auto	*4	19 ~ 28°C (67 ~ 83°F)	28 ~ 19°C (83 ~ 67°F)

- * The settable range varies depending on the connected unit.
- *1 Temperature ranges for the Cool, Dry, and Auto (dual set point) modes can be set.
- *2 Temperature ranges for the Heat and Auto (dual set point) modes can be set.
- *3 Temperature ranges for the Heat, Cool, and Dry modes must meet the conditions below:
 - Upper limit for cooling - upper limit for heating ≥ Minimum temperature difference (varies with indoor unit model)
 - Lower limit for cooling - lower limit for heating ≥ Minimum temperature difference (varies with indoor unit model)
- *4 Temperature range for the Auto (single set point) mode can be set.

Press the **[SELECT]** button to save the settings. A confirmation screen will appear.

Navigating through the screens

- To go back to the Main menu **[MENU]** button
- To return to the previous screen **[RETURN]** button

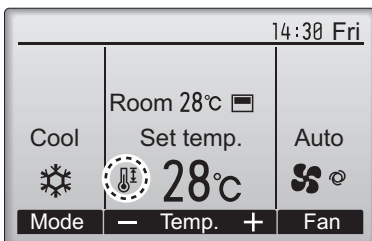

 will appear on the Main display in the Full mode when the temperature range is restricted.

Controller operation-Function settings

Restriction



Operation lock function

To enable the operation lock function, set the item "Operation locked" to "Yes".

Button operation

1

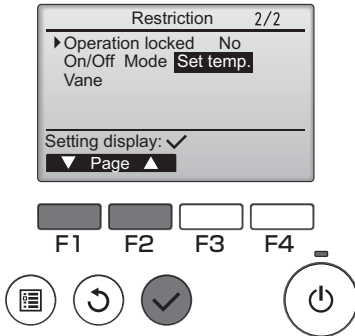

Bring up the Restriction setting screen. (Refer to page 34.)

Move the cursor to "Operation locked" and press the **SELECT** button.

2

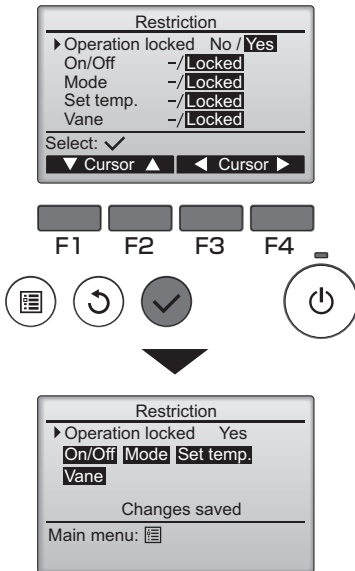

The screen to make the settings for the operation lock function will appear.

Move the cursor to the desired item with the **F1** or **F2** button out of "Operation locked," "On/Off," "Mode," "Set temp.," or "Vane."

Change the settings with the **F3** or **F4** button.

- Operation locked: No (disable)/Yes (enable)
 - On/Off: On/Off operation
 - Mode: Operation mode setting
 - Set temp.: Preset temp. setting
 - Vane: Vane setting
- "-" / "Locked"

Press the **SELECT** button to save the settings. A confirmation screen will appear.

Navigating through the screens

- To go back to the Main menu **MENU** button
- To return to the previous screen **RETURN** button

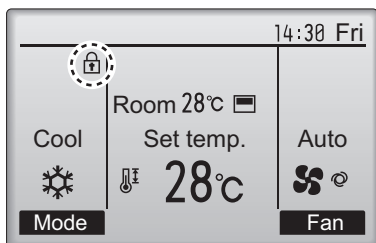

(When Set temp. is locked)

 will appear on the Main display in the Full mode when the operation lock function setting is enabled.

Operation guide that corresponds to the locked function will be suppressed.

Controller operation-Function settings

Energy saving

Main

P

Automatic return to the preset temperature

Button operation

1

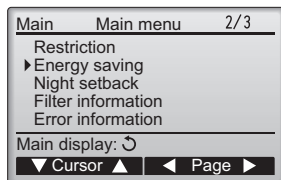

Select "Energy saving" from the Main menu (refer to page 20), and press the **SELECT** button.

2

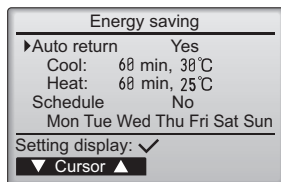

The current settings will appear.

Move the cursor to "Auto return" with the **F1** or **F2** button, and press the **SELECT** button.

3

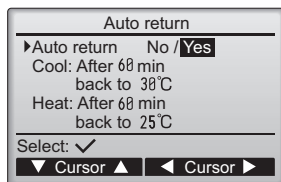

The screen to make the settings for the automatic return to the preset temperature will appear.

Move the cursor to the desired item with the **F1** or **F2** button out of "Auto return," "Cool," or "Heat."

4

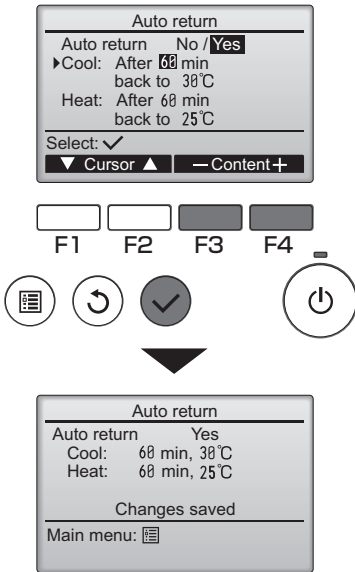

Change the settings with the **[F3]** or **[F4]** button.

- Auto return: No (disable)/Yes (enable)
- Cool: Timer setting range is 30 to 120 minutes in 10-minute increments.
Temperature setting range is 19 to 30°C (67 to 87°F) (1°C increments).
- Heat: Timer setting range is 30 to 120 minutes in 10-minute increments.
Temperature setting range is 17 to 28°C (63 to 83°F) (1°C increments).

Press the **[SELECT]** button to save the settings. "Cool" includes "Dry" and "AUTO Cooling" modes, and "Heat" includes "AUTO Heating" mode.

The screen to set the selected item will appear.

Navigating through the screens

- To go back to the Main menu **[MENU]** button
- To return to the previous screen **[RETURN]** button

The above Timer or Preset temperature settings will not be effective when the Temp. range is restricted and when the system is centrally controlled (when the Temp. range setting from local controller is prohibited). When the system is centrally controlled (when Timer operation from local remote controller is prohibited), only the Timer setting will be ineffective.

<Sample screens when the Auto return function is enabled>

Example: Lower the Set temp. to 24°C (75°F). 60 minutes later, the Set temp. will be back to 28°C (83°F).

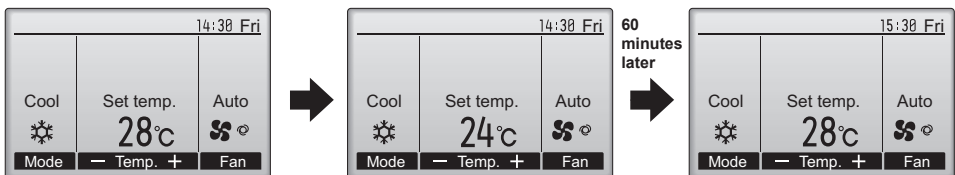

The Set temp. is changed from 28°C (83°F) to 24°C (75°F) by a user.

60 minutes later, the Set temp. returns to 28°C (83°F) automatically.

Controller operation-Function settings

Energy saving

Main

P

Setting the energy-saving operation schedule

Button operation

1

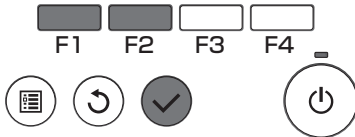
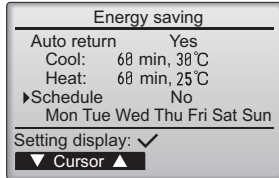

Bring up the "Energy saving" screen. (Refer to page 38.)

Move the cursor to the "Schedule," and press the **SELECT** button.

2

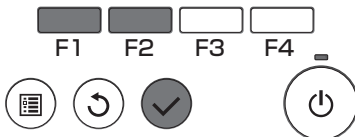
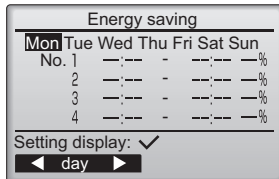

The screen to see the schedule will appear.

Press the **F1** or **F2** button to see the settings for each day of the week.

Press the **SELECT** button to go to the setting screen.

3

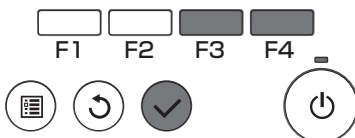
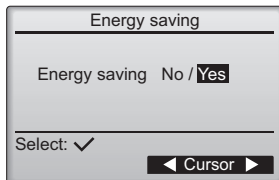

The screen to enable (Yes)/disable (No) the energy-saving operation schedule will appear.

Select "No" or "Yes" with the **F3** or **F4** button. Press the **SELECT** button to go to the setting change/day of the week selection screen.

4

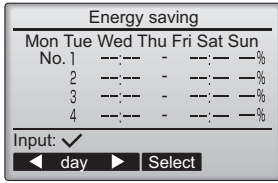

The setting change/day of the week selection screen will appear.

Up to four operation patterns can be set for each day.

Move the cursor to the desired day of the week with the **F1** or **F2** button, and press the **F3** button to select it. (Multiple days can be selected.)

Press the **SELECT** button to go to the pattern setting screen.

5

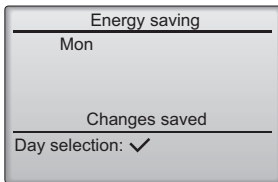
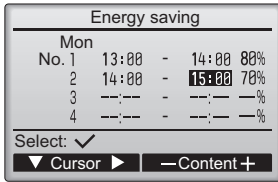

The pattern setting screen will appear.

Press the **F1** button to move the cursor to the desired pattern number.

Move the cursor to the desired item with the **F2** button out of the start time, stop time, and energy-saving rate (arranged in this order from the left).

Change the settings with the **F3** or **F4** button.

- Start/Stop time: settable in 5-minute increments
- * Press and hold the button to rapidly advance the numbers.
- Energy-saving rate: The setting range is 0% and 50 to 90% in 10% increments.

Press the **SELECT** button to save the settings.

A confirmation screen will appear.

The lower the value, the greater the energy-saving effect.

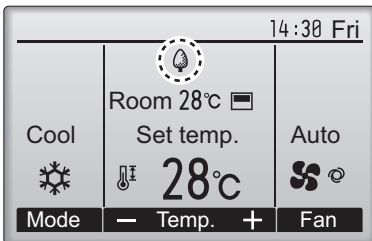

 will appear on the Main display in the Full mode when the unit is operated in the energy saving mode.

Navigating through the screens

- To go back to the setting change/day of the week selection screen **SELECT** button
- To go back to the Main menu **MENU** button
- To return to the previous screen **RETURN** button

Controller operation-Function settings

Night setback

Main

P

Function description

This control starts heating operation when the control object group is stopped and the room temperature drops below the preset lower limit temperature. Also, this control starts cooling operation when the control object group is stopped and the room temperature rises above the preset upper limit temperature.

The Night setback function is not available if the operation and the temperature setting are performed from the remote controller.

If the room temperature is measured by the air-conditioner's suction temperature sensor, the accurate temperature may not be obtained when the air-conditioner is inactive or when the air is not clean. In this case, switch the sensor to a remote sensor (PAC-SE40TSA/PAC-SE41TS-E) or a remote control sensor.

Button operation

1

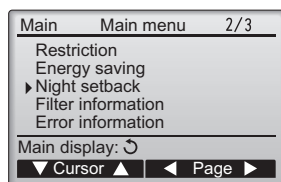

Select "Night setback" from the Main menu (refer to page 20), and press the **SELECT** button.

2

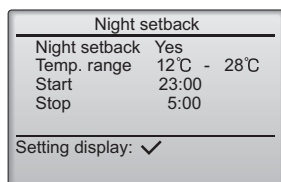

The current settings will appear.

Press the **SELECT** button to go to the setting screen.

3

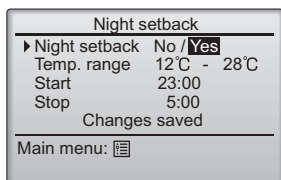
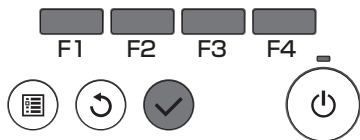
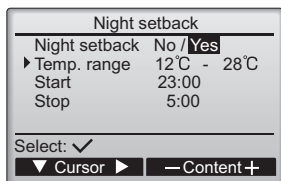

Move the cursor to the desired item with the **[F1]** or **[F2]** button out of Night setback No (disable)/ Yes (enable), Temp. range, Start time, or Stop time.

Change the settings with the **[F3]** or **[F4]** button.

- Temp. range: The lower limit temperature (for heating operation) and the upper limit temperature (for cooling operation) can be set. The temperature difference between the lower and upper limits must be 4°C (8°F) or more. The settable temperature range varies depending on the connected indoor units.
- Start/Stop time: settable in 5-minute increments
 - * Press and hold the button to rapidly advance the numbers.

Press the **[SELECT]** button to save the settings. A confirmation screen will appear.

Navigating through the screens

- To go back to the Main menu **[MENU]** button
- To return to the previous screen **[RETURN]** button

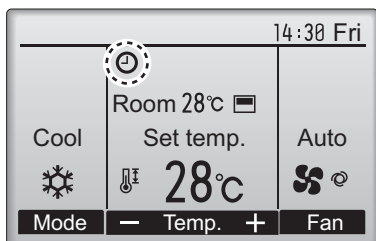

will appear on the Main display in the Full mode when the Night setback function is enabled.

appears when the timer is disabled by the centralized control system.

The Night setback will not work in the following cases:

when the unit is in operation, when the Night setback function is disabled, during an error, during check (in the service menu), during test run, during remote controller diagnosis, when the clock is not set, during Function setting, when the system is centrally controlled (On/Off operation, temperature setting, or Timer operation from local remote controller is prohibited).

Controller operation-Function settings

Manual vane angle

Main

OFF

Button operation

1

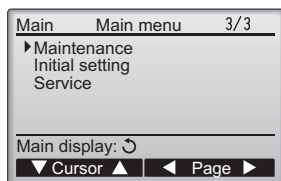

Select "Maintenance" from the Main menu (refer to page 20), and press the **SELECT** button.

2

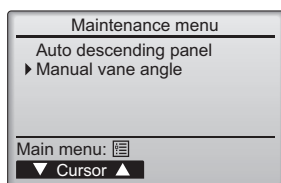

Select "Manual vane angle" with the **F1** or **F2** button, and press the **SELECT** button.

3

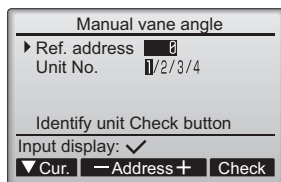

Move the cursor to "Ref. address" or "Unit No." with the **F1** button to select.

Select the refrigerant address and the unit number for the units to whose vanes are to be fixed, with the **F2** or **F3** button, and press the **SELECT** button.

- Ref. address: Refrigerant address
- Unit No.: 1, 2, 3, 4

Press the **F4** button to confirm the unit.

The screen at left shows a sample display on Mr. Slim. On City Multi units, "M-NET address," is displayed instead of "Ref. address", and the "Unit No." will not be displayed.

4

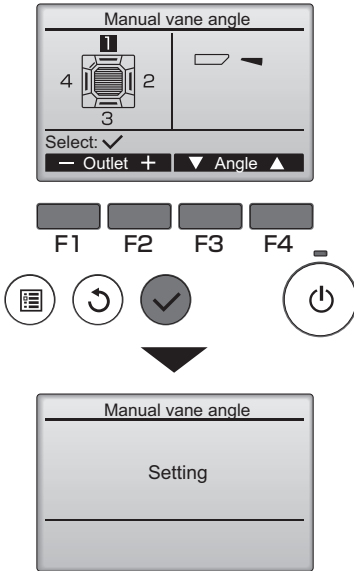

The current vane setting will appear.

Select the desired outlets from 1 through 4 with the **F1** or **F2** button.

• Outlet: "1," "2," "3," "4," and "1, 2, 3, 4, (all outlets)"

Press the **F3** or **F4** button to go through the option in the order of "No setting (reset)," "Step 1," "Step 2," "Step 3," "Step 4," and "Step 5." Select the desired setting.

■ Vane setting

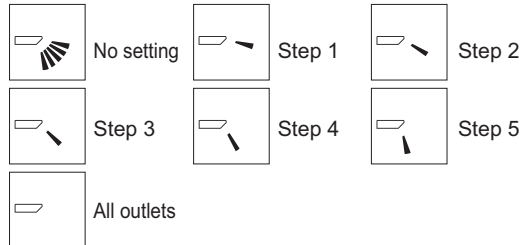

Press the **SELECT** button to save the settings. A screen will appear that indicates the setting information is being transmitted.

The setting changes will be made to the selected outlet.

The screen will automatically return to the one shown above (step 4) when the transmission is completed.

Make the settings for other outlets, following the same procedures.

If all outlets are selected,  will be displayed the next time the unit goes into operation.

Navigating through the screens

- To go back to the Main menu **MENU** button
- To return to the previous screen **RETURN** button

Controller operation-Function settings

Main display



Button operation

1

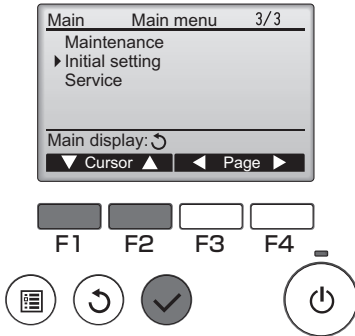

Select "Initial setting" from the Main menu (refer to page 20), and press the **SELECT** button.

2

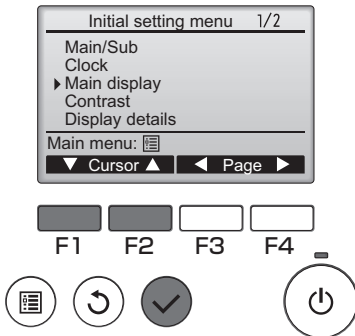

Move the cursor to the "Main display" with the **F1** or **F2** button, and press the **SELECT** button.

3

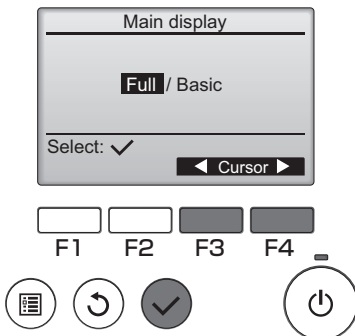

Select "Full" or "Basic" (refer to page 8) with the **F3** or **F4** button, and press the **SELECT** button.

A confirmation screen will appear.

Navigating through the screens

- To go back to the Main menu **MENU** button
- To return to the previous screen **RETURN** button

Button operation

1

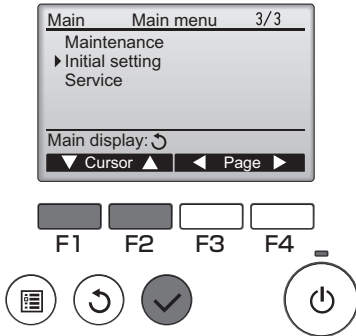

Select "Initial setting" from the Main menu (refer to page 20), and press the **SELECT** button.

2

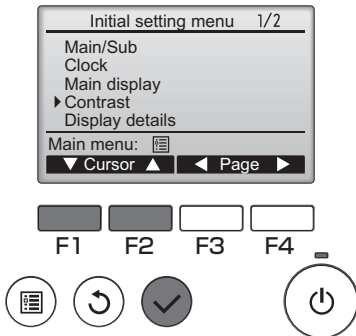

Move the cursor to the "Contrast" with the **F1** or **F2** button, and press the **SELECT** button.

3

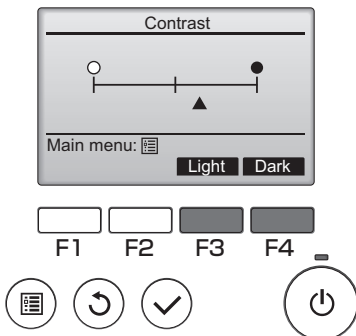

Adjust the contrast with the **F3** or **F4** button, and press the **MENU** or **RETURN** button.

Navigating through the screens

- To go back to the Main menu **MENU** button
- To return to the previous screen **RETURN** button

Controller operation-Function settings

Language selection



Function description

The desired language can be set. The language options are English, French, German, Spanish, Italian, Portuguese, Swedish, and Russian.

Button operation

1

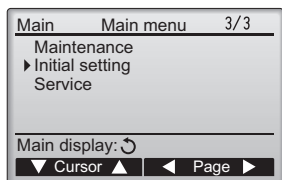

Select "Initial setting" from the Main menu (refer to page 20), and press the **SELECT** button.

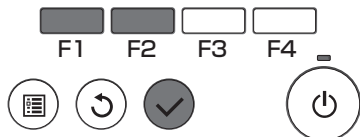

2

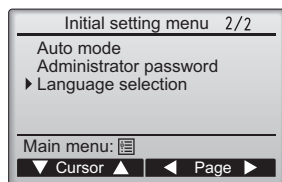

Move the cursor to the "Language selection" with the **F1** or **F2** button, and press the **SELECT** button.

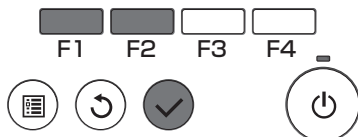

3

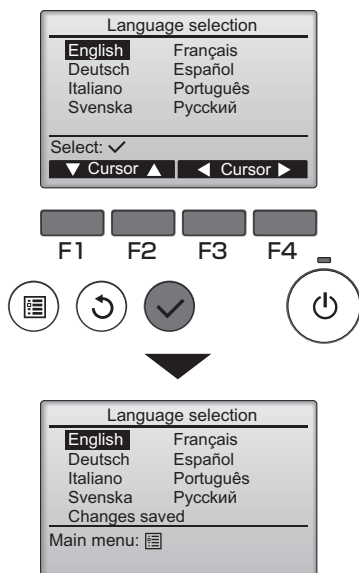

Move the cursor to the language you desire with the **F1** through **F4** buttons, and press the **SELECT** button to save the setting.

When the power is on for the first time, the Language selection screen will be displayed. Select a desired language. The system will not start-up without language selection.

A screen will appear that indicates the setting has been saved.

Navigating through the screens

- To go back to the Main menu **MENU** button
- To return to the previous screen **RETURN** button

Controller operation-Function settings

Function setting (City Multi)

OFF

P

Function description

Make the indoor units' function settings from the remote controller as necessary.

- The following settings should be made only for City Multi units and as necessary.
- Refer to the Installation Manual for how to make the settings for Mr. Slim units.
- Refer to the indoor unit Installation Manual for information about the factory settings of indoor units, function setting numbers, and setting values.
- When changing the indoor units' function settings, record all the changes made to keep track of the settings.

Button operation

1

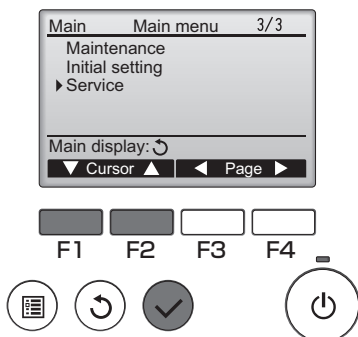

Select Service on the Main menu (see page 20), and press the **SELECT** button.

2

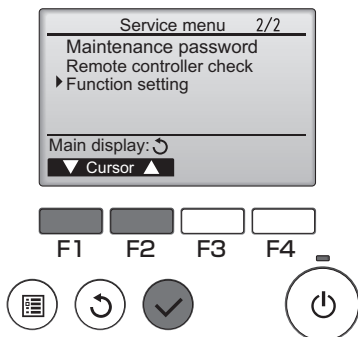

Select Function Setting on the Service Menu screen, and press the **SELECT** button.

3

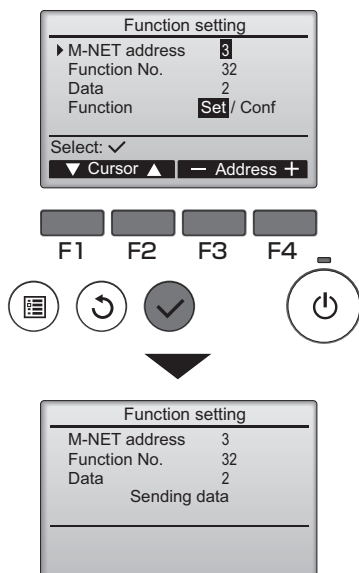

The Function Setting screen will appear.

Press the **F1** or **F2** button to move the cursor to one of the following: M-NET address, function setting number, or setting value. Then, press the **F3** or **F4** button to change the settings to the desired settings.

Once the settings have been completed, press the **SELECT** button.

A screen will appear that indicates that the settings information is being sent.

To check the current settings of a given unit, enter the setting for its M-NET address and function setting number, select Conf for the Function, and press the **SELECT** button.

A screen will appear that indicates that the settings are being searched for. When the search is done, the current settings will appear.

4

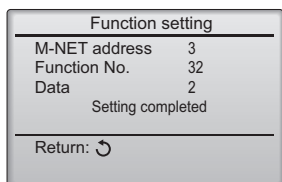

When the settings information has been sent, a screen will appear that indicates its completion.

To make additional settings, press the **RETURN** button to return to the screen shown in Step 3 above. Set the function numbers for other indoor units by following the same steps.

Navigating through the screens

- To return to the Service Menu screen **MENU** button
- To return to the previous screen **RETURN** button

Maintenance

Filter information

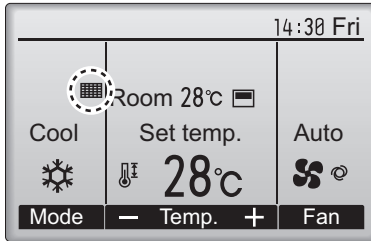

 will appear on the Main display in the Full mode when it is time to clean the filters.

Wash, clean, or replace the filters when this sign appears.

Refer to the indoor unit Instructions Manual for details.

Button operation

1

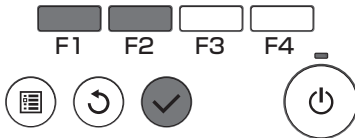
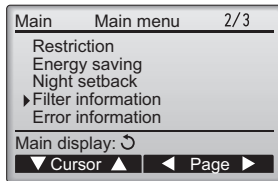

Select "Filter information" from the Main menu (refer to page 20), and press the **SELECT** button.

2

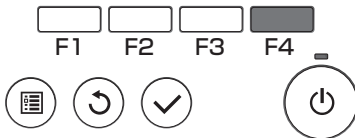

Press the **F4** button to reset filter sign.

Refer to the indoor unit Instructions Manual for how to clean the filter.

3



Select "OK" with the **F4** button.

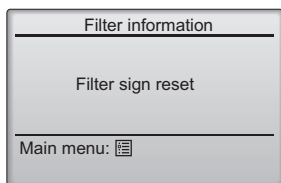
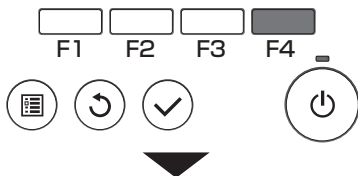

A confirmation screen will appear.

Navigating through the screens

- To go back to the Main menu **MENU** button
- To return to the previous screen **RETURN** button

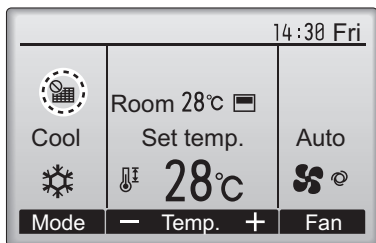

When the  is displayed on the Main display in the Full mode, the system is centrally controlled and the filter sign cannot be reset.

If two or more indoor units are connected, filter cleaning timing for each unit may be different, depending on the filter type.

The icon  will appear when the filter on the main unit is due for cleaning.

When the filter sign is reset, the cumulative operation time of all units will be reset.

The icon  is scheduled to appear after a certain duration of operation, based on the premise that the indoor units are installed in a space with ordinary air quality. Depending on the air quality, the filter may require more frequent cleaning.

The cumulative time at which filter needs cleaning depends on the model.

Troubleshooting

Error information

**When an error occurs, the following screen will appear.
Check the error status, stop the operation, and consult your dealer.**

Button operation

1

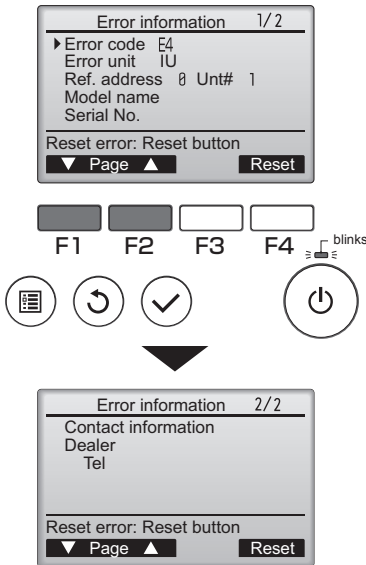

Error code, error unit, refrigerant address, unit model name, and serial number will appear. The model name and serial number will appear only if the information have been registered.

Press the **F1** or **F2** button to go to the next page.

Contact information (dealer's phone number) will appear if the information have been registered.

2

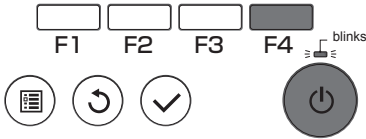
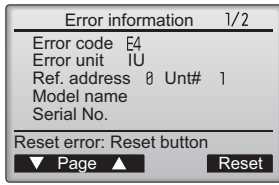

Press the **F4** button or the **ON/OFF** button to reset the error that is occurring.

Errors cannot be reset while the ON/OFF operation is prohibited.

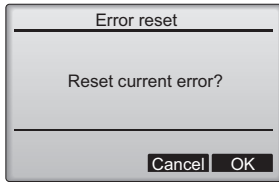

Select "OK" with the **F4** button.

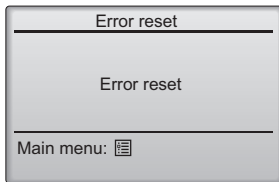

Navigating through the screens
• To go back to the Main menu **MENU** button

Checking the error information

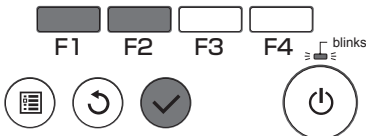
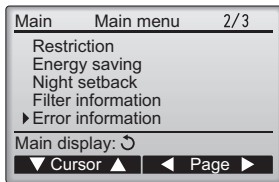

While no errors are occurring, page 2/2 of the error information (refer to page 54) can be viewed by selecting "Error information" from the Main menu (refer to page 20).
Errors cannot be reset from this screen.

Specifications

Controller specifications

	Specification
Product size	120(W) x 120(H) x 19(D) mm (4 3/4 x 4 3/4 x 3/4 [in]) (not including the protruding part)
Net weight	0.25 kg (9/16 lb.)
Rated power supply voltage	12 VDC (supplied from indoor units)
Power consumption	0.3 W
Usage environment	Temperature 0 ~ 40°C (32 ~ 104°F) Humidity 30 ~ 90%RH (with no dew condensation)
Material	Panel: PMMA Main body: PC + ABS

Function list (as of December 1, 2012)

○ : Supported ✕ : Unsupported

	Function	City Multi	Mr. Slim	Required password
Operation/ Display	Power ON/OFF	○	○	-
	Operation mode switch	○	○	-
	Room temperature setting	○	○	-
	Auto (dual set point) mode	○	✕	-
	Fan speed setting	○	○	-
	Vane angle setting	○	○	-
	Louver setting	○	○	-
	Ventilation setting	○	○	-
	High power operation	✕	○	-
	Auto descending panel	○	○	-
	Backlight	○	○	-
	Contrast setting	○	○	administrator
	Main display mode switch	○	○	administrator
	Clock setting	○	○	administrator
	Clock display format setting	○	○	administrator
	Language selection (8 languages)	○	○	administrator
	Room temperature display	○	○	administrator
Error display	○	○	-	
Filter information	○	○	-	
Schedule/ Timer	On/Off timer	○	○	administrator
	Auto-off timer	○	○	administrator
	Weekly timer	○	○	administrator
	Night setback	○	○	administrator
	OU silent mode	✕	○	administrator
Energy saving	Auto return	○	○	administrator
	Schedule	✕	○	administrator
Restriction	Operation lock	○	○	administrator
	Temperature range restriction	○	○	administrator
	Password	○	○	administrator
	(Administrator and Maintenance)	○	○	maintenance
Others	Manual vane angle	○	○	-
	Test run	○	○	maintenance
	Model information input	○	○	maintenance
	Dealer information input	○	○	maintenance
	Function setting	○	○	maintenance
	Smooth maintenance	✕	○	maintenance
	Refrigerant volume check	✕	○	maintenance
	Refrigerant leak check	✕	○	maintenance

* The supported functions vary depending on the unit model.

List of functions that can/cannot be used in combination

	High power	On/Off timer	Auto-off timer	Weekly timer	OU silent mode	Temperature range	Operation lock	Auto return	Energy saving schedule	Night setback
High power		○	○	○	△1	○	△2	○	△1	○
On/Off timer	○		○	×1	○	○	○	○	○	△3
Auto-off timer	○	○		○	○	○	○	○	○	△4
Weekly timer	○	×1	○		○	○	○	○	○	△5
OU silent mode	△1	○	○	○		○	○	○	○	○
Temperature range	○	○	○	○	○		○	×2	○	△6
Operation lock	△2	○	○	○	○	○		○	○	○
Auto return	○	○	○	○	○	×2	○		○	△7
Energy saving schedule	△1	○	○	○	○	○	○	○		○
Night setback	○	△3	△4	△5	○	△6	○	△7	○	

○ : Can be used in combination × : Cannot be used in combination △ : Restricted

△1: This function is enabled after completing the high power operation because the high power operation has the higher priority.

△2: This function cannot be operated if some operation is locked.

△3: Night setback function cannot be used when the unit is in operation by On/Off timer setting.

△4: Auto-off function cannot be used for Night setback operation.

△5: Night setback function cannot be used when the unit is in operation by Weekly timer setting.

△6: Temperature range setting cannot be used for Night setback operation.

△7: Auto return function cannot be used for Night setback operation.

×1: Weekly timer setting is not effective because On/Off timer has the higher priority.

×2: Auto return function cannot be used because Temperature range setting has the higher priority.

This product is designed and intended for use in the residential, commercial, and light-industrial environment.

The product at hand is based on the following EU regulations:

- Low Voltage Directive 2006/95/EC
- Electromagnetic Compatibility Directive 2004/108/EC

MITSUBISHI ELECTRIC CORPORATION

HEAD OFFICE: TOKYO BLDG., 2-7-3, MARUNOUCHI, CHIYODA-KU, TOKYO 100-8310, JAPAN

Authorized representative in EU: MITSUBISHI ELECTRIC EUROPE B.V.

HARMAN HOUSE, 1 GEORGE STREET, UXBRIDGE, MIDDLESEX UB8 1QQ, U.K.

WT06693X01