

SERVICE MANUAL

**No. OCH777
REVISED EDITION-A**

Series PLA Ceiling Cassettes

R32/R410A
Indoor unit
[Model Name]

 PLA-ZM35EA2
 PLA-ZM35EA2-ER
 PLA-ZM35EA2-ET
 PLA-ZM50EA2
 PLA-ZM50EA2-ER
 PLA-ZM50EA2-ET
 PLA-ZM60EA2
 PLA-ZM60EA2-ER
 PLA-ZM60EA2-ET
 PLA-ZM71EA2
 PLA-ZM71EA2-ER
 PLA-ZM71EA2-ET
 PLA-ZM100EA2
 PLA-ZM100EA2-ER
 PLA-ZM100EA2-ET
 PLA-ZM125EA2
 PLA-ZM125EA2-ER
 PLA-ZM125EA2-ET
 PLA-ZM140EA2
 PLA-ZM140EA2-ER
 PLA-ZM140EA2-ET

[Service Ref.]

 PLA-ZM35EA2.UK
 PLA-ZM35EA2-ER.UK
 PLA-ZM35EA2-ET.UK
 PLA-ZM50EA2.UK
 PLA-ZM50EA2-ER.UK
 PLA-ZM50EA2-ET.UK
 PLA-ZM60EA2.UK
 PLA-ZM60EA2-ER.UK
 PLA-ZM60EA2-ET.UK
 PLA-ZM71EA2.UK
 PLA-ZM71EA2-ER.UK
 PLA-ZM71EA2-ET.UK
 PLA-ZM100EA2.UK
 PLA-ZM100EA2-ER.UK
 PLA-ZM100EA2-ET.UK
 PLA-ZM125EA2.UK
 PLA-ZM125EA2-ER.UK
 PLA-ZM125EA2-ET.UK
 PLA-ZM140EA2.UK
 PLA-ZM140EA2-ER.UK
 PLA-ZM140EA2-ET.UK

Revision:

- PLP-6EAB has been added in REVISED EDITION-A.

OCH777 is void.

Grille model
[Model Name]

 PLP-6EA
 PLP-6EAE
 PLP-6EAL
 PLP-6EAL E
 PLP-6EAJ
 PLP-6EAJE
 PLP-6EALM2
 PLP-6EALME2
 PLP-6EAB

[Service Ref.]

 PLP-6EA
 PLP-6EAE
 PLP-6EAL
 PLP-6EAL E
 PLP-6EAJ
 PLP-6EAJE
 PLP-6EALM2
 PLP-6EALME2
 PLP-6EAB

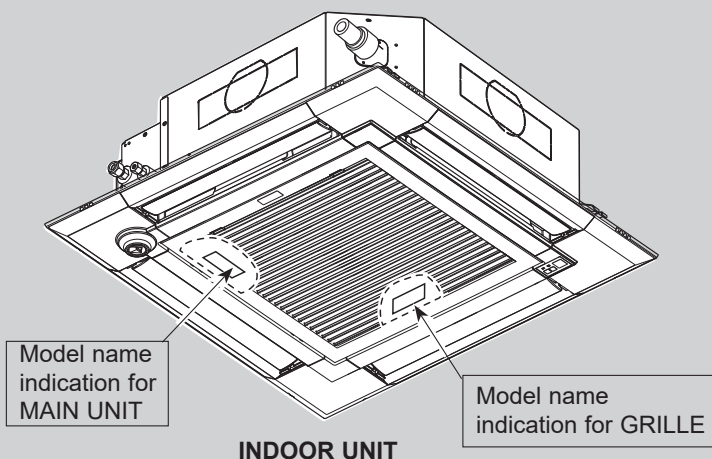
 PLP-6EAR1
 PLP-6EAER1
 PLP-6EALR1
 PLP-6EALER1

INDOOR UNIT

CONTENTS





1. REFERENCE MANUAL	2
2. SAFETY PRECAUTION	2
3. PARTS NAMES AND FUNCTIONS	8
4. SPECIFICATIONS	9
5. NOISE CRITERION CURVES	12
6. OUTLINES AND DIMENSIONS	14
7. WIRING DIAGRAM	15
8. REFRIGERANT SYSTEM DIAGRAM	16
9. TROUBLESHOOTING	17
10. FUNCTION SETTING	32
11. SPECIAL FUNCTION	33
12. DISASSEMBLY PROCEDURE	37
13. REMOTE CONTROLLER	44

PARTS CATALOG (OCB777)

OUTDOOR UNIT'S SERVICE MANUAL

Model Name	Service Ref.	Service Manual No./Parts Catalog No.
PUZ-ZM35/50VKA2(-ER/-ET)	PUZ-ZM35/50VKA2(-ER/-ET)	OCH751/OCB751
PUZ-ZM60/71VHA2 PUZ-ZM100/125/140VKA2 PUZ-ZM100/125/140/200/250YKA2	PUZ-ZM60/71VHA2.UK PUZ-ZM100/125/140VKA2.UK PUZ-ZM100/125/140/200/250YKA2.UK	OCH771/OCB771
PUHZ-ZRP35/50VKA2 PUHZ-ZRP60/71VHA2	PUHZ-ZRP35/50VKA2(-ER/-ET) PUHZ-ZRP60/71VHA2(-ER/-ET)	OCH635/OCB635
PUHZ-ZRP100VKA3 PUHZ-ZRP125/140VKA3 PUHZ-ZRP100YKA3 PUHZ-ZRP125/140YKA3 PUHZ-ZRP200/250YKA2	PUHZ-ZRP100VKA3.UK PUHZ-ZRP125/140VKA3R1.UK PUHZ-ZRP100YKA3R1.UK PUHZ-ZRP125/140YKA3R2.UK PUHZ-ZRP200/250YKA2.UK	OCH645/OCB645
PUHZ-SHW112VHA(-BS) PUHZ-SHW112YHA(-BS) PUHZ-SHW140YHA(-BS)	PUHZ-SHW112VHAR4(-BS).UK PUHZ-SHW112YHAR4(-BS).UK PUHZ-SHW140YHAR5(-BS).UK	OCH526/OCB526
PUHZ-SHW230YKA2	PUHZ-SHW230YKA2R2	OCH594/OCB594
PUHZ-FRP71VHA2	PUHZ-FRP71VHA2R1	OCH665/OCB665

MEANINGS OF SYMBOLS DISPLAYED ON THE UNIT

	WARNING (Risk of fire)	This mark is for R32 refrigerant only. Refrigerant type is written on nameplate of outdoor unit. In case that refrigerant type is R32, this unit uses a flammable refrigerant. If refrigerant leaks and comes in contact with fire or heating part, it will create harmful gas and there is risk of fire.
	Read the OPERATION MANUAL carefully before operation.	
	Service personnel are required to carefully read the OPERATION MANUAL and INSTALLATION MANUAL before operation.	
	Further information is available in the OPERATION MANUAL, INSTALLATION MANUAL, and the like.	

2-1. ALWAYS OBSERVE FOR SAFETY

Before obtaining access to terminal, all supply circuits must be disconnected.

2-2. CAUTIONS RELATED TO NEW REFRIGERANT

Cautions for units utilizing refrigerant R32/R410A

Preparation before the repair service.

- Prepare the proper tools.
- Prepare the proper protectors.
- Provide adequate ventilation.
- After stopping the operation of the air conditioner, turn off the power-supply breaker.
- Discharge the condenser before the work involving the electric parts.

Use new refrigerant pipes.

- In case of using the existing pipes for R22, be careful with the following.
- Be sure to clean the pipes and make sure that the insides of the pipes are clean.
 - Change flare nut to the one provided with this product. Use a newly flared pipe.
 - Avoid using thin pipes.
 - In case of reconnecting the refrigerant pipes after detaching, make the flared part of pipe re-fabricated.

Make sure that the inside and outside of refrigerant piping is clean and it has no contaminants such as sulfur, oxides, dirt, shaving particles, etc, which are hazard to refrigerant cycle. In addition, use pipes with specified thickness.

Contamination inside refrigerant piping can cause deterioration of refrigerant oil, etc.

Store the piping indoors, and keep both ends of the piping sealed until just before brazing. (Leave elbow joints, etc. in their packaging.)

If dirt, dust or moisture enters into refrigerant cycle, that can cause deterioration of refrigerant oil or malfunction of compressor.

The refrigerant oil applied to flare and flange connections must be ester oil, ether oil or alkylbenzene oil in a small amount.

If large amount of mineral oil enters, that can cause deterioration of refrigerant oil, etc.

Charge refrigerant from liquid phase of gas cylinder.

If the refrigerant is charged from gas phase, composition change may occur in refrigerant and the efficiency will be lowered.

Do not use a charging cylinder.

If a charging cylinder is used, the composition of refrigerant will change and the efficiency will be lowered.

Precautions during the repair service.

- Do not perform the work involving the electric parts with wet hands.
- Do not pour water into the electric parts.
- Do not touch the refrigerant.
- Do not touch the hot or cold areas in the refrigerating cycle.
- When the repair or the inspection of the circuit needs to be done without turning off the power, exercise great caution not to touch the live parts.
- When opening or closing the valve below freezing temperatures, refrigerant may spurt out from the gap between the valve stem and the valve body, resulting in injuries.

Use a vacuum pump with a reverse flow check valve.

Vacuum pump oil may flow back into refrigerant cycle and that can cause deterioration of refrigerant oil, etc.

Use the following tools specifically designed for use with R32/R410A refrigerant.

The following tools are necessary to use R32/R410A refrigerant.

Tools for R32/R410A	
Gauge manifold	Flare tool
Charge hose	Size adjustment gauge
Gas leak detector	Vacuum pump adaptor
Torque wrench	Electronic refrigerant charging scale

Handle tools with care.

If dirt, dust or moisture enters into refrigerant cycle, that can cause deterioration of refrigerant oil or malfunction of compressor.

Use the specified refrigerant only.

Never use any refrigerant other than that specified. Doing so may cause a burst, an explosion, or fire when the unit is being used, serviced, or disposed of. Correct refrigerant is specified on name plate of outdoor unit. If other refrigerant (R22, etc.) is used, chlorine in refrigerant can cause deterioration of refrigerant oil, etc. We will not be held responsible for mechanical failure, system malfunction, unit breakdown or accidents caused by failure to follow the instructions.

Ventilate the room if refrigerant leaks during operation. If refrigerant comes into contact with a flame, poisonous gases will be released.

[1] Warning for service

- (1) Do not alter the unit.
- (2) For installation and relocation work, follow the instructions in the Installation Manual and use tools and pipe components specifically made for use with refrigerant specified in the outdoor unit installation manual.
- (3) Ask a dealer or an authorized technician to install, relocate and repair the unit.
- (4) This unit should be installed in rooms which exceed the floor space specified in outdoor unit installation manual. Refer to outdoor unit installation manual.
- (5) Install the indoor unit at least 2.5 m above floor or grade level.
For appliances not accessible to the general public.
- (6) Refrigerant pipes connection shall be accessible for maintenance purposes.
- (7) If the air conditioner is installed in a small room or closed room, measures must be taken to prevent the refrigerant concentration in the room from exceeding the safety limit in the event of refrigerant leakage. Should the refrigerant leak and cause the concentration limit to be exceeded, hazards due to lack of oxygen in the room may result.
- (8) Keep gas-burning appliances, electric heaters, and other fire sources (ignition sources) away from the location where installation, repair, and other air conditioner work will be performed.
If refrigerant comes into contact with a flame, poisonous gases will be released.
- (9) When installing or relocating, or servicing the air conditioner, use only the specified refrigerant written on outdoor unit to charge the refrigerant lines.
Do not mix it with any other refrigerant and do not allow air to remain in the lines.
If air is mixed with the refrigerant, then it can be the cause of abnormal high pressure in the refrigerant line, and may result in an explosion and other hazards.
- (10) After installation has been completed, check for refrigerant leaks. If refrigerant leaks into the room and comes into contact with the flame of a heater or portable cooking range, poisonous gases will be released.
- (11) Do not use low temperature solder alloy in case of brazing the refrigerant pipes.
- (12) When performing brazing work, be sure to ventilate the room sufficiently. Make sure that there are no hazardous or flammable materials nearby.
When performing the work in a closed room, small room, or similar location, make sure that there are no refrigerant leaks before performing the work.
If refrigerant leaks and accumulates, it may ignite or poisonous gases may be released.
- (13) Do not install the unit in places where refrigerant may build-up or places with poor ventilation such as a semi-basement or a sunken place in outdoor: Refrigerant is heavier than air, and inclined to fall away from the leak source.
- (14) Do not use means to accelerate the defrosting process or to clean, other than those recommended by the manufacturer.
- (15) The appliance shall be stored in a room without continuously operating ignition sources (for example: open flames, an operating gas appliance or an operating electric heater).
- (16) Do not pierce or burn.
- (17) Be aware that refrigerants may not contain an odour.
- (18) Pipe-work shall be protected from physical damage.
- (19) The installation of pipe-work shall be kept to a minimum.
- (20) Compliance with national gas regulations shall be observed.
- (21) Keep any required ventilation openings clear of obstruction.
- (22) Servicing shall be performed only as recommended by the manufacturer.
- (23) The appliance shall be stored in a well-ventilated area where the room size corresponds to the room area as specified for operation.
- (24) Maintenance, service and repair operations shall be performed by authorized technician with required qualification.

[2] Cautions for service

- (1) Perform service after recovering the refrigerant left in unit completely.
- (2) Do not release refrigerant in the air.
- (3) After completing service, charge the cycle with specified amount of refrigerant.
- (4) When performing service, install a filter drier simultaneously.
Be sure to use a filter drier for new refrigerant.

[3] Additional refrigerant charge

When charging directly from cylinder

- (1) Check that cylinder for R32/R410A available on the market is a syphon type.
- (2) Charging should be performed with the cylinder of syphon stood vertically. (Refrigerant is charged from liquid phase.)

[4] Cautions for unit using R32 refrigerant

Basic work procedures are the same as those for conventional units using refrigerant R410A. However, pay careful attention to the following points.

(1) Information on servicing

(1-1) Checks on the Area

Prior to beginning work on systems containing flammable refrigerants, safety checks are necessary to ensure that the risk of ignition is minimized.

For repair to the refrigerating systems, (1-3) to (1-7) shall be completed prior to conducting work on the systems.

(1-2) Work Procedure

Work shall be undertaken under a controlled procedure so as to minimize the risk of a flammable gas or vapor being present while the work is being performed.

(1-3) General Work Area

All maintenance staff and others working in the local area shall be instructed on the nature of work being carried out.

Work in confined spaces shall be avoided. The area around the workspace shall be sectioned off. Ensure that the conditions within the area have been made safe by control of flammable material.

(1-4) Checking for Presence of Refrigerant

The area shall be checked with an appropriate refrigerant detector prior to and during work, to ensure the technician is aware of potentially toxic or flammable atmospheres. Ensure that the leak detection equipment being used is suitable for use with all applicable refrigerants, i.e. non-sparking, adequately sealed or intrinsically safe.

(1-5) Presence of Fire Extinguisher

If any hot work is to be conducted on the refrigeration equipment or any associated parts, appropriate fire extinguishing equipment shall be available to hand.

Have a dry powder or CO₂ fire extinguisher adjacent to the charging area.

(1-6) No Ignition Sources

No person carrying out work in relation to a refrigeration system which involves exposing any pipe work shall use any sources of ignition in such a manner that it may lead to the risk of fire or explosion. All possible ignition sources, including cigarette smoking, should be kept sufficiently far away from the site of installation, repairing, removing and disposal, during which refrigerant can possibly be released to the surrounding space. Prior to work taking place, the area around the equipment is to be surveyed to make sure that there are no flammable hazards or ignition risks. "No Smoking" signs shall be displayed.

(1-7) Ventilated Area

Ensure that the area is in the open or that it is adequately ventilated before breaking into the system or conducting any hot work. A degree of ventilation shall continue during the period that the work is carried out. The ventilation should safely disperse any released refrigerant and preferably expel it externally into the atmosphere.

(1-8) Checks on the Refrigeration Equipment

Where electrical components are being changed, they shall be fit for the purpose and to the correct specification. At all times the manufacturer's maintenance and service guidelines shall be followed. If in doubt, consult the manufacturer's technical department for assistance.

The following checks shall be applied to installations using flammable refrigerants:

- The charge size is in accordance with the room size within which the refrigerant containing parts are installed.
- The ventilation machinery and outlets are operating adequately and are not obstructed.
- Marking to the equipment continues to be visible and legible. Markings and signs that are illegible shall be corrected.
- Refrigeration pipe or components are installed in a position where they are unlikely to be exposed to any substance which may corrode refrigerant containing components, unless the components are constructed of materials which are inherently resistant to being corroded or are suitably protected against being corroded.

(1-9) Checks on Electrical Devices

Repair and maintenance to electrical components shall include initial safety checks and component inspection procedures. If a fault exists that could compromise safety, then no electrical supply shall be connected to the circuit until it is satisfactorily dealt with. If the fault cannot be corrected immediately but it is necessary to continue operation, an adequate temporary solution shall be used. This shall be reported to the owner of the equipment so all parties are advised. Initial safety checks shall include that:

- capacitors are discharged: this shall be done in a safe manner to avoid possibility of sparking;
- no live electrical components and wiring are exposed while charging, recovering or purging the system;
- there is continuity of earth bonding

(2) Repairs to Sealed Components

(2-1) During repairs to sealed components, all electrical supplies shall be disconnected from the equipment being worked upon prior to any removal of sealed covers, etc. If it is absolutely necessary to have an electrical supply to equipment during servicing, then a permanently operating form of leak detection shall be located at the most critical point to warn of a potentially hazardous situation.

(2-2) Particular attention shall be paid to the following to ensure that by working on electrical components, the casing is not altered in such a way that the level of protection is affected. This shall include damage to cables, excessive number of connections, terminals not made to original specification, damage to seals, incorrect fitting of glands, etc.

Ensure that the apparatus is mounted securely.

Ensure that seals or sealing materials have not degraded to the point that they no longer serve the purpose of preventing the ingress of flammable atmospheres.

Replacement parts shall be in accordance with the manufacturer's specifications.

(3) Repair to intrinsically Safe Components

Do not apply any permanent inductive or capacitance loads to the circuit without ensuring that this will not exceed the permissible voltage and current permitted for the equipment in use.

Intrinsically safe components are the only types that can be worked on while live in the presence of a flammable atmosphere. The test apparatus shall be at the correct rating.

Replace components only with parts specified by the manufacturer. Other parts may result in the ignition of refrigerant in the atmosphere from a leak.

(4) Cabling

Check that cabling will not be subject to wear, corrosion, excessive pressure, vibration, sharp edges or any other adverse environmental effects. The check shall also take into account the effects of aging or continual vibration from sources such as compressors or fans.

(5) Detection of Flammable Refrigerants

Under no circumstances shall potential sources of ignition be used in the searching for or detection of refrigerant leaks.

A halide torch (or any other detector using a naked flame) shall not be used.

(6) Leak Detection Methods

Electronic leak detectors may be used to detect refrigerant leaks but, in the case of flammable refrigerants, the sensitivity may not be adequate, or may need re-calibration. (Detection equipment shall be calibrated in a refrigerant-free area.)

Ensure that the detector is not a potential source of ignition and is suitable for the refrigerant used. Leak detection equipment shall be set at a percentage of the LFL of the refrigerant and shall be calibrated to the refrigerant employed, and the appropriate percentage of gas (25% maximum) is confirmed.

Leak detection fluids are suitable for use with most refrigerants but the use of detergents containing chlorine shall be avoided as the chlorine may react with the refrigerant and corrode the copper pipe-work.

If a leak is suspected, all naked flames shall be removed/extinguished.

If a leakage of refrigerant is found which requires brazing, all of the refrigerant shall be recovered from the system, or isolated (by means of shut off valves) in a part of the system remote from the leak. For appliances containing flammable refrigerants, oxygen free nitrogen (OFN) shall then be purged through the system both before and during the brazing process.

(7) Removal and Evacuation

When breaking into the refrigerant circuit to make repairs – or for any other purpose conventional procedures shall be used. However, for flammable refrigerants it is important that best practice is followed since flammability is a consideration. The following procedure shall be adhered to:

- remove refrigerant
- purge the circuit with inert gas
- evacuate
- purge again with inert gas
- open the circuit by cutting or brazing.

The refrigerant charge shall be recovered into the correct recovery cylinders. For appliances containing flammable refrigerants, the system shall be “flushed” with OFN to render the unit safe. This process may need to be repeated several times.

Compressed air or oxygen shall not be used for purging refrigerant systems.

For appliances containing flammable refrigerants, flushing shall be achieved by breaking the vacuum in the system with OFN and continuing to fill until the working pressure is achieved, then venting to atmosphere, and finally pulling down to a vacuum. This process shall be repeated until no refrigerant is within the system. When the final OFN charge is used, the system shall be vented down to atmospheric pressure to enable work to take place. This operation is absolutely vital if brazing operations on the pipe-work are to take place.

Ensure that the outlet for the vacuum pump is not close to any ignition sources and that ventilation is available.

(8) Charging Procedures

In addition to conventional charging procedures, the following requirements shall be followed:

- Ensure that contamination of different refrigerants does not occur when using charging equipment. Hoses or lines shall be as short as possible to minimize the amount of refrigerant contained in them.
- Cylinders shall be kept upright.
- Ensure that the refrigeration system is earthed prior to charging the system with refrigerant.
- Label the system when charging is complete (if not already).
- Extreme care shall be taken not to overfill the refrigeration system.

Prior to recharging the system, it shall be pressure-tested with the appropriate purging gas. The system shall be leak-tested on completion of charging but prior to commissioning. A follow up leak test shall be carried out prior to leaving the site.

(9) Decommissioning

Before carrying out this procedure, it is essential that the technician is completely familiar with the equipment and all its detail. It is recommended good practice that all refrigerants are recovered safely. Prior to the task being carried out, an oil and refrigerant sample shall be taken in case analysis is required prior to re-use of reclaimed refrigerant. It is essential that electrical power is available before the task is commenced.

Continued to the next page

- a) Become familiar with the equipment and its operation.
- b) Isolate system electrically.
- c) Before attempting the procedure, ensure that:
 - mechanical handling equipment is available, if required, for handling refrigerant cylinders;
 - all personal protective equipment is available and being used correctly;
 - the recovery process is supervised at all times by a competent person;
 - recovery equipment and cylinders conform to the appropriate standards.
- d) Pump down refrigerant system, if possible.
- e) If a vacuum is not possible, make a manifold so that refrigerant can be removed from various parts of the system.
- f) Make sure that cylinder is situated on the scales before recovery takes place.
- g) Start the recovery machine and operate in accordance with manufacturer's instructions.
- h) Do not overfill cylinders. (No more than 80 % volume liquid charge).
- i) Do not exceed the maximum working pressure of the cylinder, even temporarily.
- j) When the cylinders have been filled correctly and the process completed, make sure that the cylinders and the equipment are removed from site promptly and all isolation valves on the equipment are closed off.
- k) Recovered refrigerant shall not be charged into another refrigeration system unless it has been cleaned and checked.

(10) Labelling

Equipment shall be labelled stating that it has been de-commissioned and emptied of refrigerant. The label shall be dated and signed. For appliances containing flammable refrigerants, ensure that there are labels on the equipment stating the equipment contains flammable refrigerant.

(11) Recovery

When removing refrigerant from a system, either for servicing or decommissioning, it is recommended good practice that all refrigerants are removed safely. When transferring refrigerant into cylinders, ensure that only appropriate refrigerant recovery cylinders are employed. Ensure that the correct number of cylinders for holding the total system charge are available. All cylinders to be used are designated for the recovered refrigerant and labelled for that refrigerant (i.e. special cylinders for the recovery of refrigerant). Cylinders shall be complete with pressure-relief valve and associated shut-off valves in good working order. Empty recovery cylinders are evacuated and, if possible, cooled before recovery occurs.

The recovery equipment shall be in good working order with a set of instructions concerning the equipment that is at hand and shall be suitable for the recovery of all appropriate refrigerants including, when applicable, flammable refrigerants. In addition, a set of calibrated weighing scales shall be available and in good working order. Hoses shall be complete with leak-free disconnect couplings and in good condition. Before using the recovery machine, check that it is in satisfactory working order, has been properly maintained and that any associated electrical components are sealed to prevent ignition in the event of a refrigerant release. Consult manufacturer if in doubt.

The recovered refrigerant shall be returned to the refrigerant supplier in the correct recovery cylinder, and the relevant waste transfer note arranged. Do not mix refrigerants in recovery units and especially not in cylinders. If compressors or compressor oils are to be removed, ensure that they have been evacuated to an acceptable level to make certain that flammable refrigerant does not remain within the lubricant. The evacuation process shall be carried out prior to returning the compressor to the suppliers. Only electric heating to the compressor body shall be employed to accelerate this process. When oil is drained from a system, it shall be carried out safely.

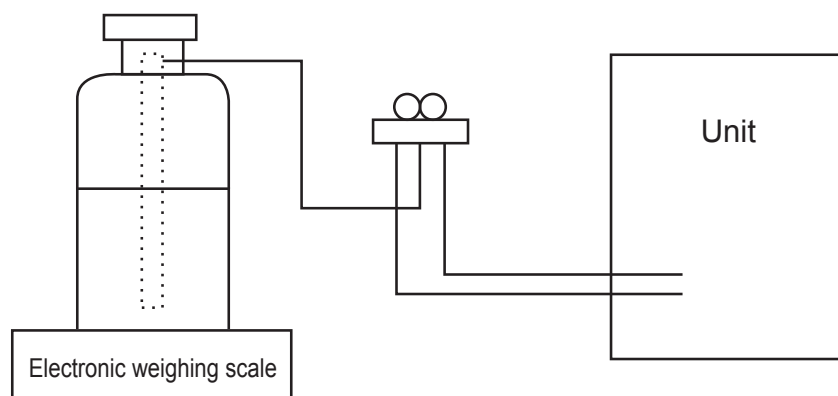

[5] Service tools

Use the below service tools as exclusive tools for R32/R410A refrigerant.

Refer to the spec name plate on outdoor unit for the type of refrigerant being used.

No.	Tool name	Specifications
1.	Gauge manifold	<ul style="list-style-type: none"> Use the existing fitting specifications. (UNF1/2) Use high-tension side pressure of 5.3MPa·G or over.
2.	Charge hose	<ul style="list-style-type: none"> Use pressure performance of 5.09MPa·G or over.
3.	Electronic weighing scale	—
4.	Gas leak detector	<ul style="list-style-type: none"> Use the detector for R134a, R407, R410A, or R32.
5.	Adaptor for reverse flow check	<ul style="list-style-type: none"> Attach on vacuum pump.
6.	Refrigerant charge base	—
7.	Refrigerant cylinder	<ul style="list-style-type: none"> R32 or R410A refrigerant Cylinder with syphon
8.	Refrigerant recovery equipment	—

3

PARTS NAMES AND FUNCTIONS

3-1. INDOOR UNIT

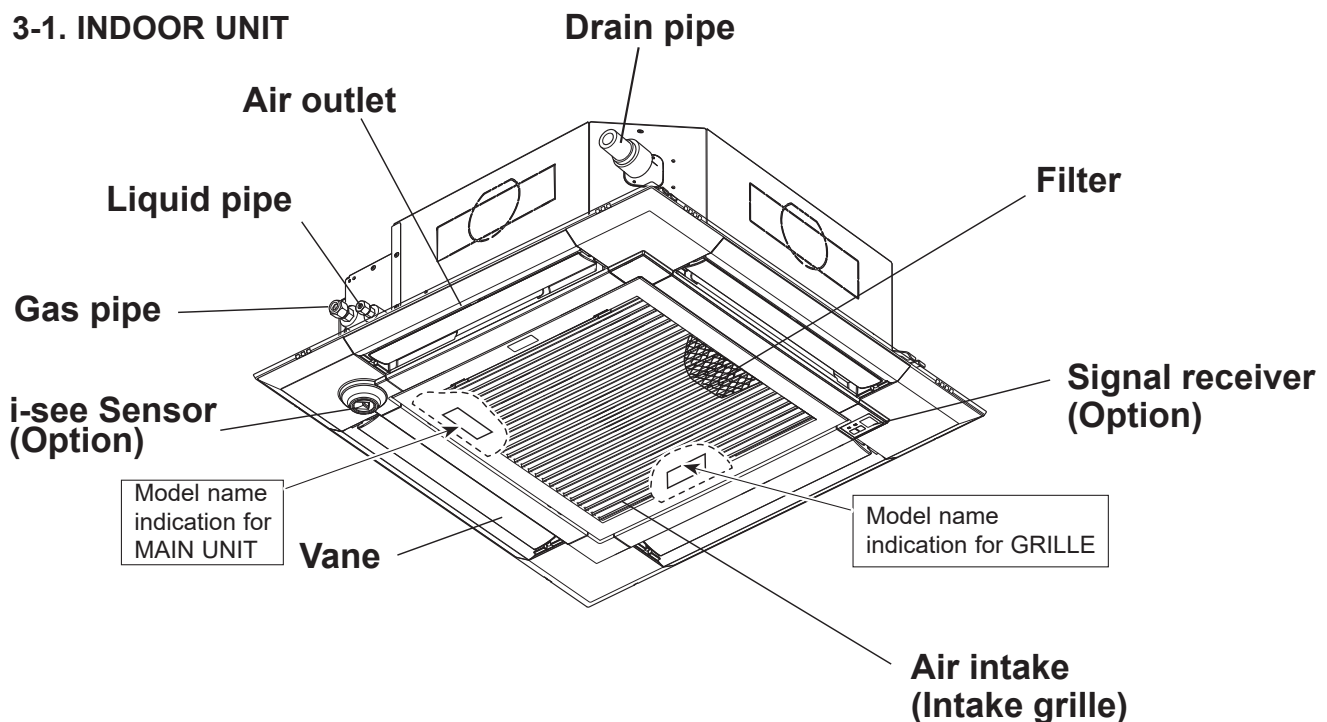

3-2. WIRELESS REMOTE CONTROLLER (Option)

Refer to "13-1. REMOTE CONTROLLER FUNCTIONS" for details.

4

SPECIFICATIONS

Service Ref.			PLA-ZM35EA2(-ET/ER).UK	
Mode			Cooling	Heating
Power supply (phase, cycle, voltage)			Single phase, 50Hz, 230 V	
Input			0.03	0.03
Running current			0.21	0.19
External finish (Grille)			Munsell 1.0Y 9.2/0.2	
Heat exchanger			Plate fin coil	
INDOOR UNIT	Fan (drive) × No.		Turbo fan (direct) × 1	
	Fan motor output		0.050	
	Airflow (Low-Medium2-Medium1-High)		11-13-15-16	
	External static pressure		0(direct blow)	
Booster heater			-	
Operation control & Thermostat			Remote controller & built-in	
Noise level SPL(Low-Medium2-Medium1-High)			26-28-29-31	
Field drain pipe O.D.			32 (1-1/4)	
INDOOR UNIT	Dimensions	W	mm (inch)	UNIT : 840 (33-3/32) GRILLE : 950 (37-13/32)
		D	mm (inch)	UNIT : 840 (33-3/32) GRILLE : 950 (37-13/32)
		H	mm (inch)	UNIT : 258 (10-3/16) GRILLE : 40 (1-9/16)
Weight			UNIT : 21	GRILLE : 5

Service Ref.			PLA-ZM50EA2(-ET/ER).UK	
Mode			Cooling	Heating
Power supply (phase, cycle, voltage)			Single phase, 50Hz, 230 V	
Input			0.03	0.03
Running current			0.22	0.20
External finish (Grille)			Munsell 1.0Y 9.2/0.2	
Heat exchanger			Plate fin coil	
INDOOR UNIT	Fan (drive) × No.		Turbo fan (direct) × 1	
	Fan motor output		0.050	
	Airflow (Low-Medium2-Medium1-High)		12-14-16-18	
	External static pressure		0(direct blow)	
Booster heater			-	
Operation control & Thermostat			Remote controller & built-in	
Noise level SPL(Low-Medium2-Medium1-High)			27-29-31-32	
Field drain pipe O.D.			32(1-1/4)	
INDOOR UNIT	Dimensions	W	mm (inch)	UNIT : 840 (33-3/32) GRILLE : 950 (37-13/32)
		D	mm (inch)	UNIT : 840 (33-3/32) GRILLE : 950 (37-13/32)
		H	mm (inch)	UNIT : 258 (10-3/16) GRILLE : 40 (1-9/16)
Weight			UNIT : 21	GRILLE : 5

Service Ref.			PLA-ZM60EA2(-ET/ER).UK	
Mode			Cooling	Heating
Power supply (phase, cycle, voltage)			Single phase, 50Hz, 230 V	
Input			0.03	0.03
Running current			0.22	0.20
External finish (Grille)			Munsell 1.0Y 9.2/0.2	
Heat exchanger			Plate fin coil	
INDOOR UNIT	Fan (drive) × No.		Turbo fan (direct) × 1	
	Fan motor output		0.050	
	Airflow (Low-Medium2-Medium1-High)		12-14-16-18	
	External static pressure		0(direct blow)	
Booster heater			-	
Operation control & Thermostat			Remote controller & built-in	
Noise level SPL (Low-Medium2-Medium1-High)			27-29-31-32	
Field drain pipe O.D.			32(1-1/4)	
INDOOR UNIT	Dimensions	W	mm (inch)	UNIT : 840 (33-3/32) GRILLE : 950 (37-13/32)
		D	mm (inch)	UNIT : 840 (33-3/32) GRILLE : 950 (37-13/32)
		H	mm (inch)	UNIT : 258 (10-3/16) GRILLE : 40 (1-9/16)
Weight			UNIT : 21	GRILLE : 5

Service Ref.			PLA-ZM71EA2(-ET/ER).UK	
Mode			Cooling	Heating
Power supply (phase, cycle, voltage)			Single phase, 50Hz, 230 V	
Input		kW	0.05	0.05
Running current		A	0.34	0.32
External finish (Grille)			Munsell 1.0Y 9.2/0.2	
Heat exchanger			Plate fin coil	
Fan			Turbo fan (direct) × 1	
Fan (drive) × No.				
Fan motor output		kW	0.120	
Airflow (Low-Medium2-Medium1-High)		m³/min	17-19-21-23	
External static pressure		Pa (mmAq)	0(direct blow)	
Booster heater			-	
Operation control & Thermostat			Remote controller & built-in	
Noise level SPL (Low-Medium2-Medium1-High)			28-30-33-36	
Field drain pipe O.D.			32(1-1/4)	
Dimensions		W	UNIT : 840 (33-3/32)	GRILLE : 950 (37-13/32)
		D	UNIT : 840 (33-3/32)	GRILLE : 950 (37-13/32)
		H	UNIT : 298 (11-3/4)	GRILLE : 40 (1-9/16)
Weight			UNIT : 24	GRILLE : 5

Service Ref.			PLA-ZM100EA2(-ET/ER).UK	
Mode			Cooling	Heating
Power supply (phase, cycle, voltage)			Single phase, 50Hz, 230 V	
Input		kW	0.07	0.07
Running current		A	0.47	0.45
External finish (Grille)			Munsell 1.0Y 9.2/0.2	
Heat exchanger			Plate fin coil	
Fan			Turbo fan (direct) × 1	
Fan (drive) × No.				
Fan motor output		kW	0.120	
Airflow (Low-Medium2-Medium1-High)		m³/min	19-22-25-28	
External static pressure		Pa (mmAq)	0(direct blow)	
Booster heater			-	
Operation control & Thermostat			Remote controller & built-in	
Noise level SPL (Low-Medium2-Medium1-High)			31-34-37-40	
Field drain pipe O.D.			32(1-1/4)	
Dimensions		W	UNIT : 840 (33-3/32)	GRILLE : 950 (37-13/32)
		D	UNIT : 840 (33-3/32)	GRILLE : 950 (37-13/32)
		H	UNIT : 298 (11-3/4)	GRILLE : 40 (1-9/16)
Weight			UNIT : 26	GRILLE : 5

Service Ref.			PLA-ZM125EA2(-ET/ER).UK	
Mode			Cooling	Heating
Power supply (phase, cycle, voltage)			Single phase, 50Hz, 230 V	
Input		kW	0.08	0.08
Running current		A	0.52	0.50
External finish (Grille)			Munsell 1.0Y 9.2/0.2	
Heat exchanger			Plate fin coil	
Fan			Turbo fan (direct) × 1	
Fan (drive) × No.				
Fan motor output		kW	0.120	
Airflow (Low-Medium2-Medium1-High)		m³/min	21-24-26-29	
External static pressure		Pa (mmAq)	0(direct blow)	
Booster heater			-	
Operation control & Thermostat			Remote controller & built-in	
Noise level SPL (Low-Medium2-Medium1-High)			33-36-39-41	
Field drain pipe O.D.			32(1-1/4)	
Dimensions		W	UNIT : 840 (33-3/32)	GRILLE : 950 (37-13/32)
		D	UNIT : 840 (33-3/32)	GRILLE : 950 (37-13/32)
		H	UNIT : 298 (11-3/4)	GRILLE : 40 (1-9/16)
Weight			UNIT : 26	GRILLE : 5

Service Ref.			PLA-ZM140EA2(-ET/ER).UK	
Mode			Cooling	Heating
Power supply (phase, cycle, voltage)			Single phase, 50Hz, 230 V	
Input		kW	0.10	0.10
Running current		A	0.66	0.64
External finish (Grille)			Munsell 1.0Y 9.2/0.2	
Heat exchanger			Plate fin coil	
INDOOR UNIT	Fan (drive) × No.		Turbo fan (direct) × 1	
	Fan motor output		0.120	
	Airflow (Low-Medium2-Medium1-High)		24-26-29-32	
	External static pressure		0(direct blow)	
Booster heater		kW	-	
Operation control & Thermostat			Remote controller & built-in	
Noise level SPL (Low-Medium2-Medium1-High)		dB(A)	36-39-42-44	
Field drain pipe O.D.		mm (inch)	32(1-1/4)	
Dimensions	W	mm (inch)	UNIT : 840 (33-3/32)	GRILLE : 950 (37-13/32)
	D	mm (inch)	UNIT : 840 (33-3/32)	GRILLE : 950 (37-13/32)
	H	mm (inch)	UNIT : 298 (11-3/4)	GRILLE : 40 (1-9/16)
Weight		kg	UNIT : 26	GRILLE : 5

PLA-ZM35EA2(-ET/ER).UK

NOTCH	SPL(dB)	LINE
High	31	○—○
Medium1	29	●—●
Medium2	28	△—△
Low	26	▲—▲

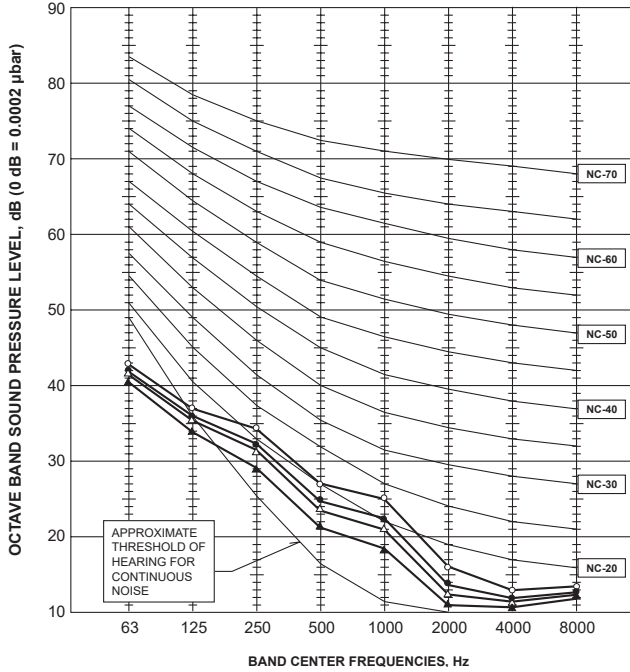

PLA-ZM50EA2(-ET/ER).UK

NOTCH	SPL(dB)	LINE
High	32	○—○
Medium1	31	●—●
Medium2	29	△—△
Low	27	▲—▲

PLA-ZM60EA2(-ET/ER).UK

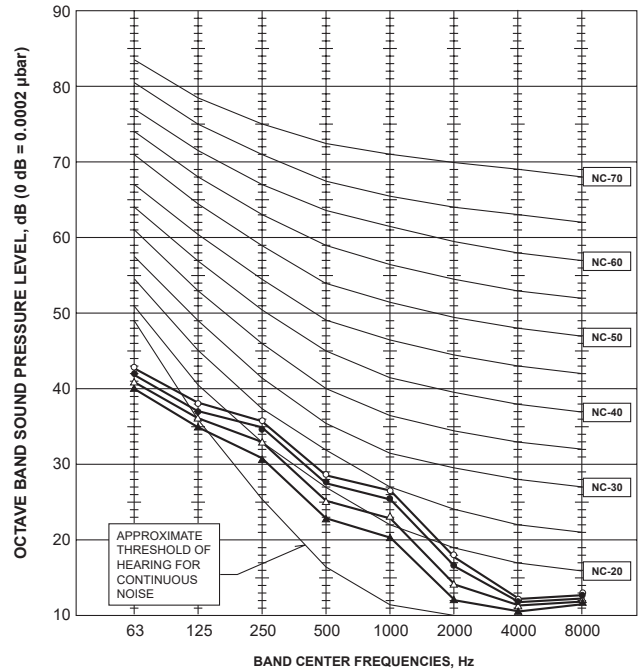

PLA-ZM71EA2(-ET/ER).UK

NOTCH	SPL(dB)	LINE
High	36	○—○
Medium1	33	●—●
Medium2	30	△—△
Low	28	▲—▲

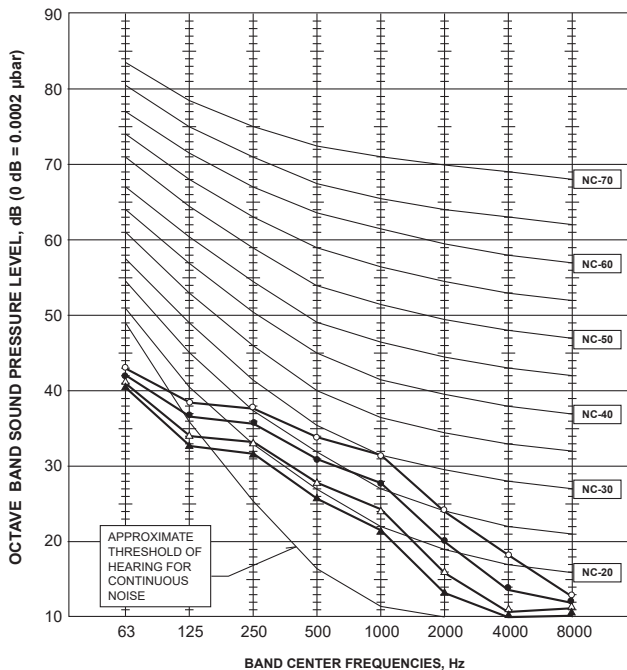

PLA-ZM100EA2(-ET/ER).UK

NOTCH	SPL(dB)	LINE
High	40	○—○
Medium1	37	●—●
Medium2	34	△—△
Low	31	▲—▲

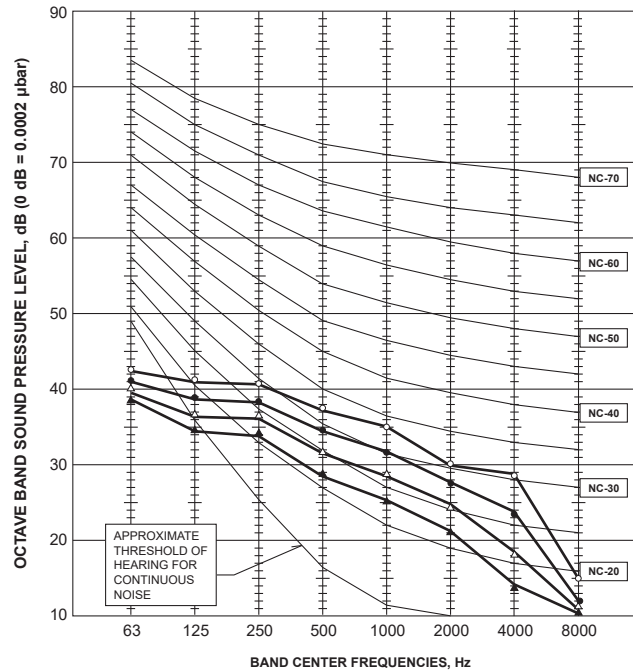

PLA-ZM125EA2(-ET/ER).UK

NOTCH	SPL(dB)	LINE
High	41	○—○
Medium1	39	●—●
Medium2	36	△—△
Low	33	▲—▲

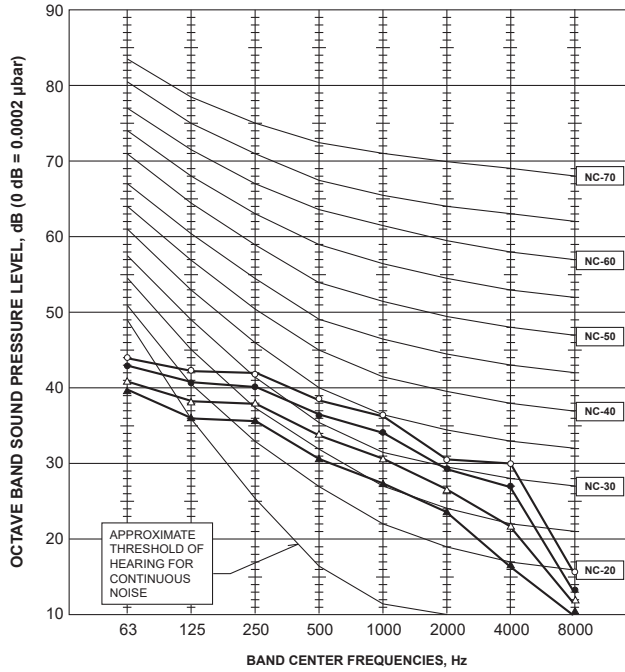

PLA-ZM140EA2(-ET/ER).UK

NOTCH	SPL(dB)	LINE
High	44	○—○
Medium1	42	●—●
Medium2	39	△—△
Low	36	▲—▲

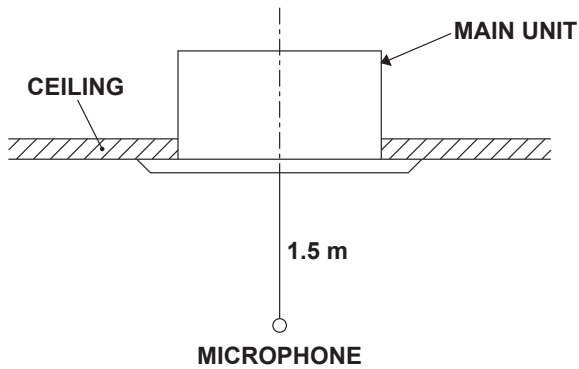
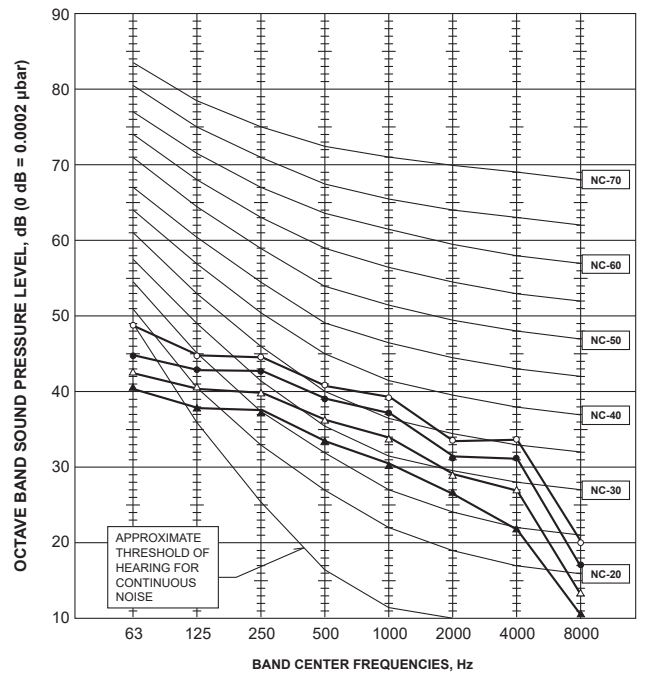

[LEGEND]

SYMBOL	NAME	SYMBOL	NAME
I.B	INDOOR CONTROLLER BOARD	TB4	TERMINAL BLOCK (INDOOR/OUTDOOR CONNECTING LINE)
CN2L	CONNECTOR (LOSSNAY)	TB5, TB6	TERMINAL BLOCK (REMOTE CONTROLLER TRANSMISSION LINE)
CN32	CONNECTOR (REMOTE SWITCH)	TH1	ROOM TEMP. THERMISTOR (0°C / 15kΩ, 25°C / 5.4kΩ DETECT)
CN41	CONNECTOR (HA TERMINAL-A)	TH2	PIPE TEMP. THERMISTOR/LIQUID (0°C / 15kΩ, 25°C / 5.4kΩ DETECT)
CN51	CONNECTOR (CENTRALLY CONTROL)	TH5	COND. / EVA. TEMP. THERMISTOR (0°C / 15kΩ, 25°C / 5.4kΩ DETECT)
CN105	CONNECTOR (IT TERMINAL)	R.B	WIRED REMOTE CONTROLLER
F1	FUSE (T6.3AL250V)	OPTION PART	
LED1	POWER SUPPLY (I.B)	W.B	PCB OF SIGNAL RECEIVER
LED2	POWER SUPPLY (R.B)	BZ	BUZZER
LED3	TRANSMISSION (INDOOR-OUTDOOR)	LED1	LED (OPERATION INDICATION : GREEN)
SW1	SWITCH (MODEL SELECTION) Refer to <Table 1>	LED2	LED (PREPARATION FOR HEATING : ORANGE)
SW2	SWITCH (CAPACITY CODE) Refer to <Table 2>	RU	RECEIVING UNIT
SWE	SWITCH (EMERGENCY OPERATION)	SW1	EMERGENCY OPERATION (HEAT / DOWN)
DP	DRAIN PUMP	SW2	EMERGENCY OPERATION (COOL / UP)
FS	DRAIN FLOAT SWITCH	MT	i-see Sensor MOTOR
MF	FAN MOTOR	TB2	TERMINAL BLOCK (INDOOR UNIT POWER AND TRANSMISSION LINE)
MV	VANE MOTOR		

<Table 1> SW1 (MODEL SELECTION)



<Table 2> SW2 (CAPACITY CODE)

CAPACITY	Manufacture/Service	CAPACITY	Manufacture/Service	CAPACITY	Manufacture/Service
35	1 2 3 4 5 ON OFF	71	1 2 3 4 5 ON OFF	140	1 2 3 4 5 ON OFF
50	1 2 3 4 5 ON OFF	100	1 2 3 4 5 ON OFF		
60	1 2 3 4 5 ON OFF	125	1 2 3 4 5 ON OFF		

The black square (■) indicates a switch position.

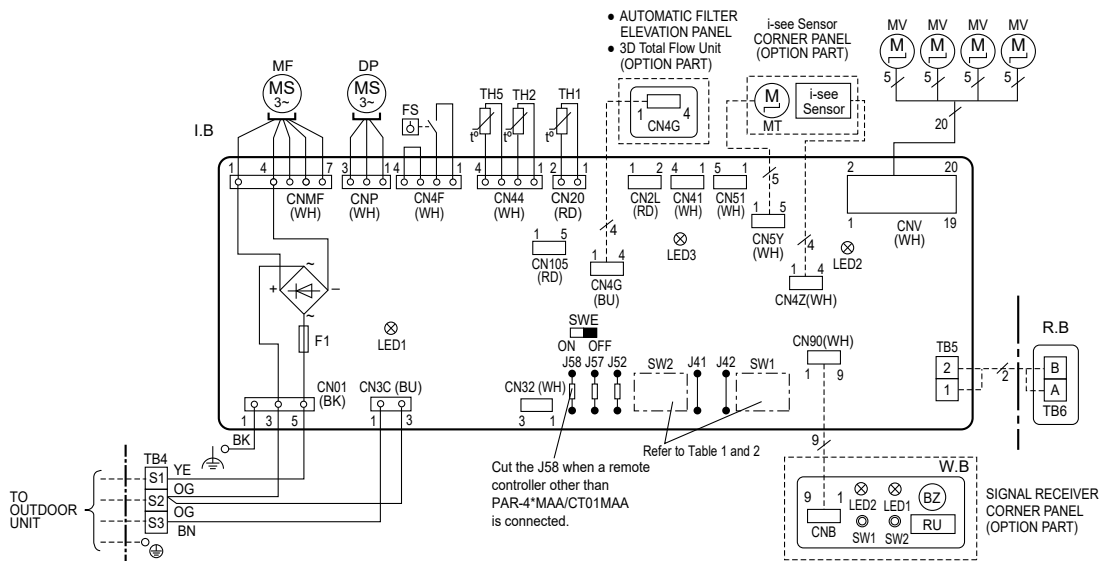

- Notes:
1. Symbols used in wiring diagram on the left are, □: Terminal (block), ○: Connector.
 2. Indoor and outdoor connecting wires are made with polarities, make wiring matching terminal numbers (S1, S2, S3).
 3. Since the outdoor side electric wiring may change be sure to check the outdoor unit electric wiring for servicing.
 4. This diagram shows the wiring of indoor and outdoor connecting wires (specification of 230V), adopting superimposed system of power and signal.
 - If the separate indoor/outdoor unit power supplied system is applied, refer to Fig 2.
 - For power supply system of this unit, refer to the caution label located near this diagram.
 5. When installing the automatic filter elevation panel and the 3D Total Flow Unit together, refer to the wiring diagram of the 3D Total Flow Unit.

<Fig. 2>

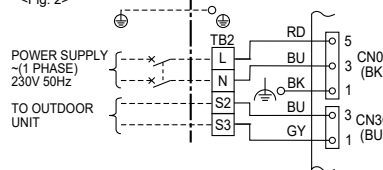

<Fig. 1> Caution when connecting the remote controller cable to the terminal block TB5

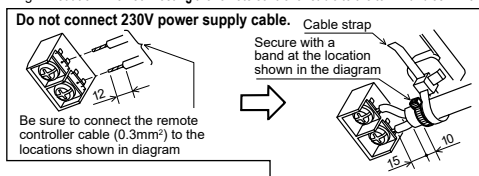

[Self-diagnosis]

1. For details on how to operate self-diagnosis with the wireless remote controller, refer to the technical manuals etc.

Check code	Symptom	Check code	Symptom
P1	Abnormality of room temperature thermistor (TH1).	PB(Pb)	Indoor unit fan motor error.
P2	Abnormality of pipe temperature thermistor / Liquid (TH2).	PL	Refrigerant circuit abnormal.
P4	Float switch connector open (FS).	E0-E5	Abnormality of the signal transmission between remote controller and indoor unit.
P5	Malfunction of Drain pump.	E6-EF	Abnormality of the signal transmission between indoor unit and outdoor unit.
P6	Freezing / overheating protection is working.	FB(Fb)	Abnormality of indoor controller board.
P8	Abnormality of pipe temperature.	U*, F*	Abnormality in outdoor unit. Refer to outdoor unit wiring diagram.
P9	Abnormality of pipe temperature thermistor / Cond. /Eva. (TH5).		
PA	Leakage error (refrigerant system)		

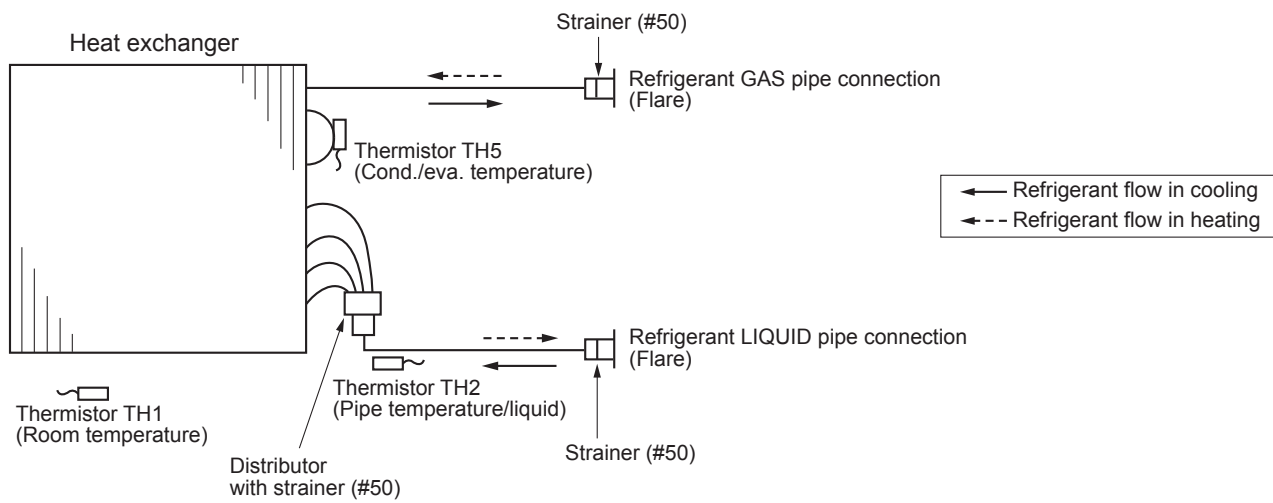

9-1. TROUBLESHOOTING

<Check code displayed by self-diagnosis and actions to be taken for service (summary)>

Present and past check codes are logged, and they can be displayed on the wired remote controller or controller board of outdoor unit. Actions to be taken for service, which depends on whether or not the trouble is reoccurring in the field, are summarized in the table below. Check the contents below before investigating details.

Unit conditions at service	Check code	Actions to be taken for service (summary)
The trouble is reoccurring.	Displayed	Judge what is wrong and take a corrective action according to "9-3. SELF-DIAGNOSIS ACTION TABLE".
	Not displayed	Conduct troubleshooting and ascertain the cause of the trouble according to "9-4. TROUBLESHOOTING OF PROBLEMS".
The trouble is not reoccurring.	Logged	<ul style="list-style-type: none"> ① Consider the temporary defects such as the work of protection devices in the refrigerant circuit including compressor, poor connection of wiring, noise, etc. Re-check the symptom, and check the installation environment, refrigerant amount, weather when the trouble occurred, matters related to wiring, etc. ② Reset check code logs and restart the unit after finishing service. ③ There is no abnormality in electrical component, controller board, remote controller, etc.
	Not logged	<ul style="list-style-type: none"> ① Re-check the abnormal symptom. ② Conduct troubleshooting and ascertain the cause of the trouble according to "9-4. TROUBLESHOOTING OF PROBLEMS". ③ Continue to operate unit for the time being if the cause is not ascertained. ④ There is no abnormality concerning of parts such as electrical component, controller board, remote controller, etc.

9-2. MALFUNCTION-DIAGNOSIS METHOD BY REMOTE CONTROLLER

Refer to "13-8. SELF-DIAGNOSIS" to search for the error history.

Refer to the following tables for details on the check codes.

[Output pattern A]

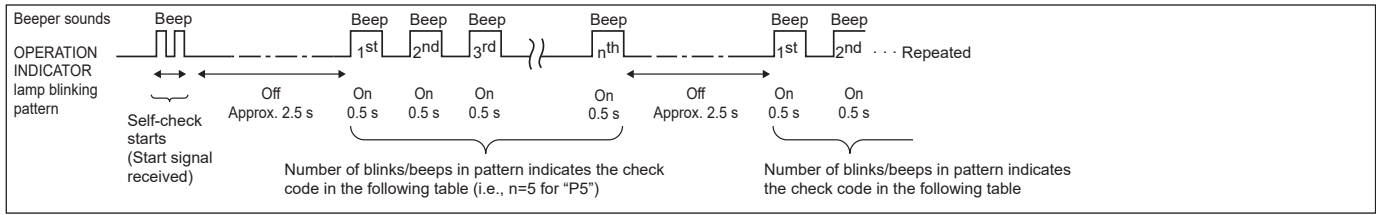

[Output pattern B]

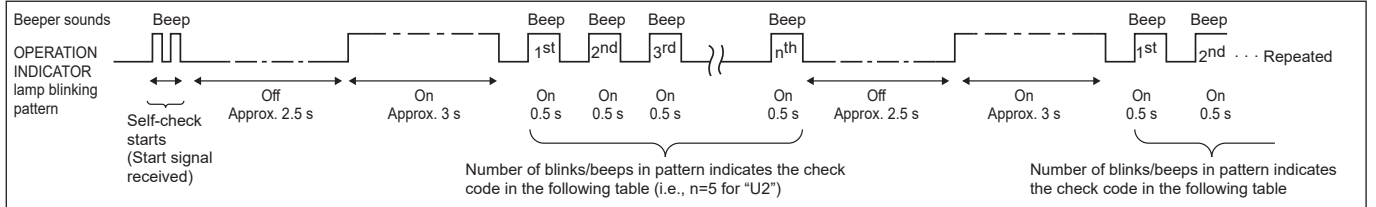

[Output pattern A] Errors detected by indoor unit

Wireless remote controller	Wired remote controller	Symptom	Remark
Beeper sounds/OPERATION INDICATOR lamp blinks (Number of times)	Check code		
1	P1	Intake sensor error	
2	P2	Pipe (TH2) sensor error	
	P9	Pipe (TH5) sensor error	
3	E6, E7	Indoor/outdoor unit communication error	
4	P4	Drain sensor error / Float switch connector open	
5	P5	Drain overflow protection operation	
	PA	Forced compressor error (due to water leakage abnormality)	
6	P6	Freeze (during cooling operation)/Overheat protection operation (during heating operation)	
7	EE	Combination error between indoor and outdoor unit	
8	P8	Pipe temperature error	
9	E4, E5	Communication error between wired remote controller and indoor unit	
10	—	—	
11	Pb	Indoor unit fan motor error	
12	Fb	Indoor unit control system error (memory error, etc.)	
14	PL	Refrigerant circuit abnormal	
—	E0,E3	Remote controller transmission error	
—	E1,E2	Remote controller control board error	

[Output pattern B] Errors detected by unit other than indoor unit (outdoor unit, etc.)

Note: The supported check codes may vary depending on the connected outdoor unit.

Wireless remote controller	Wired remote controller	Symptom	Remark
Beeper sounds/OPERATION INDICATOR lamp blinks (Number of times)	Check code		
1	E9	Indoor/outdoor unit communication error	For details, check the LED display of the outdoor controller board.
2	UP	Compressor overcurrent interruption	
3	U3, U4	Open/short of outdoor unit thermistors	
4	UF	Compressor overcurrent interruption (When compressor locked)	
5	U2	Abnormal high discharging temperature/49C worked/insufficient refrigerant	
6	U1, Ud	Abnormal high pressure (63H worked)/Overheat protection operation	
7	U5	Abnormal temperature of heat sink	
8	U8	Outdoor unit fan protection stop	
9	U6	Compressor overcurrent interruption/Abnormal of power module	
10	U7	Abnormality of super heat due to low discharge temperature	
11	U9, UH	Abnormality such as overvoltage or voltage shortage and abnormal synchronous signal to main circuit/Current sensor error	
12	—	—	
13	—	—	
14	Others	Other errors (Refer to the technical manual for the outdoor unit.)	

Notes:

- If the beeper does not sound again after the initial 2 beeps to confirm the self-check start signal was received and the OPERATION INDICATOR lamp does not come on, there are no error records.
- If the beeper sounds 3 times continuously "beep, beep, beep (0.4 + 0.4 + 0.4 seconds)" after the initial 2 beeps to confirm the self-check start signal was received, the specified refrigerant address is incorrect.
 - On wireless remote controller
 - The continuous buzzer sounds from receiving section of indoor unit.
 - Blink of operation lamp
 - On wired remote controller
 - Check code displayed in the LCD.

- If the unit cannot be operated properly after the test run, refer to the following table to find out the cause.

Symptom		Cause
Wired remote controller		
Please Wait	For about 2 minutes after power-on	• For about 2 minutes after power-on, operation of the remote controller is not possible due to system startup. (Correct operation)
Please Wait → check code	Subsequent to about 2 minutes after power-on	• Connector for the outdoor unit's protection device is not connected. • Reverse or open phase wiring for the outdoor unit's power terminal block
No messages appear even when operation switch is turned ON (operation lamp does not light up).		• Incorrect wiring between indoor and outdoor units. (incorrect polarity of S1, S2, S3) • Remote controller wire short

On the wireless remote controller with condition above, following phenomena take place.

- No signals from the remote controller can be received.
- Operation lamp is blinking.
- The buzzer makes a short ping sound.

Note:

Operation is not possible for about 30 seconds after cancellation of function selection. (Correct operation)

For description of each LED (LED1, 2, 3) provided on the indoor controller, refer to the following table.

LED1 (power for microprocessor)	Indicates whether control power is supplied. Make sure that this LED is always lit.
LED2 (power for remote controller)	Indicates whether power is supplied to the remote controller. This LED lights only in the case of the indoor unit which is connected to the outdoor unit refrigerant address "0".
LED3 (communication between indoor and outdoor units)	Indicates state of communication between the indoor and outdoor units. Make sure that this LED is always blinking.

Note: Errors to be detected in outdoor unit, such as codes starting with F, U or E (excluding E0 to E7), are not covered in this document. Please refer to the outdoor unit's service manual for the details.

9-3. SELF-DIAGNOSIS ACTION TABLE

Check code	Abnormal point and detection method	Cause	Countermeasure										
P1	<p>Room temperature thermistor (TH1)</p> <p>① The unit is in 3-minute resume prevention mode if short/open of thermistor is detected. Abnormal if the unit does not reset normally after 3 minutes. (The unit returns to normal operation, if it has been reset normally.)</p> <p>② Constantly detected during cooling, drying, and heating operation. Short: -90°C or more Open: -40°C or less</p>	<p>① Defective thermistor characteristics</p> <p>② Contact failure of connector (CN20) on the indoor controller board (Insert failure)</p> <p>③ Breaking of wire or contact failure of thermistor wiring</p> <p>④ Defective indoor controller board</p>	<p>①-③ Check resistance value of thermistor.</p> <table border="1"> <tr><td>0°C</td><td>15.0 kΩ</td></tr> <tr><td>10°C</td><td>9.6 kΩ</td></tr> <tr><td>20°C</td><td>6.3 kΩ</td></tr> <tr><td>30°C</td><td>4.3 kΩ</td></tr> <tr><td>40°C</td><td>3.0 kΩ</td></tr> </table> <p>If you put force on (draw or bend) the lead wire while measuring resistance value of thermistor, breaking of wire or contact failure can be detected.</p> <p>② Check contact failure of connector (CN20) on the indoor controller board. Refer to "9-7. TEST POINT DIAGRAM". Turn the power on again and check restart after inserting connector again.</p> <p>④ Check room temperature display on remote controller. Replace indoor controller board if there is abnormal difference with actual room temperature.</p> <p>Turn the power off, and on again to operate after check.</p>	0°C	15.0 kΩ	10°C	9.6 kΩ	20°C	6.3 kΩ	30°C	4.3 kΩ	40°C	3.0 kΩ
0°C	15.0 kΩ												
10°C	9.6 kΩ												
20°C	6.3 kΩ												
30°C	4.3 kΩ												
40°C	3.0 kΩ												
P2	<p>Pipe temperature thermistor/Liquid (TH2)</p> <p>① The unit is in 3-minute resume prevention mode if short/open of thermistor is detected. Abnormal if the unit does not reset normally after 3 minutes. (The unit returns to normal operation, if it has been reset normally.)</p> <p>② Constantly detected during cooling, drying, and heating (except defrosting) operation Short: 90°C or more Open: -40°C or less</p>	<p>① Defective thermistor characteristics</p> <p>② Contact failure of connector (CN44) on the indoor controller board (Insert failure)</p> <p>③ Breaking of wire or contact failure of thermistor wiring</p> <p>④ Defective refrigerant circuit is causing thermistor temperature of 90°C or more or -40°C or less.</p> <p>⑤ Defective indoor controller board</p>	<p>①-③ Check resistance value of thermistor. For characteristics, refer to (P1).</p> <p>② Check contact failure of connector (CN44) on the indoor controller board. Refer to "9-7. TEST POINT DIAGRAM". Turn the power on and check restart after inserting connector again.</p> <p>④ Check pipe <liquid> temperature with remote controller in test run mode. If pipe <liquid> temperature is extremely low (in cooling mode) or high (in heating mode), refrigerant circuit may have defective.</p> <p>⑤ Check pipe <liquid> temperature with remote controller in test run mode. If there is extremely difference with actual pipe <liquid> temperature, replace indoor controller board.</p> <p>Turn the power off, and on again to operate after check.</p>										
P4	<p>Contact failure of drain float switch (CN4F)</p> <ul style="list-style-type: none"> Extract when the connector of drain float switch is disconnected. (③ and ④ of connector CN4F is not short-circuited.) Constantly detected during operation 	<p>① Contact failure of connector (Insert failure)</p> <p>② Defective indoor controller board</p>	<p>① Check contact failure of float switch connector. Turn the power on again and check after inserting connector again.</p> <p>② Operate with connector (CN4F) short-circuited. Replace indoor controller board if abnormality reappears.</p>										
P5	<p>Drain overflow protection operation</p> <p>① Suspensive abnormality, if drain float switch is detected to be underwater for 1 minute and 30 seconds continuously with drain pump on. Compressor and indoor fan will be turned off.</p> <p>② Drain pump is abnormal if the condition above is detected during suspensive abnormality.</p> <p>③ Constantly detected during drain pump operation</p>	<p>① Malfunction of drain pump</p> <p>② Defective drain Clogged drain pump Clogged drain pipe</p> <p>③ Defective drain float switch Jamming of the drain float switch or malfunction of moving parts causing the drain float switch to be detected under water (Switch On)</p> <p>④ Defective indoor-controller board</p>	<p>① Check if drain pump works.</p> <p>② Check drain function.</p> <p>③ Remove drain float switch connector CN4F and check if it is short (Switch On) with the moving part of float switch UP, or OPEN with the moving part of float switch down. Replace float switch if it is short with the moving part of float switch down.</p> <p>④ Replace indoor controller board if it is short-circuited between ③-④ of the drain float switch connector CN4F and abnormality reappears.</p> <p>It is not abnormal if there is no problem about the above-mentioned ①-④. Turn the power off, and on again to operate after check.</p>										



Check code	Abnormal point and detection method	Cause	Countermeasure
P5	<p>Drain pump lock protection operation</p> <p>① Error postponement, if drain pump stops for 5 seconds continuously while drain pump is operating.</p> <p>② Drain pump is abnormal if above condition is repeated 4 times after error postponement is detected.</p>	<p>① Malfunction of drain pump</p> <p>② Clogged drain pump</p> <p>③ Contact failure of connector</p> <p>④ Defective indoor controller board</p>	<p>① Check if drain pump works.</p> <p>② Check if drain pump works.</p> <p>③ Check contact failure of connector CNP</p> <p>④ Press the indoor emergency switch (SWE) to check the voltage between CNP①-③.</p> <p>• If 13 V DC, replace the drain pump.</p> <p>• If not 13 V DC, replace the indoor controller board.</p>
P6	<p>Freeze/overheat protection is operating</p> <p>① Freeze protection (Cooling mode) The unit is in 6-minute resume prevention mode if pipe <liquid or condenser/evaporator> temperature stays under -15°C for 3 minutes, 3 minutes after the compressor started. Abnormal if it stays under -15°C for 3 minutes again within 16 minutes after 6-minute resume prevention mode.</p> <p>② Overheat protection (Heating mode) The unit is in 6-minute resume prevention mode if pipe <liquid or condenser/evaporator> temperature is detected as over 70°C after the compressor started. Abnormal if the temperature of over 70°C is detected again within 30 minutes after 6-minute resume prevention mode.</p>	<p>(Cooling or drying mode)</p> <p>① Clogged filter (reduced airflow)</p> <p>② Short cycle of air path</p> <p>③ Low-load (low temperature) operation out of the tolerance range</p> <p>④ Defective indoor fan motor</p> <ul style="list-style-type: none"> Fan motor is defective. Indoor controller board is defective. <p>⑤ Defective outdoor fan control</p> <p>⑥ Overcharge of refrigerant</p> <p>⑦ Defective refrigerant circuit (clogs)</p> <p>(Heating mode)</p> <p>① Clogged filter (reduced airflow)</p> <p>② Short cycle of air path</p> <p>③ Overload (high temperature) operation out of the tolerance range</p> <p>④ Defective indoor fan motor</p> <ul style="list-style-type: none"> Fan motor is defective. Indoor controller board is defective. <p>⑤ Defective outdoor fan control</p> <p>⑥ Overcharge of refrigerant</p> <p>⑦ Defective refrigerant circuit (clogs)</p> <p>⑧ Bypass circuit of outdoor unit is defective.</p>	<p>(Cooling or drying mode)</p> <p>① Check clogs of the filter.</p> <p>② Remove blockage.</p> <p>④ Refer to "9-6. HOW TO CHECK THE PARTS".</p> <p>⑤ Check outdoor fan motor.</p> <p>⑥⑦ Check operating condition of refrigerant circuit.</p> <p>(Heating mode)</p> <p>① Check clogs of the filter.</p> <p>② Remove blockage.</p> <p>④ Refer to "9-6. HOW TO CHECK THE PARTS".</p> <p>⑤ Check outdoor fan motor.</p> <p>⑥-⑧ Check operating condition of refrigerant circuit.</p>
P8	<p>Pipe temperature</p> <p><Cooling mode> Detected as abnormal when the pipe temperature is not in the cooling range 3 minutes after compressor start and 6 minutes after the liquid or condenser/evaporator pipe is out of cooling range. Note 1: It takes at least 9 minutes to detect. Note 2: Abnormality P8 is not detected in drying mode. Cooling range: $-3^{\circ}\text{C} \geq (\text{TH}-\text{TH1})$ TH: Lower temperature between liquid pipe temperature (TH2) and condenser/evaporator temperature (TH5) TH1: Intake temperature</p> <p><Heating mode> When 10 seconds have passed after the compressor starts operation and the hot adjustment mode has finished, the unit is detected as abnormal when condenser/evaporator pipe temperature is not in heating range within 20 minutes.</p> <p>Note 3: It takes at least 27 minutes to detect abnormality. Note 4: It excludes the period of defrosting. (Detection restarts when defrosting mode is over.) Heating range: $3^{\circ}\text{C} \leq (\text{TH5}-\text{TH1})$</p>	<p>① Slight temperature difference between indoor room temperature and pipe <liquid or condenser/evaporator> temperature thermistor</p> <ul style="list-style-type: none"> Shortage of refrigerant Disconnected holder of pipe <liquid or condenser/evaporator> thermistor Defective refrigerant circuit <p>② Converse connection of extension pipe (on plural units connection)</p> <p>③ Converse wiring of indoor/outdoor unit connecting wire (on plural units connection)</p> <p>④ Defective detection of indoor room temperature and pipe <condenser/evaporator> temperature thermistor</p> <p>⑤ Stop valve is not opened completely.</p>	<p>①-④ Check pipe <liquid or condenser/evaporator> temperature with room temperature display on remote controller and outdoor controller circuit board. Pipe <liquid or condenser/evaporator> temperature display is indicated by setting SW2 of outdoor controller circuit board as follows.</p> <p>(Conduct temperature check with outdoor controller circuit board after connecting 'A-Control Service Tool (PAC-SK52ST)').</p> <p>②③ Check converse connection of extension pipe or converse wiring of indoor/outdoor unit connecting wire.</p>



Check code	Abnormal point and detection method	Cause	Countermeasure
P9	<p>Pipe temperature thermistor/ Condenser-Evaporator (TH5)</p> <p>① The unit is in 3-minute resume protection mode if short/open of thermistor is detected. Abnormal if the unit does not get back to normal within 3 minutes. (The unit returns to normal operation, if it has been reset normally.)</p> <p>② Constantly detected during cooling, drying, and heating operation (except defrosting) Short: 90°C or more Open: -40°C or less</p>	<p>① Defective thermistor characteristics</p> <p>② Contact failure of connector (CN44) on the indoor controller board (Insert failure)</p> <p>③ Breaking of wire or contact failure of thermistor wiring</p> <p>④ Temperature of thermistor is 90°C or more, or -40°C or less caused by defective refrigerant circuit.</p> <p>⑤ Defective indoor controller board</p>	<p>①-③ Check resistance value of thermistor. For characteristics, refer to (P1).</p> <p>② Check contact failure of connector (CN44) on the indoor controller board. Refer to "9-7. TEST POINT DIAGRAM". Turn the power on and check restart after inserting connector again.</p> <p>④ Operate in test run mode and check pipe <condenser/evaporator> temperature with outdoor controller circuit board. If pipe <condenser/evaporator> temperature is extremely low (in cooling mode) or high (in heating mode), refrigerant circuit may have defect.</p> <p>⑤ Operate in test run mode and check pipe <condenser/evaporator> temperature with outdoor control circuit board. If there is extreme difference with actual pipe <condenser / evaporator> temperature, replace indoor controller board. There is no abnormality if none of above comes within the unit. Turn the power off, and on again to operate.</p> <p style="text-align: center;">(In case of checking pipe temperature with outdoor controller circuit board, be sure to connect A-control service tool (PAC-SK52ST).)</p>
E0 or E4	<p>Remote controller transmission error(E0)/signal receiving error(E4)</p> <p>① Abnormal if main or sub remote controller cannot receive any transmission normally from indoor unit of refrigerant address "0" for 3 minutes. (Check code : E0)</p> <p>② Abnormal if sub remote controller could not receive any signal for 2 minutes. (Check code: E0)</p> <p>① Abnormal if indoor controller board can not receive any data normally from remote controller board or from other indoor controller board for 3 minutes. (Check code: E4)</p> <p>② Indoor controller board cannot receive any signal from remote controller for 2 minutes. (Check code: E4)</p>	<p>① Contact failure at transmission wire of remote controller</p> <p>② All remote controllers are set as "sub" remote controller. In this case, E0 is displayed on remote controller, and E4 is displayed at LED (LED1, LED2) on the outdoor controller circuit board.</p> <p>③ Miswiring of remote controller</p> <p>④ Defective transmitting receiving circuit of remote controller</p> <p>⑤ Defective transmitting receiving circuit of indoor controller board of refrigerant addresses "0".</p> <p>⑥ Noise has entered into the transmission wire of remote controller.</p>	<p>① Check disconnection or looseness of indoor unit or transmission wire of remote controller.</p> <p>② Set one of the remote controllers "main" if there is no problem with the action above.</p> <p>③ Check wiring of remote controller.</p> <ul style="list-style-type: none"> • The number of connecting indoor units: max. 16 units • The number of connecting remote controller: max. 2 units • Total wiring length: <ul style="list-style-type: none"> When one remote controller is connected: max. 500 m When two remote controllers are connected: 200m (Do not use a multicore cable.) <p>If the cause of trouble is not any of ①-③ above,</p> <p>④ Diagnose remote controllers.</p> <p>a) When "OK" is displayed, Remote controllers have no problem. Turn the power off, and on again to check. If abnormality generates again, replace indoor controller board.</p> <p>b) When "NG" is displayed, Replace remote controller.</p> <p>c) When "E3" or "ERC" is displayed, noise may be causing abnormality.</p> <p>Note: If the unit is not normal after replacing indoor controller board in group control, indoor controller board of address "0" may be abnormal.</p>
E3 or E5	<p>Remote controller transmission error(E3)/signal receiving error(E5)</p> <p>① Abnormal if remote controller could not find blank of transmission path for 6 seconds and could not transmit. (Check code: E3)</p> <p>② Remote controller receives transmitted data at the same time and compares the received and transmitted data. Abnormal if these data are judged to be different 30 continuous times. (Check code: E3)</p> <p>① Abnormal if indoor controller board could not find blank of transmission path. (Check code: E5)</p> <p>② Indoor controller board receives transmitted data at the same time and compares the received and transmitted data. Abnormal if these data are judged to be different 30 continuous times. (Check code: E5)</p>	<p>① 2 remote controllers are set as "main." (In case of 2 remote controllers)</p> <p>② Remote controller is connected with 2 indoor units or more.</p> <p>③ Repetition of refrigerant address</p> <p>④ Defective transmitting receiving circuit of remote controller</p> <p>⑤ Defective transmitting receiving circuit of indoor controller board</p> <p>⑥ Noise has entered into transmission wire of remote controller.</p>	<p>① Set a remote controller to main, and the other to sub.</p> <p>② Remote controller is connected with only one indoor unit.</p> <p>③ The address changes to a separate setting.</p> <p>④-⑥ Diagnose remote controller.</p> <p>a) When "OK" is displayed, remote controllers have no problem. Turn the power off, and on again to check. When becoming abnormal again, replace indoor controller board.</p> <p>b) When "NG" is displayed, replace remote controller.</p> <p>c) When "E3" or "ERC" is displayed, noise may be causing abnormality.</p>

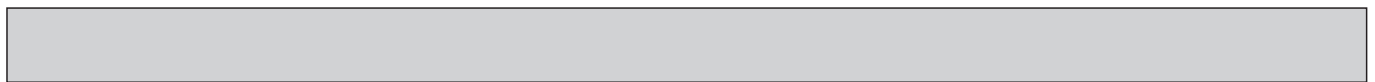

Check code	Abnormal point and detection method	Cause	Countermeasure
E6	<p>Indoor/outdoor unit communication error (Signal receiving error)</p> <p>① Abnormal if indoor controller board cannot receive any signal normally for 6 minutes after turning the power on.</p> <p>② Abnormal if indoor controller board cannot receive any signal normally for 3 minutes.</p> <p>③ Consider the unit abnormal under the following condition: When 2 or more indoor units are connected to an outdoor unit, indoor controller board cannot receive a signal for 3 minutes from outdoor controller circuit board, a signal which allows outdoor controller circuit board to transmit signals.</p>	<p>① Contact failure, short circuit or, miswiring (converse wiring) of indoor/outdoor unit connecting wire</p> <p>② Defective transmitting receiving circuit of indoor controller board</p> <p>③ Defective transmitting receiving circuit of indoor controller board</p> <p>④ Noise has entered into indoor/outdoor unit connecting wire.</p> <p>⑤ Malfunction of fan motor</p>	<p>Note: Check LED display on the outdoor control circuit board. (Connect A-control service tool, PAC-SK52ST.) Refer to outdoor unit service manual.</p> <p>① Check disconnection or looseness of indoor/outdoor unit connecting wire of indoor unit or outdoor unit. Check all the units in case of twin or triple indoor unit system.</p> <p>②-④ Turn the power off, and on again to check. If abnormality generates again, replace indoor controller board or outdoor controller circuit board.</p> <p>⑤ Turn the power off, and on again after removing the fan motor connectors (CNF1,2) from outdoor controller board.</p> <ul style="list-style-type: none"> • If normal, replace fan motor. • If abnormal generates again, replace outdoor controller board. <p>Note: Other indoor controller board may have defect in the case of twin triple indoor unit system.</p>
E7	<p>Indoor/outdoor unit communication error (Transmitting error)</p> <p>Abnormal if "1" receiving is detected 30 times continuously though indoor controller board has transmitted "0".</p>	<p>① Defective transmitting receiving circuit of indoor controller board</p> <p>② Noise has entered into power supply.</p> <p>③ Noise has entered into outdoor control wire.</p>	<p>①-③ Turn the power off, and on again to check. If abnormality generates again, replace indoor controller board.</p>
Fb	<p>Indoor controller board</p> <p>Abnormal if data cannot be read normally from the nonvolatile memory of the indoor controller board.</p>	<p>① Defective indoor controller board</p>	<p>① Replace indoor controller board.</p>
E1 or E2	<p>Remote controller control board</p> <p>① Abnormal if data cannot be read normally from the nonvolatile memory of the remote controller control board. (Check code: E1)</p> <p>② Abnormal if the clock function of remote controller cannot be operated normally. (Check code: E2)</p>	<p>① Defective remote controller</p>	<p>① Replace remote controller.</p>
PA	<p>Forced compressor stop (due to water leakage abnormality)</p> <p>① The unit has a water leakage abnormality when the following conditions, a) and b), are satisfied while the above-mentioned detection is performed.</p> <p>a) The intake temperature subtracted with liquid pipe temperature detects to be less than -10°C for a total of 30 minutes. (When the drain sensor is detected to be NOT soaked in the water, the detection record of a) and b) will be cleared.)</p> <p>b) Drain float switch detects to be in the water for more than 15 minutes.</p> <p>Note: Once the water leakage abnormality is detected, abnormality state will not be released until the main power is reset.</p>	<p>① Drain pump trouble</p> <p>② Drain defective</p> <ul style="list-style-type: none"> • Drain pump clogging • Drain pipe clogging <p>③ Open circuit of float switch</p> <p>④ Contact failure of float switch connector</p> <p>⑤ Dew condensation on float switch</p> <ul style="list-style-type: none"> • Drain water trickles down lead wire. • Drain water ripples due to filter clogging. <p>⑥ Extension piping connection difference at twin, triple or quadruple system</p> <p>⑦ Miswiring of indoor/ outdoor connecting at twin, triple or quadruple system</p> <p>⑧ Room temperature thermistor/ liquid pipe temperature thermistor detection is defective.</p>	<p>① Check the drain pump.</p> <p>② Check whether water can be drained.</p> <p>③ Check the resistance of the float switch.</p> <p>④ Check the connector contact failure.</p> <p>⑤ Check the float switch leadwire mounted. Check the filter clogging.</p> <p>⑥ Check the piping connection.</p> <p>⑦ Check the indoor/outdoor connecting wires.</p> <p>⑧ Check the room temperature display of remote controller. Check the indoor liquid pipe temperature display of outdoor controller board.</p>



Check code	Abnormal point and detection method	Cause	Countermeasure
Pb	Fan motor trouble	① Defective fan motor ② Defective indoor controller board	①② Refer to "9-6-2. DC Fan Motor (fan motor/ indoor controller board)".
PL	Abnormal refrigerant circuit During Cooling, Dry, or Auto Cooling operation, the following conditions are regarded as failures when detected for 1 second. a)The compressor continues to run for 30 or more seconds. b)The liquid pipe temperature or the condenser/evaporator temperature is 75°C or more. <u>These detected errors will not be cancelled until the power source is reset.</u>	① Abnormal operation of 4-way valve ② Disconnection of or leakage in refrigerant pipes ③ Air into refrigerant piping ④ Abnormal operation (no rotation) of indoor fan • Defective fan motor • Defective indoor control board. ⑤ Defective refrigerant circuit (clogging)	① <u>When this error occurs, be sure to replace the 4-way valve.</u> ② Check refrigerant pipes for disconnection or leakage. ③ After the recovery of refrigerant, vacuum dry the whole refrigerant circuit. ④ Refer to section "9-6-2. DC Fan motor (fan motor/indoor controller board)". ⑤ Check refrigerant circuit for operation. <u>To avoid entry of moisture or air into refrigerant circuit which could cause abnormal high pressure, purge air in refrigerant circuit or replace refrigerant.</u>

9-4. TROUBLESHOOTING OF PROBLEMS

Note: Refer to the outdoor unit's service manual for the detail of remote controller.

Phenomena	Cause	Countermeasure
(1) LED2 on indoor controller board is off.	<ul style="list-style-type: none"> • When LED1 on indoor controller board is also off. <p>① Power supply of rated voltage is not supplied to outdoor unit.</p> <p>② Defective outdoor controller circuit board</p> <p>③ Power supply of 220–240 V is not supplied to indoor unit.</p> <p>④ Defective indoor controller board</p>	<p>① Check the voltage of outdoor power supply terminal block (L, N) or (L₃, N).</p> <ul style="list-style-type: none"> • When 220–240 V AC is not detected, check the power wiring to outdoor unit and the breaker. • When 220–240 V AC is detected, check ② (below). <p>② Check the voltage between outdoor terminal block S1 and S2.</p> <ul style="list-style-type: none"> • When 220–240 V AC is not detected, —check the fuse on outdoor controller circuit board. —check the wiring connection. • When 220–240 V AC is detected, check ③ (below). <p>③ Check the voltage between indoor terminal block S1 and S2.</p> <ul style="list-style-type: none"> • When 220–240 V AC is not detected, check indoor/outdoor unit connecting wire for miswiring. • When 220–240 V AC is detected, check ④ (below). <p>④ Check the fuse on indoor controller board. Check the wiring connection. If no problem is found, indoor controller board is defective.</p>
	<p>(For the separate indoor/outdoor unit power supply system)</p> <p>① Power supply of 220–240 V AC is not supplied to indoor unit.</p> <p>② The connectors of the optional replacement kit are not used.</p> <p>③ Defective indoor controller board</p>	<p>① Check the voltage of indoor power supply terminal block (L,N).</p> <ul style="list-style-type: none"> • When 220–240 V AC is not detected, check the power supply wiring. • When 220–240 V AC is detected, check ② (below). <p>② Check that there is no problem in the method of connecting the connectors.</p> <ul style="list-style-type: none"> • When there are problems in the method of connecting the connectors, connect the connector correctly referring to installation manual of an optional kit. • When there is no problem in the method of connecting the connectors, check ③ (below). <p>③ Check the fuse on indoor controller board. Check the wiring connection. If no problem is found, indoor controller board is defective.</p>
	<ul style="list-style-type: none"> • When LED1 on indoor controller board is lit. <p>① Mis-setting of refrigerant address for outdoor unit (There is no unit corresponding to refrigerant address "0".)</p>	<p>① Check again the setting of refrigerant address for outdoor unit. Set the refrigerant address to "0". (For grouping control system under which 2 or more outdoor units are connected, set one of the units to "0".) Set refrigerant address using SW1 (3-6) on outdoor controller circuit board.</p>

Note: Refer to the outdoor unit's service manual for the detail of remote controller.

Phenomena	Cause	Countermeasure
(2) LED2 on indoor controller board is blinking.	<ul style="list-style-type: none"> • When LED1 on indoor controller board is also blinking. Connection failure of indoor/outdoor unit connecting wire • When LED1 is lit. ① Miswiring of remote controller wires Under twin triple indoor unit system, 2 or more indoor units are wired together. ② Refrigerant address for outdoor unit is wrong or not set. Under grouping control system, there are some units whose refrigerant addresses are 0. ③ Short-circuit of remote controller wires ④ Defective remote controller 	<p>Check indoor/outdoor unit connecting wire for connection failure.</p> <ul style="list-style-type: none"> ① Check the connection of remote controller wires in case of twin triple indoor unit system. When 2 or more indoor units are wired in one refrigerant system, connect remote controller wires to one of those units. ② Check the setting of refrigerant address in case of grouping control system. If there are some units whose refrigerant addresses are 0 in one group, set one of the units to 0 using SW1 (3-6) on outdoor controller circuit board. ③④ Remove remote controller wires and check LED2 on indoor controller board. <ul style="list-style-type: none"> • When LED2 is blinking, check the short-circuit of remote controller wires. • When LED2 is lit, connect remote controller wires again and: if LED2 is blinking, remote controller is defective; if LED2 is lit, connection failure of remote controller terminal block, etc. has returned to normal.
(3) Upward/downward vane performance failure	<ul style="list-style-type: none"> ① The vane is not downward during defrosting and heat preparation and when the thermostat is OFF in HEAT mode. (Working of COOL protection function) ② Vane motor does not rotate. <ul style="list-style-type: none"> • Defective vane motor • Breaking of wire or connection failure of connector ③ Upward/downward vane does not work. <ul style="list-style-type: none"> • The vane is set to fixed position. 	<ul style="list-style-type: none"> ① Normal operation (The vane is set to horizontal regardless of remote control.) ② Check ② (left). <ul style="list-style-type: none"> • Check the vane motor. (Refer to "9-6. HOW TO CHECK THE PARTS".) • Check for breaking of wire or connection failure of connector. ③ Normal operation (Each connector on vane motor side is disconnected or setting the fixed vanes by wired remote controller.)
(4) Receiver for wireless remote controller	<ul style="list-style-type: none"> ① Weak batteries of wireless remote controller. ② Contact failure of connector (CNB) on wireless remote controller board (Insert failure) ③ Contact failure of connector (CN90) on indoor controller board (Insert failure) ④ Contact failure of connector between wireless remote controller board and indoor controller board 	<ul style="list-style-type: none"> ① Replace batteries of wireless remote controller. ②-④ Check contact failure of each connector. If no problems are found on connector, replace indoor controller board. When the same trouble occurs even if indoor controller board is replaced, replace wireless remote controller board.

9-5. EMERGENCY OPERATION

9-5-1. When wireless remote controller fails or its battery is exhausted

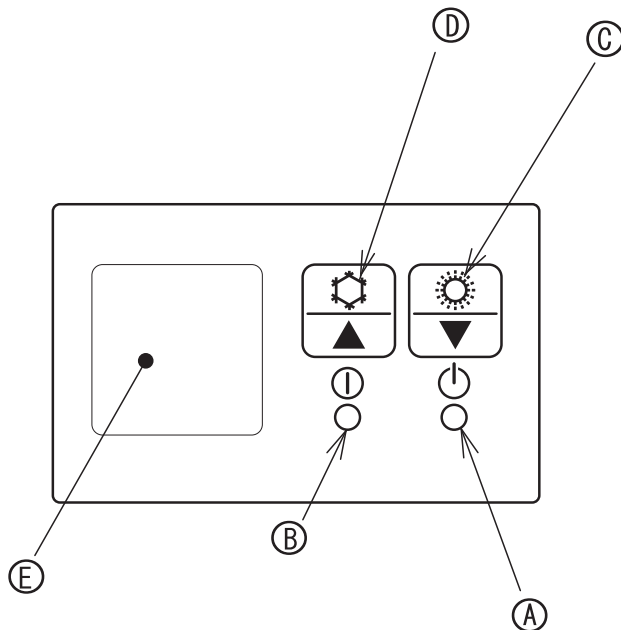

When the remote controller cannot be used

When the batteries of the remote controller run out or the remote controller malfunctions, the emergency operation can be done using the emergency buttons on the grille.

- Ⓐ DEFROST/STAND BY lamp
- Ⓑ Operation lamp
- Ⓒ Emergency operation switch (heating)
- Ⓓ Emergency operation switch (cooling)
- Ⓔ Receiver

Starting operation

- To operate the cooling mode, press the ❄️ button Ⓓ for more than 2 seconds.
- To operate the heating mode, press the ☀️ button Ⓒ for more than 2 seconds.

Note: Lighting of the Operation lamp Ⓑ means the start of operation.

Details of EMERGENCY MODE are as shown below.

Operation mode	COOL	HEAT
Set temperature	24°C	24°C
Fan speed	High	High
Airflow direction	Horizontal	Downward 5

Stopping operation

- To stop operation, press the ❄️ button Ⓓ or the ☀️ button Ⓒ.

9-5-2. When wired remote controller fails

[Emergency operation procedure]

1. When the wired remote controller has failed, but all other components work properly, set the switch (SWE) on the indoor controller board ON, the indoor unit will begin emergency operation.

When emergency operation is activated, the indoor unit operates as follows:

- (1) Indoor fan is running at high speed.
- (2) Drain pump is working.

- Note on the wireless remote controller: When the remote controller does not function, it is possible to activate emergency operation by using the indoor unit emergency operation switch (SW1, SW2 of the wireless signal receiver board).

2. When you activate emergency operation of the cooling or heating, you have to set the switch(SWE) on the indoor controller board and activate emergency operation of the outdoor unit.
For details on how to activate emergency operation of the outdoor unit, refer to the outdoor unit wiring diagram.

3. Before you activate emergency operation, check the following points:

- (1) Emergency operation cannot be activated when:

- The outdoor unit malfunctions.
- The indoor fan malfunctions.
- When it has detected the malfunction of drain pump during self-diagnosing.

- (2) Emergency operation becomes continuous only by switching the power source on/off.
ON/OFF on the remote controller or temperature control, etc. does not function.

- (3) Avoid operating for a long time when the outdoor unit begins defrosting while emergency operation of the heating is activated, because it will start to blow cold air.

- (4) Emergency cooling should be limited to 10 hours maximum (The indoor unit heat exchanger may freeze).

- (5) After emergency operation has been deactivated, set the switches etc. to their original positions.

- (6) Movement of the vanes does not work in emergency operation, therefore you have to slowly set them manually to the appropriate positions.

9-6. HOW TO CHECK THE PARTS

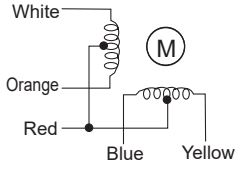
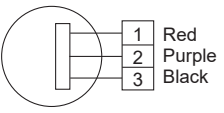
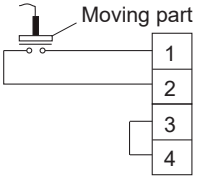
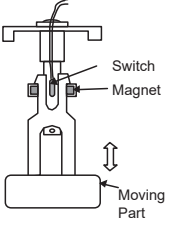
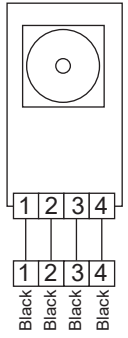
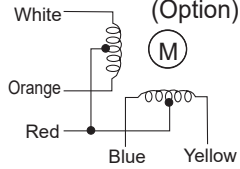
Parts name	Check method and criterion														
Room temperature thermistor (TH1)	Measure the resistance with a multimeter. (Parts temperature 10 to 30°C)														
Pipe temperature thermistor/liquid (TH2)	<table border="1"> <thead> <tr> <th>Normal</th> <th>Abnormal</th> </tr> </thead> <tbody> <tr> <td>4.3 to 9.6 kΩ</td> <td>Opened or short-circuited</td> </tr> </tbody> </table>	Normal	Abnormal	4.3 to 9.6 kΩ	Opened or short-circuited										
Normal	Abnormal														
4.3 to 9.6 kΩ	Opened or short-circuited														
Condenser/evaporator temperature thermistor (TH5)	Refer to "9-6-1 Thermistor".														
Vane motor (MV)	<p>Measure the resistance between the terminals with a multimeter. (At the ambient temperature 20 to 30°C)</p>  <table border="1"> <thead> <tr> <th>Connector</th> <th>Normal</th> <th>Abnormal</th> </tr> </thead> <tbody> <tr> <td>Red–Yellow (⑤–③, ⑩–⑧, ⑮–⑬, ⑳–⑱)</td> <td rowspan="4">300 Ω</td> <td rowspan="4">Open or short</td> </tr> <tr> <td>Red–Blue (⑤–①, ⑩–⑥, ⑮–⑪, ⑳–⑯)</td> </tr> <tr> <td>Red–Orange (⑤–④, ⑩–⑨, ⑮–⑭, ⑳–⑰)</td> </tr> <tr> <td>Red–White (⑤–②, ⑩–⑦, ⑮–⑫, ⑳–⑰)</td> </tr> </tbody> </table>	Connector	Normal	Abnormal	Red–Yellow (⑤–③, ⑩–⑧, ⑮–⑬, ⑳–⑱)	300 Ω	Open or short	Red–Blue (⑤–①, ⑩–⑥, ⑮–⑪, ⑳–⑯)	Red–Orange (⑤–④, ⑩–⑨, ⑮–⑭, ⑳–⑰)	Red–White (⑤–②, ⑩–⑦, ⑮–⑫, ⑳–⑰)					
Connector	Normal	Abnormal													
Red–Yellow (⑤–③, ⑩–⑧, ⑮–⑬, ⑳–⑱)	300 Ω	Open or short													
Red–Blue (⑤–①, ⑩–⑥, ⑮–⑪, ⑳–⑯)															
Red–Orange (⑤–④, ⑩–⑨, ⑮–⑭, ⑳–⑰)															
Red–White (⑤–②, ⑩–⑦, ⑮–⑫, ⑳–⑰)															
Drain pump (DP)	<p>① Check if the drain float switch works properly. ② Check if the drain pump works and drains water properly in cooling operation. ③ If no water drains, confirm that the check code P5 will not be displayed 10 minutes after the operation starts.</p> <p>Note: The drain pump for this model is driven by the internal DC motor of controller board, so it is not possible to measure the resistance between the terminals.</p> <p>Normal Red–Black: Input 13 V DC → The motor starts to rotate. Purple–Black: Abnormal (check code P5) if it outputs 0–13 V square wave (5 pulses/rotation), and the number of rotation is not normal.</p> 														
Drain float switch (FS)	<p>Measure the resistance between the terminals with a multimeter.</p>  <table border="1"> <thead> <tr> <th>State of moving part</th> <th>Normal</th> <th>Abnormal</th> </tr> </thead> <tbody> <tr> <td>UP</td> <td>Short</td> <td>Other than short</td> </tr> <tr> <td>DOWN</td> <td>Open</td> <td>Other than open</td> </tr> </tbody> </table> 	State of moving part	Normal	Abnormal	UP	Short	Other than short	DOWN	Open	Other than open					
State of moving part	Normal	Abnormal													
UP	Short	Other than short													
DOWN	Open	Other than open													
i-see Sensor (Option)	<p>Turn the power ON while the i-see Sensor connector is connected to the CN4Z on indoor controller board. A communication between the indoor controller board and i-see Sensor board is made to detect the connection.</p> <p>Normal: When the operation starts, the motor for i-see Sensor is driven to rotate the i-see Sensor. Abnormal: The motor for i-see Sensor is not driven when the operation starts.</p> <p>Note: The voltage between the terminals cannot be measured accurately since it is pulse output.</p> 														
i-see Sensor motor (Option)	<p>Measure the resistance between the terminals with a multimeter. (At the ambient temperature 20 to 30°C)</p>  <table border="1"> <thead> <tr> <th colspan="4">Normal</th> <th>Abnormal</th> </tr> </thead> <tbody> <tr> <td>Red–Yellow</td> <td>Red–Blue</td> <td>Red–Orange</td> <td>Red–White</td> <td rowspan="2">Open or short</td> </tr> <tr> <td colspan="4">250 Ω</td> </tr> </tbody> </table>	Normal				Abnormal	Red–Yellow	Red–Blue	Red–Orange	Red–White	Open or short	250 Ω			
Normal				Abnormal											
Red–Yellow	Red–Blue	Red–Orange	Red–White	Open or short											
250 Ω															

9-6-1. Thermistor

<Thermistor Characteristic Graph>

Thermistors for lower temperature

- Room temperature thermistor (TH1)
- Pipe temperature thermistor/liquid (TH2)
- Condenser/evaporator temperature thermistor (TH5)

R_t: Thermistor resistance
t: Temperature

Thermistor R₀=15kΩ ± 3%
Fixed number of B=3480 ± 1%

$$R_t = R_0 \exp \left\{ B \left(\frac{1}{273 + t} - \frac{1}{273} \right) \right\}$$

t	R _t
0°C	15 kΩ
10°C	9.6 kΩ
20°C	6.3 kΩ
25°C	5.4 kΩ
30°C	4.3 kΩ
40°C	3.0 kΩ

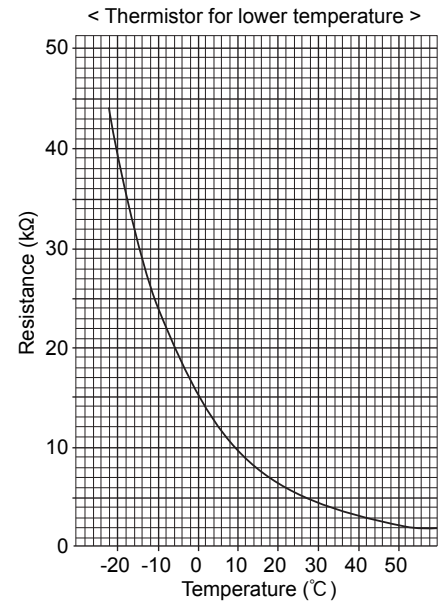

9-6-2. DC Fan motor (fan motor/indoor controller board)

Check method of DC fan motor (fan motor / indoor controller circuit board)

① Notes

- High voltage is applied to the connector (CNMF) for the fan motor. Pay attention to the service.
- Do not pull out the connector (CNMF) for the motor with the power supply on.
(It causes trouble of the indoor controller circuit board and fan motor.)

② Self check

Symptom : The indoor fan cannot turn around.

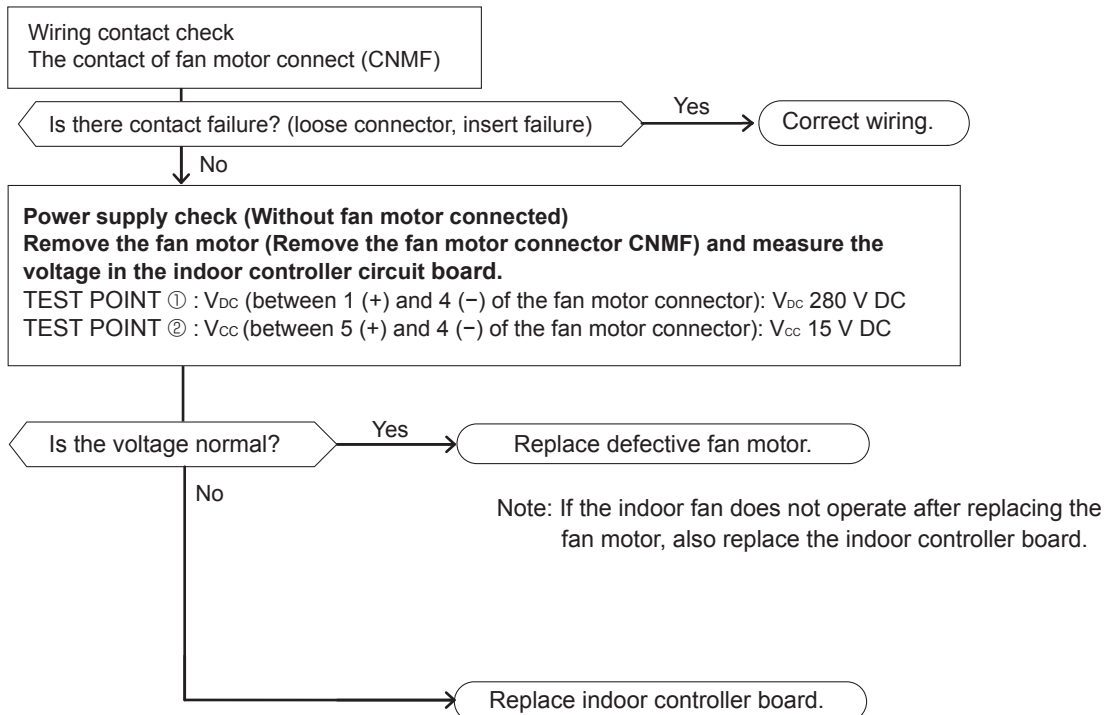

Note: If the indoor fan does not operate after replacing the fan motor, also replace the indoor controller board.

Note: If the indoor fan does not operate after replacing the indoor controller board, also replace the fan motor.

9-7. TEST POINT DIAGRAM

Indoor controller board

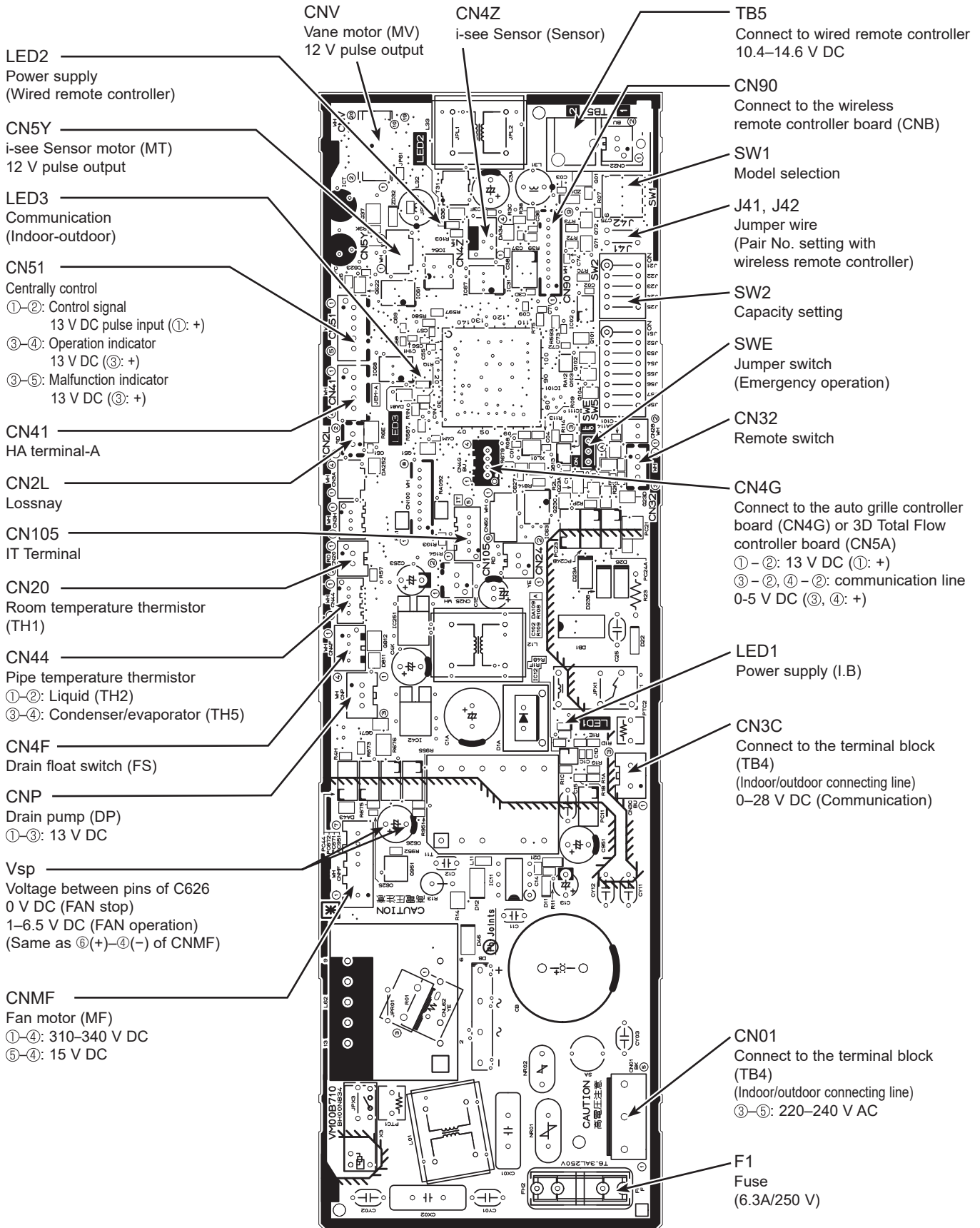

9-8. FUNCTIONS OF DIP SWITCH AND JUMPER WIRE

Each function is controlled by the DIP switch and the jumper wire on the indoor controller board.

The black square (■) indicates a switch position

Jumper wire	Functions	Setting by the DIP switch and jumper wire	Remarks																																																																																																				
SW1	Model settings	<table border="1"> <thead> <tr> <th>MODEL</th> <th>SETTING</th> </tr> </thead> <tbody> <tr> <td>PLA-ZM•EA</td> <td> <table border="1"> <tr> <td>1</td><td>2</td><td>3</td><td>4</td><td>5</td><td>6</td> <td>ON OFF</td> </tr> <tr> <td>■</td><td>■</td><td>■</td><td>■</td><td>■</td><td>■</td> <td></td> </tr> </table> </td> </tr> </tbody> </table>	MODEL	SETTING	PLA-ZM•EA	<table border="1"> <tr> <td>1</td><td>2</td><td>3</td><td>4</td><td>5</td><td>6</td> <td>ON OFF</td> </tr> <tr> <td>■</td><td>■</td><td>■</td><td>■</td><td>■</td><td>■</td> <td></td> </tr> </table>	1	2	3	4	5	6	ON OFF	■	■	■	■	■	■																																																																																				
MODEL	SETTING																																																																																																						
PLA-ZM•EA	<table border="1"> <tr> <td>1</td><td>2</td><td>3</td><td>4</td><td>5</td><td>6</td> <td>ON OFF</td> </tr> <tr> <td>■</td><td>■</td><td>■</td><td>■</td><td>■</td><td>■</td> <td></td> </tr> </table>	1	2	3	4	5	6	ON OFF	■	■	■	■	■	■																																																																																									
1	2	3	4	5	6	ON OFF																																																																																																	
■	■	■	■	■	■																																																																																																		
SW2	Capacity settings	<table border="1"> <thead> <tr> <th>MODELS</th> <th>SETTING</th> </tr> </thead> <tbody> <tr> <td>PLA-ZM35EA</td> <td> <table border="1"> <tr> <td>1</td><td>2</td><td>3</td><td>4</td><td>5</td> <td>ON OFF</td> </tr> <tr> <td>■</td><td>■</td><td>■</td><td>■</td><td>■</td> <td></td> </tr> </table> </td> </tr> <tr> <td>PLA-ZM50EA</td> <td> <table border="1"> <tr> <td>1</td><td>2</td><td>3</td><td>4</td><td>5</td> <td>ON OFF</td> </tr> <tr> <td>■</td><td>■</td><td>■</td><td>■</td><td>■</td> <td></td> </tr> </table> </td> </tr> <tr> <td>PLA-ZM60EA</td> <td> <table border="1"> <tr> <td>1</td><td>2</td><td>3</td><td>4</td><td>5</td> <td>ON OFF</td> </tr> <tr> <td>■</td><td>■</td><td>■</td><td>■</td><td>■</td> <td></td> </tr> </table> </td> </tr> <tr> <td>PLA-ZM71EA</td> <td> <table border="1"> <tr> <td>1</td><td>2</td><td>3</td><td>4</td><td>5</td> <td>ON OFF</td> </tr> <tr> <td>■</td><td>■</td><td>■</td><td>■</td><td>■</td> <td></td> </tr> </table> </td> </tr> <tr> <td>PLA-ZM100EA</td> <td> <table border="1"> <tr> <td>1</td><td>2</td><td>3</td><td>4</td><td>5</td> <td>ON OFF</td> </tr> <tr> <td>■</td><td>■</td><td>■</td><td>■</td><td>■</td> <td></td> </tr> </table> </td> </tr> <tr> <td>PLA-ZM125EA</td> <td> <table border="1"> <tr> <td>1</td><td>2</td><td>3</td><td>4</td><td>5</td> <td>ON OFF</td> </tr> <tr> <td>■</td><td>■</td><td>■</td><td>■</td><td>■</td> <td></td> </tr> </table> </td> </tr> <tr> <td>PLA-ZM140EA</td> <td> <table border="1"> <tr> <td>1</td><td>2</td><td>3</td><td>4</td><td>5</td> <td>ON OFF</td> </tr> <tr> <td>■</td><td>■</td><td>■</td><td>■</td><td>■</td> <td></td> </tr> </table> </td> </tr> </tbody> </table>	MODELS	SETTING	PLA-ZM35EA	<table border="1"> <tr> <td>1</td><td>2</td><td>3</td><td>4</td><td>5</td> <td>ON OFF</td> </tr> <tr> <td>■</td><td>■</td><td>■</td><td>■</td><td>■</td> <td></td> </tr> </table>	1	2	3	4	5	ON OFF	■	■	■	■	■		PLA-ZM50EA	<table border="1"> <tr> <td>1</td><td>2</td><td>3</td><td>4</td><td>5</td> <td>ON OFF</td> </tr> <tr> <td>■</td><td>■</td><td>■</td><td>■</td><td>■</td> <td></td> </tr> </table>	1	2	3	4	5	ON OFF	■	■	■	■	■		PLA-ZM60EA	<table border="1"> <tr> <td>1</td><td>2</td><td>3</td><td>4</td><td>5</td> <td>ON OFF</td> </tr> <tr> <td>■</td><td>■</td><td>■</td><td>■</td><td>■</td> <td></td> </tr> </table>	1	2	3	4	5	ON OFF	■	■	■	■	■		PLA-ZM71EA	<table border="1"> <tr> <td>1</td><td>2</td><td>3</td><td>4</td><td>5</td> <td>ON OFF</td> </tr> <tr> <td>■</td><td>■</td><td>■</td><td>■</td><td>■</td> <td></td> </tr> </table>	1	2	3	4	5	ON OFF	■	■	■	■	■		PLA-ZM100EA	<table border="1"> <tr> <td>1</td><td>2</td><td>3</td><td>4</td><td>5</td> <td>ON OFF</td> </tr> <tr> <td>■</td><td>■</td><td>■</td><td>■</td><td>■</td> <td></td> </tr> </table>	1	2	3	4	5	ON OFF	■	■	■	■	■		PLA-ZM125EA	<table border="1"> <tr> <td>1</td><td>2</td><td>3</td><td>4</td><td>5</td> <td>ON OFF</td> </tr> <tr> <td>■</td><td>■</td><td>■</td><td>■</td><td>■</td> <td></td> </tr> </table>	1	2	3	4	5	ON OFF	■	■	■	■	■		PLA-ZM140EA	<table border="1"> <tr> <td>1</td><td>2</td><td>3</td><td>4</td><td>5</td> <td>ON OFF</td> </tr> <tr> <td>■</td><td>■</td><td>■</td><td>■</td><td>■</td> <td></td> </tr> </table>	1	2	3	4	5	ON OFF	■	■	■	■	■		
MODELS	SETTING																																																																																																						
PLA-ZM35EA	<table border="1"> <tr> <td>1</td><td>2</td><td>3</td><td>4</td><td>5</td> <td>ON OFF</td> </tr> <tr> <td>■</td><td>■</td><td>■</td><td>■</td><td>■</td> <td></td> </tr> </table>	1	2	3	4	5	ON OFF	■	■	■	■	■																																																																																											
1	2	3	4	5	ON OFF																																																																																																		
■	■	■	■	■																																																																																																			
PLA-ZM50EA	<table border="1"> <tr> <td>1</td><td>2</td><td>3</td><td>4</td><td>5</td> <td>ON OFF</td> </tr> <tr> <td>■</td><td>■</td><td>■</td><td>■</td><td>■</td> <td></td> </tr> </table>	1	2	3	4	5	ON OFF	■	■	■	■	■																																																																																											
1	2	3	4	5	ON OFF																																																																																																		
■	■	■	■	■																																																																																																			
PLA-ZM60EA	<table border="1"> <tr> <td>1</td><td>2</td><td>3</td><td>4</td><td>5</td> <td>ON OFF</td> </tr> <tr> <td>■</td><td>■</td><td>■</td><td>■</td><td>■</td> <td></td> </tr> </table>	1	2	3	4	5	ON OFF	■	■	■	■	■																																																																																											
1	2	3	4	5	ON OFF																																																																																																		
■	■	■	■	■																																																																																																			
PLA-ZM71EA	<table border="1"> <tr> <td>1</td><td>2</td><td>3</td><td>4</td><td>5</td> <td>ON OFF</td> </tr> <tr> <td>■</td><td>■</td><td>■</td><td>■</td><td>■</td> <td></td> </tr> </table>	1	2	3	4	5	ON OFF	■	■	■	■	■																																																																																											
1	2	3	4	5	ON OFF																																																																																																		
■	■	■	■	■																																																																																																			
PLA-ZM100EA	<table border="1"> <tr> <td>1</td><td>2</td><td>3</td><td>4</td><td>5</td> <td>ON OFF</td> </tr> <tr> <td>■</td><td>■</td><td>■</td><td>■</td><td>■</td> <td></td> </tr> </table>	1	2	3	4	5	ON OFF	■	■	■	■	■																																																																																											
1	2	3	4	5	ON OFF																																																																																																		
■	■	■	■	■																																																																																																			
PLA-ZM125EA	<table border="1"> <tr> <td>1</td><td>2</td><td>3</td><td>4</td><td>5</td> <td>ON OFF</td> </tr> <tr> <td>■</td><td>■</td><td>■</td><td>■</td><td>■</td> <td></td> </tr> </table>	1	2	3	4	5	ON OFF	■	■	■	■	■																																																																																											
1	2	3	4	5	ON OFF																																																																																																		
■	■	■	■	■																																																																																																			
PLA-ZM140EA	<table border="1"> <tr> <td>1</td><td>2</td><td>3</td><td>4</td><td>5</td> <td>ON OFF</td> </tr> <tr> <td>■</td><td>■</td><td>■</td><td>■</td><td>■</td> <td></td> </tr> </table>	1	2	3	4	5	ON OFF	■	■	■	■	■																																																																																											
1	2	3	4	5	ON OFF																																																																																																		
■	■	■	■	■																																																																																																			
J41 J42	Pair number setting with wireless remote controller	<table border="1"> <thead> <tr> <th rowspan="2">Wireless remote controller setting</th> <th colspan="2">Control PCB setting</th> </tr> <tr> <th>J41</th> <th>J42</th> </tr> </thead> <tbody> <tr> <td>0</td> <td>Short</td> <td>Short</td> </tr> <tr> <td>1</td> <td>Open</td> <td>Short</td> </tr> <tr> <td>2</td> <td>Short</td> <td>Open</td> </tr> <tr> <td>3 to 9</td> <td>Open</td> <td>Open</td> </tr> </tbody> </table>	Wireless remote controller setting	Control PCB setting		J41	J42	0	Short	Short	1	Open	Short	2	Short	Open	3 to 9	Open	Open	<p><Initial setting> Wireless remote controller: 0 Control PCB: Short (for both J41 and J42) 4 pair number settings are supported. The pair number settings of the wireless remote controller and indoor control PCB (J41/J42) are given in the table on the left. ('Open' in the table indicates the jumper wire is disconnected.)</p>																																																																																			
Wireless remote controller setting	Control PCB setting																																																																																																						
	J41	J42																																																																																																					
0	Short	Short																																																																																																					
1	Open	Short																																																																																																					
2	Short	Open																																																																																																					
3 to 9	Open	Open																																																																																																					

10-1. UNIT FUNCTION SETTING BY THE REMOTE CONTROLLER

Each function can be set as necessary using the remote controller. The setting of function for each unit can only be done by the remote controller.

(1) Functions available when setting the unit number to 00

Refer to the service manual that comes with each outdoor unit.

(2) Functions available when setting the unit number to 01–03 or AL (07 in case of wireless remote controller)

<Table 1>

Function	Settings	Mode No.	Setting No.	Initial setting	Setting
Filter sign	100 Hr	07	1		
	2500 Hr		2	○	
	No filter sign indicator		3		
Fan speed	Silent (low ceiling)	08	1		
	Standard		2	○	
	High ceiling		3		
No. of air outlets	4 directions	09	1	○	
	3 directions		2		
	2 directions		3		
Installed options (high efficiency filter)	Not supported	10	1	○	
	Supported		2		
Up/down vane setting	Downward setting (vaner angle setup ③)	11	1		
	Middle setting (vaner angle setup ①)		2		
	Draft-less setting (vaner angle setup ②)		3	○	
3D i-see Sensor positioning	Position ①	12*1	1		
	Position ②		2		
	Position ③ (Default)		3	○	
3D i-see Sensor ceiling height setting (when installing the 3D i-see Sensor panel)	Low ceiling (ceiling height: less than 2.7m)	26	1		
	Standard (ceiling height: 2.7–3.5 m)		2	○	
	High ceiling (ceiling height: 3.5–4.5 m)		3		
Fan speed during the cooling thermostat is OFF	Setting fan speed	27	1		
	Stop		2		
	Extra low		3	○	

*1 When the 3D i-see Sensor corner panel position is changed, change this mode. For more details, refer to the Installation Manual.

11-1. OPERATION (AUTOMATIC FILTER ELEVATION GRILLE: PLP-6EAJ/PLP-6EAJE)

(1) Normal operation

① UP/DOWN

Air intake grille is raised/lowered by commands of UP and DOWN.

Air intake grille does not move under the state of no-load detection or obstacle detection.

Air intake grille stops automatically at the set lowering distance from the ceiling level.

② STOP

It stops in the cases below :

- When it reaches the set lowering distance from the ceiling level.

It automatically stops after a predetermined period of lowering.

- When it is stored in the panel.

The air intake grille is judged to be stored in the panel when the storage detection switch is pressed for 5 seconds continuously.

- When receiving commands of STOP, DOWN while moving up or UP while moving down.

The STOP button is only available on the automatic filter elevation panel remote controller.

When the wired remote controller is used, there will be a slight delay in stopping due to transmission speed.

- When both string 1b and 2b are not loaded.

Only the string b in each UP/DOWN Machine has a tension detection switch.

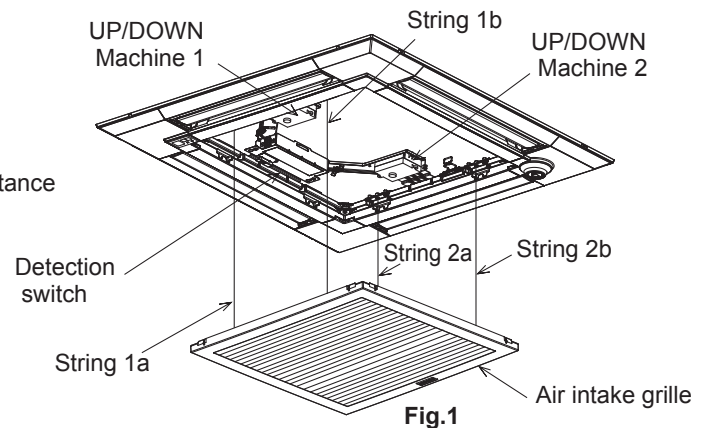

(2) Special operation

① Re-storage operation

Case : Obstruction of the raising air intake grille before storage or malfunction of storage detection switch
Re-storage operation will be performed when the intake grille has been raised the set distance but the storage detection switch is not engaged.

In this case, the operation below will be repeated up to 4 times.

10 cm down → 30 cm up → … → 10 cm down → 30 cm up

② No-load detection

Case : UP/DOWN commands with no grille suspended.

When both string 1b and string 2b are not loaded, the strings will not move.

③ Obstacle detection

Case : Making contact with something while lowering.

Should the loads on the string 1b and string 2b be removed due to the air intake grille making contact with something while lowering, the lowering operation will stop. The air intake grille will then be raised 10 cm and stop again.

[EMERGENCY OPERATION]

1. If the wireless remote controller for ELEVATION PANEL is faulty or lost, operation will be possible using the emergency up/down switch at the wireless signal receiver or wired remote controller.

- For the operation using the emergency up/down switch at the wireless signal receiver, refer to SW1 and SW2 on the [LEGEND] in the next page.

2. When machine for ELEVATION PANEL breaks down, an intake grille is fixed for a while, and the operation of the unit can be done.

- Refer to installation manual with the grille for the details such as an installation method.

11-2. ELECTRICAL CIRCUIT (Controller board and wiring diagram (Panel))

11-2-1 DIP SW

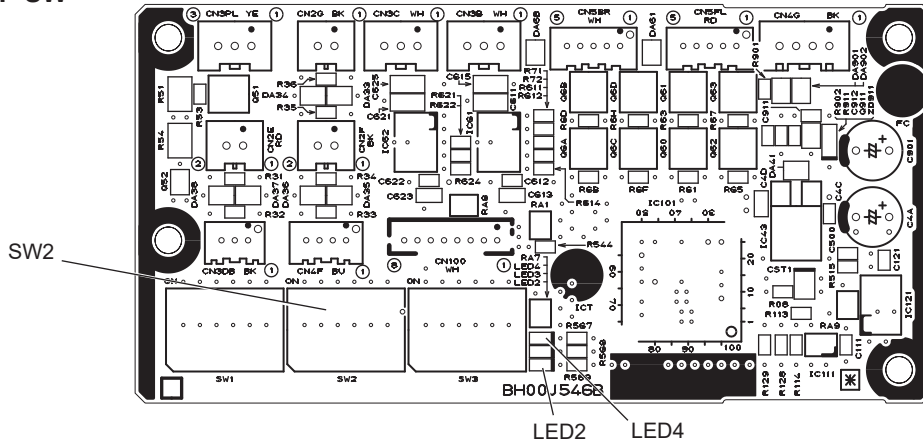

[LEGEND]

SYMBOL	NAME
U.B	ELEVATION PANEL CONTROLLER BOARD
LED2	LED ORANGE (INTAKE GRILLE CONDITION (See Table *1))
LED4	LED GREEN (COMMUNICATION WITH INDOOR UNIT)
U.K 1	ELEVATION MACHINE
M	MOTOR (ELEVATION)
LS21	DETECTION SWITCH (STRING TENSION)
I.B	INDOOR UNIT CONTROLLER BOARD
W.B	PCB OF SIGNAL RECEIVER
BZ	BUZZER
RU	RECEIVING UNIT
LED1	LED GREEN (OPERATION INDICATION)
LED2	LED ORANGE (PREPARATION FOR HEATING)
SW1	EMERGENCY HEATING (LONG PRESS FOR OVER 2SEC.) (SHORT PRESS)
SW2	EMERGENCY COOLING (LONG PRESS FOR OVER 2SEC.) (SHORT PRESS)
LS1	DETECTION SWITCH (INTAKE GRILLE STORAGE)
R.B	WIRED REMOTE CONTROLLER

[EMERGENCY OPERATION]

- If the wireless remote controller for ELEVATION PANEL is faulty or lost, operation will be possible using the emergency up/down switch at the wireless signal receiver or wired remote controller.
 - For the operation using the emergency up/down switch at the wireless signal receiver, refer to SW1 and SW2 on the left [LEGEND].
- When machine for ELEVATION PANEL breaks down, a intake grille is fixed for a while, and the operation of the unit can be done.
 - Refer to installation manual with the grille for the details such as an installation method.

<Table 2>SW2 on U.B

LOWERING DISTANCE	SET UP	LOWERING DISTANCE	SET UP
1.2m	ON OFF [1][2][3][4][5][6]	2.8m	ON OFF [1][2][3][4][5][6]
1.6m (Initial setting)	ON OFF [1][2][3][4][5][6]	3.2m	ON OFF [1][2][3][4][5][6]
2.0m	ON OFF [1][2][3][4][5][6]	3.6m	ON OFF [1][2][3][4][5][6]
2.4m	ON OFF [1][2][3][4][5][6]	4.0m	ON OFF [1][2][3][4][5][6]

Note: The actual lowering distance might be different from the distance in Table 2 since it can also be set using the wired remote controller.

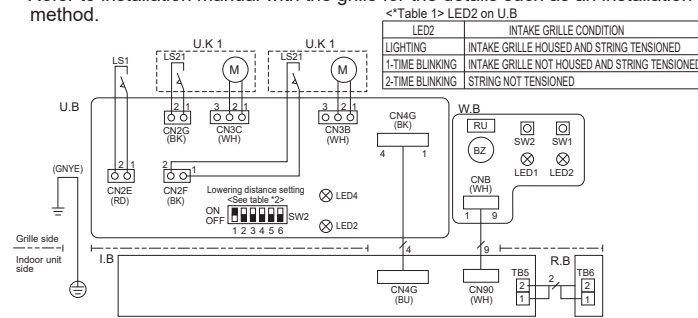

[Note]

- Symbols used in wiring diagram above are, : Connector, : Terminal (block).
- The black square (■) indicates a switch position.

11-2-2. Check point of trouble

<LED 2 Orange display>

- Turn OFF : No power supply
- Blink : Storage detection switch ON (short)
- One blink : Storage detection switch OFF (open)
- Two blinks : Tension detection switch OFF (open)

<LED 4 Green display>

- Blink : Connecting

<Controller board>

Check item	Check point	Normal	Remarks
Up/down controller P.C. board supply voltage	CN4A (between 1-2)	11-14 V AC	—
Up/down machine supply voltage	CN3B (between 1-2) CN3C (between 1-2)	10-13.5 V DC	Check when instructing up/down with LED blinking once.

<Up/down machine>

Check item	Check point	Normal	Check contents
Storage detection switch	CN2E	open or short	Check if it is short by pressing push switch.
Tension detection switch	CN2F, CN2G	open or short	Check if it is short when string b is tensioned.
Motor	CN3B, CN3C	5-20 Ω	Check if it is not open or short.
Entwining strings	Pull string	Retention: about 2 kgf	Check if string is drawn out by pulling with 4 kgf.

11-3. TROUBLESHOOTING

- Check the following points.

Problem	Possible Reason	Corrective Action
Intake grille does not function with operation of the remote controller.	Air-conditioner is running.	Stop running the air-conditioner and try again.
	Power failure	After recovering from power failure, try again.
	Batteries are not inserted into the wireless remote controller. Or battery power is running low.	Install or replace the battery.
	There is something on the intake grille. Or something is stuck in the intake grille.	Remove the objects or obstacles from the intake grille. Or, remove the stuck object.
Intake grille cannot be placed in the correct position.	There is something on the intake grille.	Remove the objects or obstacles from the intake grille.
	Filter is not properly installed.	Lower the intake grille again and check whether the filter is installed in the correct position.
	Intake grille is not hung with all 4 hooks.	Lower the intake grille again and hang the hook on the intake grille.
Intake grille stops lowering in mid flow. (Intake grille would not lower any further.)	Because the intake grille has finished lowering to the auto-stop position.	This is normal. Note: If you want to change the setting for the lowering distance, contact your dealer.
Noises are made during up/down operation. (While intake grille is moving up/down.)	This is the noise made when the string is winded and unwound.	This is normal.
Noises are made while placing the intake grille in.	This is the operational noise for placing the intake grille in securely.	
Intake grille repeats rising and lowering several times while being placed in the correct position.	This is the operation for placing the intake grille in securely.	
Intake grille leans toward one side during the up/down operation.	The speeds of winding each string is slightly different.	

11-4. ROTATION FUNCTION (AND BACK-UP FUNCTION, 2ND STAGE CUT-IN FUNCTION)

Note that this function is not available for SUZ, MXZ, and PUMY models.

11-4-1. Operation

(1) Rotation function (and Back-up function)

• Outline of functions

- Main and sub unit operate according to the interval of rotation setting.
Main and sub unit should be set by refrigerant address. (Outdoor DIP switch setting)
Refrigerant address "00" → Main unit
Refrigerant address "01", "02" → Sub unit
- When an error occurs to one unit, another unit will start operation. (Back-up function)

• System constraint

- This function is available only by the grouping control system (INDOOR UNIT: OUTDOOR UNIT=1:1) of 2 or 3 refrigerant groups. (Refer to Fig. 1)
- Main indoor unit should be connected for wired remote controller and the transmission line (TB5) for main and sub unit should also be connected. (Refer to Fig. 1)
(This function cannot be set by wireless remote controller.)
- Set refrigerant address of each unit. (DIP switch on the outdoor unit ... Refrigerant address 00/01/02)

Operation pattern

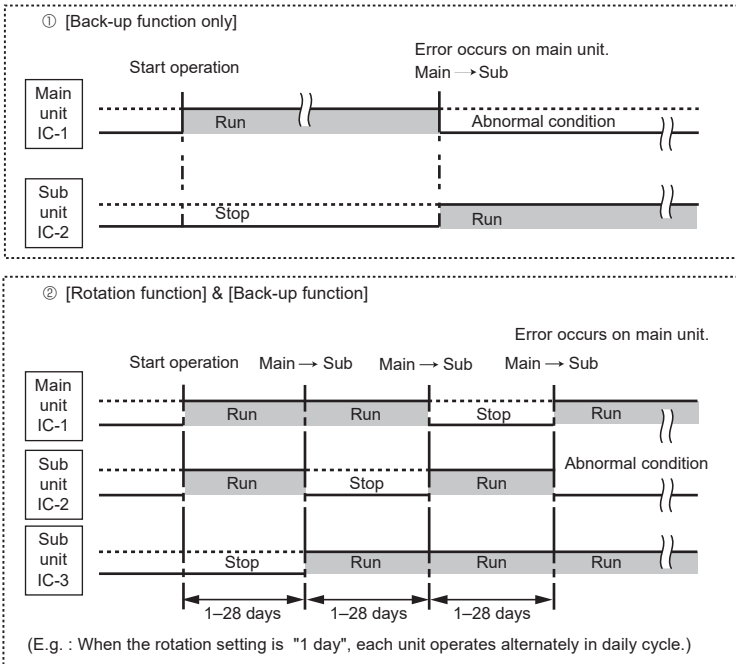
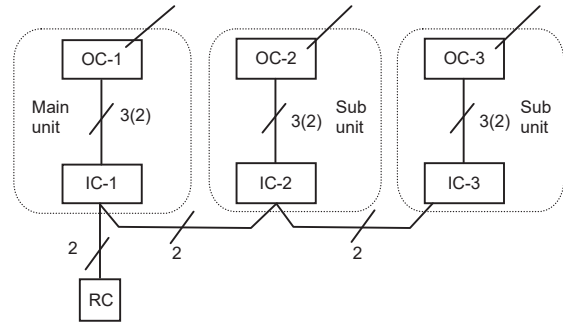

Fig. 1 Refrigerant address "00" Refrigerant address "01" Refrigerant address "02"



- Note:**
- When the unit is restarted to operate after turning off the power or operation OFF status, the unit which was operating will start operation.
 - To operate the main unit, refer to "13-6. ROTATION SETTING" and set again.

(2) 2nd stage cut-in function

• Outline of functions

- When the 1st and 2nd unit CANNOT supply sufficient capacity for exceptionally high-demand conditions and the actual room temperature reaches set point (*), the 3rd unit starts operation in conjunction with the 1st and 2nd unit.
- Once the actual room temperature goes down to 4°C below set point(*), the 3rd unit stops operation automatically. (* set point = set temperature by R/C (remote controller) + 4, 6, 8°C (selectable))
- Number of operating units is determined according to the room temperature and set point.
- When room temperature reaches higher than set point, standby unit starts. (3 units operation)
- When room temperature falls below set point -4°C, standby unit stops. (2 units operation)

• System constraint

- This function is available only in cool mode.

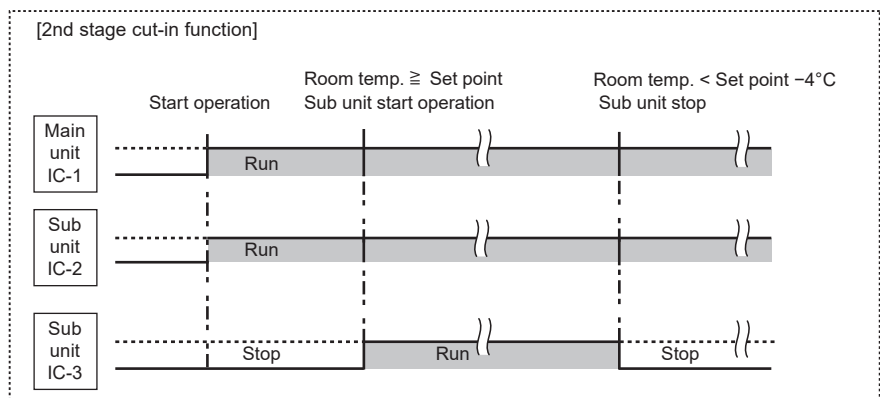
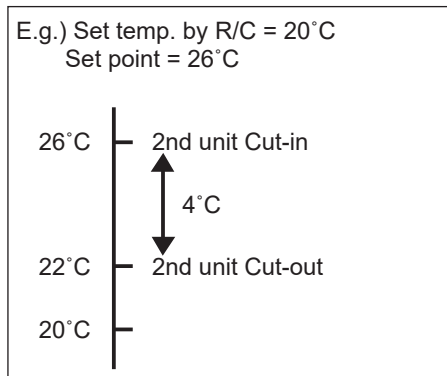

→ : Indicates the visible parts in the photos/figures.

Be careful when removing heavy parts.

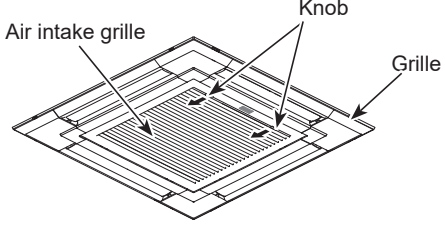
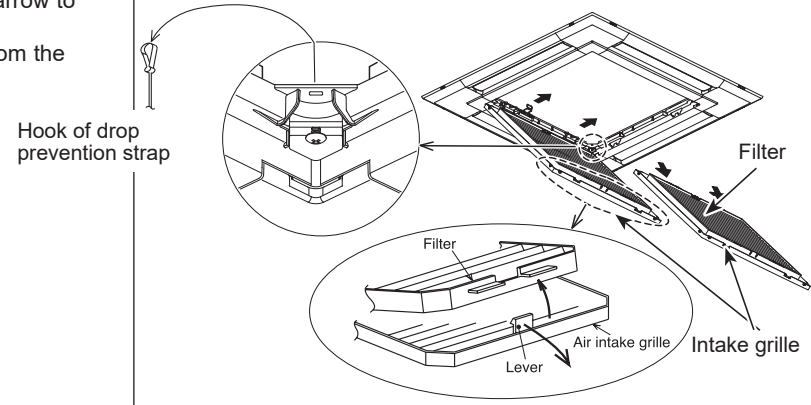
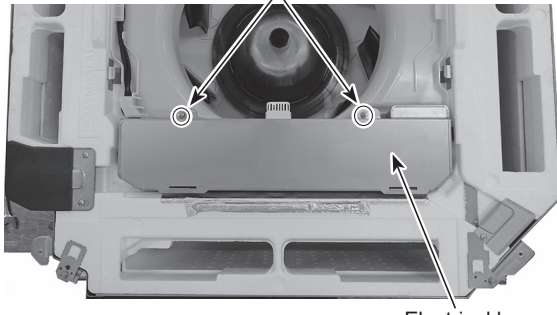
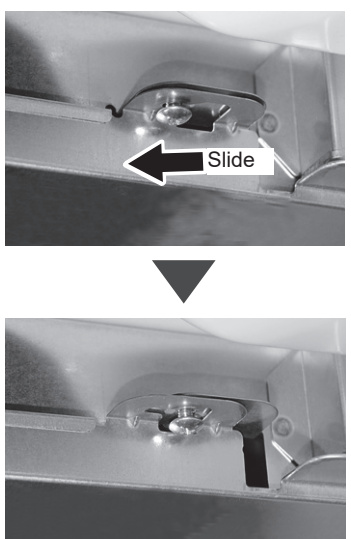
OPERATING PROCEDURE	PHOTOS/FIGURES
<p>1. Removing the filter</p> <ol style="list-style-type: none"> (1) Slide the knob of air intake grille toward the arrow to open the air intake grille. (See Figure 1) (2) Pull down the lever of the air intake grille to remove the filter. (See Figure 2) 	<p>Figure 1</p> 
<p>2. Removing the air intake grille</p> <ol style="list-style-type: none"> (1) Slide the knob of air intake grille toward the arrow to open the air intake grille. (See Figure 1) (2) Remove the hook of drop prevention strap from the panel. (3) Remove the air intake grille. 	<p>Figure 2</p> 
<p>3. Removing the electrical box cover</p> <ol style="list-style-type: none"> (1) Remove the air intake grille and the filter. (Refer to procedure 2) (2) Loosen the 2 electrical box cover fixing screws (M4×10) approximately 2 to 3 mm. (See Photo 1) (3) Slide the electrical box cover toward the arrow to remove. (See Photo 2) 	<p>Photo 1</p>  <p>Photo 2</p> 

OPERATING PROCEDURE

PHOTOS/FIGURES

4. Removing the room temperature thermistor (TH1)

- (1) Remove the electrical box cover. (See Photo 1 and 2)
- (2) Disconnect the connector CN20 (Red) from the indoor controller board.
- (3) Remove the room temperature thermistor with its holder. (See Photo 4)

Photo 3

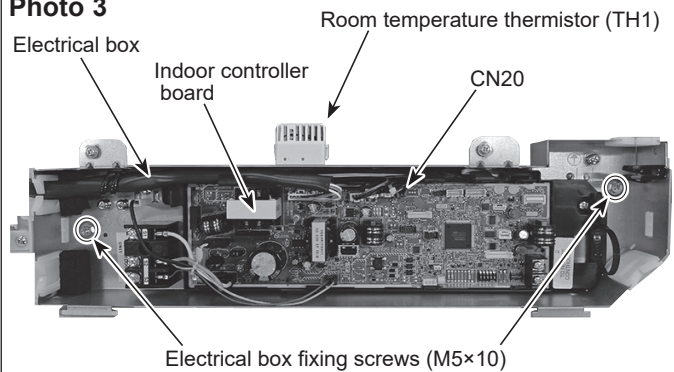
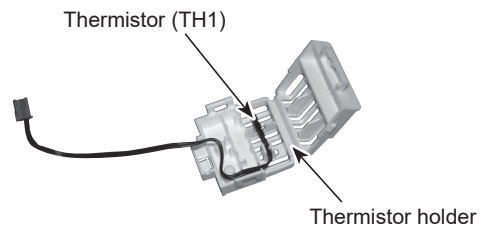

Photo 4



5. Removing the indoor controller board (I.B)

- (1) Remove the electrical box cover. (See Photo 1 and 2)
- (2) Disconnect the connectors:
 - CNMF (White) for fan motor
 - CNV (White) for vane motor
 - CN5Y (White) for motor for i-see Sensor (Option)
 - CN4Z (White) for sensor for i-see Sensor (Option)
 - CN90 (White) for signal receiver (Option)
 - CNP (White) for drain pump
 - CN4F (White) for float switch
 - CN44 (White) for thermistor (TH2/TH5)
 - CN01 (Black) for Indoor/Outdoor connecting line
 - CN3C (Blue) for Indoor/Outdoor transmission

Disconnect the connectors for optional parts, if any.

- (3) For the unit controlled with the wireless remote controller, disconnect the lead wire connected to TB5 on the indoor controller board.
TB5: Remote controller transmission connecting wire
- (4) Remove the indoor controller board (3 holders/4 Hooks). (See Photo 5)

Photo 5

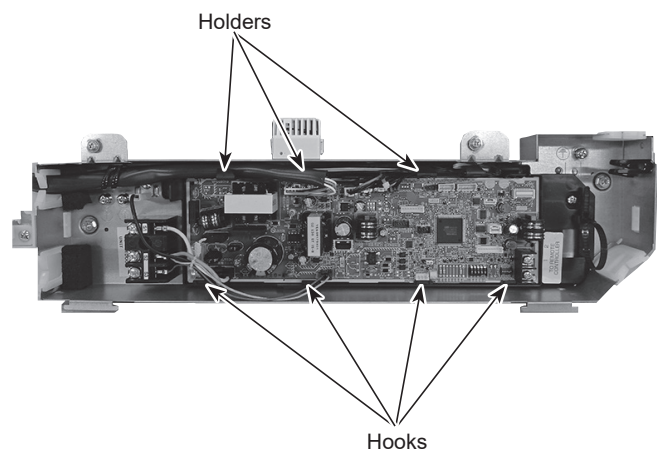

OPERATING PROCEDURE

6. Removing the electrical box

- (1) Remove the electrical box cover (See Photo 1 and 2) and the connectors (Refer to procedure 5).
- (2) Remove the electrical box fixing screws (M5×10: 2 screw). (See Photo 3)

<Electrical parts in the electrical box>

- Terminal block for earth and reactor
- Indoor controller board
- Thermistor (TH)

- (3) Remove the electrical box (2 hooks).

7. Removing the turbo fan

- (1) Remove the electrical box. (See Photo 3 and refer to procedure 6)
- (2) Remove the bell mouth (tapping screw 4×10: 2 screws). (See Photo 5)
- (3) Remove the nut (M8 × 1) and a square washer. (See Photo 7 and 8.)
- (4) Remove the turbo fan.

Note 1: When assembling the turbo fan, attach it so that its tabs fit the holes of washer.

Note 2: Nut tightening torque: 4.5 ± 0.5 Nm.

Turbo fan

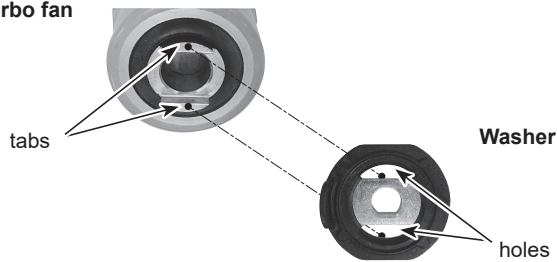
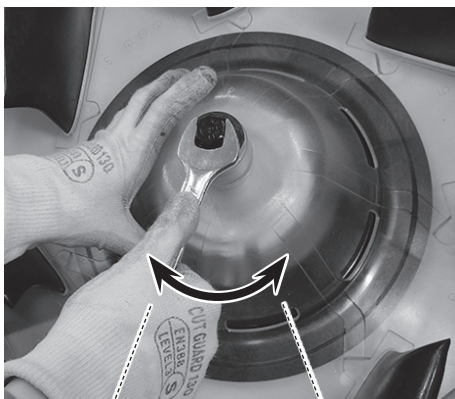

Photo 8



Turn this way to tighten. Turn this way to loosen.
(The same directions as the fan rotation.)

PHOTOS/FIGURES

Photo 6

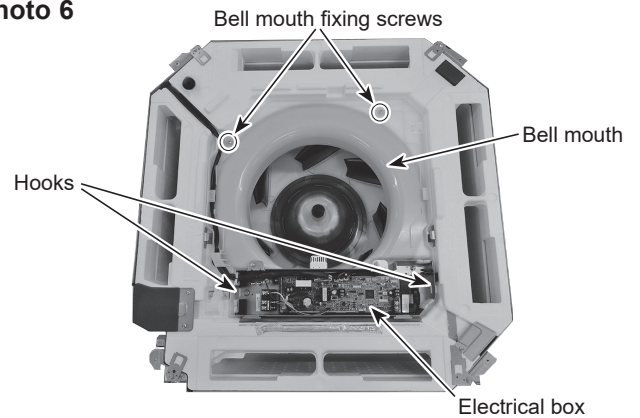
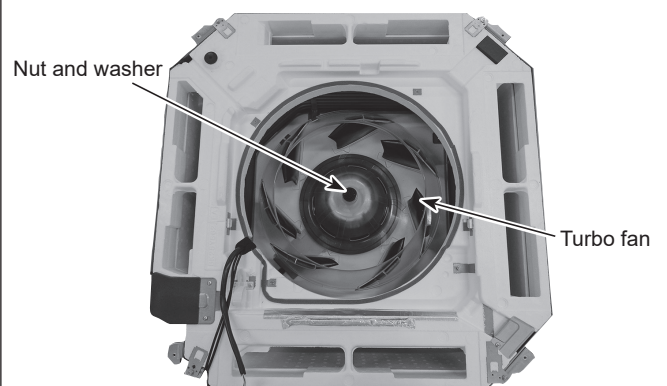

Photo 7



< Nut and washer >



Photo 9

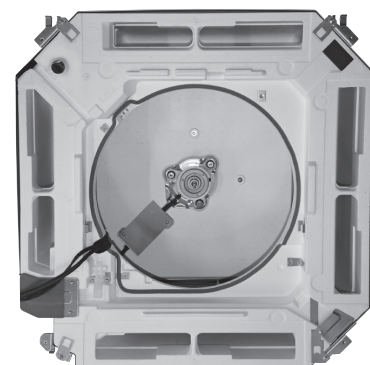

OPERATING PROCEDURE

8. Removing the fan motor (MF)

- (1) Remove the turbo fan.
(See Photo 7 and refer to procedure 7)
- (2) Remove the lead cover (tapping screw 4×10: 2 screws).
(See Photo 10)
- (3) Loosen the 2 clamps.
- (4) Remove the 3 nuts and washers (M5).
- (5) Remove the fan motor.
- (6) Remove the 3 rubber mounts.

Figure 3: Partial cross section

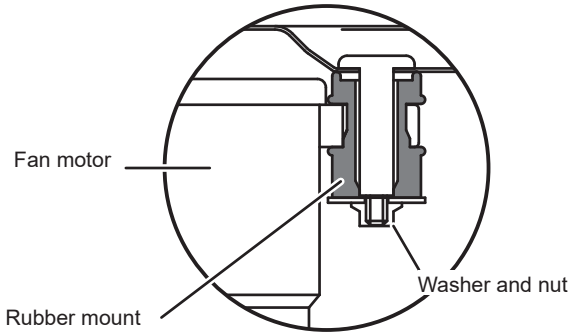

Note: When re-attaching the motor mount, make sure that the thicker end faces the motor shaft.

9. Removing the panel

- (1) Remove the electrical box fixing cover. (See Photo 1)
- (2) Disconnect the connector for vane motor (CNV: White).
(Refer to procedure 5)
- (3) Loosen the 4 corner panel fixing screws (tapping screw 4×16). (See Figure 4)
- (4) Slide the corner panel to the direction of the arrow 1, and remove the corner panel. (See Figure 4)
- (5) Remove the 4 installation screws (M5×28). (See Photo 11)
- (6) Release the 2 temporary hanging hooks to remove the grille. (See Photo 12)

PHOTOS/FIGURES

Photo 10

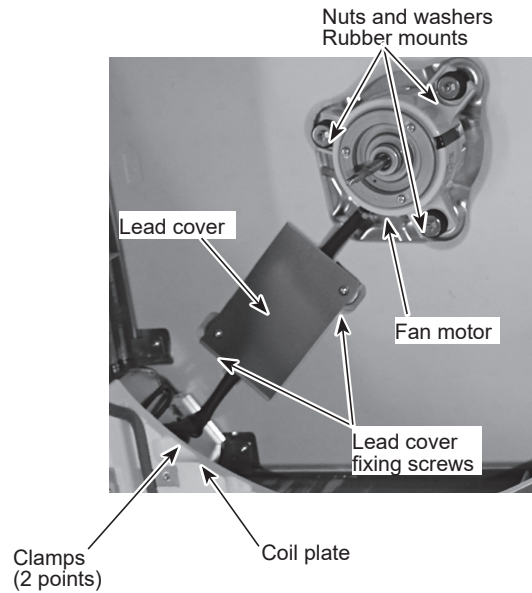

Figure 4

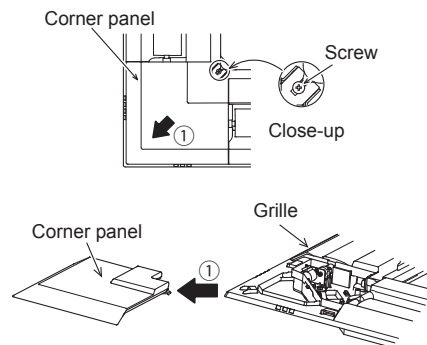

Photo 11

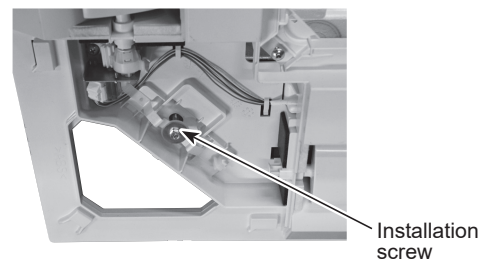
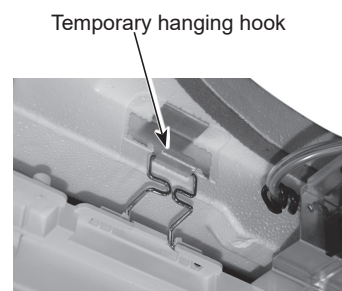
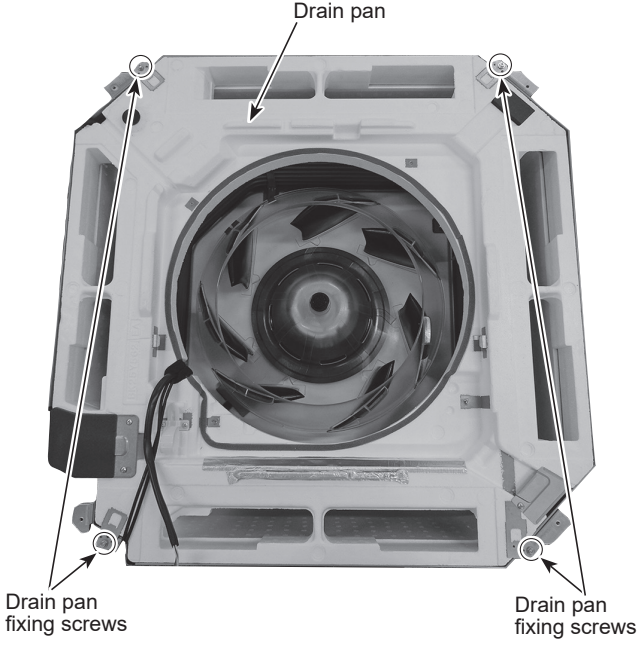
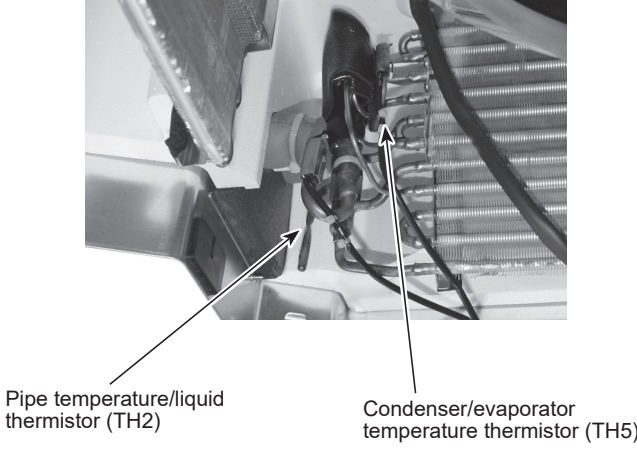

Photo 12





OPERATING PROCEDURE	PHOTOS/FIGURES
<p>10. Removing the drain pan</p> <ol style="list-style-type: none">(1) Remove the electrical box. (See photo 3 and refer to procedure 6)(2) Remove the bell mouth (tapping screw 4×10 : 2 screws). (See Photo 6)(3) Remove the drain pan (screw M5×10: 4 screws).	<p>Photo 13</p>  <p>Drain pan</p> <p>Drain pan fixing screws</p>
<p>11. Removing the pipe temperature/liquid thermistor (TH2) and condenser/evaporator temperature thermistor (TH5)</p> <ol style="list-style-type: none">(1) Remove the drain pan (Refer to procedure 10) and loosen the 2 clamps of the coil plate. (See Photo 10)(2) Remove the coil plate (tapping screw 4×10: 2 screws).(3) Disconnect the pipe temperature/liquid thermistor (TH2) and condenser/evaporator temperature thermistor (TH5) from the holder.	<p>Photo 14</p>  <p>Pipe temperature/liquid thermistor (TH2)</p> <p>Condenser/evaporator temperature thermistor (TH5)</p>

OPERATING PROCEDURE

12. Removing the drain pump (DP)

- (1) Remove the drain pan. (Refer to procedure 10)
- (2) Cut the hose band and remove the hose.
- (3) Loosen the clamp of the drain pump.
- (4) Remove the drain pump (tapping screw 4×10: 2 screws/2 hooks).
- (5) Cut the drain pump base and lead wire fixing band. (See Figure 5)
- (6) Remove the lead wire of the drain pump from the clamp of the drain pump base. (See Figure 5)
- (7) Remove the drain pump (tapping screw: 3 screws). (See Figure 6)

PHOTOS/FIGURES

Photo 15

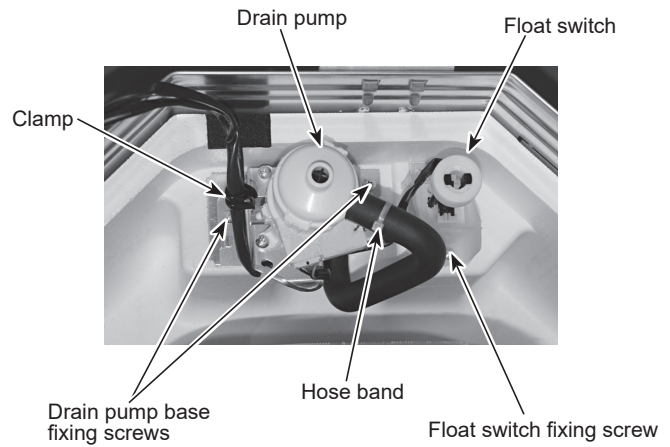

Figure 6

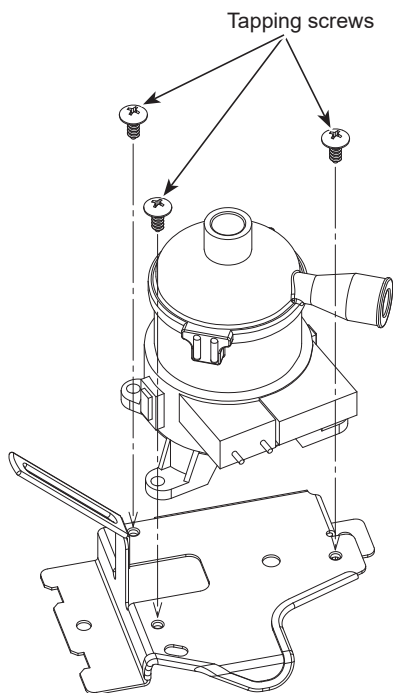
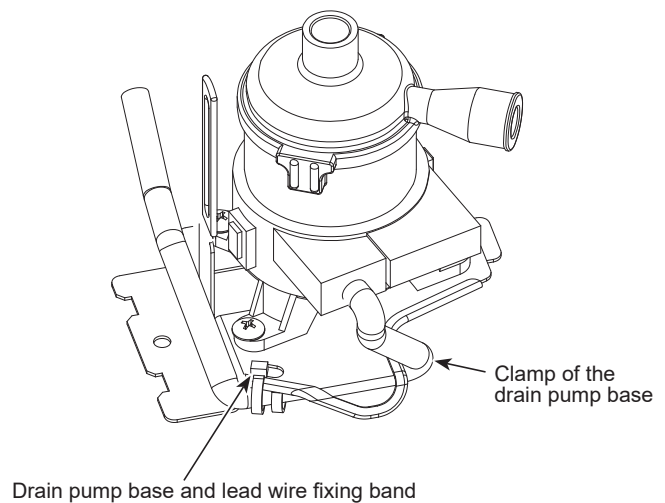

Figure 5



OPERATING PROCEDURE

13. Removing the float switch (FS)

- (1) Remove the drain pan. (Refer to procedure 10)
- (2) Loosen the clamp of the drain pump. (See Photo 15)
- (3) Remove the float switch (tapping screw 4×10: 1 screw/1 hook). (See Photo 15)
- (4) Remove the float switch base and the lead wire fixing band. (See Photo 16)
- (5) Remove the lead wire from the U shaped portion of the float switch base. (See Photo 16)
- (6) Slide the float switch towards the arrow to remove from the float switch base.

PHOTOS/FIGURES

Photo 16

Do not hold this floating part when lifting; Doing so will cause malfunction.

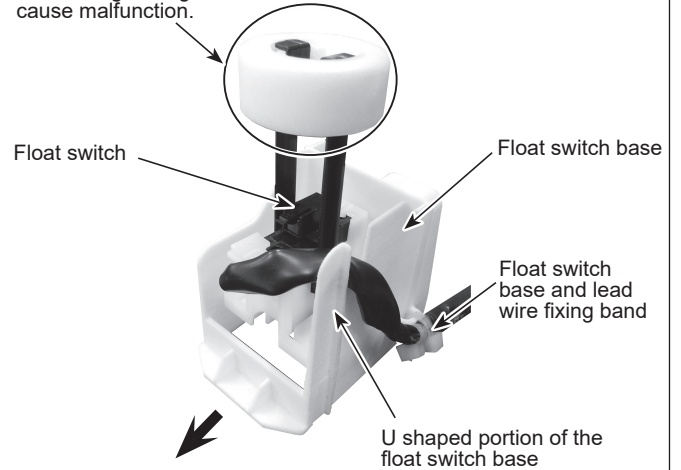

14. Removing the heat exchanger

- (1) Remove the drain pan. (Refer to procedure 10)
- (2) Remove the piping cover (tapping screw 4×10: 3 screws).
- (3) Remove the coil plate (tapping screw 4×10: 2 screws).
- (4) Remove the heat exchanger fixing screws (tapping screw 4×10: 2 screws).
- (5) Remove the coil support (tapping screw 4×10: 1 screw each)
 - ZM35–60: 1 coil support (See photo 17)
 - ZM71–140: 3 coil supports (See photo 18)
- (6) Remove the heat exchanger.

Photo 17

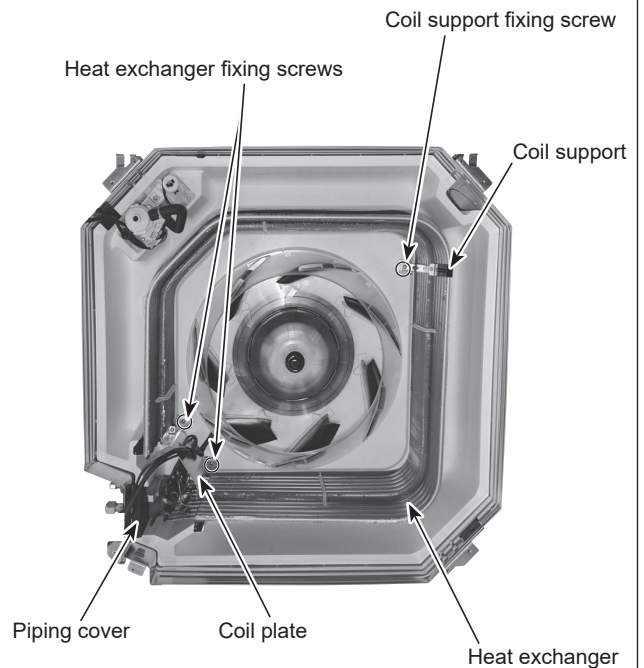
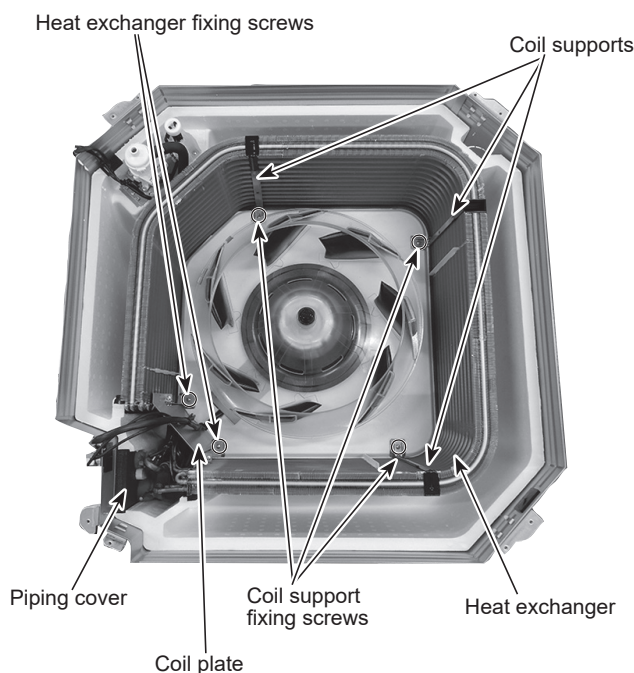

Photo 18



13-1. REMOTE CONTROLLER FUNCTIONS

<PAR-41MAA>

Controller interface

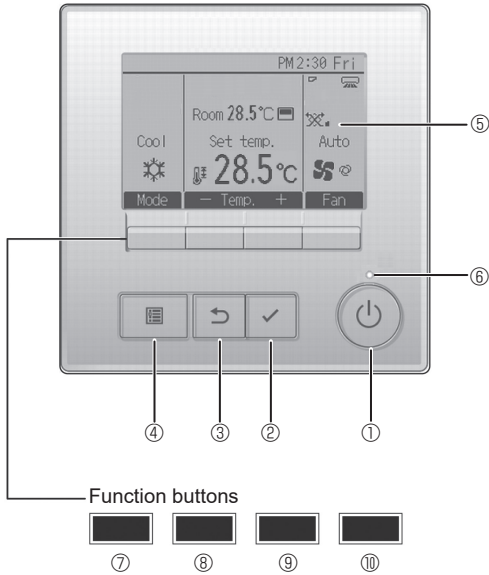

① [ON/OFF] button

Press to turn ON/OFF the indoor unit.

② [SELECT] button

Press to save the setting.

③ [RETURN] button

Press to return to the previous screen.

④ [MENU] button

Press to bring up the Main menu.

⑤ Backlit LCD

Operation settings will appear.
When the backlight is off, pressing any button turns the backlight on and it will stay lit for a certain period of time depending on the screen.

When the backlight is off, pressing any button turns the backlight on and does not perform its function. (except for the [ON/OFF] button)

The functions of the function buttons change depending on the screen.

Refer to the button function guide that appears at the bottom of the LCD for the functions they serve on a given screen.

When the system is centrally controlled, the button function guide that corresponds to the locked button will not appear.

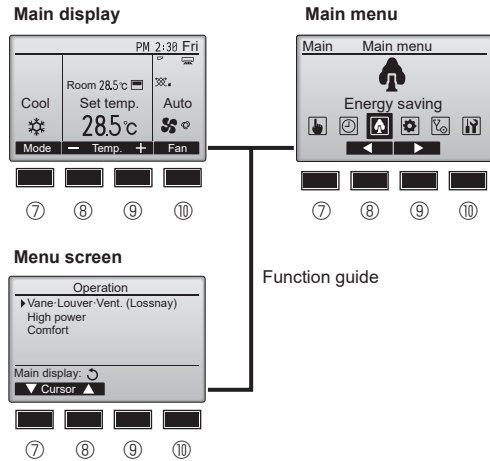

⑥ ON/OFF lamp

This lamp lights up in green while the unit is in operation. It blinks while the remote controller is starting up or when there is an error.

⑦ Function button [F1]

Main display: Press to change the operation mode.
Menu screen: The button function varies with the screen.

⑧ Function button [F2]

Main display: Press to decrease temperature.
Main menu: Press to move the cursor left.
Menu screen: The button function varies with the screen.

⑨ Function button [F3]

Main display: Press to increase temperature.
Main menu: Press to move the cursor right.
Menu screen: The button function varies with the screen.

⑩ Function button [F4]

Main display: Press to change the fan speed.
Menu screen: The button function varies with the screen.

Display

The main display can be displayed in two different modes: "Full" and "Basic". The initial setting is "Full". To switch to the "Basic" mode, change the setting on the Main display setting. (Refer to operation manual included with remote controller.)

<Full mode>

* All icons are displayed for explanation.

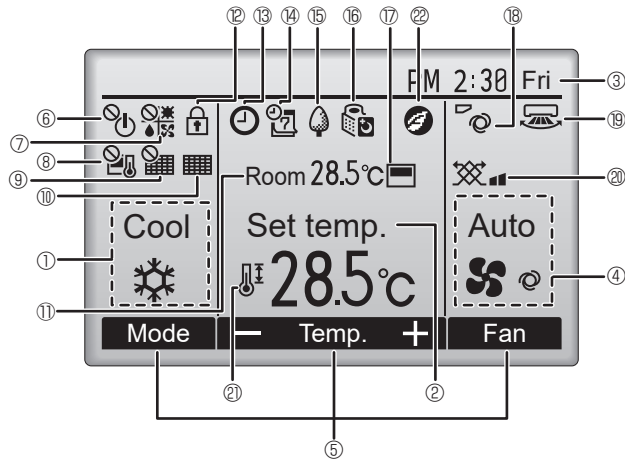

<Basic mode>

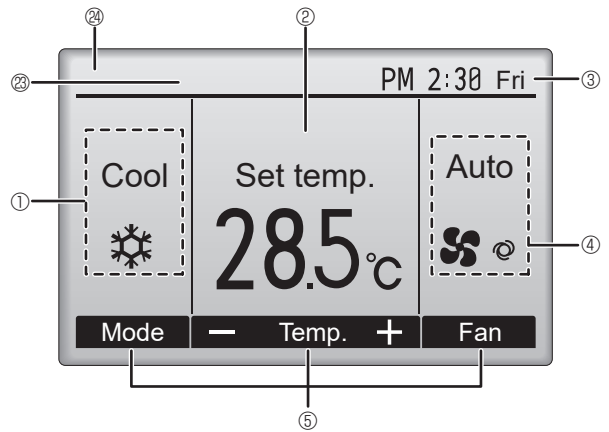

① Operation mode

② Preset temperature

③ Clock

④ Fan speed

⑤ Button function guide

Functions of the corresponding buttons appear here.



Appears when the ON/OFF operation is centrally controlled.



Appears when the operation mode is centrally controlled.



Appears when the preset temperature is centrally controlled.



Appears when the filter reset function is centrally controlled.



Indicates when filter needs maintenance.

⑪ Room temperature



Appears when the buttons are locked.



Appears when the On/Off timer, Night setback, or Auto-off timer function is enabled.



appears when the timer is disabled by the centralized control system.



Appears when the Weekly timer is enabled.



Appears while the units are operated in the energy saving mode. (Will not appear on some models of indoor units)



Appears while the outdoor units are operated in the silent mode.



Appears when the built-in thermistor on the remote controller is activated to monitor the room temperature (⑪).



appears when the thermistor on the indoor unit is activated to monitor the room temperature.



Indicates the vane setting.



Indicates the louver setting.



Indicates the ventilation setting.



Appears when the preset temperature range is restricted.



Appears when an energy saving operation is performed using a "3D i-See sensor" function.

⑳ Centrally controlled

Appears for a certain period of time when a centrally-controlled item is operated.

㉑ Preliminary error display

A check code appears during the preliminary error.

Most settings (except ON/OFF, mode, fan speed, temperature) can be made from the Main menu.

Menu structure

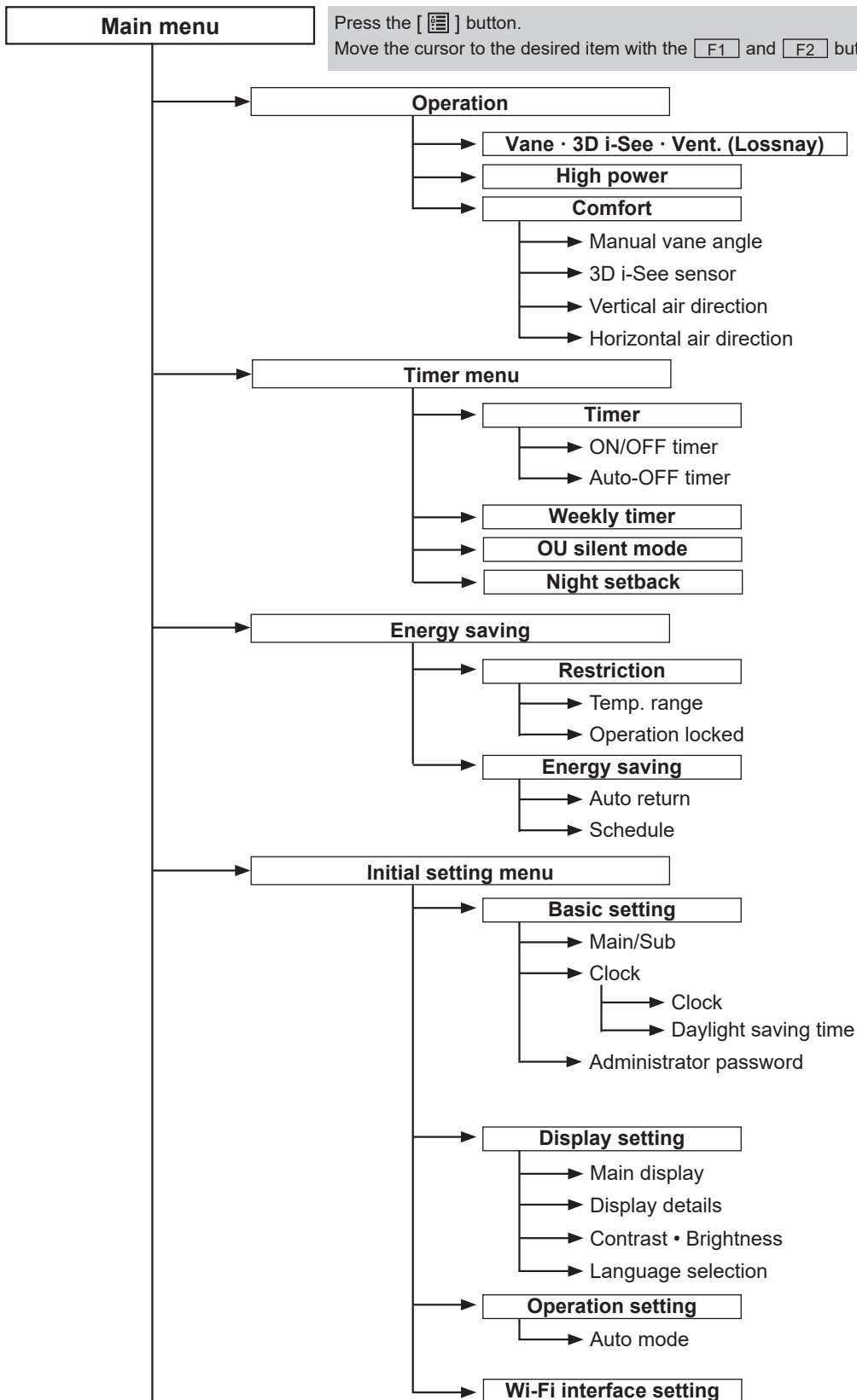

Continue to the next page.

Not all functions are available on all models of indoor units.

Continue from the previous page.

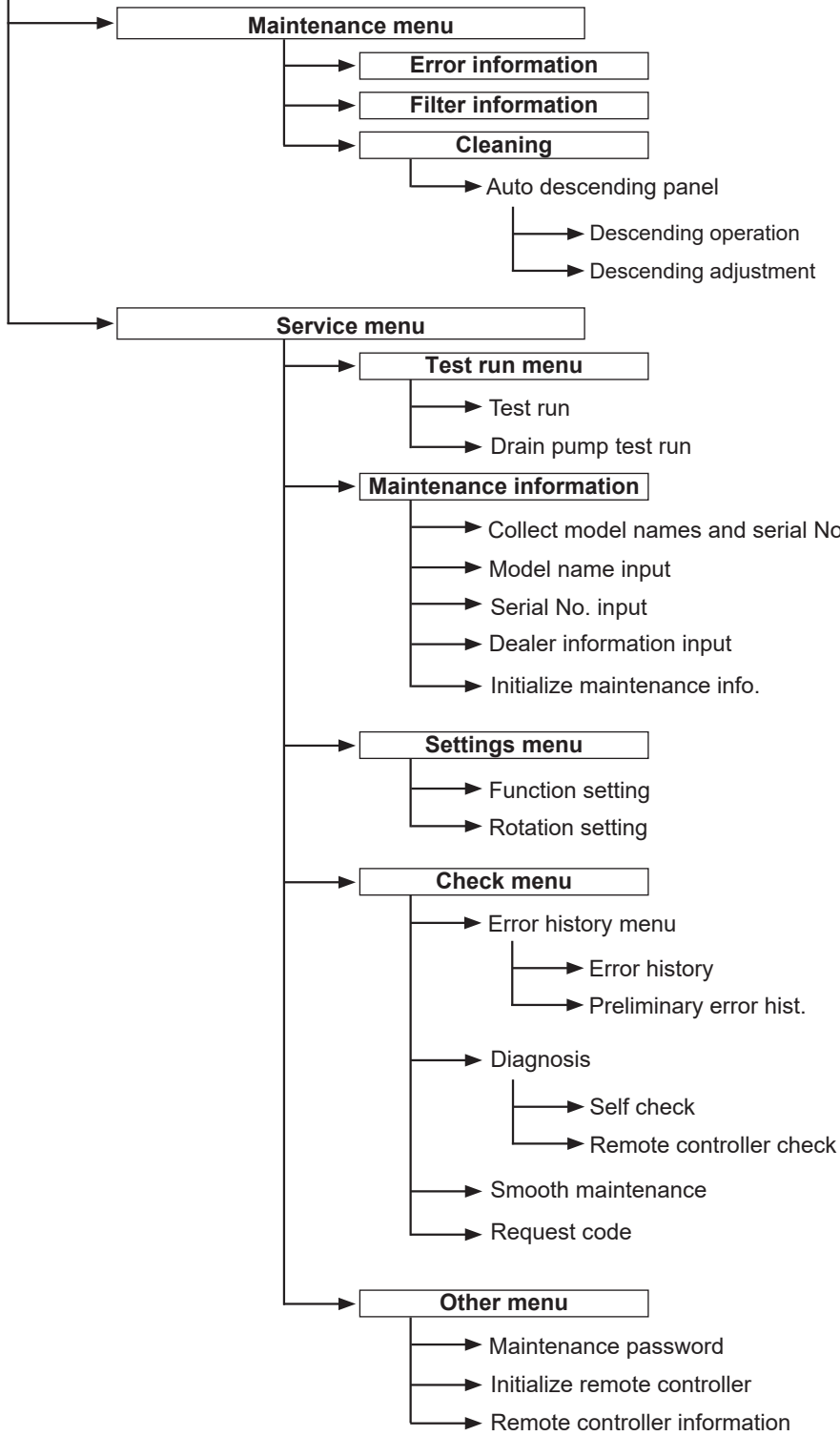

Not all functions are available on all models of indoor units.

Main menu list

Main menu	Setting and display items		Setting details
Operation	Vane · 3D i-See · Vent. (Vane.Vent. (Lossnay))		Vane: Use to set the vertical air direction. Louver: Use to set the horizontal air direction. 3D i-See sensor: This setting is available only for the air conditioners that support easy setting function of motion sensing air direction. Vent: Use to set the amount of ventilation.
	High power ^{*3}		Use to reach the comfortable room temperature quickly. • Units can be operated in the High-power mode for up to 30 minutes.
	Comfort	Manual vane angle	Vertical air direction • Sets the vertical airflow direction (vane) of each unit. Horizontal air direction • Sets the horizontal airflow direction (vane) of each unit.
		3D i-See sensor	Use to set the following functions for 3D i-See sensor. • Air distribution • Energy saving option • Seasonal airflow
Timer	Timer	ON/OFF timer ^{*1}	Use to set the operation ON/OFF times. • Time can be set in 5-minute increments.
		Auto-OFF timer	Use to set the Auto-OFF time. • Time can be set to a value from 30 to 240 in 10-minute increments.
	Weekly timer ^{*1, *2}		Use to set the weekly operation ON/OFF times. • Up to 8 operation patterns can be set for each day. (Not valid when the ON/OFF timer is enabled.)
	OU silent mode ^{*1, *3}		Use to set the time periods in which priority is given to quiet operation of outdoor units over temperature control. Set the Start/Stop times for each day of the week. • Select the desired silent level from "Normal," "Middle," and "Quiet."
	Night setback ^{*1}		Use to make Night setback settings. • Select "Yes" to enable the setting, and "No" to disable the setting. The temperature range and the start/stop times can be set.
Energy saving	Restriction	Temp. range ^{*2}	Use to restrict the preset temperature range. • Different temperature ranges can be set for different operation modes.
		Operation lock	Use to lock selected functions. • The locked functions cannot be operated.
	Energy saving	Auto return ^{*2}	Use to get the units to operate at the preset temperature after performing energy saving operation for a specified time period. • Time can be set to a value from 30 and 120 in 10-minute increments. (This function will not be valid when the preset temperature ranges are restricted.)
		Schedule ^{*1, *3}	Set the start/stop times to operate the units in the energy saving mode for each day of the week, and set the energy saving rate. • Up to 4 energy saving operation patterns can be set for each day. • Time can be set in 5-minute increments. • Energy saving rate can be set to a value from 0% or 50 to 90% in 10% increments.
	Energy data (for unit time, month, and day)		Displays the amount of power consumption during operation. • Unit time data: Data for the last one-month period can be displayed in 30-minute units. • Monthly/daily data: Data for the last 14-month period are displayed in day-and-month-units. * Data can be deleted. * Data are obtained based on the power consumption estimated from the operating state.

^{*1} Clock setting is required.

^{*2} 1°C increments.

^{*3} This function is available only when certain outdoor units are connected.



Main menu	Setting and display items		Setting details
Initial setting	Basic setting	Main/Sub	When connecting 2 remote controllers, one of them needs to be designated as a sub controller.
		Clock	Use to set the current time.
		Daylight saving time	Set the daylight saving time.
		Administrator password	The administrator password is required to make the settings for the following items. • Timer setting • Energy saving setting • Weekly timer setting • Restriction setting • Outdoor unit silent mode setting • Night set back
	Display setting	Main display	Use to switch between "Full" and "Basic" modes for the Main display, and use to change the background colors of the display to black.
		Display details	Make the settings for the remote controller related items as necessary. Clock: The initial settings are "Yes" and "24h" format. Temperature: Set either Celsius (°C) or Fahrenheit (°F). Room temp.: Set Show or Hide. Auto mode: Set Auto mode display or Only Auto display.
		Contrast • Brightness	Use to adjust screen contrast and brightness.
		Language selection	Use to select the desired language.
Operation setting	Auto mode	Whether or not to use Auto mode can be selected by using the button. This setting is valid only when indoor units with Auto mode function are connected.	
Maintenance	Error information		Use to check error information when an error occurs. • Check code, error source, refrigerant address, model name, manufacturing number, contact information (dealer's phone number) can be displayed. (The model name, manufacturing number, and contact information need to be registered in advance to be displayed.)
	Filter information		Use to check the filter status. • The filter sign can be reset.
	Cleaning	Auto descending panel	Use to lift and lower the auto descending panel (Optional parts).
Service	Test run		Select "Test run" from the Service menu to bring up the Test run menu. • Test run • Drain pump test run
	Input maintenance info.		Select "Input maintenance Info." from the Service menu to bring up the Maintenance information screen. The following settings can be made from the Maintenance Information screen. • Model name input • Serial No. input • Dealer information input • Initialize maintenance info.
	Settings	Function setting	Make the settings for the indoor unit functions via the remote controller as necessary.
	Check	Error history	Display the error history and execute "delete error history".
		Diagnosis	Self check: Error history of each unit can be checked via the remote controller. Remote controller check: When the remote controller does not work properly, use the remote controller checking function to troubleshoot the problem.
		Smooth maintenance * ³	Use to display the maintenance data of indoor/outdoor units.
		Request code * ³	Use to check operation data such as thermistor temperature and error information.
	Others	Maintenance password	Use to change the maintenance password.
		Initialize remote controller	Use to initialize the remote controller to the factory shipment status.
Remote controller information		Use to display the remote controller model name, software version, and serial number.	

*³ This function is available only when certain outdoor units are connected.

<PAR-SL97A-E>

Controller interface

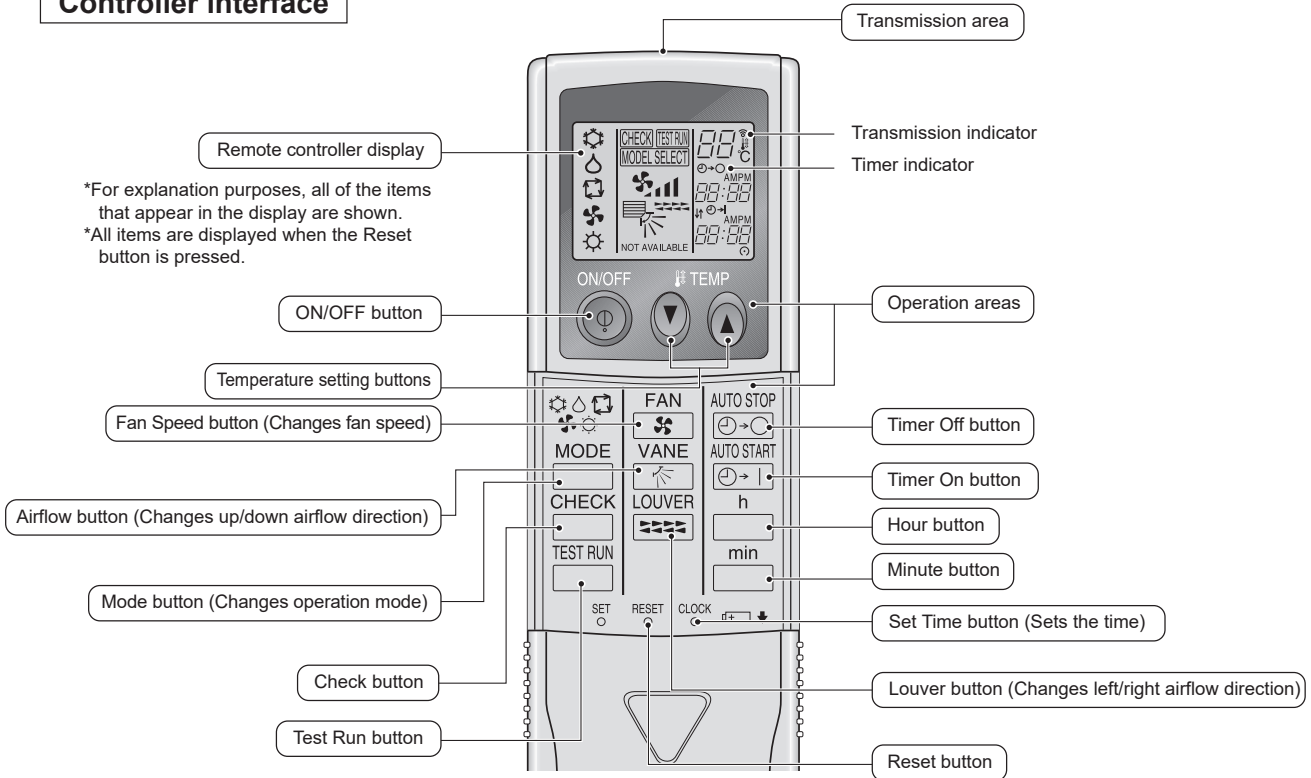

- When using the wireless remote controller, point it towards the receiver on the indoor unit.
- If the remote controller is operated within approximately two minutes after power is supplied to the indoor unit, the indoor unit may beep twice as the unit is performing the initial automatic check.
- The indoor unit beeps to confirm that the signal transmitted from the remote controller has been received. Signals can be received up to approximately 7 meters in a direct line from the indoor unit in an area 45° to the left and right of the unit. However, illumination such as fluorescent lights and strong light can affect the ability of the indoor unit to receive signals.
- If the operation lamp near the receiver on the indoor unit is blinking, the unit needs to be inspected. Consult your dealer for service.
- Handle the remote controller carefully! Do not drop the remote controller or subject it to strong shocks. In addition, do not get the remote controller wet or leave it in a location with high humidity.
- To avoid misplacing the remote controller, install the holder included with the remote controller on a wall and be sure to always place the remote controller in the holder after use.



<PAR-SL101A-E>

Controller interface

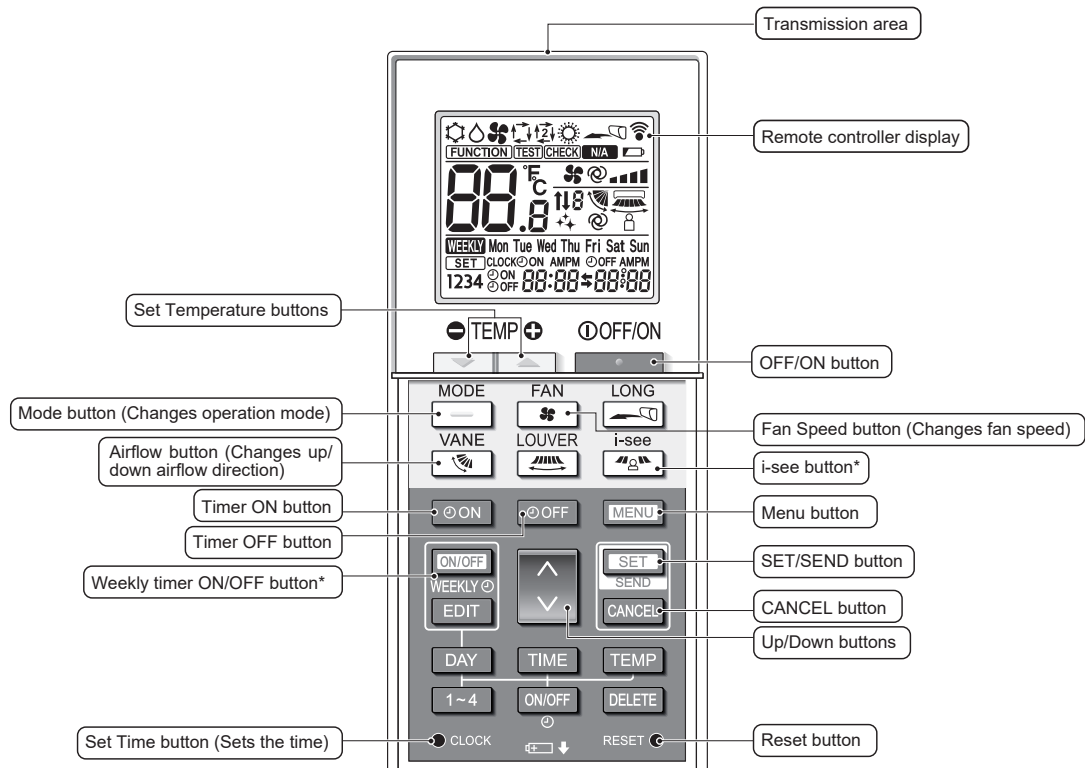

Note:
 * This button is enabled or disabled depending on the model of the indoor unit.

Display

Operation mode

	Cool		Dry
	Fan		Auto (single set point)
	Heat		Auto (dual set point)

Temperature setting
 The units of temperature can be changed. For details, refer to the Installation Manual.

Vane setting

Step 1 Step 2 Step 3 Step 4 Step 5 Swing Auto

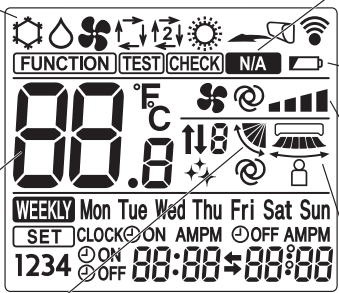

Not available
 Appears when a non-supported function is selected.

Battery replacement indicator
 Appears when the remaining battery power is low.

Fan speed setting

Auto

3D i-See sensor (Air distribution)

Default Direct Indirect

When Direct or Indirect is selected, the vane setting is set to "Auto".

13-2. ERROR INFORMATION

**When an error occurs, the following screen will appear.
Check the error status, stop the operation, and consult your dealer.**

1. Check code, error unit, refrigerant address, date and time of occurrence, model name, and serial number will appear.
The model name and serial number will appear only if the information have been registered.

Press the **[F1]** or **[F2]** button to go to the next page.

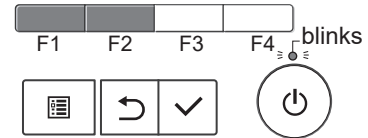
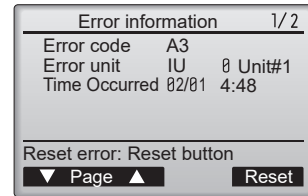

Contact information (dealer's phone number) will appear if the information has been registered.

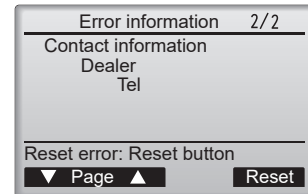

2. Press the **[F4]** button or the  button to reset the error that is occurring.

Errors cannot be reset while the ON/OFF operation is prohibited.

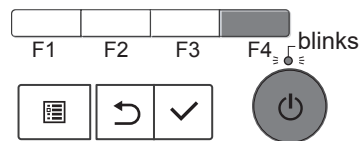
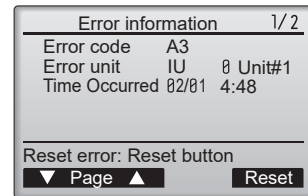

Select "OK" with the **[F4]** button.

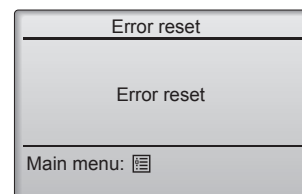
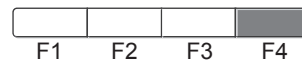
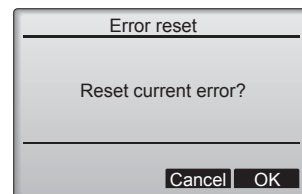

Navigating through the screens

- To go back to the Service menu  button

• Checking the error information

While no errors are occurring, page 2/2 of the error information can be viewed by selecting "Error information" from the Maintenance menu. Errors cannot be reset from this screen.

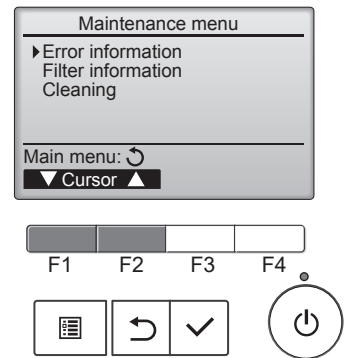

13-3. SERVICE MENU

Maintenance password is required

1. Select "Service" from the Main menu, and press the [✓] button.

*At the main display, the menu button and select "Service" to make the maintenance setting.

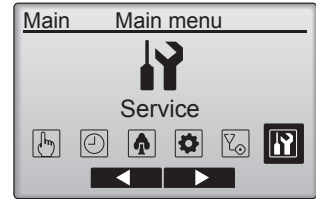

2. When the Service menu is selected, a window will appear asking for the password.

To enter the current maintenance password (4 numerical digits), move the cursor to the digit you want to change with the [F1] or [F2] button.



Set each number (0 through 9) with the [F3] or [F4] button.



Then, press the [✓] button.

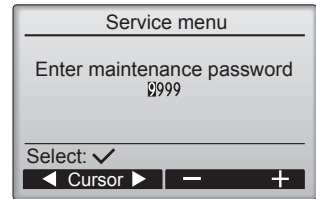

Note: The initial maintenance password is "9999". Change the default password as necessary to prevent unauthorized access. Have the password available for those who need it.

If you forget your maintenance password, you can initialize the password to the default password "9999" by pressing and holding the [F1] button for 10 seconds on the maintenance password setting screen.

3. If the password matches, the Service menu will appear.

The type of menu that appears depends on the connected indoor units' type.

Note: Air conditioning units may need to be stopped to make only at "Settings". There may be some settings that cannot be made when the system is centrally controlled.



A screen will appear that indicates the setting has been saved.

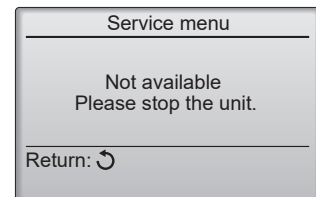
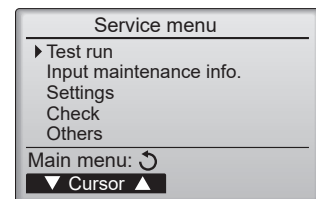

Navigating through the screens

- To go back to the Service menu[] button
- To return to the previous screen.....[] button

13-4. TEST RUN

13-4-1. PAR-41MAA

1. Select "Service" from the Main menu, and press the [✓] button.



Select "Test run" with the [F1] or [F2] button, and press the [✓] button.

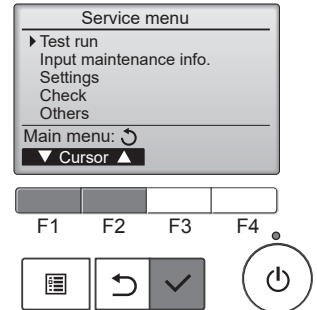

2. Select "Test run" with the [F1] or [F2] button, and press the [✓] button.

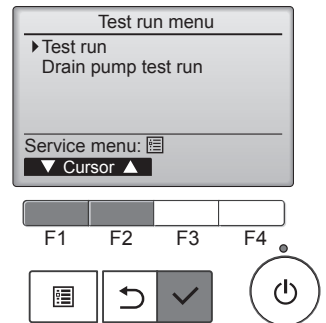

Test run operation

Press the [F1] button to go through the operation modes in the order of "Cool and Heat".

Cool mode: Check the cold air blows out.
Heat mode: Check the heat blows out.

Check the operation of the outdoor unit's fan.



Press the [✓] button and open the Vane setting screen.

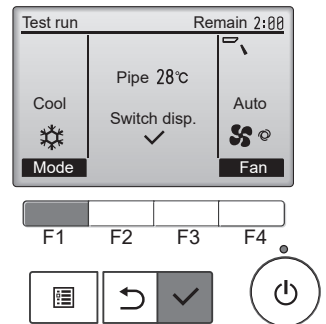

Auto vane check

Check the auto vane with the [F1] [F2] [F3] buttons.



Press the [↶] button to return to "Test run operation".



Press the [⏻] button.





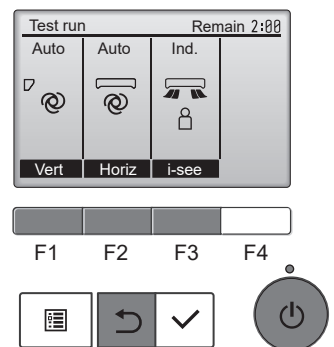





When the test run is completed, the "Test run menu" screen will appear.
The test run will automatically stop after 2 hours.

*The function is available only for the model with vanes.



13-4-2. PAR-SL97A-E

Measure an impedance between the power supply terminal block on the outdoor unit and ground with a 500 V Megger and check that it is equal to or greater than 1.0 MΩ.







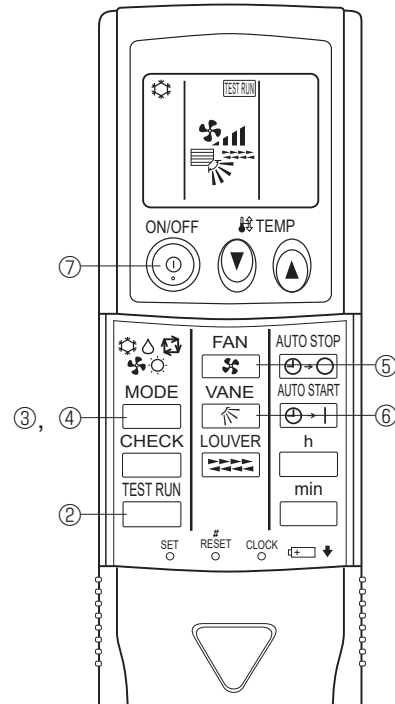







1. Turn on the main power to the unit.
2. Press the  button twice continuously.
(Start this operation from the status of remote controller display turned off.)
A  and current operation mode are displayed.
3. Press the  () to activate  mode, then check whether cool air blows out from the unit.
4. Press the  () to activate  mode, then check whether warm air blows out from the unit.
5. Press the  button and check whether strong air blows out from the unit.
6. Press the  button and check whether the auto vane operates properly.
7. Press the ON/OFF button to stop the test run.

Note:

- Point the remote controller towards the indoor unit receiver while following steps 2 to 7.
- It is not possible to run in FAN, DRY or AUTO mode.



13-4-3. PAR-SL101A-E

1. Press the  button ① to stop the air conditioner.
 - If the weekly timer is enabled ( is on), press the  button ③ to disable it ( is off).
2. Press the  button ② for 5 seconds.
 -  comes on and the unit enters the service mode.
3. Press the  button ②.
 -  ④ comes on and the unit enters the test run mode.
4. Press the following buttons to start the test run.
 - : Switch the operation mode between cooling and heating and start the test run.
 - : Switch the fan speed and start the test run.
 - : Switch the airflow direction and start the test run.
 - : Switch the louver and start the test run.
 - : Start the test run.
5. Stop the test run.
 - Press the  button ① to stop the test run.
 - After 2 hours, the stop signal is transmitted.

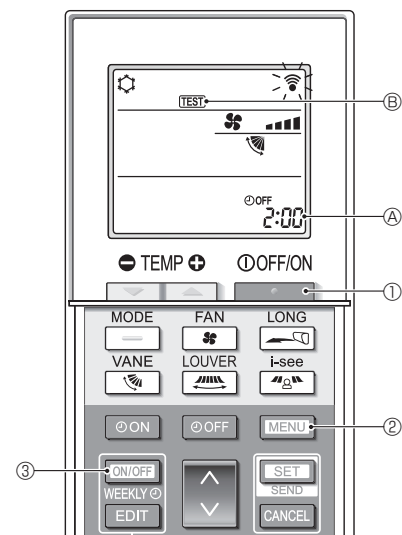

13-5. FUNCTION SETTING

13-5-1. PAR-41MAA

1. Select "Service" from the Main menu, and press the [✓] button.



Select "Setting" from the Service menu, and press the [✓] button.



Select "Function setting", and press the [✓] button.

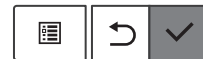
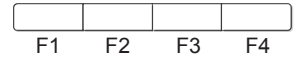
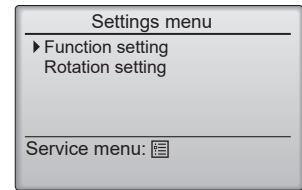

<The display format and the setting method vary with indoor units.>

Pattern 1

2. Set the indoor unit refrigerant addresses and unit numbers with the [F1] through [F4] buttons, and then press the [✓] button to confirm the current setting.
3. When data collection from the indoor units is completed, the current settings appears highlighted. Non-highlighted items indicate that no function settings are made. Screen appearance varies depending on the "Unit No." setting.

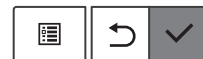
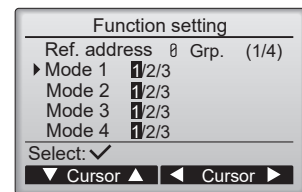

4. Use the [F1] or [F2] button to move the cursor to select the mode number, and change the setting number with the [F3] or [F4] button.
5. When the settings are completed, press the [✓] button to send the setting data from the remote controller to the indoor units.
6. When the transmission is successfully completed, the screen will return to the Function setting screen.

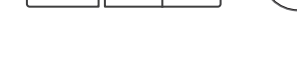
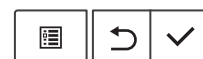
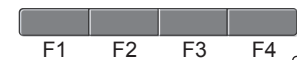
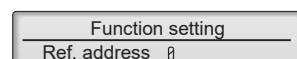
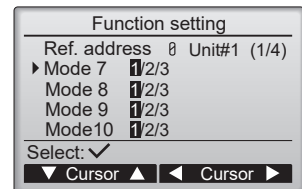

Pattern 2

4. Toggle through the pages with the **[F3]** or **[F4]** button.
5. Select the mode number with the **[F1]** or **[F2]** button, and then press the **[✓]** button.
6. Select the setting number with the **[F1]** or **[F2]** button.
Setting range for modes 1 through 28: 1 through 3
Setting range for modes 31 through 66: 1 through 15
7. When the settings are completed, press the **[✓]** button to send the setting data from the remote controller to the indoor units.
8. When the transmission is successfully completed, the screen will return to the Function setting screen.

Note:

- Make the function settings refer to 10-1 <Table 1> on Mr. SLIM units as necessary.
- Refer to 10-1 <Table 1> summarizes the setting options for each mode number. Refer to the indoor unit Installation Manual for the detailed information about initial settings, mode numbers, and setting numbers for the indoor units.
- Be sure to write down the settings for all functions if any of the initial settings has been changed after the completion of installation work.

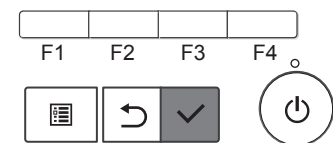
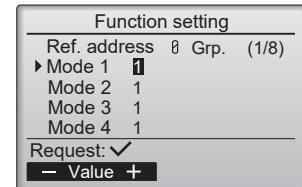
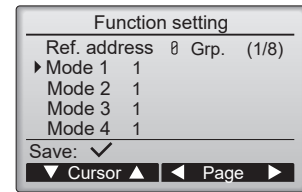

13-5-2. PAR-SL97A-E

Functions can be selected with the wireless remote controller. Function selection using wireless remote controller is available only for refrigerant system with wireless function. Refrigerant address cannot be specified by the wireless remote controller.

[Flow of function selection procedure]

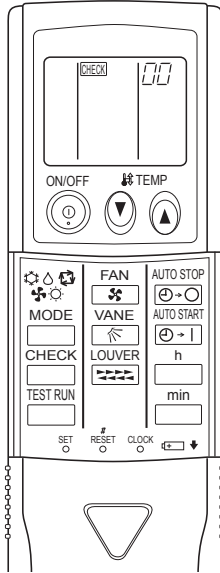

The flow of the function selection procedure is shown below. This example shows how to turn off the function that raises the set temperature by 4 degrees during HEAT operation. (Mode 24: 2)
The procedure is given after the flow chart.

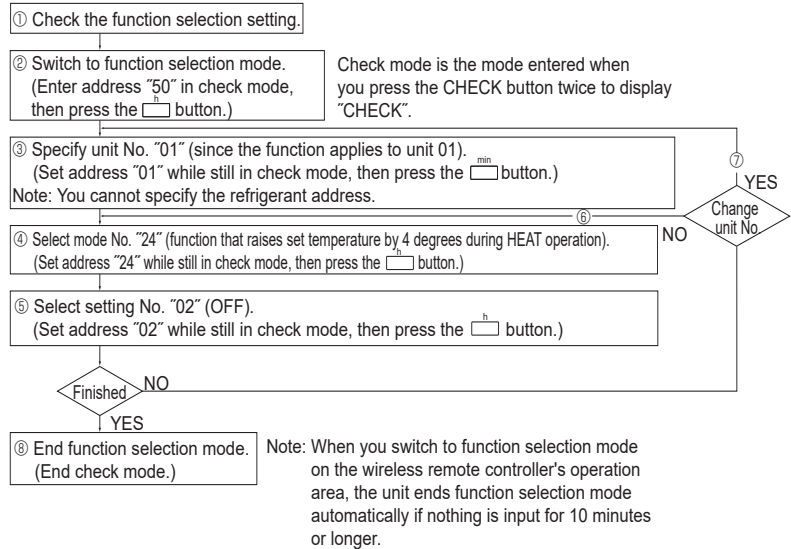

[Operating instructions]

1. Check the function settings.

2. Press the button twice continuously. → is lit and "00" blinks.

Press the button once to set "50". Direct the wireless remote controller toward the receiver of the indoor unit and press the button.

3. Set the unit number.

Press the button to set the unit number. (Press "01" to specify the indoor unit whose unit number is 01.)
Direct the wireless remote controller toward the receiver of the indoor unit and press the button.

By setting unit number with the button, specified indoor unit starts performing fan operation.
Detect which unit is assigned to which number using this function. If unit number is set to AL, all the indoor units in same refrigerant system start performing fan operation simultaneously.

Notes:

- If a unit number that cannot be recognized by the unit is entered, 3 beeps of 0.4 seconds will be heard. Reenter the unit number setting.
- If the signal was not received by the sensor, you will not hear a beep or a "double beep" may be heard. Reenter the unit number setting.

4. Select a mode.

Press the button to set a mode. Press "24" to turn on the function that raises the set temperature by 4 degrees during heat operation. Direct the wireless remote controller toward the sensor of the indoor unit and press the button.
→ The sensor-operation indicator will blink and beeps will be heard to indicate the current setting number.

Current setting number: 1 = 1 beep (1 second)
2 = 2 beeps (1 second each)
3 = 3 beeps (1 second each)

Notes:

- If a mode number that cannot be recognized by the unit is entered, 3 beeps of 0.4 seconds will be heard. Reenter the mode number.
- If the signal was not received by the sensor, you will not hear a beep or a "double beep" may be heard. Reenter the mode number.

5. Select the setting number.

Press the button to select the setting number. (02: Not available)
Direct the wireless remote controller toward the receiver of the indoor unit and press the button.
→ The sensor-operation indicator will blink and beeps will be heard to indicate the setting number.

Setting number: 1 = 2 beeps (0.4 seconds each)
2 = 2 beeps (0.4 seconds each, repeated twice)
3 = 2 beeps (0.4 seconds each, repeated 3 times)

Notes:

- If a setting number that cannot be recognized by the unit is entered, the setting will turn back to the original setting.
 - If the signal was not received by the sensor, you will not hear a beep or a "double beep" may be heard. Reenter the setting number.
6. Repeat steps ④ and ⑤ to make an additional setting without changing unit number.
7. Repeat steps ③ to ⑤ to change unit number and make function settings on it.
8. Complete the function settings

Press button.

Do not use the wireless remote controller for 30 seconds after completing the function setting.

13-5-3. PAR-SL101A-E

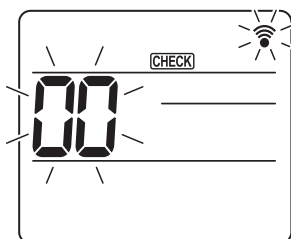

Fig. 1

1. Going to the function select mode

Press the **MENU** button between of 5 seconds.

(Start this operation from the status of remote controller display turned off.)

[CHECK] is lit and "00" blinks. (Fig. 1)

Press the **DOWN** button to set the "50".

Direct the wireless remote controller toward the receiver of the indoor unit and press the **SET** button.

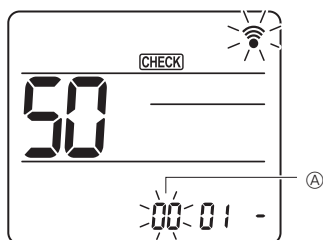

Fig. 2

2. Setting the unit number

Press the **DOWN** button to set unit number **A**. (Fig. 2)

Direct the wireless remote controller toward the receiver of the indoor unit and press the **SET** button.

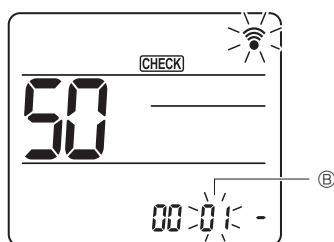

Fig. 3

3. Select a mode

Press the **DOWN** button to set Mode number **B**. (Fig. 3)

Direct the wireless remote controller toward the receiver of the indoor unit and press the **SET** button.

Current setting number:

1=1 beep (1 second)

2=2 beep (1 second each)

3=3 beep (1 second each)

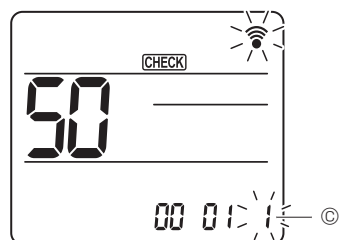

Fig. 4

4. Selecting the setting number

Use the **DOWN** button to change the Setting number **C**. (Fig. 4)

Direct the wireless remote controller toward the receiver of the indoor unit and press the **SET** button.

5. To select multiple functions continuously

Repeat select **3** and **4** to change multiple function settings continuously.

6. Complete function selection

Direct the wireless remote controller toward the sensor of the indoor unit and press the **OFF/ON** button.

Note: Be sure to write down the settings for all functions if any of the initial settings has been changed after the completion of installation work.

13-6. ROTATION SETTING

Setting method of each function by wired remote controller

■ PAR-41MAA

1. Stop operation 

Select "Service" from the Main menu, and press the [✓] button.

Select "Settings" with the [F1] or [F2] button, and press the [✓] button.

Select "Rotation setting" with the [F1] or [F2] button, and press the [✓] button.

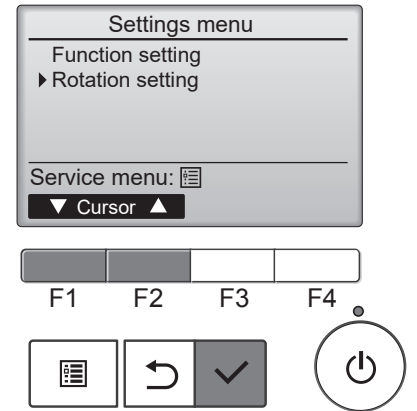

2. Set the rotation function.

Select "Rotation" with the [F1] button.

Select the rotation period or "Backup only" with the [F2] or [F3] button.

■ "Rotation" setup

None, 1 day, 3 days, 5 days, 7 days, 14 days, 28days, Backup only

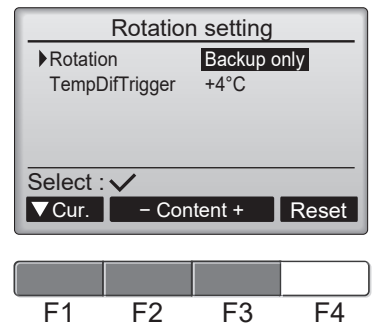

Notes:

- When 1 to 28 days are selected, the backup function is also enabled.
- When "Backup only" is selected, the rotation function will be disabled. The systems with refrigerant addresses of 00 or 01 (00 system/ 01 system) will be operated as a main system while the 02 system is the standby mode as backup.

3. Set the support function.

Select "TempDifTrigger" with the [F1] button.

Select "the difference between the suction temperature and the set temperature" with the [F2] or [F3] button.

■ "TempDifTrigger" setup

None, +4°C, +6°C, +8°C

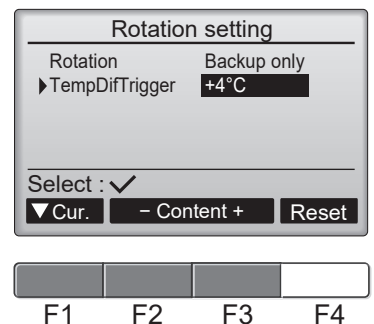

Notes:

- The support function is available only in the COOL mode. (Not available in the HEAT, DRY and AUTO mode.)
- The support function is enabled when any option other than "None" is selected from the "Rotation" setup.

4. Update the setting.

Press the [✓] button to update the setting.

Reset method

- Press the [F4] button in step ⑤ or ⑥ to reset the operation time of the rotation function. Once it is reset, operation will start from the 00 or 01 systems.

Note: When the 02 system is in the backup operation, the 00 or 01 systems will be operated again.

13-7. ERROR HISTORY

1. Select "Service" from the Main menu, and press the [✓] button.



Select "Check" with the [F1] or [F2] button, and press the [✓] button.



Select "Error history" with the [F1] or [F2] button, and press the [✓] button.

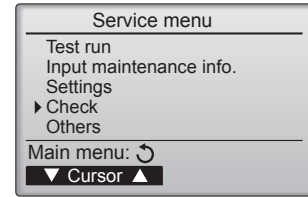

2. Select "Error history" from the Error history menu, and press the [✓] button.

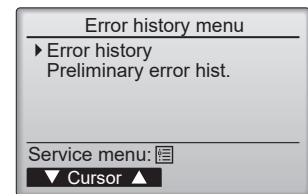

3. 16 error history records will appear.

4 records are shown per page, and the top record on the first page indicates the latest error record.

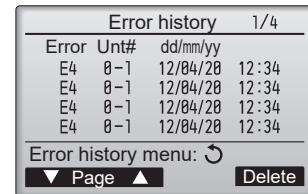

4. Deleting the error history

To delete the error history, press the [F4] button (Delete) on the screen that shows error history.
A confirmation screen will appear asking if you want to delete the error history.



Press the [F4] button (OK) to delete the history.



"Error history deleted" will appear on the screen.

Press the [↻] button to go back to the Error history menu screen.

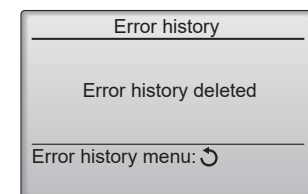
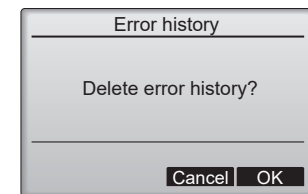

5. Preliminary error history

Select "Preliminary error hist." from the Error history menu, and press the [✓] button.

32 preliminary error history records will appear.

4 records are shown per page, and the top record on the first page indicates the latest error record.

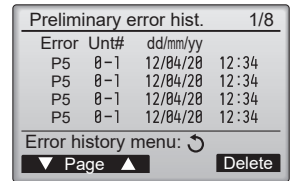

Preliminary error hist. 1/8			
Error	Unt#	dd/mm/yy	
P5	0-1	12/04/20	12:34
P5	0-1	12/04/20	12:34
P5	0-1	12/04/20	12:34
P5	0-1	12/04/20	12:34

Error history menu: ↻
▼ Page ▲ Delete

6. Deleting the preliminary error history

To delete the preliminary error history, press the [F4] button (Delete) on the screen that shows preliminary error history.

A confirmation screen will appear asking if you want to delete the preliminary error history.



Press the [F4] button (OK) to delete the preliminary error history.



"Preliminary error history deleted" will appear on the screen.

Press the [↻] button to go back to the Error history menu.

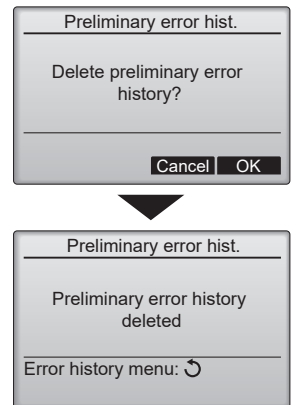

13-8. SELF-DIAGNOSIS

13-8-1. PAR-41MAA

1. Select "Service" from the Main menu, and press the [✓] button.

Select "Check" from the Service menu, and press the [✓] button.

Select "Diagnosis" from the Check menu, and press the [✓] button.

Select "Self check" with the [F1] or [F2] button, and press the [✓] button.

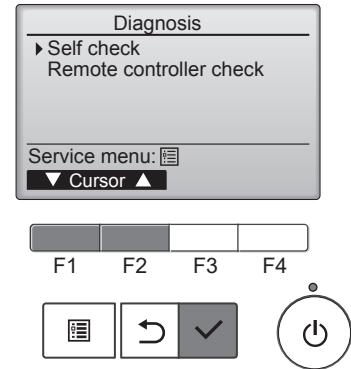

2. With the [F1] or [F2] button, enter the refrigerant address, and press the [✓] button.

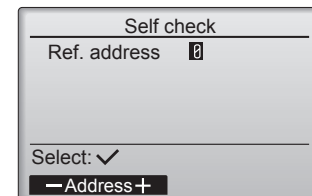

3. Check code, unit number, attribute will appear. "-" will appear if no error history is available.

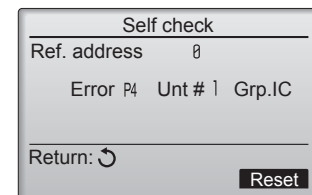

When there is no error history

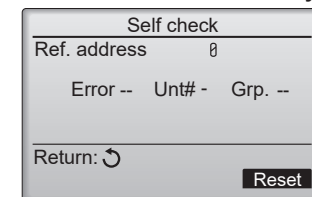

4. Resetting the error history

Press the [F4] button (Reset) on the screen that shows the error history.



A confirmation screen will appear asking if you want to delete the error history.

Press the [F4] button (OK) to delete the error history.

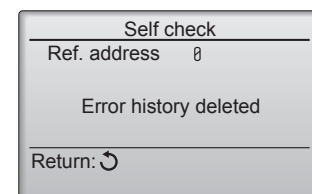
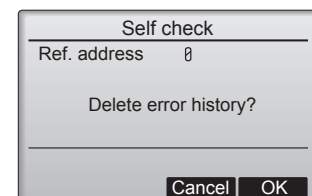
If deletion fails, "Request rejected" will appear. "Unit not exist" will appear if no indoor units that are correspond to the entered address are found.



Navigating through the screens

- To go back to the Service menu [] button
- To return to the previous screen..... [] button

13-8-2. PAR-SL97A-E

When a malfunction occurs to air conditioner, both indoor unit and outdoor unit will stop and operation lamp blinks to inform unusual stop.

<Malfunction-diagnosis method at maintenance service>

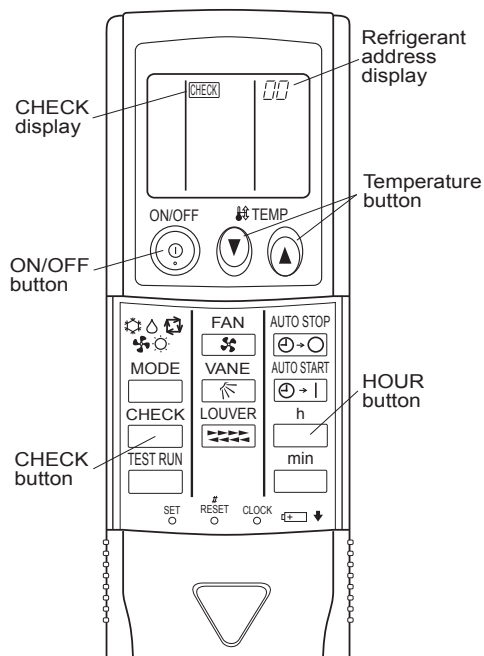

[Procedure]

1. Press the CHECK button twice.
 - "CHECK" lights, and refrigerant address "00" blinks.
 - Check that the remote controller's display has stopped before continuing.
2. Press the TEMP \uparrow \downarrow buttons.
 - Select the refrigerant address of the indoor unit for the self-diagnosis.
 - Note: Set refrigerant address using the outdoor unit's DIP switch (SW1). (For more information, see the outdoor unit installation manual.)
3. Point the remote controller at the sensor on the indoor unit and press the HOUR button.
 - If an air conditioner error occurs, the indoor unit's sensor emits an intermittent buzzer sound, the operation light blinks, and the check code is output. (It takes 3 seconds at most for check code to appear.)
4. Point the remote controller at the sensor on the indoor unit and press the ON/OFF button.
 - The check mode is cancelled.

13-8-3. PAR-SL101A-E

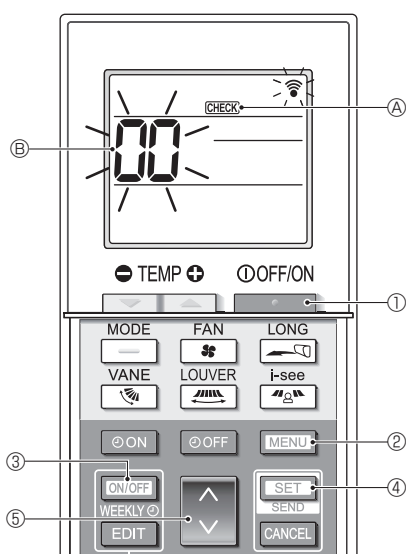

[Procedure]

1. Press the \ominus button ① to stop the air conditioner.
 - If the weekly timer is enabled (WEEKLY is on), press the ON/OFF WEEKLY button ③ to disable it (WEEKLY is off).
2. Press the MENU button ② for 5 seconds.
 - CHECK ④ comes on and the unit enters the self-check mode.
3. Press the \downarrow button ⑤ to select the refrigerant address (M-NET address) ⑥ of the indoor unit for which you want to perform the self-check.
4. Press the SET button ④.
 - If an error is detected, the check code is indicated by the number of beeps from the indoor unit and the number of blinks of the OPERATION INDICATOR lamp.
5. Press the \ominus button ①.
 - CHECK ④ and the refrigerant address (M-NET address) ⑥ go off and the self-check is completed.

13-9. REMOTE CONTROLLER CHECK

If operations cannot be completed with the remote controller, diagnose the remote controller with this function.

1. Select "Service" from the Main menu, and press the [✓] button.



Select "Check" from the Service menu, and press the [✓] button.



Select "Diagnosis" from the Check menu, and press the [✓] button.



Select "Remote controller check" with the [F1] or [F2] button, and press the [✓] button.

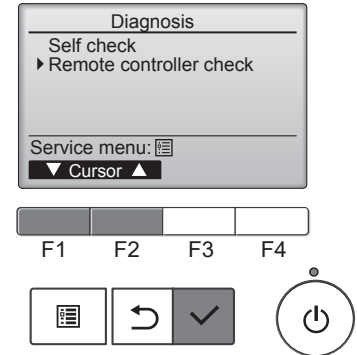

2. Select "Remote controller check" from the Diagnosis menu, and press the [✓] button to start the remote controller check and see the check results.



To cancel the remote controller check and exit the "Remote controller check" menu screen, press the [⌂] or the [↶] button.



The remote controller will not reboot itself.

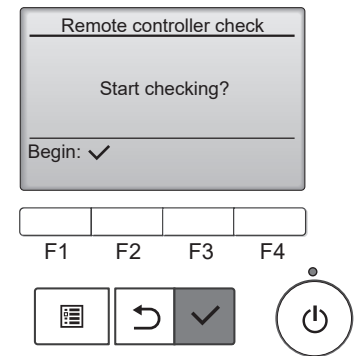

3.
 - OK: No problems are found with the remote controller. Check other parts for problems.
 - E3, 6832: There is noise on the transmission line, or the indoor unit or another remote controller is faulty. Check the transmission line and the other remote controllers.
 - NG (ALLO, ALL1): Send-receive circuit fault. The remote controller needs replacing.
 - ERC: The number of data errors is the discrepancy between the number of bits in the data transmitted from the remote controller and that of the data that was actually transmitted over the transmission line. If data errors are found, check the transmission line for external noise interference.



If the [✓] button is pressed after the remote controller check results are displayed, remote controller check will end, and the remote controller will automatically reboot itself.

Remote controller check results screen

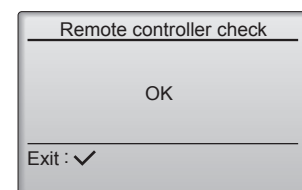

Check the remote controller display and see if anything is displayed (including lines). Nothing will appear on the remote controller display if the correct voltage (8.5–12 VDC) is not supplied to the remote controller. If this is the case, check the remote controller wiring and indoor units.

13-10. SMOOTH MAINTENANCE

1. Select "Service" from the Main menu, and press the [✓] button.



Select "Check" with the [F1] or [F2] button, and press the [✓] button.



Select "Smooth maintenance" with the [F1] or [F2] button, and press the [✓] button.

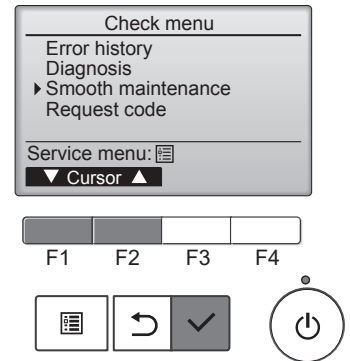

2. Set each item.

Select the item to be changed with the [F1] or [F2] button.

Select the required setting with the [F3] or [F4] button.

- <Ref.address> setting [0] – [15]
- <Stable mode> setting [Cool] / [Heat] / [Normal]

Press the [✓] button, Fixed operation will start.

Note: Stable mode will take approx. 20 minutes.

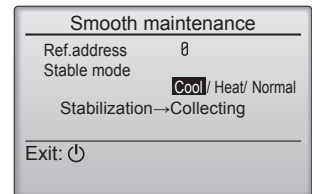
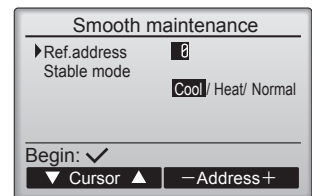

3. The operation data will appear.

The Compressor-Accumulated operating (COMP. run) time is 10-hour unit, and the Compressor-Number of operation times (COMP. ON/OFF) is a 100-time unit (fractions discarded).

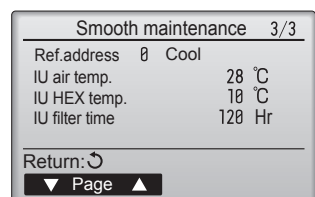
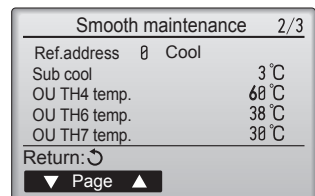
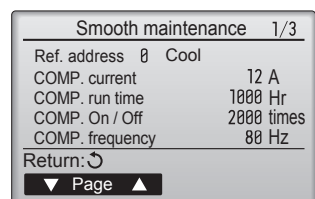

Navigating through the screens

- To go back to the Service menu [Menu] button
- To return to the previous screen..... [Back] button

■ Refrigerant address

Single refrigerant system

In the case of single refrigerant system, the refrigerant address is "00" and no operation is required.

Simultaneous twin, triple units belong to this category (single refrigerant system).

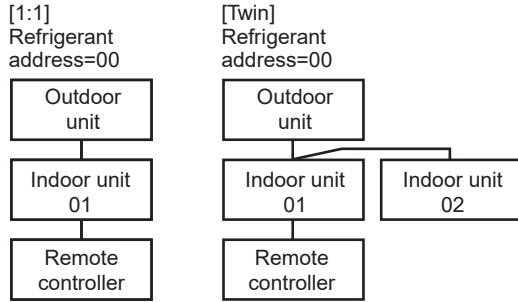

Multi refrigerant system (group control)

Up to 16 refrigerant systems (16 outdoor units) can be connected as a group by 1 remote controller. To check or set the refrigerant addresses.

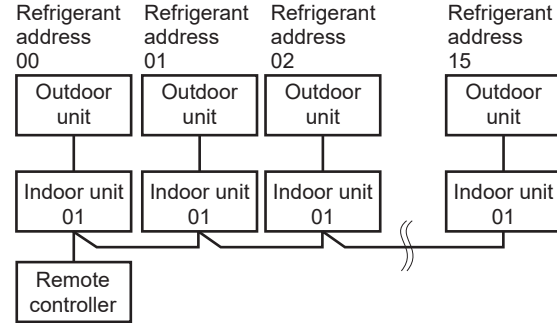

13-11. REQUEST CODE

Details on the operation data including each thermistor temperature and error history can be confirmed with the remote controller.

1. Select "Service" from the Main menu, and press the [✓] button.

Select "Check" with the [F1] or [F2] button, and press the [✓] button.

Select "Request code" with the [F1] or [F2] button, and press the [✓] button.

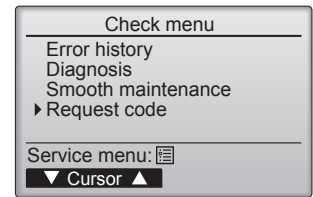

2. Set the Refrigerant address and Request code.

Select the item to be changed with the [F1] or [F2] button.

Select the required setting with the [F3] or [F4] button.

- <Ref.address>setting [0] – [15]
- <Request code>setting

Press the [✓] button, Data will be collected and displayed.

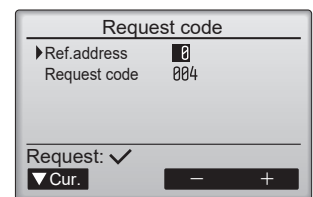

Request code: 004
Discharge temperature: 69°C

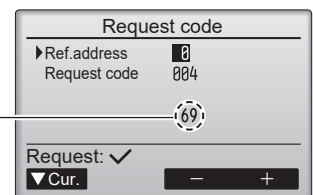



Mr. SLIM

mitsubishi electric corporation
HEAD OFFICE: TOKYO BUILDING, 2-7-3, MARUNOUCHI, CHIYODA-KU, TOKYO 100-8310, JAPAN