

AIR CONDITIONING SYSTEMS

CITY MULTI



DATA BOOK

MODEL

PURY-M200-1000Y(S)XM-A(-BS)



R32 refrigerant is mildly flammable, and certain restrictions apply to the installation of units.

When installing new units, moving the existing units, or changing the layout of the room, ensure that installation restrictions are observed.

For details, refer to R32 City Multi Technical Manual (System Design and General Safety Considerations) and Installation Manual.

Line-up of Outdoor Units of R32 CITY MULTI
Heat Recovery R2-Series



PURY-M200YXM-A(-BS)
PURY-M300YXM-A(-BS)

PURY-M250YXM-A(-BS)

8, 10, 12HP



PURY-M350YXM-A(-BS)
PURY-M450YXM-A(-BS)

PURY-M400YXM-A(-BS)
PURY-M500YXM-A(-BS)

14, 16, 18, 20HP



PURY-M400YSXM-A(-BS)
PURY-M500YSXM-A(-BS)
PURY-M600YSXM-A(-BS)

PURY-M450YSXM-A(-BS)
PURY-M550YSXM-A(-BS)

16, 18, 20, 22, 24HP



PURY-M650YSXM-A(-BS)

26HP



PURY-M700YSXM-A(-BS)
PURY-M800YSXM-A(-BS)
PURY-M900YSXM-A(-BS)
PURY-M1000YSXM-A(-BS)

PURY-M750YSXM-A(-BS)
PURY-M850YSXM-A(-BS)
PURY-M950YSXM-A(-BS)

28, 30, 32, 34, 36, 38, 40HP

PURY-M-Y(S)XM-A

1. SPECIFICATIONS	2
2. EXTERNAL DIMENSIONS	22
3. CENTER OF GRAVITY	29
4. ELECTRICAL WIRING DIAGRAMS	30
5. SOUND LEVELS	32
5-1. Sound levels in cooling mode (Sound pressure level)	32
5-2. Sound levels in heating mode (Sound pressure level)	37
5-3. Sound levels in cooling mode (Sound power level)	42
5-4. Sound levels in heating mode (Sound power level).....	46
6. VIBRATION LEVEL	50
7. OPERATION TEMPERATURE RANGE	51
8. CAPACITY TABLES	52
8-1. Selection of Cooling/Heating Units	52
8-2. Correction by temperature	58
8-3. Correction by total indoor units	135
8-4. Correction by refrigerant piping length.....	146
8-5. Correction by port counts of the BC controller	150
8-6. Correction at frost and defrost	150
8-7. Correction at evaporation-temperature (ET) control	150
9. OPTIONAL PARTS.....	151
9-1. JOINT and REDUCER.....	151
9-2. OUTDOOR TWINNING KIT.....	154
9-3. JOINT KIT "CMY-R170M-E" FOR BC CONTROLLER.....	155
9-4. FIN GUARD.....	156
10.ELECTRICAL WORK	157
10-1.General cautions	157
10-2.Power supply for Outdoor unit.....	158
10-3.Power cable specifications	159
10-4.Power supply examples.....	160
11.M-NET CONTROL	162
11-1.Transmission cable specifications	162
11-2.System configuration restrictions.....	163
11-3.Address setting.....	166
12.PIPING DESIGN	171
12-1.R32 Piping material	171
12-2.Piping Design	173
12-3.Refrigerant charging calculation	180
13.OUTDOOR INSTALLATION	182
13-1.General requirements for installation.....	182
13-2.Spacing.....	183
13-3.Piping direction	186
13-4.Weather countermeasure	191
13-5.Countermeasure to wind	191
14.NOTES ON UNIT SELECTION	192
14-1.Indoor unit 200% connection	192

Outdoor Model		PURY-M200YXM-A(-BS)	
Power source		3-phase 4-wire 380-400-415V 50Hz	
Cooling capacity (Nominal)	*1	kW	22.4
		BTU/h	76,400
		Power input kW	5.53
		Current input A	9.3-8.8-8.5
		EER	4.05
	SEER	kW/kW	7.72
Temp. range of cooling	*4	Indoor	W.B.
		Outdoor	D.B.
Heating capacity (Max)		*2	kW
			BTU/h
			Power input kW
			Current input A
			COP
(Nominal)		*3	kW
			BTU/h
			Power input kW
			Current input A
			COP
			SCOP
Temp. range of heating	*4	Indoor	D.B.
		Outdoor	W.B.
Indoor unit connectable		Total capacity	
		Model/Maximum quantity	
Sound pressure level (measured in anechoic room)		*5, 6	dB <A>
Sound power level (measured in anechoic room)		*5	dB <A>
Refrigerant piping diameter		High pressure	mm (in.)
		Low pressure	mm (in.)
FAN	Type x Quantity		Propeller fan x 1
	Air flow rate		m ³ /min
			L/s
			cfm
	Control, Driving mechanism		Inverter-control, Direct-driven by motor
*7	Motor output	kW	
External static press.		0 Pa (0 mmH ₂ O)	
Compressor	Type x Quantity		Inverter scroll hermetic compressor x1
	Starting method		Inverter
		Motor output	kW
		Case heater	kW
Lubricant		MEL46EH	
External finish		Pre-coated galvanized steel sheets (+powder coating for -BS type) <MUNSELL 3Y 7.8/1.1 or similar>	
External dimension H x W x D		mm	1,858 (1,798 without legs) x 910 x 740
		in.	73-3/16 (70-13/16 without legs) x 35-7/8 x 29-3/16
Protection devices	High pressure protection		High pressure sensor, High pressure switch at 4.15MPa (601psi)
	Inverter circuit (COMP./FAN)		Over-heat protection, Over-current protection
	Compressor		-
	Fan motor		-
Refrigerant	Type x original charge		R32 x 8.0kg (18lbs)
	Control		Indoor LEV and BC controller
Net weight		kg (lbs)	265 (585)
Heat exchanger		Salt-resistant cross fin & copper tube	
HIC circuit (HIC: Heat Inter-Changer)		-	
Defrosting method		Auto-defrost mode (Reversed refrigerant cycle, Liquid backless refrigerant cycle)	
Drawing	External	KB94CANT	
	Wiring	KE94L612	
Standard attachment	Document	Installation Manual	
	Accessory	-	
Optional parts	Joint		CMY-Y102SS-G2, CMY-Y102LS-G2, CMY-R170M-E
	Main BC controller		CMB-M104/106/108/1012V-MA-SV(-TR)
	Sub BC controller		CMB-M104/108V-MB-SV(-TR)
Remarks		Details on foundation work, duct work, insulation work, electrical wiring, power source switch, and other items shall be referred to the Installation Manual. Due to continuing improvement, above specifications may be subject to change without notice.	

Notes:	Unit converter
1.Nominal cooling conditions Indoor: 27°CDB./19°CWB. (81°FDB./66°FWB.), Outdoor: 35°CDB./24°CWB. (95°FDB./75°FWB.) (subject to EN 14511-2) Pipe length: 7.5 m (24-9/16 ft.), Level difference: 0 m (0 ft.) (subject to EN 14511-3)	BTU/h =kW x 3,412 cfm =m ³ /min x 35.31 lbs =kg/0.4536
2.Max heating conditions Indoor: 20°CDB. (68°FDB.), Outdoor: 7°CDB./6°CWB. (45°FDB./43°FWB.) (subject to EN 14511-2) Pipe length: 7.5 m (24-9/16 ft.), Level difference: 0 m (0 ft.) (subject to EN 14511-3)	
3.Nominal heating conditions Indoor: 20°CDB. (68°FDB.), Outdoor: 7°CDB./6°CWB. (45°FDB./43°FWB.) (subject to EN 14511-2) Pipe length: 7.5 m (24-9/16 ft.), Level difference: 0 m (0 ft.) (subject to EN 14511-3) Eurovent registered	
4.-10 °CDB.(14 °FDB.)/-11 °CWB.(12 °FWB.) to 21 °CDB.(70 °FDB.)/15.5 °CWB.(60 °FWB.) with cooling/heating mixed operation.	
5.Cooling mode/Heating mode	
6.The sound pressure level measured by the conventional method in JIS for reference purpose.	
7.External static pressure option is available (30 Pa, 60 Pa, 80 Pa/3.1 mmH ₂ O, 6.1 mmH ₂ O, 8.2 mmH ₂ O). Consult your dealer about the specification when setting External static pressure option.	
	*Above specification data is subject to rounding variation.

Outdoor Model		PUR-Y-M250YXM-A(-BS)		
Power source		3-phase 4-wire 380-400-415V 50Hz		
Cooling capacity (Nominal)	*1 kW	28.0		
	BTU/h	95,500		
	Power input kW	7.79		
	Current input A	13.1-12.4-12.0		
	EER	3.59		
	SEER	7.37		
Temp. range of cooling	*4 Indoor	W.B.	15.0~24.0°C (59~75°F)	
	Outdoor	D.B.	-5.0~52.0°C (23~126°F)	
Heating capacity (Max)	*2 kW	31.5		
	BTU/h	107,500		
	Power input kW	7.79		
	Current input A	13.1-12.4-12.0		
	COP	4.04		
	(Nominal)	*3 kW	28.0	
		BTU/h	95,500	
		Power input kW	6.43	
		Current input A	10.8-10.3-9.9	
		COP	4.35	
	SCOP	4.66		
Temp. range of heating	*4 Indoor	D.B.	15.0~27.0°C (59~81°F)	
	Outdoor	W.B.	-25.0~15.5°C (-13~60°F)	
Indoor unit connectable	Total capacity		50~150% of outdoor unit capacity	
	Model/Maximum quantity		M10~M250/18	
Sound pressure level (measured in anechoic room)	*5, 6	dB <A>	56.0/58.0	
Sound power level (measured in anechoic room)	*5	dB <A>	78/79	
Refrigerant piping diameter	High pressure	mm (in.)	19.05 (3/4) Brazed	
	Low pressure	mm (in.)	22.2 (7/8) Brazed	
FAN	Type x Quantity		Propeller fan x 1	
	Air flow rate	m ³ /min	180	
		L/s	3,000	
		cfm	6,356	
	Control, Driving mechanism		Inverter-control, Direct-driven by motor	
	*7 Motor output	kW	0.92 x 1	
External static press.		0 Pa (0 mmH ₂ O)		
Compressor	Type x Quantity		Inverter scroll hermetic compressor x 1	
	Starting method		Inverter	
	Motor output	kW	5.8	
	Case heater	kW	-	
	Lubricant		MEL46EH	
External finish		Pre-coated galvanized steel sheets (+powder coating for -BS type) <MUNSELL 3Y 7.8/1.1 or similar>		
External dimension H x W x D	mm	1,858 (1,798 without legs) x 910 x 740		
	in.	73-3/16 (70-13/16 without legs) x 35-7/8 x 29-3/16		
Protection devices	High pressure protection		High pressure sensor, High pressure switch at 4.15MPa (601psi)	
	Inverter circuit (COMP./FAN)		Over-heat protection, Over-current protection	
	Compressor		-	
	Fan motor		-	
Refrigerant	Type x original charge		R32 x 8.0kg (18lbs)	
	Control		Indoor LEV and BC controller	
Net weight	kg (lbs)	265 (585)		
Heat exchanger		Salt-resistant cross fin & copper tube		
HIC circuit (HIC: Heat Inter-Changer)		-		
Defrosting method		Auto-defrost mode (Reversed refrigerant cycle, Liquid backless refrigerant cycle)		
Drawing	External	KB94CANT		
	Wiring	KE94L612		
Standard attachment	Document	Installation Manual		
	Accessory	-		
Optional parts	Joint		CMY-Y102SS-G2, CMY-Y102LS-G2, CMY-R170M-E	
	Main BC controller		CMB-M104/106/108/1012V-MA-SV(-TR)	
	Sub BC controller		CMB-M104/108V-MB-SV(-TR)	
Remarks		Details on foundation work, duct work, insulation work, electrical wiring, power source switch, and other items shall be referred to the Installation Manual. Due to continuing improvement, above specifications may be subject to change without notice.		

Notes:	Unit converter
1.Nominal cooling conditions Indoor: 27°C.D.B./19°C.W.B. (81°F.D.B./66°F.W.B.), Outdoor: 35°C.D.B./24°C.W.B. (95°F.D.B./75°F.W.B.) (subject to EN 14511-2) Pipe length: 7.5 m (24-9/16 ft.), Level difference: 0 m (0 ft.) (subject to EN 14511-3)	BTU/h =kW x 3,412 cfm =m ³ /min x 35.31 lbs =kg/0.4536
2.Max heating conditions Indoor: 20°C.D.B. (68°F.D.B.), Outdoor: 7°C.D.B./6°C.W.B. (45°F.D.B./43°F.W.B.) (subject to EN 14511-2) Pipe length: 7.5 m (24-9/16 ft.), Level difference: 0 m (0 ft.) (subject to EN 14511-3)	
3.Nominal heating conditions Indoor: 20°C.D.B. (68°F.D.B.), Outdoor: 7°C.D.B./6°C.W.B. (45°F.D.B./43°F.W.B.) (subject to EN 14511-2) Pipe length: 7.5 m (24-9/16 ft.), Level difference: 0 m (0 ft.) (subject to EN 14511-3) Eurovent registered	
4.-10 °C.D.B.(14 °F.D.B.)/-11 °C.W.B.(12 °F.W.B.) to 21 °C.D.B.(70 °F.D.B.)/15.5 °C.W.B.(60 °F.W.B.) with cooling/heating mixed operation.	
5.Cooling mode/Heating mode	
6.The sound pressure level measured by the conventional method in JIS for reference purpose.	
7.External static pressure option is available (30 Pa, 60 Pa, 80 Pa/3.1 mmH ₂ O, 6.1 mmH ₂ O, 8.2 mmH ₂ O). Consult your dealer about the specification when setting External static pressure option.	*Above specification data is subject to rounding variation.

Outdoor Model		PURY-M300YXM-A(-BS)	
Power source		3-phase 4-wire 380-400-415V 50Hz	
Cooling capacity (Nominal)	*1 kW	33.5	
	BTU/h	114,300	
	Power input kW	9.43	
	Current input A	15.9-15.1-14.5	
	EER	3.55	
	SEER	7.66	
Temp. range of cooling	*4 Indoor	W.B.	15.0~24.0°C (59~75°F)
	Outdoor	D.B.	-5.0~52.0°C (23~126°F)
Heating capacity (Max)	*2 kW	37.5	
	BTU/h	128,000	
	Power input kW	9.61	
	Current input A	16.2-15.4-14.8	
	COP	3.90	
	(Nominal) kW	33.5	
	BTU/h	114,300	
	Power input kW	7.88	
	Current input A	13.3-12.6-12.1	
	COP	4.25	
	SCOP	4.66	
Temp. range of heating	*4 Indoor	D.B.	15.0~27.0°C (59~81°F)
	Outdoor	W.B.	-25.0~15.5°C (-13~60°F)
Indoor unit connectable	Total capacity	50~150% of outdoor unit capacity	
	Model/Maximum quantity	M10~M250/22	
Sound pressure level (measured in anechoic room)	*5, 6	dB <A>	60.5/63.5
Sound power level (measured in anechoic room)	*5	dB <A>	80/83
Refrigerant piping diameter	High pressure	mm (in.)	19.05 (3/4) Brazed
	Low pressure	mm (in.)	22.2 (7/8) Brazed
FAN	Type x Quantity	Propeller fan x 1	
	Air flow rate	m ³ /min	235
		L/s	3,917
		cfm	8,298
	Control, Driving mechanism	Inverter-control, Direct-driven by motor	
	*7 Motor output	kW	0.92 × 1
External static press.	0 Pa (0 mmH ₂ O)		
Compressor	Type x Quantity	Inverter scroll hermetic compressor × 1	
	Starting method	Inverter	
	Motor output	kW	7.4
	Case heater	kW	-
	Lubricant	MEL46EH	
External finish	Pre-coated galvanized steel sheets (+powder coating for -BS type) <MUNSELL 3Y 7.8/1.1 or similar>		
External dimension H x W x D	mm	1,858 (1,798 without legs) x 910 x 740	
	in.	73-3/16 (70-13/16 without legs) x 35-7/8 x 29-3/16	
Protection devices	High pressure protection	High pressure sensor, High pressure switch at 4.15MPa (601psi)	
	Inverter circuit (COMP./FAN)	Over-heat protection, Over-current protection	
	Compressor	-	
	Fan motor	-	
Refrigerant	Type x original charge	R32 x 8.0kg (18lbs)	
	Control	Indoor LEV and BC controller	
Net weight	kg (lbs)	266 (587)	
Heat exchanger	Salt-resistant cross fin & copper tube		
HIC circuit (HIC: Heat Inter-Changer)	-		
Defrosting method	Auto-defrost mode (Reversed refrigerant cycle, Liquid backless refrigerant cycle)		
Drawing	External	KB94CANT	
	Wiring	KE94L612	
Standard attachment	Document	Installation Manual	
	Accessory	-	
Optional parts	Joint	CMY-Y102SS-G2, CMY-Y102LS-G2, CMY-R170M-E	
	Main BC controller	CMB-M104/106/108/1012V-MA-SV(-TR)	
	Sub BC controller	CMB-M104/108V-MB-SV(-TR)	
Remarks	Details on foundation work, duct work, insulation work, electrical wiring, power source switch, and other items shall be referred to the Installation Manual. Due to continuing improvement, above specifications may be subject to change without notice.		

Notes:	Unit converter
1. Nominal cooling conditions Indoor: 27°C D.B./19°C W.B. (81°F D.B./66°F W.B.), Outdoor: 35°C D.B./24°C W.B. (95°F D.B./75°F W.B.) (subject to EN 14511-2) Pipe length: 7.5 m (24-9/16 ft.), Level difference: 0 m (0 ft.) (subject to EN 14511-3)	BTU/h = kW x 3,412 cfm = m ³ /min x 35.31 lbs = kg/0.4536
2. Max heating conditions Indoor: 20°C D.B. (68°F D.B.), Outdoor: 7°C D.B./6°C W.B. (45°F D.B./43°F W.B.) (subject to EN 14511-2) Pipe length: 7.5 m (24-9/16 ft.), Level difference: 0 m (0 ft.) (subject to EN 14511-3)	
3. Nominal heating conditions Indoor: 20°C D.B. (68°F D.B.), Outdoor: 7°C D.B./6°C W.B. (45°F D.B./43°F W.B.) (subject to EN 14511-2) Pipe length: 7.5 m (24-9/16 ft.), Level difference: 0 m (0 ft.) (subject to EN 14511-3) Eurovent registered	
4. -10 °C D.B. (14 °F D.B.)/-11 °C W.B. (12 °F W.B.) to 21 °C D.B. (70 °F D.B.)/15.5 °C W.B. (60 °F W.B.) with cooling/heating mixed operation.	
5. Cooling mode/Heating mode	
6. The sound pressure level measured by the conventional method in JIS for reference purpose.	
7. External static pressure option is available (30 Pa, 60 Pa, 80 Pa/3.1 mmH ₂ O, 6.1 mmH ₂ O, 8.2 mmH ₂ O). Consult your dealer about the specification when setting External static pressure option.	
	*Above specification data is subject to rounding variation.

Outdoor Model		PURY-M350YXM-A(-BS)		
Power source		3-phase 4-wire 380-400-415V 50Hz		
Cooling capacity (Nominal)	*1 kW	40.0		
	BTU/h	136,500		
	Power input kW	11.62		
	Current input A	19.6-18.6-17.9		
	EER kW/kW	3.44		
	SEER kW/kW	7.89		
Temp. range of cooling	*4 Indoor	W.B.	15.0~24.0°C (59~75°F)	
	Outdoor	D.B.	-5.0~52.0°C (23~126°F)	
Heating capacity (Max)	*2 kW	45.0		
	BTU/h	153,500		
	Power input kW	12.64		
	Current input A	21.3-20.2-19.5		
	COP	3.56		
	(Nominal)	*3 kW	40.0	
		BTU/h	136,500	
		Power input kW	10.07	
		Current input A	16.9-16.1-15.5	
		COP	3.97	
Temp. range of heating	*4 Indoor	D.B.	15.0~27.0°C (59~81°F)	
	Outdoor	W.B.	-25.0~15.5°C (-13~60°F)	
Indoor unit connectable	Total capacity		50~150% of outdoor unit capacity	
	Model/Maximum quantity		M10~M250/25	
Sound pressure level (measured in anechoic room)	*5, 6	dB <A> 57.5/63.0		
Sound power level (measured in anechoic room)	*5	dB <A> 78/82		
Refrigerant piping diameter	High pressure	mm (in.)	19.05 (3/4) Brazed	
	Low pressure	mm (in.)	28.58 (1-1/8) Brazed	
FAN	Type x Quantity		Propeller fan x 2	
	Air flow rate	m ³ /min	220	
		L/s	3,667	
		cfm	7,768	
	Control, Driving mechanism		Inverter-control, Direct-driven by motor	
	*7 Motor output	kW	0.46 x2	
	External static press.		0 Pa (0 mmH ₂ O)	
Compressor	Type x Quantity		Inverter scroll hermetic compressor x1	
	Starting method		Inverter	
	Motor output	kW	10.0	
	Case heater	kW	-	
	Lubricant		MEL46EH	
External finish		Pre-coated galvanized steel sheets (+powder coating for -BS type) <MUNSELL 3Y 7.8/1.1 or similar>		
External dimension H x W x D	mm		1,858 (1,798 without legs) x 1207 x 740	
	in.		73-3/16 (70-13/16 without legs) x 47-9/16 x 29-3/16	
Protection devices	High pressure protection		High pressure sensor, High pressure switch at 4.15MPa (601psi)	
	Inverter circuit (COMP./FAN)		Over-heat protection, Over-current protection	
	Compressor		-	
	Fan motor		-	
Refrigerant	Type x original charge		R32 x 9.3kg (21lbs)	
	Control		Indoor LEV and BC controller	
Net weight	kg (lbs)	322 (710)		
Heat exchanger		Salt-resistant cross fin & copper tube		
HIC circuit (HIC: Heat Inter-Changer)		-		
Defrosting method		Auto-defrost mode (Reversed refrigerant cycle, Liquid backless refrigerant cycle)		
Drawing	External		KB94CANU	
	Wiring		KE94L613	
Standard attachment	Document		Installation Manual	
	Accessory		-	
Optional parts	Joint		CMY-Y102SS-G2, CMY-Y102LS-G2, CMY-R170M-E	
	Main BC controller		CMB-M104/106/108/1012V-MA-SV(-TR)	
	Sub BC controller		CMB-M104/108V-MB-SV(-TR)	
Remarks		Details on foundation work, duct work, insulation work, electrical wiring, power source switch, and other items shall be referred to the Installation Manual. Due to continuing improvement, above specifications may be subject to change without notice.		

Notes:	Unit converter
1.Nominal cooling conditions Indoor: 27°C.D.B./19°C.W.B. (81°F.D.B./66°F.W.B.), Outdoor: 35°C.D.B./24°C.W.B. (95°F.D.B./75°F.W.B.) (subject to EN 14511-2) Pipe length: 7.5 m (24-9/16 ft.), Level difference: 0 m (0 ft.) (subject to EN 14511-3)	BTU/h =kW x 3,412 cfm =m ³ /min x 35.31 lbs =kg/0.4536
2.Max heating conditions Indoor: 20°C.D.B. (68°F.D.B.), Outdoor: 7°C.D.B./6°C.W.B. (45°F.D.B./43°F.W.B.) (subject to EN 14511-2) Pipe length: 7.5 m (24-9/16 ft.), Level difference: 0 m (0 ft.) (subject to EN 14511-3)	
3.Nominal heating conditions Indoor: 20°C.D.B. (68°F.D.B.), Outdoor: 7°C.D.B./6°C.W.B. (45°F.D.B./43°F.W.B.) (subject to EN 14511-2) Pipe length: 7.5 m (24-9/16 ft.), Level difference: 0 m (0 ft.) (subject to EN 14511-3) Eurovent registered	
4.-10 °C.D.B.(14 °F.D.B.)/-11 °C.W.B.(12 °F.W.B.) to 21 °C.D.B.(70 °F.D.B.)/15.5 °C.W.B.(60 °F.W.B.) with cooling/heating mixed operation.	
5.Cooling mode/Heating mode	
6.The sound pressure level measured by the conventional method in JIS for reference purpose.	
7.External static pressure option is available (30 Pa, 60 Pa, 80 Pa/3.1 mmH ₂ O, 6.1 mmH ₂ O, 8.2 mmH ₂ O). Consult your dealer about the specification when setting External static pressure option.	*Above specification data is subject to rounding variation.

Outdoor Model		PURY-M400YXM-A(-BS)		
Power source		3-phase 4-wire 380-400-415V 50Hz		
Cooling capacity (Nominal)	*1 kW	45.0		
	BTU/h	153,500		
	Power input kW	13.39		
	Current input A	22.6-21.4-20.6		
	EER	3.36		
	SEER	7.53		
Temp. range of cooling	*4 Indoor	W.B.	15.0~24.0°C (59~75°F)	
	Outdoor	D.B.	-5.0~52.0°C (23~126°F)	
Heating capacity (Max)	*2 kW	50.0		
	BTU/h	170,600		
	Power input kW	14.04		
	Current input A	23.7-22.5-21.7		
	COP	3.56		
	(Nominal)	*3 kW	45.0	
		BTU/h	153,500	
		Power input kW	11.39	
		Current input A	19.2-18.2-17.6	
		COP	3.95	
	SCOP	4.56		
Temp. range of heating	*4 Indoor	D.B.	15.0~27.0°C (59~81°F)	
	Outdoor	W.B.	-25.0~15.5°C (-13~60°F)	
Indoor unit connectable	Total capacity	50~150% of outdoor unit capacity		
	Model/Maximum quantity	M10~M250/29		
Sound pressure level (measured in anechoic room)	*5, 6	dB <A>	61.0/64.0	
Sound power level (measured in anechoic room)	*5	dB <A>	82/86	
Refrigerant piping diameter	High pressure	mm (in.)	22.2 (7/8) Brazed	
	Low pressure	mm (in.)	28.58 (1-1/8) Brazed	
FAN	Type x Quantity	Propeller fan x 2		
	Air flow rate	m ³ /min	260	
		L/s	4,333	
		cfm	9,181	
	Control, Driving mechanism	Inverter-control, Direct-driven by motor		
	*7 Motor output	kW	0.46 x2	
External static press.	0 Pa (0 mmH ₂ O)			
Compressor	Type x Quantity	Inverter scroll hermetic compressor x1		
	Starting method	Inverter		
	Motor output	kW	11.2	
	Case heater	kW	-	
Lubricant	MEL46EH			
External finish	Pre-coated galvanized steel sheets (+powder coating for -BS type) <MUNSELL 3Y 7.8/1.1 or similar>			
External dimension H x W x D	mm	1,858 (1,798 without legs) x 1207 x 740		
	in.	73-3/16 (70-13/16 without legs) x 47-9/16 x 29-3/16		
Protection devices	High pressure protection	High pressure sensor, High pressure switch at 4.15MPa (601psi)		
	Inverter circuit (COMP./FAN)	Over-heat protection, Over-current protection		
	Compressor	-		
	Fan motor	-		
Refrigerant	Type x original charge	R32 x 9.3kg (21lbs)		
	Control	Indoor LEV and BC controller		
Net weight	kg (lbs)	327 (721)		
Heat exchanger	Salt-resistant cross fin & copper tube			
HIC circuit (HIC: Heat Inter-Changer)	-			
Defrosting method	Auto-defrost mode (Reversed refrigerant cycle, Liquid backless refrigerant cycle)			
Drawing	External	KB94CANU		
	Wiring	KE94L613		
Standard attachment	Document	Installation Manual		
	Accessory	-		
Optional parts	Joint	CMY-Y102SS-G2, CMY-Y102LS-G2, CMY-R170M-E		
	Main BC controller	CMB-M104/106/108/1012V-MA-SV(-TR)		
	Sub BC controller	CMB-M104/108V-MB-SV(-TR)		
Remarks	Details on foundation work, duct work, insulation work, electrical wiring, power source switch, and other items shall be referred to the Installation Manual. Due to continuing improvement, above specifications may be subject to change without notice.			

Notes:	Unit converter
1.Nominal cooling conditions Indoor: 27°CDB./19°CWB. (81°FDB./66°FWB.), Outdoor: 35°CDB./24°CWB. (95°FDB./75°FWB.) (subject to EN 14511-2) Pipe length: 7.5 m (24-9/16 ft.), Level difference: 0 m (0 ft.) (subject to EN 14511-3)	BTU/h =kW x 3,412 cfm =m ³ /min x 35.31 lbs =kg/0.4536
2.Max heating conditions Indoor: 20°CDB. (68°FDB.), Outdoor: 7°CDB./6°CWB. (45°FDB./43°FWB.) (subject to EN 14511-2) Pipe length: 7.5 m (24-9/16 ft.), Level difference: 0 m (0 ft.) (subject to EN 14511-3)	
3.Nominal heating conditions Indoor: 20°CDB. (68°FDB.), Outdoor: 7°CDB./6°CWB. (45°FDB./43°FWB.) (subject to EN 14511-2) Pipe length: 7.5 m (24-9/16 ft.), Level difference: 0 m (0 ft.) (subject to EN 14511-3) Eurovent registered	
4.-10 °CDB.(14 °FDB.)/-11 °CWB.(12 °FWB.) to 21 °CDB.(70 °FDB.)/15.5 °CWB.(60 °FWB.) with cooling/heating mixed operation.	
5.Cooling mode/Heating mode	
6.The sound pressure level measured by the conventional method in JIS for reference purpose.	
7.External static pressure option is available (30 Pa, 60 Pa, 80 Pa/3.1 mmH ₂ O, 6.1 mmH ₂ O, 8.2 mmH ₂ O). Consult your dealer about the specification when setting External static pressure option.	
	*Above specification data is subject to rounding variation.

Outdoor Model		PUR-Y-M450YXM-A(-BS)		
Power source		3-phase 4-wire 380-400-415V 50Hz		
Cooling capacity (Nominal)	*1 kW	50.0		
	BTU/h	170,600		
	Power input kW	15.47		
	Current input A	26.1-24.8-23.9		
	EER	3.23		
SEER	7.43			
Temp. range of cooling	*4 Indoor	W.B.	15.0~24.0°C (59~75°F)	
	Outdoor	D.B.	-5.0~52.0°C (23~126°F)	
Heating capacity (Max)	*2 kW	56.0		
	BTU/h	191,100		
	Power input kW	16.66		
	Current input A	28.1-26.7-25.7		
	COP	3.36		
	(Nominal)	*3 kW	50.0	
		BTU/h	170,600	
Power input kW		13.36		
Current input A		22.5-21.4-20.6		
COP	3.74			
SCOP	4.45			
Temp. range of heating	*4 Indoor	D.B.	15.0~27.0°C (59~81°F)	
	Outdoor	W.B.	-25.0~15.5°C (-13~60°F)	
Indoor unit connectable	Total capacity		50~150% of outdoor unit capacity	
	Model/Maximum quantity		M10~M250/33	
Sound pressure level (measured in anechoic room)	*5, 6	dB <A>	63.0/68.0	
Sound power level (measured in anechoic room)	*5	dB <A>	83/89	
Refrigerant piping diameter	High pressure	mm (in.)	22.2 (7/8) Brazed	
	Low pressure	mm (in.)	28.58 (1-1/8) Brazed	
FAN	Type x Quantity		Propeller fan x 2	
	Air flow rate	m ³ /min	300	
		L/s	5,000	
		cfm	10,593	
	Control, Driving mechanism		Inverter-control, Direct-driven by motor	
	*7 Motor output	kW	0.46 x2	
External static press.		0 Pa (0 mmH ₂ O)		
Compressor	Type x Quantity		Inverter scroll hermetic compressor x1	
	Starting method		Inverter	
	Motor output	kW	13.5	
	Case heater	kW	-	
	Lubricant		MEL46EH	
External finish		Pre-coated galvanized steel sheets (+powder coating for -BS type) <MUNSELL 3Y 7.8/1.1 or similar>		
External dimension H x W x D	mm	1,858 (1,798 without legs) x 1207 x 740		
	in.	73-3/16 (70-13/16 without legs) x 47-9/16 x 29-3/16		
Protection devices	High pressure protection		High pressure sensor, High pressure switch at 4.15MPa (601psi)	
	Inverter circuit (COMP./FAN)		Over-heat protection, Over-current protection	
	Compressor		-	
	Fan motor		-	
Refrigerant	Type x original charge		R32 x 9.3kg (21lbs)	
	Control		Indoor LEV and BC controller	
Net weight	kg (lbs)	327 (721)		
Heat exchanger		Salt-resistant cross fin & copper tube		
HIC circuit (HIC: Heat Inter-Changer)		-		
Defrosting method		Auto-defrost mode (Reversed refrigerant cycle, Liquid backless refrigerant cycle)		
Drawing	External	KB94CANU		
	Wiring	KE94L613		
Standard attachment	Document	Installation Manual		
	Accessory	-		
Optional parts	Joint		CMY-Y102SS-G2, CMY-Y102LS-G2, CMY-R170M-E	
	Main BC controller		CMB-M104/106/108/1012V-MA-SV(-TR)	
	Sub BC controller		CMB-M104/108V-MB-SV(-TR)	
Remarks		Details on foundation work, duct work, insulation work, electrical wiring, power source switch, and other items shall be referred to the Installation Manual. Due to continuing improvement, above specifications may be subject to change without notice.		

Notes:	Unit converter
1.Nominal cooling conditions Indoor: 27°C.D.B./19°C.W.B. (81°F.D.B./66°F.W.B.), Outdoor: 35°C.D.B./24°C.W.B. (95°F.D.B./75°F.W.B.) (subject to EN 14511-2) Pipe length: 7.5 m (24-9/16 ft.), Level difference: 0 m (0 ft.) (subject to EN 14511-3)	BTU/h =kW x 3,412 cfm =m ³ /min x 35.31 lbs =kg/0.4536
2.Max heating conditions Indoor: 20°C.D.B. (68°F.D.B.), Outdoor: 7°C.D.B./6°C.W.B. (45°F.D.B./43°F.W.B.) (subject to EN 14511-2) Pipe length: 7.5 m (24-9/16 ft.), Level difference: 0 m (0 ft.) (subject to EN 14511-3)	
3.Nominal heating conditions Indoor: 20°C.D.B. (68°F.D.B.), Outdoor: 7°C.D.B./6°C.W.B. (45°F.D.B./43°F.W.B.) (subject to EN 14511-2) Pipe length: 7.5 m (24-9/16 ft.), Level difference: 0 m (0 ft.) (subject to EN 14511-3) Eurovent registered	
4.-10 °C.D.B.(14 °F.D.B.)/-11 °C.W.B.(12 °F.W.B.) to 21 °C.D.B.(70 °F.D.B.)/15.5 °C.W.B.(60 °F.W.B.) with cooling/heating mixed operation.	
5.Cooling mode/Heating mode	
6.The sound pressure level measured by the conventional method in JIS for reference purpose.	
7.External static pressure option is available (30 Pa, 60 Pa/3.1 mmH ₂ O, 6.1 mmH ₂ O). Consult your dealer about the specification when setting External static pressure option.	*Above specification data is subject to rounding variation.

Outdoor Model		PURY-M500YXM-A(-BS)		
Power source		3-phase 4-wire 380-400-415V 50Hz		
Cooling capacity (Nominal)	*1	kW	56.0	
		BTU/h	191,100	
		Power input kW	19.71	
		Current input A	33.2-31.6-30.4	
		EER	2.84	
	SEER	kW/kW	7.00	
Temp. range of cooling	*4	Indoor	W.B.	15.0~24.0°C (59~75°F)
		Outdoor	D.B.	-5.0~52.0°C (23~126°F)
Heating capacity (Max)	*2	kW	58.0	
		BTU/h	197,900	
		Power input kW	17.41	
		Current input A	29.3-27.9-26.9	
		COP	kW/kW	3.33
	(Nominal)	*3	kW	56.0
			BTU/h	191,100
			Power input kW	15.09
			Current input A	25.4-24.2-23.3
			COP	kW/kW
	SCOP	kW/kW	4.35	
Temp. range of heating	*4	Indoor	D.B.	15.0~27.0°C (59~81°F)
		Outdoor	W.B.	-25.0~15.5°C (-13~60°F)
Indoor unit connectable	Total capacity		50~150% of outdoor unit capacity	
	Model/Maximum quantity		M10~M250/36	
Sound pressure level (measured in anechoic room)	*5, 6	dB <A>	67.5/69.5	
Sound power level (measured in anechoic room)	*5	dB <A>	87/91	
Refrigerant piping diameter	High pressure		mm (in.)	22.2 (7/8) Brazed
	Low pressure		mm (in.)	28.58 (1-1/8) Brazed
FAN	Type x Quantity		Propeller fan x 2	
	Air flow rate	m ³ /min	305	
		L/s	5,083	
		cfm	10,770	
	Control, Driving mechanism		Inverter-control, Direct-driven by motor	
	*7	Motor output kW	0.46 x2	
External static press.		0 Pa (0 mmH ₂ O)		
Compressor	Type x Quantity		Inverter scroll hermetic compressor x1	
	Starting method		Inverter	
	Motor output	kW	16.1	
	Case heater	kW	-	
	Lubricant		MEL46EH	
External finish		Pre-coated galvanized steel sheets (+powder coating for -BS type) <MUNSELL 3Y 7.8/1.1 or similar>		
External dimension H x W x D		mm	1,858 (1,798 without legs) x 1207 x 740	
		in.	73-3/16 (70-13/16 without legs) x 47-9/16 x 29-3/16	
Protection devices	High pressure protection		High pressure sensor, High pressure switch at 4.15MPa (601psi)	
	Inverter circuit (COMP./FAN)		Over-heat protection, Over-current protection	
	Compressor		-	
	Fan motor		-	
Refrigerant	Type x original charge		R32 x 9.3kg (21lbs)	
	Control		Indoor LEV and BC controller	
Net weight	kg (lbs)		327 (721)	
Heat exchanger		Salt-resistant cross fin & copper tube		
HIC circuit (HIC: Heat Inter-Changer)		-		
Defrosting method		Auto-defrost mode (Reversed refrigerant cycle, Liquid backless refrigerant cycle)		
Drawing	External	KB94CANU		
	Wiring	KE94L613		
Standard attachment	Document	Installation Manual		
	Accessory	-		
Optional parts	Joint		CMY-Y102SS-G2, CMY-Y102LS-G2, CMY-R170M-E	
	Main BC controller		CMB-M104/106/108/1012V-MA-SV(-TR)	
	Sub BC controller		CMB-M104/108V-MB-SV(-TR)	
Remarks		Details on foundation work, duct work, insulation work, electrical wiring, power source switch, and other items shall be referred to the Installation Manual. Due to continuing improvement, above specifications may be subject to change without notice.		

Notes:	Unit converter
1.Nominal cooling conditions Indoor: 27°C D.B./19°C W.B. (81°F D.B./66°F W.B.), Outdoor: 35°C D.B./24°C W.B. (95°F D.B./75°F W.B.) (subject to EN 14511-2) Pipe length: 7.5 m (24-9/16 ft.), Level difference: 0 m (0 ft.) (subject to EN 14511-3)	BTU/h =kW x 3,412 cfm =m ³ /min x 35.31 lbs =kg/0.4536
2.Max heating conditions Indoor: 20°C D.B. (68°F D.B.), Outdoor: 7°C D.B./6°C W.B. (45°F D.B./43°F W.B.) (subject to EN 14511-2) Pipe length: 7.5 m (24-9/16 ft.), Level difference: 0 m (0 ft.) (subject to EN 14511-3)	
3.Nominal heating conditions Indoor: 20°C D.B. (68°F D.B.), Outdoor: 7°C D.B./6°C W.B. (45°F D.B./43°F W.B.) (subject to EN 14511-2) Pipe length: 7.5 m (24-9/16 ft.), Level difference: 0 m (0 ft.) (subject to EN 14511-3) Eurovent registered	
4.-10 °C D.B.(14 °F D.B.)/-11 °C W.B.(12 °F W.B.) to 21 °C D.B.(70 °F D.B.)/15.5 °C W.B.(60 °F W.B.) with cooling/heating mixed operation.	
5.Cooling mode/Heating mode	
6.The sound pressure level measured by the conventional method in JIS for reference purpose.	
7.External static pressure option is available (30 Pa/3.1 mmH ₂ O). Consult your dealer about the specification when setting External static pressure option.	*Above specification data is subject to rounding variation.

Outdoor Model		PURY-M400YSXM-A(-BS)		
Power source		3-phase 4-wire 380-400-415V 50Hz		
Cooling capacity (Nominal)	*1	kW	44.8	
		BTU/h	152,900	
		Power input kW	11.17	
		Current input A	18.8-17.9-17.2	
		EER	4.01	
		SEER	7.67	
Temp. range of cooling	*4	Indoor	W.B.	
		Outdoor	D.B.	
Heating capacity (Max)		kW	50.0	
		BTU/h	170,600	
		Power input kW	11.68	
		Current input A	19.7-18.7-18.0	
		COP	4.28	
	(Nominal)	*3	kW	44.8
			BTU/h	152,900
		Power input kW	9.91	
		Current input A	16.7-15.8-15.3	
		COP	4.52	
		SCOP	4.69	
Temp. range of heating	*4	Indoor	D.B.	
		Outdoor	W.B.	
Indoor unit connectable	Total capacity	50~150% of outdoor unit capacity		
	Model/Maximum quantity	M10~M250/29		
Sound pressure level (measured in anechoic room)	*5, 6	dB <A>	60.0/61.0	
Sound power level (measured in anechoic room)	*5	dB <A>	79/82	
Refrigerant piping diameter	High pressure	mm (in.)	22.2 (7/8) Brazed	
	Low pressure	mm (in.)	28.58 (1-1/8) Brazed	

Set Model		PURY-M200YXM-A(-BS)		PURY-M200YXM-A(-BS)	
Outdoor Model		PURY-M200YXM-A(-BS)		PURY-M200YXM-A(-BS)	
FAN	Type x Quantity	Propeller fan x 1		Propeller fan x 1	
	Air flow rate	m ³ /min	170	170	170
		L/s	2,833	2,833	2,833
		cfm	6,003	6,003	6,003
	Control, Driving mechanism	Inverter-control, Direct-driven by motor		Inverter-control, Direct-driven by motor	
	Motor output	kW	0.92 x 1	0.92 x 1	0.92 x 1
	External static press.	0 Pa (0 mmH ₂ O)		0 Pa (0 mmH ₂ O)	
Compressor	Type x Quantity	Inverter scroll hermetic compressor x1		Inverter scroll hermetic compressor x1	
	Starting method	Inverter		Inverter	
	Motor output	kW	4.0	4.0	4.0
	Case heater	kW	-	-	-
	Lubricant	MEL46EH		MEL46EH	
External finish	Pre-coated galvanized steel sheets (+powder coating for -BS type) <MUNSELL 3Y 7.8/1.1 or similar>		Pre-coated galvanized steel sheets (+powder coating for -BS type) <MUNSELL 3Y 7.8/1.1 or similar>		
External dimension H x W x D	mm	1,858 (1,798 without legs) x 910 x 740		1,858 (1,798 without legs) x 910 x 740	
	in.	73-3/16 (70-13/16 without legs) x 35-7/8 x 29-3/16		73-3/16 (70-13/16 without legs) x 35-7/8 x 29-3/16	
Protection devices	High pressure protection	High pressure sensor, High pressure switch at 4.15MPa (601psi)		High pressure sensor, High pressure switch at 4.15MPa (601psi)	
	Inverter circuit (COMP./FAN)	Over-heat protection, Over-current protection		Over-heat protection, Over-current protection	
	Compressor	-		-	
	Fan motor	-		-	
Refrigerant	Type x original charge	R32 x 8.0kg (18lbs)		R32 x 8.0kg (18lbs)	
	Control	Indoor LEV and BC controller			
Net weight	kg (lbs)	265 (585)		265 (585)	
Heat exchanger	Salt-resistant cross fin & copper tube		Salt-resistant cross fin & copper tube		
HIC circuit (HIC: Heat Inter-Changer)	-				
Pipe between unit and distributor	High pressure	mm (in.)	15.88 (5/8) Brazed	15.88 (5/8) Brazed	
	Low pressure	mm (in.)	19.05 (3/4) Brazed	19.05 (3/4) Brazed	
Defrosting method	Auto-defrost mode (Reversed refrigerant cycle, Liquid backless refrigerant cycle)				
Drawing	External	KB94CANV			
	Wiring	KE94L612		KE94L612	
Standard attachment	Document	Installation Manual			
	Accessory	-			
Optional parts	Twinning kit	CMY-R100VBK4			
	Joint	CMY-Y102SS-G2, CMY-Y102LS-G2, CMY-R170M-E			
	Main BC controller	CMB-M104/106/108/1012V-MA-SV(-TR)			
	Sub BC controller	CMB-M104/108V-MB-SV(-TR)			
Remarks	Details on foundation work, duct work, insulation work, electrical wiring, power source switch, and other items shall be referred to the Installation Manual. Due to continuing improvement, above specifications may be subject to change without notice.				

Notes:	Unit converter
1.Nominal cooling conditions Indoor: 27°C.D.B./19°C.W.B. (81°F.D.B./66°F.W.B.), Outdoor: 35°C.D.B./24°C.W.B. (95°F.D.B./75°F.W.B.) (subject to EN 14511-2) Pipe length: 7.5 m (24-9/16 ft.), Level difference: 0 m (0 ft.) (subject to EN 14511-3)	BTU/h =kW x 3,412
2.Max heating conditions Indoor: 20°C.D.B. (68°F.D.B.), Outdoor: 7°C.D.B./6°C.W.B. (45°F.D.B./43°F.W.B.) (subject to EN 14511-2) Pipe length: 7.5 m (24-9/16 ft.), Level difference: 0 m (0 ft.) (subject to EN 14511-3)	cfm =m ³ /min x 35.31
3.Nominal heating conditions Indoor: 20°C.D.B. (68°F.D.B.), Outdoor: 7°C.D.B./6°C.W.B. (45°F.D.B./43°F.W.B.) (subject to EN 14511-2) Pipe length: 7.5 m (24-9/16 ft.), Level difference: 0 m (0 ft.) (subject to EN 14511-3)	lbs =kg/0.4536
4.-10 °C.D.B.(14 °F.D.B.)-11 °C.W.B.(12 °F.W.B.) to 21 °C.D.B.(70 °F.D.B.)/15.5 °C.W.B.(60 °F.W.B.) with cooling/heating mixed operation.	
5.Cooling mode/Heating mode	
6.The sound pressure level measured by the conventional method in JIS for reference purpose.	
7.External static pressure option is available (30 Pa, 60 Pa, 80 Pa/3.1 mmH ₂ O, 6.1 mmH ₂ O, 8.2 mmH ₂ O). Consult your dealer about the specification when setting External static pressure option.	
	*Above specification data is subject to rounding variation.

Outdoor Model		PURY-M450YSXM-A(-BS)		
Power source		3-phase 4-wire 380-400-415V 50Hz		
Cooling capacity (Nominal)	*1	kW	50.4	
		BTU/h	172,000	
		Power input kW	13.44	
		Current input A	22.6-21.5-20.7	
		EER	3.75	
	SEER	7.47		
Temp. range of cooling	*4	Indoor	W.B.	15.0~24.0°C (59~75°F)
		Outdoor	D.B.	-5.0~52.0°C (23~126°F)
Heating capacity (Max)	*2	kW	56.5	
		BTU/h	192,800	
		Power input kW	13.78	
		Current input A	23.2-22.0-21.3	
		COP	4.10	
	(Nominal)	*3	kW	50.4
			BTU/h	172,000
			Power input kW	11.55
			Current input A	19.4-18.5-17.8
			COP	4.36
	SCOP	4.67		
Temp. range of heating	*4	Indoor	D.B.	15.0~27.0°C (59~81°F)
		Outdoor	W.B.	-25.0~15.5°C (-13~60°F)
Indoor unit connectable	Total capacity	50~150% of outdoor unit capacity		
	Model/Maximum quantity	M10-M250/33		
Sound pressure level (measured in anechoic room)	*5, 6	dB <A>	60.0/61.0	
Sound power level (measured in anechoic room)	*5	dB <A>	80/82	
Refrigerant piping diameter	High pressure	mm (in.)	22.2 (7/8) Brazed	
	Low pressure	mm (in.)	28.58 (1-1/8) Brazed	

Set Model		PURY-M250YXM-A(-BS)		PURY-M200YXM-A(-BS)	
FAN	Type x Quantity	Propeller fan x 1		Propeller fan x 1	
	Air flow rate	m ³ /min	180	170	
		L/s	3,000	2,833	
		cfm	6,356	6,003	
	Control, Driving mechanism	Inverter-control, Direct-driven by motor		Inverter-control, Direct-driven by motor	
	Motor output	kW	0.92 × 1	0.92 × 1	
	External static press.	0 Pa (0 mmH ₂ O)		0 Pa (0 mmH ₂ O)	
Compressor	Type x Quantity	Inverter scroll hermetic compressor × 1		Inverter scroll hermetic compressor × 1	
	Starting method	Inverter		Inverter	
	Motor output	kW	5.8	4.0	
	Case heater	kW	-	-	
	Lubricant	MEL46EH		MEL46EH	
External finish	Pre-coated galvanized steel sheets (+powder coating for -BS type) <MUNSELL 3Y 7.8/1.1 or similar>		Pre-coated galvanized steel sheets (+powder coating for -BS type) <MUNSELL 3Y 7.8/1.1 or similar>		
External dimension H x W x D	mm	1,858 (1,798 without legs) x 910 x 740		1,858 (1,798 without legs) x 910 x 740	
	in.	73-3/16 (70-13/16 without legs) x 35-7/8 x 29-3/16		73-3/16 (70-13/16 without legs) x 35-7/8 x 29-3/16	
Protection devices	High pressure protection	High pressure sensor, High pressure switch at 4.15MPa (601psi)		High pressure sensor, High pressure switch at 4.15MPa (601psi)	
	Inverter circuit (COMP./FAN)	Over-heat protection, Over-current protection		Over-heat protection, Over-current protection	
	Compressor	-		-	
	Fan motor	-		-	
Refrigerant	Type x original charge	R32 x 8.0kg (18lbs)		R32 x 8.0kg (18lbs)	
	Control	Indoor LEV and BC controller			
Net weight	kg (lbs)	265 (585)		265 (585)	
Heat exchanger	Salt-resistant cross fin & copper tube		Salt-resistant cross fin & copper tube		
HIC circuit (HIC: Heat Inter-Changer)	-				
Pipe between unit and distributor	High pressure	mm (in.)	19.05 (3/4) Brazed	15.88 (5/8) Brazed	
	Low pressure	mm (in.)	22.2 (7/8) Brazed	19.05 (3/4) Brazed	
Defrosting method	Auto-defrost mode (Reversed refrigerant cycle, Liquid backless refrigerant cycle)				
Drawing	External	KB94CANV			
	Wiring	KE94L612		KE94L612	
Standard attachment	Document	Installation Manual			
	Accessory	-			
Optional parts	Twinning kit	CMY-R100VBK4			
	Joint	CMY-Y102SS-G2, CMY-Y102LS-G2, CMY-R170M-E			
	Main BC controller	CMB-M104/106/108/1012V-MA-SV(-TR)			
	Sub BC controller	CMB-M104/108V-MB-SV(-TR)			
Remarks	Details on foundation work, duct work, insulation work, electrical wiring, power source switch, and other items shall be referred to the Installation Manual. Due to continuing improvement, above specifications may be subject to change without notice.				

Notes:	Unit converter
1. Nominal cooling conditions Indoor: 27°C D.B./19°C W.B. (81°F D.B./66°F W.B.), Outdoor: 35°C D.B./24°C W.B. (95°F D.B./75°F W.B.) (subject to EN 14511-2) Pipe length: 7.5 m (24-9/16 ft.), Level difference: 0 m (0 ft.) (subject to EN 14511-3)	BTU/h =kW x 3,412 cfm =m ³ /min x 35.31 lbs =kg/0.4536
2. Max heating conditions Indoor: 20°C D.B. (68°F D.B.), Outdoor: 7°C D.B./6°C W.B. (45°F D.B./43°F W.B.) (subject to EN 14511-2) Pipe length: 7.5 m (24-9/16 ft.), Level difference: 0 m (0 ft.) (subject to EN 14511-3)	
3. Nominal heating conditions Indoor: 20°C D.B. (68°F D.B.), Outdoor: 7°C D.B./6°C W.B. (45°F D.B./43°F W.B.) (subject to EN 14511-2) Pipe length: 7.5 m (24-9/16 ft.), Level difference: 0 m (0 ft.) (subject to EN 14511-3)	
4. -10 °C D.B. (14 °F D.B.)/-11 °C W.B. (12 °F W.B.) to 21 °C D.B. (70 °F D.B.)/15.5 °C W.B. (60 °F W.B.) with cooling/heating mixed operation.	
5. Cooling mode/Heating mode	
6. The sound pressure level measured by the conventional method in JIS for reference purpose.	
7. External static pressure option is available (30 Pa, 60 Pa, 80 Pa/3.1 mmH ₂ O, 6.1 mmH ₂ O, 8.2 mmH ₂ O). Consult your dealer about the specification when setting External static pressure option.	
	*Above specification data is subject to rounding variation.

Outdoor Model		PURY-M500YSXM-A(-BS)		
Power source		3-phase 4-wire 380-400-415V 50Hz		
Cooling capacity (Nominal)	*1	kW	56.0	
		BTU/h	191,100	
		Power input kW	16.00	
		Current input A	27.0-25.6-24.7	
		EER	3.50	
		SEER	7.39	
Temp. range of cooling	*4	Indoor	W.B.	
		Outdoor	D.B.	
Heating capacity (Max)		kW	63.0	
		BTU/h	215,000	
		Power input kW	16.11	
		Current input A	27.1-25.8-24.9	
		COP	3.91	
	(Nominal)	*3	kW	56.0
		BTU/h	191,100	
Temp. range of heating		Power input kW	13.30	
		Current input A	22.4-21.3-20.5	
		COP	4.21	
		SCOP	4.66	
		Indoor	D.B.	
		Outdoor	W.B.	
Indoor unit connectable	Total capacity	50~150% of outdoor unit capacity		
	Model/Maximum quantity	M10~M250/36		
Sound pressure level (measured in anechoic room)	*5, 6	dB <A>	60.0/62.0	
Sound power level (measured in anechoic room)	*5	dB <A>	82/83	
Refrigerant piping diameter		High pressure	22.2 (7/8) Brazed	
		Low pressure	28.58 (1-1/8) Brazed	

Set Model		PURY-M250YXM-A(-BS)		PURY-M250YXM-A(-BS)	
Outdoor Model		PURY-M250YXM-A(-BS)		PURY-M250YXM-A(-BS)	
FAN	Type x Quantity	Propeller fan x 1		Propeller fan x 1	
	Air flow rate	m ³ /min	180	180	
		L/s	3,000	3,000	
		cfm	6,356	6,356	
	Control, Driving mechanism	Inverter-control, Direct-driven by motor		Inverter-control, Direct-driven by motor	
	Motor output	kW	0.92 x 1	0.92 x 1	
	External static press.		0 Pa (0 mmH ₂ O)	0 Pa (0 mmH ₂ O)	
Compressor	Type x Quantity	Inverter scroll hermetic compressor x1		Inverter scroll hermetic compressor x1	
	Starting method	Inverter		Inverter	
	Motor output	kW	5.8	5.8	
	Case heater	kW	-	-	
	Lubricant		MEL46EH	MEL46EH	
External finish		Pre-coated galvanized steel sheets (+powder coating for -BS type) <MUNSELL 3Y 7.8/1.1 or similar>		Pre-coated galvanized steel sheets (+powder coating for -BS type) <MUNSELL 3Y 7.8/1.1 or similar>	
External dimension H x W x D		mm	1,858 (1,798 without legs) x 910 x 740	1,858 (1,798 without legs) x 910 x 740	
		in.	73-3/16 (70-13/16 without legs) x 35-7/8 x 29-3/16	73-3/16 (70-13/16 without legs) x 35-7/8 x 29-3/16	
Protection devices	High pressure protection	High pressure sensor, High pressure switch at 4.15MPa (601psi)		High pressure sensor, High pressure switch at 4.15MPa (601psi)	
	Inverter circuit (COMP./FAN)	Over-heat protection, Over-current protection		Over-heat protection, Over-current protection	
	Compressor	-		-	
	Fan motor	-		-	
Refrigerant	Type x original charge	R32 x 8.0kg (18lbs)		R32 x 8.0kg (18lbs)	
	Control	Indoor LEV and BC controller			
Net weight	kg (lbs)	265 (585)		265 (585)	
Heat exchanger		Salt-resistant cross fin & copper tube		Salt-resistant cross fin & copper tube	
HIC circuit (HIC: Heat Inter-Changer)		-		-	
Pipe between unit and distributor	High pressure	mm (in.)	19.05 (3/4) Brazed	19.05 (3/4) Brazed	
	Low pressure	mm (in.)	22.2 (7/8) Brazed	22.2 (7/8) Brazed	
Defrosting method		Auto-defrost mode (Reversed refrigerant cycle, Liquid backless refrigerant cycle)			
Drawing	External	KB94CANV			
	Wiring	KE94L612		KE94L612	
Standard attachment	Document	Installation Manual			
	Accessory	-			
Optional parts	Twinning kit	CMY-R100VBK4			
	Joint	CMY-Y102SS-G2, CMY-Y102LS-G2, CMY-R170M-E			
	Main BC controller	CMB-M104/106/108/1012V-MA-SV(-TR)			
	Sub BC controller	CMB-M104/108V-MB-SV(-TR)			
Remarks		Details on foundation work, duct work, insulation work, electrical wiring, power source switch, and other items shall be referred to the Installation Manual. Due to continuing improvement, above specifications may be subject to change without notice.			

Notes:	Unit converter
1.Nominal cooling conditions Indoor: 27°C.D.B./19°C.W.B. (81°F.D.B./66°F.W.B.), Outdoor: 35°C.D.B./24°C.W.B. (95°F.D.B./75°F.W.B.) (subject to EN 14511-2) Pipe length: 7.5 m (24-9/16 ft.), Level difference: 0 m (0 ft.) (subject to EN 14511-3)	BTU/h =kW x 3,412
2.Max heating conditions Indoor: 20°C.D.B. (68°F.D.B.), Outdoor: 7°C.D.B./6°C.W.B. (45°F.D.B./43°F.W.B.) (subject to EN 14511-2) Pipe length: 7.5 m (24-9/16 ft.), Level difference: 0 m (0 ft.) (subject to EN 14511-3)	cfm =m ³ /min x 35.31
3.Nominal heating conditions Indoor: 20°C.D.B. (68°F.D.B.), Outdoor: 7°C.D.B./6°C.W.B. (45°F.D.B./43°F.W.B.) (subject to EN 14511-2) Pipe length: 7.5 m (24-9/16 ft.), Level difference: 0 m (0 ft.) (subject to EN 14511-3)	lbs =kg/0.4536
4.-10 °C.D.B.(14 °F.D.B.)-11 °C.W.B.(12 °F.W.B.) to 21 °C.D.B.(70 °F.D.B.)/15.5 °C.W.B.(60 °F.W.B.) with cooling/heating mixed operation.	
5.Cooling mode/Heating mode	
6.The sound pressure level measured by the conventional method in JIS for reference purpose.	
7.External static pressure option is available (30 Pa, 60 Pa, 80 Pa/3.1 mmH ₂ O, 6.1 mmH ₂ O, 8.2 mmH ₂ O). Consult your dealer about the specification when setting External static pressure option.	
	*Above specification data is subject to rounding variation.

Outdoor Model		PURY-M550YSXM-A(-BS)		
Power source		3-phase 4-wire 380-400-415V 50Hz		
Cooling capacity (Nominal)	*1	kW	61.5	
		BTU/h	209,800	
		Power input kW	17.67	
		Current input A	29.8-28.3-27.3	
		EER	3.48	
	SEER	kW/kW	7.40	
Temp. range of cooling	*4	Indoor	W.B.	15.0-24.0°C (59-75°F)
		Outdoor	D.B.	-5.0-52.0°C (23-126°F)
Heating capacity (Max)	*2	kW	69.0	
		BTU/h	235,400	
		Power input kW	17.92	
		Current input A	30.2-28.7-27.7	
		COP	kW/kW	3.85
	(Nominal)	*3	kW	61.5
			BTU/h	209,800
			Power input kW	14.74
		Current input A	24.8-23.6-22.7	
		COP	kW/kW	4.17
	SCOP	kW/kW	4.66	
Temp. range of heating	*4	Indoor	D.B.	15.0-27.0°C (59-81°F)
		Outdoor	W.B.	-25.0-15.5°C (-13-60°F)
Indoor unit connectable	Total capacity	50-150% of outdoor unit capacity		
	Model/Maximum quantity	M10-M250/40		
Sound pressure level (measured in anechoic room)	*5, 6	dB <A>	62.0/65.0	
Sound power level (measured in anechoic room)	*5	dB <A>	83/85	
Refrigerant piping diameter	High pressure	mm (in.)	22.2 (7/8) Brazed (28.58 (1-1/8) Brazed, the farthest pipe length >=65 m)	
	Low pressure	mm (in.)	28.58 (1-1/8) Brazed	

Set Model		PURY-M300YXM-A(-BS)		PURY-M250YXM-A(-BS)	
FAN	Type x Quantity	Propeller fan x 1		Propeller fan x 1	
	Air flow rate	m ³ /min	235	180	
		L/s	3,917	3,000	
		cfm	8,298	6,356	
	Control, Driving mechanism	Inverter-control, Direct-driven by motor		Inverter-control, Direct-driven by motor	
	Motor output	kW	0.92 × 1	0.92 × 1	
	External static press.	0 Pa (0 mmH ₂ O)		0 Pa (0 mmH ₂ O)	
Compressor	Type x Quantity	Inverter scroll hermetic compressor × 1		Inverter scroll hermetic compressor × 1	
	Starting method	Inverter		Inverter	
	Motor output	kW	7.4	5.8	
	Case heater	kW	-	-	
Lubricant	MEL46EH		MEL46EH		
External finish	Pre-coated galvanized steel sheets (+powder coating for -BS type)		Pre-coated galvanized steel sheets (+powder coating for -BS type)		
	<MUNSELL 3Y 7.8/1.1 or similar>		<MUNSELL 3Y 7.8/1.1 or similar>		
External dimension H x W x D	mm	1,858 (1,798 without legs) x 910 x 740	1,858 (1,798 without legs) x 910 x 740		
	in.	73-3/16 (70-13/16 without legs) x 35-7/8 x 29-3/16	73-3/16 (70-13/16 without legs) x 35-7/8 x 29-3/16		
Protection devices	High pressure protection	High pressure sensor, High pressure switch at 4.15MPa (601psi)		High pressure sensor, High pressure switch at 4.15MPa (601psi)	
	Inverter circuit (COMP./FAN)	Over-heat protection, Over-current protection		Over-heat protection, Over-current protection	
	Compressor	-		-	
	Fan motor	-		-	
Refrigerant	Type x original charge	R32 x 8.0kg (18lbs)		R32 x 8.0kg (18lbs)	
	Control	Indoor LEV and BC controller			
Net weight	kg (lbs)	266 (587)	265 (585)		
Heat exchanger	Salt-resistant cross fin & copper tube		Salt-resistant cross fin & copper tube		
HIC circuit (HIC: Heat Inter-Changer)	-				
Pipe between unit and distributor	High pressure	mm (in.)	19.05 (3/4) Brazed	19.05 (3/4) Brazed	
	Low pressure	mm (in.)	22.2 (7/8) Brazed	22.2 (7/8) Brazed	
Defrosting method	Auto-defrost mode (Reversed refrigerant cycle, Liquid backless refrigerant cycle)				
Drawing	External	KB94CANV			
	Wiring	KE94L612		KE94L612	
Standard attachment	Document	Installation Manual			
	Accessory	-			
Optional parts	Twinning kit	CMY-R100VBK4			
	Joint	CMY-Y102SS-G2, CMY-Y102LS-G2, CMY-R170M-E			
	Main BC controller	CMB-M104/106/108/1012V-MA-SV(-TR)			
	Sub BC controller	CMB-M104/108V-MB-SV(-TR)			
Remarks	Details on foundation work, duct work, insulation work, electrical wiring, power source switch, and other items shall be referred to the Installation Manual. Due to continuing improvement, above specifications may be subject to change without notice.				

Notes:	Unit converter
1.Nominal cooling conditions Indoor: 27°C D.B./19°C W.B. (81°F D.B./66°F W.B.), Outdoor: 35°C D.B./24°C W.B. (95°F D.B./75°F W.B.) (subject to EN 14511-2) Pipe length: 7.5 m (24-9/16 ft.), Level difference: 0 m (0 ft.) (subject to EN 14511-3)	BTU/h =kW x 3,412 cfm =m ³ /min x 35.31 lbs =kg/0.4536
2.Max heating conditions Indoor: 20°C D.B. (68°F D.B.), Outdoor: 7°C D.B./6°C W.B. (45°F D.B./43°F W.B.) (subject to EN 14511-2) Pipe length: 7.5 m (24-9/16 ft.), Level difference: 0 m (0 ft.) (subject to EN 14511-3)	
3.Nominal heating conditions Indoor: 20°C D.B. (68°F D.B.), Outdoor: 7°C D.B./6°C W.B. (45°F D.B./43°F W.B.) (subject to EN 14511-2) Pipe length: 7.5 m (24-9/16 ft.), Level difference: 0 m (0 ft.) (subject to EN 14511-3)	
4.-10 °C D.B.(14 °F D.B.)/-11 °C W.B.(12 °F W.B.) to 21 °C D.B.(70 °F D.B.)/15.5 °C W.B.(60 °F W.B.) with cooling/heating mixed operation.	
5.Cooling mode/Heating mode	
6.The sound pressure level measured by the conventional method in JIS for reference purpose.	
7.External static pressure option is available (30 Pa, 60 Pa, 80 Pa/3.1 mmH ₂ O, 6.1 mmH ₂ O, 8.2 mmH ₂ O). Consult your dealer about the specification when setting External static pressure option.	
	*Above specification data is subject to rounding variation.

Outdoor Model		PURY-M600YSXM-A(-BS)		
Power source		3-phase 4-wire 380-400-415V 50Hz		
Cooling capacity (Nominal)	*1	kW	67.0	
		BTU/h	228,600	
		Power input kW	19.36	
		Current input A	32.6-31.0-29.9	
		EER	3.46	
		SEER	7.54	
Temp. range of cooling	*4	Indoor	W.B.	
		Outdoor	D.B.	
Heating capacity (Max)		kW	75.0	
		BTU/h	255,900	
		Power input kW	19.84	
		Current input A	33.4-31.8-30.6	
		COP	3.78	
	(Nominal)	*3	kW	67.0
			BTU/h	228,600
		Power input kW	16.26	
		Current input A	27.4-26.0-25.1	
		COP	4.12	
		SCOP	4.66	
Temp. range of heating	*4	Indoor	D.B.	
		Outdoor	W.B.	
Indoor unit connectable	Total capacity	50~150% of outdoor unit capacity		
	Model/Maximum quantity	M10~M250/44		
Sound pressure level (measured in anechoic room)	*5, 6	dB <A>	64.0/67.0	
Sound power level (measured in anechoic room)	*5	dB <A>	84/87	
Refrigerant piping diameter	High pressure	mm (in.)	22.2 (7/8) Brazed (28.58 (1-1/8) Brazed, the farthest pipe length >=65 m)	
	Low pressure	mm (in.)	28.58 (1-1/8) Brazed	

Set Model		PURY-M300YXM-A(-BS)		PURY-M300YXM-A(-BS)		
Outdoor Model		PURY-M300YXM-A(-BS)		PURY-M300YXM-A(-BS)		
FAN	Type x Quantity	Propeller fan x 1		Propeller fan x 1		
	Air flow rate	m ³ /min	235		235	
		L/s	3,917		3,917	
		cfm	8,298		8,298	
	Control, Driving mechanism	Inverter-control, Direct-driven by motor		Inverter-control, Direct-driven by motor		
	Motor output	kW	0.92 x 1		0.92 x 1	
	External static press.		0 Pa (0 mmH ₂ O)		0 Pa (0 mmH ₂ O)	
Compressor	Type x Quantity	Inverter scroll hermetic compressor x1		Inverter scroll hermetic compressor x1		
	Starting method	Inverter		Inverter		
	Motor output	kW	7.4		7.4	
	Case heater	kW	-		-	
	Lubricant		MEL46EH		MEL46EH	
External finish		Pre-coated galvanized steel sheets (+powder coating for -BS type) <MUNSELL 3Y 7.8/1.1 or similar>		Pre-coated galvanized steel sheets (+powder coating for -BS type) <MUNSELL 3Y 7.8/1.1 or similar>		
External dimension H x W x D	mm	1,858 (1,798 without legs) x 910 x 740		1,858 (1,798 without legs) x 910 x 740		
		in.	73-3/16 (70-13/16 without legs) x 35-7/8 x 29-3/16		73-3/16 (70-13/16 without legs) x 35-7/8 x 29-3/16	
Protection devices	High pressure protection	High pressure sensor, High pressure switch at 4.15MPa (601psi)		High pressure sensor, High pressure switch at 4.15MPa (601psi)		
	Inverter circuit (COMP./FAN)	Over-heat protection, Over-current protection		Over-heat protection, Over-current protection		
	Compressor	-		-		
	Fan motor	-		-		
Refrigerant	Type x original charge	R32 x 8.0kg (18lbs)		R32 x 8.0kg (18lbs)		
	Control	Indoor LEV and BC controller				
Net weight	kg (lbs)	266 (587)		266 (587)		
Heat exchanger		Salt-resistant cross fin & copper tube		Salt-resistant cross fin & copper tube		
HIC circuit (HIC: Heat Inter-Changer)		-		-		
Pipe between unit and distributor	High pressure	mm (in.)	19.05 (3/4) Brazed		19.05 (3/4) Brazed	
	Low pressure	mm (in.)	22.2 (7/8) Brazed		22.2 (7/8) Brazed	
Defrosting method		Auto-defrost mode (Reversed refrigerant cycle, Liquid backless refrigerant cycle)				
Drawing	External	KB94CANV				
	Wiring	KE94L612		KE94L612		
Standard attachment	Document	Installation Manual				
	Accessory	-				
Optional parts	Twinning kit	CMY-R100VBK4				
	Joint	CMY-Y102SS-G2, CMY-Y102LS-G2, CMY-R170M-E				
	Main BC controller	CMB-M104/106/108/1012V-MA-SV(-TR)				
	Sub BC controller	CMB-M104/108V-MB-SV(-TR)				
Remarks		Details on foundation work, duct work, insulation work, electrical wiring, power source switch, and other items shall be referred to the Installation Manual. Due to continuing improvement, above specifications may be subject to change without notice.				

Notes:	Unit converter
1.Nominal cooling conditions Indoor: 27°C.D.B./19°C.W.B. (81°F.D.B./66°F.W.B.), Outdoor: 35°C.D.B./24°C.W.B. (95°F.D.B./75°F.W.B.) (subject to EN 14511-2) Pipe length: 7.5 m (24-9/16 ft.), Level difference: 0 m (0 ft.) (subject to EN 14511-3)	BTU/h =kW x 3,412
2.Max heating conditions Indoor: 20°C.D.B. (68°F.D.B.), Outdoor: 7°C.D.B./6°C.W.B. (45°F.D.B./43°F.W.B.) (subject to EN 14511-2) Pipe length: 7.5 m (24-9/16 ft.), Level difference: 0 m (0 ft.) (subject to EN 14511-3)	cfm =m ³ /min x 35.31
3.Nominal heating conditions Indoor: 20°C.D.B. (68°F.D.B.), Outdoor: 7°C.D.B./6°C.W.B. (45°F.D.B./43°F.W.B.) (subject to EN 14511-2) Pipe length: 7.5 m (24-9/16 ft.), Level difference: 0 m (0 ft.) (subject to EN 14511-3)	lbs =kg/0.4536
4.-10 °C.D.B.(14 °F.D.B.)-11 °C.W.B.(12 °F.W.B.) to 21 °C.D.B.(70 °F.D.B.)/15.5 °C.W.B.(60 °F.W.B.) with cooling/heating mixed operation.	
5.Cooling mode/Heating mode	
6.The sound pressure level measured by the conventional method in JIS for reference purpose.	
7.External static pressure option is available (30 Pa, 60 Pa, 80 Pa/3.1 mmH ₂ O, 6.1 mmH ₂ O, 8.2 mmH ₂ O). Consult your dealer about the specification when setting External static pressure option.	
	*Above specification data is subject to rounding variation.

Outdoor Model		PURY-M650YSXM-A(-BS)		
Power source		3-phase 4-wire 380-400-415V 50Hz		
Cooling capacity (Nominal)	*1	kW	73.5	
		BTU/h	250,800	
		Power input kW	21.87	
		Current input A	36.9-35.0-33.8	
		EER	3.36	
	SEER	kW/kW	7.60	
Temp. range of cooling	*4	Indoor	W.B.	15.0-24.0°C (59-75°F)
		Outdoor	D.B.	-5.0-52.0°C (23-126°F)
Heating capacity (Max)	*2	kW	82.5	
		BTU/h	281,500	
		Power input kW	22.85	
		Current input A	38.5-36.6-35.3	
		COP	kW/kW	3.61
	(Nominal)	*3	kW	73.5
			BTU/h	250,800
			Power input kW	18.46
			Current input A	31.1-29.6-28.5
			COP	kW/kW
	SCOP	kW/kW	4.68	
Temp. range of heating	*4	Indoor	D.B.	15.0-27.0°C (59-81°F)
		Outdoor	W.B.	-25.0-15.5°C (-13-60°F)
Indoor unit connectable	Total capacity	50-150% of outdoor unit capacity		
	Model/Maximum quantity	M10-M250/47		
Sound pressure level (measured in anechoic room)	*5, 6	dB <A>	63.0/67.0	
Sound power level (measured in anechoic room)	*5	dB <A>	83/86	
Refrigerant piping diameter	High pressure	mm (in.)	28.58 (1-1/8) Brazed	
	Low pressure	mm (in.)	28.58 (1-1/8) Brazed	

Set Model		PURY-M350YXM-A(-BS)		PURY-M300YXM-A(-BS)	
FAN	Type x Quantity	Propeller fan x 2		Propeller fan x 1	
	Air flow rate	m ³ /min	220	235	
		L/s	3,667	3,917	
		cfm	7,768	8,298	
	Control, Driving mechanism	Inverter-control, Direct-driven by motor		Inverter-control, Direct-driven by motor	
	Motor output	kW	0.46 x 2	0.92 x 1	
	External static press.	0 Pa (0 mmH ₂ O)		0 Pa (0 mmH ₂ O)	
Compressor	Type x Quantity	Inverter scroll hermetic compressor x1		Inverter scroll hermetic compressor x1	
	Starting method	Inverter		Inverter	
	Motor output	kW	10.0	7.4	
	Case heater	kW	-	-	
	Lubricant	MEL46EH		MEL46EH	
External finish	Pre-coated galvanized steel sheets (+powder coating for -BS type)		Pre-coated galvanized steel sheets (+powder coating for -BS type)		
	<MUNSELL 3Y 7.8/1.1 or similar>		<MUNSELL 3Y 7.8/1.1 or similar>		
External dimension H x W x D	mm	1,858 (1,798 without legs) x 1207 x 740	1,858 (1,798 without legs) x 910 x 740		
	in.	73-3/16 (70-13/16 without legs) x 47-9/16 x 29-3/16	73-3/16 (70-13/16 without legs) x 35-7/8 x 29-3/16		
Protection devices	High pressure protection	High pressure sensor, High pressure switch at 4.15MPa (601psi)		High pressure sensor, High pressure switch at 4.15MPa (601psi)	
	Inverter circuit (COMP./FAN)	Over-heat protection, Over-current protection		Over-heat protection, Over-current protection	
	Compressor	-		-	
	Fan motor	-		-	
Refrigerant	Type x original charge	R32 x 9.3kg (21lbs)		R32 x 8.0kg (18lbs)	
	Control	Indoor LEV and BC controller			
Net weight	kg (lbs)	322 (710)	266 (587)		
Heat exchanger	Salt-resistant cross fin & copper tube		Salt-resistant cross fin & copper tube		
HIC circuit (HIC: Heat Inter-Changer)	-		-		
Pipe between unit and distributor	High pressure	mm (in.)	19.05 (3/4) Brazed	19.05 (3/4) Brazed	
	Low pressure	mm (in.)	28.58 (1-1/8) Brazed	22.2 (7/8) Brazed	
Defrosting method	Auto-defrost mode (Reversed refrigerant cycle, Liquid backless refrigerant cycle)				
Drawing	External	KB94CANW			
	Wiring	KE94L613	KE94L612		
Standard attachment	Document	Installation Manual			
	Accessory	-			
Optional parts	Twinning kit	CMY-R100VBK4			
	Joint	CMY-Y102SS-G2, CMY-Y102LS-G2, CMY-R170M-E			
	Main BC controller	CMB-M104/106/108/1012V-MA-SV(-TR)			
	Sub BC controller	CMB-M104/108V-MB-SV(-TR)			
Remarks	Details on foundation work, duct work, insulation work, electrical wiring, power source switch, and other items shall be referred to the Installation Manual. Due to continuing improvement, above specifications may be subject to change without notice.				

Notes:	Unit converter
1.Nominal cooling conditions Indoor: 27°C D.B./19°C W.B. (81°F D.B./66°F W.B.), Outdoor: 35°C D.B./24°C W.B. (95°F D.B./75°F W.B.) (subject to EN 14511-2) Pipe length: 7.5 m (24-9/16 ft.), Level difference: 0 m (0 ft.) (subject to EN 14511-3)	BTU/h =kW x 3,412 cfm =m ³ /min x 35.31 lbs =kg/0.4536
2.Max heating conditions Indoor: 20°C D.B. (68°F D.B.), Outdoor: 7°C D.B./6°C W.B. (45°F D.B./43°F W.B.) (subject to EN 14511-2) Pipe length: 7.5 m (24-9/16 ft.), Level difference: 0 m (0 ft.) (subject to EN 14511-3)	
3.Nominal heating conditions Indoor: 20°C D.B. (68°F D.B.), Outdoor: 7°C D.B./6°C W.B. (45°F D.B./43°F W.B.) (subject to EN 14511-2) Pipe length: 7.5 m (24-9/16 ft.), Level difference: 0 m (0 ft.) (subject to EN 14511-3)	
4.-10 °C D.B.(14 °F D.B.)/-11 °C W.B.(12 °F W.B.) to 21 °C D.B.(70 °F D.B.)/15.5 °C W.B.(60 °F W.B.) with cooling/heating mixed operation.	
5.Cooling mode/Heating mode	
6.The sound pressure level measured by the conventional method in JIS for reference purpose.	
7.External static pressure option is available (30 Pa, 60 Pa, 80 Pa/3.1 mmH ₂ O, 6.1 mmH ₂ O, 8.2 mmH ₂ O). Consult your dealer about the specification when setting External static pressure option.	
	*Above specification data is subject to rounding variation.

Outdoor Model		PURY-M700YSXM-A(-BS)	
Power source		3-phase 4-wire 380-400-415V 50Hz	
Cooling capacity (Nominal)	*1 kW	80.0	
	BTU/h	273,000	
	Power input kW	23.80	
	Current input A	40.1-38.1-36.7	
	EER kW/kW	3.36	
	SEER kW/kW	7.78	
Temp. range of cooling	*4 Indoor	W.B.	15.0~24.0°C (59~75°F)
	Outdoor	D.B.	-5.0~52.0°C (23~126°F)
Heating capacity (Max)	*2 kW	90.0	
	BTU/h	307,100	
	Power input kW	26.08	
	Current input A	44.0-41.8-40.3	
	COP	3.45	
	(Nominal) *3 kW	80.0	
	BTU/h	273,000	
	Power input kW	20.77	
	Current input A	35.0-33.3-32.1	
	COP	3.85	
	SCOP	4.71	
Temp. range of heating	*4 Indoor	D.B.	15.0~27.0°C (59~81°F)
	Outdoor	W.B.	-25.0~15.5°C (-13~60°F)
Indoor unit connectable	Total capacity	50~150% of outdoor unit capacity	
	Model/Maximum quantity	M10~M250/50	
Sound pressure level (measured in anechoic room)	*5, 6 dB <A>	61.0/67.0	
Sound power level (measured in anechoic room)	*5 dB <A>	82/86	
Refrigerant piping diameter	High pressure	mm (in.)	28.58 (1-1/8) Brazed
	Low pressure	mm (in.)	34.93 (1-3/8) Brazed

Set Model						
Outdoor Model		PURY-M350YXM-A(-BS)		PURY-M350YXM-A(-BS)		
FAN	Type x Quantity	Propeller fan x 2		Propeller fan x 2		
	Air flow rate	m ³ /min	220		220	
		L/s	3,667		3,667	
		cfm	7,768		7,768	
	Control, Driving mechanism	Inverter-control, Direct-driven by motor		Inverter-control, Direct-driven by motor		
	Motor output	kW	0.46 x 2		0.46 x 2	
	External static press.	0 Pa (0 mmH ₂ O)		0 Pa (0 mmH ₂ O)		
Compressor	Type x Quantity	Inverter scroll hermetic compressor x1		Inverter scroll hermetic compressor x1		
	Starting method	Inverter		Inverter		
	Motor output	kW	10.0		10.0	
	Case heater	kW	-		-	
	Lubricant	MEL46EH		MEL46EH		
External finish	Pre-coated galvanized steel sheets (+powder coating for -BS type) <MUNSELL 3Y 7.8/1.1 or similar>		Pre-coated galvanized steel sheets (+powder coating for -BS type) <MUNSELL 3Y 7.8/1.1 or similar>			
External dimension H x W x D	mm	1,858 (1,798 without legs) x 1207 x 740		1,858 (1,798 without legs) x 1207 x 740		
	in.	73-3/16 (70-13/16 without legs) x 47-9/16 x 29-3/16		73-3/16 (70-13/16 without legs) x 47-9/16 x 29-3/16		
Protection devices	High pressure protection	High pressure sensor, High pressure switch at 4.15MPa (601psi)		High pressure sensor, High pressure switch at 4.15MPa (601psi)		
	Inverter circuit (COMP./FAN)	Over-heat protection, Over-current protection		Over-heat protection, Over-current protection		
	Compressor	-		-		
	Fan motor	-		-		
Refrigerant	Type x original charge	R32 x 9.3kg (21lbs)		R32 x 9.3kg (21lbs)		
	Control	Indoor LEV and BC controller				
Net weight	kg (lbs)	322 (710)		322 (710)		
Heat exchanger	Salt-resistant cross fin & copper tube		Salt-resistant cross fin & copper tube			
HIC circuit (HIC: Heat Inter-Changer)	-					
Pipe between unit and distributor	High pressure	mm (in.)	19.05 (3/4) Brazed			
	Low pressure	mm (in.)	28.58 (1-1/8) Brazed			
Defrosting method	Auto-defrost mode (Reversed refrigerant cycle, Liquid backless refrigerant cycle)					
Drawing	External	KB94CANX				
	Wiring	KE94L613		KE94L613		
Standard attachment	Document	Installation Manual				
	Accessory	-				
Optional parts	Twinning kit	CMY-R200VBK4				
	Joint	CMY-Y102SS-G2, CMY-Y102LS-G2, CMY-R170M-E				
	Main BC controller	CMB-M104/106/108/1012V-MA-SV(-TR)				
	Sub BC controller	CMB-M104/108V-MB-SV(-TR)				
Remarks	Details on foundation work, duct work, insulation work, electrical wiring, power source switch, and other items shall be referred to the Installation Manual. Due to continuing improvement, above specifications may be subject to change without notice.					

Notes:	Unit converter
1.Nominal cooling conditions Indoor: 27°C D.B./19°C W.B. (81°F D.B./66°F W.B.), Outdoor: 35°C D.B./24°C W.B. (95°F D.B./75°F W.B.) (subject to EN 14511-2) Pipe length: 7.5 m (24-9/16 ft.), Level difference: 0 m (0 ft.) (subject to EN 14511-3)	BTU/h =kW x 3,412 cfm =m ³ /min x 35.31 lbs =kg/0.4536
2.Max heating conditions Indoor: 20°C D.B. (68°F D.B.), Outdoor: 7°C D.B./6°C W.B. (45°F D.B./43°F W.B.) (subject to EN 14511-2) Pipe length: 7.5 m (24-9/16 ft.), Level difference: 0 m (0 ft.) (subject to EN 14511-3)	
3.Nominal heating conditions Indoor: 20°C D.B. (68°F D.B.), Outdoor: 7°C D.B./6°C W.B. (45°F D.B./43°F W.B.) (subject to EN 14511-2) Pipe length: 7.5 m (24-9/16 ft.), Level difference: 0 m (0 ft.) (subject to EN 14511-3)	
4.-10 °C D.B. (14 °F D.B.)/-11 °C W.B. (12 °F W.B.) to 21 °C D.B. (70 °F D.B.)/15.5 °C W.B. (60 °F W.B.) with cooling/heating mixed operation.	
5.Cooling mode/Heating mode	
6.The sound pressure level measured by the conventional method in JIS for reference purpose.	
7.External static pressure option is available (30 Pa, 60 Pa, 80 Pa/3.1 mmH ₂ O, 6.1 mmH ₂ O, 8.2 mmH ₂ O). Consult your dealer about the specification when setting External static pressure option.	
	*Above specification data is subject to rounding variation.

Outdoor Model		PURY-M750YSXM-A(-BS)		
Power source		3-phase 4-wire 380-400-415V 50Hz		
Cooling capacity (Nominal)	*1	kW	85.0	
		BTU/h	290,000	
		Power input kW	25.67	
		Current input A	43.3-41.1-39.6	
		EER kW/kW	3.31	
		SEER kW/kW	7.59	
Temp. range of cooling	*4	Indoor	W.B. 15.0~24.0°C (59~75°F)	
		Outdoor	D.B. -5.0~52.0°C (23~126°F)	
Heating capacity (Max)	*2	kW	95.0	
		BTU/h	324,100	
		Power input kW	27.53	
		Current input A	46.4-44.1-42.5	
		COP	3.45	
	(Nominal)	*3	kW	85.0
			BTU/h	290,000
			Power input kW	22.13
			Current input A	37.3-35.4-34.2
			COP	3.84
		SCOP	4.63	
Temp. range of heating	*4	Indoor	D.B. 15.0~27.0°C (59~81°F)	
		Outdoor	W.B. -25.0~15.5°C (-13~60°F)	
Indoor unit connectable	Total capacity	50~150% of outdoor unit capacity		
	Model/Maximum quantity	M10-M250/50		
Sound pressure level (measured in anechoic room)	*5, 6	dB <A>	63.0/67.0	
Sound power level (measured in anechoic room)	*5	dB <A>	84/88	
Refrigerant piping diameter	High pressure	mm (in.)	28.58 (1-1/8) Brazed	
	Low pressure	mm (in.)	34.93 (1-3/8) Brazed	

Set Model		PURY-M400YXM-A(-BS)		PURY-M350YXM-A(-BS)	
FAN	Type x Quantity	Propeller fan x 2		Propeller fan x 2	
		Air flow rate	m ³ /min	260	220
			L/s	4,333	3,667
			cfm	9,181	7,768
	Control, Driving mechanism	Inverter-control, Direct-driven by motor		Inverter-control, Direct-driven by motor	
	Motor output	kW	0.46 x 2	0.46 x 2	
	External static press.	0 Pa (0 mmH ₂ O)		0 Pa (0 mmH ₂ O)	
Compressor	Type x Quantity	Inverter scroll hermetic compressor x 1		Inverter scroll hermetic compressor x 1	
	Starting method	Inverter		Inverter	
	Motor output	kW	11.2	10.0	
	Case heater	kW	-	-	
	Lubricant	MEL46EH		MEL46EH	
External finish	Pre-coated galvanized steel sheets (+powder coating for -BS type) <MUNSELL 3Y 7.8/1.1 or similar>		Pre-coated galvanized steel sheets (+powder coating for -BS type) <MUNSELL 3Y 7.8/1.1 or similar>		
External dimension H x W x D	mm	1,858 (1,798 without legs) x 1207 x 740		1,858 (1,798 without legs) x 1207 x 740	
		in.	73-3/16 (70-13/16 without legs) x 47-9/16 x 29-3/16		73-3/16 (70-13/16 without legs) x 47-9/16 x 29-3/16
Protection devices	High pressure protection	High pressure sensor, High pressure switch at 4.15MPa (601psi)		High pressure sensor, High pressure switch at 4.15MPa (601psi)	
	Inverter circuit (COMP./FAN)	Over-heat protection, Over-current protection		Over-heat protection, Over-current protection	
	Compressor	-		-	
	Fan motor	-		-	
Refrigerant	Type x original charge	R32 x 9.3kg (21lbs)		R32 x 9.3kg (21lbs)	
	Control	Indoor LEV and BC controller			
Net weight	kg (lbs)	327 (721)		322 (710)	
Heat exchanger	Salt-resistant cross fin & copper tube		Salt-resistant cross fin & copper tube		
HIC circuit (HIC: Heat Inter-Changer)	-		-		
Pipe between unit and distributor	High pressure	mm (in.)	22.2 (7/8) Brazed	19.05 (3/4) Brazed	
	Low pressure	mm (in.)	28.58 (1-1/8) Brazed	28.58 (1-1/8) Brazed	
Defrosting method	Auto-defrost mode (Reversed refrigerant cycle, Liquid backless refrigerant cycle)				
Drawing	External	KB94CANX			
	Wiring	KE94L613		KE94L613	
Standard attachment	Document	Installation Manual			
	Accessory	-			
Optional parts	Twinning kit	CMY-R200VBK4			
	Joint	CMY-Y102SS-G2, CMY-Y102LS-G2, CMY-R170M-E			
	Main BC controller	CMB-M104/106/108/1012V-MA-SV(-TR)			
	Sub BC controller	CMB-M104/108V-MB-SV(-TR)			
Remarks	Details on foundation work, duct work, insulation work, electrical wiring, power source switch, and other items shall be referred to the Installation Manual. Due to continuing improvement, above specifications may be subject to change without notice.				

Notes:	Unit converter
1.Nominal cooling conditions Indoor: 27°C D.B./19°C W.B. (81°F D.B./66°F W.B.), Outdoor: 35°C D.B./24°C W.B. (95°F D.B./75°F W.B.) (subject to EN 14511-2) Pipe length: 7.5 m (24-9/16 ft.), Level difference: 0 m (0 ft.) (subject to EN 14511-3)	BTU/h =kW x 3,412 cfm =m ³ /min x 35.31 lbs =kg/0.4536
2.Max heating conditions Indoor: 20°C D.B. (68°F D.B.), Outdoor: 7°C D.B./6°C W.B. (45°F D.B./43°F W.B.) (subject to EN 14511-2) Pipe length: 7.5 m (24-9/16 ft.), Level difference: 0 m (0 ft.) (subject to EN 14511-3)	
3.Nominal heating conditions Indoor: 20°C D.B. (68°F D.B.), Outdoor: 7°C D.B./6°C W.B. (45°F D.B./43°F W.B.) (subject to EN 14511-2) Pipe length: 7.5 m (24-9/16 ft.), Level difference: 0 m (0 ft.) (subject to EN 14511-3)	
4.-10 °C D.B.(14 °F D.B.)/-11 °C W.B.(12 °F W.B.) to 21 °C D.B.(70 °F D.B.)/15.5 °C W.B.(60 °F W.B.) with cooling/heating mixed operation.	
5.Cooling mode/Heating mode	
6.The sound pressure level measured by the conventional method in JIS for reference purpose.	
7.External static pressure option is available (30 Pa, 60 Pa, 80 Pa/3.1 mmH ₂ O, 6.1 mmH ₂ O, 8.2 mmH ₂ O). Consult your dealer about the specification when setting External static pressure option.	
	*Above specification data is subject to rounding variation.

Outdoor Model		PURY-M800YSXM-A(-BS)		
Power source		3-phase 4-wire 380-400-415V 50Hz		
Cooling capacity (Nominal)	*1	kW	90.0	
		BTU/h	307,100	
		Power input kW	27.60	
		Current input A	46.5-44.2-42.6	
		EER	3.26	
		SEER	7.40	
Temp. range of cooling	*4	Indoor	W.B.	
		Outdoor	D.B.	
Heating capacity (Max)		kW	100.0	
		BTU/h	341,200	
		Power input kW	28.98	
		Current input A	48.9-46.4-44.7	
		COP	3.45	
	(Nominal)	*3	kW	90.0
			BTU/h	307,100
		Power input kW	23.49	
		Current input A	39.6-37.6-36.3	
		COP	3.83	
		SCOP	4.56	
Temp. range of heating	*4	Indoor	D.B.	
		Outdoor	W.B.	
Indoor unit connectable	Total capacity	50~150% of outdoor unit capacity		
	Model/Maximum quantity	M10~M250/50		
Sound pressure level (measured in anechoic room)	*5, 6	dB <A>	65.0/68.0	
Sound power level (measured in anechoic room)	*5	dB <A>	86/90	
Refrigerant piping diameter	High pressure	mm (in.)	28.58 (1-1/8) Brazed	
	Low pressure	mm (in.)	34.93 (1-3/8) Brazed	

Set Model		PURY-M400YXM-A(-BS)		PURY-M400YXM-A(-BS)	
FAN	Type x Quantity	Propeller fan x 2		Propeller fan x 2	
	Air flow rate	m ³ /min	260	260	260
		L/s	4,333	4,333	4,333
		cfm	9,181	9,181	9,181
	Control, Driving mechanism	Inverter-control, Direct-driven by motor		Inverter-control, Direct-driven by motor	
	Motor output	kW	0.46 x 2	0.46 x 2	0.46 x 2
	External static press.	0 Pa (0 mmH ₂ O)		0 Pa (0 mmH ₂ O)	
Compressor	Type x Quantity	Inverter scroll hermetic compressor x1		Inverter scroll hermetic compressor x1	
	Starting method	Inverter		Inverter	
	Motor output	kW	11.2	11.2	11.2
	Case heater	kW	-	-	-
	Lubricant	MEL46EH		MEL46EH	
External finish	Pre-coated galvanized steel sheets (+powder coating for -BS type) <MUNSELL 3Y 7.8/1.1 or similar>		Pre-coated galvanized steel sheets (+powder coating for -BS type) <MUNSELL 3Y 7.8/1.1 or similar>		
External dimension H x W x D	mm	1,858 (1,798 without legs) x 1207 x 740		1,858 (1,798 without legs) x 1207 x 740	
	in.	73-3/16 (70-13/16 without legs) x 47-9/16 x 29-3/16		73-3/16 (70-13/16 without legs) x 47-9/16 x 29-3/16	
Protection devices	High pressure protection	High pressure sensor, High pressure switch at 4.15MPa (601psi)		High pressure sensor, High pressure switch at 4.15MPa (601psi)	
	Inverter circuit (COMP./FAN)	Over-heat protection, Over-current protection		Over-heat protection, Over-current protection	
	Compressor	-		-	
	Fan motor	-		-	
Refrigerant	Type x original charge	R32 x 9.3kg (21lbs)		R32 x 9.3kg (21lbs)	
	Control	Indoor LEV and BC controller			
Net weight	kg (lbs)	327 (721)		327 (721)	
Heat exchanger	Salt-resistant cross fin & copper tube		Salt-resistant cross fin & copper tube		
HIC circuit (HIC: Heat Inter-Changer)	-				
Pipe between unit and distributor	High pressure	mm (in.)	22.2 (7/8) Brazed	22.2 (7/8) Brazed	
	Low pressure	mm (in.)	28.58 (1-1/8) Brazed	28.58 (1-1/8) Brazed	
Defrosting method	Auto-defrost mode (Reversed refrigerant cycle, Liquid backless refrigerant cycle)				
Drawing	External	KB94CANX			
	Wiring	KE94L613		KE94L613	
Standard attachment	Document	Installation Manual			
	Accessory	-			
Optional parts	Twinning kit	CMY-R200VBK4			
	Joint	CMY-Y102SS-G2, CMY-Y102LS-G2, CMY-R170M-E			
	Main BC controller	CMB-M104/106/108/1012V-MA-SV(-TR)			
	Sub BC controller	CMB-M104/108V-MB-SV(-TR)			
Remarks	Details on foundation work, duct work, insulation work, electrical wiring, power source switch, and other items shall be referred to the Installation Manual. Due to continuing improvement, above specifications may be subject to change without notice.				

Notes:	Unit converter
1.Nominal cooling conditions Indoor: 27°C D.B./19°C W.B. (81°F D.B./66°F W.B.), Outdoor: 35°C D.B./24°C W.B. (95°F D.B./75°F W.B.) (subject to EN 14511-2) Pipe length: 7.5 m (24-9/16 ft.), Level difference: 0 m (0 ft.) (subject to EN 14511-3)	BTU/h =kW x 3,412
2.Max heating conditions Indoor: 20°C D.B. (68°F D.B.), Outdoor: 7°C D.B./6°C W.B. (45°F D.B./43°F W.B.) (subject to EN 14511-2) Pipe length: 7.5 m (24-9/16 ft.), Level difference: 0 m (0 ft.) (subject to EN 14511-3)	cfm =m ³ /min x 35.31
3.Nominal heating conditions Indoor: 20°C D.B. (68°F D.B.), Outdoor: 7°C D.B./6°C W.B. (45°F D.B./43°F W.B.) (subject to EN 14511-2) Pipe length: 7.5 m (24-9/16 ft.), Level difference: 0 m (0 ft.) (subject to EN 14511-3)	lbs =kg/0.4536
4.-10 °C D.B. (14 °F D.B.)-11 °C W.B. (12 °F W.B.) to 21 °C D.B. (70 °F D.B.)/15.5 °C W.B. (60 °F W.B.) with cooling/heating mixed operation.	
5.Cooling mode/Heating mode	
6.The sound pressure level measured by the conventional method in JIS for reference purpose.	
7.External static pressure option is available (30 Pa, 60 Pa, 80 Pa/3.1 mmH ₂ O, 6.1 mmH ₂ O, 8.2 mmH ₂ O). Consult your dealer about the specification when setting External static pressure option.	
	*Above specification data is subject to rounding variation.

Outdoor Model		PURY-M850YSXM-A(-BS)		
Power source		3-phase 4-wire 380-400-415V 50Hz		
Cooling capacity (Nominal)	*1	kW	95.0	
		BTU/h	324,100	
		Power input kW	29.59	
		Current input A	49.9-47.4-45.7	
		EER	3.21	
	SEER	7.36		
Temp. range of cooling	*4	Indoor	W.B.	15.0-24.0°C (59-75°F)
		Outdoor	D.B.	-5.0-52.0°C (23-126°F)
Heating capacity (Max)	*2	kW	106.0	
		BTU/h	361,700	
		Power input kW	31.64	
		Current input A	53.4-50.7-48.9	
		COP	3.35	
	(Nominal)	*3	kW	95.0
			BTU/h	324,100
			Power input kW	25.53
			Current input A	43.0-40.9-39.4
			COP	3.72
	SCOP	4.50		
Temp. range of heating	*4	Indoor	D.B.	15.0-27.0°C (59-81°F)
		Outdoor	W.B.	-25.0-15.5°C (-13-60°F)
Indoor unit connectable	Total capacity	50-150% of outdoor unit capacity		
	Model/Maximum quantity	M10-M250/50		
Sound pressure level (measured in anechoic room)	*5, 6	dB <A>	66.0/70.0	
Sound power level (measured in anechoic room)	*5	dB <A>	86/91	
Refrigerant piping diameter	High pressure	mm (in.)	28.58 (1-1/8) Brazed	
	Low pressure	mm (in.)	41.28 (1-5/8) Brazed	

Set Model		PURY-M450YXM-A(-BS)		PURY-M400YXM-A(-BS)	
FAN	Type x Quantity	Propeller fan x 2		Propeller fan x 2	
		Air flow rate	m ³ /min	300	260
	L/s		5,000	4,333	
	cfm		10,593	9,181	
	Control, Driving mechanism	Inverter-control, Direct-driven by motor		Inverter-control, Direct-driven by motor	
	Motor output	kW	0.46 x 2	0.46 x 2	
	External static press.	0 Pa (0 mmH ₂ O)		0 Pa (0 mmH ₂ O)	
Compressor	Type x Quantity	Inverter scroll hermetic compressor x1		Inverter scroll hermetic compressor x1	
	Starting method	Inverter		Inverter	
	Motor output	kW	13.5	11.2	
	Case heater	kW	-	-	
	Lubricant	MEL46EH		MEL46EH	
External finish	Pre-coated galvanized steel sheets (+powder coating for -BS type)		Pre-coated galvanized steel sheets (+powder coating for -BS type)		
	<MUNSELL 3Y 7.8/1.1 or similar>		<MUNSELL 3Y 7.8/1.1 or similar>		
External dimension H x W x D	mm	1,858 (1,798 without legs) x 1207 x 740		1,858 (1,798 without legs) x 1207 x 740	
	in.	73-3/16 (70-13/16 without legs) x 47-9/16 x 29-3/16		73-3/16 (70-13/16 without legs) x 47-9/16 x 29-3/16	
Protection devices	High pressure protection	High pressure sensor, High pressure switch at 4.15MPa (601psi)		High pressure sensor, High pressure switch at 4.15MPa (601psi)	
	Inverter circuit (COMP./FAN)	Over-heat protection, Over-current protection		Over-heat protection, Over-current protection	
	Compressor	-		-	
	Fan motor	-		-	
Refrigerant	Type x original charge	R32 x 9.3kg (21lbs)		R32 x 9.3kg (21lbs)	
	Control	Indoor LEV and BC controller			
Net weight	kg (lbs)	327 (721)		327 (721)	
Heat exchanger	Salt-resistant cross fin & copper tube		Salt-resistant cross fin & copper tube		
HIC circuit (HIC: Heat Inter-Changer)	-		-		
Pipe between unit and distributor	High pressure	mm (in.)	22.2 (7/8) Brazed	22.2 (7/8) Brazed	
	Low pressure	mm (in.)	28.58 (1-1/8) Brazed	28.58 (1-1/8) Brazed	
Defrosting method	Auto-defrost mode (Reversed refrigerant cycle, Liquid backless refrigerant cycle)				
Drawing	External	KB94CANX			
	Wiring	KE94L613		KE94L613	
Standard attachment	Document	Installation Manual			
	Accessory	-			
Optional parts	Twinning kit	CMY-R200VBK4			
	Joint	CMY-Y102SS-G2, CMY-Y102LS-G2, CMY-R170M-E			
	Main BC controller	CMB-M104/106/108/1012V-MA-SV(-TR)			
	Sub BC controller	CMB-M104/108V-MB-SV(-TR)			
Remarks	Details on foundation work, duct work, insulation work, electrical wiring, power source switch, and other items shall be referred to the Installation Manual. Due to continuing improvement, above specifications may be subject to change without notice.				

Notes:	Unit converter
1.Nominal cooling conditions Indoor: 27°C D.B./19°C W.B. (81°F D.B./66°F W.B.), Outdoor: 35°C D.B./24°C W.B. (95°F D.B./75°F W.B.) (subject to EN 14511-2) Pipe length: 7.5 m (24-9/16 ft.), Level difference: 0 m (0 ft.) (subject to EN 14511-3)	BTU/h =kW x 3,412 cfm =m ³ /min x 35.31 lbs =kg/0.4536
2.Max heating conditions Indoor: 20°C D.B. (68°F D.B.), Outdoor: 7°C D.B./6°C W.B. (45°F D.B./43°F W.B.) (subject to EN 14511-2) Pipe length: 7.5 m (24-9/16 ft.), Level difference: 0 m (0 ft.) (subject to EN 14511-3)	
3.Nominal heating conditions Indoor: 20°C D.B. (68°F D.B.), Outdoor: 7°C D.B./6°C W.B. (45°F D.B./43°F W.B.) (subject to EN 14511-2) Pipe length: 7.5 m (24-9/16 ft.), Level difference: 0 m (0 ft.) (subject to EN 14511-3)	
4.-10 °C D.B.(14 °F D.B.)/-11 °C W.B.(12 °F W.B.) to 21 °C D.B.(70 °F D.B.)/15.5 °C W.B.(60 °F W.B.) with cooling/heating mixed operation.	
5.Cooling mode/Heating mode	
6.The sound pressure level measured by the conventional method in JIS for reference purpose.	
7.External static pressure option is available (30 Pa, 60 Pa/3.1 mmH ₂ O, 6.1 mmH ₂ O). Consult your dealer about the specification when setting External static pressure option.	
	*Above specification data is subject to rounding variation.

Outdoor Model		PURY-M900YSXM-A(-BS)		
Power source		3-phase 4-wire 380-400-415V 50Hz		
Cooling capacity (Nominal)	*1	kW	100.0	
		BTU/h	341,200	
		Power input kW	31.94	
		Current input A	53.9-51.2-49.3	
		EER	3.13	
		SEER	7.30	
Temp. range of cooling	*4	Indoor	W.B.	
		Outdoor	D.B.	
Heating capacity (Max)		kW	112.0	
		BTU/h	382,100	
		Power input kW	34.46	
		Current input A	58.1-55.2-53.2	
		COP	3.25	
	(Nominal)	*3	kW	100.0
			BTU/h	341,200
		Power input kW	27.62	
		Current input A	46.6-44.2-42.6	
		COP	3.62	
		SCOP	4.45	
Temp. range of heating	*4	Indoor	D.B.	
		Outdoor	W.B.	
Indoor unit connectable	Total capacity	50~150% of outdoor unit capacity		
	Model/Maximum quantity	M10~M250/50		
Sound pressure level (measured in anechoic room)	*5, 6	dB <A>	67.0/72.0	
Sound power level (measured in anechoic room)	*5	dB <A>	87/93	
Refrigerant piping diameter	High pressure	mm (in.)	28.58 (1-1/8) Brazed	
	Low pressure	mm (in.)	41.28 (1-5/8) Brazed	

Set Model		PURY-M450YXM-A(-BS)		PURY-M450YXM-A(-BS)		
FAN	Type x Quantity	Propeller fan x 2		Propeller fan x 2		
	Air flow rate	m ³ /min	300		300	
		L/s	5,000		5,000	
		cfm	10,593		10,593	
	Control, Driving mechanism	Inverter-control, Direct-driven by motor		Inverter-control, Direct-driven by motor		
	Motor output	kW	0.46 x 2		0.46 x 2	
	External static press.		0 Pa (0 mmH ₂ O)		0 Pa (0 mmH ₂ O)	
Compressor	Type x Quantity	Inverter scroll hermetic compressor x1		Inverter scroll hermetic compressor x1		
	Starting method	Inverter		Inverter		
	Motor output	kW	13.5		13.5	
	Case heater	kW	-		-	
	Lubricant		MEL46EH		MEL46EH	
External finish		Pre-coated galvanized steel sheets (+powder coating for -BS type) <MUNSELL 3Y 7.8/1.1 or similar>		Pre-coated galvanized steel sheets (+powder coating for -BS type) <MUNSELL 3Y 7.8/1.1 or similar>		
External dimension H x W x D	mm	1,858 (1,798 without legs) x 1207 x 740		1,858 (1,798 without legs) x 1207 x 740		
		in.	73-3/16 (70-13/16 without legs) x 47-9/16 x 29-3/16		73-3/16 (70-13/16 without legs) x 47-9/16 x 29-3/16	
Protection devices	High pressure protection	High pressure sensor, High pressure switch at 4.15MPa (601psi)		High pressure sensor, High pressure switch at 4.15MPa (601psi)		
	Inverter circuit (COMP./FAN)	Over-heat protection, Over-current protection		Over-heat protection, Over-current protection		
	Compressor	-		-		
	Fan motor	-		-		
Refrigerant	Type x original charge	R32 x 9.3kg (21lbs)		R32 x 9.3kg (21lbs)		
	Control	Indoor LEV and BC controller				
Net weight	kg (lbs)	327 (721)		327 (721)		
Heat exchanger		Salt-resistant cross fin & copper tube		Salt-resistant cross fin & copper tube		
HIC circuit (HIC: Heat Inter-Changer)		-		-		
Pipe between unit and distributor	High pressure	mm (in.)	22.2 (7/8) Brazed		22.2 (7/8) Brazed	
	Low pressure	mm (in.)	28.58 (1-1/8) Brazed		28.58 (1-1/8) Brazed	
Defrosting method		Auto-defrost mode (Reversed refrigerant cycle, Liquid backless refrigerant cycle)				
Drawing	External	KB94CANX				
	Wiring	KE94L613		KE94L613		
Standard attachment	Document	Installation Manual				
	Accessory	-				
Optional parts	Twinning kit	CMY-R200VBK4				
	Joint	CMY-Y102SS-G2, CMY-Y102LS-G2, CMY-R170M-E				
	Main BC controller	CMB-M104/106/108/1012V-MA-SV(-TR)				
	Sub BC controller	CMB-M104/108V-MB-SV(-TR)				
Remarks	Details on foundation work, duct work, insulation work, electrical wiring, power source switch, and other items shall be referred to the Installation Manual. Due to continuing improvement, above specifications may be subject to change without notice.					

Notes:	Unit converter
1.Nominal cooling conditions Indoor: 27°C.D.B./19°C.W.B. (81°F.D.B./66°F.W.B.), Outdoor: 35°C.D.B./24°C.W.B. (95°F.D.B./75°F.W.B.) (subject to EN 14511-2) Pipe length: 7.5 m (24-9/16 ft.), Level difference: 0 m (0 ft.) (subject to EN 14511-3)	BTU/h =kW x 3,412
2.Max heating conditions Indoor: 20°C.D.B. (68°F.D.B.), Outdoor: 7°C.D.B./6°C.W.B. (45°F.D.B./43°F.W.B.) (subject to EN 14511-2) Pipe length: 7.5 m (24-9/16 ft.), Level difference: 0 m (0 ft.) (subject to EN 14511-3)	cfm =m ³ /min x 35.31
3.Nominal heating conditions Indoor: 20°C.D.B. (68°F.D.B.), Outdoor: 7°C.D.B./6°C.W.B. (45°F.D.B./43°F.W.B.) (subject to EN 14511-2) Pipe length: 7.5 m (24-9/16 ft.), Level difference: 0 m (0 ft.) (subject to EN 14511-3)	lbs =kg/0.4536
4.-10 °C.D.B.(14 °F.D.B.)-11 °C.W.B.(12 °F.W.B.) to 21 °C.D.B.(70 °F.D.B.)/15.5 °C.W.B.(60 °F.W.B.) with cooling/heating mixed operation.	
5.Cooling mode/Heating mode	
6.The sound pressure level measured by the conventional method in JIS for reference purpose.	
7.External static pressure option is available (30 Pa, 60 Pa/3.1 mmH ₂ O, 6.1 mmH ₂ O). Consult your dealer about the specification when setting External static pressure option.	
	*Above specification data is subject to rounding variation.

Outdoor Model		PURY-M950YSXM-A(-BS)		
Power source		3-phase 4-wire 380-400-415V 50Hz		
Cooling capacity (Nominal)	*1	kW	106.0	
		BTU/h	361,700	
		Power input kW	36.05	
		Current input A	60.8-57.8-55.7	
		EER	2.94	
	SEER	7.08		
Temp. range of cooling	*4	Indoor	W.B.	15.0-24.0°C (59-75°F)
		Outdoor	D.B.	-5.0-52.0°C (23-126°F)
Heating capacity (Max)	*2	kW	114.0	
		BTU/h	389,000	
		Power input kW	35.18	
		Current input A	59.3-56.4-54.3	
		COP	3.24	
	(Nominal)	*3	kW	106.0
			BTU/h	361,700
			Power input kW	29.36
		Current input A	49.5-47.0-45.3	
		COP	3.61	
	SCOP	4.40		
Temp. range of heating	*4	Indoor	D.B.	15.0-27.0°C (59-81°F)
		Outdoor	W.B.	-25.0-15.5°C (-13-60°F)
Indoor unit connectable	Total capacity	50-150% of outdoor unit capacity		
	Model/Maximum quantity	M10-M250/50		
Sound pressure level (measured in anechoic room)	*5, 6	dB <A>	69.0/72.0	
Sound power level (measured in anechoic room)	*5	dB <A>	89/94	
Refrigerant piping diameter	High pressure	mm (in.)	28.58 (1-1/8) Brazed	
	Low pressure	mm (in.)	41.28 (1-5/8) Brazed	

Set Model		PURY-M500YXM-A(-BS)		PURY-M450YXM-A(-BS)	
FAN	Type x Quantity	Propeller fan x 2		Propeller fan x 2	
		Air flow rate	m ³ /min	305	300
			L/s	5,083	5,000
			cfm	10,770	10,593
	Control, Driving mechanism	Inverter-control, Direct-driven by motor		Inverter-control, Direct-driven by motor	
	Motor output	kW	0.46 x 2	0.46 x 2	
	External static press.	0 Pa (0 mmH ₂ O)		0 Pa (0 mmH ₂ O)	
Compressor	Type x Quantity	Inverter scroll hermetic compressor x1		Inverter scroll hermetic compressor x1	
	Starting method	Inverter		Inverter	
	Motor output	kW	16.1	13.5	
	Case heater	kW	-	-	
	Lubricant	MEL46EH		MEL46EH	
External finish	Pre-coated galvanized steel sheets (+powder coating for -BS type) <MUNSELL 3Y 7.8/1.1 or similar>		Pre-coated galvanized steel sheets (+powder coating for -BS type) <MUNSELL 3Y 7.8/1.1 or similar>		
External dimension H x W x D	mm	1,858 (1,798 without legs) x 1207 x 740		1,858 (1,798 without legs) x 1207 x 740	
		in.	73-3/16 (70-13/16 without legs) x 47-9/16 x 29-3/16		73-3/16 (70-13/16 without legs) x 47-9/16 x 29-3/16
Protection devices	High pressure protection	High pressure sensor, High pressure switch at 4.15MPa (601psi)		High pressure sensor, High pressure switch at 4.15MPa (601psi)	
	Inverter circuit (COMP./FAN)	Over-heat protection, Over-current protection		Over-heat protection, Over-current protection	
	Compressor	-		-	
	Fan motor	-		-	
Refrigerant	Type x original charge	R32 x 9.3kg (21lbs)		R32 x 9.3kg (21lbs)	
	Control	Indoor LEV and BC controller			
Net weight	kg (lbs)	327 (721)		327 (721)	
Heat exchanger	Salt-resistant cross fin & copper tube		Salt-resistant cross fin & copper tube		
HIC circuit (HIC: Heat Inter-Changer)	-		-		
Pipe between unit and distributor	High pressure	mm (in.)	22.2 (7/8) Brazed	22.2 (7/8) Brazed	
	Low pressure	mm (in.)	28.58 (1-1/8) Brazed	28.58 (1-1/8) Brazed	
Defrosting method	Auto-defrost mode (Reversed refrigerant cycle, Liquid backless refrigerant cycle)				
Drawing	External	KB94CANX			
	Wiring	KE94L613		KE94L613	
Standard attachment	Document	Installation Manual			
	Accessory	-			
Optional parts	Twinning kit	CMY-R200VBK4			
	Joint	CMY-Y102SS-G2, CMY-Y102LS-G2, CMY-R170M-E			
	Main BC controller	CMB-M104/106/108/1012V-MA-SV(-TR)			
	Sub BC controller	CMB-M104/108V-MB-SV(-TR)			
Remarks	Details on foundation work, duct work, insulation work, electrical wiring, power source switch, and other items shall be referred to the Installation Manual. Due to continuing improvement, above specifications may be subject to change without notice.				

Notes:	Unit converter
1.Nominal cooling conditions Indoor: 27°C D.B./19°C W.B. (81°F D.B./66°F W.B.), Outdoor: 35°C D.B./24°C W.B. (95°F D.B./75°F W.B.) (subject to EN 14511-2) Pipe length: 7.5 m (24-9/16 ft.), Level difference: 0 m (0 ft.) (subject to EN 14511-3)	BTU/h =kW x 3,412 cfm =m ³ /min x 35.31 lbs =kg/0.4536
2.Max heating conditions Indoor: 20°C D.B. (68°F D.B.), Outdoor: 7°C D.B./6°C W.B. (45°F D.B./43°F W.B.) (subject to EN 14511-2) Pipe length: 7.5 m (24-9/16 ft.), Level difference: 0 m (0 ft.) (subject to EN 14511-3)	
3.Nominal heating conditions Indoor: 20°C D.B. (68°F D.B.), Outdoor: 7°C D.B./6°C W.B. (45°F D.B./43°F W.B.) (subject to EN 14511-2) Pipe length: 7.5 m (24-9/16 ft.), Level difference: 0 m (0 ft.) (subject to EN 14511-3)	
4.-10 °C D.B.(14 °F D.B.)/-11 °C W.B.(12 °F W.B.) to 21 °C D.B.(70 °F D.B.)/15.5 °C W.B.(60 °F W.B.) with cooling/heating mixed operation.	
5.Cooling mode/Heating mode	
6.The sound pressure level measured by the conventional method in JIS for reference purpose.	
7.External static pressure option is available (30 Pa/3.1 mmH ₂ O). Consult your dealer about the specification when setting External static pressure option.	
	*Above specification data is subject to rounding variation.

Outdoor Model		PURY-M1000YSXM-A(-BS)		
Power source		3-phase 4-wire 380-400-415V 50Hz		
Cooling capacity (Nominal)	*1	kW	112.0	
		BTU/h	382,100	
		Power input kW	40.87	
		Current input A	68.9-65.5-63.1	
		EER	2.74	
	SEER	kW/kW	6.86	
Temp. range of cooling	*4	Indoor	W.B.	15.0~24.0°C (59~75°F)
		Outdoor	D.B.	-5.0~52.0°C (23~126°F)
Heating capacity (Max)	*2	kW	116.0	
		BTU/h	395,800	
		Power input kW	35.91	
		Current input A	60.6-57.5-55.5	
		COP	kW/kW	3.23
	(Nominal)	*3	kW	112.0
		BTU/h	382,100	
	Power input kW	31.19		
	Current input A	52.6-50.0-48.2		
	COP	kW/kW	3.59	
	SCOP	kW/kW	4.35	
Temp. range of heating	*4	Indoor	D.B.	15.0~27.0°C (59~81°F)
		Outdoor	W.B.	-25.0~15.5°C (-13~60°F)
Indoor unit connectable	Total capacity		50~150% of outdoor unit capacity	
	Model/Maximum quantity		M10~M250/50	
Sound pressure level (measured in anechoic room)	*5, 6	dB <A>	71.0/73.0	
Sound power level (measured in anechoic room)	*5	dB <A>	91/95	
Refrigerant piping diameter	High pressure		mm (in.) 28.58 (1-1/8) Brazed	
	Low pressure		mm (in.) 41.28 (1-5/8) Brazed	

Set Model

Outdoor Model		PURY-M500YXM-A(-BS)		PURY-M500YXM-A(-BS)		
FAN	Type x Quantity		Propeller fan x 2		Propeller fan x 2	
	Air flow rate	m ³ /min	305		305	
		L/s	5,083		5,083	
		cfm	10,770		10,770	
	Control, Driving mechanism		Inverter-control, Direct-driven by motor		Inverter-control, Direct-driven by motor	
	Motor output	kW	0.46 x 2		0.46 x 2	
	External static press.		0 Pa (0 mmH ₂ O)		0 Pa (0 mmH ₂ O)	
Compressor	Type x Quantity		Inverter scroll hermetic compressor x 1		Inverter scroll hermetic compressor x 1	
	Starting method		Inverter		Inverter	
	Motor output	kW	16.1		16.1	
	Case heater	kW	-		-	
	Lubricant		MEL46EH		MEL46EH	
External finish		Pre-coated galvanized steel sheets (+powder coating for -BS type) <MUNSELL 3Y 7.8/1.1 or similar>		Pre-coated galvanized steel sheets (+powder coating for -BS type) <MUNSELL 3Y 7.8/1.1 or similar>		
External dimension H x W x D		mm	1,858 (1,798 without legs) x 1207 x 740		1,858 (1,798 without legs) x 1207 x 740	
		in.	73-3/16 (70-13/16 without legs) x 47-9/16 x 29-3/16		73-3/16 (70-13/16 without legs) x 47-9/16 x 29-3/16	
Protection devices	High pressure protection		High pressure sensor, High pressure switch at 4.15MPa (601psi)		High pressure sensor, High pressure switch at 4.15MPa (601psi)	
	Inverter circuit (COMP./FAN)		Over-heat protection, Over-current protection		Over-heat protection, Over-current protection	
	Compressor		-		-	
	Fan motor		-		-	
Refrigerant	Type x original charge		R32 x 9.3kg (21lbs)		R32 x 9.3kg (21lbs)	
	Control		Indoor LEV and BC controller			
Net weight	kg (lbs)	327 (721)		327 (721)		
Heat exchanger		Salt-resistant cross fin & copper tube				
HIC circuit (HIC: Heat Inter-Changer)		-				
Pipe between unit and distributor	High pressure	mm (in.)	22.2 (7/8) Brazed		22.2 (7/8) Brazed	
	Low pressure	mm (in.)	28.58 (1-1/8) Brazed		28.58 (1-1/8) Brazed	
Defrosting method		Auto-defrost mode (Reversed refrigerant cycle, Liquid backless refrigerant cycle)				
Drawing	External		KB94CANX			
	Wiring		KE94L613		KE94L613	
Standard attachment	Document		Installation Manual			
	Accessory		-			
Optional parts	Twinning kit		CMY-R200VBK4			
	Joint		CMY-Y102SS-G2, CMY-Y102LS-G2, CMY-R170M-E			
	Main BC controller		CMB-M104/106/108/1012V-MA-SV(-TR)			
	Sub BC controller		CMB-M104/108V-MB-SV(-TR)			
Remarks		Details on foundation work, duct work, insulation work, electrical wiring, power source switch, and other items shall be referred to the Installation Manual. Due to continuing improvement, above specifications may be subject to change without notice.				

Notes:

- Nominal cooling conditions
Indoor: 27°C D.B./19°C W.B. (81°F D.B./66°F W.B.), Outdoor: 35°C D.B./24°C W.B. (95°F D.B./75°F W.B.) (subject to EN 14511-2)
Pipe length: 7.5 m (24-9/16 ft.), Level difference: 0 m (0 ft.) (subject to EN 14511-3)
- Max heating conditions
Indoor: 20°C D.B. (68°F D.B.), Outdoor: 7°C D.B./6°C W.B. (45°F D.B./43°F W.B.) (subject to EN 14511-2)
Pipe length: 7.5 m (24-9/16 ft.), Level difference: 0 m (0 ft.) (subject to EN 14511-3)
- Nominal heating conditions
Indoor: 20°C D.B. (68°F D.B.), Outdoor: 7°C D.B./6°C W.B. (45°F D.B./43°F W.B.) (subject to EN 14511-2)
Pipe length: 7.5 m (24-9/16 ft.), Level difference: 0 m (0 ft.) (subject to EN 14511-3)
- 10 °C D.B. (14 °F D.B.)/-11 °C W.B. (12 °F W.B.) to 21 °C D.B. (70 °F D.B.)/15.5 °C W.B. (60 °F W.B.) with cooling/heating mixed operation.
- Cooling mode/Heating mode
- The sound pressure level measured by the conventional method in JIS for reference purpose.
- External static pressure option is available (30 Pa/3.1 mmH₂O).
Consult your dealer about the specification when setting External static pressure option.

Unit converter	
BTU/h	=kW x 3.412
cfm	=m ³ /min x 35.31
lbs	=kg/0.4536

*Above specification data is subject to rounding variation.

PURY-M200, 250, 300YXM-A (-BS)

Unit: mm

Connecting pipe specifications

Model	Refrigerant pipe *1		Service valve	
	High pressure	Low pressure	High pressure	Low pressure
M200	φ15.88 Brazed	φ19.05 Brazed	φ28.58	φ28.58
M250	φ19.05 Brazed	φ22.2 Brazed	φ28.58	φ28.58
M300	φ19.05 Brazed	φ22.2 Brazed	φ28.58	φ28.58

*1 Connect the refrigerant pipe to the service valve according to the installation Manual.

No.	Usage	Specifications
①	Front through hole	145 x 77 Knockout hole
②	Bottom through hole	150 x 90 Knockout hole
③	Front through hole	φ65 or φ40 Knockout hole
④	Front through hole	φ52 or φ27 Knockout hole
⑤	Bottom through hole	φ65 Knockout hole
⑥	Bottom through hole	φ52 Knockout hole
⑦	Front through hole	φ34 Knockout hole
⑧	Bottom through hole	φ34 Knockout hole

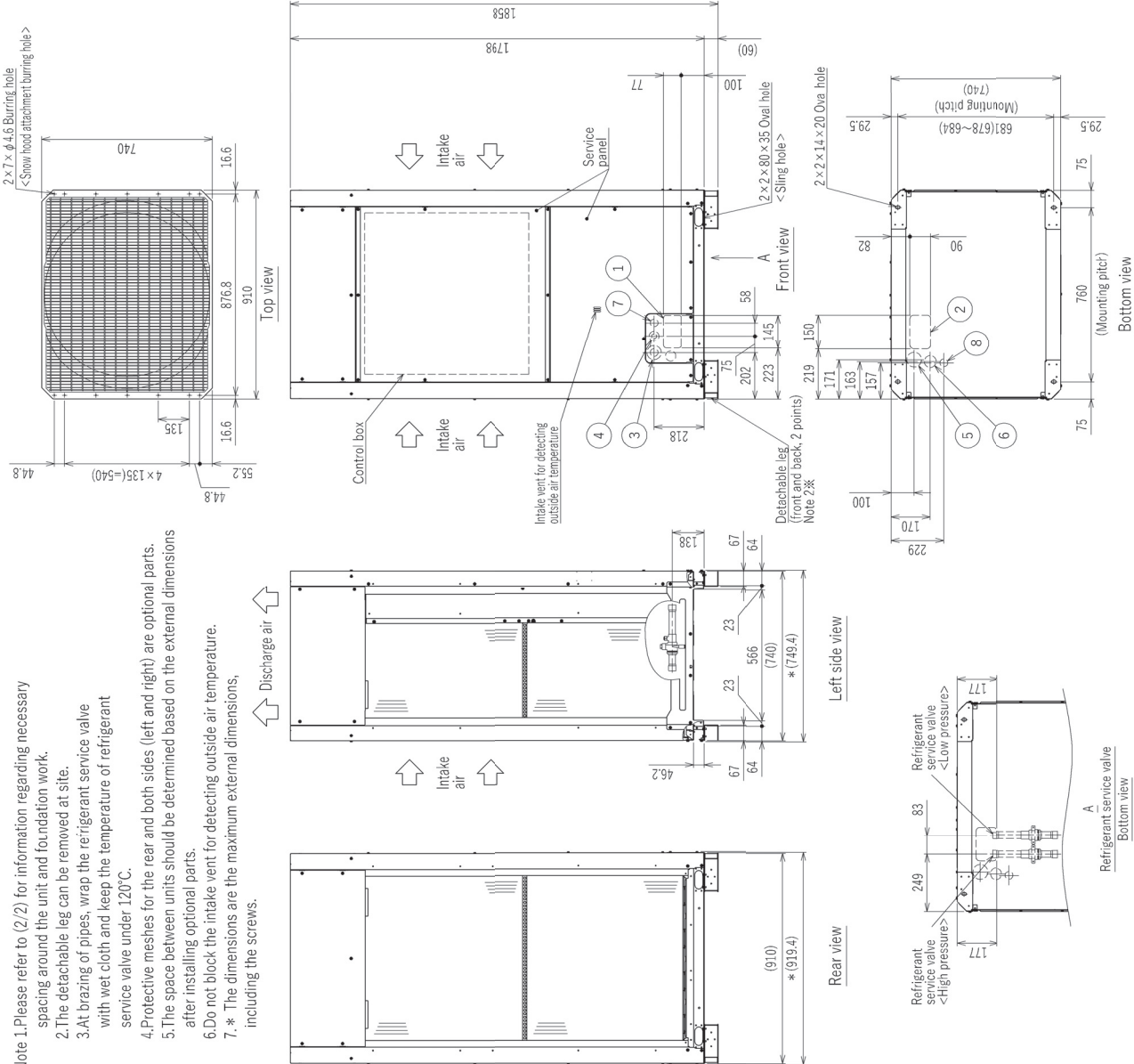

- Note 1. Please refer to (2/2) for information regarding necessary spacing around the unit and foundation work.
- The detachable leg can be removed at site.
 - At brazing of pipes, wrap the refrigerant service valve with wet cloth and keep the temperature of refrigerant service valve under 120°C.
 - Protective meshes for the rear and both sides (left and right) are optional parts.
 - The space between units should be determined based on the external dimensions after installing optional parts.
 - Do not block the intake vent for detecting outside air temperature.
 - * The dimensions are the maximum external dimensions, including the screws.

PURY-M200, 250, 300YXM-A (-BS)

Unit: mm

1. Required space around the unit

In case of single installation

① Secure enough space around the unit as shown in the figure below.

- With a space of at least 300mm to the wall on the back of the unit

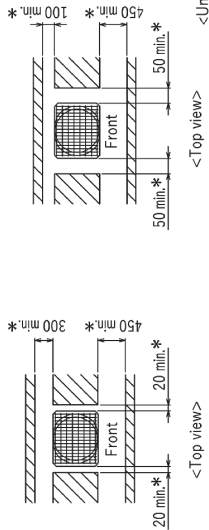

② When the height of the walls on the front, back or on the sides <math>H < h/2 ></math> exceeds the wall height limit as defined below add half of the height that exceeds the height limit $h/2 >$ to the figures that are marked with an asterisk (*).

When adjacent to a building wall, ensure that at least two directions are open, with a rear space of at least 300mm and a side space of at least 200mm from the wall.

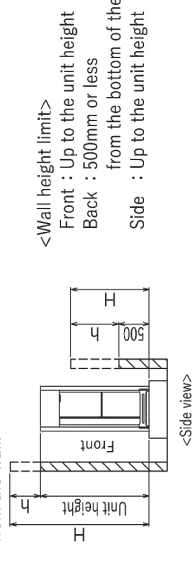

2. Foundation work

① Take into consideration the surface strength, water drainage route, piping route, and wiring route when preparing the installation site.

<Note that the drain water comes out of the unit during operation.>

② Build the foundation in such way that the corner of the installation leg is securely supported as shown in the right figure. (Fig.A,B)

When using a rubber isolating cushion, please ensure it is large enough to cover the entire width of each of the unit's legs.

③ The protrusion length of the anchor bolt must not exceed 30mm. (Fig.A,B)

④ Use four fixing plates as shown in the right figure <field supply required> when using M12 hole-in anchor bolts <field supply required>. (Fig.C,D)

⑤ To prevent small animals and water and snow from entering the unit and damaging its parts, close the gap around the edges of through holes for pipes and wires with filler plates <field supply required>.

⑥ When the pipes or cables are routed at the bottom of the unit, make sure that the through hole at the base of the unit does not get blocked with the installation base.

⑦ Refer to the Installation Manual when installing units on an installation base.

In case of collective installation

① When multiple units are installed adjacent to each other, secure enough space to allow for air circulation and walkway between groups of units as shown in the figures below.

② At least two sides must be left open.

③ As with the single installation, add half of the height that exceeds the height limit $h/2 >$ to the figures that are marked with an asterisk (*).

When adjacent to a building wall, ensure that at least two directions are open, with a rear space of at least 300mm and a side space of at least 200mm from the wall.

④ When installing units side by side, ensure a space of at least 400mm between the units. If there is a wall at both the front and the rear of the unit, install up to six units consecutively in the side direction and provide a space of 1000mm or more as inlet space / passage space for each six units.

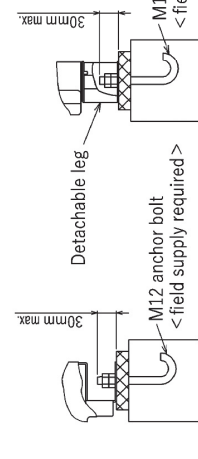
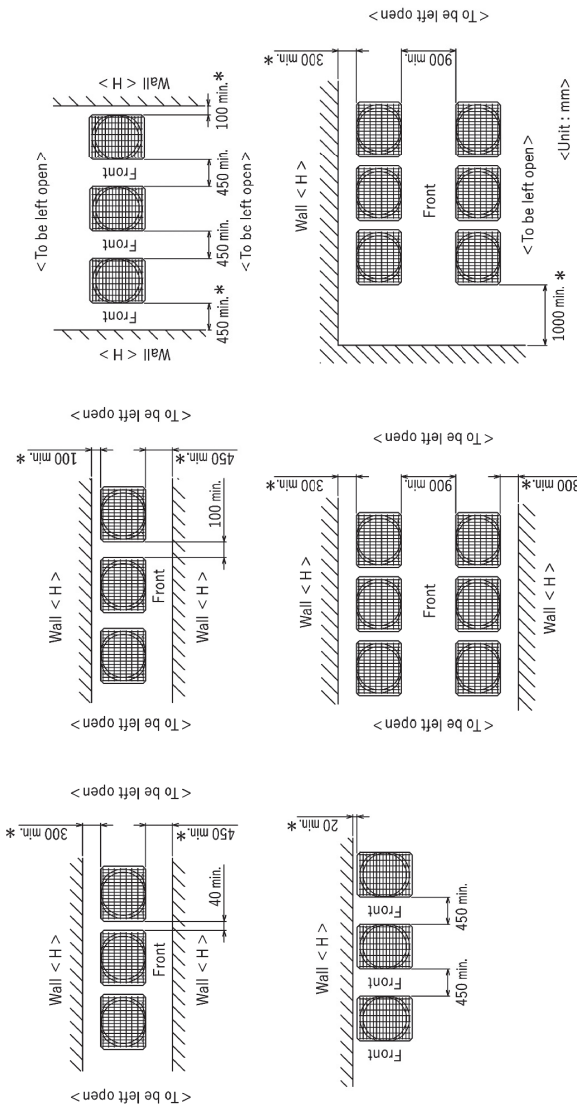

Fig. A (without detachable legs)

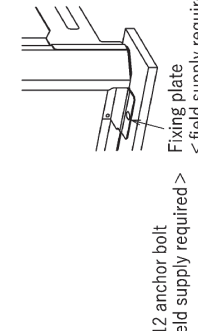

Fig. B (with detachable legs)

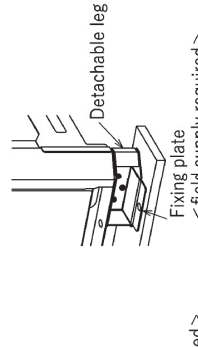

Fig. C (without detachable legs)

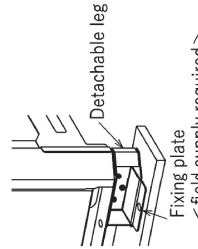

Fig. D (with detachable legs)

PURY-M350, 400, 450, 500YXM-A (-BS)

Unit: mm

PURY-M-Y(S)XM-A

Connecting pipe specifications

Model	Refrigerant pipe *1		Diameter	
	High pressure	Low pressure	High pressure	Low pressure
M350	φ19.05	φ28.58	Brazed	φ28.58
M400	φ22.2	φ28.58	Brazed	φ28.58
M450	φ22.2	φ28.58	Brazed	φ28.58
M500	φ22.2	φ28.58	Brazed	φ28.58

*1 Connect the refrigerant pipe to the service valve according to the Installation Manual.

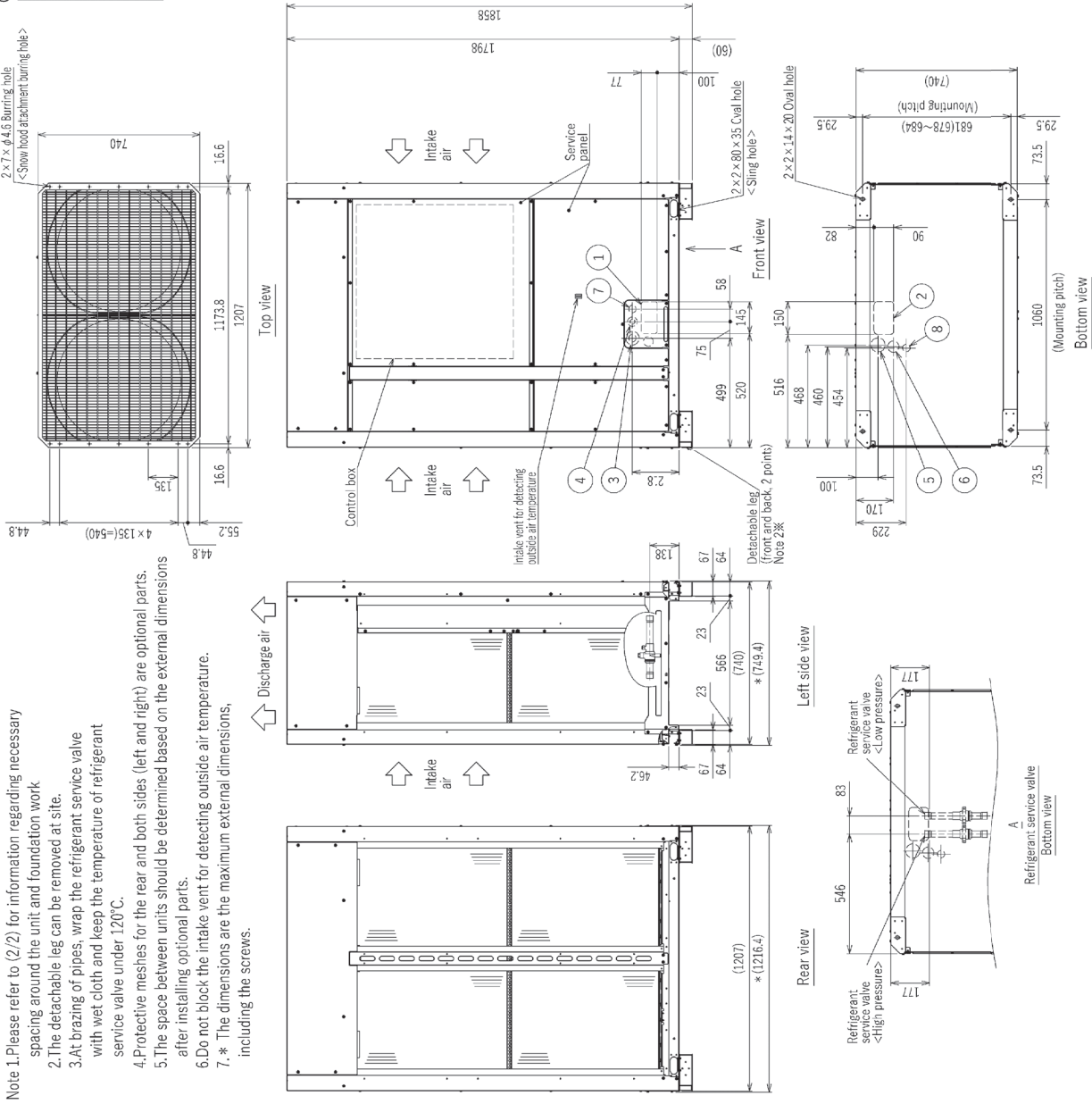

NO.	Usage	Specifications
①	Front through hole	145 × 77 Knockout hole
②	Bottom through hole	150 × 90 Knockout hole
③	Front through hole	φ65 or φ40 Knockout hole
④	Front through hole	φ52 or φ27 Knockout hole
⑤	Bottom through hole	φ65 Knockout hole
⑥	Bottom through hole	φ52 Knockout hole
⑦	Front through hole	φ34 Knockout hole
⑧	Bottom through hole	φ34 Knockout hole

- Note 1. Please refer to (2/2) for information regarding necessary spacing around the unit and foundation work.
- 2. The detachable leg can be removed at site.
- 3. At brazing of pipes, wrap the refrigerant service valve with wet cloth and keep the temperature of refrigerant service valve under 120°C.
- 4. Protective meshes for the rear and both sides (left and right) are optional parts.
- 5. The space between units should be determined based on the external dimensions after installing optional parts.
- 6. Do not block the intake vent for detecting outside air temperature.
- 7. * The dimensions are the maximum external dimensions, including the screws.

Unit: mm

1. Required space around the unit

● In case of single installation

① Secure enough space around the unit as shown in the figure below.

- With a space of at least 300mm to the wall on the back of the unit

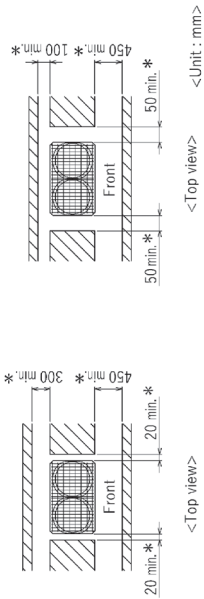

② When the height of the walls on the front, back or on the sides <math>< H ></math> exceeds the wall height limit as defined below add half of the height that exceeds the height limit <math>< h/2 ></math> to the figures that are marked with an asterisk (*).

When adjacent to a building wall, ensure that at least two directions are open, with a rear space of at least 300mm and a side space of at least 200mm from the wall.

<math>< \text{Wall height limit} ></math>
 Front : Up to the unit height
 Back : 500mm or less from the bottom of the unit
 Side : Up to the unit height

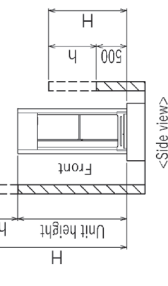

2. Foundation work

- Take into consideration the surface strength, water drainage route, piping route, and wiring route when preparing the installation site.
 <math>< \text{Note that the drain water comes out of the unit during operation.} ></math>
- Build the foundation in such way that the corner of the installation leg is securely supported as shown in the right figure.(Fig.A,B)
 When using a rubber isolating cushion, please ensure it is large enough to cover the entire width of each of the unit's legs.
- The protrusion length of the anchor bolt must not exceed 30mm.(Fig.A,B)
- Use four fixing plates as shown in the right figure <math>< \text{field supply required} ></math> when using M12 hole-in anchor bolts <math>< \text{field supply required} ></math> (Fig.C,D)
- To prevent small animals and water and snow from entering the unit and damaging its parts, close the gap around the edges of through holes for pipes and wires with filler plates <math>< \text{field supply required} ></math>.
- When the pipes or cables are routed at the bottom of the unit, make sure that the through hole at the base of the unit does not get blocked with the installation base.
- Refer to the Installation Manual when installing units on an installation base.

● In case of collective installation

- When multiple units are installed adjacent to each other, secure enough space to allow for air circulation and walkway between groups of units as shown in the figures below.
- At least two sides must be left open.
- As with the single installation, add half of the height that exceeds the height limit <math>< h/2 ></math> to the figures that are marked with an asterisk(*).
 When adjacent to a building wall, ensure that at least two directions are open, with a rear space of at least 300mm and a side space of at least 200mm from the wall.
 When installing units side by side, ensure a space of at least 400mm between the units.
- If there is a wall at both the front and the rear of the unit, install up to six units consecutively in the side direction and provide a space of 1000mm or more as inlet space / passage space for each six units.

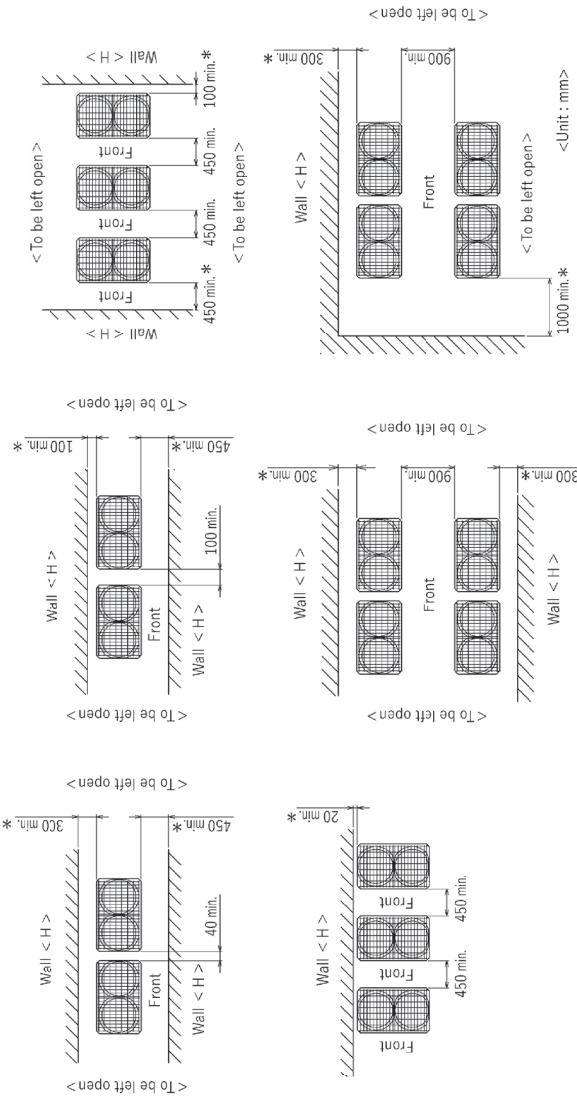

Fig. A (without detachable legs)

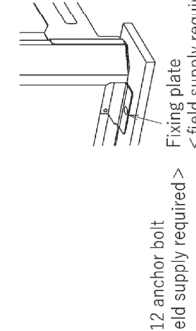

Fig. B (with detachable legs)

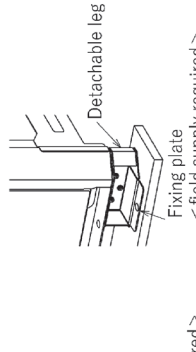

Fig. C (without detachable legs)

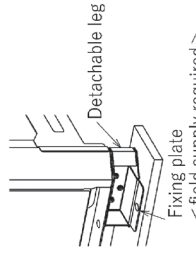
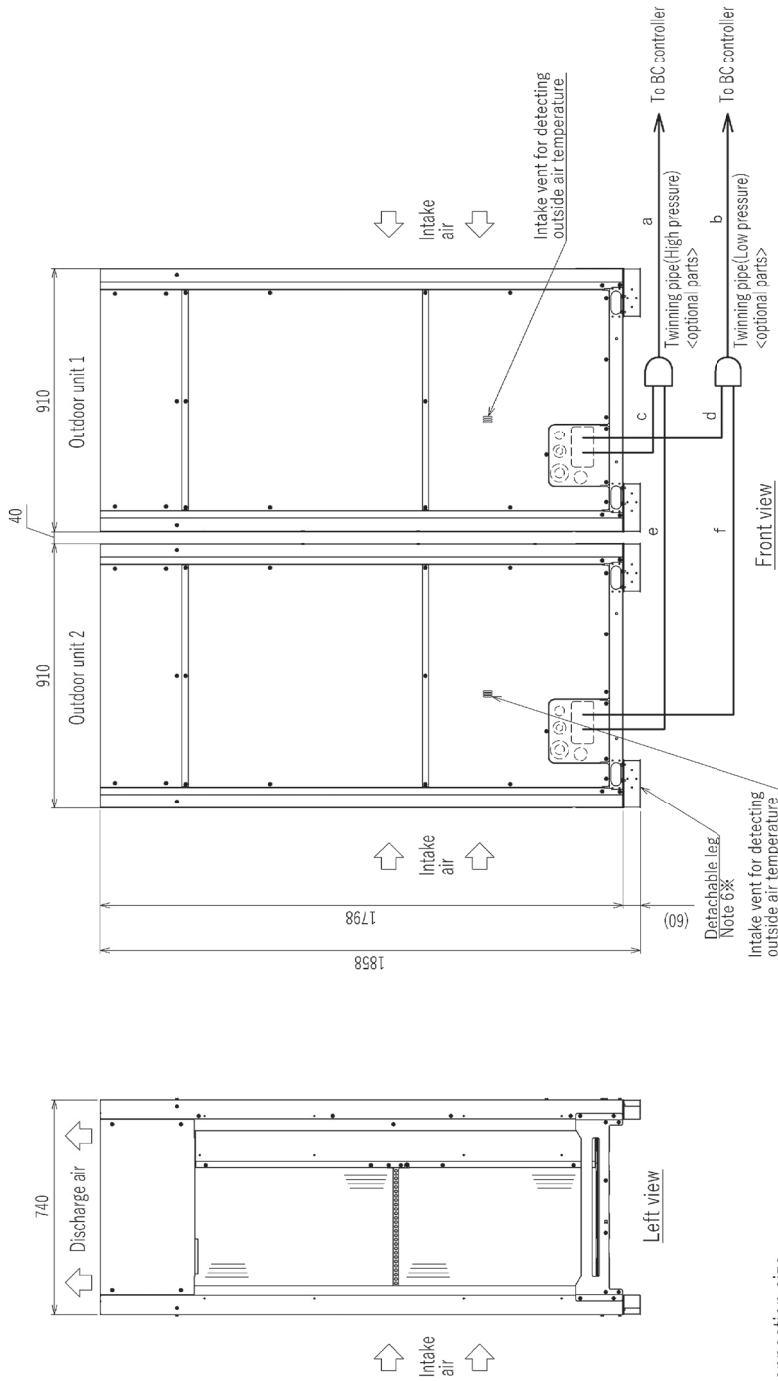

Fig. D (with detachable legs)

PURY-M400, 450, 500, 550, 600YSXM-A (-BS)

Unit: mm



Twinning pipe connection size

Package unit name	PURY-M400YSXM-A(-BS)	PURY-M450YSXM-A(-BS)	PURY-M500YSXM-A(-BS)	PURY-M550YSXM-A(-BS)	PURY-M600YSXM-A(-BS)
Outdoor unit 1	PURY-M200YSXM-A(-BS)	PURY-M250YSXM-A(-BS)	PURY-M300YSXM-A(-BS)	PURY-M350YSXM-A(-BS)	PURY-M400YSXM-A(-BS)
Outdoor unit 2	PURY-M200YSXM-A(-BS)	PURY-M250YSXM-A(-BS)	PURY-M300YSXM-A(-BS)	PURY-M350YSXM-A(-BS)	PURY-M400YSXM-A(-BS)
Outdoor Twinning Kit (optional parts)	CMY-R100VBK4	CMY-R100VBK4	CMY-R100VBK4	CMY-R100VBK4	CMY-R100VBK4
BC controller					
~ Twinning pipe	High pressure a	High pressure b	High pressure c	High pressure d	High pressure e
	Low pressure	Low pressure	Low pressure	Low pressure	Low pressure
Twinning pipe	~ Outdoor unit 1	~ Outdoor unit 1	~ Outdoor unit 1	~ Outdoor unit 1	~ Outdoor unit 1
Twinning pipe	~ Outdoor unit 2	~ Outdoor unit 2	~ Outdoor unit 2	~ Outdoor unit 2	~ Outdoor unit 2
	φ22.2	φ22.2	φ22.2	φ22.2	φ22.2
	φ28.58	φ28.58	φ28.58	φ28.58	φ28.58
	φ15.88	φ15.88	φ15.88	φ15.88	φ15.88
	φ19.05	φ19.05	φ19.05	φ19.05	φ19.05
	φ15.88	φ15.88	φ15.88	φ15.88	φ15.88
	φ19.05	φ19.05	φ19.05	φ19.05	φ19.05
	φ22.2	φ22.2	φ22.2	φ22.2	φ22.2
	φ22.2 (φ28.53)	φ22.2 (φ28.53)	φ22.2 (φ28.53)	φ22.2 (φ28.53)	φ22.2 (φ28.53)

*When the piping length is 65m or longer, use the φ28.58 pipe for the part that exceeds 65m.

Note 1. Connect the pipes as shown in the figure above. Refer to the table above for the pipe size.

2. Twinning pipes must be installed horizontally using a level vessel.

Be sure to see the Installation Manual for details of Twinning pipe installation.

3. The pipe section before the Twinning pipe (section "a" and "b" in the figure) must have at least 500mm of straight section

(* including the straight pipe that is supplied with the Twinning pipe).

4. Only use the Twinning pipe by Mitsubishi (optional parts).

5. Do not block the intake vent for detecting outside air temperature.

6. The detachable leg can be removed at site.

PURY-M650YSXM-A (-BS)

Unit: mm

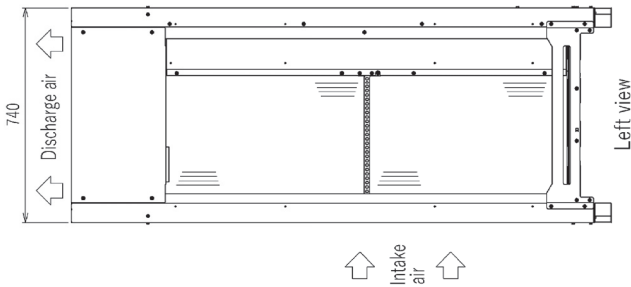
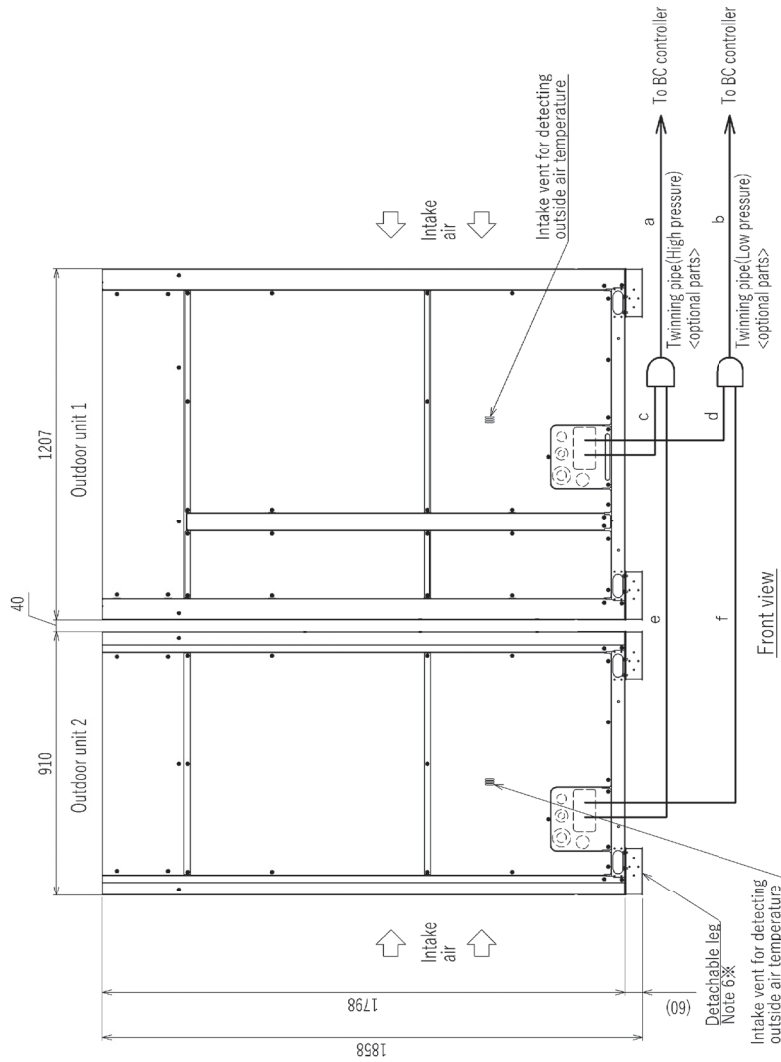

Twinning pipe connection size

Package unit name	PURY-M650YSXM-A(-BS)	
Component unit name	Outdoor unit 1	Outdoor unit 2
Outdoor unit name	PURY-M350YSXM-A(-BS)	PURY-M300YSXM-A(-BS)
Outdoor Twinning Kit (optional parts)	CMY-R100VBK4	
BC controller		
~Twinning pipe	High pressure a	Low pressure b
	Low pressure c	High pressure d
~Outdoor unit 1	High pressure e	Low pressure f
~Outdoor unit 2	Low pressure f	

1. Connect the pipes as shown in the figure above. Refer to the table above for the pipe size.
2. Twinning pipes must be installed horizontally using a level vessel.
3. Be sure to see the Installation Manual for details of Twinning pipe installation.
4. The pipe section before the Twinning pipe (section "a" and "b" in the figure) must have at least 500mm of straight section (* including the straight pipe that is supplied with the Twinning pipe).
5. Only use the Twinning pipe by Mitsubishi (optional parts).
6. Do not block the intake vent for detecting outside air temperature.
7. The detachable leg can be removed at site.

PURY-M700, 750, 800, 850, 900, 950, 1000YSXM-A (-BS)

Unit: mm

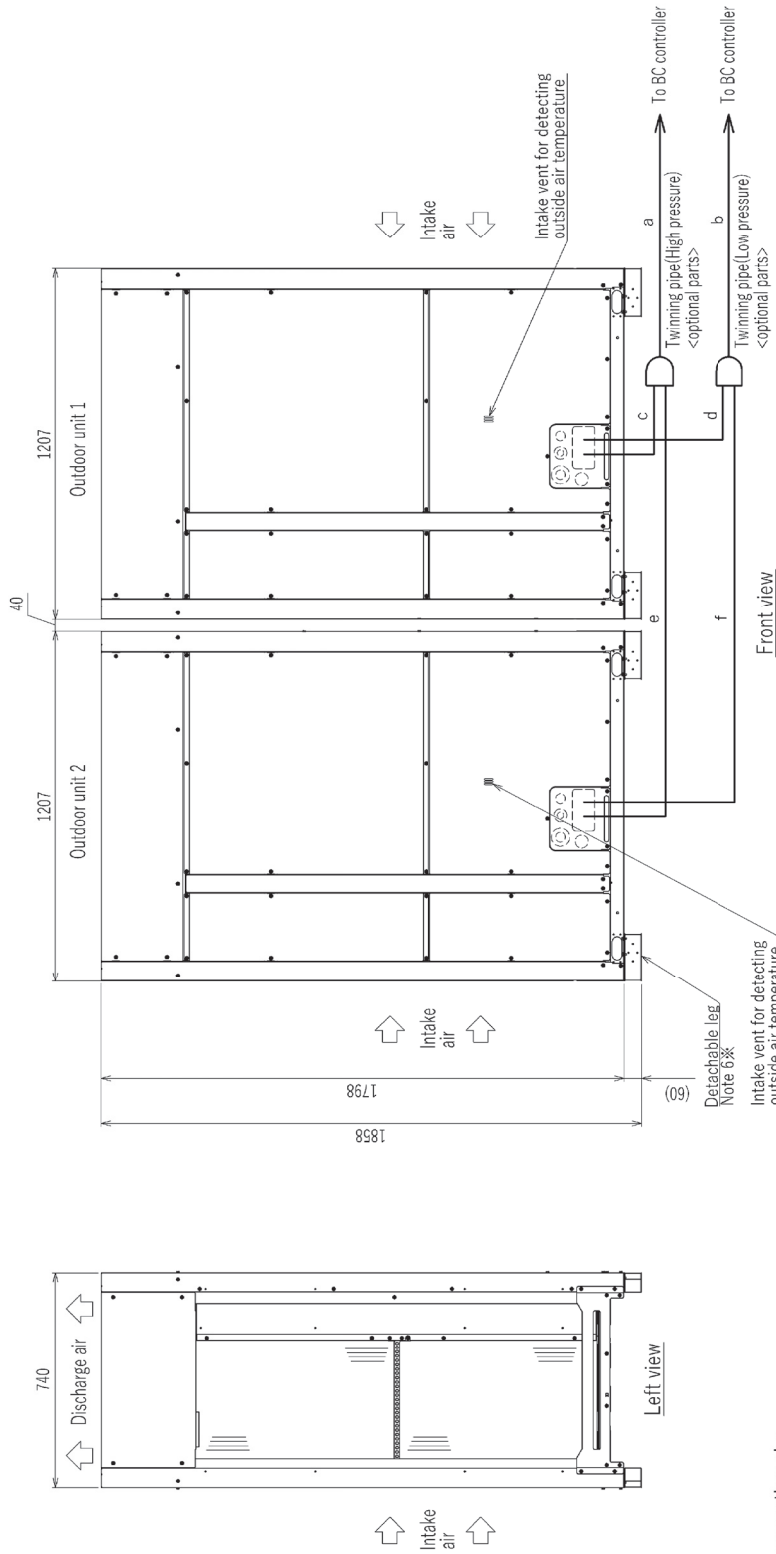

Twinning pipe connection size

Package unit name	PURY-M700YSXM-A(-BS)	PURY-M750YSXM-A(-BS)	PURY-M800YSXM-A(-BS)	PURY-M850YSXM-A(-BS)	PURY-M900YSXM-A(-BS)	PURY-M950YSXM-A(-BS)	PURY-M1000YSXM-A(-BS)
Outdoor unit 1	PURY-M350YXM-A(-BS)	PURY-M400YXM-A(-BS)	PURY-M450YXM-A(-BS)	PURY-M500YXM-A(-BS)	PURY-M550YXM-A(-BS)	PURY-M600YXM-A(-BS)	PURY-M650YXM-A(-BS)
Outdoor unit 2	PURY-M350YXM-A(-BS)	PURY-M400YXM-A(-BS)	PURY-M450YXM-A(-BS)	PURY-M500YXM-A(-BS)	PURY-M550YXM-A(-BS)	PURY-M600YXM-A(-BS)	PURY-M650YXM-A(-BS)
Outdoor Twinning Kit (optional parts)	CMY-R200VBK4	CMY-R200VBK4	CMY-R200VBK4	CMY-R200VBK4	CMY-R200VBK4	CMY-R200VBK4	CMY-R200VBK4
BC controller							
~Twinning pipe							
High pressure	a	φ 28.58	φ 28.58	φ 28.58	φ 28.58	φ 28.58	φ 28.58
Low pressure	b	φ 34.93	φ 34.93	φ 41.28	φ 41.28	φ 41.28	φ 41.28
Twinning pipe							
High pressure	c	φ 22.2	φ 22.2	φ 22.2	φ 22.2	φ 22.2	φ 22.2
Low pressure	d	φ 28.58	φ 28.58	φ 28.58	φ 28.58	φ 28.58	φ 28.58
Twinning pipe							
High pressure	e	φ 19.05	φ 22.2	φ 22.2	φ 22.2	φ 22.2	φ 22.2
Low pressure	f	φ 28.58	φ 28.58	φ 28.58	φ 28.58	φ 28.58	φ 28.58

Note 1. Connect the pipes as shown in the figure above. Refer to the table above for the pipe size.

Note 2. Twinning pipes must be installed horizontally using a level vessel.

Note 3. Be sure to see the Installation Manual for details of Twinning pipe installation.

Note 4. The pipe section before the Twinning pipe (section "a" and "b" in the figure) must have at least 500mm of straight section

Note 5. (* including the straight pipe that is supplied with the Twinning pipe).

Note 6. Only use the Twinning pipe by Mitsubishi (optional parts).

Note 7. Do not block the intake vent for detecting outside air temperature.

Note 8. The detachable leg can be removed at site.

PURY-M200, 250, 300YXM-A (-BS)

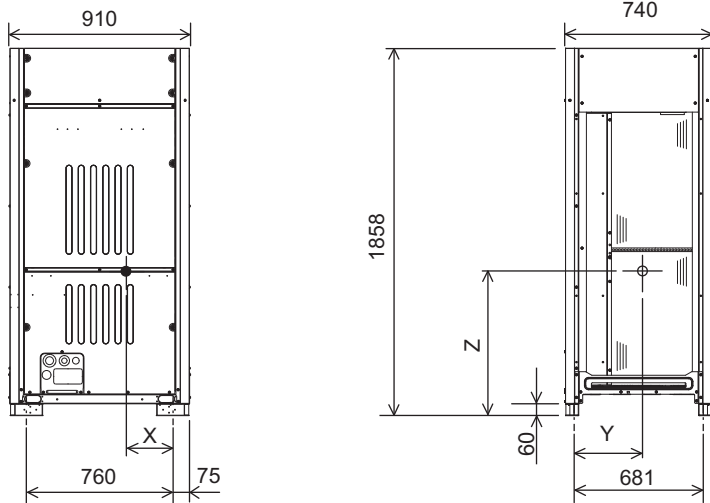

Unit: mm

Model	X	Y	Z
PURY-M200YXM-A(-BS)	342	286	777
PURY-M250YXM-A(-BS)	342	286	777
PURY-M300YXM-A(-BS)	342	284	779

PURY-M350, 400, 450, 500YXM-A (-BS)

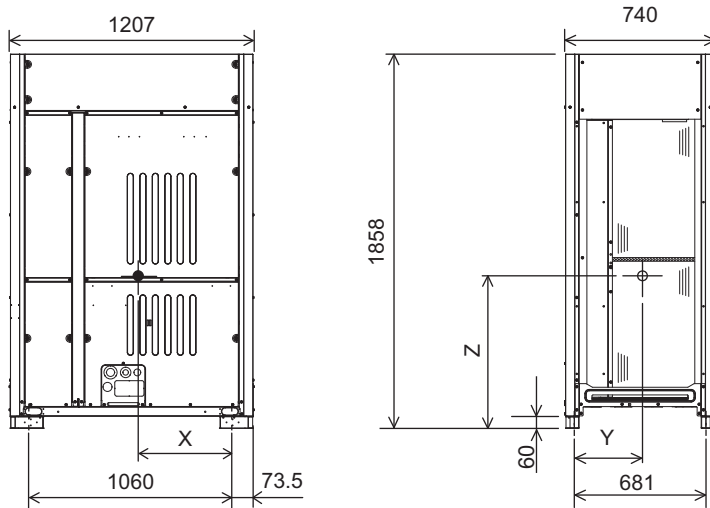

Unit: mm

Model	X	Y	Z
PURY-M350YXM-A(-BS)	431	307	825
PURY-M400YXM-A(-BS)	429	305	823
PURY-M450YXM-A(-BS)	429	305	823
PURY-M500YXM-A(-BS)	429	305	823

PURY-M200, 250, 300YXM-A-(BS)

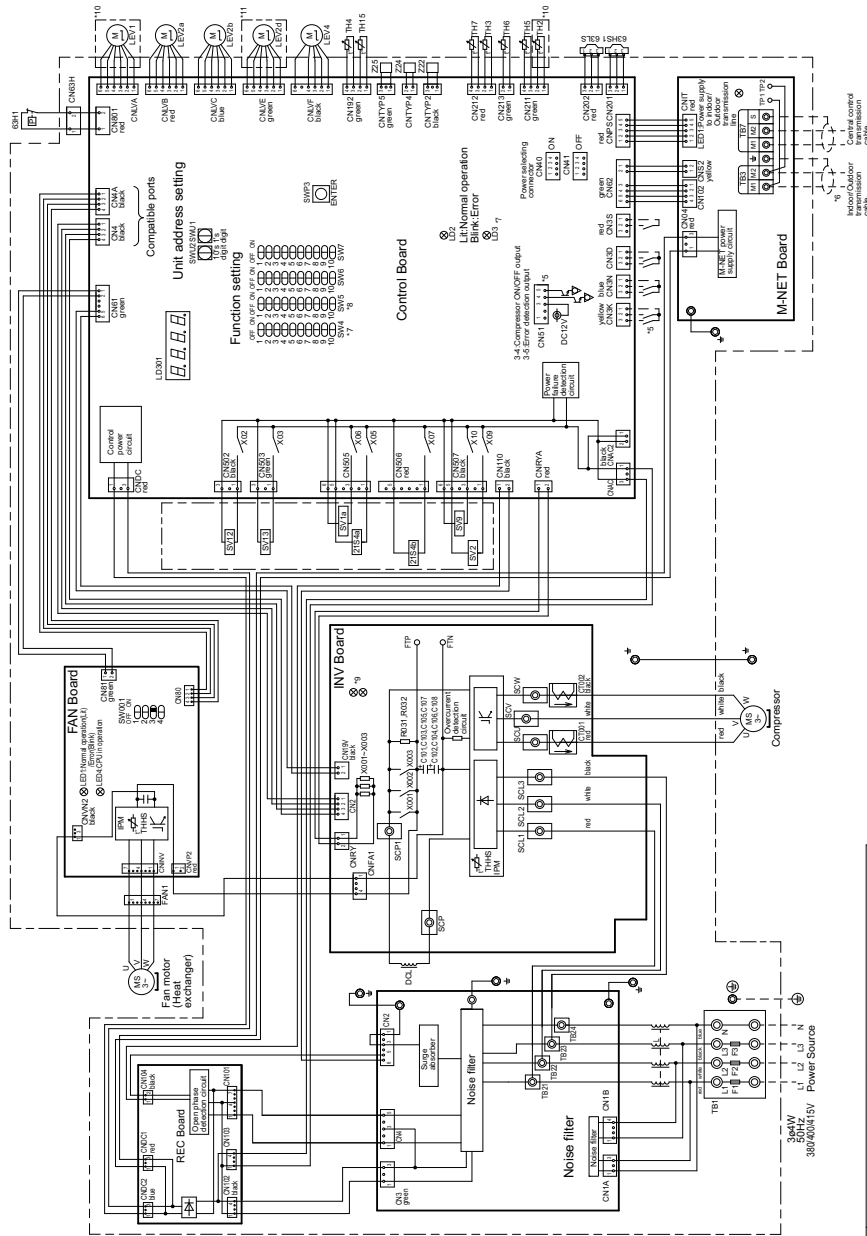

- *1. Dot-dash lines indicate wiring not supplied with unit.
- *2. Single-dotted lines indicate the control box boundaries.
- *3. Control box houses high-voltage parts. Before inspecting the inside of the control box, turn off the power, keep the unit off for at least 10 minutes, and confirm that the voltage between the FTP and FTN terminals on the INV board has dropped to DC20V or less.
- *4. There are many high-temperature parts inside and on the back of the control box, so exercise caution even after turning off the power.
- *5. Refer to the Data book for connecting input/output signal connectors.
- *6. Refer to the Data book for outdoor units in the same refrigerant system.
- *7. SW4: In the case of All OFF
 - *LD3 Lit/Operation
 - Blink: Turning on
 - Unit: Turn off
- Refer to the Data book and Service Handbook for other switch setting and monitoring items.
- *8. Setting the Central control switch(SW5-1).

System configuration	SW5-1
No connection system with the system controller	OFF
Connection system with the system controller	ON

*9. Refer to the following for the LED on the INV board.

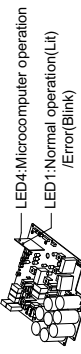

*10. Difference of appliance

Model name	Appliance
PURY	*10 do not exist

*11. Difference of appliance

Model name	Appliance
PURY	*11 do not exist
PURY	*11 exist

<Symbol explanation>

Symbol	Explanation	Symbol	Explanation
Z1S4a	4-way valve	SV1a	Solenoid valve
Z1S4b	Pressure switch (high pressure protection)	SV2	For opening/closing the bypass circuit under the O/S
63HT	Pressure		For opening/closing the high and low pressure bypass on switching
X03	Discharge pressure		For on/off switching
X03-1	Discharge pressure		For on defrost switching
C101-C108	Magnetic relay (main circuit)		Power supply
C1001.002	Capacitor (inverter main circuit)		Indoor/Outdoor transmission cable
DCL	DC reactor (for high-frequency noise reduction)		Central control transmission cable
LEV1	Linear expansion valve		Subcool bypass outlet temperature
LEV2a	Pressure control		Pipe temperature
LEV2b	Refrigerant flow rate control		Discharge pipe temperature
LEV2c	Refrigerant flow rate control		ACC inlet pipe temperature
LEV4	Pressure control		Subcooled liquid refrigerant temperature
	Refrigerant flow rate control		O/A temperature
	For opening/closing the bypass		Evaporation of compressor lower shell temperature
R031 R032	Resistor	Z22 Z24 Z25	Function setting connector
	Inrush current prevention	F1, F2, F3	Fuse (600VAC 100A)

PURY-M350, 400, 450, 500YX-M-A(-BS)

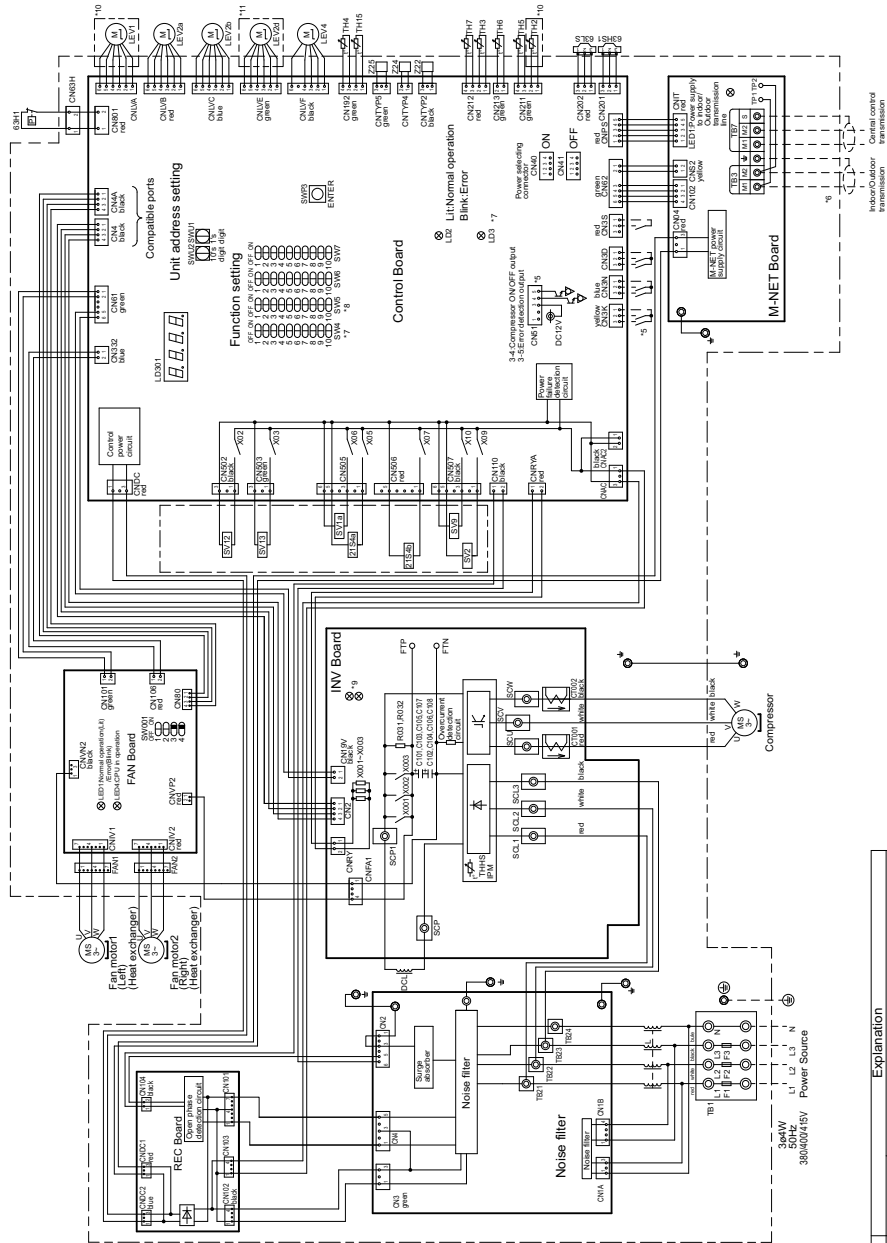

- *1. Dot-dash lines indicate wiring not supplied with unit.
- *2. Single-dotted lines indicate the control box boundaries.
- *3. Control box houses high-voltage parts. Before inspecting the inside of the control box, turn off the power, keep the unit off for at least 10 minutes, and confirm that the voltage between the FTP and FTN terminals on the INV board has dropped to DC20V or less.
- *4. There are many high-temperature parts inside and on the back of the control box, so exercise caution even after turning off the power.
- *5. Refer to the Data book for connecting input/output signal connectors.
- *6. Refer to the Data book for outdoor units in the same refrigerant system.
- *7. SW4: In the case of All OFF
 - *LD3 Lit: Operation
 - *Blink: Turning on
 - *Unit: Turn off

Refer to the Data book and Service Handbook for other switch setting and monitoring items.

*8. Setting the Central control switch(SW5-1).

System configuration	SW5-1
No connection system with the system controller	OFF
Connection system with the system controller	ON

*9. Refer to the following for the LED on the INV board.

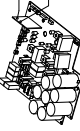

- LED4: Microcomputer operation
- LED1: Normal operation(Lit) /Error(Blink)

*10. Difference of appliance

Model name	Appliance
PURY	*10. exist
PURV	*10. do not exist

*11. Difference of appliance

Model name	Appliance
PURY	*11. exist
PURV	*11. do not exist

<Symbol explanation>

Symbol	Explanation	Symbol	Explanation
21.54a	Cooling/Heating switching	SV1a	Solenoid valve
21.54b	HEX capacity switching	SV2	For opening/closing the bypass circuit under the OIS
63HT	Pressure switch(High pressure protection)		For opening/closing the high and low pressure
63FT	Pressure switch(Low pressure protection)		For defrost switching
X01-X03	Magnetic relay(Inverter main circuit)/ZC		For on defrost switching
C101-C108	Capacitor(Inverter main circuit)		Power supply
C1001.002	Current sensor		Indoor/Outdoor transmission cable
DC/L	DC reactor(For power factor enhancement)		Central control transmission cable
LEV1	Linear choke coil(For high-frequency noise reduction)		Subcool bypass outlet temperature
LEV2a	Pressure control, Refrigerant flow rate control.		Pipe temperature
LEV2b	Pressure control, Refrigerant flow rate control.		Discharge pipe temperature
LEV2c	Pressure control, Refrigerant flow rate control.		ACC inlet pipe temperature
LEV4	Pressure control, Refrigerant flow rate control.		Evaporator liquid refrigerant temperature
	Pressure control, Refrigerant flow rate control.		Oil temperature
	Pressure control, Refrigerant flow rate control.		IPM temperature
	Pressure control, Refrigerant flow rate control.		Detection of compressor lower shell temperature
	Pressure control, Refrigerant flow rate control.		Function setting controller
R031, R032	Resistor	F1, F2, F3	Fuser(600VAC, 100A)

PURY-M-Y(S)X-M-A

5-1. Sound levels in cooling mode (Sound pressure level)

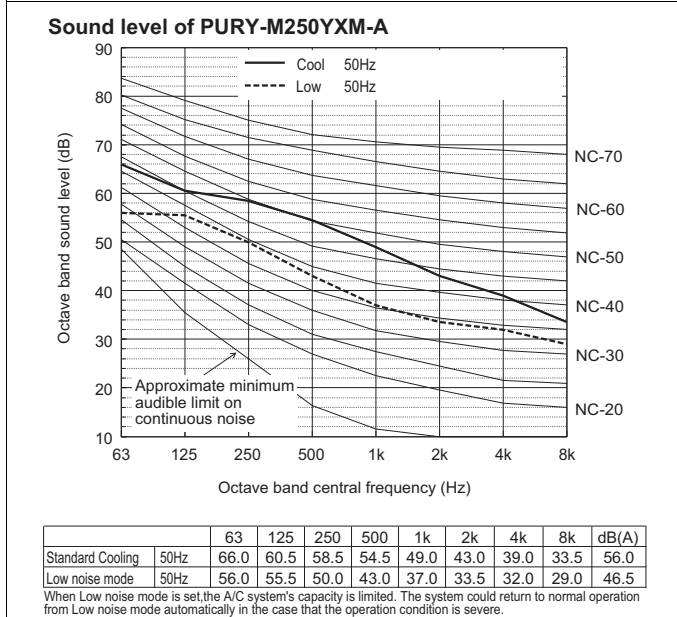
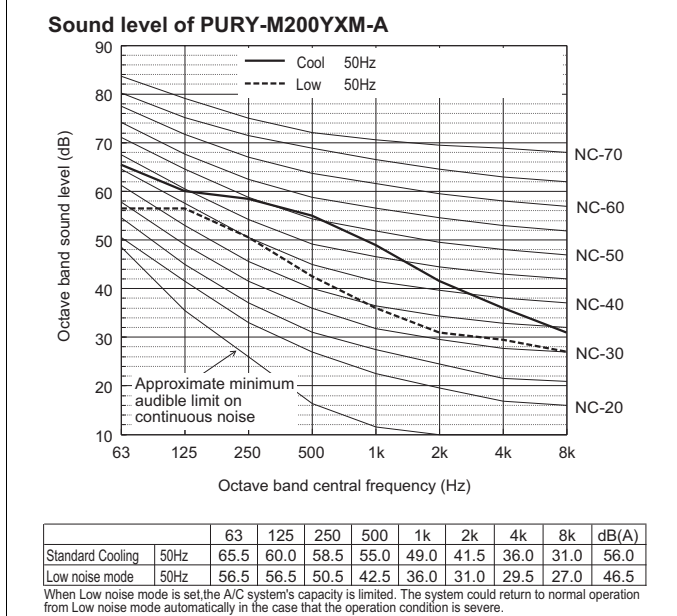
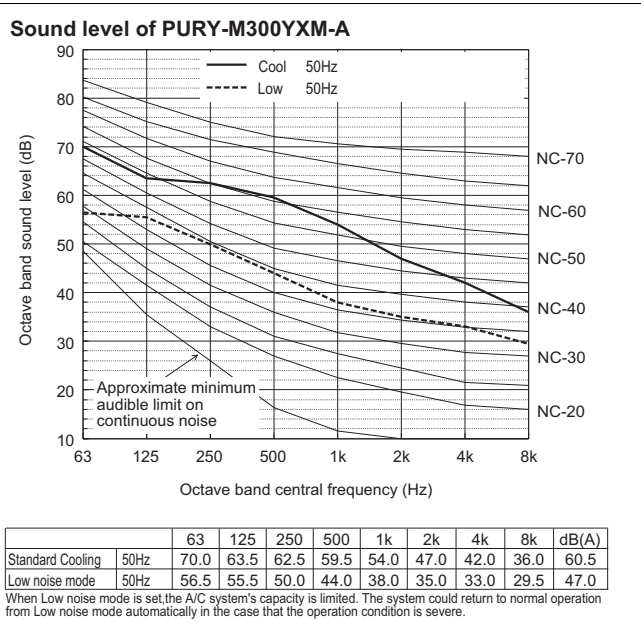
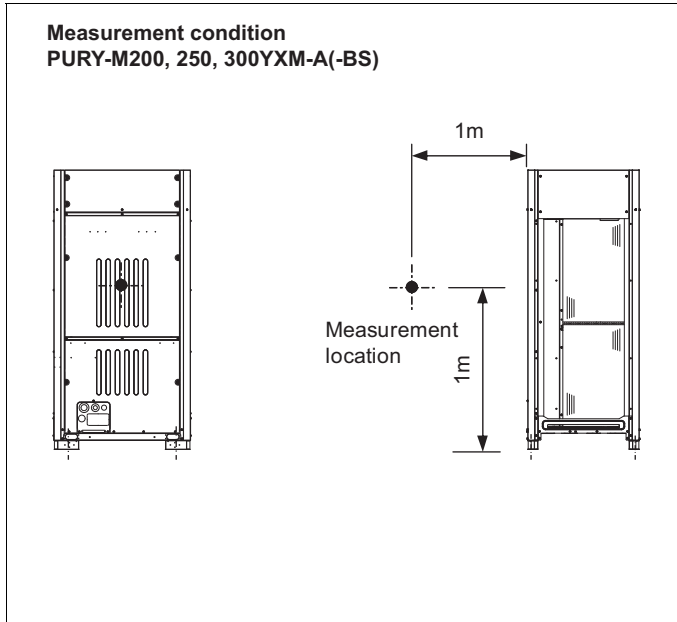

• Depending on the operation conditions, the unit generates noise caused by valve actuation, refrigerant flow, and pressure changes when operating normally. Please consider to avoid location where quietness is required. For BC controller, it is recommended to be installed in places such as ceilings of corridor, rest rooms and plant rooms. The sound pressure level measured by the conventional method in JIS for reference purpose.

Measurement condition
PURY-M350, 400, 450, 500YXM-A(-BS)

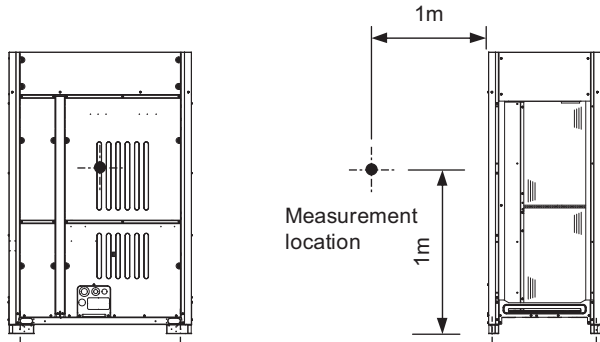

Sound level of PURY-M450YXM-A

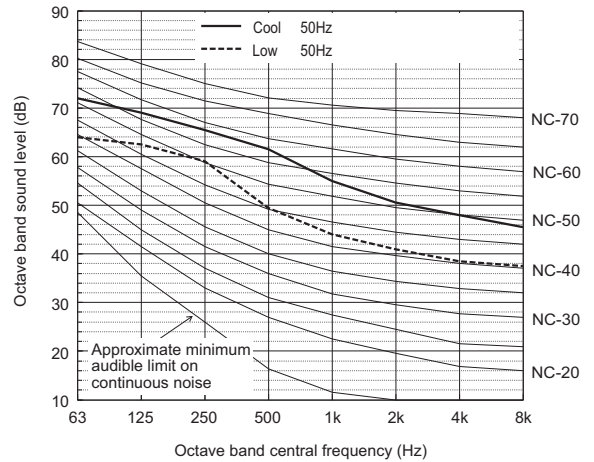

		63	125	250	500	1k	2k	4k	8k	dB(A)
Standard Cooling	50Hz	72.0	69.0	65.5	61.5	55.0	50.5	48.0	45.5	63.0
Low noise mode	50Hz	64.0	62.5	59.0	49.5	44.0	41.0	38.5	37.5	54.0

When Low noise mode is set, the A/C system's capacity is limited. The system could return to normal operation from Low noise mode automatically in the case that the operation condition is severe.

Sound level of PURY-M350YXM-A

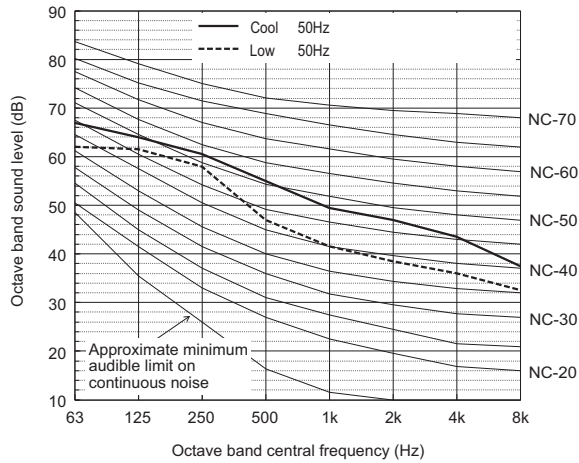

		63	125	250	500	1k	2k	4k	8k	dB(A)
Standard Cooling	50Hz	67.0	64.0	60.5	55.0	49.5	47.0	43.5	37.5	57.5
Low noise mode	50Hz	62.0	61.5	58.0	47.0	41.5	38.5	36.0	32.5	52.5

When Low noise mode is set, the A/C system's capacity is limited. The system could return to normal operation from Low noise mode automatically in the case that the operation condition is severe.

Sound level of PURY-M500YXM-A

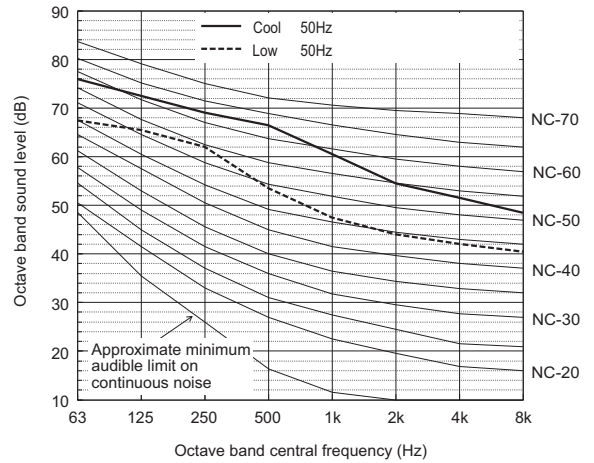

		63	125	250	500	1k	2k	4k	8k	dB(A)
Standard Cooling	50Hz	76.0	72.5	69.0	66.5	60.5	54.5	51.5	48.5	67.5
Low noise mode	50Hz	67.5	65.5	62.0	53.5	47.5	44.0	42.0	40.5	57.5

When Low noise mode is set, the A/C system's capacity is limited. The system could return to normal operation from Low noise mode automatically in the case that the operation condition is severe.

Sound level of PURY-M400YXM-A

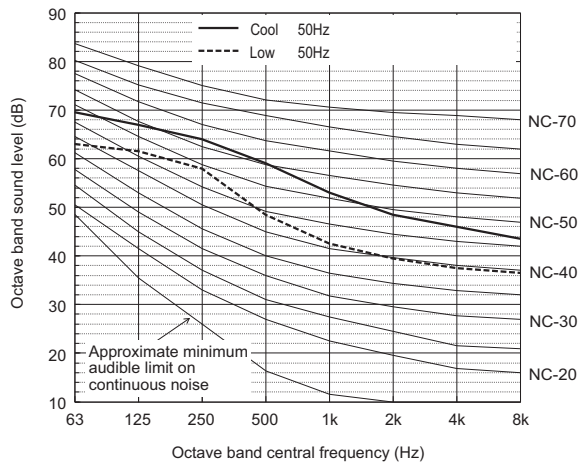

		63	125	250	500	1k	2k	4k	8k	dB(A)
Standard Cooling	50Hz	69.5	67.0	64.0	59.0	53.0	48.5	46.0	43.5	61.0
Low noise mode	50Hz	63.0	61.5	58.0	48.5	42.5	39.5	37.5	36.5	53.0

When Low noise mode is set, the A/C system's capacity is limited. The system could return to normal operation from Low noise mode automatically in the case that the operation condition is severe.

• Depending on the operation conditions, the unit generates noise caused by valve actuation, refrigerant flow, and pressure changes when operating normally. Please consider to avoid location where quietness is required. For BC controller, it is recommended to be installed in places such as ceilings of corridor, rest rooms and plant rooms. The sound pressure level measured by the conventional method in JIS for reference purpose.

Measurement condition
PURY-M400, 450, 500, 550, 600YSXM-A-(BS)

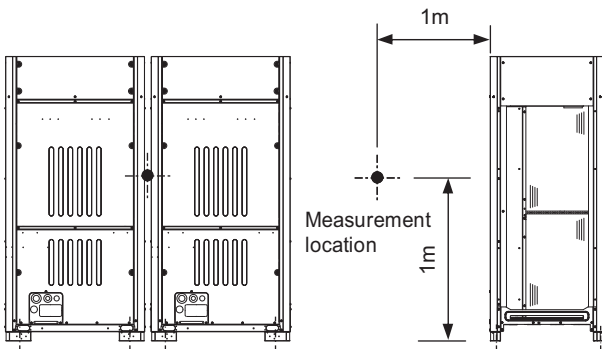

Sound level of PURY-M500YSXM-A

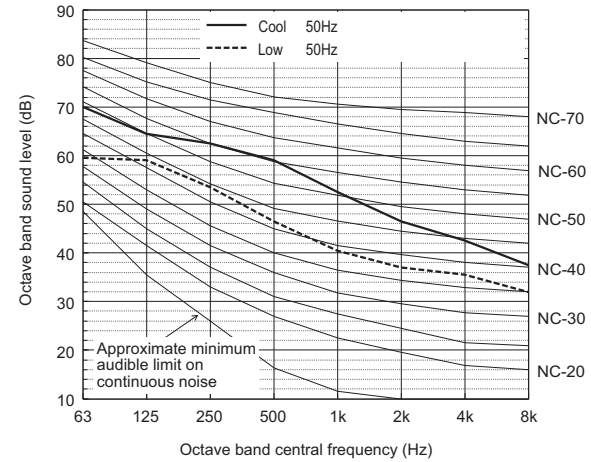

		63	125	250	500	1k	2k	4k	8k	dB(A)
Standard Cooling	50Hz	70.0	64.5	62.5	59.0	52.5	46.5	42.5	37.5	60.0
Low noise mode	50Hz	59.5	59.0	53.5	46.5	40.5	37.0	35.5	32.0	50.0

When Low noise mode is set, the A/C system's capacity is limited. The system could return to normal operation from Low noise mode automatically in the case that the operation condition is severe.

Sound level of PURY-M400YSXM-A

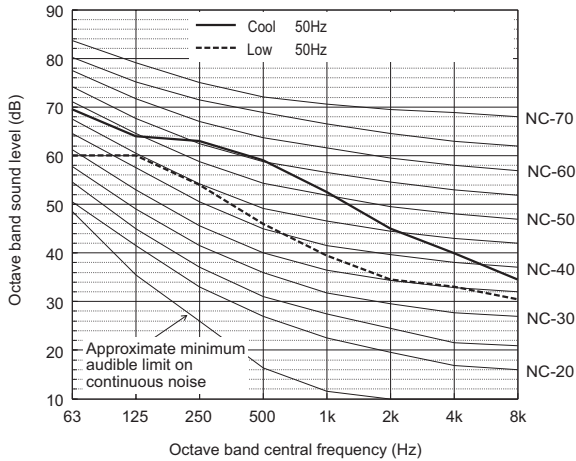

		63	125	250	500	1k	2k	4k	8k	dB(A)
Standard Cooling	50Hz	69.5	64.0	63.0	59.0	52.5	45.0	40.0	34.5	60.0
Low noise mode	50Hz	60.0	60.0	54.0	46.0	39.5	34.5	33.0	30.5	50.0

When Low noise mode is set, the A/C system's capacity is limited. The system could return to normal operation from Low noise mode automatically in the case that the operation condition is severe.

Sound level of PURY-M550YSXM-A

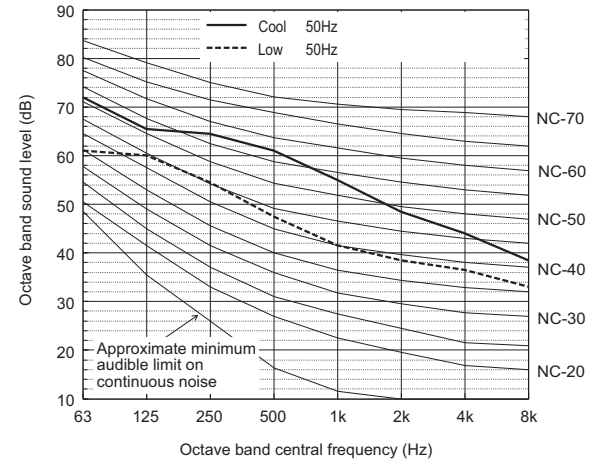

		63	125	250	500	1k	2k	4k	8k	dB(A)
Standard Cooling	50Hz	72.0	65.5	64.5	61.0	55.0	48.5	44.0	38.5	62.0
Low noise mode	50Hz	61.0	60.0	54.5	47.5	41.5	38.5	36.5	33.0	51.0

When Low noise mode is set, the A/C system's capacity is limited. The system could return to normal operation from Low noise mode automatically in the case that the operation condition is severe.

Sound level of PURY-M450YSXM-A

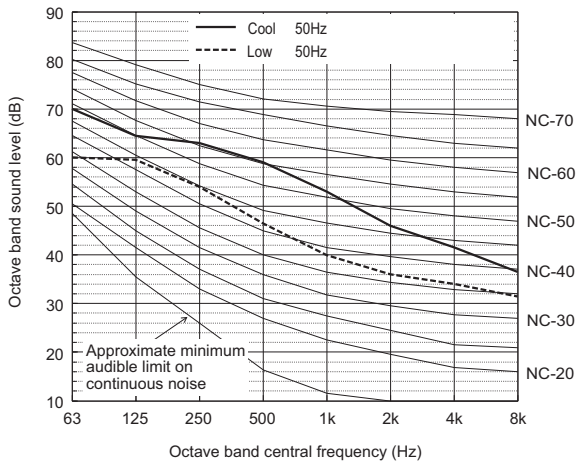

		63	125	250	500	1k	2k	4k	8k	dB(A)
Standard Cooling	50Hz	70.0	64.5	63.0	59.0	53.0	46.0	41.5	36.5	60.0
Low noise mode	50Hz	60.0	59.5	54.0	46.5	40.0	36.0	34.0	31.5	50.0

When Low noise mode is set, the A/C system's capacity is limited. The system could return to normal operation from Low noise mode automatically in the case that the operation condition is severe.

Sound level of PURY-M600YSXM-A

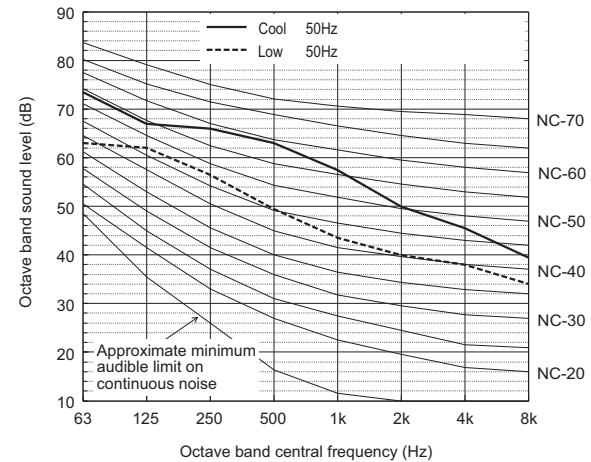

		63	125	250	500	1k	2k	4k	8k	dB(A)
Standard Cooling	50Hz	73.5	67.0	66.0	63.0	57.5	50.0	45.5	39.5	64.0
Low noise mode	50Hz	63.0	62.0	56.5	49.5	43.5	40.0	38.0	34.0	53.0

When Low noise mode is set, the A/C system's capacity is limited. The system could return to normal operation from Low noise mode automatically in the case that the operation condition is severe.

*Depending on the operation conditions, the unit generates noise caused by valve actuation, refrigerant flow, and pressure changes when operating normally. Please consider to avoid location where quietness is required. For BC controller, it is recommended to be installed in places such as ceilings of corridor, rest rooms and plant rooms. The sound pressure level measured by the conventional method in JIS for reference purpose.

Measurement condition
PURY-M650YSXM-A(-BS)

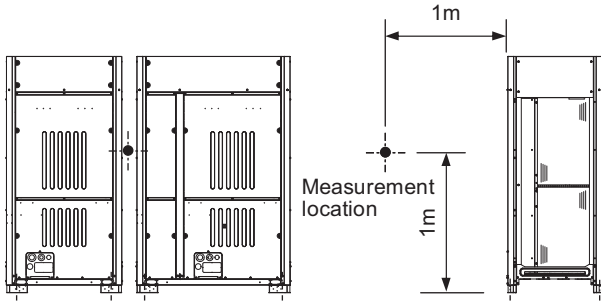

Measurement condition
PURY-M700, 750, 800, 850, 900, 950, 1000YSXM-A(-BS)

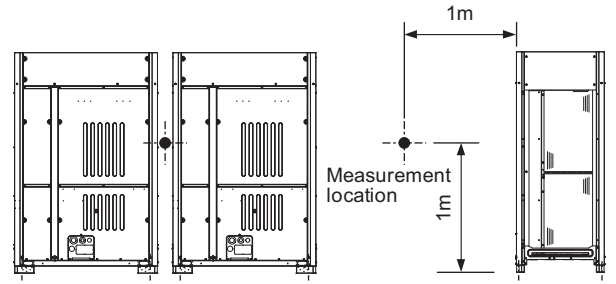

Sound level of PURY-M650YSXM-A

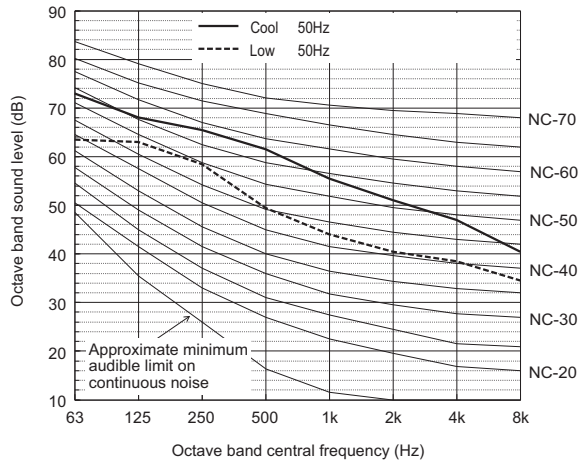

		63	125	250	500	1k	2k	4k	8k	dB(A)
Standard Cooling	50Hz	73.0	68.0	65.5	61.5	55.5	51.0	47.0	40.5	63.0
Low noise mode	50Hz	63.5	63.0	58.5	49.5	44.0	40.5	38.5	34.5	54.0

When Low noise mode is set, the A/C system's capacity is limited. The system could return to normal operation from Low noise mode automatically in the case that the operation condition is severe.

Sound level of PURY-M700YSXM-A

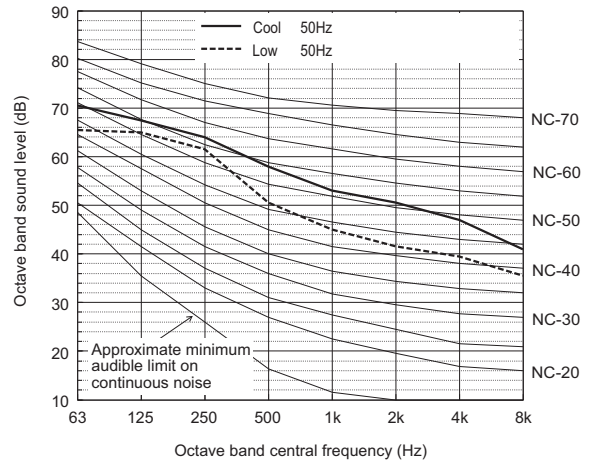

		63	125	250	500	1k	2k	4k	8k	dB(A)
Standard Cooling	50Hz	70.5	67.5	64.0	58.0	53.0	50.5	47.0	41.0	61.0
Low noise mode	50Hz	65.5	65.0	61.5	50.5	45.0	41.5	39.5	35.5	56.0

When Low noise mode is set, the A/C system's capacity is limited. The system could return to normal operation from Low noise mode automatically in the case that the operation condition is severe.

Sound level of PURY-M750YSXM-A

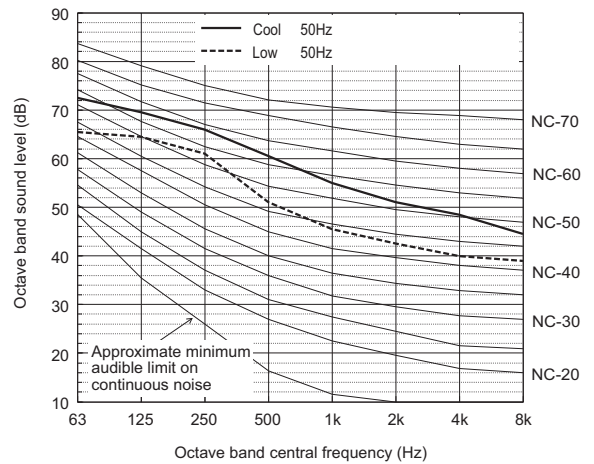

		63	125	250	500	1k	2k	4k	8k	dB(A)
Standard Cooling	50Hz	72.5	69.5	66.0	60.5	55.0	51.0	48.5	44.5	63.0
Low noise mode	50Hz	65.5	64.5	61.0	51.0	45.5	42.5	40.0	39.0	56.0

When Low noise mode is set, the A/C system's capacity is limited. The system could return to normal operation from Low noise mode automatically in the case that the operation condition is severe.

• Depending on the operation conditions, the unit generates noise caused by valve actuation, refrigerant flow, and pressure changes when operating normally. Please consider to avoid location where quietness is required. For BC controller, it is recommended to be installed in places such as ceilings of corridor, rest rooms and plant rooms. The sound pressure level measured by the conventional method in JIS for reference purpose.

Sound level of PURY-M800YSXM-A

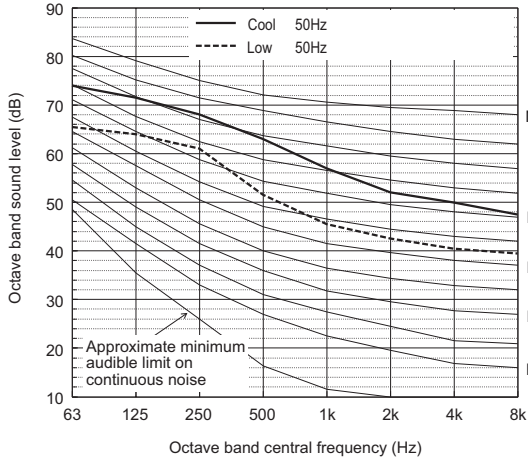

When Low noise mode is set, the A/C system's capacity is limited. The system could return to normal operation from Low noise mode automatically in the case that the operation condition is severe.

Sound level of PURY-M950YSXM-A

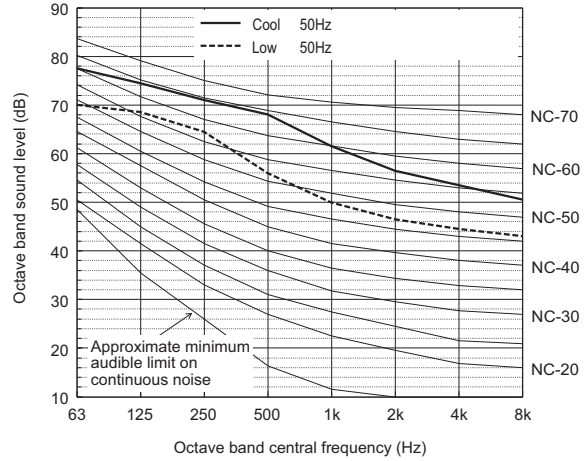

When Low noise mode is set, the A/C system's capacity is limited. The system could return to normal operation from Low noise mode automatically in the case that the operation condition is severe.

Sound level of PURY-M850YSXM-A

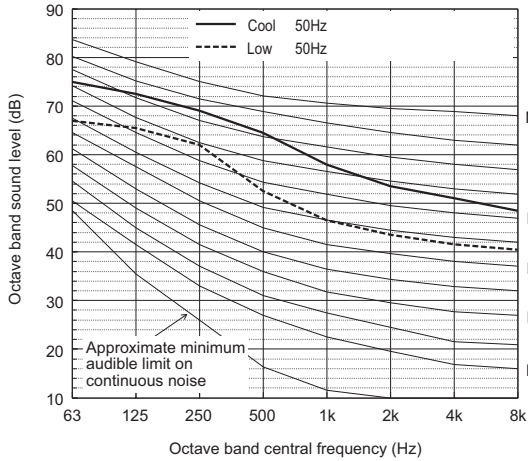

When Low noise mode is set, the A/C system's capacity is limited. The system could return to normal operation from Low noise mode automatically in the case that the operation condition is severe.

Sound level of PURY-M1000YSXM-A

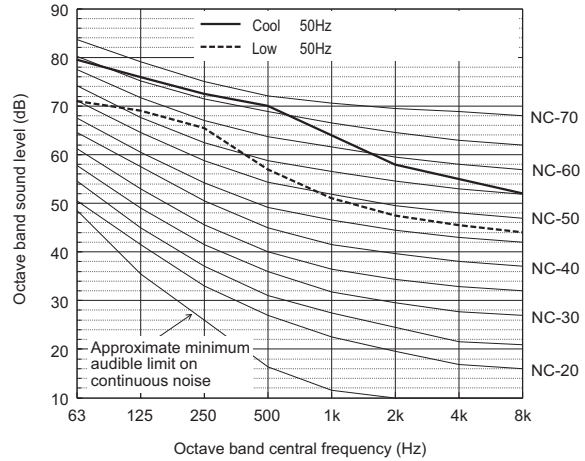

When Low noise mode is set, the A/C system's capacity is limited. The system could return to normal operation from Low noise mode automatically in the case that the operation condition is severe.

Sound level of PURY-M900YSXM-A

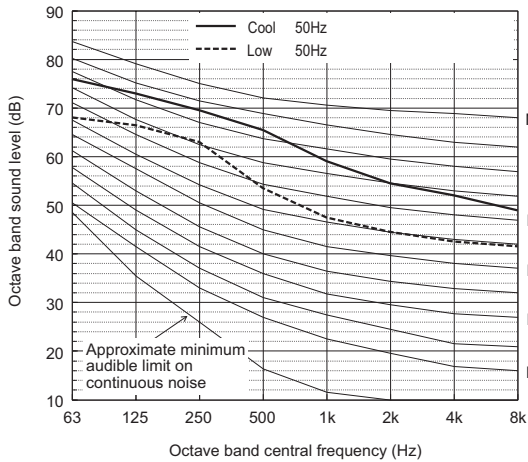

When Low noise mode is set, the A/C system's capacity is limited. The system could return to normal operation from Low noise mode automatically in the case that the operation condition is severe.

* Depending on the operation conditions, the unit generates noise caused by valve actuation, refrigerant flow, and pressure changes when operating normally. Please consider to avoid location where quietness is required. For BC controller, it is recommended to be installed in places such as ceilings of corridor, rest rooms and plant rooms. The sound pressure level measured by the conventional method in JIS for reference purpose.

5-2. Sound levels in heating mode (Sound pressure level)

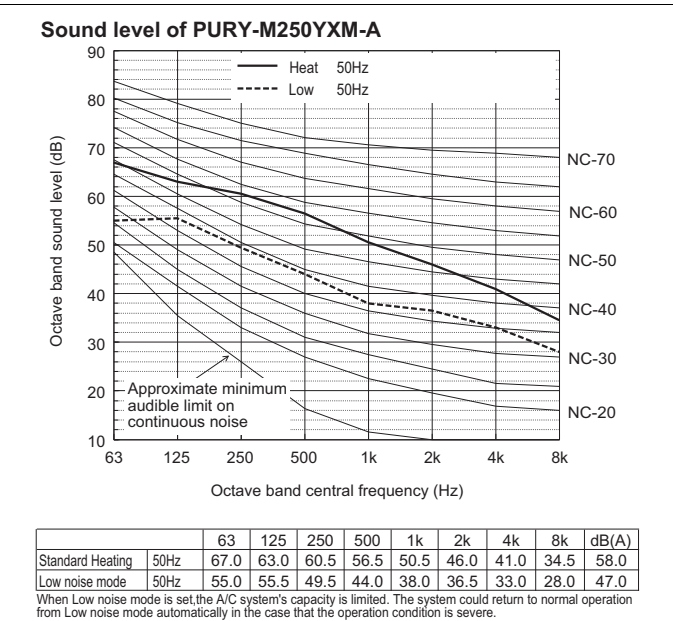
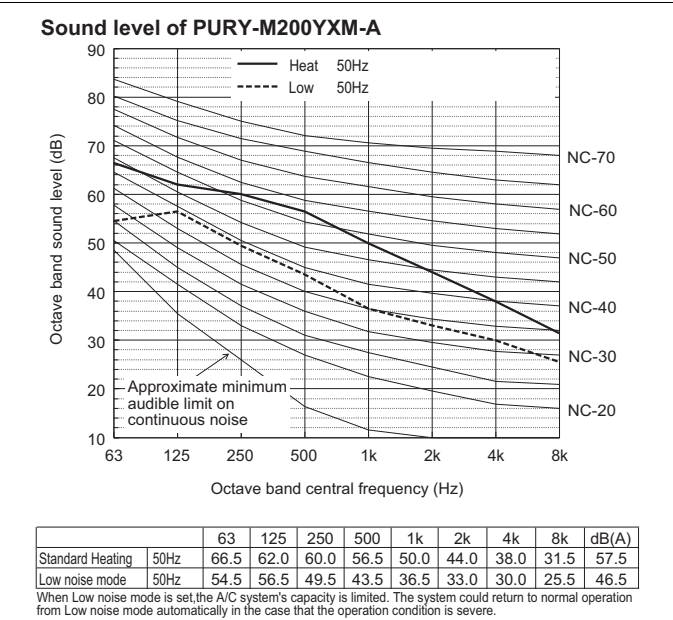
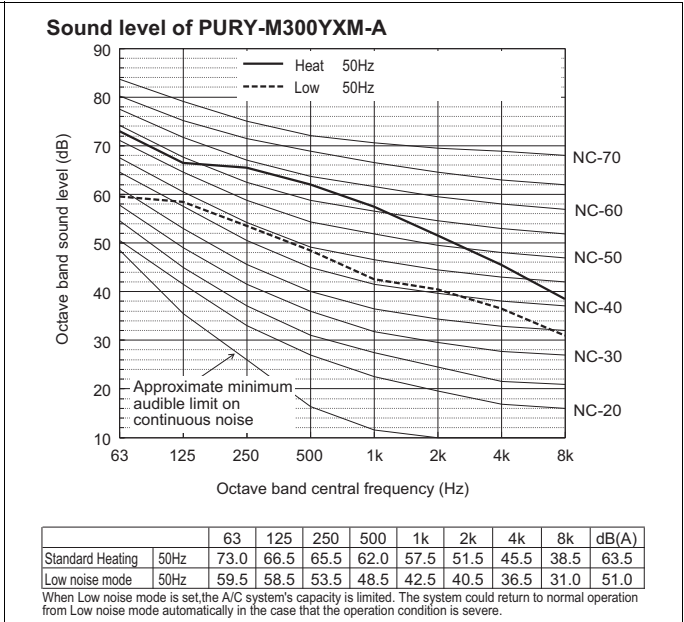
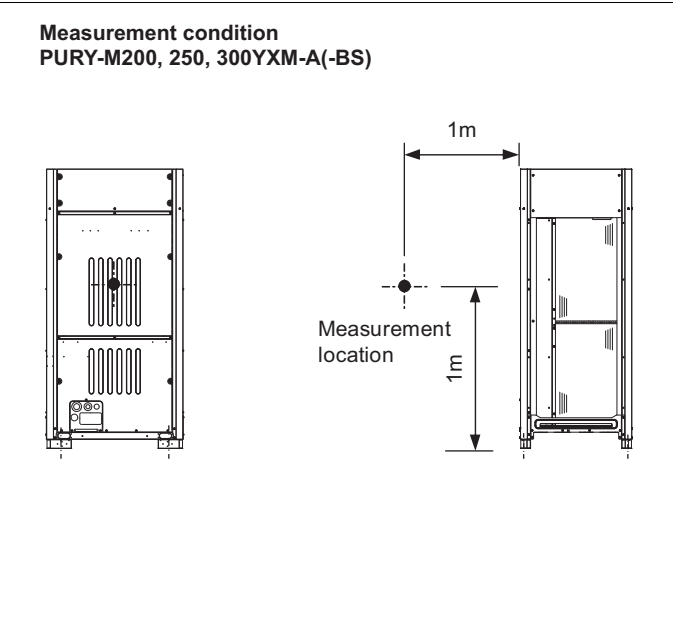

• Depending on the operation conditions, the unit generates noise caused by valve actuation, refrigerant flow, and pressure changes when operating normally. Please consider to avoid location where quietness is required. For BC controller, it is recommended to be installed in places such as ceilings of corridor, rest rooms and plant rooms. The sound pressure level measured by the conventional method in JIS for reference purpose.

PURY-M-Y(S)XM-A

Measurement condition
PURY-M350, 400, 450, 500YXM-A(-BS)

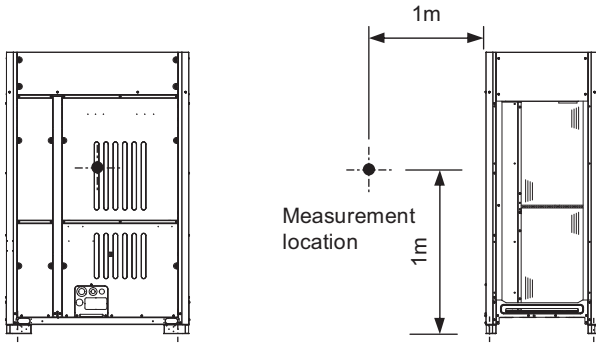

Sound level of PURY-M450YXM-A

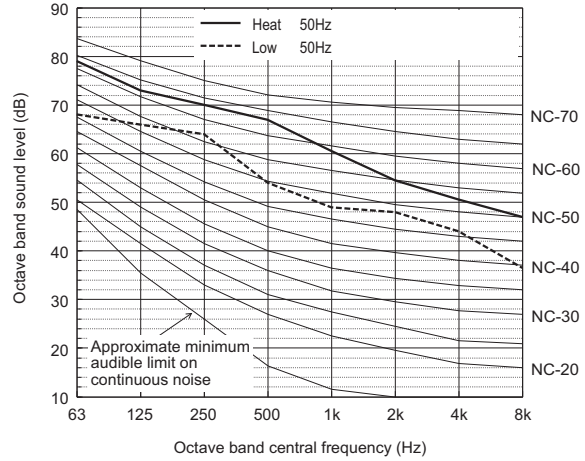

		63	125	250	500	1k	2k	4k	8k	dB(A)
Standard Heating	50Hz	79.0	73.0	70.0	67.0	60.5	54.5	50.5	47.0	68.0
Low noise mode	50Hz	68.0	66.0	64.0	54.0	49.0	48.0	44.0	36.5	59.0

When Low noise mode is set, the A/C system's capacity is limited. The system could return to normal operation from Low noise mode automatically in the case that the operation condition is severe.

Sound level of PURY-M350YXM-A

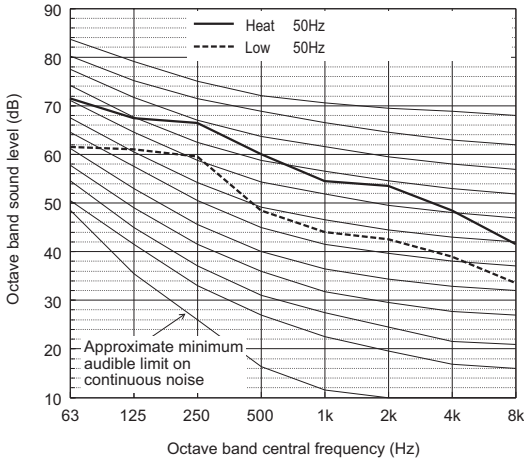

		63	125	250	500	1k	2k	4k	8k	dB(A)
Standard Heating	50Hz	71.5	67.5	66.5	60.0	54.5	53.5	48.5	41.5	63.0
Low noise mode	50Hz	61.5	61.0	59.5	48.5	44.0	42.5	39.0	33.5	54.0

When Low noise mode is set, the A/C system's capacity is limited. The system could return to normal operation from Low noise mode automatically in the case that the operation condition is severe.

Sound level of PURY-M500YXM-A

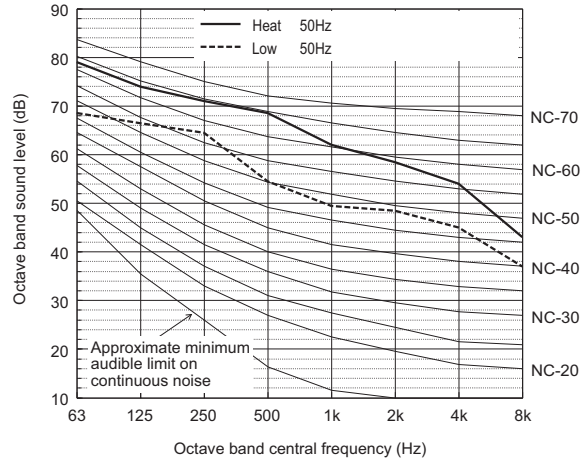

		63	125	250	500	1k	2k	4k	8k	dB(A)
Standard Heating	50Hz	79.0	74.0	71.0	68.5	62.0	58.5	54.0	43.0	69.5
Low noise mode	50Hz	68.5	66.5	64.5	54.5	49.5	48.5	45.0	37.0	59.5

When Low noise mode is set, the A/C system's capacity is limited. The system could return to normal operation from Low noise mode automatically in the case that the operation condition is severe.

Sound level of PURY-M400YXM-A

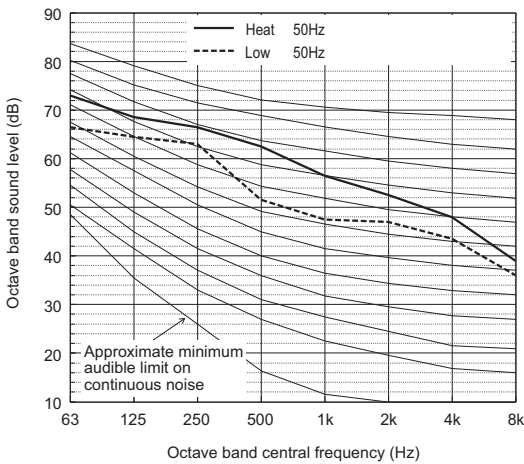

		63	125	250	500	1k	2k	4k	8k	dB(A)
Standard Heating	50Hz	73.0	68.5	66.5	62.5	56.5	52.5	48.0	39.0	64.0
Low noise mode	50Hz	66.5	64.5	63.0	51.5	47.5	47.0	43.5	36.0	57.5

When Low noise mode is set, the A/C system's capacity is limited. The system could return to normal operation from Low noise mode automatically in the case that the operation condition is severe.

* Depending on the operation conditions, the unit generates noise caused by valve actuation, refrigerant flow, and pressure changes when operating normally. Please consider to avoid location where quietness is required. For BC controller, it is recommended to be installed in places such as ceilings of corridor, rest rooms and plant rooms. The sound pressure level measured by the conventional method in JIS for reference purpose.

Measurement condition
PURY-M400, 450, 500, 550, 600YSXM-A(-BS)

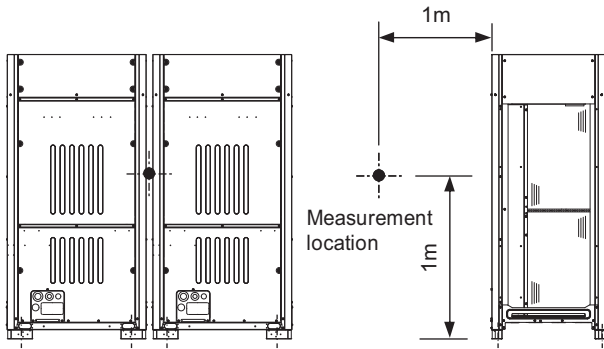

Sound level of PURY-M500YSXM-A

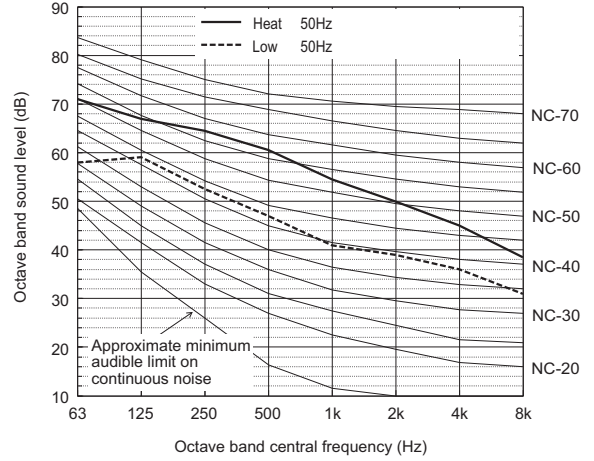

		63	125	250	500	1k	2k	4k	8k	dB(A)
Standard Heating	50Hz	71.0	67.0	64.5	60.5	54.5	50.0	45.0	38.5	62.0
Low noise mode	50Hz	58.0	59.0	52.5	47.0	41.0	39.0	36.0	31.0	50.0

When Low noise mode is set, the A/C system's capacity is limited. The system could return to normal operation from Low noise mode automatically in the case that the operation condition is severe.

Sound level of PURY-M400YSXM-A

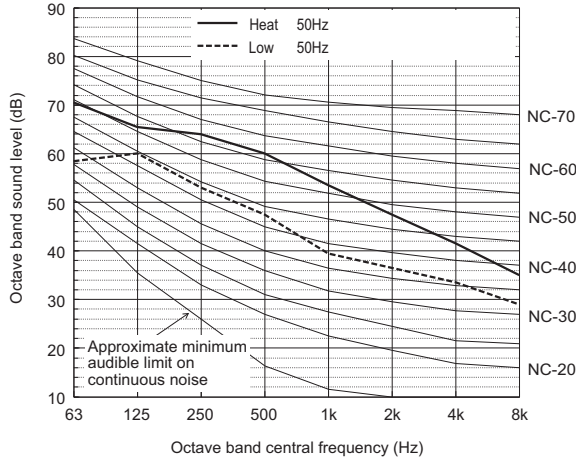

		63	125	250	500	1k	2k	4k	8k	dB(A)
Standard Heating	50Hz	70.5	65.5	64.0	60.0	53.5	47.5	41.5	35.0	61.0
Low noise mode	50Hz	58.5	60.0	53.0	47.5	39.5	36.5	33.5	29.0	50.0

When Low noise mode is set, the A/C system's capacity is limited. The system could return to normal operation from Low noise mode automatically in the case that the operation condition is severe.

Sound level of PURY-M550YSXM-A

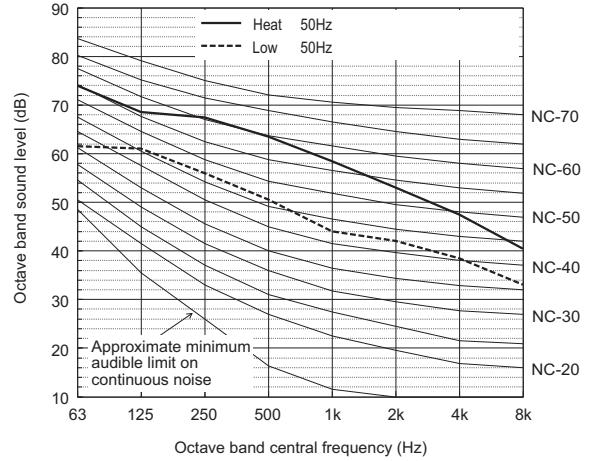

		63	125	250	500	1k	2k	4k	8k	dB(A)
Standard Heating	50Hz	74.0	68.5	67.5	63.5	58.5	53.0	47.5	40.5	65.0
Low noise mode	50Hz	61.5	61.0	56.0	50.5	44.0	42.0	38.5	33.0	53.0

When Low noise mode is set, the A/C system's capacity is limited. The system could return to normal operation from Low noise mode automatically in the case that the operation condition is severe.

Sound level of PURY-M450YSXM-A

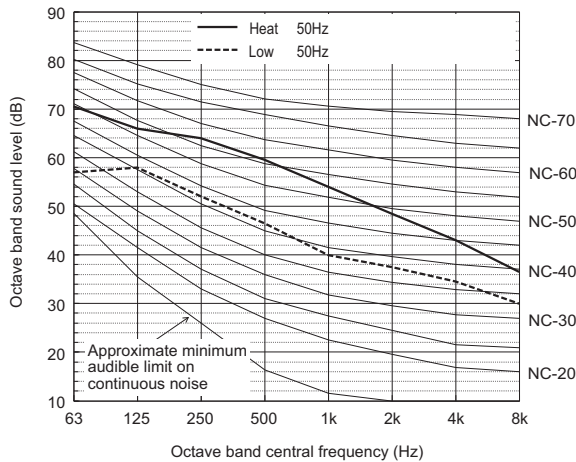

		63	125	250	500	1k	2k	4k	8k	dB(A)
Standard Heating	50Hz	70.5	66.0	64.0	59.5	54.0	48.5	43.0	36.5	61.0
Low noise mode	50Hz	57.0	58.0	52.0	46.5	40.0	37.5	34.5	30.0	49.0

When Low noise mode is set, the A/C system's capacity is limited. The system could return to normal operation from Low noise mode automatically in the case that the operation condition is severe.

Sound level of PURY-M600YSXM-A

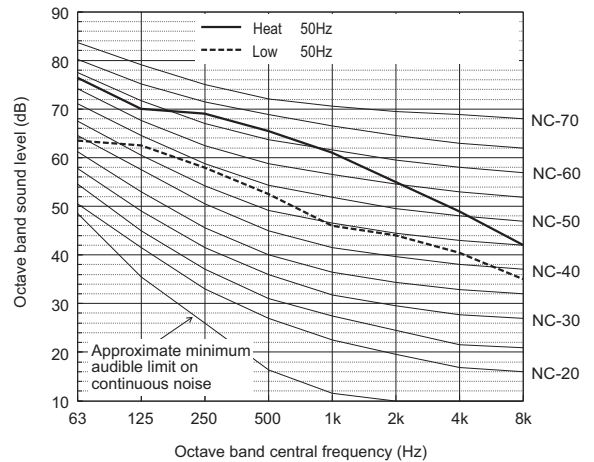

		63	125	250	500	1k	2k	4k	8k	dB(A)
Standard Heating	50Hz	76.5	70.0	69.0	65.5	61.0	55.0	49.0	42.0	67.0
Low noise mode	50Hz	63.5	62.5	58.0	52.5	46.0	44.0	40.5	35.0	55.0

When Low noise mode is set, the A/C system's capacity is limited. The system could return to normal operation from Low noise mode automatically in the case that the operation condition is severe.

• Depending on the operation conditions, the unit generates noise caused by valve actuation, refrigerant flow, and pressure changes when operating normally. Please consider to avoid location where quietness is required. For BC controller, it is recommended to be installed in places such as ceilings of corridor, rest rooms and plant rooms. The sound pressure level measured by the conventional method in JIS for reference purpose.

PURY-M-Y(S)XM-A

Measurement condition
PURY-M650YSXM-A(-BS)

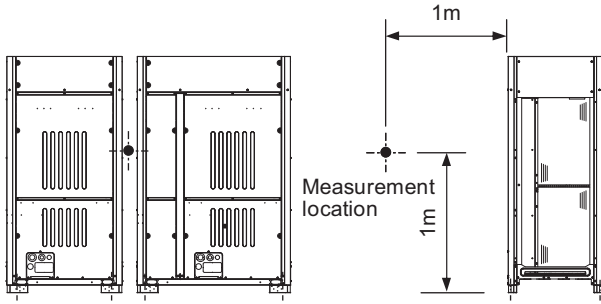

Measurement condition
PURY-M700, 750, 800, 850, 900, 950, 1000YSXM-A(-BS)

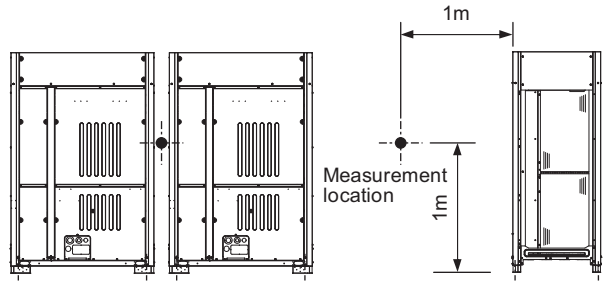

Sound level of PURY-M650YSXM-A

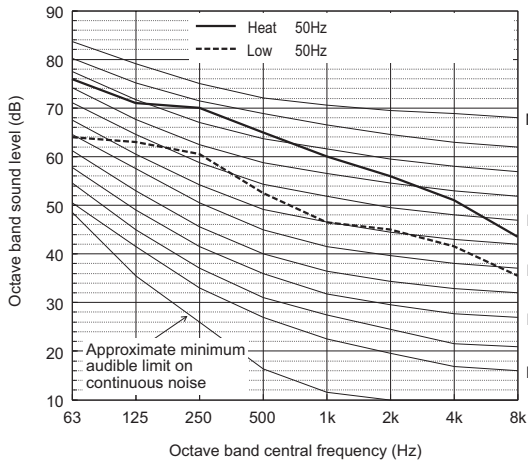

		63	125	250	500	1k	2k	4k	8k	dB(A)
Standard Heating	50Hz	76.0	71.0	70.0	65.0	60.0	56.0	51.0	43.5	67.0
Low noise mode	50Hz	64.0	63.0	60.5	52.5	46.5	45.0	41.5	35.5	56.0

When Low noise mode is set, the A/C system's capacity is limited. The system could return to normal operation from Low noise mode automatically in the case that the operation condition is severe.

Sound level of PURY-M700YSXM-A

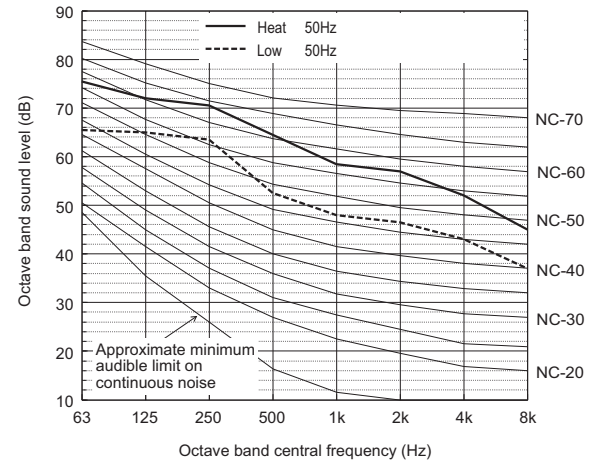

		63	125	250	500	1k	2k	4k	8k	dB(A)
Standard Heating	50Hz	75.5	72.0	70.5	64.5	58.5	57.0	52.0	45.0	67.0
Low noise mode	50Hz	65.5	65.0	63.5	52.5	48.0	46.5	43.0	37.0	58.0

When Low noise mode is set, the A/C system's capacity is limited. The system could return to normal operation from Low noise mode automatically in the case that the operation condition is severe.

Sound level of PURY-M750YSXM-A

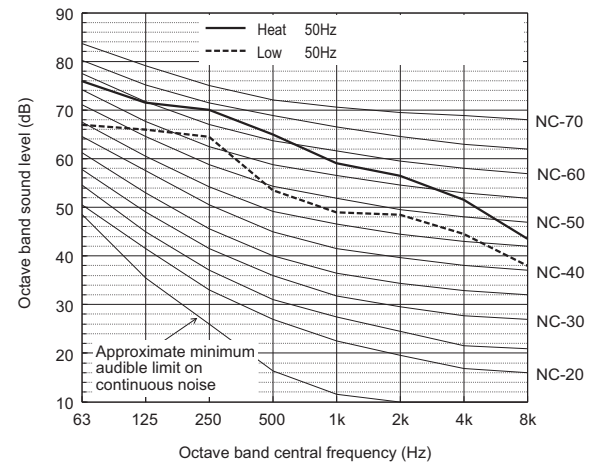

		63	125	250	500	1k	2k	4k	8k	dB(A)
Standard Heating	50Hz	76.0	71.5	70.0	65.0	59.0	56.5	51.5	43.5	67.0
Low noise mode	50Hz	67.0	66.0	64.5	53.5	49.0	48.5	44.5	38.0	59.0

When Low noise mode is set, the A/C system's capacity is limited. The system could return to normal operation from Low noise mode automatically in the case that the operation condition is severe.

• Depending on the operation conditions, the unit generates noise caused by valve actuation, refrigerant flow, and pressure changes when operating normally. Please consider to avoid location where quietness is required. For BC controller, it is recommended to be installed in places such as ceilings of corridor, rest rooms and plant rooms. The sound pressure level measured by the conventional method in JIS for reference purpose.

Sound level of PURY-M800YSXM-A

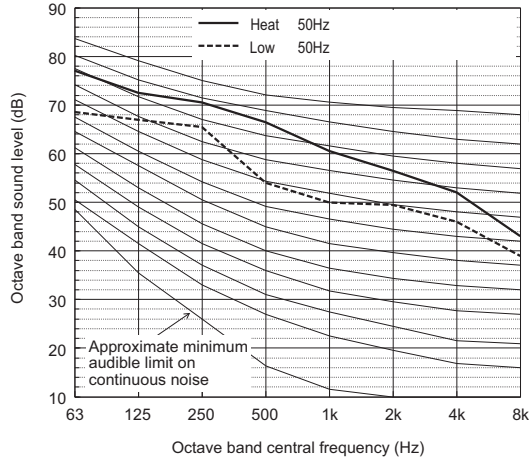

When Low noise mode is set, the A/C system's capacity is limited. The system could return to normal operation from Low noise mode automatically in the case that the operation condition is severe.

Sound level of PURY-M950YSXM-A

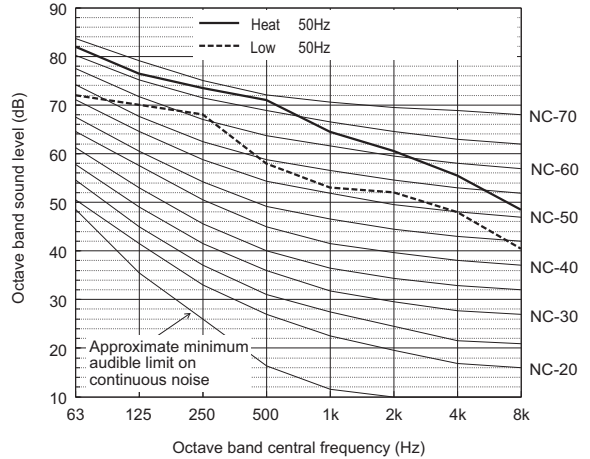

When Low noise mode is set, the A/C system's capacity is limited. The system could return to normal operation from Low noise mode automatically in the case that the operation condition is severe.

Sound level of PURY-M850YSXM-A

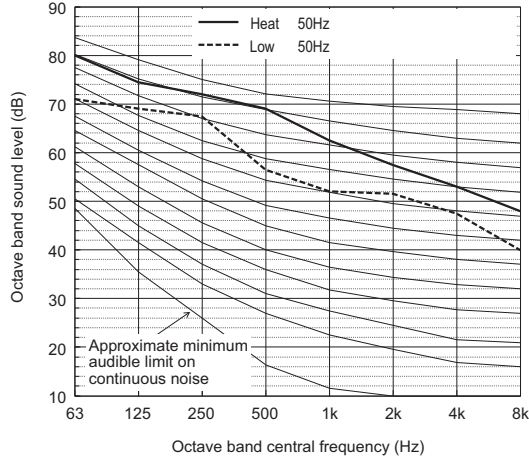

When Low noise mode is set, the A/C system's capacity is limited. The system could return to normal operation from Low noise mode automatically in the case that the operation condition is severe.

Sound level of PURY-M1000YSXM-A

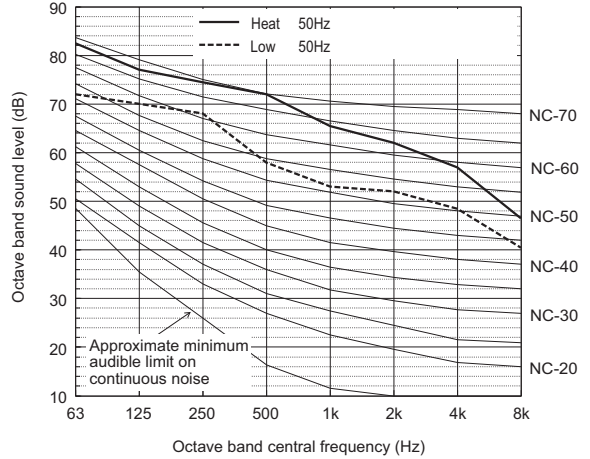

When Low noise mode is set, the A/C system's capacity is limited. The system could return to normal operation from Low noise mode automatically in the case that the operation condition is severe.

Sound level of PURY-M900YSXM-A

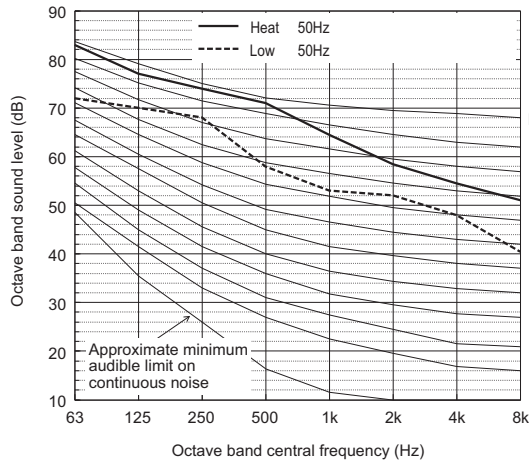

When Low noise mode is set, the A/C system's capacity is limited. The system could return to normal operation from Low noise mode automatically in the case that the operation condition is severe.

• Depending on the operation conditions, the unit generates noise caused by valve actuation, refrigerant flow, and pressure changes when operating normally. Please consider to avoid location where quietness is required. For BC controller, it is recommended to be installed in places such as ceilings of corridor, rest rooms and plant rooms. The sound pressure level measured by the conventional method in JIS for reference purpose.

5-3. Sound levels in cooling mode (Sound power level)

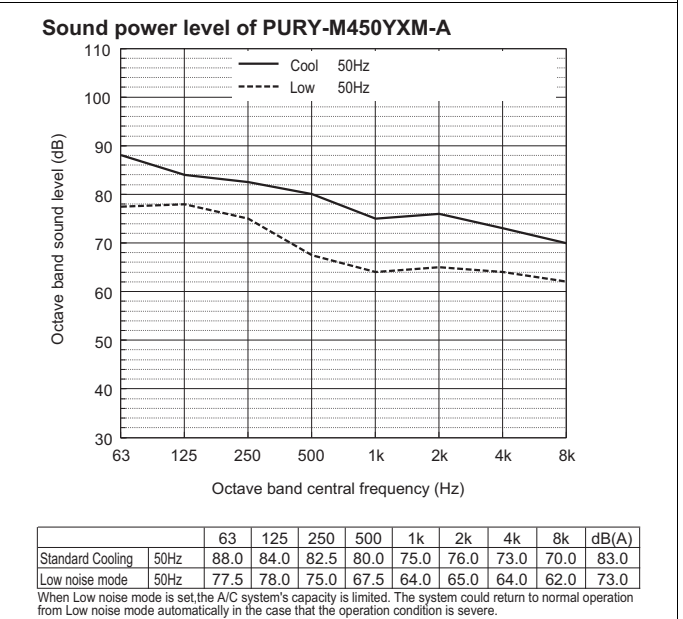
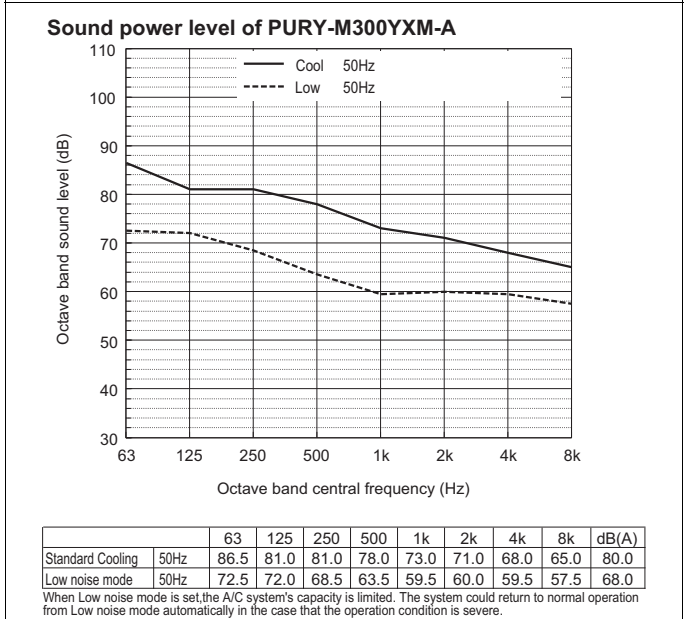
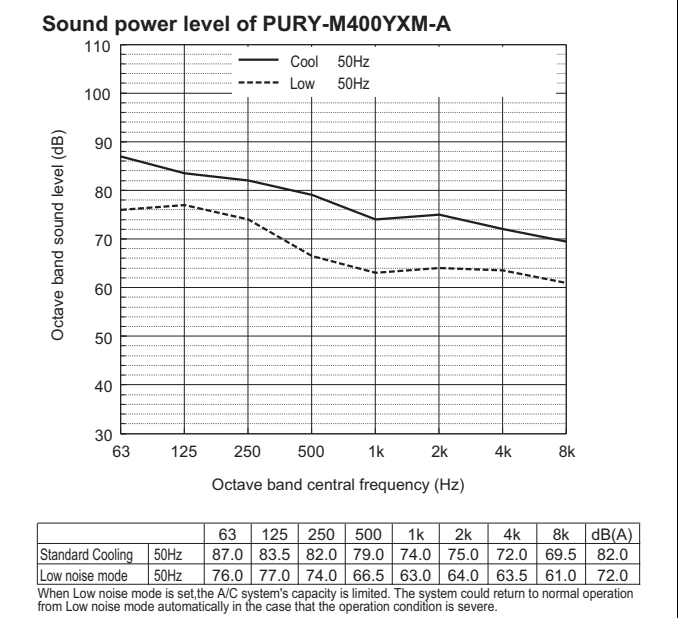
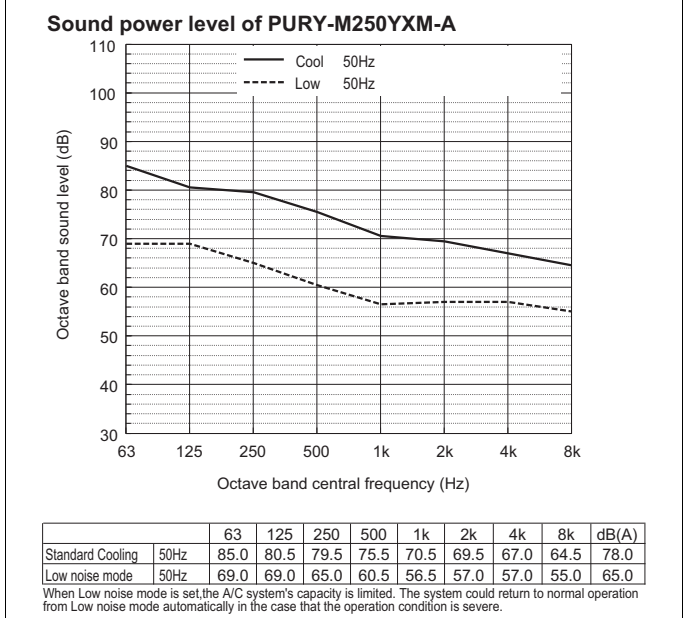
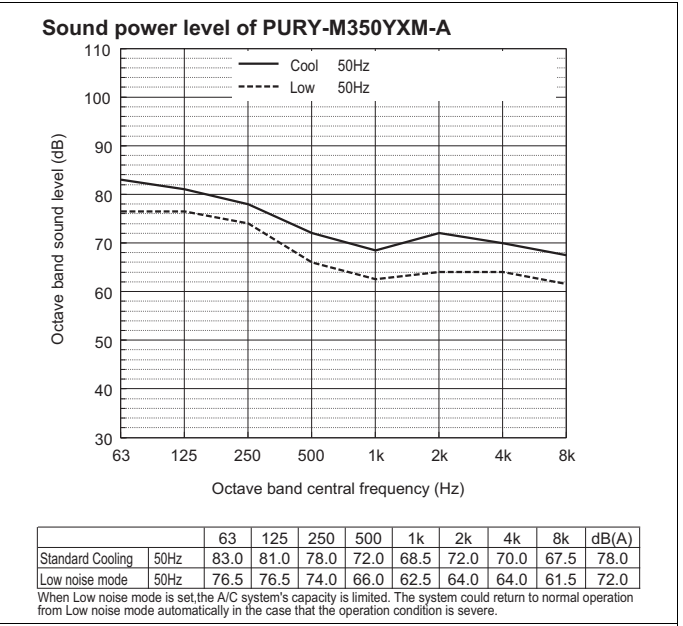
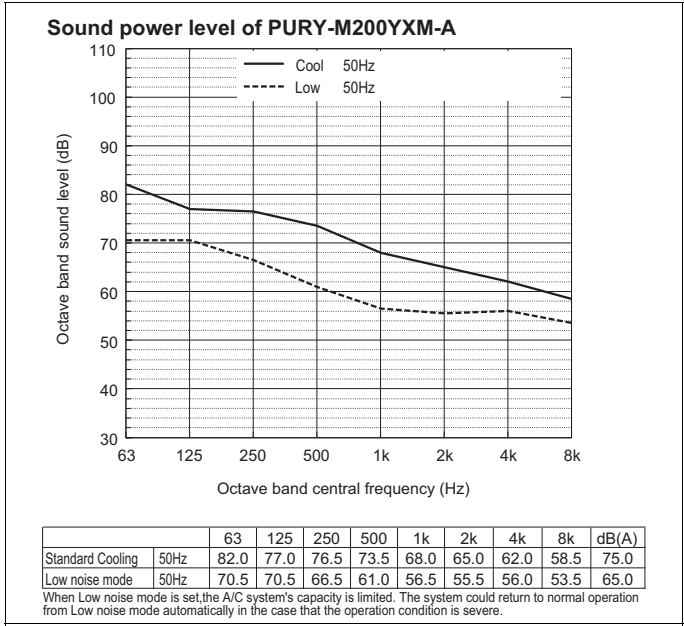

• Depending on the operation conditions, the unit generates noise caused by valve actuation, refrigerant flow, and pressure changes when operating normally. Please consider to avoid location where quietness is required.

For BC controller, it is recommended to be installed in places such as ceilings of corridor, rest rooms and plant rooms.

• The sound values are sound power level (PWL) based on ISO 3744:2010 (r = 3.5 m).

Sound power level of PURY-M500YXM-A

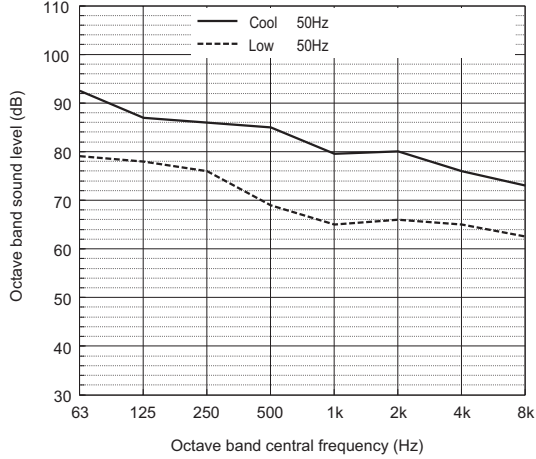

		63	125	250	500	1k	2k	4k	8k	dB(A)
Standard Cooling	50Hz	92.5	87.0	86.0	85.0	79.5	80.0	76.0	73.0	87.0
Low noise mode	50Hz	79.0	78.0	76.0	69.0	65.0	66.0	65.0	62.5	74.0

When Low noise mode is set, the A/C system's capacity is limited. The system could return to normal operation from Low noise mode automatically in the case that the operation condition is severe.

Sound power level of PURY-M500YSXM-A

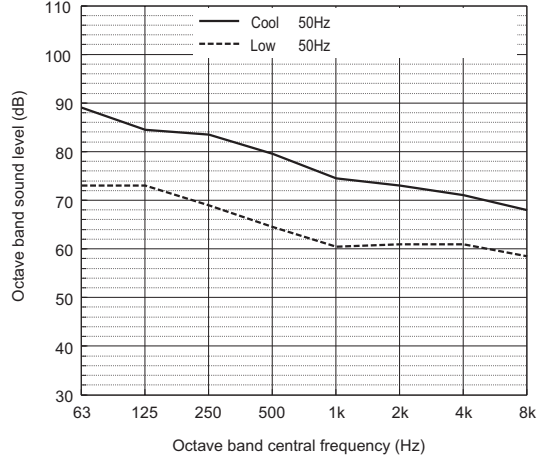

		63	125	250	500	1k	2k	4k	8k	dB(A)
Standard Cooling	50Hz	89.0	84.5	83.5	79.5	74.5	73.0	71.0	68.0	82.0
Low noise mode	50Hz	73.0	73.0	69.0	64.5	60.5	61.0	61.0	58.5	69.0

When Low noise mode is set, the A/C system's capacity is limited. The system could return to normal operation from Low noise mode automatically in the case that the operation condition is severe.

Sound power level of PURY-M400YSXM-A

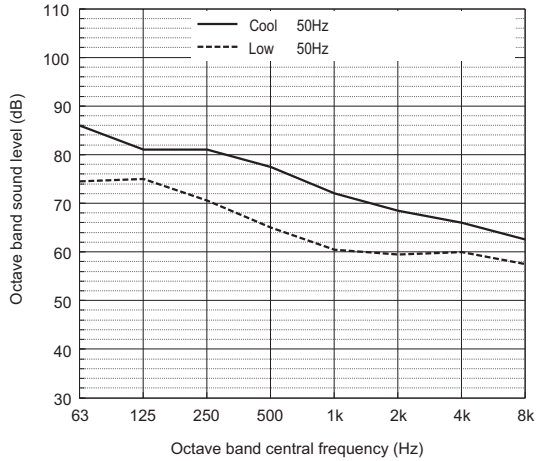

		63	125	250	500	1k	2k	4k	8k	dB(A)
Standard Cooling	50Hz	86.0	81.0	81.0	77.5	72.0	68.5	66.0	62.5	79.0
Low noise mode	50Hz	74.5	75.0	70.5	65.0	60.5	59.5	60.0	57.5	69.0

When Low noise mode is set, the A/C system's capacity is limited. The system could return to normal operation from Low noise mode automatically in the case that the operation condition is severe.

Sound power level of PURY-M550YSXM-A

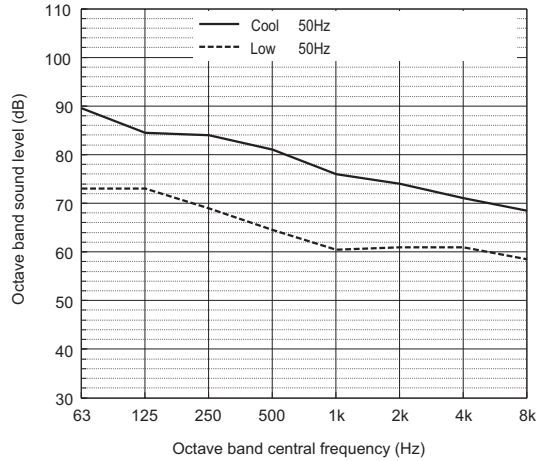

		63	125	250	500	1k	2k	4k	8k	dB(A)
Standard Cooling	50Hz	89.5	84.5	84.0	81.0	76.0	74.0	71.0	68.5	83.0
Low noise mode	50Hz	73.0	73.0	69.0	64.5	60.5	61.0	61.0	58.5	69.0

When Low noise mode is set, the A/C system's capacity is limited. The system could return to normal operation from Low noise mode automatically in the case that the operation condition is severe.

Sound power level of PURY-M450YSXM-A

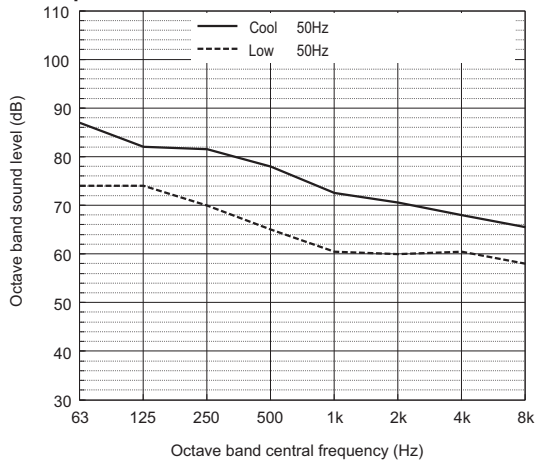

		63	125	250	500	1k	2k	4k	8k	dB(A)
Standard Cooling	50Hz	87.0	82.0	81.5	78.0	72.5	70.5	68.0	65.5	80.0
Low noise mode	50Hz	74.0	74.0	70.0	65.0	60.5	60.0	60.5	58.0	69.0

When Low noise mode is set, the A/C system's capacity is limited. The system could return to normal operation from Low noise mode automatically in the case that the operation condition is severe.

Sound power level of PURY-M600YSXM-A

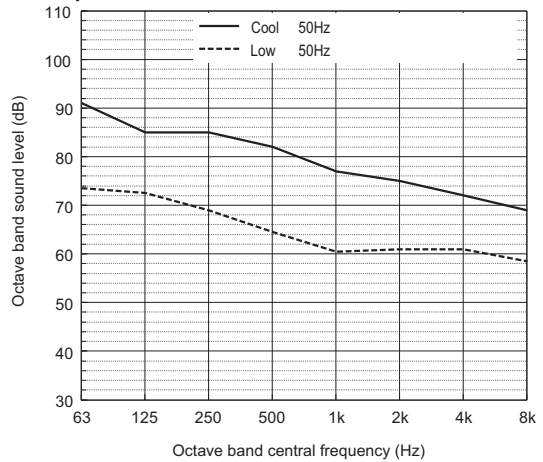

		63	125	250	500	1k	2k	4k	8k	dB(A)
Standard Cooling	50Hz	91.0	85.0	85.0	82.0	77.0	75.0	72.0	69.0	84.0
Low noise mode	50Hz	73.5	72.5	69.0	64.5	60.5	61.0	61.0	58.5	69.0

When Low noise mode is set, the A/C system's capacity is limited. The system could return to normal operation from Low noise mode automatically in the case that the operation condition is severe.

- Depending on the operation conditions, the unit generates noise caused by valve actuation, refrigerant flow, and pressure changes when operating normally. Please consider to avoid location where quietness is required.
For BC controller, it is recommended to be installed in places such as ceilings of corridor, rest rooms and plant rooms.
- The sound values are sound power level (PWL) based on ISO 3744:2010 (r = 3.5 m).

Sound power level of PURY-M650YSXM-A

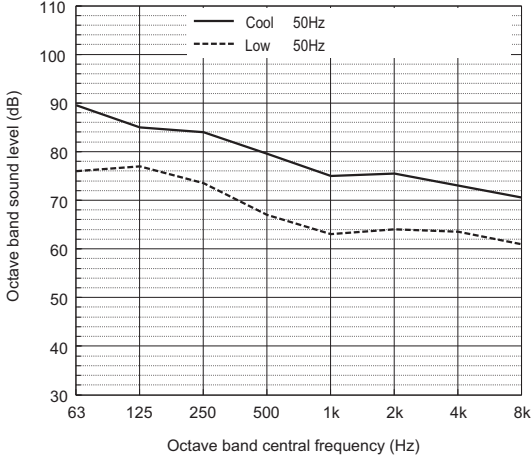

		63	125	250	500	1k	2k	4k	8k	dB(A)
Standard Cooling	50Hz	89.5	85.0	84.0	79.5	75.0	75.5	73.0	70.5	83.0
Low noise mode	50Hz	76.0	77.0	73.5	67.0	63.0	64.0	63.5	61.0	72.0

When Low noise mode is set, the A/C system's capacity is limited. The system could return to normal operation from Low noise mode automatically in the case that the operation condition is severe.

Sound power level of PURY-M800YSXM-A

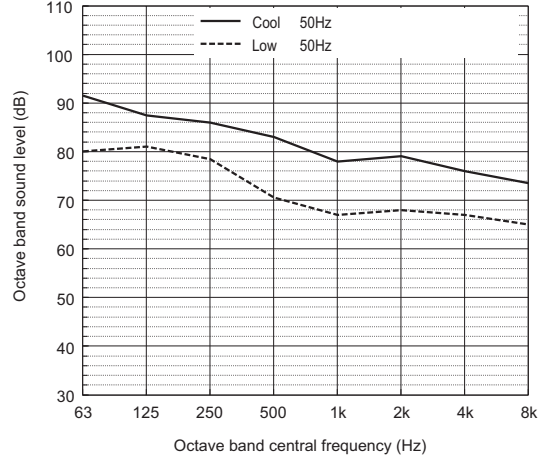

		63	125	250	500	1k	2k	4k	8k	dB(A)
Standard Cooling	50Hz	91.5	87.5	86.0	83.0	78.0	79.0	76.0	73.5	86.0
Low noise mode	50Hz	80.0	81.0	78.5	70.5	67.0	68.0	67.0	65.0	76.0

When Low noise mode is set, the A/C system's capacity is limited. The system could return to normal operation from Low noise mode automatically in the case that the operation condition is severe.

Sound power level of PURY-M700YSXM-A

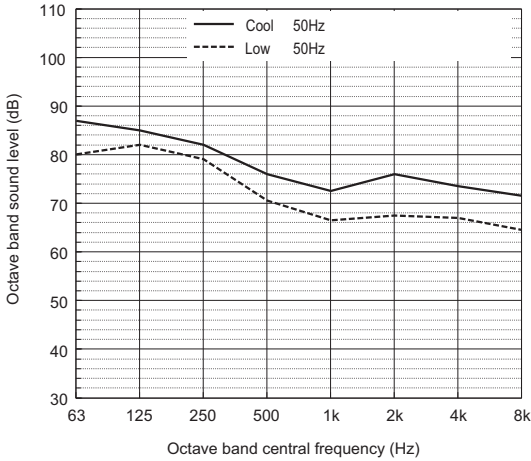

		63	125	250	500	1k	2k	4k	8k	dB(A)
Standard Cooling	50Hz	87.0	85.0	82.0	76.0	72.5	76.0	73.5	71.5	82.0
Low noise mode	50Hz	80.0	82.0	79.0	70.5	66.5	67.5	67.0	64.5	76.0

When Low noise mode is set, the A/C system's capacity is limited. The system could return to normal operation from Low noise mode automatically in the case that the operation condition is severe.

Sound power level of PURY-M850YSXM-A

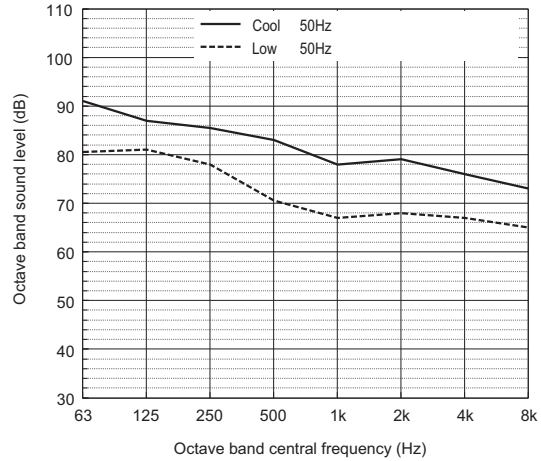

		63	125	250	500	1k	2k	4k	8k	dB(A)
Standard Cooling	50Hz	91.0	87.0	85.5	83.0	78.0	79.0	76.0	73.0	86.0
Low noise mode	50Hz	80.5	81.0	78.0	70.5	67.0	68.0	67.0	65.0	76.0

When Low noise mode is set, the A/C system's capacity is limited. The system could return to normal operation from Low noise mode automatically in the case that the operation condition is severe.

Sound power level of PURY-M750YSXM-A

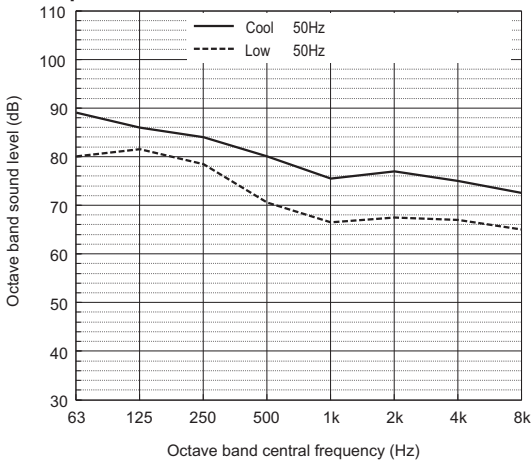

		63	125	250	500	1k	2k	4k	8k	dB(A)
Standard Cooling	50Hz	89.0	86.0	84.0	80.0	75.5	77.0	75.0	72.5	84.0
Low noise mode	50Hz	80.0	81.5	78.5	70.5	66.5	67.5	67.0	65.0	76.0

When Low noise mode is set, the A/C system's capacity is limited. The system could return to normal operation from Low noise mode automatically in the case that the operation condition is severe.

Sound power level of PURY-M900YSXM-A

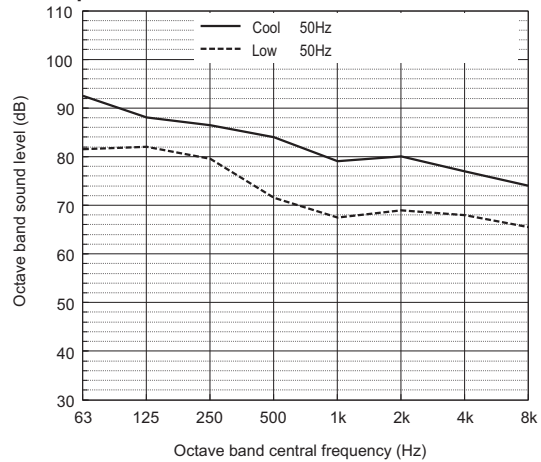

		63	125	250	500	1k	2k	4k	8k	dB(A)
Standard Cooling	50Hz	92.5	88.0	86.5	84.0	79.0	80.0	77.0	74.0	87.0
Low noise mode	50Hz	81.5	82.0	79.5	71.5	67.5	69.0	68.0	65.5	77.0

When Low noise mode is set, the A/C system's capacity is limited. The system could return to normal operation from Low noise mode automatically in the case that the operation condition is severe.

• Depending on the operation conditions, the unit generates noise caused by valve actuation, refrigerant flow, and pressure changes when operating normally. Please consider to avoid location where quietness is required.

For BC controller, it is recommended to be installed in places such as ceilings of corridor, rest rooms and plant rooms.

• The sound values are sound power level (PWL) based on ISO 3744:2010 (r = 3.5 m).

Sound power level of PURY-M950YSXM-A

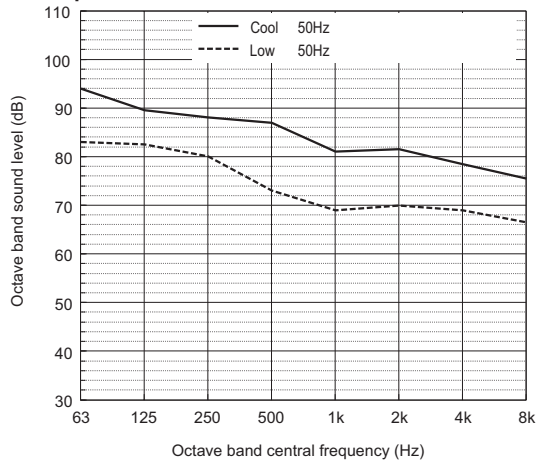

		63	125	250	500	1k	2k	4k	8k	dB(A)
Standard Cooling	50Hz	94.0	89.5	88.0	87.0	81.0	81.5	78.5	75.5	89.0
Low noise mode	50Hz	83.0	82.5	80.0	73.0	69.0	70.0	69.0	66.5	78.0

When Low noise mode is set, the A/C system's capacity is limited. The system could return to normal operation from Low noise mode automatically in the case that the operation condition is severe.

Sound power level of PURY-M1000YSXM-A

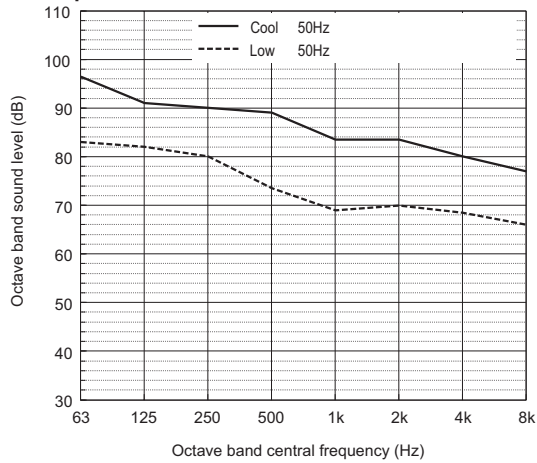

		63	125	250	500	1k	2k	4k	8k	dB(A)
Standard Cooling	50Hz	96.5	91.0	90.0	89.0	83.5	83.5	80.0	77.0	91.0
Low noise mode	50Hz	83.0	82.0	80.0	73.5	69.0	70.0	68.5	66.0	78.0

When Low noise mode is set, the A/C system's capacity is limited. The system could return to normal operation from Low noise mode automatically in the case that the operation condition is severe.

- Depending on the operation conditions, the unit generates noise caused by valve actuation, refrigerant flow, and pressure changes when operating normally. Please consider to avoid location where quietness is required.
For BC controller, it is recommended to be installed in places such as ceilings of corridor, rest rooms and plant rooms.
- The sound values are sound power level (PWL) based on ISO 3744:2010 (r = 3.5 m).

5-4. Sound levels in heating mode (Sound power level)

Sound power level of PURY-M200YXM-A

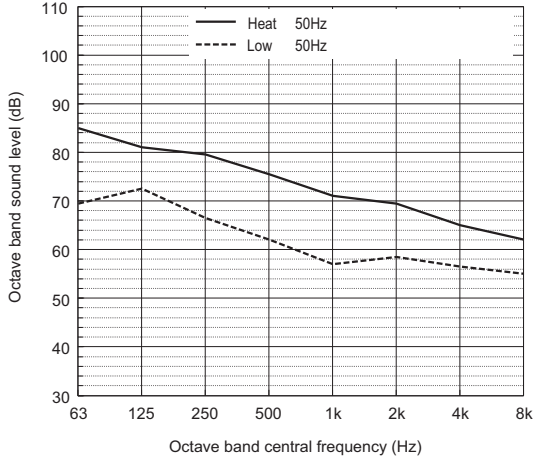

		63	125	250	500	1k	2k	4k	8k	dB(A)
Standard Heating	50Hz	85.0	81.0	79.5	75.5	71.0	69.5	65.0	62.0	78.0
Low noise mode	50Hz	69.5	72.5	66.5	62.0	57.0	58.5	56.5	55.0	66.0

When Low noise mode is set the A/C system's capacity is limited. The system could return to normal operation from Low noise mode automatically in the case that the operation condition is severe.

Sound power level of PURY-M350YXM-A

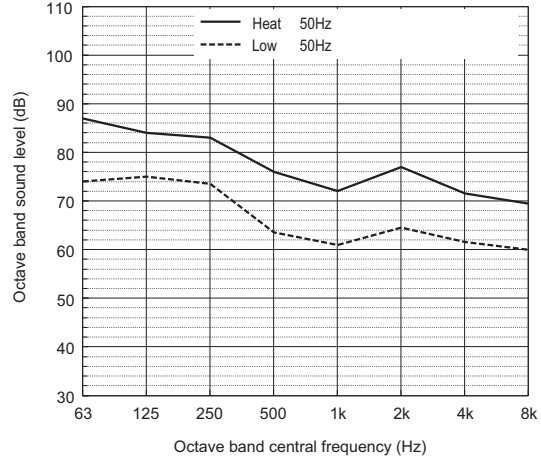

		63	125	250	500	1k	2k	4k	8k	dB(A)
Standard Heating	50Hz	87.0	84.0	83.0	76.0	72.0	77.0	71.5	69.5	82.0
Low noise mode	50Hz	74.0	75.0	73.5	63.5	61.0	64.5	61.5	60.0	71.0

When Low noise mode is set the A/C system's capacity is limited. The system could return to normal operation from Low noise mode automatically in the case that the operation condition is severe.

Sound power level of PURY-M250YXM-A

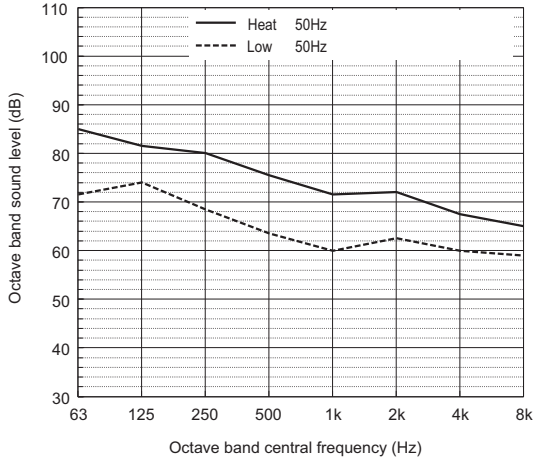

		63	125	250	500	1k	2k	4k	8k	dB(A)
Standard Heating	50Hz	85.0	81.5	80.0	75.5	71.5	72.0	67.5	65.0	79.0
Low noise mode	50Hz	71.5	74.0	68.5	63.5	60.0	62.5	60.0	59.0	69.0

When Low noise mode is set the A/C system's capacity is limited. The system could return to normal operation from Low noise mode automatically in the case that the operation condition is severe.

Sound power level of PURY-M400YXM-A

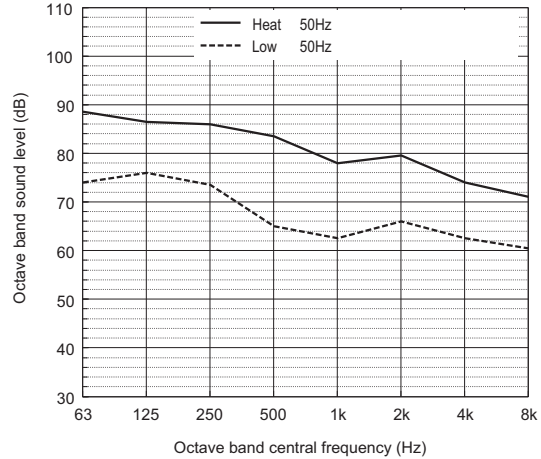

		63	125	250	500	1k	2k	4k	8k	dB(A)
Standard Heating	50Hz	88.5	86.5	86.0	83.5	78.0	79.5	74.0	71.0	86.0
Low noise mode	50Hz	74.0	76.0	73.5	65.0	62.5	66.0	62.5	60.5	72.0

When Low noise mode is set the A/C system's capacity is limited. The system could return to normal operation from Low noise mode automatically in the case that the operation condition is severe.

Sound power level of PURY-M300YXM-A

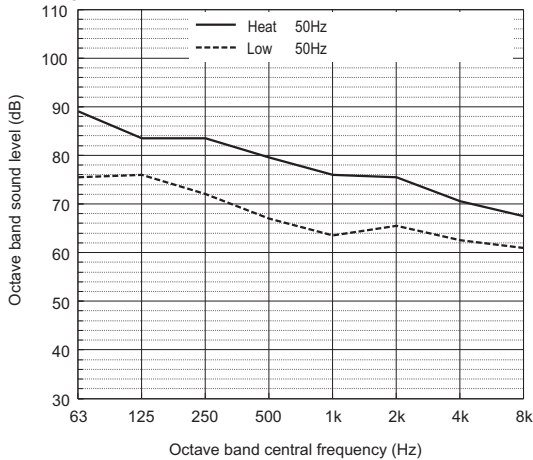

		63	125	250	500	1k	2k	4k	8k	dB(A)
Standard Heating	50Hz	89.0	83.5	83.5	79.5	76.0	75.5	70.5	67.5	83.0
Low noise mode	50Hz	75.5	76.0	72.0	67.0	63.5	65.5	62.5	61.0	72.0

When Low noise mode is set the A/C system's capacity is limited. The system could return to normal operation from Low noise mode automatically in the case that the operation condition is severe.

Sound power level of PURY-M450YXM-A

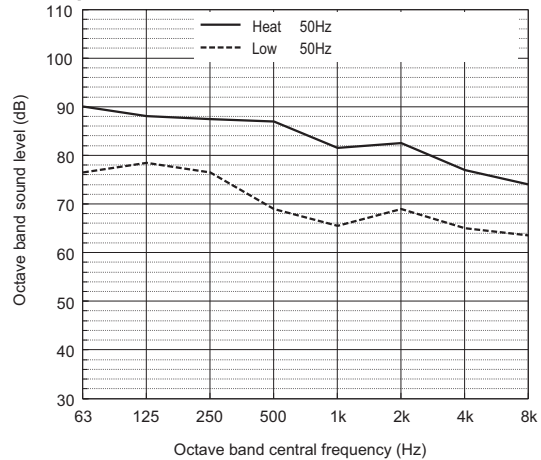

		63	125	250	500	1k	2k	4k	8k	dB(A)
Standard Heating	50Hz	90.0	88.0	87.5	87.0	81.5	82.5	77.0	74.0	89.0
Low noise mode	50Hz	76.5	78.5	76.5	69.0	65.5	69.0	65.0	63.5	75.0

When Low noise mode is set the A/C system's capacity is limited. The system could return to normal operation from Low noise mode automatically in the case that the operation condition is severe.

• Depending on the operation conditions, the unit generates noise caused by valve actuation, refrigerant flow, and pressure changes when operating normally. Please consider to avoid location where quietness is required.

For BC controller, it is recommended to be installed in places such as ceilings of corridor, rest rooms and plant rooms.

• The sound values are sound power level (PWL) based on ISO 3744:2010 (r = 3.5 m).

Sound power level of PURY-M500YXM-A

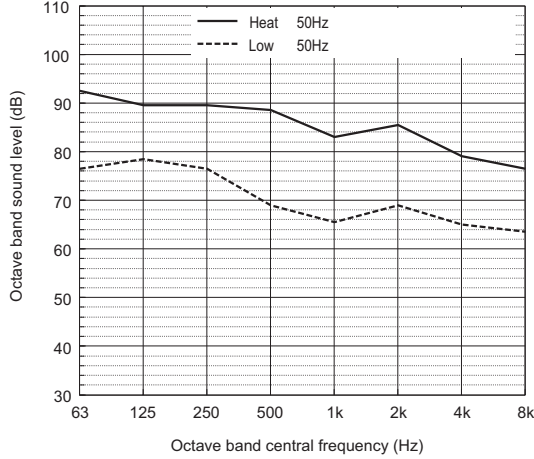

		63	125	250	500	1k	2k	4k	8k	dB(A)
Standard Heating	50Hz	92.5	89.5	89.5	88.5	83.0	85.5	79.0	76.5	91.0
Low noise mode	50Hz	76.5	78.5	76.5	69.0	65.5	69.0	65.0	63.5	75.0

When Low noise mode is set, the A/C system's capacity is limited. The system could return to normal operation from Low noise mode automatically in the case that the operation condition is severe.

Sound power level of PURY-M500YSXM-A

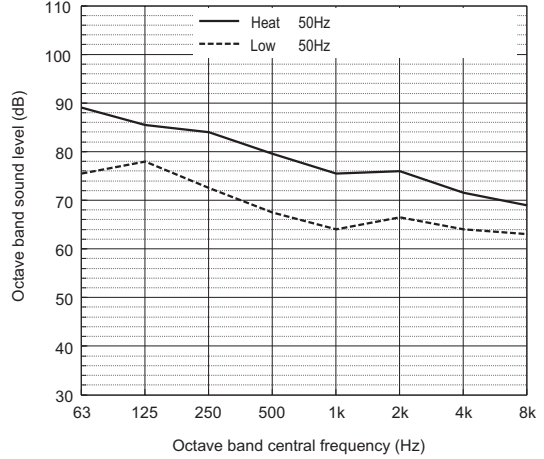

		63	125	250	500	1k	2k	4k	8k	dB(A)
Standard Heating	50Hz	89.0	85.5	84.0	79.5	75.5	76.0	71.5	69.0	83.0
Low noise mode	50Hz	75.5	78.0	72.5	67.5	64.0	66.5	64.0	63.0	73.0

When Low noise mode is set, the A/C system's capacity is limited. The system could return to normal operation from Low noise mode automatically in the case that the operation condition is severe.

Sound power level of PURY-M400YSXM-A

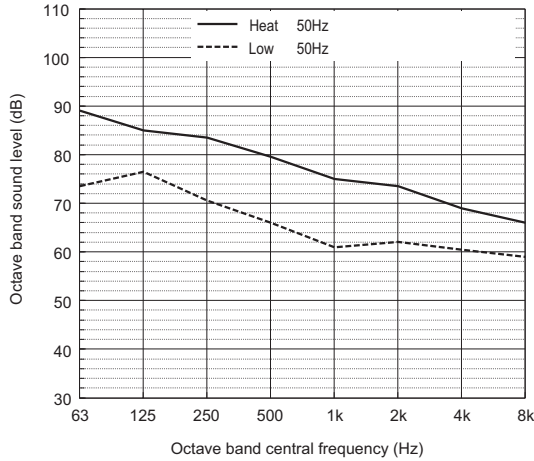

		63	125	250	500	1k	2k	4k	8k	dB(A)
Standard Heating	50Hz	89.0	85.0	83.5	79.5	75.0	73.5	69.0	66.0	82.0
Low noise mode	50Hz	73.5	76.5	70.5	66.0	61.0	62.0	60.5	59.0	70.0

When Low noise mode is set, the A/C system's capacity is limited. The system could return to normal operation from Low noise mode automatically in the case that the operation condition is severe.

Sound power level of PURY-M550YSXM-A

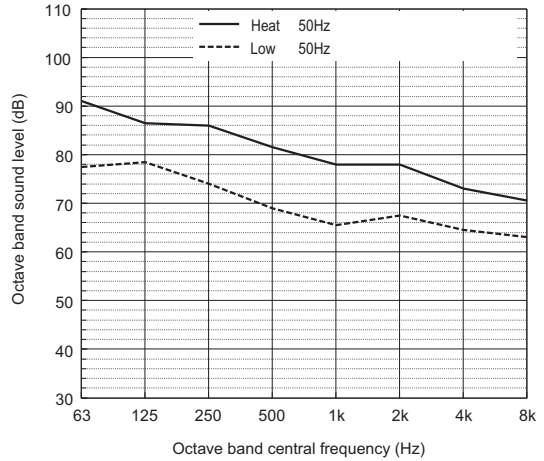

		63	125	250	500	1k	2k	4k	8k	dB(A)
Standard Heating	50Hz	91.0	86.5	86.0	81.5	78.0	78.0	73.0	70.5	85.0
Low noise mode	50Hz	77.5	78.5	74.0	69.0	65.5	67.5	64.5	63.0	74.0

When Low noise mode is set, the A/C system's capacity is limited. The system could return to normal operation from Low noise mode automatically in the case that the operation condition is severe.

Sound power level of PURY-M450YSXM-A

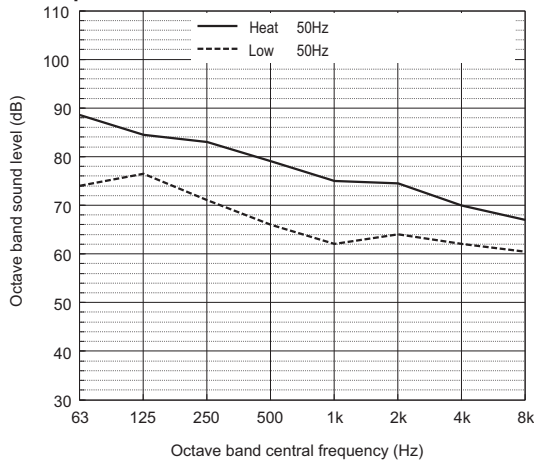

		63	125	250	500	1k	2k	4k	8k	dB(A)
Standard Heating	50Hz	88.5	84.5	83.0	79.0	75.0	74.5	70.0	67.0	82.0
Low noise mode	50Hz	74.0	76.5	71.0	66.0	62.0	64.0	62.0	60.5	71.0

When Low noise mode is set, the A/C system's capacity is limited. The system could return to normal operation from Low noise mode automatically in the case that the operation condition is severe.

Sound power level of PURY-M600YSXM-A

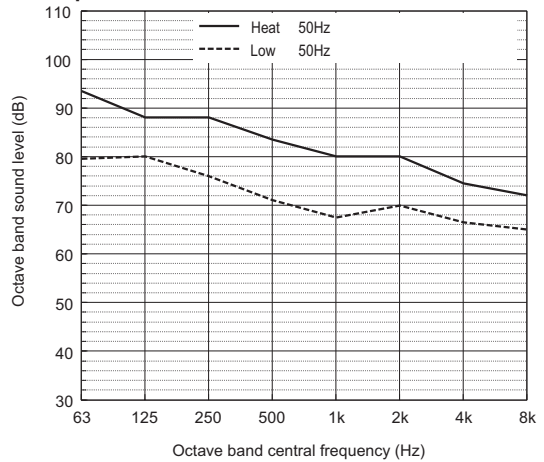

		63	125	250	500	1k	2k	4k	8k	dB(A)
Standard Heating	50Hz	93.5	88.0	88.0	83.5	80.0	80.0	74.5	72.0	87.0
Low noise mode	50Hz	79.5	80.0	76.0	71.0	67.5	70.0	66.5	65.0	76.0

When Low noise mode is set, the A/C system's capacity is limited. The system could return to normal operation from Low noise mode automatically in the case that the operation condition is severe.

- Depending on the operation conditions, the unit generates noise caused by valve actuation, refrigerant flow, and pressure changes when operating normally. Please consider to avoid location where quietness is required.
For BC controller, it is recommended to be installed in places such as ceilings of corridor, rest rooms and plant rooms.
- The sound values are sound power level (PWL) based on ISO 3744:2010 (r = 3.5 m).

Sound power level of PURY-M650YSXM-A

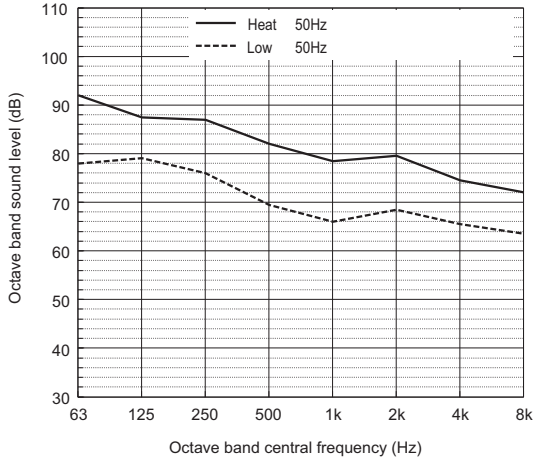

		63	125	250	500	1k	2k	4k	8k	dB(A)
Standard Heating	50Hz	92.0	87.5	87.0	82.0	78.5	79.5	74.5	72.0	86.0
Low noise mode	50Hz	78.0	79.0	76.0	69.5	66.0	68.5	65.5	63.5	75.0

When Low noise mode is set, the A/C system's capacity is limited. The system could return to normal operation from Low noise mode automatically in the case that the operation condition is severe.

Sound power level of PURY-M800YSXM-A

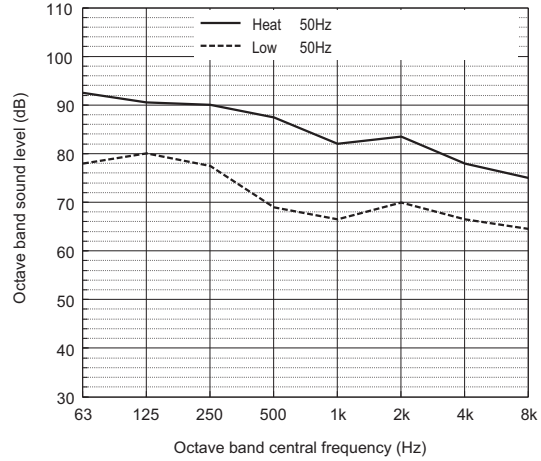

		63	125	250	500	1k	2k	4k	8k	dB(A)
Standard Heating	50Hz	92.5	90.5	90.0	87.5	82.0	83.5	78.0	75.0	90.0
Low noise mode	50Hz	78.0	80.0	77.5	69.0	66.5	70.0	66.5	64.5	76.0

When Low noise mode is set, the A/C system's capacity is limited. The system could return to normal operation from Low noise mode automatically in the case that the operation condition is severe.

Sound power level of PURY-M700YSXM-A

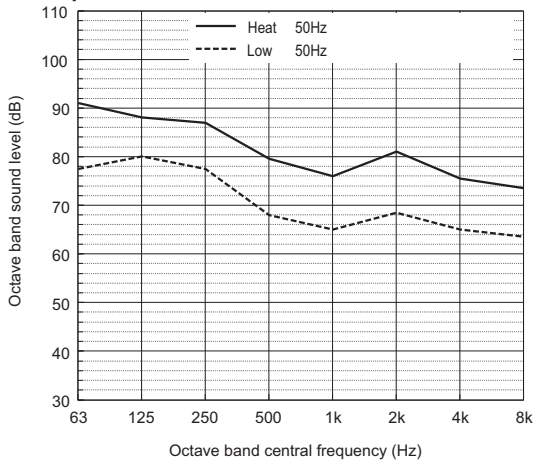

		63	125	250	500	1k	2k	4k	8k	dB(A)
Standard Heating	50Hz	91.0	88.0	87.0	79.5	76.0	81.0	75.5	73.5	86.0
Low noise mode	50Hz	77.5	80.0	77.5	68.0	65.0	68.5	65.0	63.5	75.0

When Low noise mode is set, the A/C system's capacity is limited. The system could return to normal operation from Low noise mode automatically in the case that the operation condition is severe.

Sound power level of PURY-M850YSXM-A

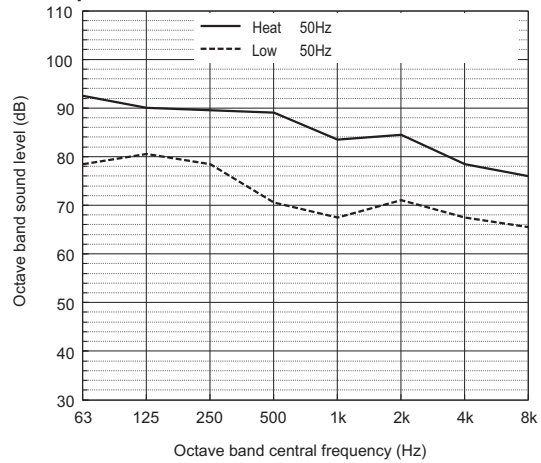

		63	125	250	500	1k	2k	4k	8k	dB(A)
Standard Heating	50Hz	92.5	90.0	89.5	89.0	83.5	84.5	78.5	76.0	91.0
Low noise mode	50Hz	78.5	80.5	78.5	70.5	67.5	71.0	67.5	65.5	77.0

When Low noise mode is set, the A/C system's capacity is limited. The system could return to normal operation from Low noise mode automatically in the case that the operation condition is severe.

Sound power level of PURY-M750YSXM-A

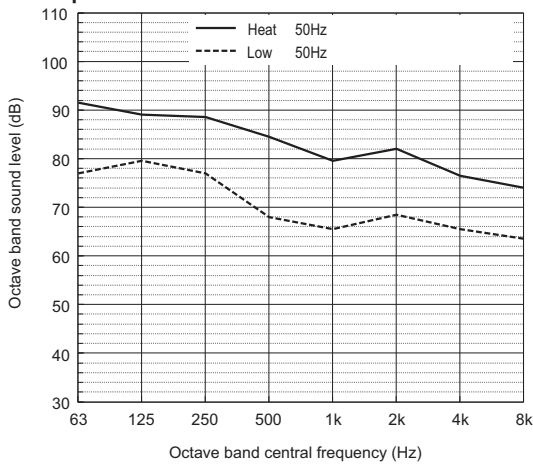

		63	125	250	500	1k	2k	4k	8k	dB(A)
Standard Heating	50Hz	91.5	89.0	88.5	84.5	79.5	82.0	76.5	74.0	88.0
Low noise mode	50Hz	77.0	79.5	77.0	68.0	65.5	68.5	65.5	63.5	75.0

When Low noise mode is set, the A/C system's capacity is limited. The system could return to normal operation from Low noise mode automatically in the case that the operation condition is severe.

Sound power level of PURY-M900YSXM-A

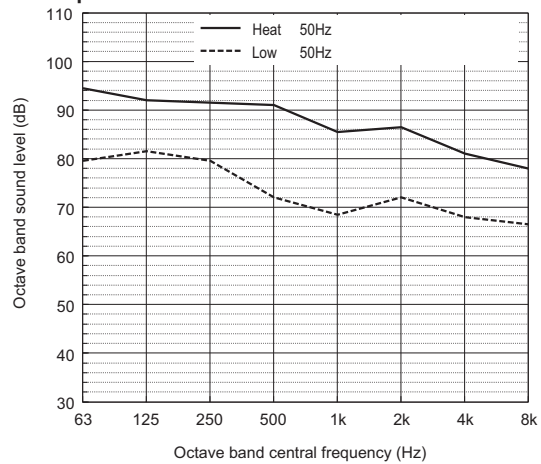

		63	125	250	500	1k	2k	4k	8k	dB(A)
Standard Heating	50Hz	94.5	92.0	91.5	91.0	85.5	86.5	81.0	78.0	93.0
Low noise mode	50Hz	79.5	81.5	79.5	72.0	68.5	72.0	68.0	66.5	78.0

When Low noise mode is set, the A/C system's capacity is limited. The system could return to normal operation from Low noise mode automatically in the case that the operation condition is severe.

• Depending on the operation conditions, the unit generates noise caused by valve actuation, refrigerant flow, and pressure changes when operating normally. Please consider to avoid location where quietness is required.

For BC controller, it is recommended to be installed in places such as ceilings of corridor, rest rooms and plant rooms.

• The sound values are sound power level (PWL) based on ISO 3744:2010 (r = 3.5 m).

Sound power level of PURY-M950YSXM-A

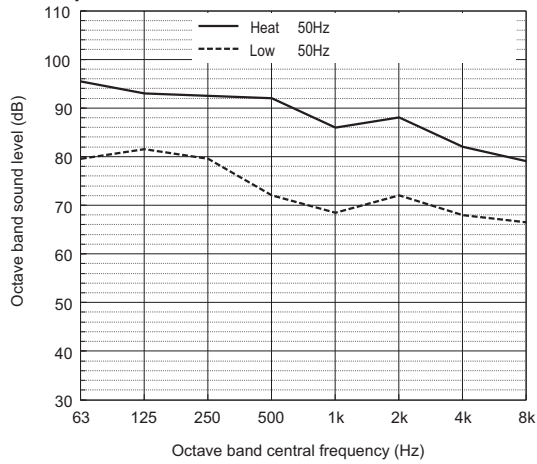

		63	125	250	500	1k	2k	4k	8k	dB(A)
Standard Heating	50Hz	95.5	93.0	92.5	92.0	86.0	88.0	82.0	79.0	94.0
Low noise mode	50Hz	79.5	81.5	79.5	72.0	68.5	72.0	68.0	66.5	78.0

When Low noise mode is set, the A/C system's capacity is limited. The system could return to normal operation from Low noise mode automatically in the case that the operation condition is severe.

Sound power level of PURY-M1000YSXM-A

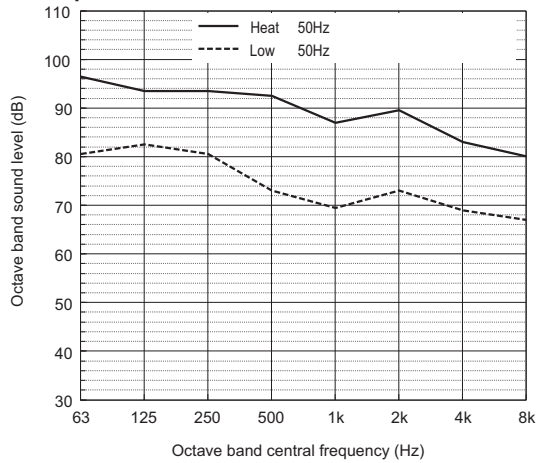

		63	125	250	500	1k	2k	4k	8k	dB(A)
Standard Heating	50Hz	96.5	93.5	93.5	92.5	87.0	89.5	83.0	80.0	95.0
Low noise mode	50Hz	80.5	82.5	80.5	73.0	69.5	73.0	69.0	67.0	79.0

When Low noise mode is set, the A/C system's capacity is limited. The system could return to normal operation from Low noise mode automatically in the case that the operation condition is severe.

- Depending on the operation conditions, the unit generates noise caused by valve actuation, refrigerant flow, and pressure changes when operating normally. Please consider to avoid location where quietness is required.
For BC controller, it is recommended to be installed in places such as ceilings of corridor, rest rooms and plant rooms.
- The sound values are sound power level (PWL) based on ISO 3744:2010 (r = 3.5 m).

[PURY-M200-500YXM, PURY-M400-1000YSXM]

Measurement condition

Measurement frequency: 1 Hz-80 Hz

Measurement point: Ground surface 20 cm away from the unit leg

Installation condition: Direct installation on the concrete floor

Power source: 3-phase 4-wire 380-400-415 V 50 Hz

Operation condition: JIS condition (cooling, heating)

Measurement device: Vibration level meter for vibration pollution VR-6100 (JIS-compliant product)

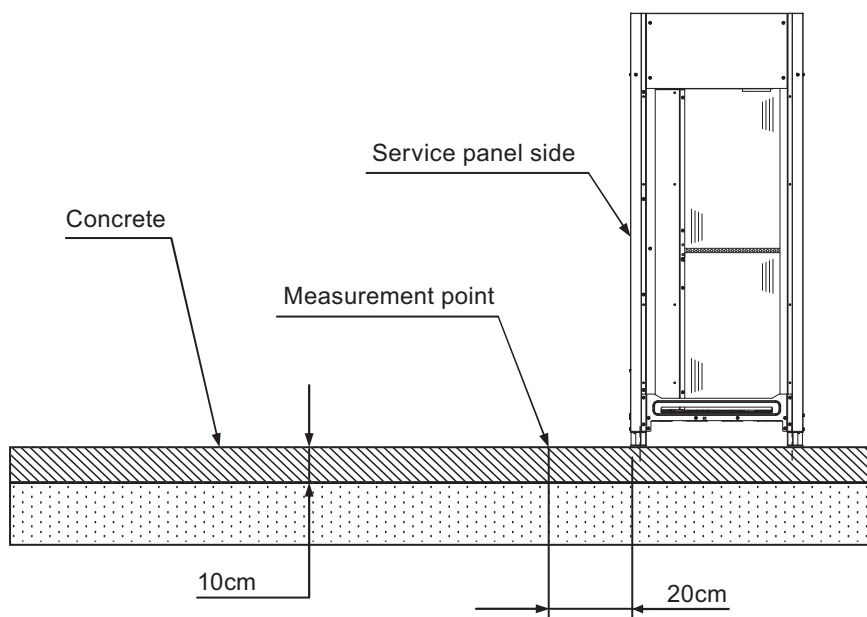

Vibration level

Model	Vibration level (dB)
PURY-M200YXM-A (-BS)	45
PURY-M250YXM-A (-BS)	45
PURY-M300YXM-A (-BS)	45
PURY-M350YXM-A (-BS)	47
PURY-M400YXM-A (-BS)	47
PURY-M450YXM-A (-BS)	47
PURY-M500YXM-A (-BS)	47
PURY-M400YSXM-A (-BS)	48
PURY-M450YSXM-A (-BS)	48
PURY-M500YSXM-A (-BS)	48
PURY-M550YSXM-A (-BS)	48
PURY-M600YSXM-A (-BS)	48
PURY-M650YSXM-A (-BS)	50.5
PURY-M700YSXM-A (-BS)	50.5
PURY-M750YSXM-A (-BS)	50.5
PURY-M800YSXM-A (-BS)	50.5
PURY-M850YSXM-A (-BS)	50.5
PURY-M900YSXM-A (-BS)	50.5
PURY-M950YSXM-A (-BS)	50.5
PURY-M1000YSXM-A (-BS)	50.5

* Vibration level varies depending on the conditions of actual installation site.

• Cooling only

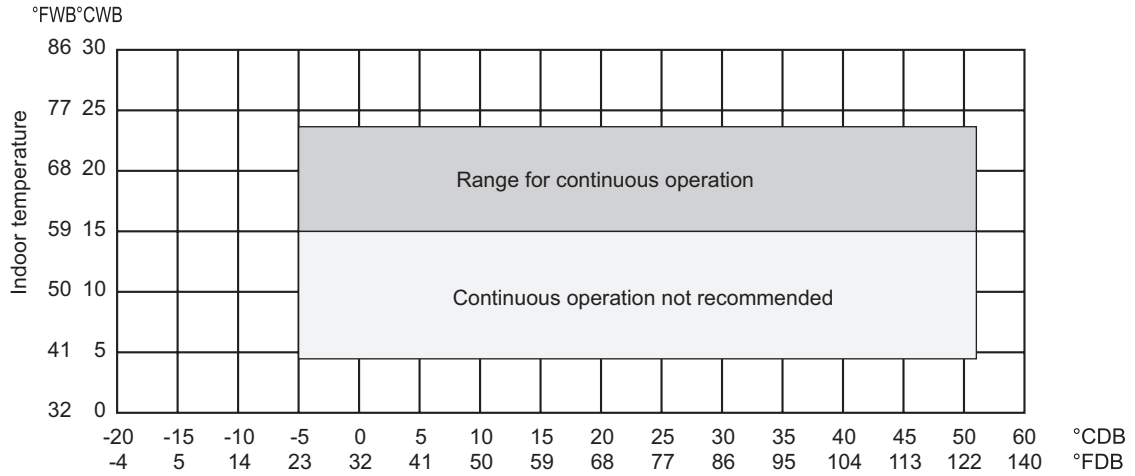

• Heating only

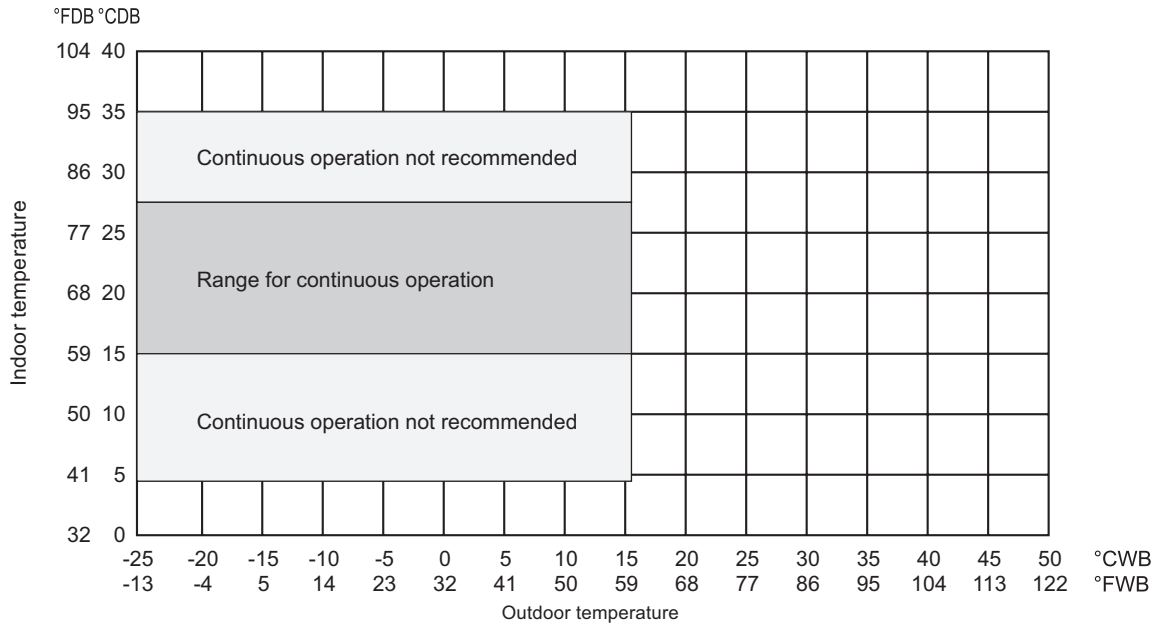

• Combination of cooling/heating operation (Cooling main or Heating main)

	Cooling	Heating
Indoor temperature	15 to 24 °CWB (59 to 75 °FWB)	15 to 27 °CDB (59 to 81 °FDB)
Outdoor temperature	-10 to 21 °CDB (14 to 70 °FDB)	-11 to 15.5 °CWB (12 to 60 °FWB)

8-1. Selection of Cooling/Heating Units

How to determine the capacity when less than or equal to 100% indoor model size units are connected in total:

The purpose of this flow chart is to select the indoor and outdoor units. For other purposes, this flow chart is intended only for reference.

PURY-M-Y(S)XM-A

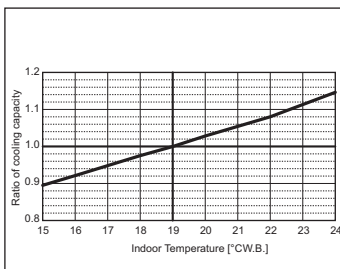
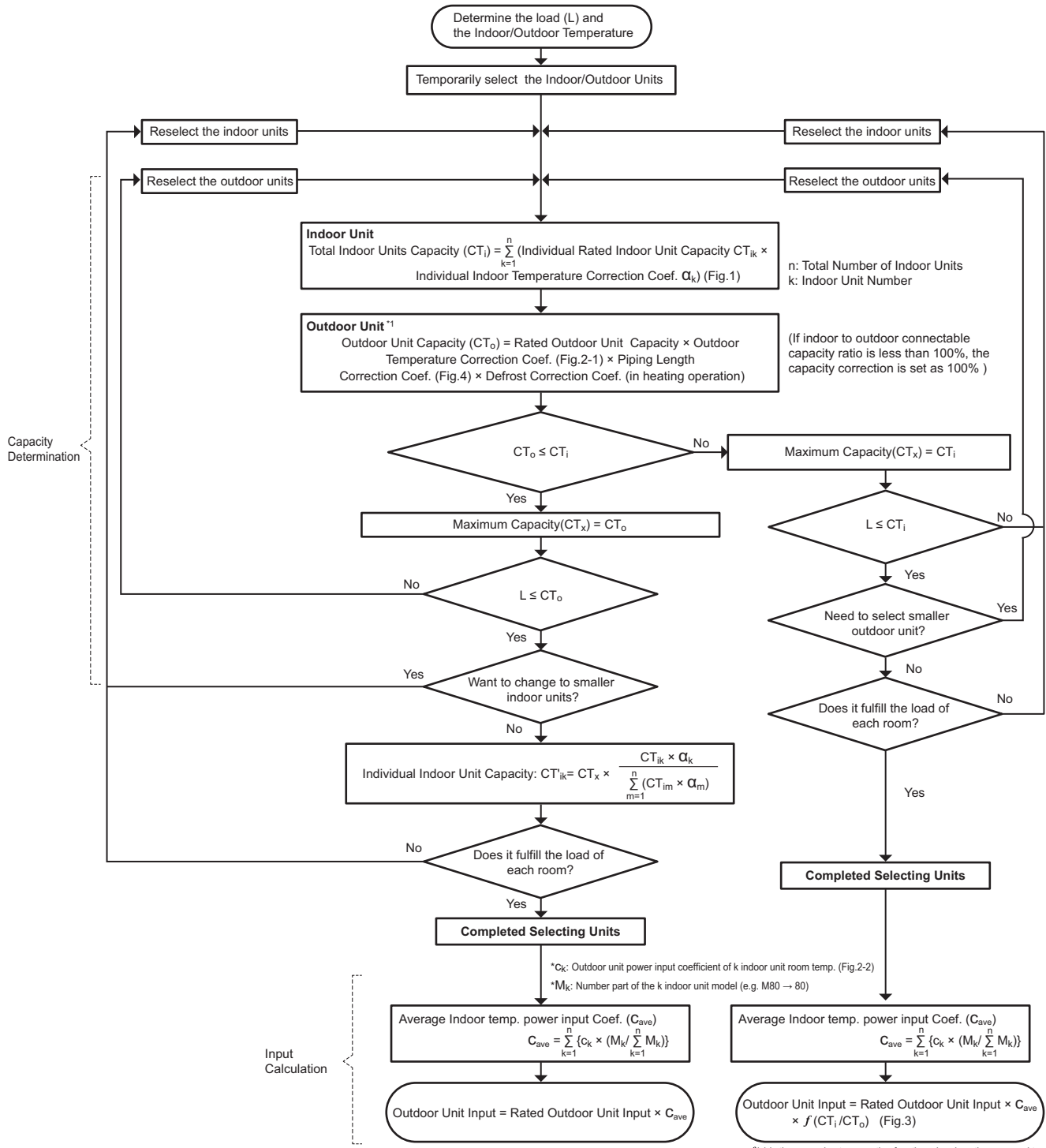

Fig.1 Indoor unit temperature correction

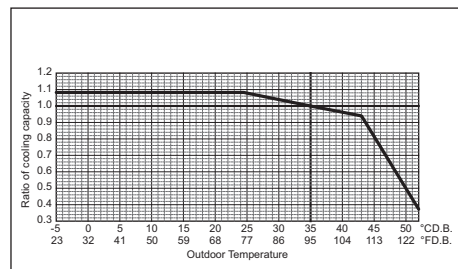

Fig.2-1 Outdoor unit temperature correction (capacity)

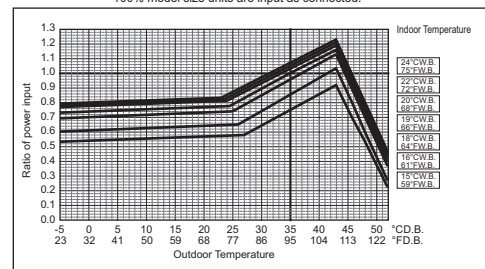

Fig.2-2 Outdoor unit temperature correction (power input)

*1 When the indoor unit sizes from M100 to M140 or total capacity indoor units from 81 to 140 are connected to only 1 port on the BC controller in the R2 system, the cooling capacity of the outdoor unit should be multiplied by a correction factor of 0.98.

How to determine the capacity when greater than 100% indoor model size units are connected in total:

The purpose of this flow chart is to select the indoor and outdoor units. For other purposes, this flow chart is intended only for reference.

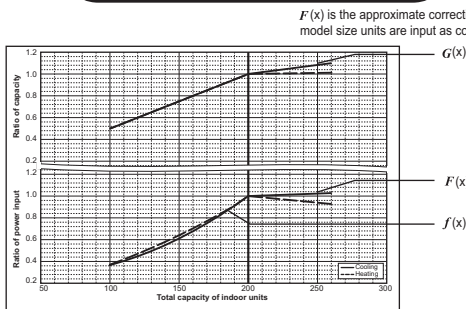
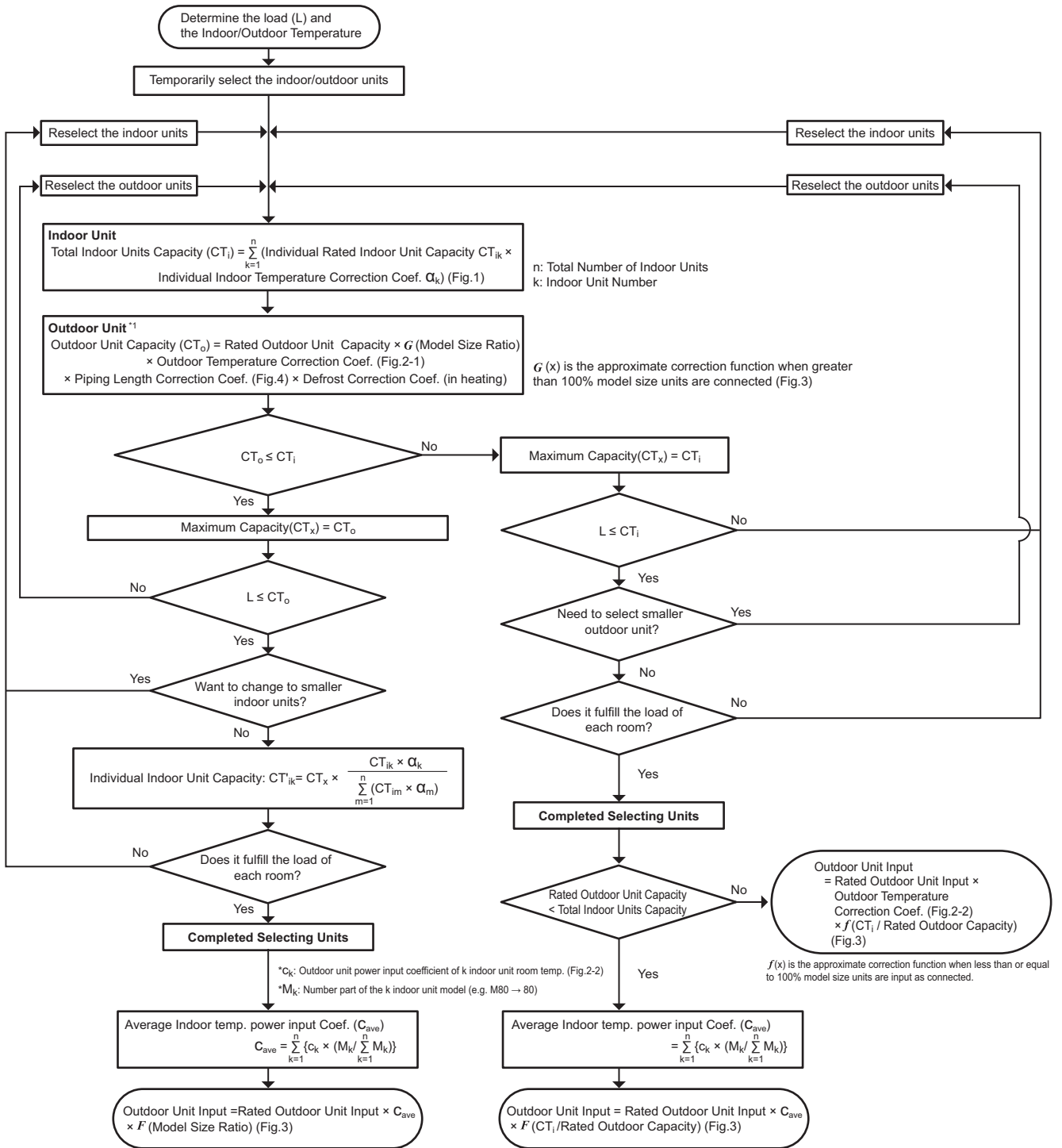

Fig.3 Correction by total indoor

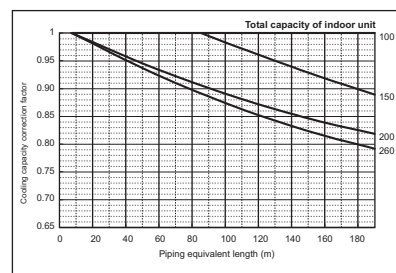

Fig.4 Correction of refrigerant piping length

*1 When the indoor unit sizes from M100 to M140 or total capacity indoor units from 81 to 140 are connected to only 1 port on the BC controller in the R2 system, the cooling capacity of the outdoor unit should be multiplied by a correction factor of 0.98.

<Cooling>

Design Condition	
Outdoor Design Dry Bulb Temperature	37 °C
Total Cooling Load	19.0 kW
Room1	
Indoor Design Dry Bulb Temperature	27 °C
Indoor Design Wet Bulb Temperature	20 °C
Cooling Load	9.0 kW
Room2	
Indoor Design Dry Bulb Temperature	24 °C
Indoor Design Wet Bulb Temperature	18 °C
Cooling Load	10.0 kW
<Other>	
Indoor/Outdoor Equivalent Piping Length	50 m

1. Cooling Calculation

(1) Temporary Selection of Indoor Units

Room1	PLFY-M100	11.2 kW (Rated)
Room2	PLFY-M100	11.2 kW (Rated)

(2) Total Indoor Units Capacity

$$M100 + M100 = M200$$

(3) Selection of Outdoor Unit

The M200 outdoor unit is selected as total indoor units capacity is M200

PURY-M200	22.4 kW
-----------	---------

(4) Total Indoor Units Capacity Correction Calculation

Room1	Indoor Design Wet Bulb Temperature Correction (20°C)	1.03 (Refer to Fig.1)
Room2	Indoor Design Wet Bulb Temperature Correction (18°C)	0.98 (Refer to Fig.1)

Total Indoor Units Capacity (CTi)

$$CTi = \Sigma (\text{Indoor Unit Rating} \times \text{Indoor Design Temperature Correction})$$

$$= 11.2 \times 1.03 + 11.2 \times 0.98$$

$$= 22.5 \text{ kW}$$

(5) Outdoor Unit Correction Calculation

Outdoor Design Dry Bulb Temperature Correction (37°C)	0.99 (Refer to Fig.2)
Piping Length Correction (50 m)	0.95 (Refer to Fig.3)

Total Outdoor Unit Capacity (CTo)

$$CTo = \text{Outdoor Rating} \times \text{Outdoor Design Temperature Correction} \times \text{Piping Length Correction}$$

$$= 22.4 \times 0.99 \times 0.95$$

$$= 21.0 \text{ kW}$$

(6) Determination of Maximum System Capacity (CTx)

Comparison of Capacity between Total Indoor Units Capacity (CTi) and Total Outdoor Unit Capacity (CTo)

$$CTi = 22.5 > CTo = 21.0, \text{ thus, select } CTo.$$

$$CTx = CTo = 21.0 \text{ kW}$$

(7) Comparison with Essential Load

Against the essential load 19.0kW, the maximum system capacity is 21.0kW: Proper outdoor units have been selected.

(8) Calculation of Maximum Indoor Unit Capacity of Each Room

CTx = CTo, thus, calculate by the calculation below

Room1

$$\text{Maximum Capacity} \times \text{Room1 Capacity after the Temperature Correction} / (\text{Room1,2 Total Capacity after the Temperature Correction})$$

$$= 21.0 \times (11.2 \times 1.03) / (11.2 \times 1.03 + 11.2 \times 0.98)$$

$$= 10.8 \text{ kW} \quad \text{OK: fulfills the load 9.0kW}$$

Room2

$$\text{Maximum Capacity} \times \text{Room2 Capacity after the Temperature Correction} / (\text{Room1,2 Total Capacity after the Temperature Correction})$$

$$= 21.0 \times (11.2 \times 0.98) / (11.2 \times 1.03 + 11.2 \times 0.98)$$

$$= 10.2 \text{ kW} \quad \text{OK: fulfills the load 10.0kW}$$

Go on to the heating trial calculation since the selected units fulfill the cooling loads of Room 1, 2.

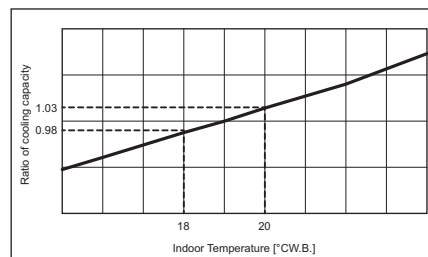

Fig.1 Indoor unit temperature correction
To be used to correct indoor unit only

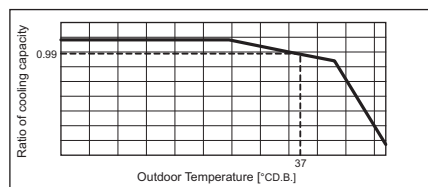

Fig.2 Outdoor unit temperature correction
To be used to correct outdoor unit only

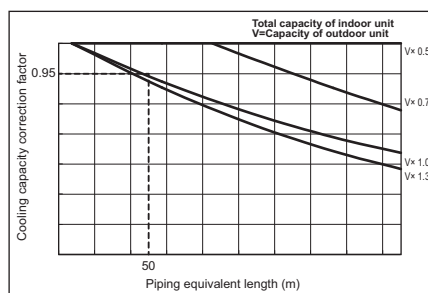

Fig.3 Correction of refrigerant piping length

<Heating>

Design Condition	
Outdoor Design Wet Bulb Temperature	-3 °C
Total Heating Load	18.5 kW
Room1	
Indoor Design Dry Bulb Temperature	25 °C
Heating Load	9.5 kW
Room2	
Indoor Design Dry Bulb Temperature	25 °C
Heating Load	9.0 kW
<Other>	
Indoor/Outdoor Equivalent Piping Length	50 m

2. Heating Calculation

(1) Temporary Selection of Indoor Units

Room1	PLFY-M100	12.5 kW (Rated)
Room2	PLFY-M100	12.5 kW (Rated)

(2) Total Indoor Units Capacity

M100 + M100 = M200

(3) Selection of Outdoor Unit

The M200 outdoor unit is selected as total indoor units capacity is M200
 PURY-M200 **25.0 kW**

(4) Total Indoor Units Capacity Correction Calculation

Room1	Indoor Design Dry Bulb Temperature Correction (25°C)	0.80 (Refer to Fig.4)
Room2	Indoor Design Dry Bulb Temperature Correction (25°C)	0.80 (Refer to Fig.4)

Total Indoor Units Capacity (CTi)

$$CTi = \sum (\text{Indoor Unit Rating} \times \text{Indoor Design Temperature Correction})$$

$$= 12.5 \times 0.80 + 12.5 \times 0.80$$

$$= 20.0 \text{ kW}$$

(5) Outdoor Unit Correction Calculation

Outdoor Design Wet Bulb Temperature Correction (-3°C)	0.98 (Refer to Fig.5)
Piping Length Correction (50 m)	0.97 (Refer to Fig.6)
Defrost Correction	0.89 (Refer to Tbl.1)

Total Outdoor Unit Capacity (CTo)

$$CTo = \text{Outdoor Unit Rating} \times \text{Outdoor Design Temperature Correction} \times \text{Piping Length Correction} \times \text{Defrost Correction}$$

$$= 25.0 \times 0.98 \times 0.97 \times 0.89$$

$$= 21.1 \text{ kW}$$

(6) Determination of Maximum System Capacity (CTx)

Comparison of Capacity between Total Indoor Units Capacity (CTi) and Total Outdoor Unit Capacity (CTo)

CTi = 20.0 < CTo = 21.1, thus, select CTi.
 CTx = CTi = 20.0 kW

(7) Comparison with Essential Load

Against the essential load 18.5kW, the maximum system capacity is 20.0kW: Proper outdoor units have been selected.

(8) Calculation of Maximum Indoor Unit Capacity of Each Room

CTx = CTi, thus, calculate by the calculation below

Room1	
Indoor Unit Rating × Indoor Design Temperature Correction	
= 12.5 × 0.80	
= 10.0 kW	OK: fulfills the load 9.5kW
Room2	
Indoor Unit Rating × Indoor Design Temperature Correction	
= 12.5 × 0.80	
= 10.0 kW	OK: fulfills the load 9.0kW

Tbl.1 Table of correction factor at frost and defrost

Outdoor inlet air temp. °CWB	6	4	2	1	0	-2	-4	-6	-8	-10	-20
Outdoor inlet air temp. °FWB	43	39	36	34	32	28	25	21	18	14	-4
PURY-M200	1.00	0.95	0.84	0.825	0.83	0.87	0.90	0.95	0.95	0.95	0.95
PURY-M250	1.00	0.95	0.84	0.825	0.83	0.87	0.90	0.95	0.95	0.95	0.95
PURY-M300	1.00	0.93	0.82	0.80	0.82	0.86	0.90	0.90	0.95	0.95	0.95
PURY-M350	1.00	0.93	0.85	0.83	0.84	0.86	0.90	0.90	0.95	0.95	0.95
PURY-M400	1.00	0.93	0.85	0.83	0.84	0.86	0.90	0.90	0.95	0.95	0.95

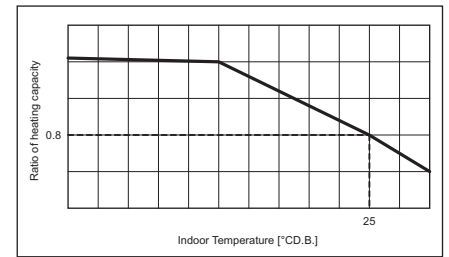

Fig.4 Indoor unit temperature correction
 To be used to correct indoor unit only

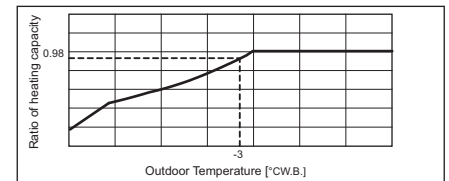

Fig.5 Outdoor unit temperature correction
 To be used to correct outdoor unit only

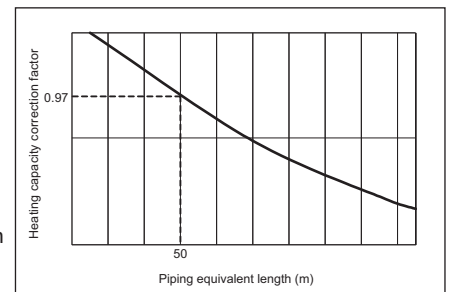

Fig.6 Correction of refrigerant piping length

3. Power input of outdoor unit

<Cooling>

(1) Rated power input of outdoor unit **5.19 kW****(2) Calculation of the average indoor temperature power input coefficient**

Coefficient of the outdoor unit for indoor unit 1 (Outdoor temp. 37 °CD.B., Indoor temp. 20 °CW.B.)

1.07

Coefficient of the outdoor unit for indoor unit 2 (Outdoor temp. 37 °CD.B., Indoor temp. 18 °CW.B.)

1.00

$$\text{Average indoor temp. power input coefficient } (C_{ave}) = \sum_{k=1}^n \{c_k \times (M_k / \sum_{k=1}^n M_k)\}$$

n: Total number of the indoor units

k: Number of the indoor unit

c_k: Outdoor unit power input coefficient of k indoor unit room temp.M_k: Number part of the k indoor unit model (e.g. M80 → 80)

$$= 1.07 \times 100 / (100 + 100) + 1 \times 100 / (100 + 100)$$

$$= 1.04$$

(3) No need to consider Coefficient of the partial load $f(CTi/CTo)$ -**(4) Outdoor power input (P_{lo})**Maximum System Capacity (CT_x) = Total Outdoor unit Capacity (CT_o), so use the following formulaP_{lo} = Outdoor unit Cooling Rated Power Input × Correction Coefficient of Indoor temperature

$$= 5.19 \times 1.04$$

$$= 5.4 \text{ kW}$$

<Heating>

(1) Rated power input of outdoor unit **5.73 kW****(2) Calculation of the average indoor temperature power input coefficient**Coefficient of the outdoor unit for indoor unit 1 (Outdoor temp. -3 °CW.B., Indoor temp. 25 °CD.B.)
1.08Coefficient of the outdoor unit for indoor unit 2 (Outdoor temp. -3 °CW.B., Indoor temp. 25 °CD.B.)
1.08

$$\text{Average indoor temp. power input coefficient } (C_{ave}) = \sum_{k=1}^n \{c_k \times (M_k / \sum_{k=1}^n M_k)\}$$

n: Total number of the indoor units

k: Number of the indoor unit

c_k: Outdoor unit power input coefficient of k indoor unit room temp.M_k: Number part of the k indoor unit model (e.g. M80 → 80)

$$= 1.08 \times 100 / (100 + 100) + 1.08 \times 100 / (100 + 100)$$

$$= 1.08$$

(3) Coefficient of the partial load f (CTi/CTo) **0.91****(4) Outdoor power input (P_{lo})**Maximum System Capacity (CT_x) = Total Indoor unit Capacity (CT_i), so use the following formula

$$P_{lo} = \text{Outdoor unit Heating Rated Power Input} \times \text{Correction Coefficient of Indoor temperature} \times f(\text{CT}_i/\text{CT}_o)$$

$$= 5.73 \times 1.08 \times 0.91$$

$$= 5.65 \text{ kW}$$

PURY-M-Y(S)XM-A

8-2. Correction by temperature

CITY MULTI could have various capacities at different designing temperatures. Using the nominal cooling/heating capacity values and the ratios below, the capacity can be observed at various temperatures.

PURY-		M200YXM-A
Cooling Capacity	kW	22.4
	BTU/h	76,400
Input	kW	5.53

Indoor unit temperature correction

To be used to correct indoor unit capacity only

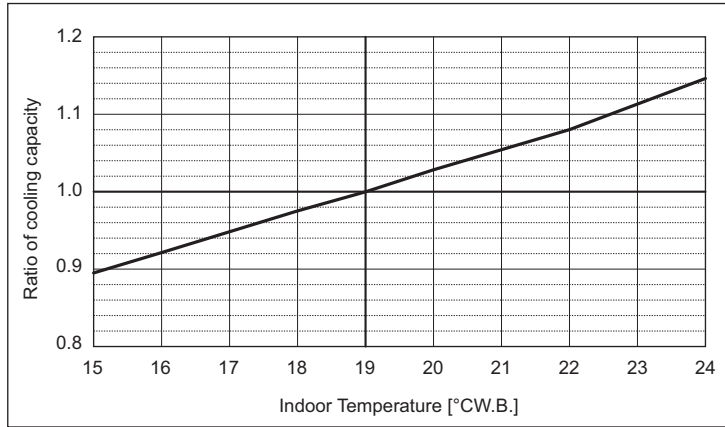

Outdoor unit temperature correction

To be used to correct outdoor unit only

Outdoor unit capacity is NOT affected by the indoor temperature.

Outdoor unit power input is affected by the indoor and outdoor temperatures. Please consult the sales office for details.

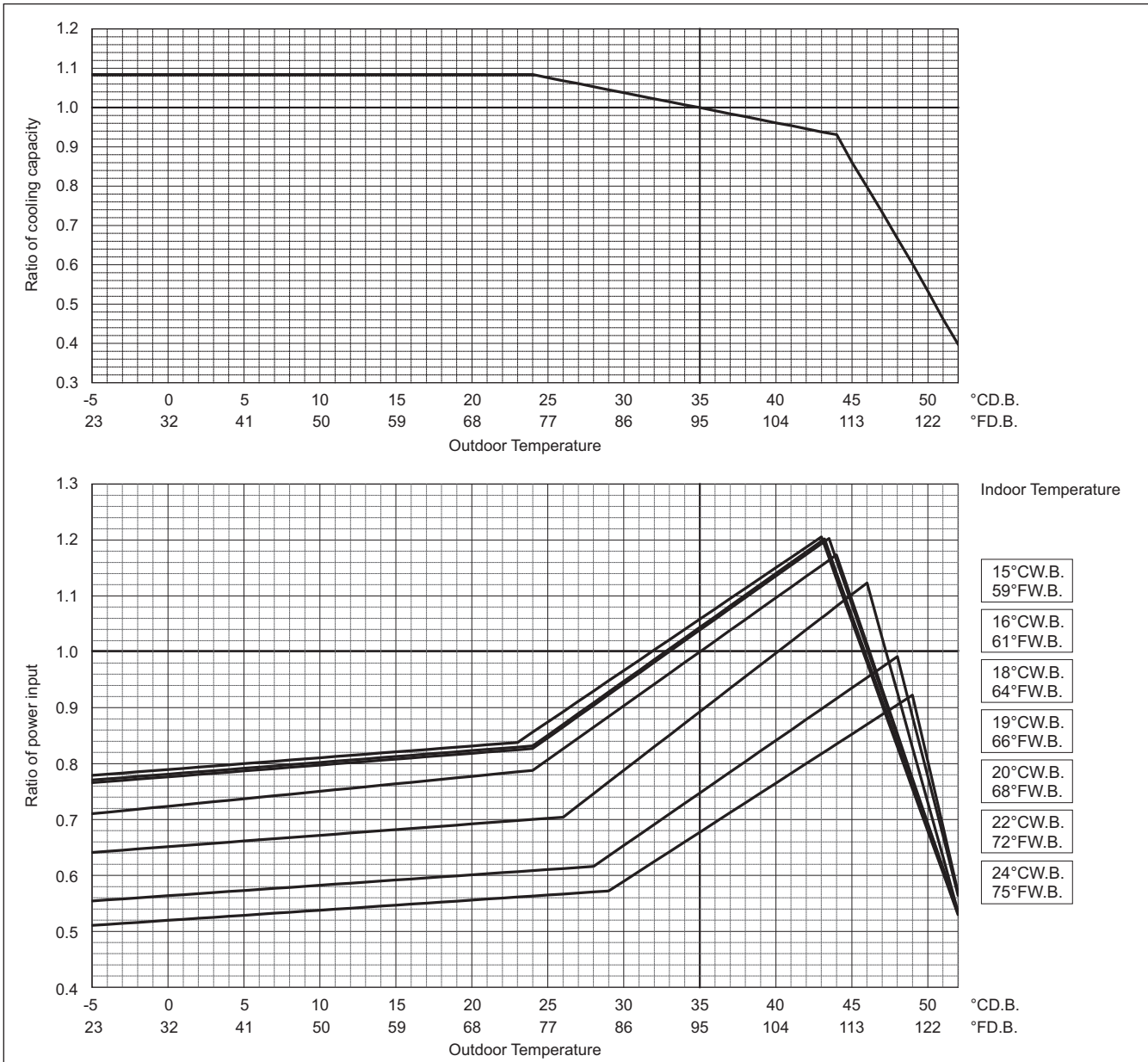

	PURY-	M200YXM-A
Heating Capacity	kW	25.0
	BTU/h	85,300
Input	kW	5.65

Indoor unit temperature correction

To be used to correct indoor unit capacity only

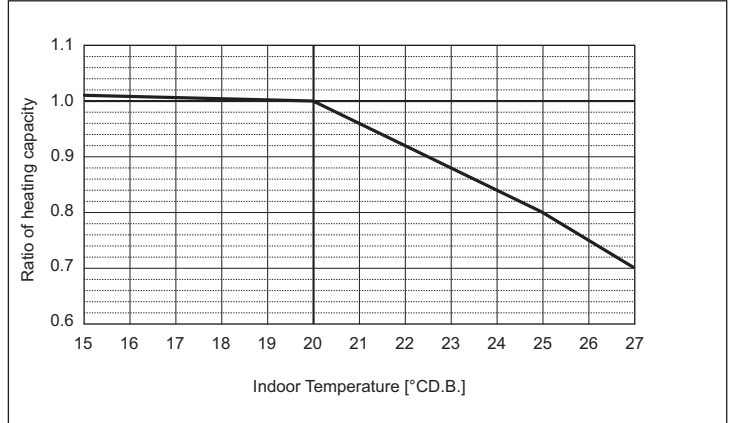

Outdoor unit temperature correction

To be used to correct outdoor unit only

Outdoor unit capacity is NOT affected by the indoor temperature.

Outdoor unit power input is affected by the indoor and outdoor temperatures. Please consult the sales office for details.

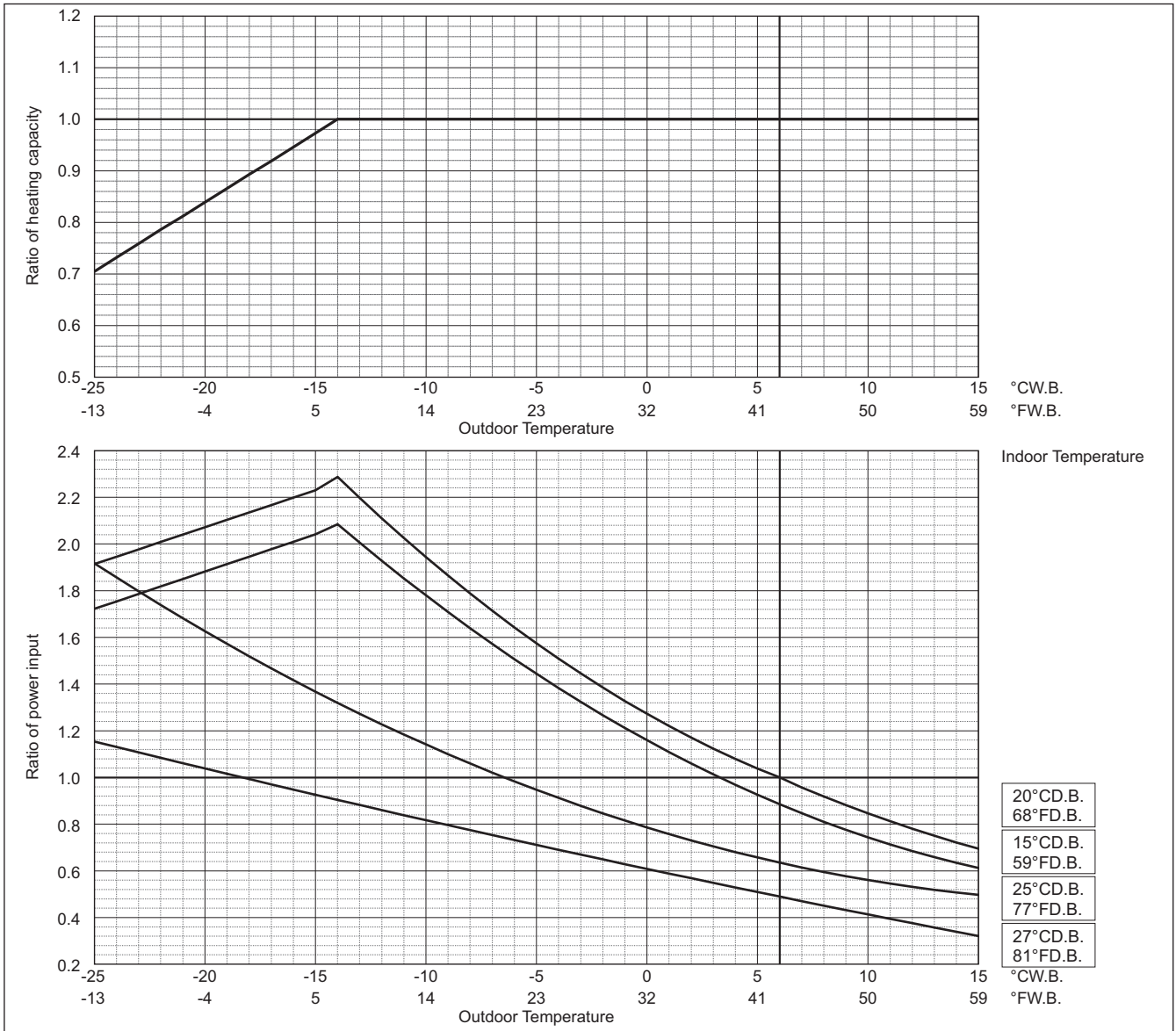

PURY-M-Y(S)XM-A

PURY-		M250YXM-A
Cooling Capacity	kW	28.0
	BTU/h	95,500
Input	kW	7.79

Indoor unit temperature correction
To be used to correct indoor unit capacity only

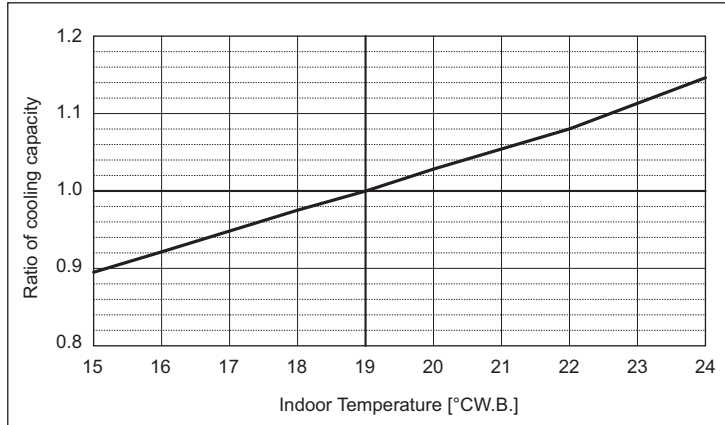

Outdoor unit temperature correction

To be used to correct outdoor unit only

Outdoor unit capacity is NOT affected by the indoor temperature.

Outdoor unit power input is affected by the indoor and outdoor temperatures. Please consult the sales office for details.

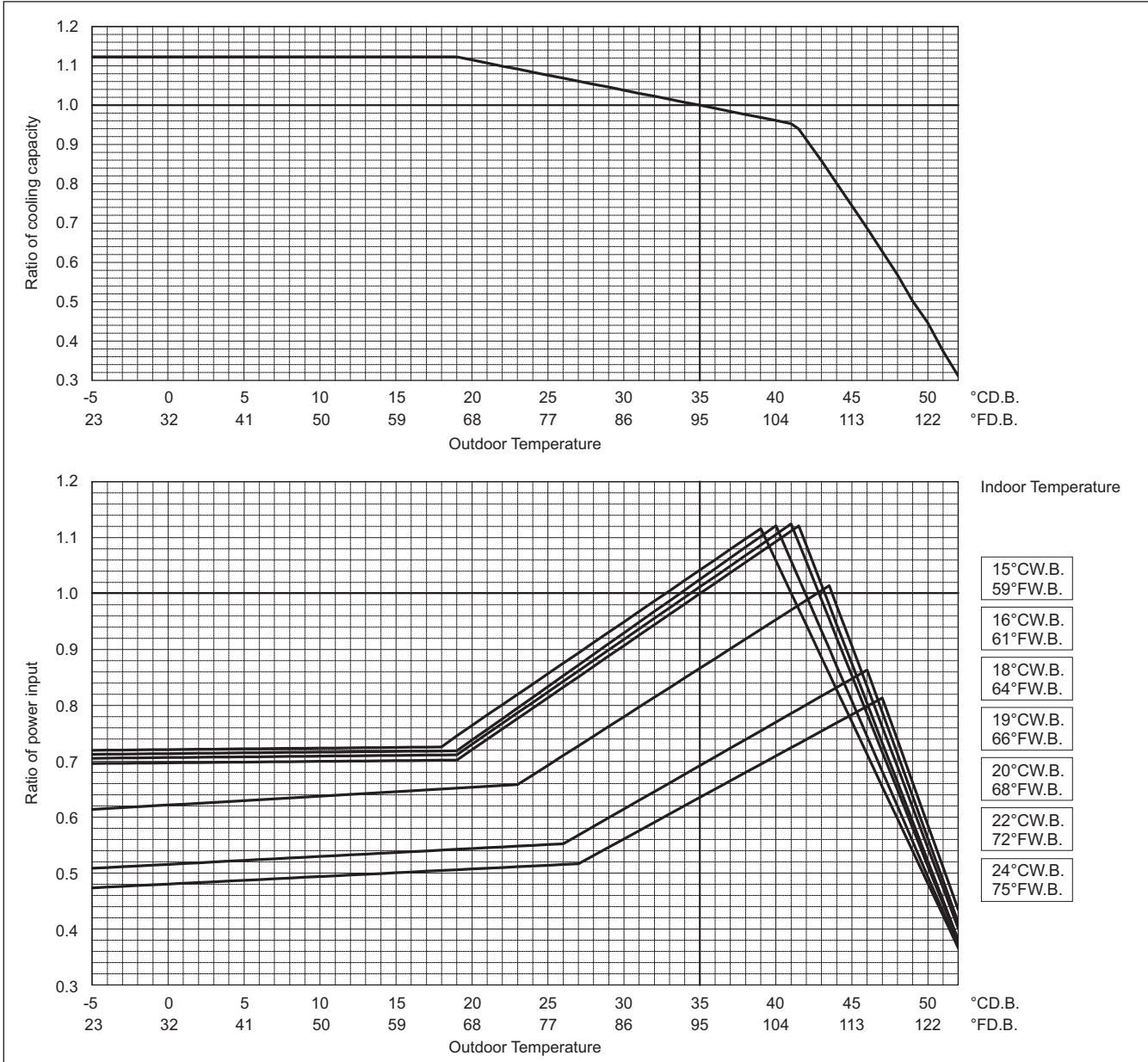

PURY-M-Y(S)XM-A

	PURY-	M250YXM-A
Heating Capacity	kW	31.5
	BTU/h	107,500
Input	kW	7.79

Indoor unit temperature correction

To be used to correct indoor unit capacity only

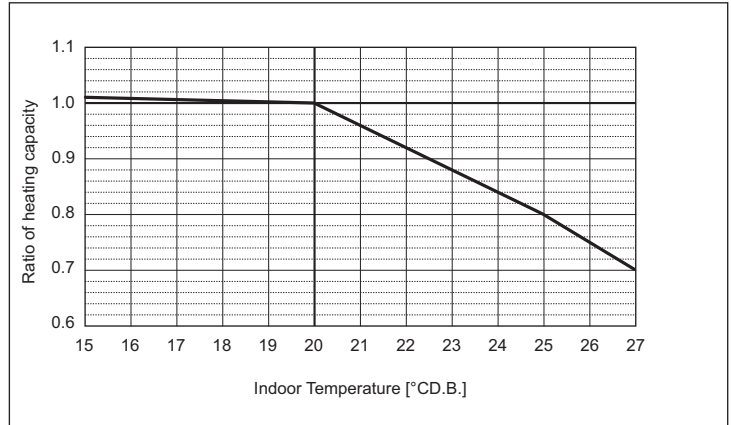

Outdoor unit temperature correction

To be used to correct outdoor unit only

Outdoor unit capacity is NOT affected by the indoor temperature.

Outdoor unit power input is affected by the indoor and outdoor temperatures. Please consult the sales office for details.

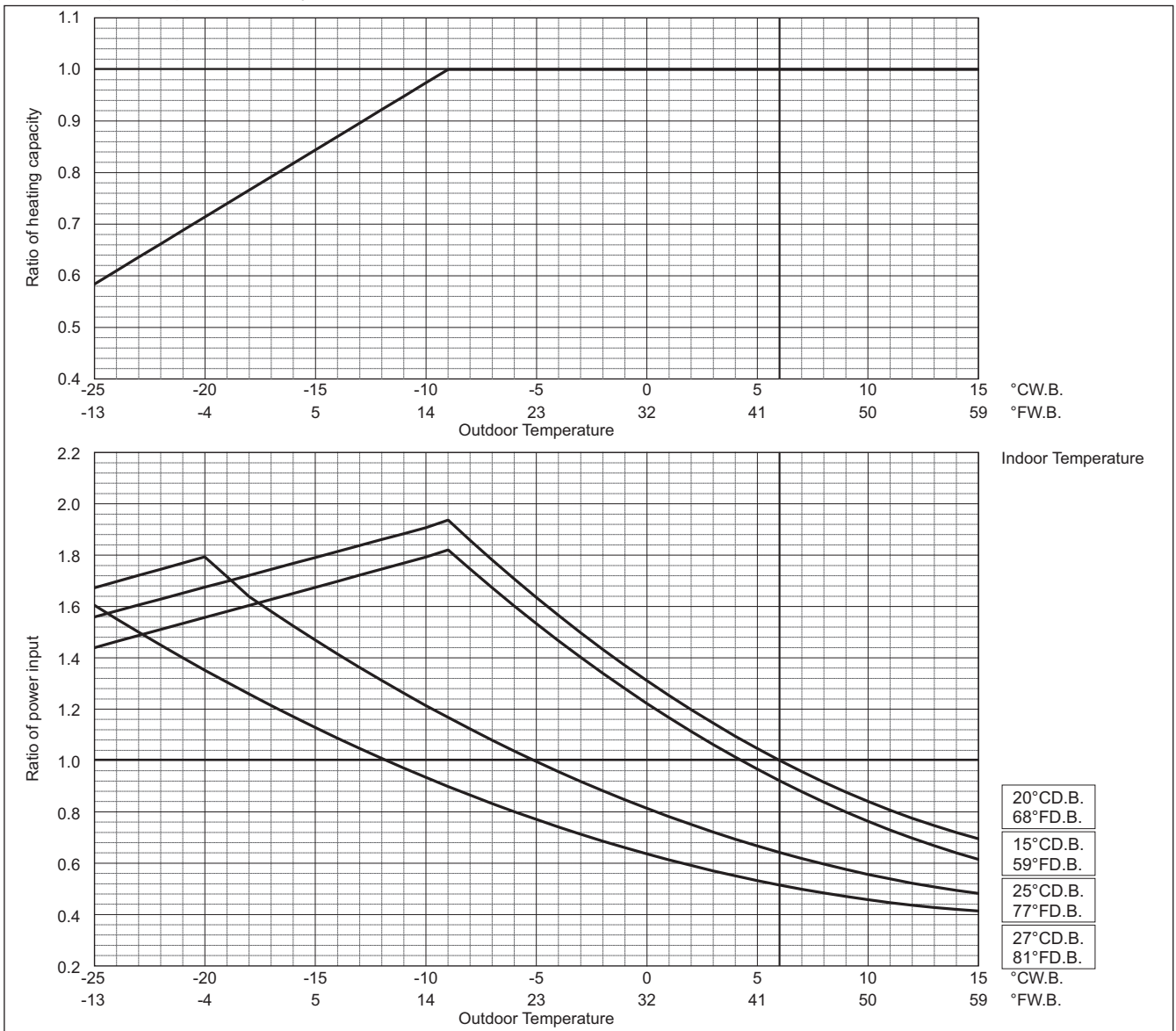

PURY-		M300YXM-A
Cooling Capacity	kW	33.5
	BTU/h	114,300
Input	kW	9.43

Indoor unit temperature correction
To be used to correct indoor unit capacity only

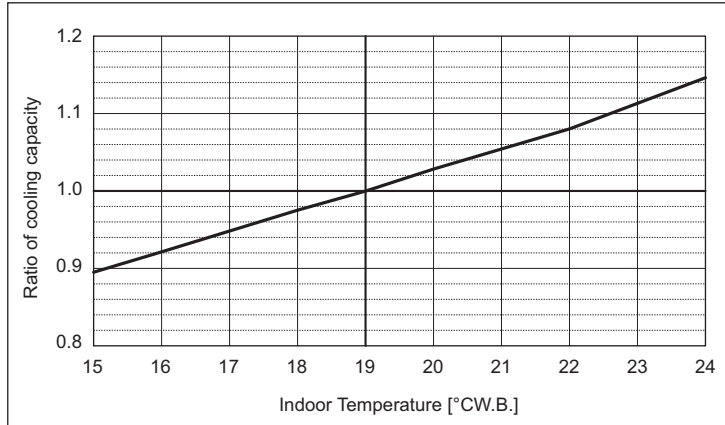

Outdoor unit temperature correction

To be used to correct outdoor unit only

Outdoor unit capacity is NOT affected by the indoor temperature.

Outdoor unit power input is affected by the indoor and outdoor temperatures. Please consult the sales office for details.

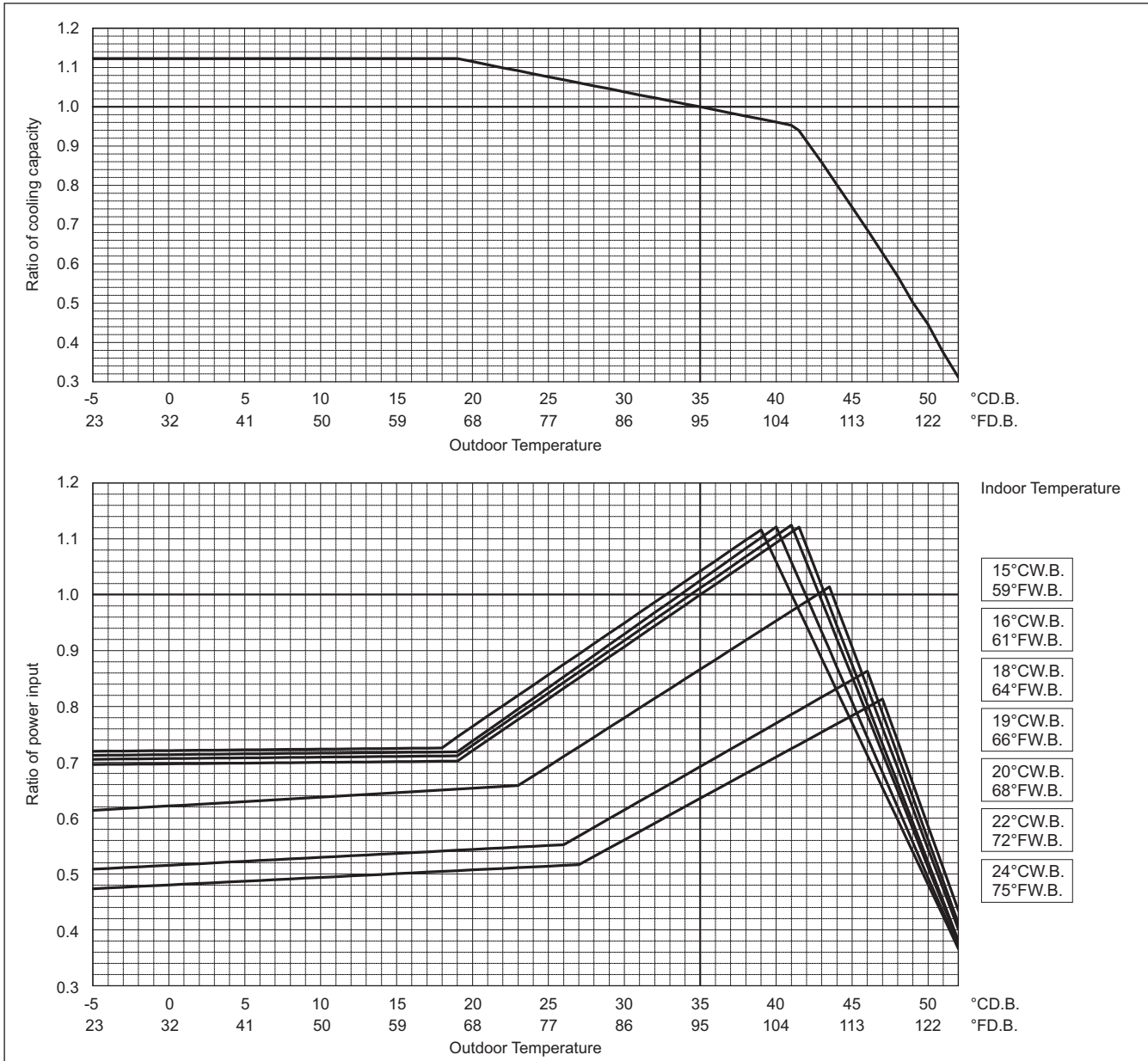

PURY-M-Y(S)XM-A

	PURY-	M300YXM-A
Heating Capacity	kW	37.5
	BTU/h	128,000
Input	kW	9.61

Indoor unit temperature correction

To be used to correct indoor unit capacity only

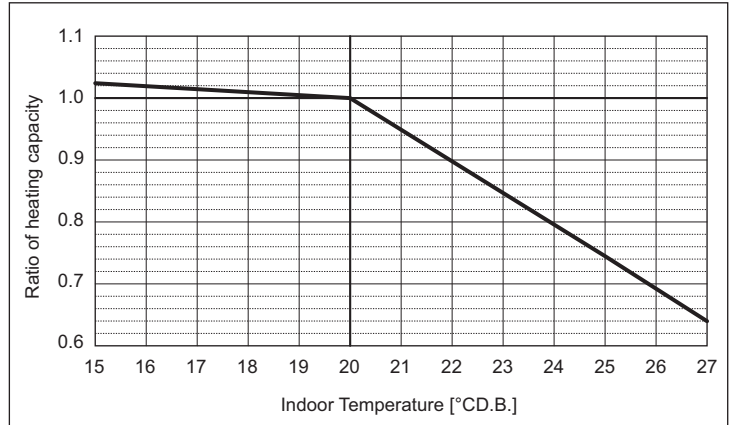

Outdoor unit temperature correction

To be used to correct outdoor unit only

Outdoor unit capacity is NOT affected by the indoor temperature.

Outdoor unit power input is affected by the indoor and outdoor temperatures. Please consult the sales office for details.

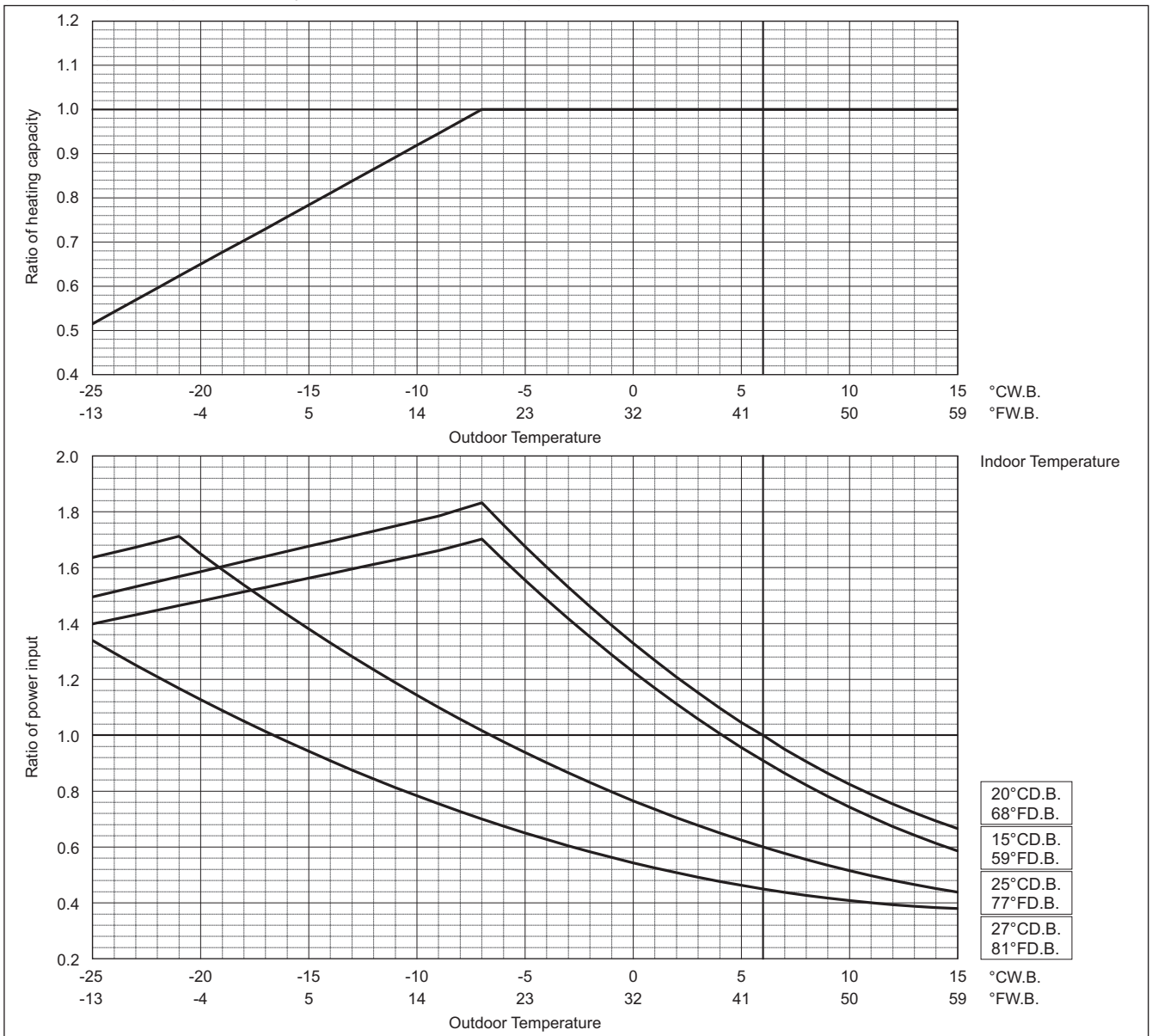

PURY-		M350YXM-A
Cooling Capacity	kW	40.0
	BTU/h	136,500
Input	kW	11.62

Indoor unit temperature correction
To be used to correct indoor unit capacity only

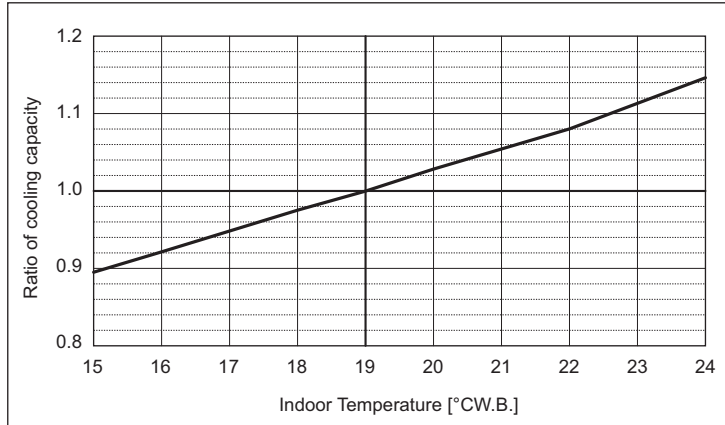

Outdoor unit temperature correction

To be used to correct outdoor unit only

Outdoor unit capacity is NOT affected by the indoor temperature.

Outdoor unit power input is affected by the indoor and outdoor temperatures. Please consult the sales office for details.

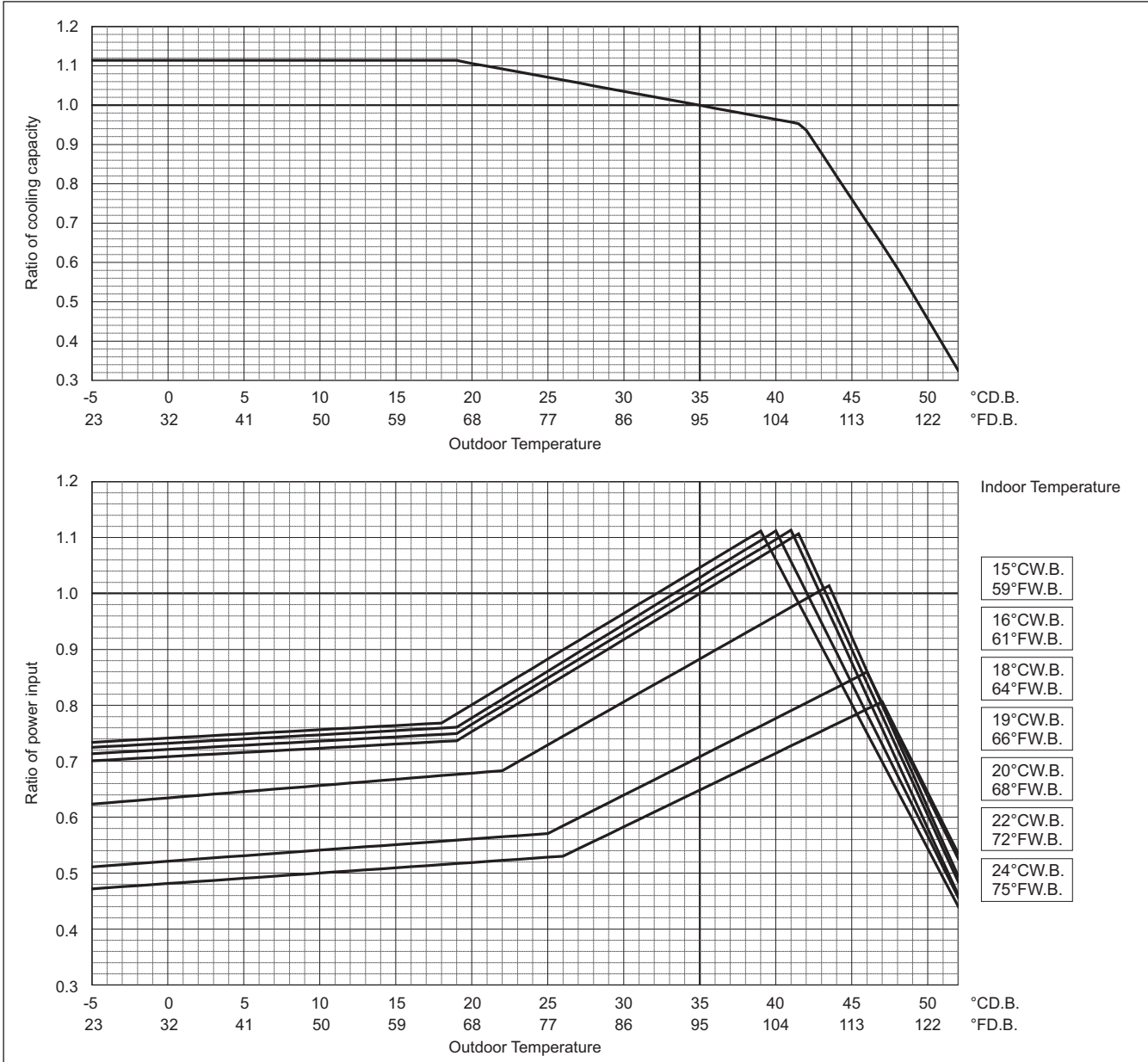

PURY-M-Y(S)XM-A

	PURY-	M350YXM-A
Heating Capacity	kW	45.0
	BTU/h	153,500
Input	kW	12.64

Indoor unit temperature correction

To be used to correct indoor unit capacity only

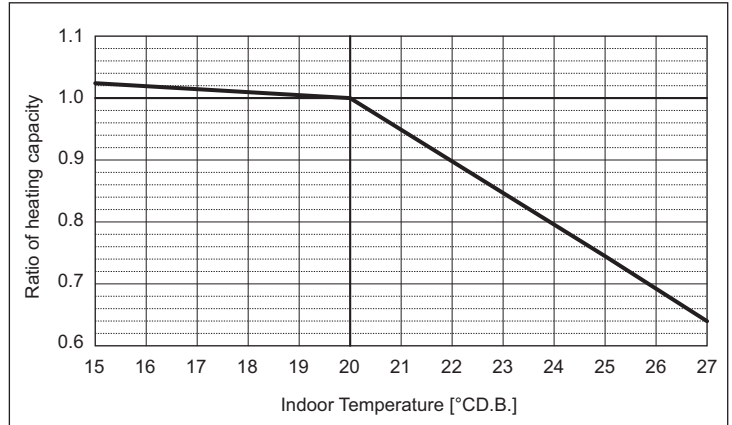

Outdoor unit temperature correction

To be used to correct outdoor unit only

Outdoor unit capacity is NOT affected by the indoor temperature.

Outdoor unit power input is affected by the indoor and outdoor temperatures. Please consult the sales office for details.

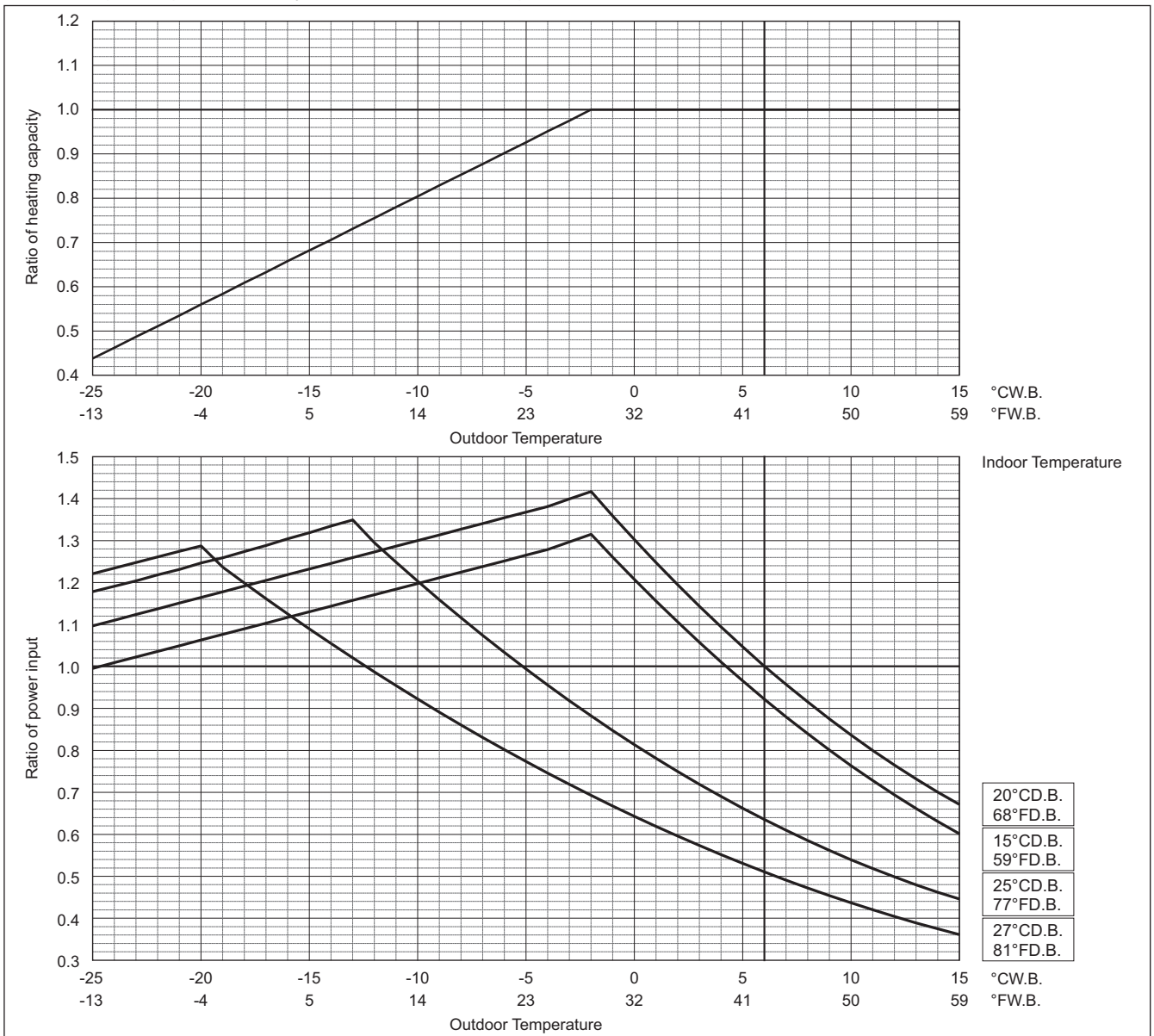

PURY-		M400YXM-A
Cooling Capacity	kW	45.0
	BTU/h	153,500
Input	kW	13.39

Indoor unit temperature correction
To be used to correct indoor unit capacity only

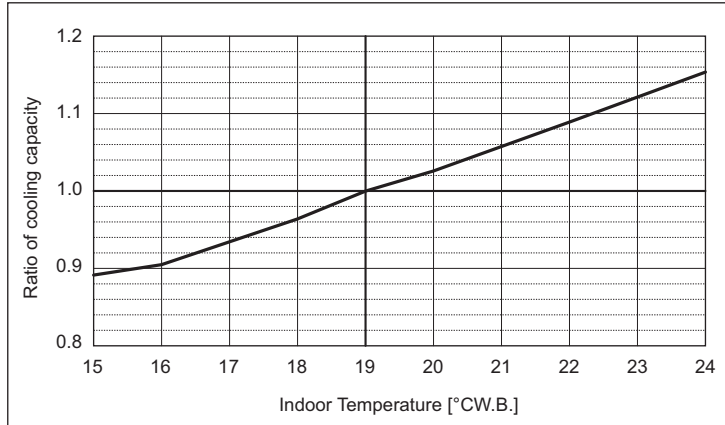

Outdoor unit temperature correction

To be used to correct outdoor unit only

Outdoor unit capacity is NOT affected by the indoor temperature.

Outdoor unit power input is affected by the indoor and outdoor temperatures. Please consult the sales office for details.

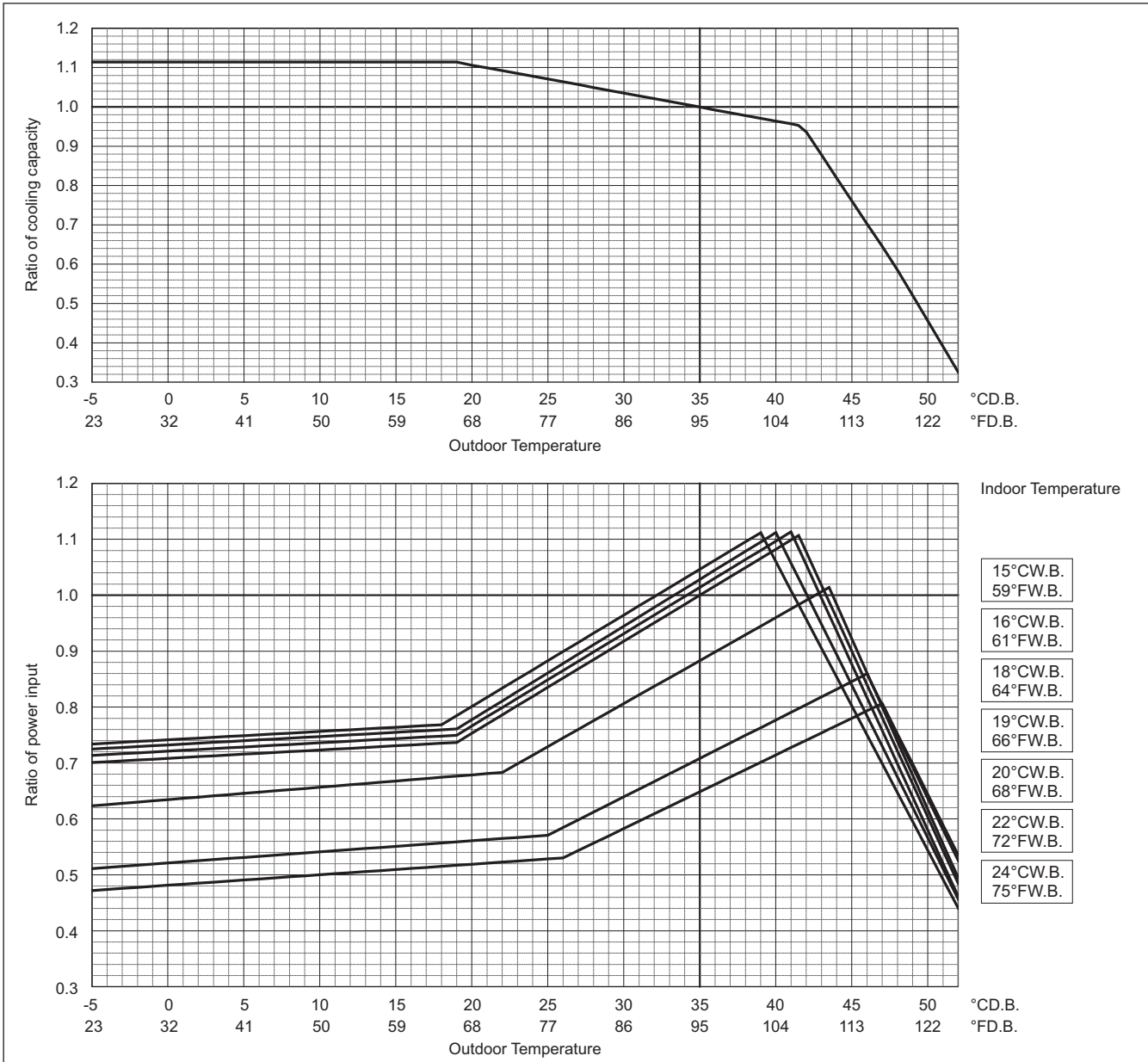

PURY-M-Y(S)XM-A

	PURY-	M400YXM-A
Heating Capacity	kW	50.0
	BTU/h	170,600
Input	kW	14.04

Indoor unit temperature correction

To be used to correct indoor unit capacity only

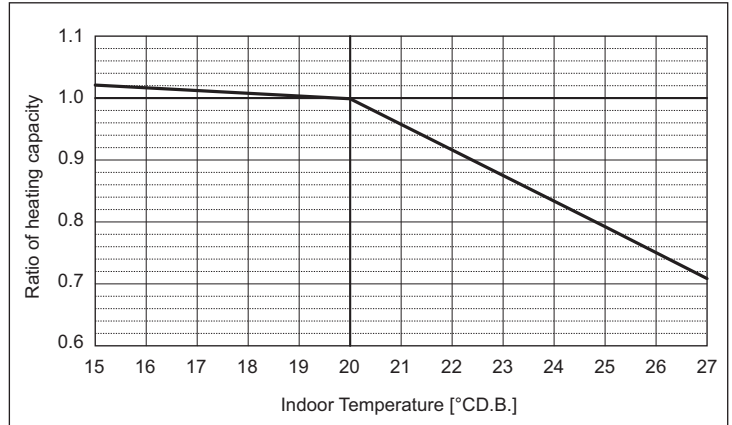

Outdoor unit temperature correction

To be used to correct outdoor unit only

Outdoor unit capacity is NOT affected by the indoor temperature.

Outdoor unit power input is affected by the indoor and outdoor temperatures. Please consult the sales office for details.

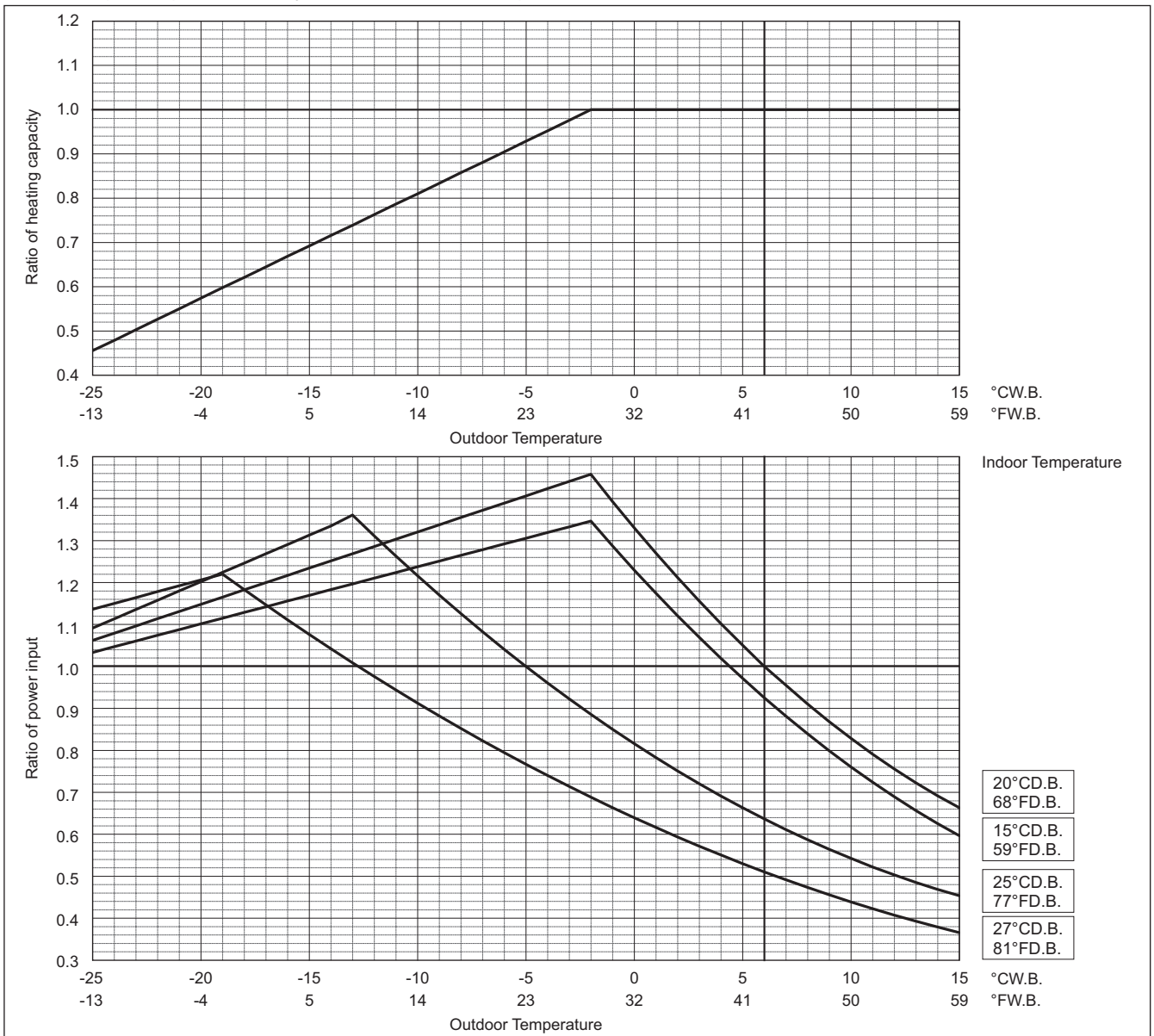

PURY-		M450YXM-A
Cooling Capacity	kW	50.0
	BTU/h	170,600
Input	kW	15.47

Indoor unit temperature correction
To be used to correct indoor unit capacity only

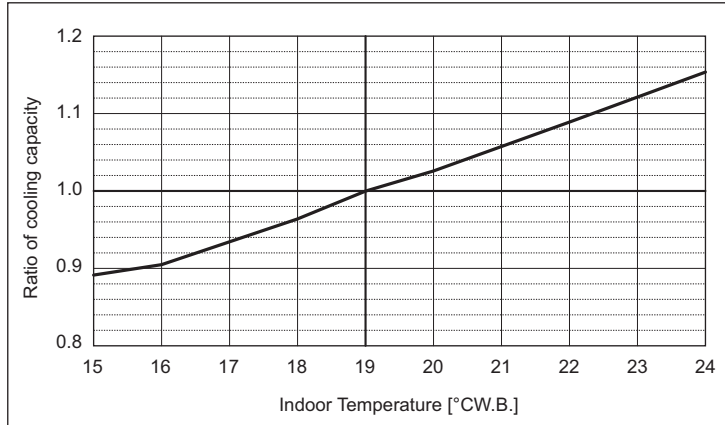

Outdoor unit temperature correction

To be used to correct outdoor unit only

Outdoor unit capacity is NOT affected by the indoor temperature.

Outdoor unit power input is affected by the indoor and outdoor temperatures. Please consult the sales office for details.

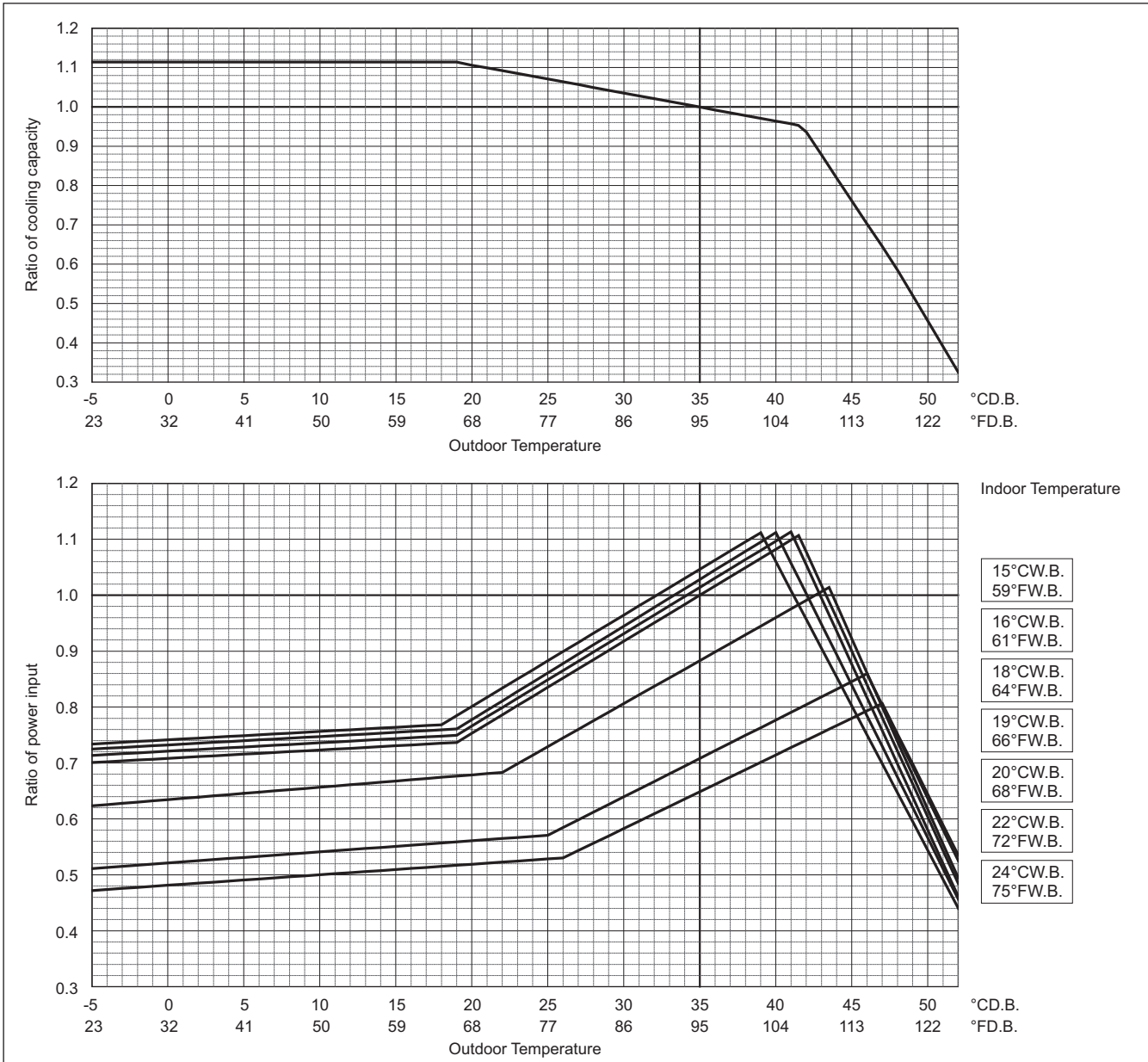

PURY-M-Y(S)XM-A

	PURY-	M450YXM-A
Heating Capacity	kW	56.0
Capacity	BTU/h	191,100
Input	kW	16.66

Indoor unit temperature correction

To be used to correct indoor unit capacity only

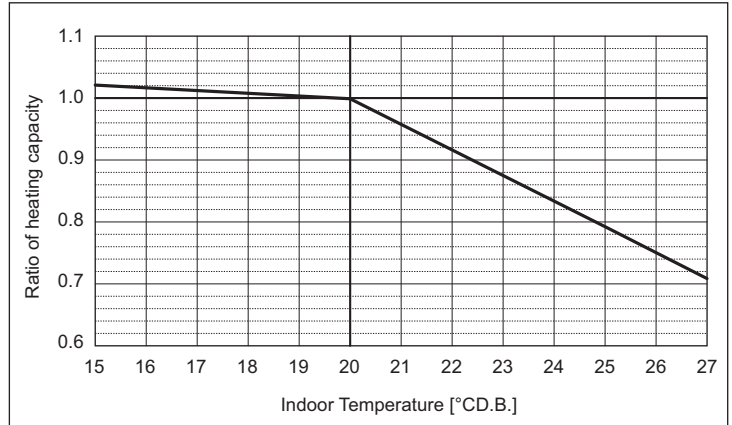

Outdoor unit temperature correction

To be used to correct outdoor unit only

Outdoor unit capacity is NOT affected by the indoor temperature.

Outdoor unit power input is affected by the indoor and outdoor temperatures. Please consult the sales office for details.

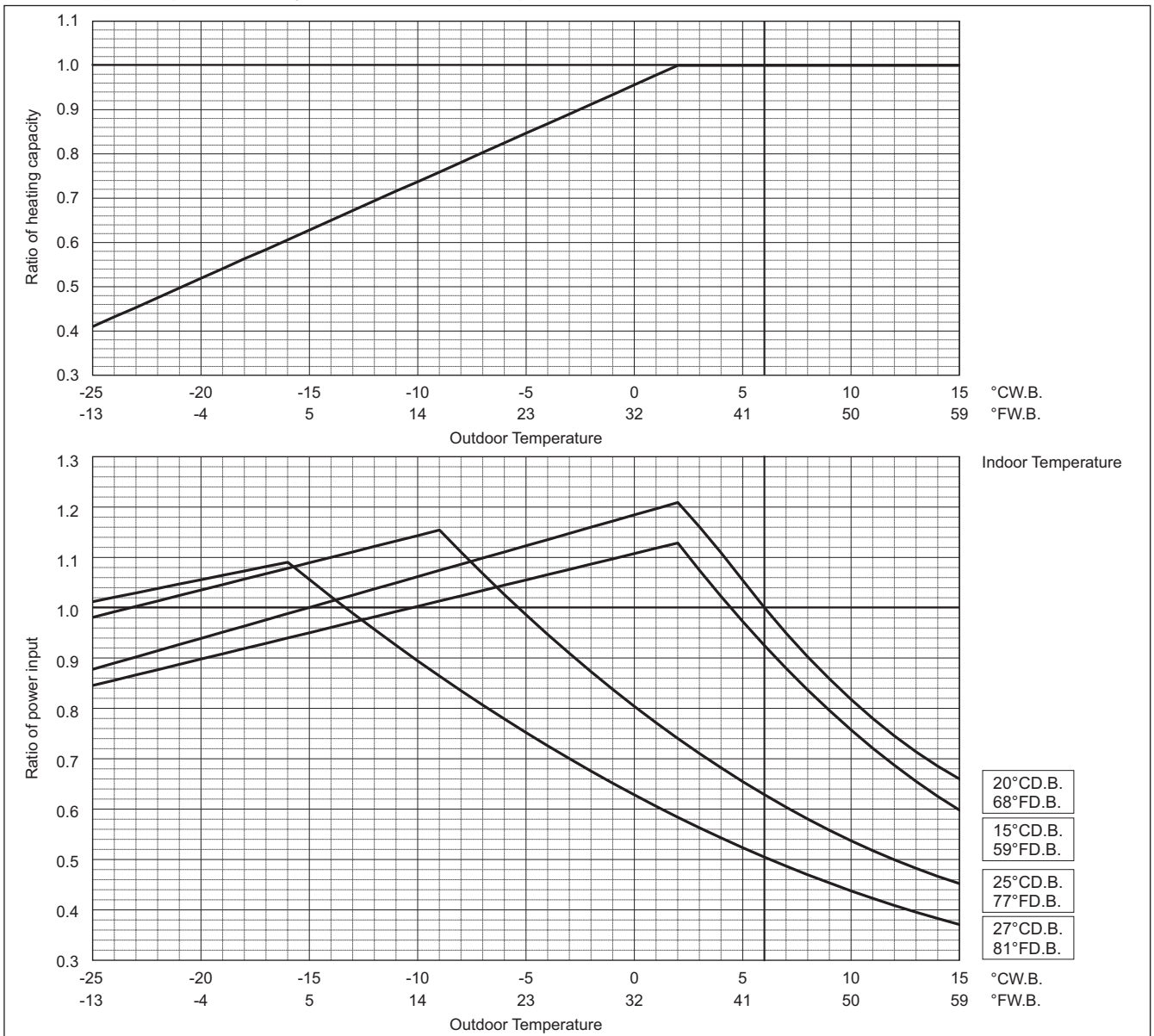

PURY-		M500YXM-A
Cooling Capacity	kW	56.0
	BTU/h	191,100
Input	kW	19.71

Indoor unit temperature correction
To be used to correct indoor unit capacity only

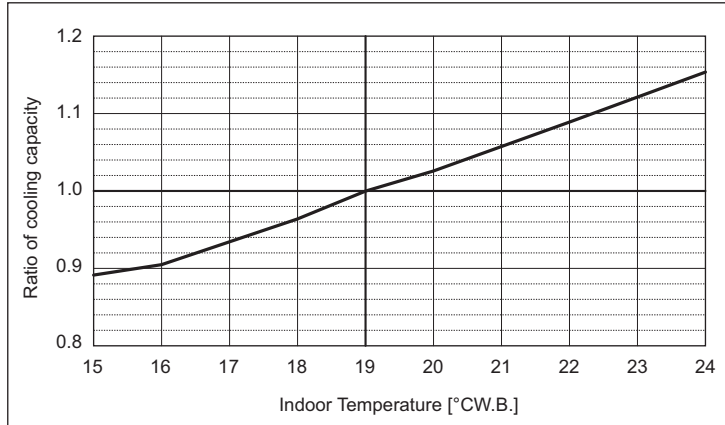

Outdoor unit temperature correction

To be used to correct outdoor unit only

Outdoor unit capacity is NOT affected by the indoor temperature.

Outdoor unit power input is affected by the indoor and outdoor temperatures. Please consult the sales office for details.

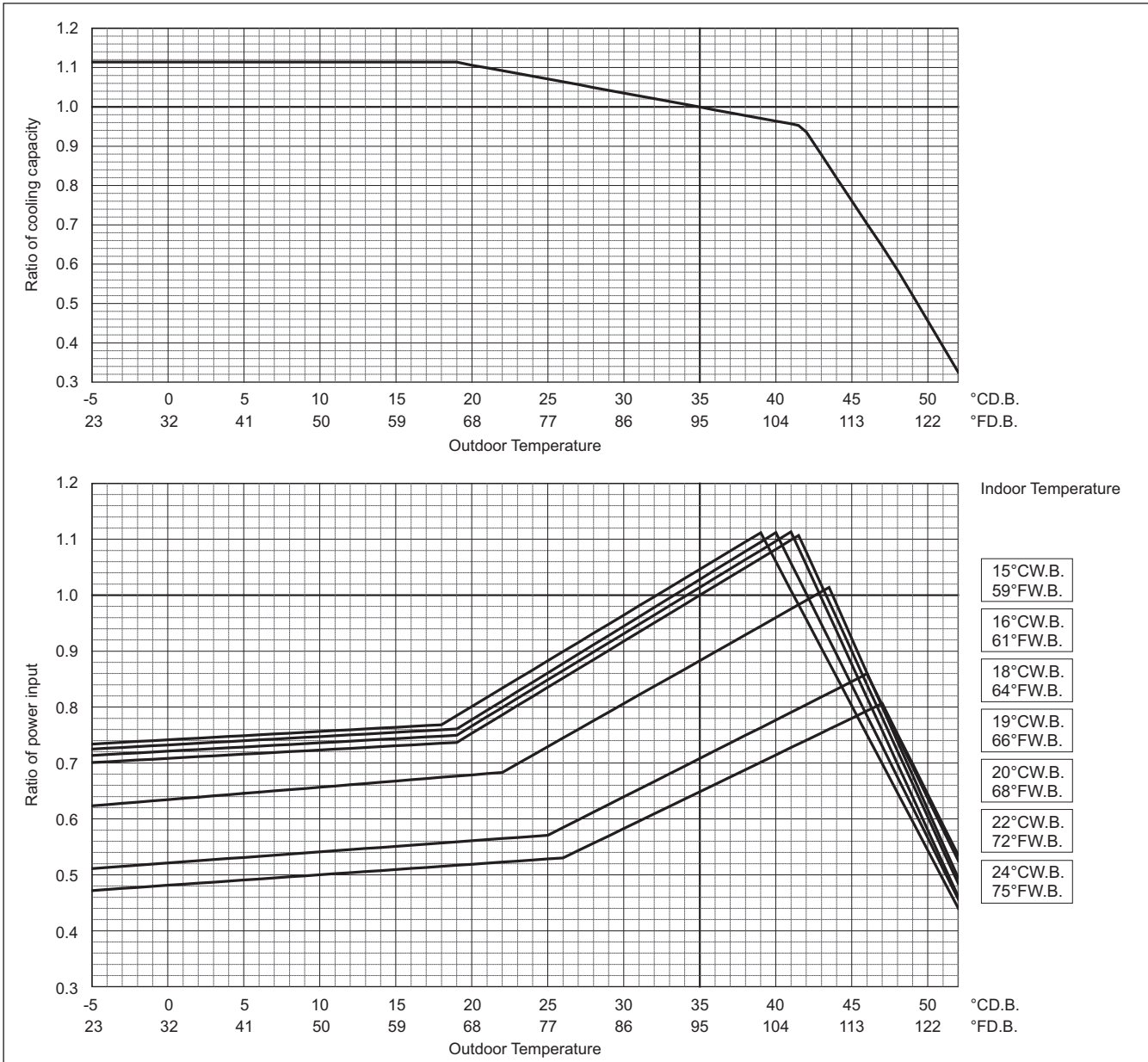

PURY-M-Y(S)XM-A

	PURY-	M500YXM-A
Heating Capacity	kW	58.0
Capacity	BTU/h	197,900
Input	kW	17.41

Indoor unit temperature correction

To be used to correct indoor unit capacity only

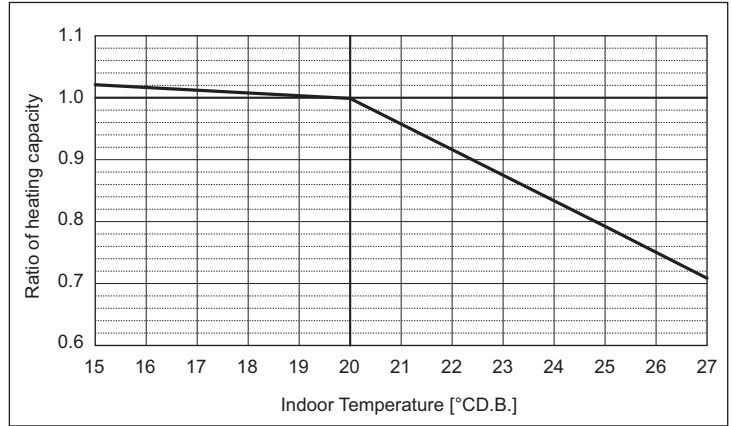

Outdoor unit temperature correction

To be used to correct outdoor unit only

Outdoor unit capacity is NOT affected by the indoor temperature.

Outdoor unit power input is affected by the indoor and outdoor temperatures. Please consult the sales office for details.

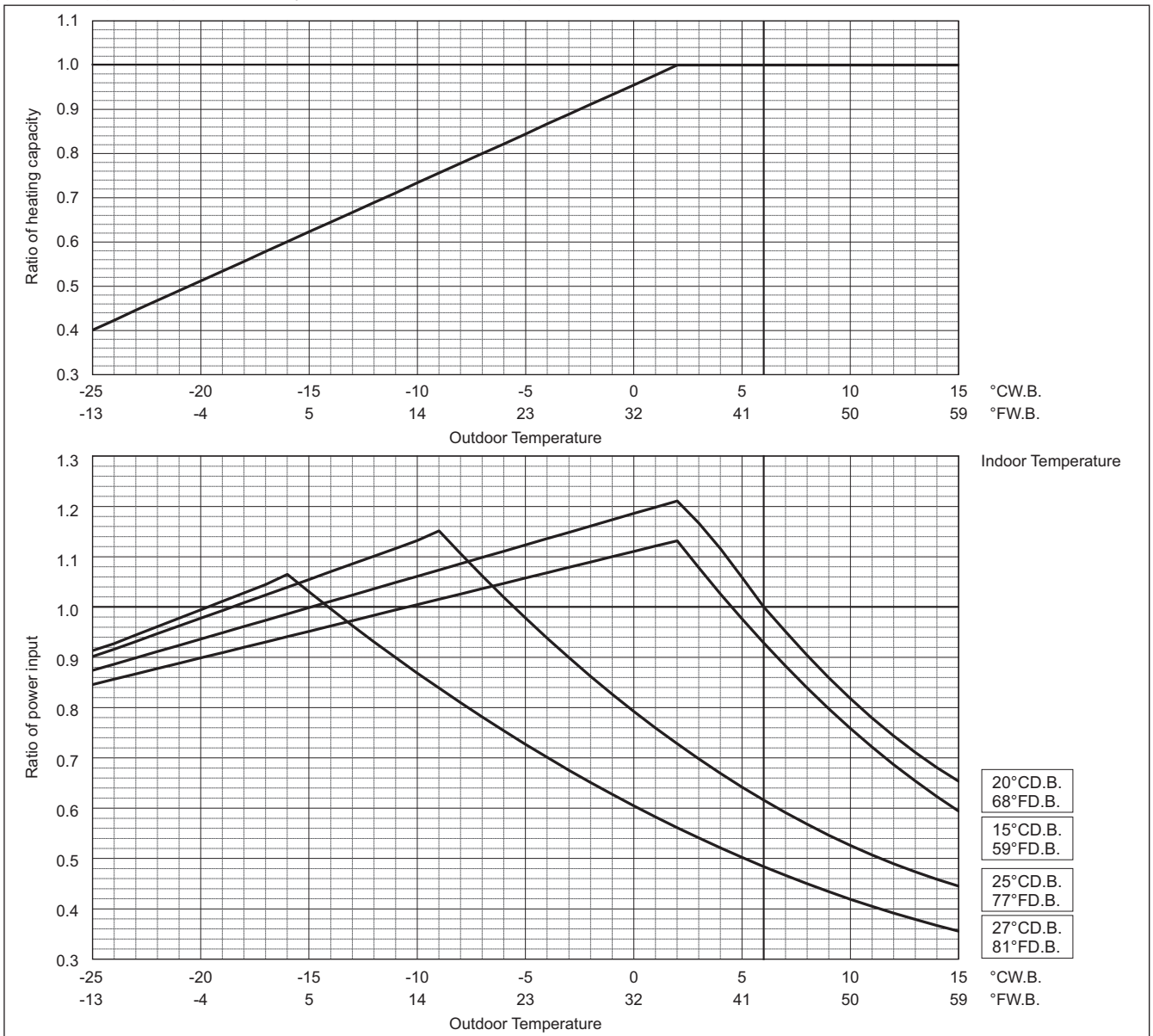

PURY-		M400YSXM-A
Cooling Capacity	kW	44.8
	BTU/h	152,900
Input	kW	11.17

Indoor unit temperature correction
To be used to correct indoor unit capacity only

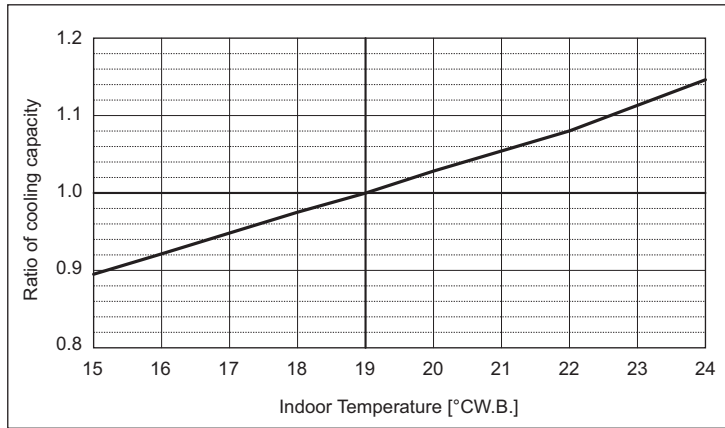

Outdoor unit temperature correction

To be used to correct outdoor unit only

Outdoor unit capacity is NOT affected by the indoor temperature.

Outdoor unit power input is affected by the indoor and outdoor temperatures. Please consult the sales office for details.

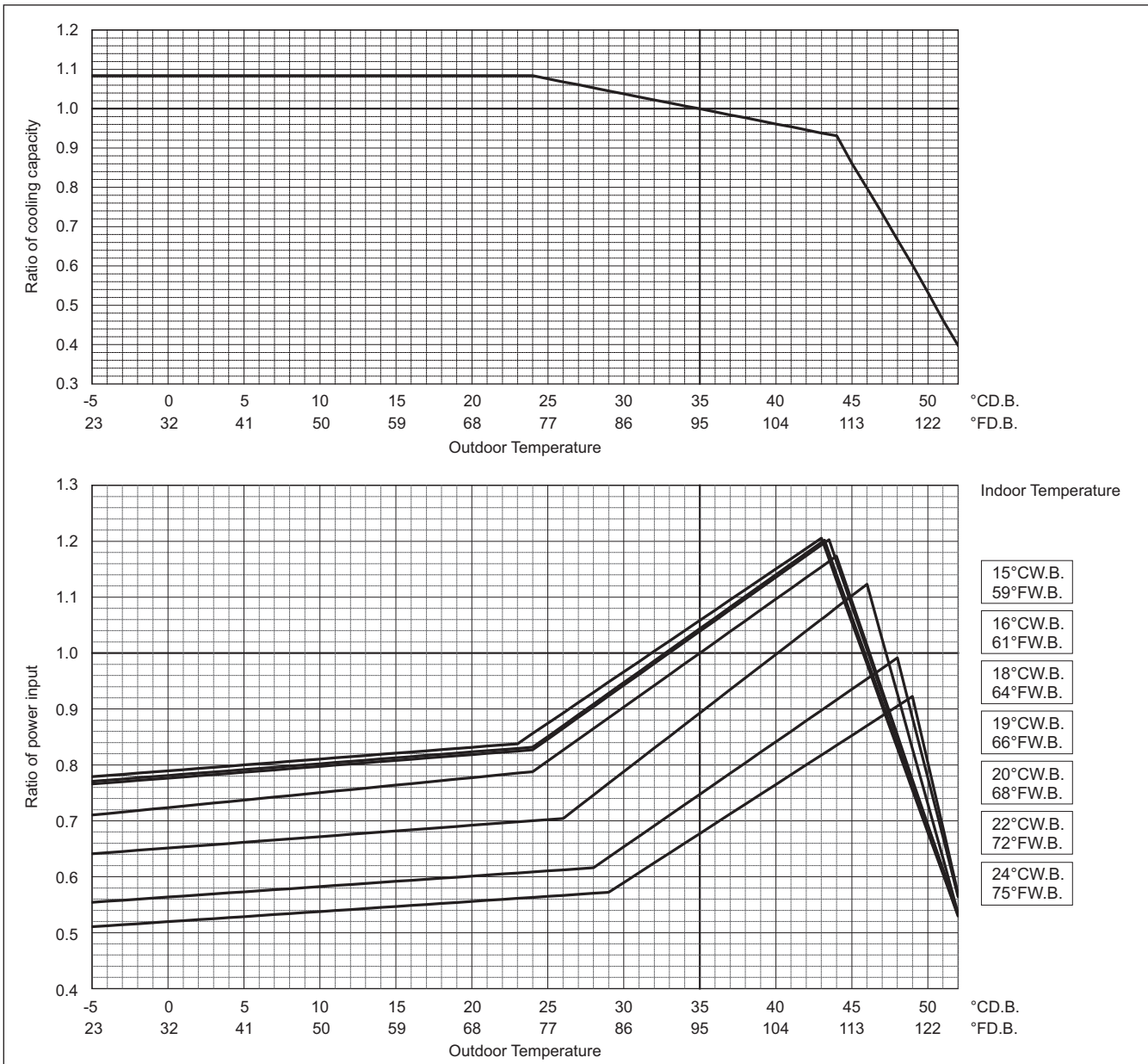

PURY-M-Y(S)XM-A

PURY-		M400YSXM-A
Heating Capacity	kW	50.0
	BTU/h	170,600
Input	kW	11.68

Indoor unit temperature correction

To be used to correct indoor unit capacity only

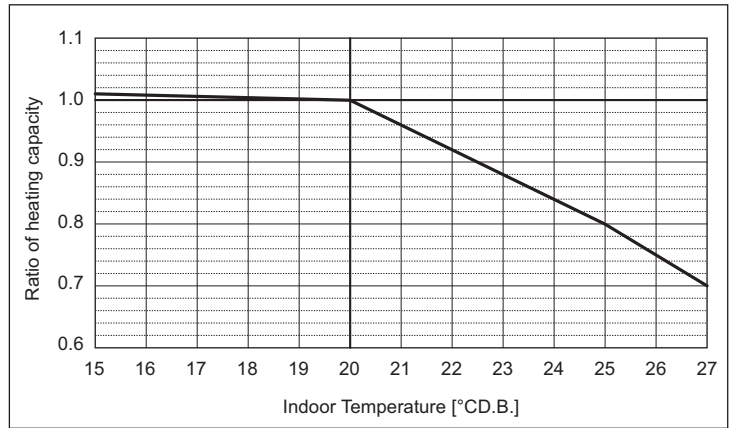

Outdoor unit temperature correction

To be used to correct outdoor unit only

Outdoor unit capacity is NOT affected by the indoor temperature.

Outdoor unit power input is affected by the indoor and outdoor temperatures. Please consult the sales office for details.

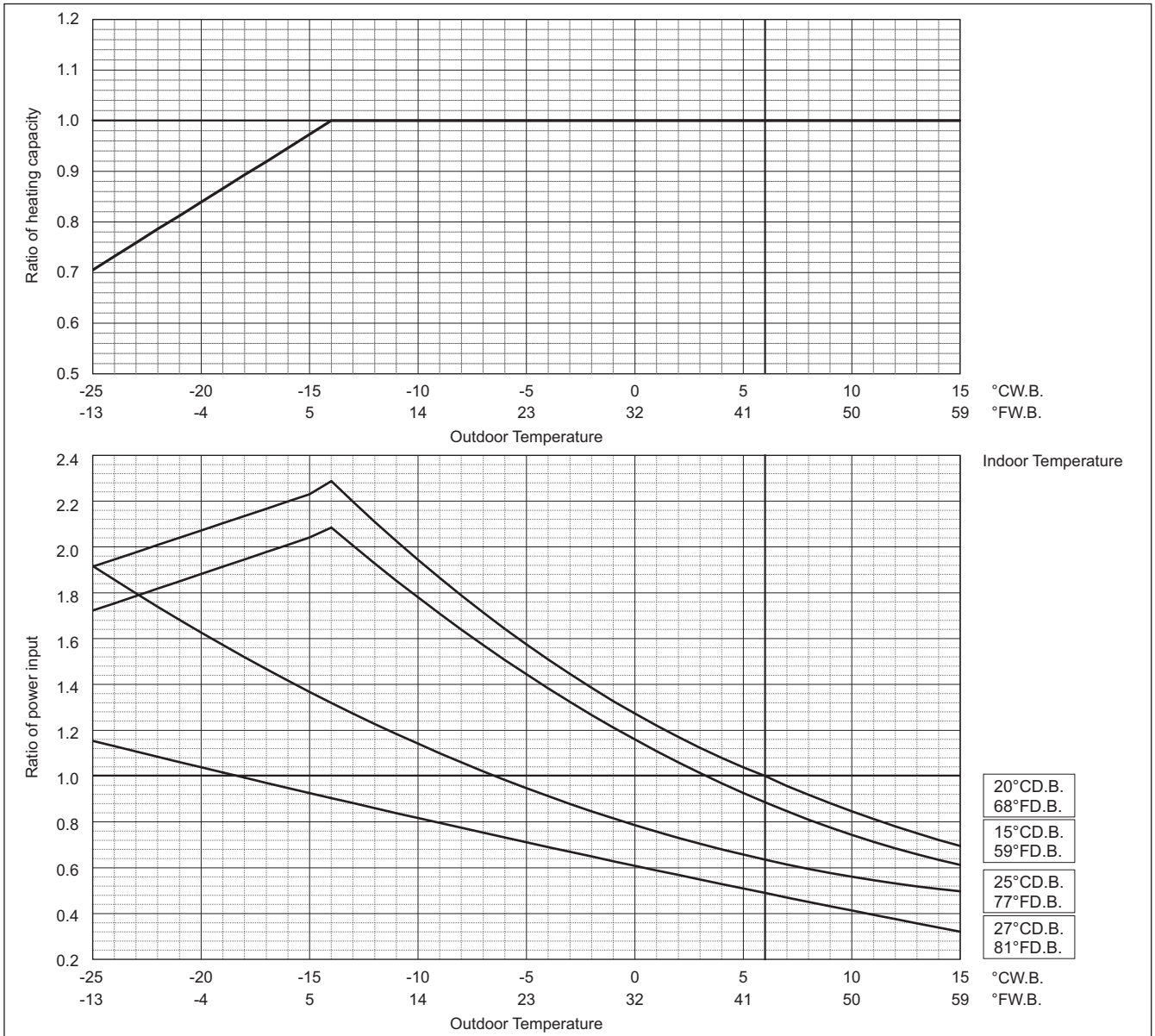

PURY-M-(S)XM-A

PURY-		M450YSXM-A
Cooling Capacity	kW	50.4
	BTU/h	172,000
Input	kW	13.44

Indoor unit temperature correction

To be used to correct indoor unit capacity only

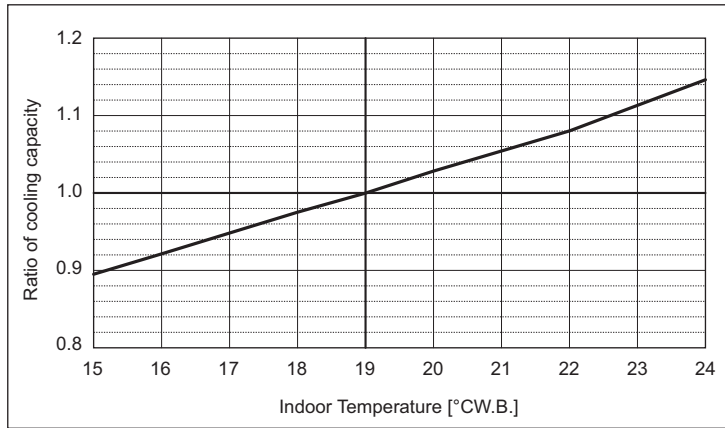

Outdoor unit temperature correction

To be used to correct outdoor unit only

Outdoor unit capacity is NOT affected by the indoor temperature.

Outdoor unit power input is affected by the indoor and outdoor temperatures. Please consult the sales office for details.

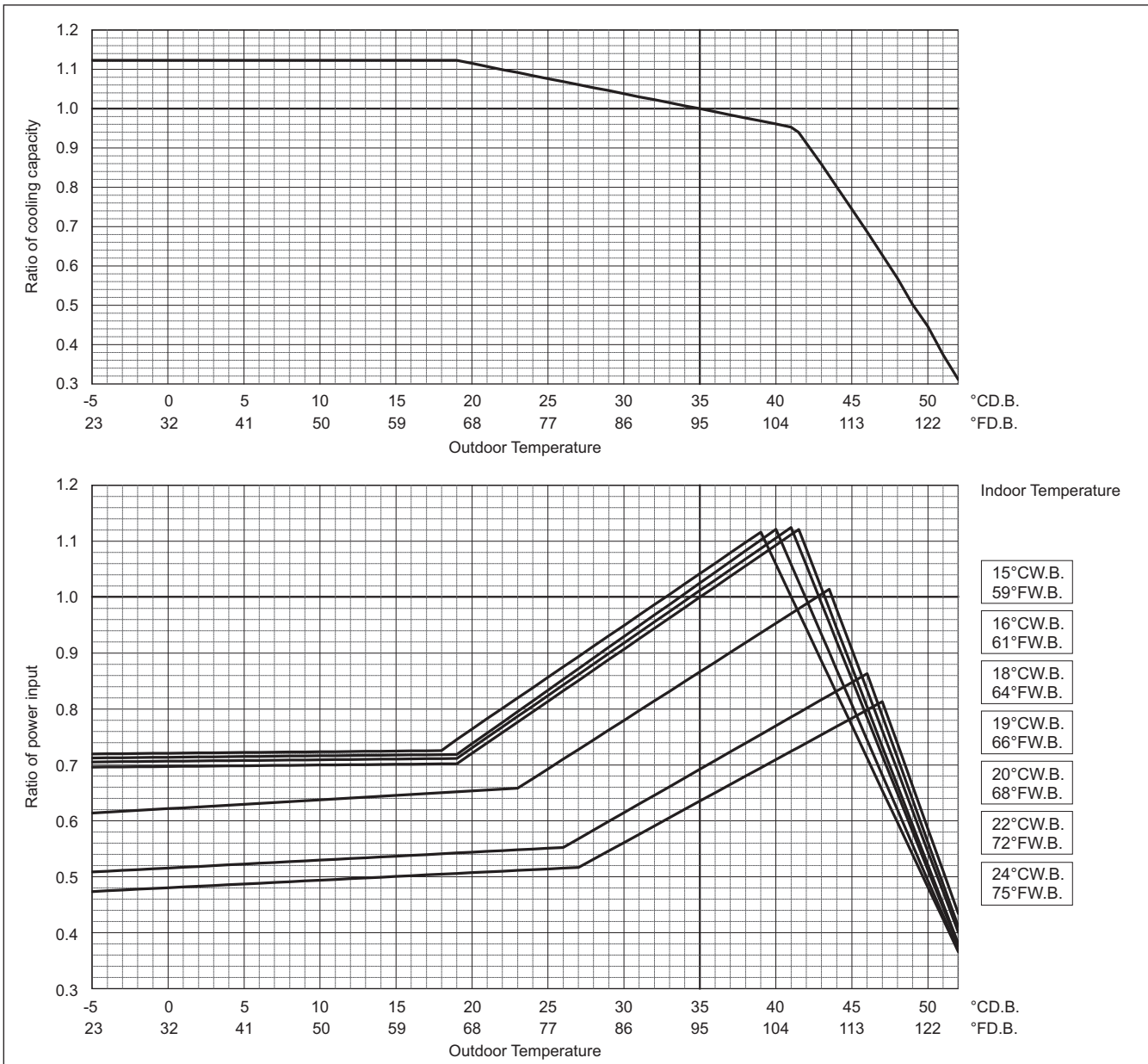

PURY-M-Y(S)XM-A

	PURY-	M450YSXM-A
Heating Capacity	kW	56.5
	BTU/h	192,800
Input	kW	13.78

Indoor unit temperature correction

To be used to correct indoor unit capacity only

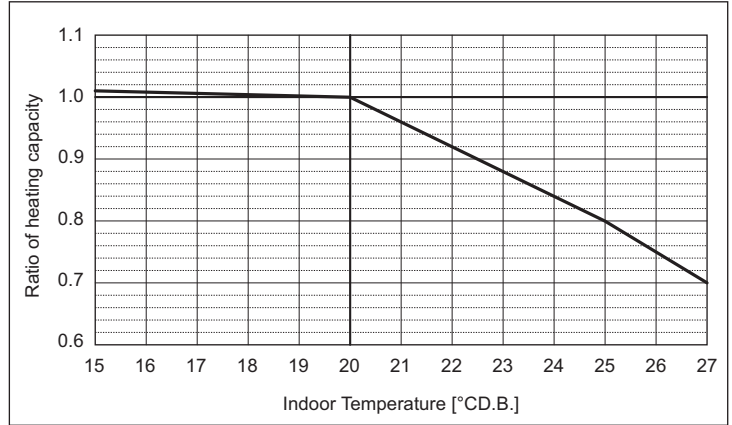

Outdoor unit temperature correction

To be used to correct outdoor unit only

Outdoor unit capacity is NOT affected by the indoor temperature.

Outdoor unit power input is affected by the indoor and outdoor temperatures. Please consult the sales office for details.

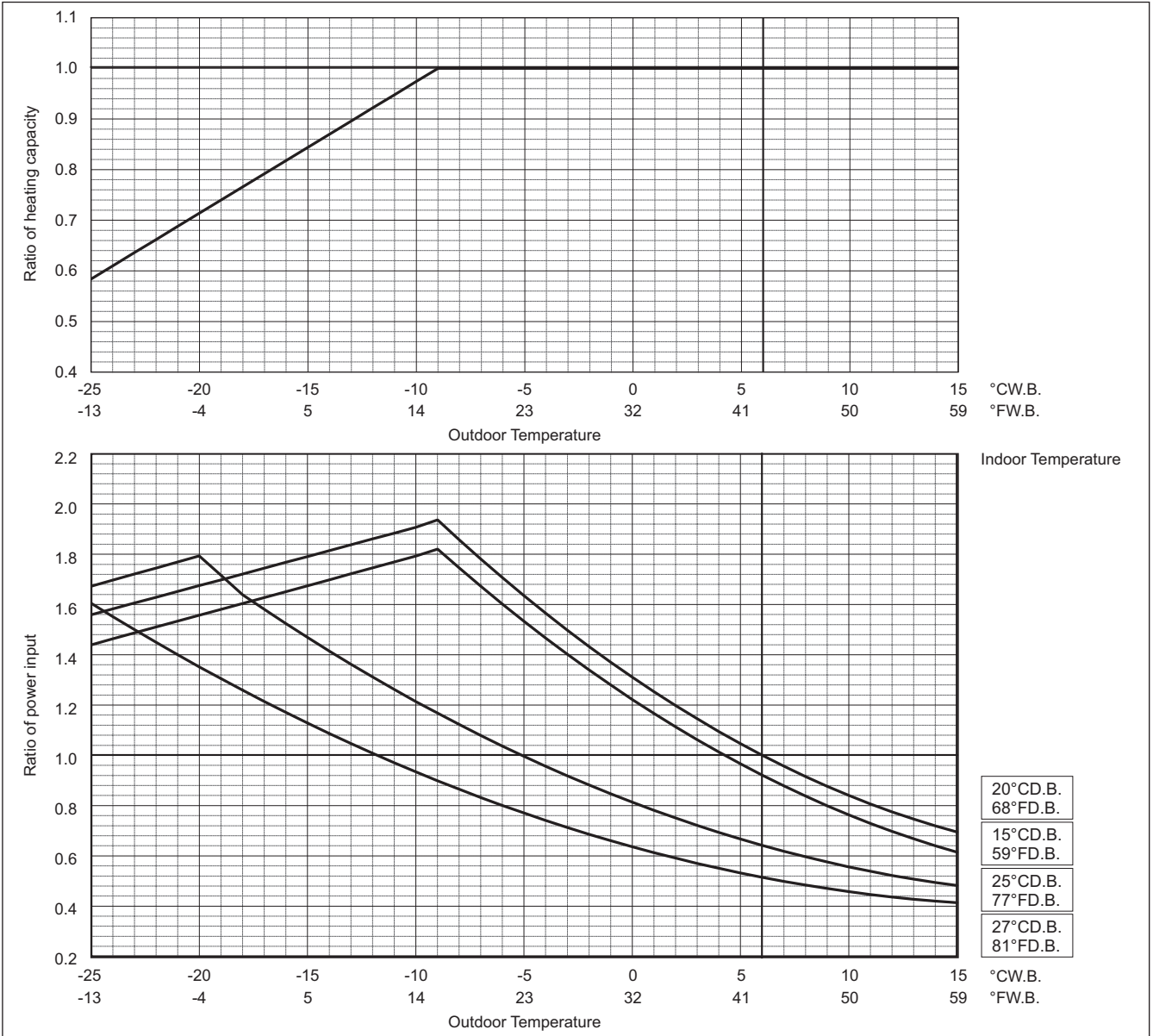

PURY-M-(S)XM-A

PURY-M-Y(S)XM-A

PURY-		M500YSXM-A
Cooling Capacity	kW	56.0
	BTU/h	191,100
Input	kW	16.00

Indoor unit temperature correction

To be used to correct indoor unit capacity only

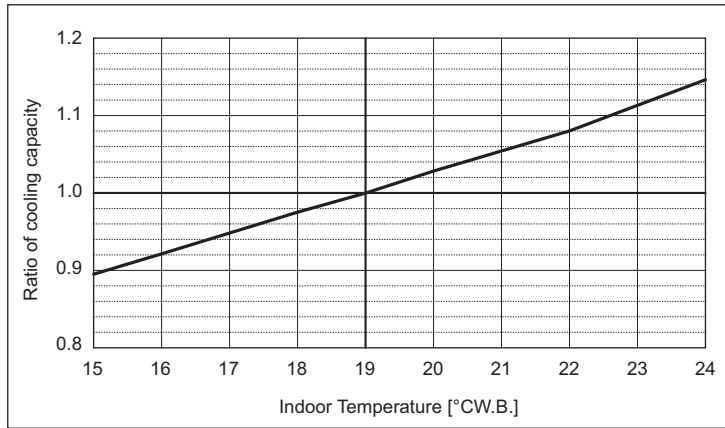

Outdoor unit temperature correction

To be used to correct outdoor unit only

Outdoor unit capacity is NOT affected by the indoor temperature.

Outdoor unit power input is affected by the indoor and outdoor temperatures. Please consult the sales office for details.

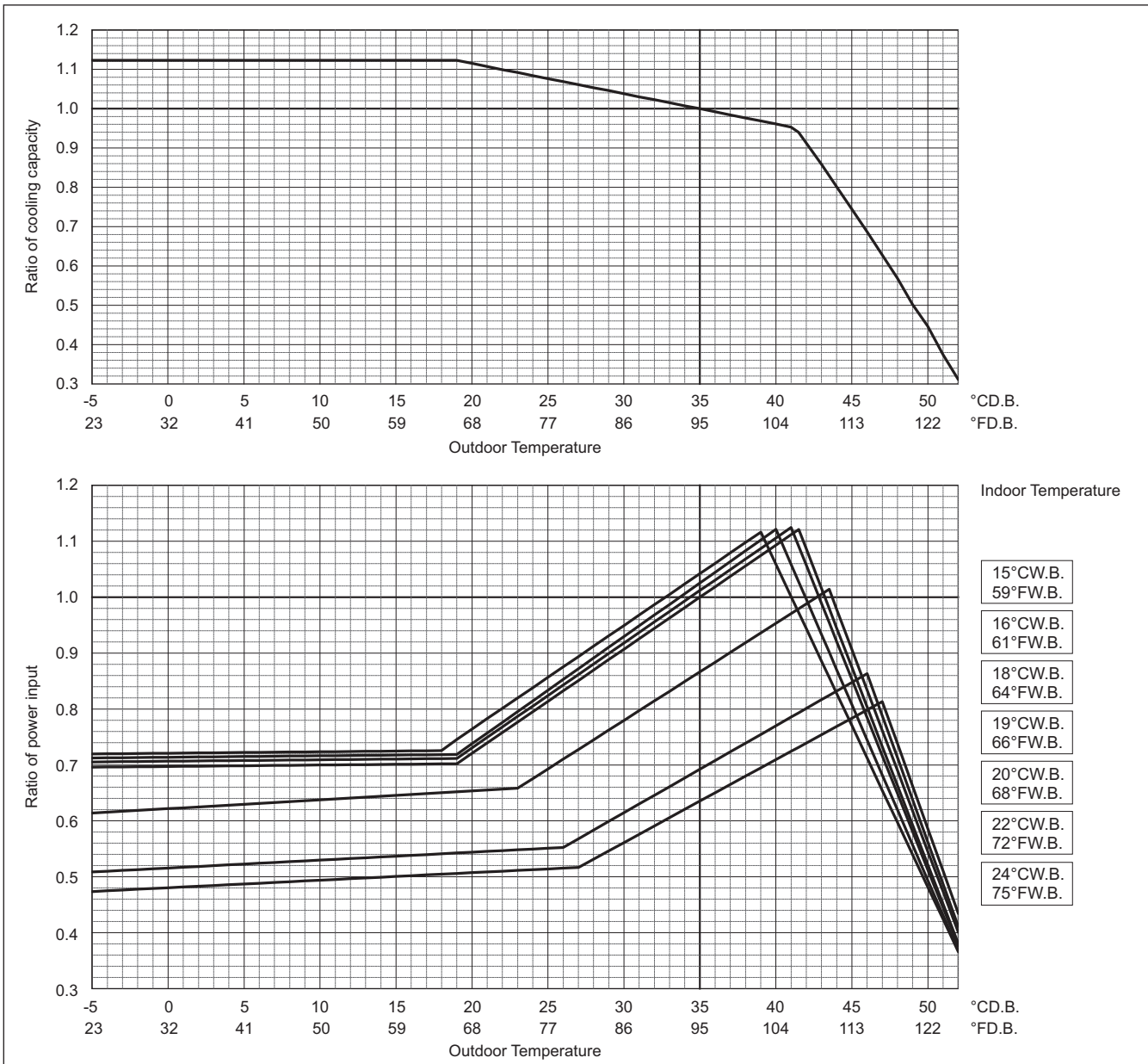

	PURY-	M500YSXM-A
Heating Capacity	kW	63.0
	BTU/h	215,000
Input	kW	16.11

Indoor unit temperature correction

To be used to correct indoor unit capacity only

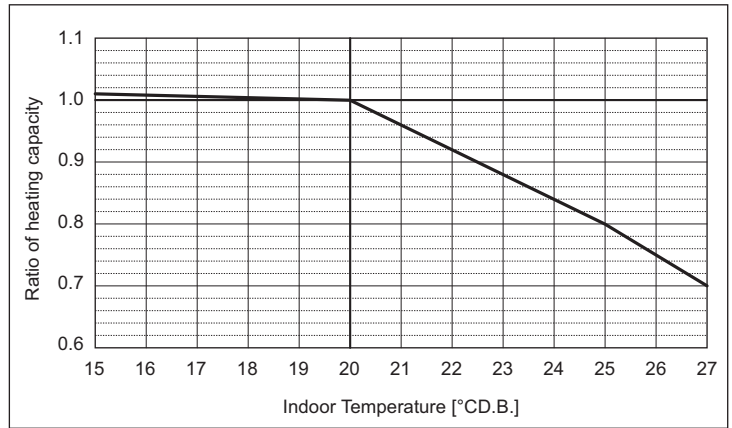

Outdoor unit temperature correction

To be used to correct outdoor unit only

Outdoor unit capacity is NOT affected by the indoor temperature.

Outdoor unit power input is affected by the indoor and outdoor temperatures. Please consult the sales office for details.

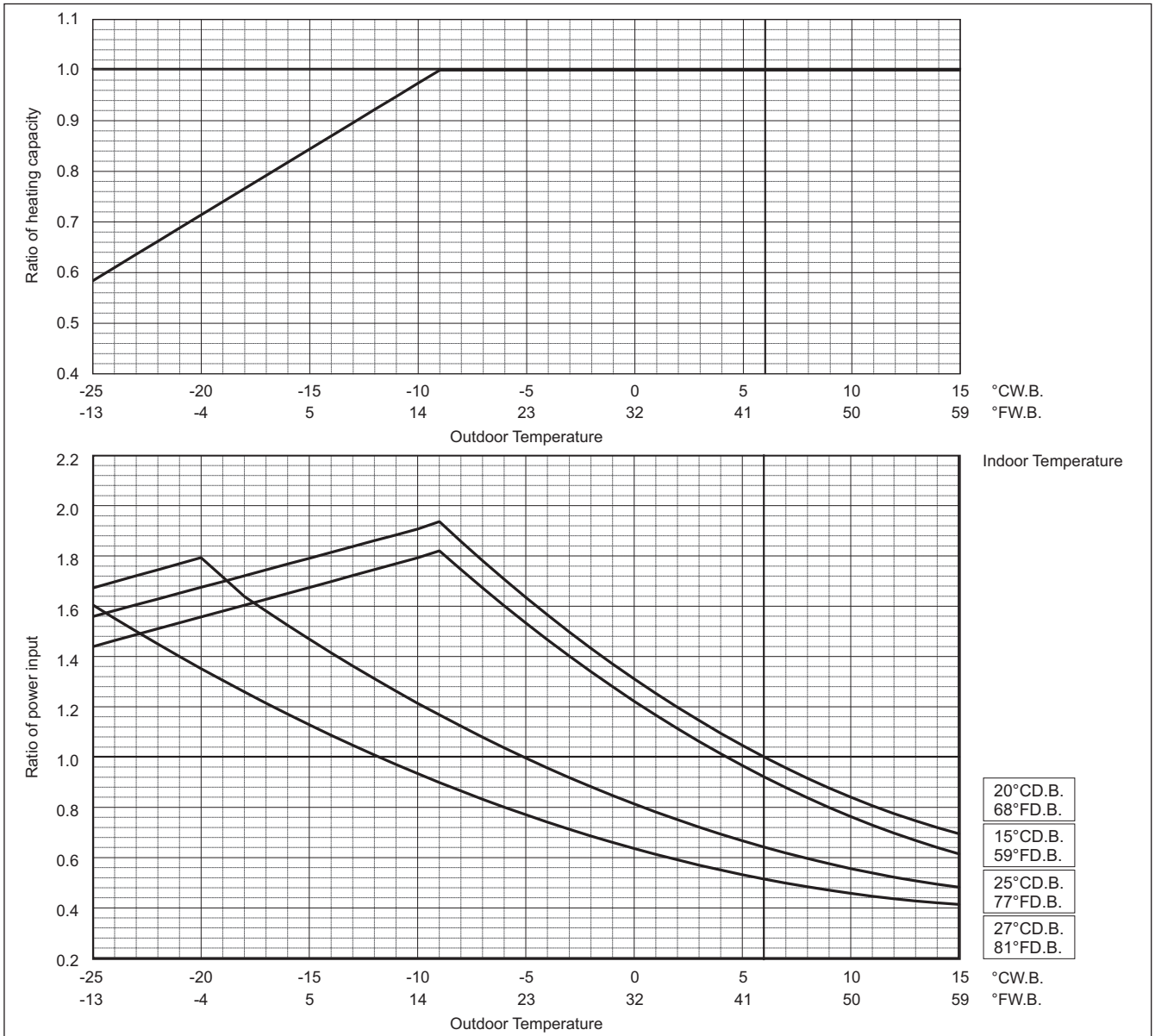

PURY-M-Y(S)XM-A

PURY-		M550YSXM-A
Cooling Capacity	kW	61.5
	BTU/h	209,800
Input	kW	17.67

Indoor unit temperature correction
To be used to correct indoor unit capacity only

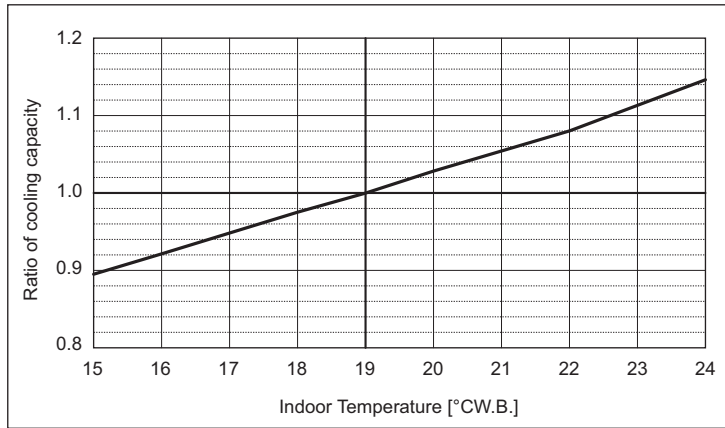

Outdoor unit temperature correction

To be used to correct outdoor unit only

Outdoor unit capacity is NOT affected by the indoor temperature.

Outdoor unit power input is affected by the indoor and outdoor temperatures. Please consult the sales office for details.

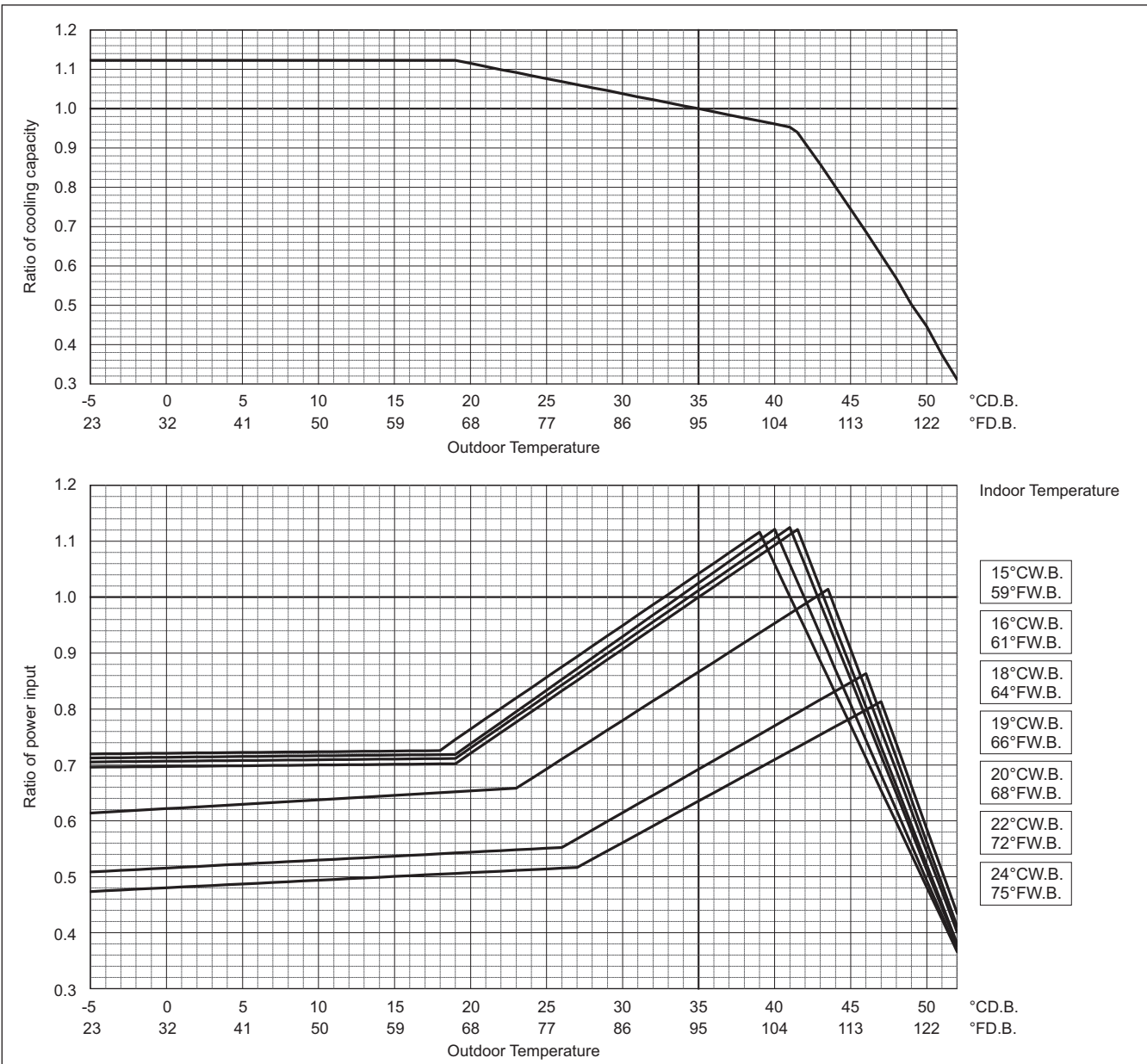

	PURY-	M550YSXM-A
Heating Capacity	kW	69.0
	BTU/h	235,400
Input	kW	17.92

Indoor unit temperature correction

To be used to correct indoor unit capacity only

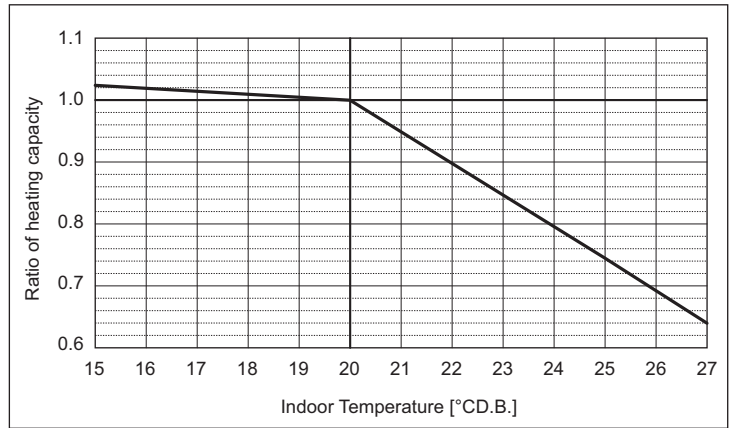

Outdoor unit temperature correction

To be used to correct outdoor unit only

Outdoor unit capacity is NOT affected by the indoor temperature.

Outdoor unit power input is affected by the indoor and outdoor temperatures. Please consult the sales office for details.

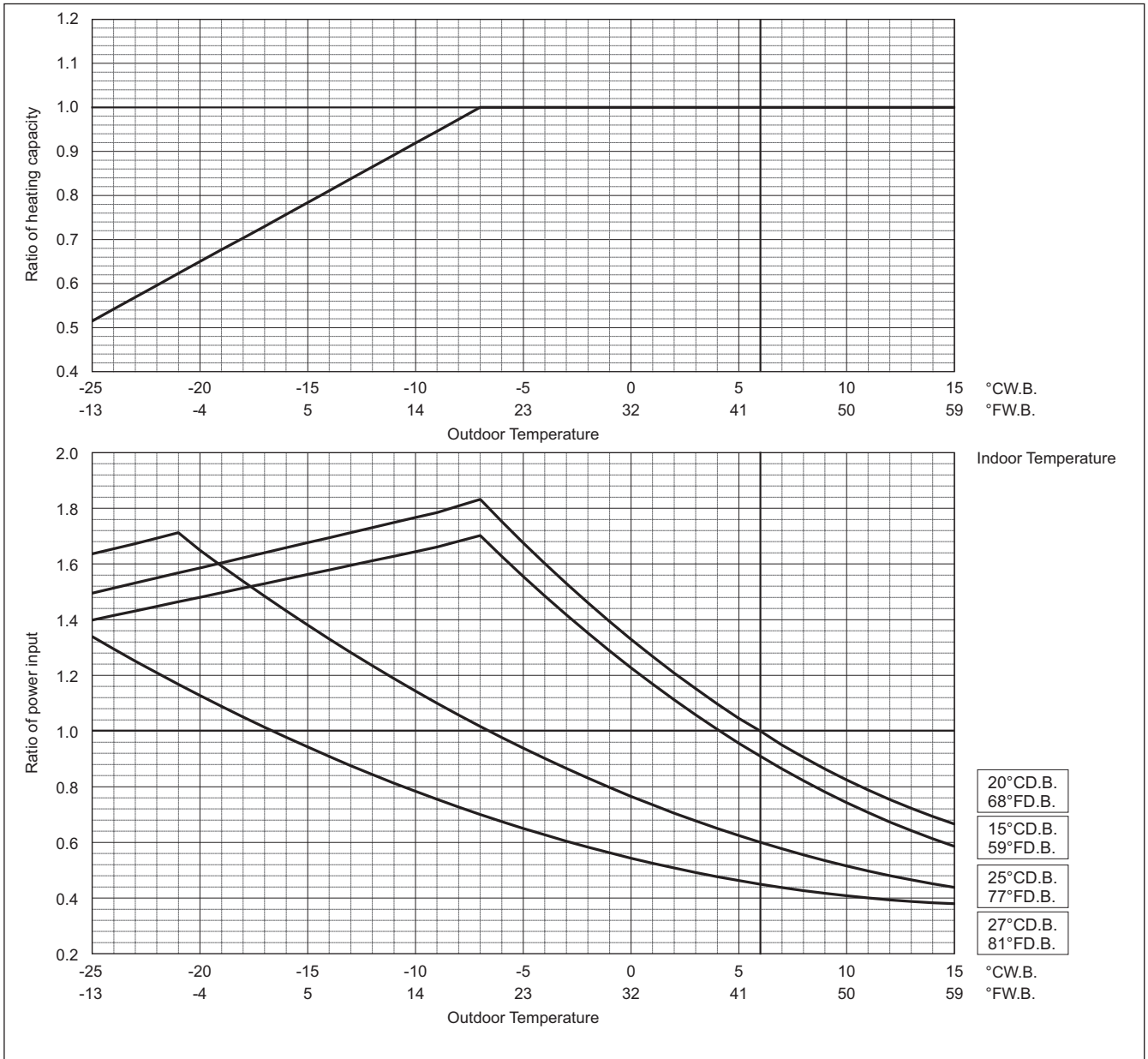

PURY-		M600YSXM-A
Cooling Capacity	kW	67.0
	BTU/h	228,600
Input	kW	19.36

Indoor unit temperature correction
To be used to correct indoor unit capacity only

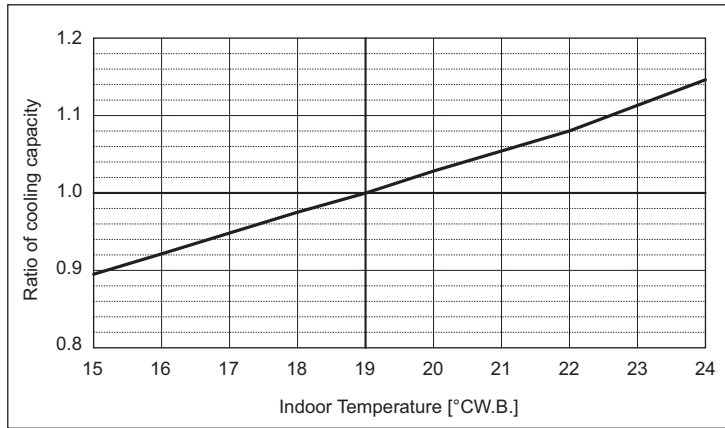

Outdoor unit temperature correction

To be used to correct outdoor unit only

Outdoor unit capacity is NOT affected by the indoor temperature.

Outdoor unit power input is affected by the indoor and outdoor temperatures. Please consult the sales office for details.

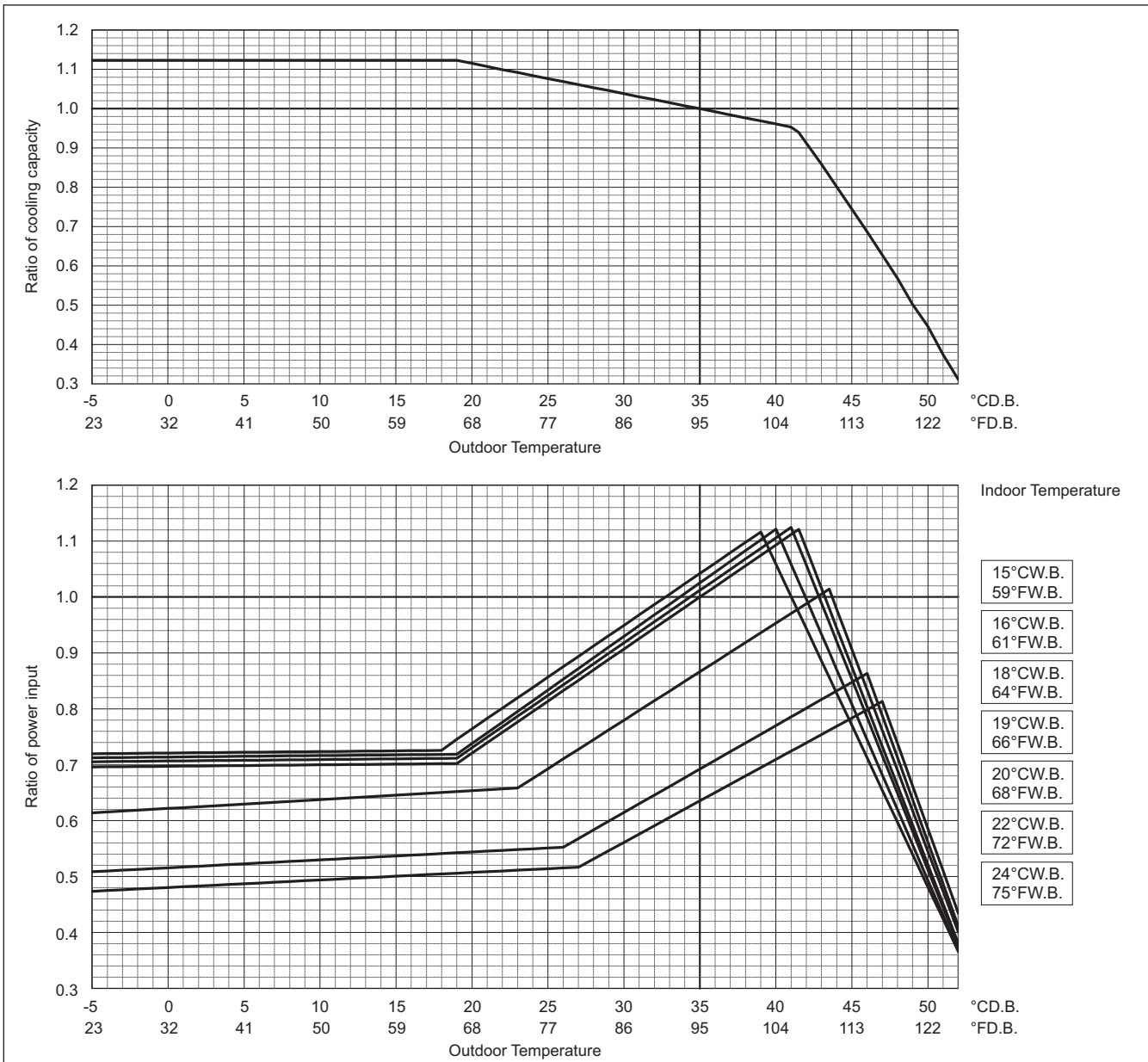

PURY-M-Y(S)XM-A

	PURY-	M600YSXM-A
Heating Capacity	kW	75.0
	BTU/h	225,900
Input	kW	19.84

Indoor unit temperature correction

To be used to correct indoor unit capacity only

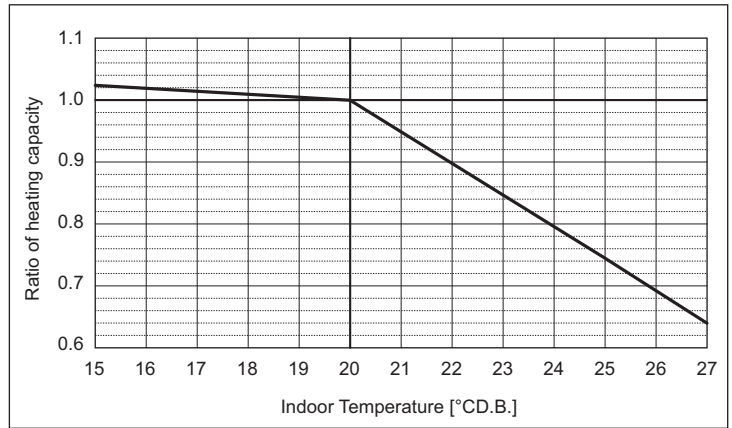

Outdoor unit temperature correction

To be used to correct outdoor unit only

Outdoor unit capacity is NOT affected by the indoor temperature.

Outdoor unit power input is affected by the indoor and outdoor temperatures. Please consult the sales office for details.

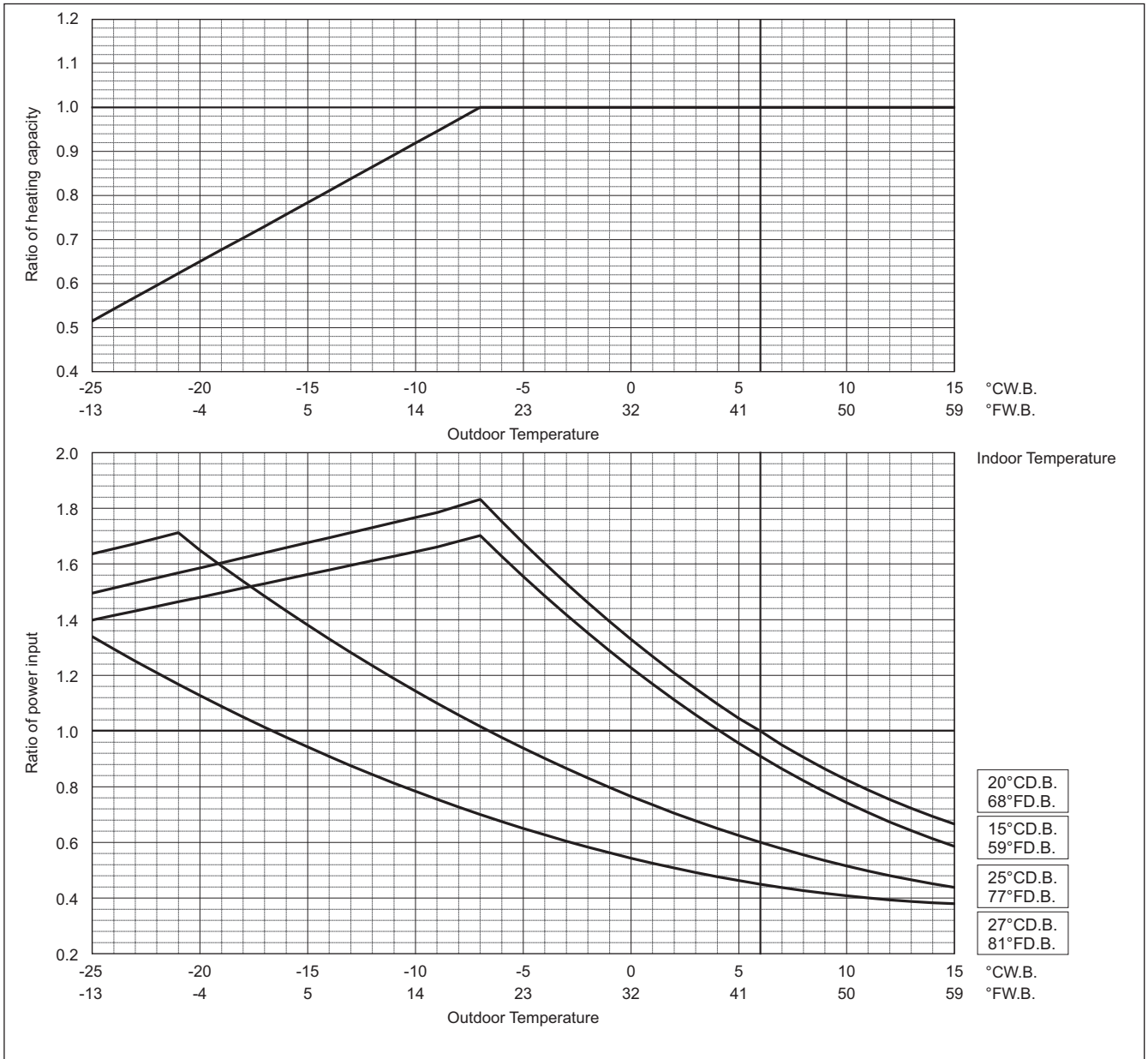

PURY-		M650YSXM-A
Cooling Capacity	kW	73.5
	BTU/h	250,800
Input	kW	21.87

Indoor unit temperature correction
To be used to correct indoor unit capacity only

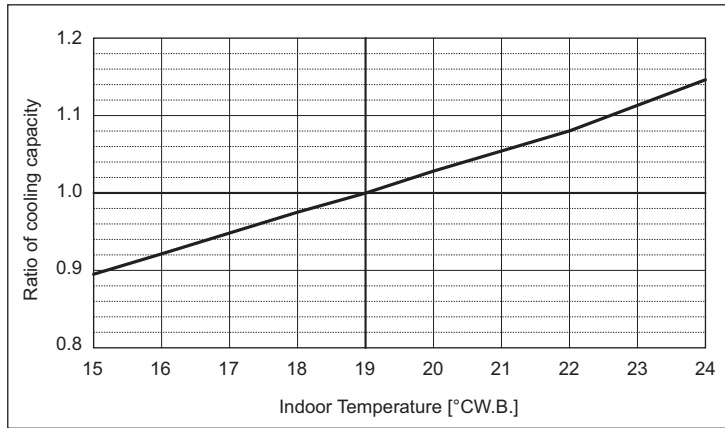

Outdoor unit temperature correction

To be used to correct outdoor unit only

Outdoor unit capacity is NOT affected by the indoor temperature.

Outdoor unit power input is affected by the indoor and outdoor temperatures. Please consult the sales office for details.

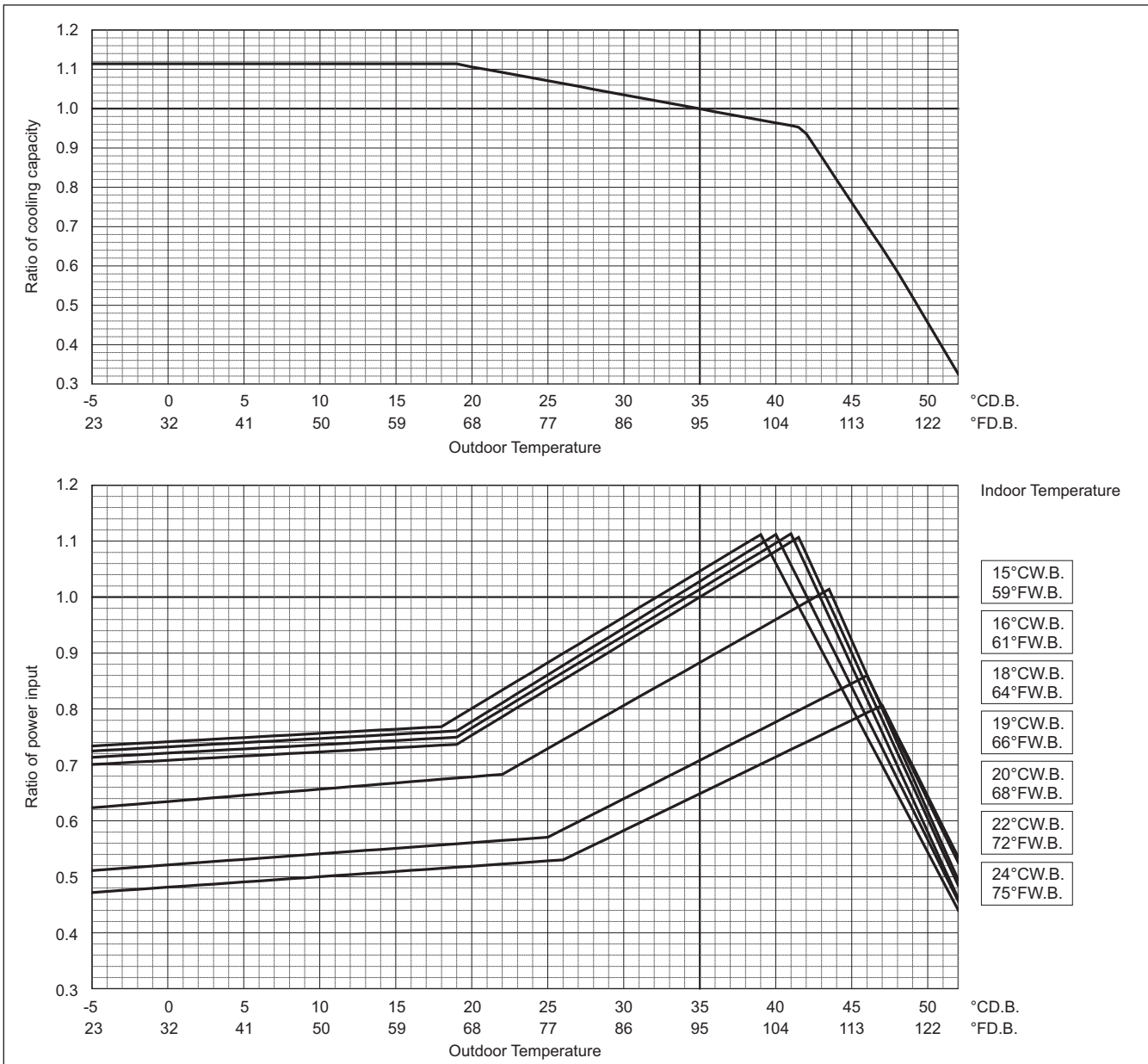

PURY-M-Y(S)XM-A

PURY-		M650YSXM-A
Heating Capacity	kW	82.5
	BTU/h	281,500
Input	kW	22.85

Indoor unit temperature correction

To be used to correct indoor unit capacity only

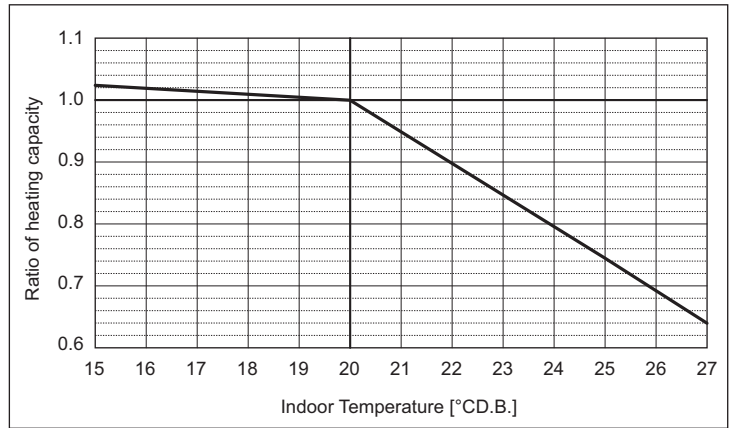

Outdoor unit temperature correction

To be used to correct outdoor unit only

Outdoor unit capacity is NOT affected by the indoor temperature.

Outdoor unit power input is affected by the indoor and outdoor temperatures. Please consult the sales office for details.

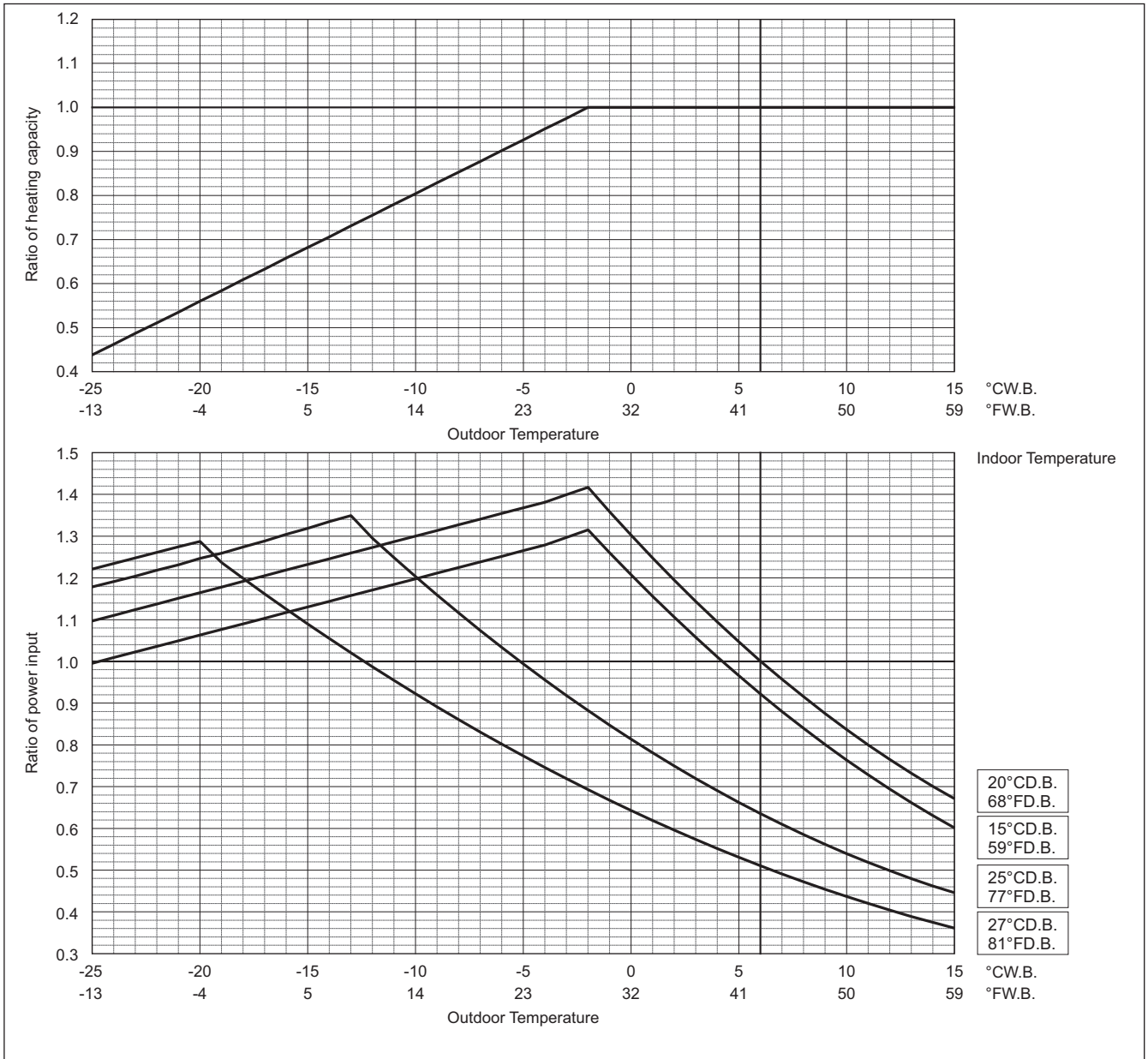

PURY-		M700YSXM-A
Cooling Capacity	kW	80.0
	BTU/h	273,000
Input	kW	23.80

Indoor unit temperature correction
To be used to correct indoor unit capacity only

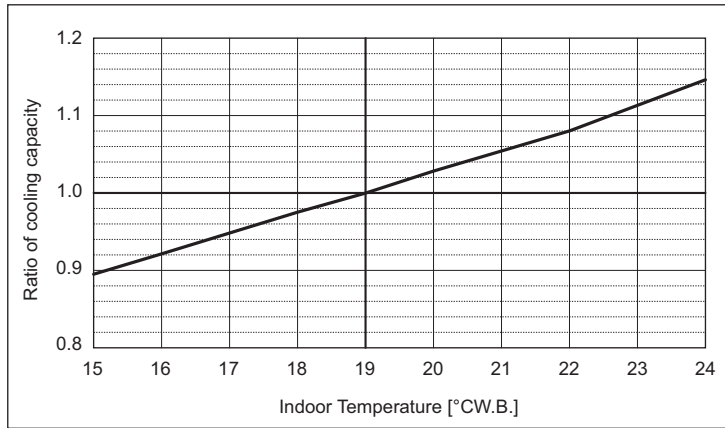

Outdoor unit temperature correction

To be used to correct outdoor unit only

Outdoor unit capacity is NOT affected by the indoor temperature.

Outdoor unit power input is affected by the indoor and outdoor temperatures. Please consult the sales office for details.

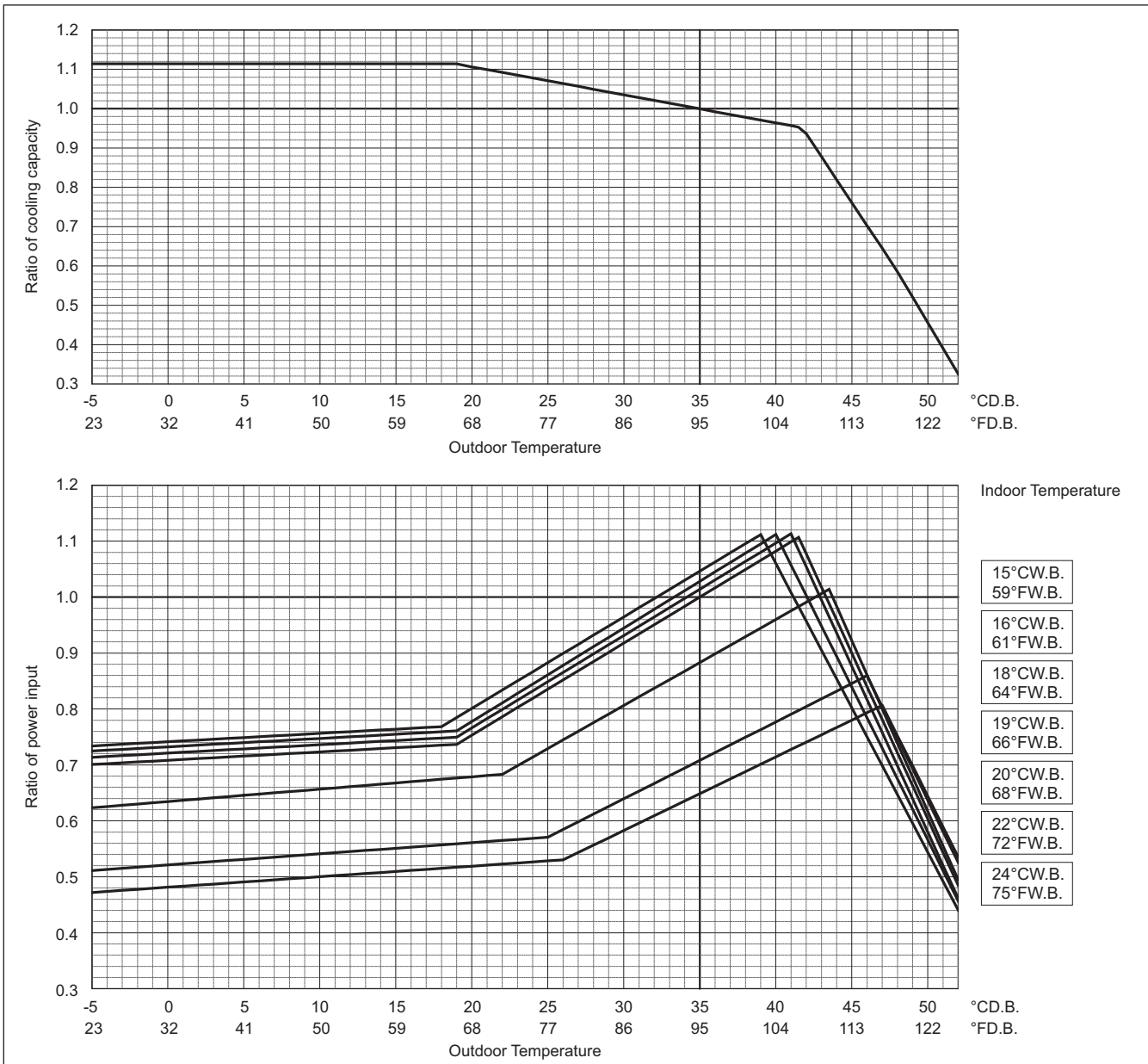

	PURY-	M700YSXM-A
Heating Capacity	kW	90.0
	BTU/h	307,100
Input	kW	26.08

Indoor unit temperature correction

To be used to correct indoor unit capacity only

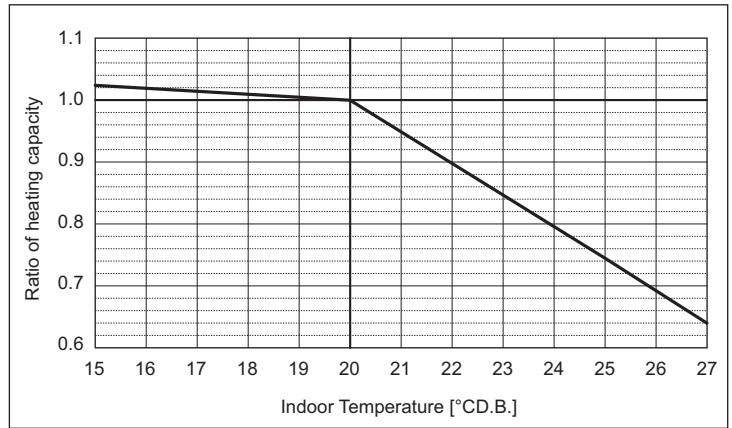

Outdoor unit temperature correction

To be used to correct outdoor unit only

Outdoor unit capacity is NOT affected by the indoor temperature.

Outdoor unit power input is affected by the indoor and outdoor temperatures. Please consult the sales office for details.

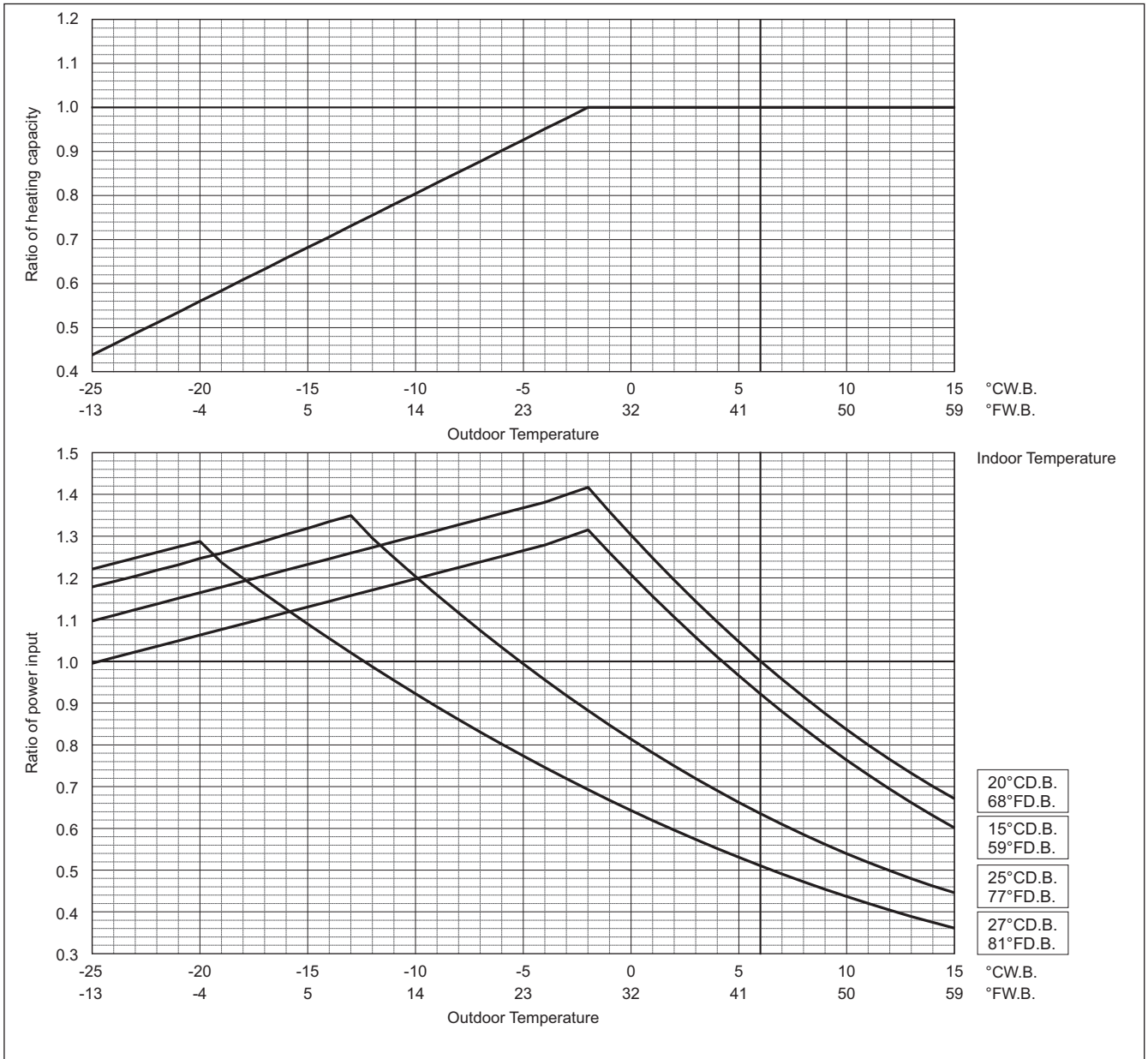

PURY-M-Y(S)XM-A

PURY-		M750YSXM-A
Cooling Capacity	kW	85.0
	BTU/h	290,000
Input	kW	25.67

Indoor unit temperature correction
To be used to correct indoor unit capacity only

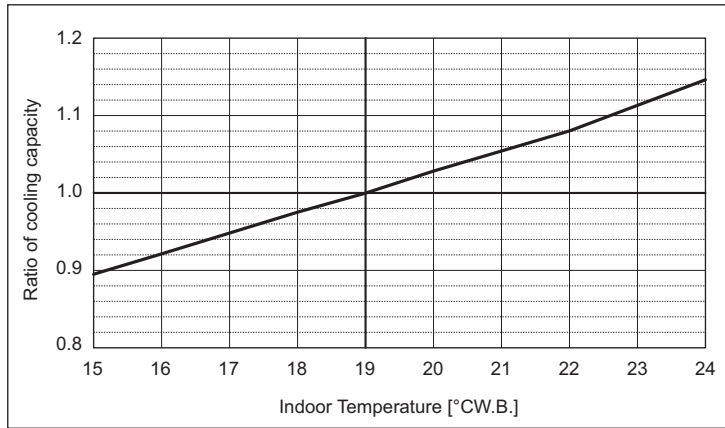

Outdoor unit temperature correction

To be used to correct outdoor unit only
Outdoor unit capacity is NOT affected by the indoor temperature.
Outdoor unit power input is affected by the indoor and outdoor temperatures. Please consult the sales office for details.

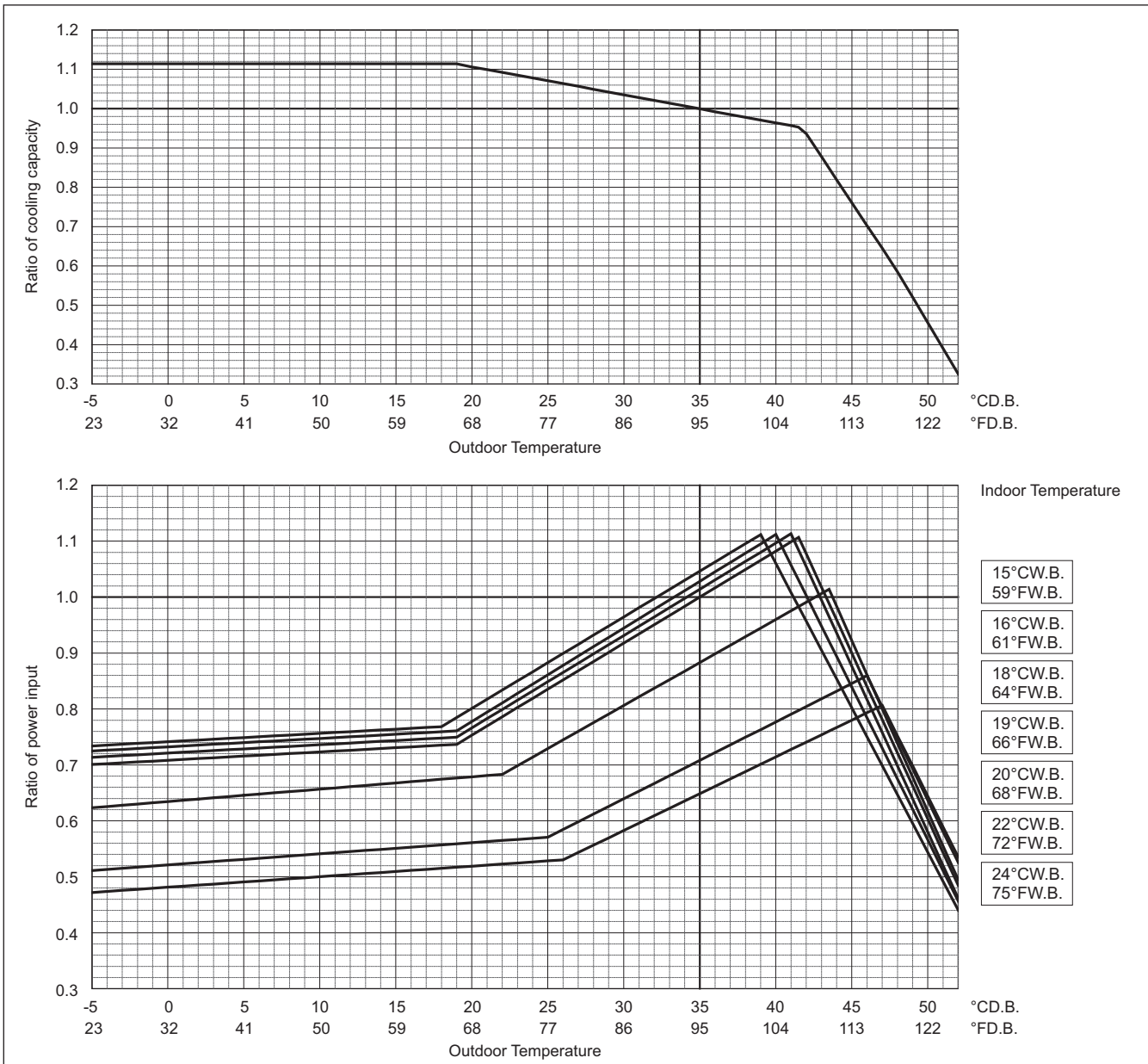

PURY-		M750YSXM-A
Heating Capacity	kW	95.0
	BTU/h	324,100
Input	kW	27.53

Indoor unit temperature correction

To be used to correct indoor unit capacity only

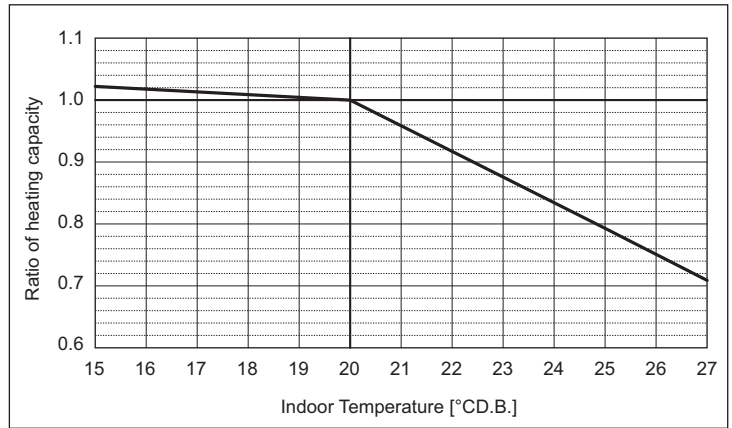

Outdoor unit temperature correction

To be used to correct outdoor unit only

Outdoor unit capacity is NOT affected by the indoor temperature.

Outdoor unit power input is affected by the indoor and outdoor temperatures. Please consult the sales office for details.

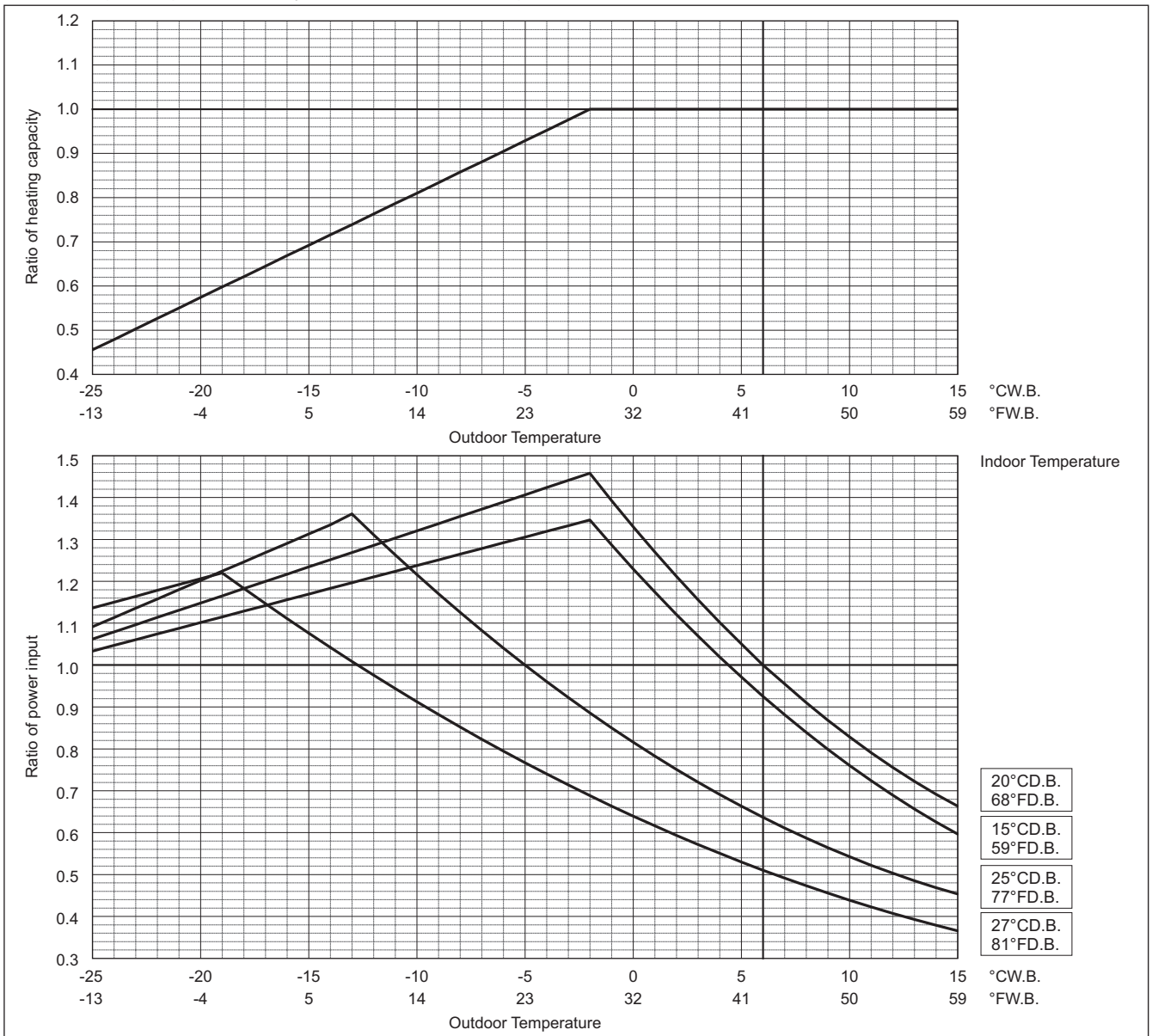

PURY-M-V(S)XM-A

PURY-		M800YSXM-A
Cooling Capacity	kW	90.0
	BTU/h	307,100
Input	kW	27.60

Indoor unit temperature correction
To be used to correct indoor unit capacity only

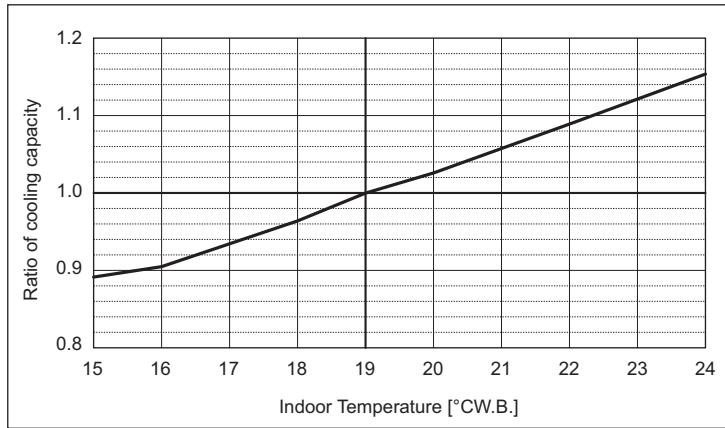

Outdoor unit temperature correction

To be used to correct outdoor unit only
Outdoor unit capacity is NOT affected by the indoor temperature.
Outdoor unit power input is affected by the indoor and outdoor temperatures. Please consult the sales office for details.

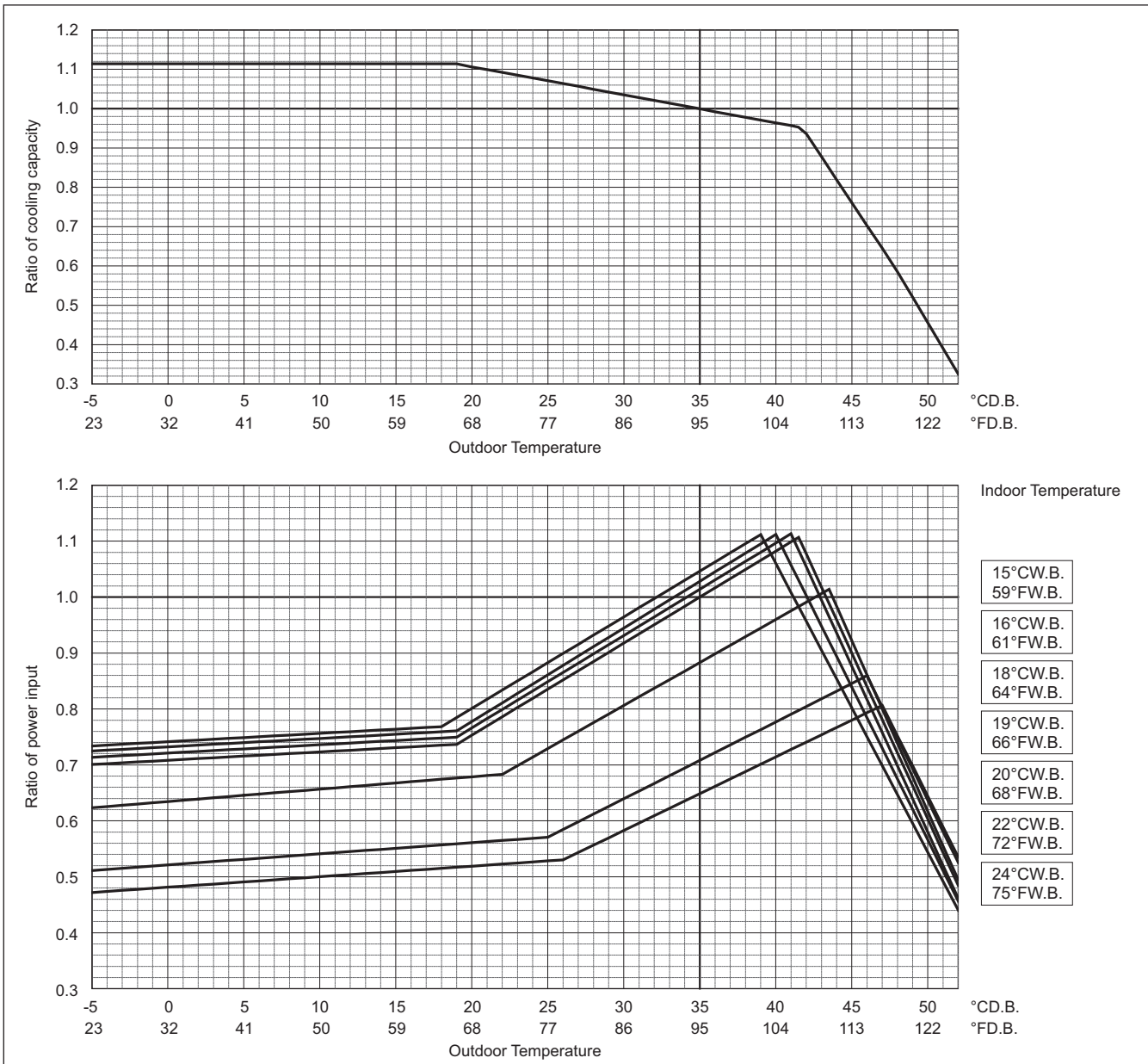

PURY-M-Y(S)XM-A

	PURY-	M800YSXM-A
Heating Capacity	kW	100.0
	BTU/h	341,200
Input	kW	28.98

Indoor unit temperature correction

To be used to correct indoor unit capacity only

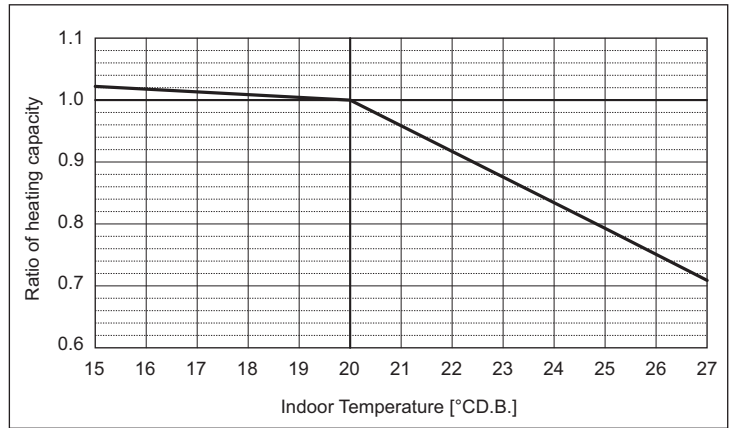

Outdoor unit temperature correction

To be used to correct outdoor unit only

Outdoor unit capacity is NOT affected by the indoor temperature.

Outdoor unit power input is affected by the indoor and outdoor temperatures. Please consult the sales office for details.

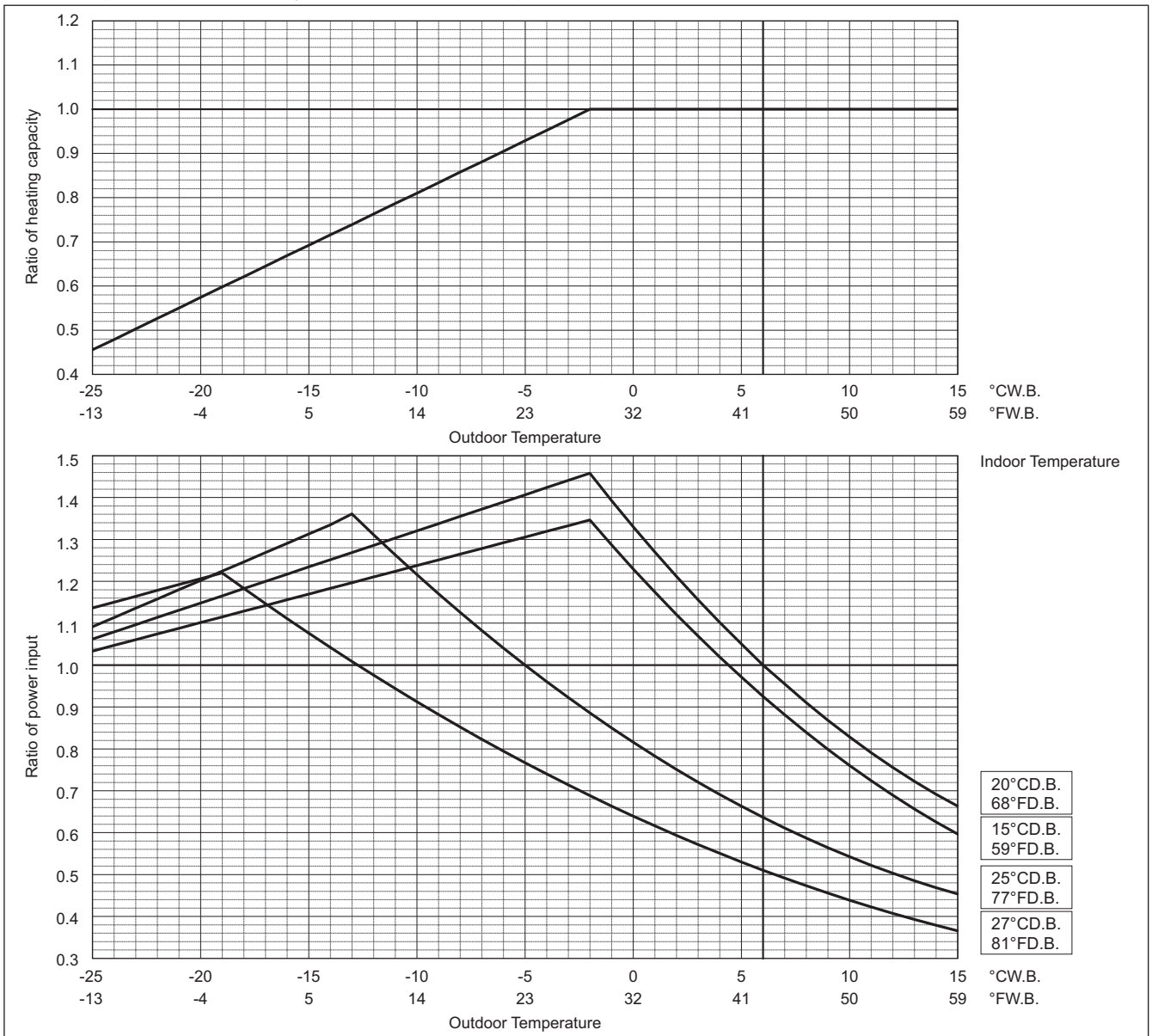

PURY-M-V(S)XM-A

PURY-		M850YSXM-A
Cooling Capacity	kW	95.0
	BTU/h	324,100
Input	kW	29.59

Indoor unit temperature correction

To be used to correct indoor unit capacity only

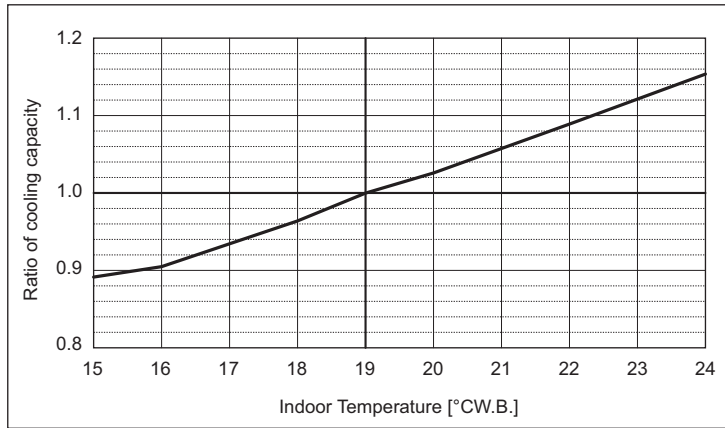

Outdoor unit temperature correction

To be used to correct outdoor unit only

Outdoor unit capacity is NOT affected by the indoor temperature.

Outdoor unit power input is affected by the indoor and outdoor temperatures. Please consult the sales office for details.

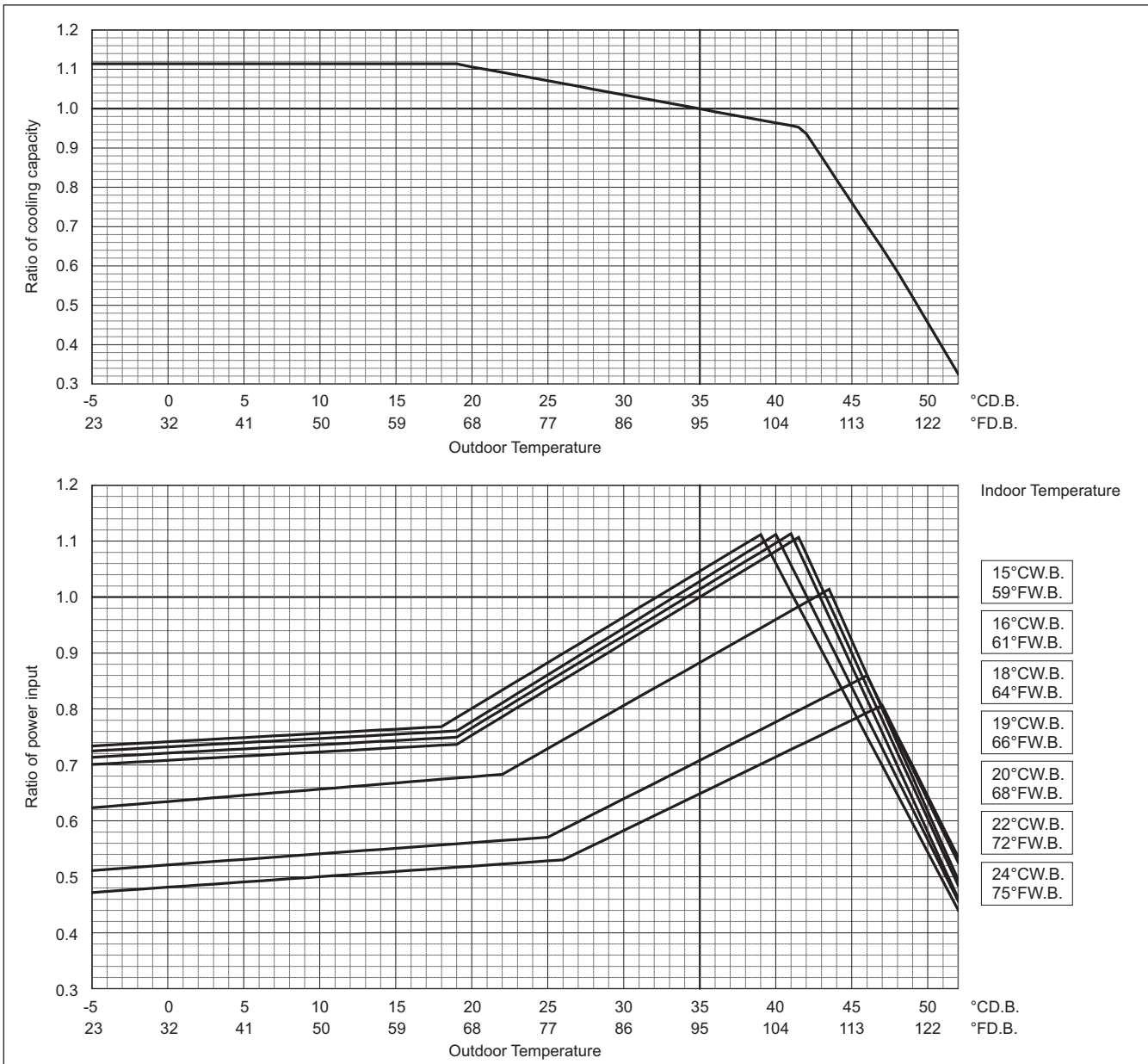

PURY-M-Y(S)XM-A

	PURY-	M850YSXM-A
Heating Capacity	kW	106.0
	BTU/h	361,700
Input	kW	31.64

Indoor unit temperature correction

To be used to correct indoor unit capacity only

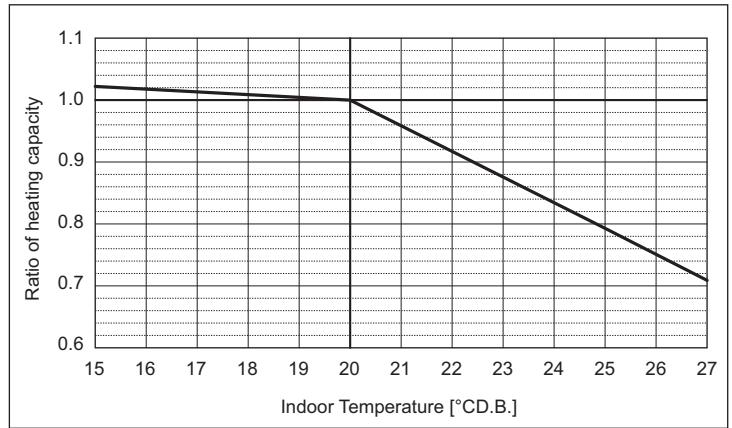

Outdoor unit temperature correction

To be used to correct outdoor unit only

Outdoor unit capacity is NOT affected by the indoor temperature.

Outdoor unit power input is affected by the indoor and outdoor temperatures. Please consult the sales office for details.

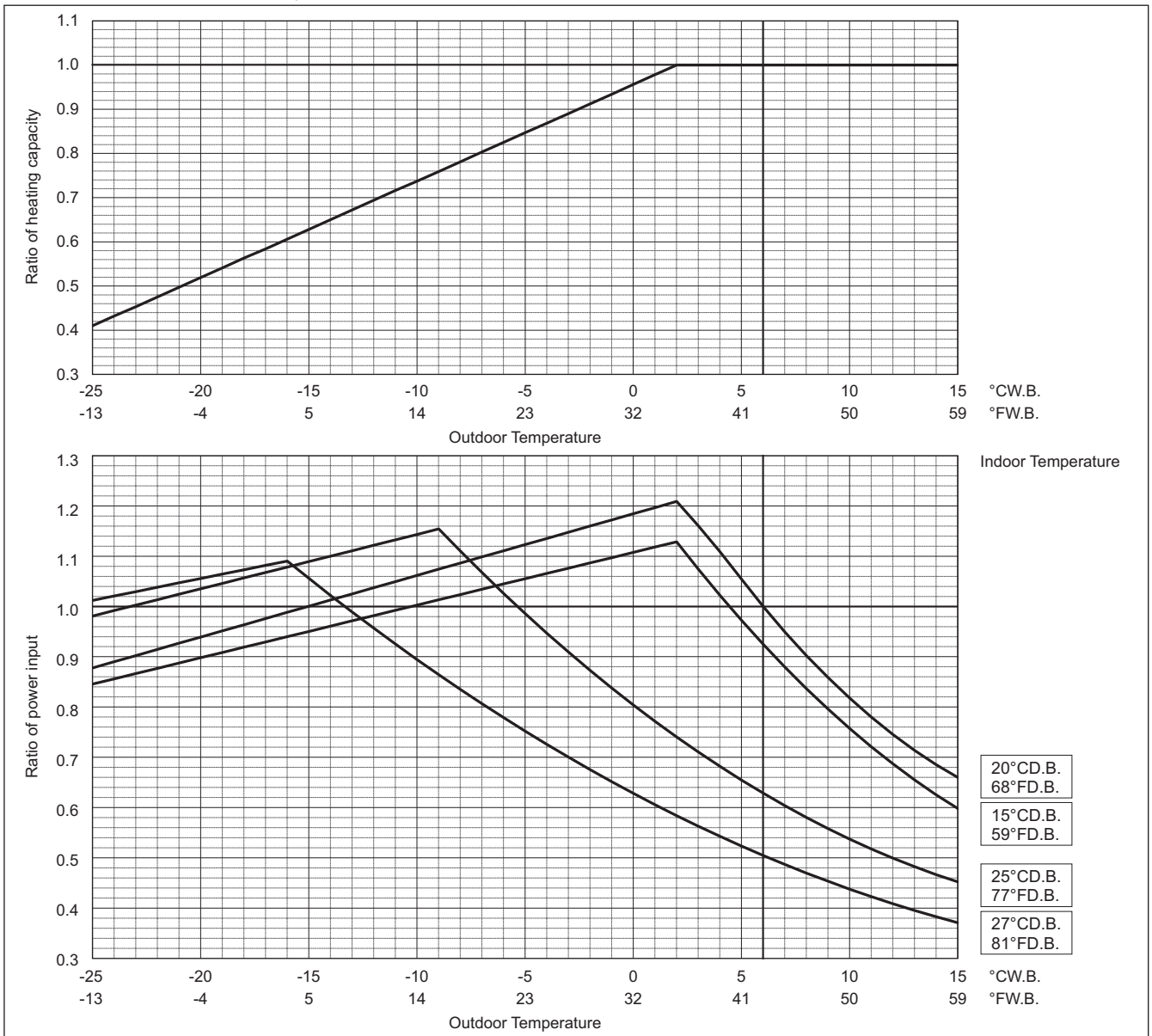

PURY-M-V(S)XM-A

PURY-		M900YSXM-A
Cooling Capacity	kW	100.0
	BTU/h	341,200
Input	kW	31.94

Indoor unit temperature correction
To be used to correct indoor unit capacity only

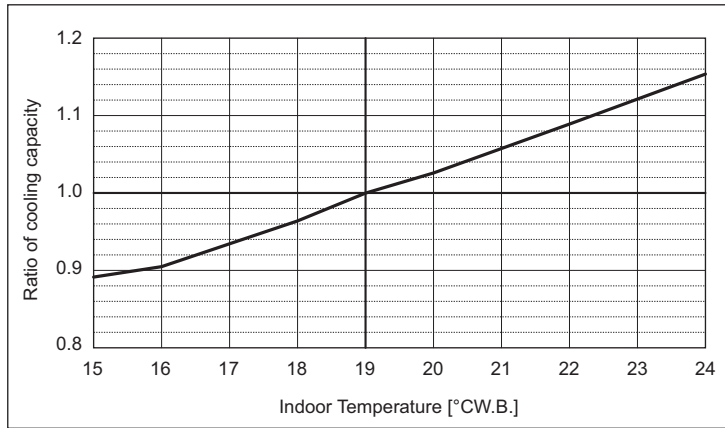

Outdoor unit temperature correction

To be used to correct outdoor unit only
Outdoor unit capacity is NOT affected by the indoor temperature.
Outdoor unit power input is affected by the indoor and outdoor temperatures. Please consult the sales office for details.

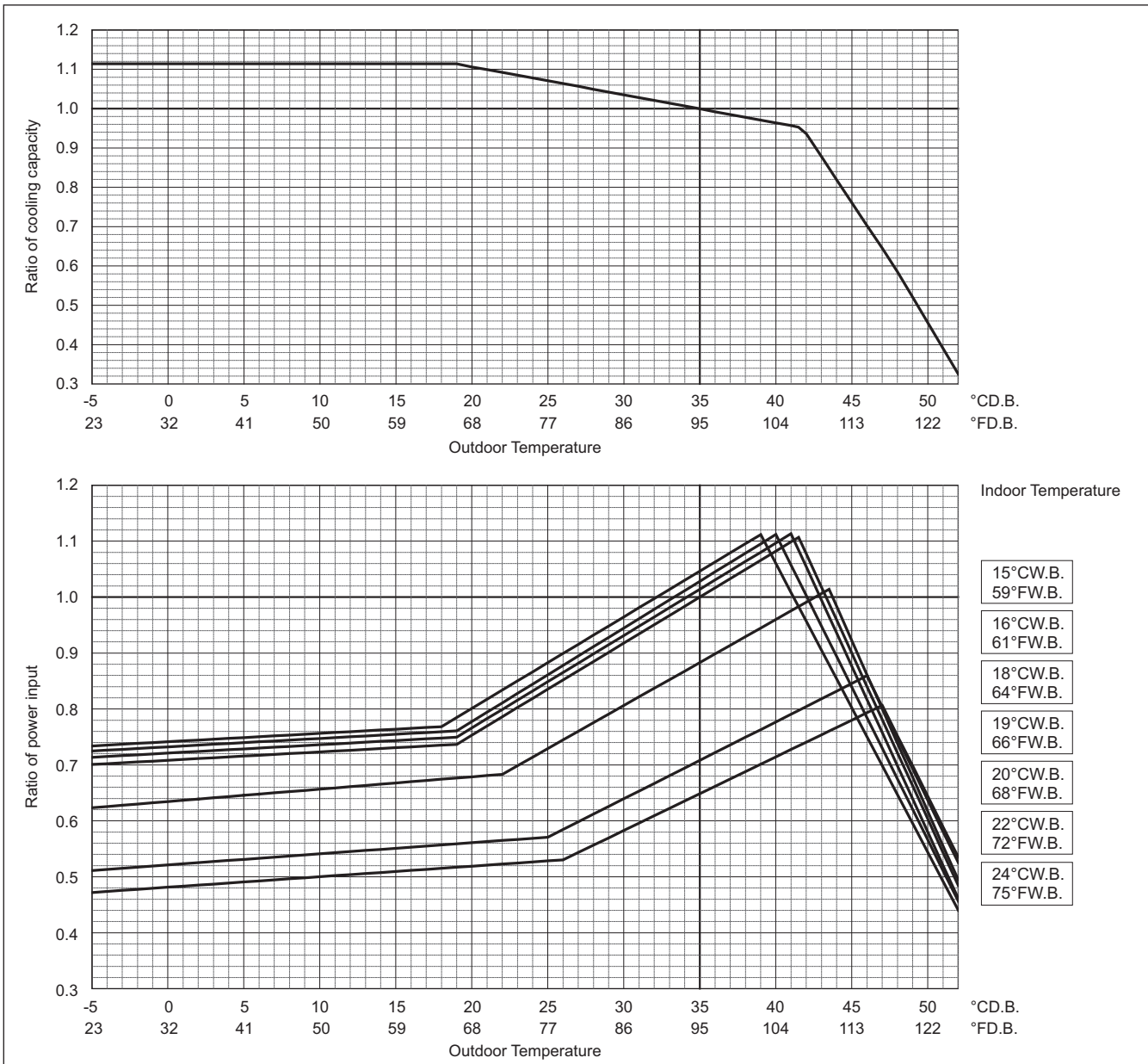

PURY-M-Y(S)XM-A

	PURY-	M900YSXM-A
Heating Capacity	kW	112.0
	BTU/h	382,100
Input	kW	34.46

Indoor unit temperature correction

To be used to correct indoor unit capacity only

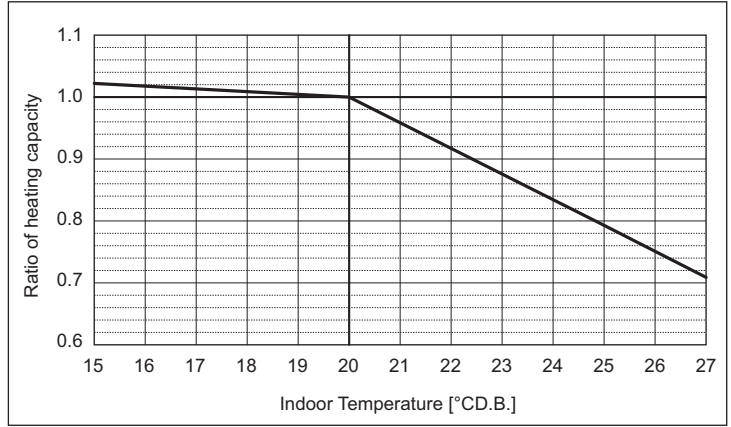

Outdoor unit temperature correction

To be used to correct outdoor unit only

Outdoor unit capacity is NOT affected by the indoor temperature.

Outdoor unit power input is affected by the indoor and outdoor temperatures. Please consult the sales office for details.

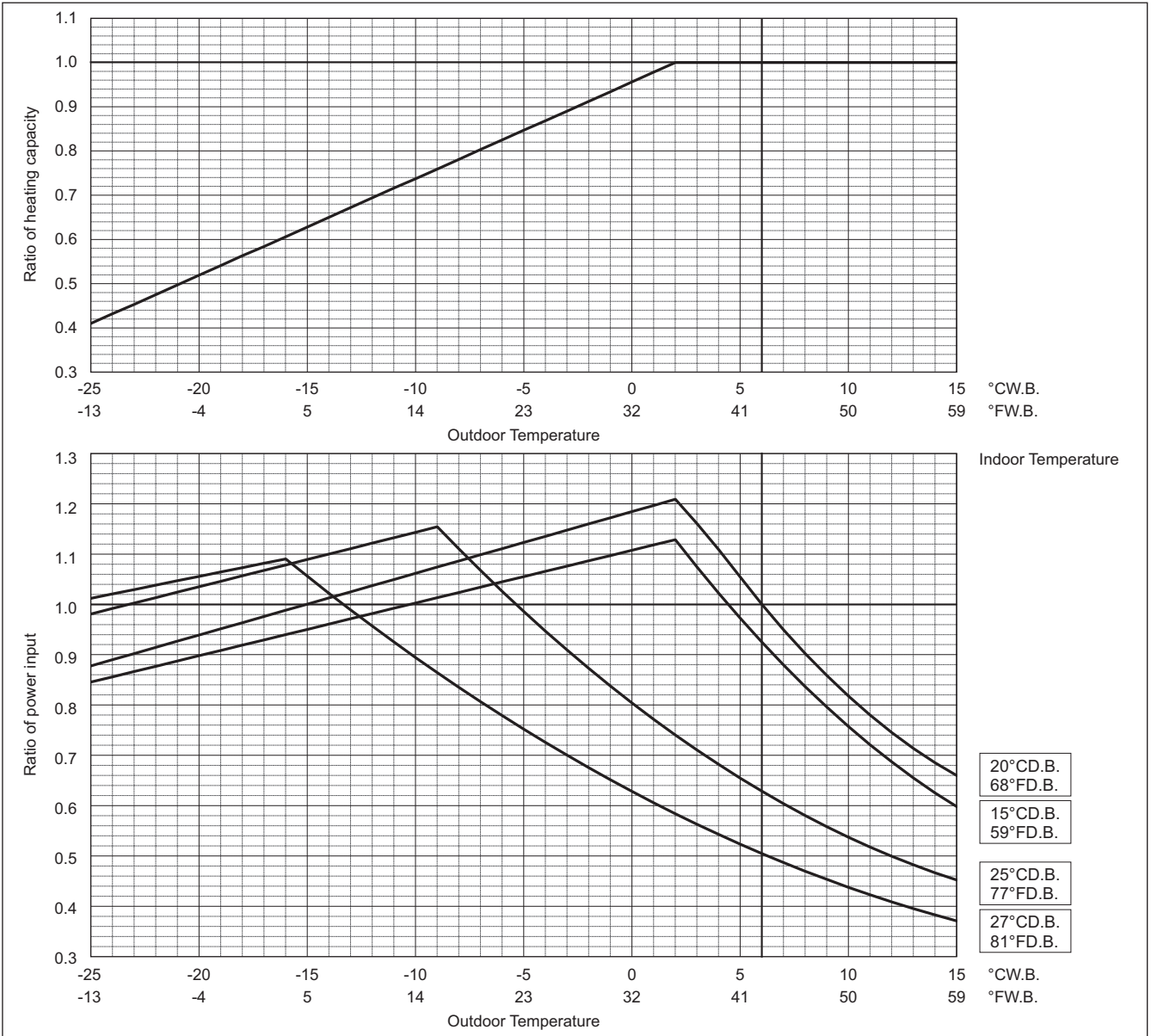

PURY-M-V(S)XM-A

PURY-		M950YSXM-A
Cooling Capacity	kW	106.0
	BTU/h	361,700
Input	kW	36.05

Indoor unit temperature correction

To be used to correct indoor unit capacity only

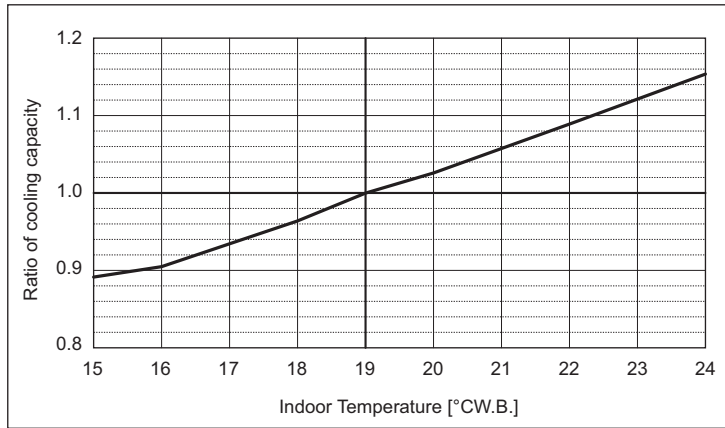

Outdoor unit temperature correction

To be used to correct outdoor unit only

Outdoor unit capacity is NOT affected by the indoor temperature.

Outdoor unit power input is affected by the indoor and outdoor temperatures. Please consult the sales office for details.

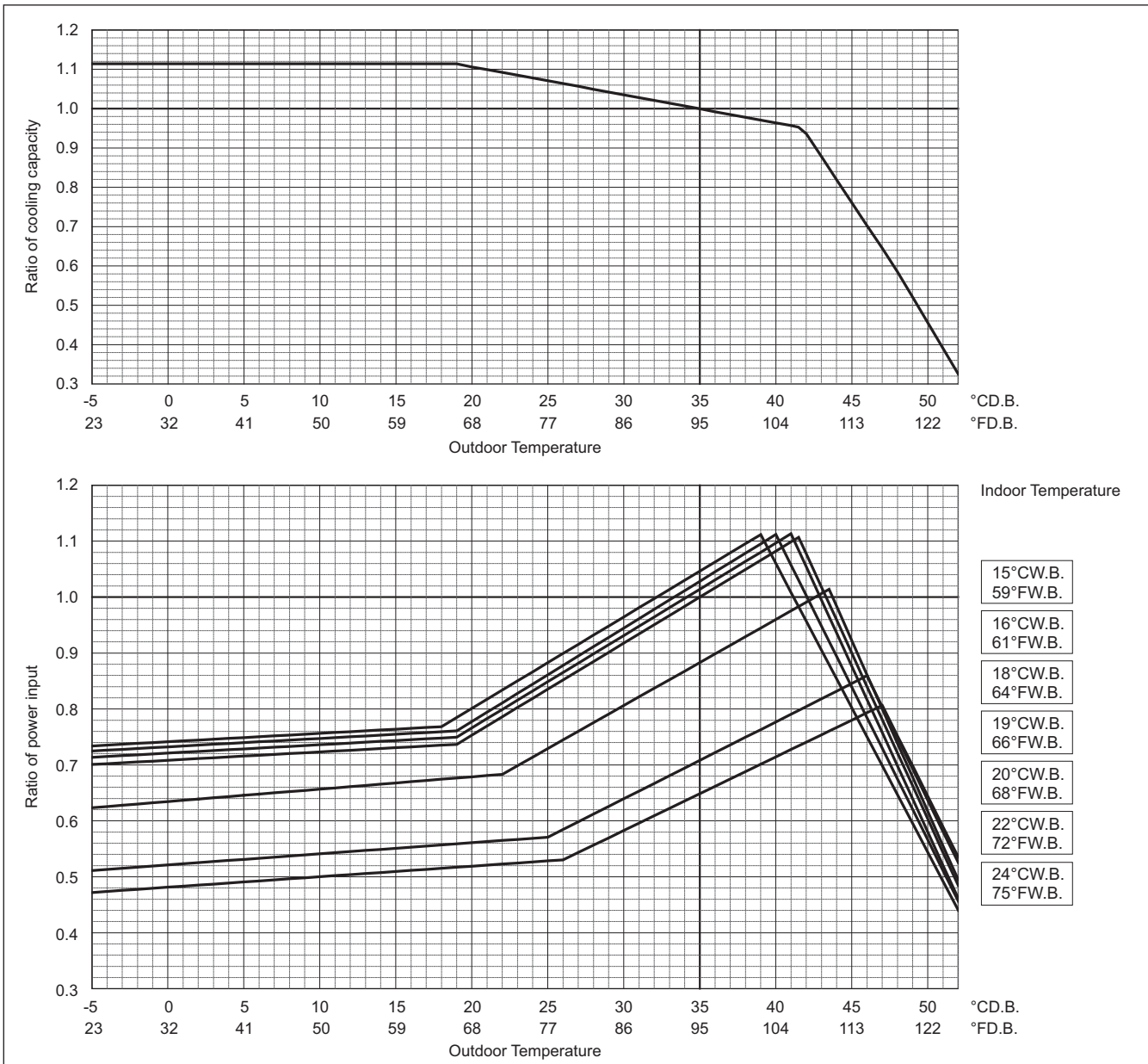

PURY-M-Y(S)XM-A

	PURY-	M950YSXM-A
Heating Capacity	kW	114.0
	BTU/h	389,000
Input	kW	35.18

Indoor unit temperature correction

To be used to correct indoor unit capacity only

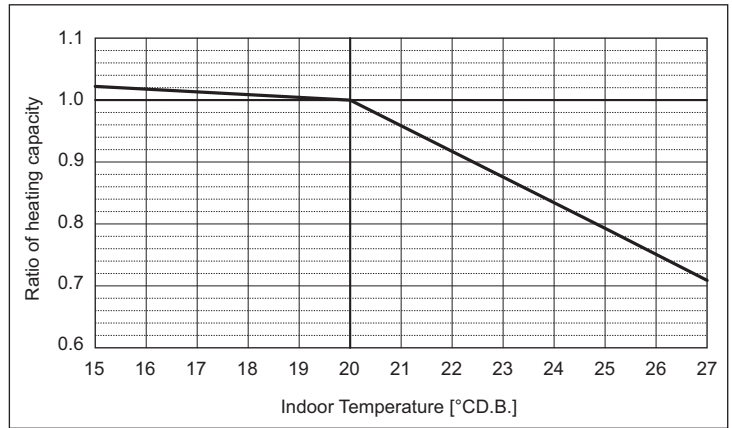

Outdoor unit temperature correction

To be used to correct outdoor unit only

Outdoor unit capacity is NOT affected by the indoor temperature.

Outdoor unit power input is affected by the indoor and outdoor temperatures. Please consult the sales office for details.

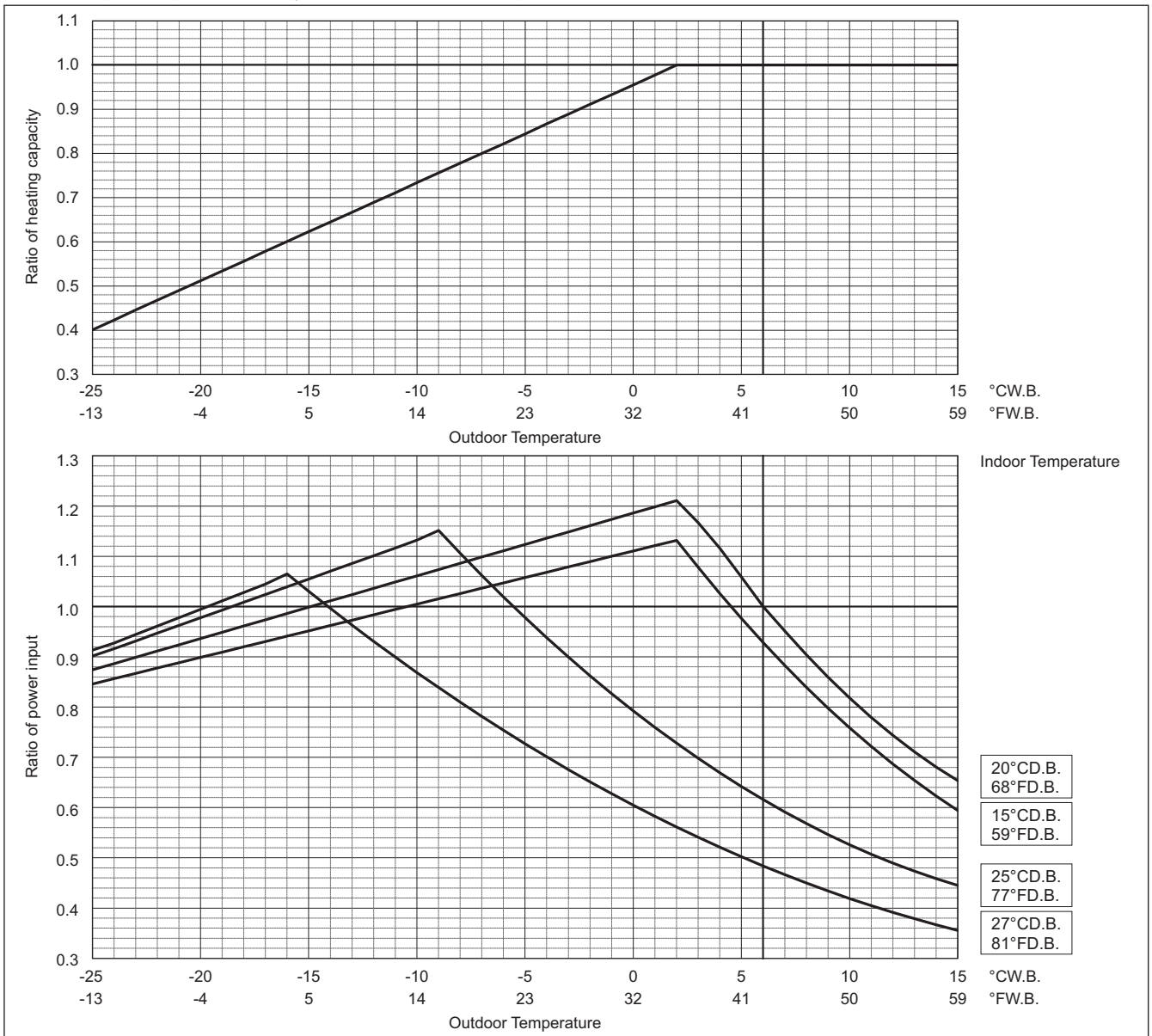

PURY-		M1000YSXM-A
Cooling Capacity	kW	112.0
	BTU/h	382,100
Input	kW	40.87

Indoor unit temperature correction

To be used to correct indoor unit capacity only

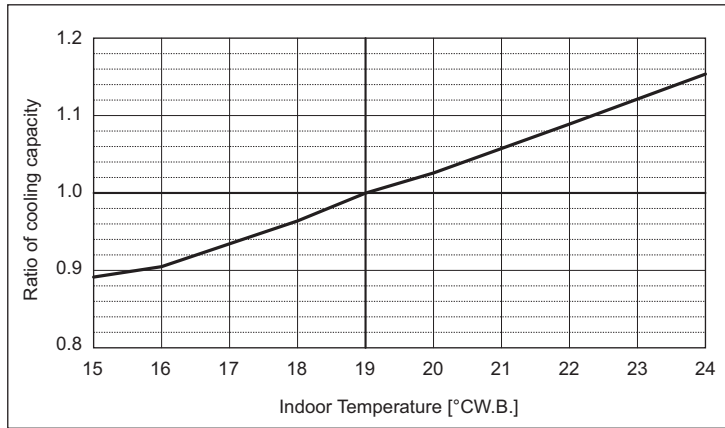

Outdoor unit temperature correction

To be used to correct outdoor unit only

Outdoor unit capacity is NOT affected by the indoor temperature.

Outdoor unit power input is affected by the indoor and outdoor temperatures. Please consult the sales office for details.

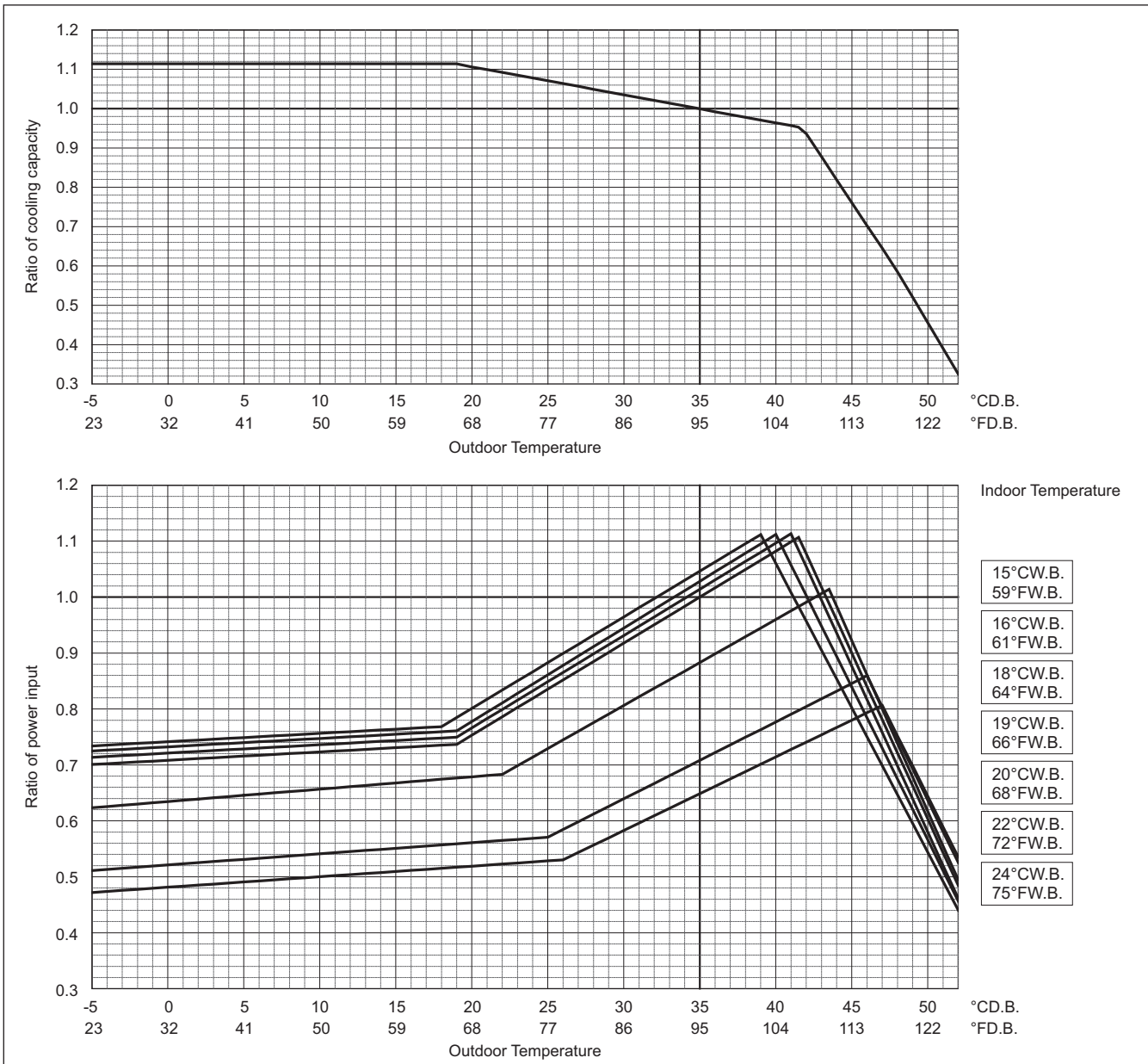

PURY-M-Y(S)XM-A

PURY-		M1000YSXM-A
Heating Capacity	kW	116.0
	BTU/h	395,800
Input	kW	35.91

Indoor unit temperature correction

To be used to correct indoor unit capacity only

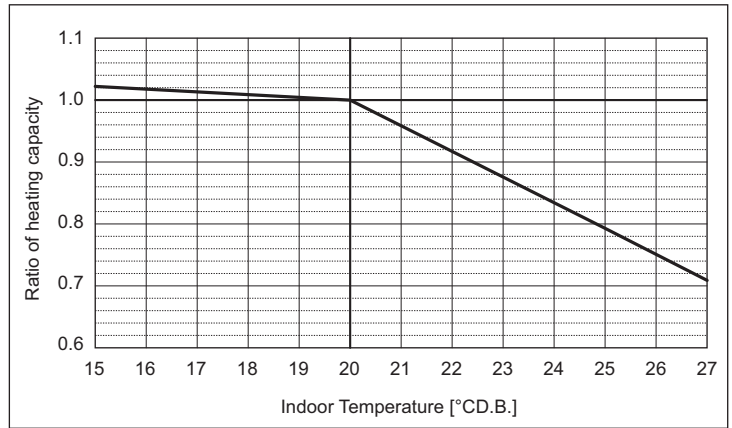

Outdoor unit temperature correction

To be used to correct outdoor unit only

Outdoor unit capacity is NOT affected by the indoor temperature.

Outdoor unit power input is affected by the indoor and outdoor temperatures. Please consult the sales office for details.

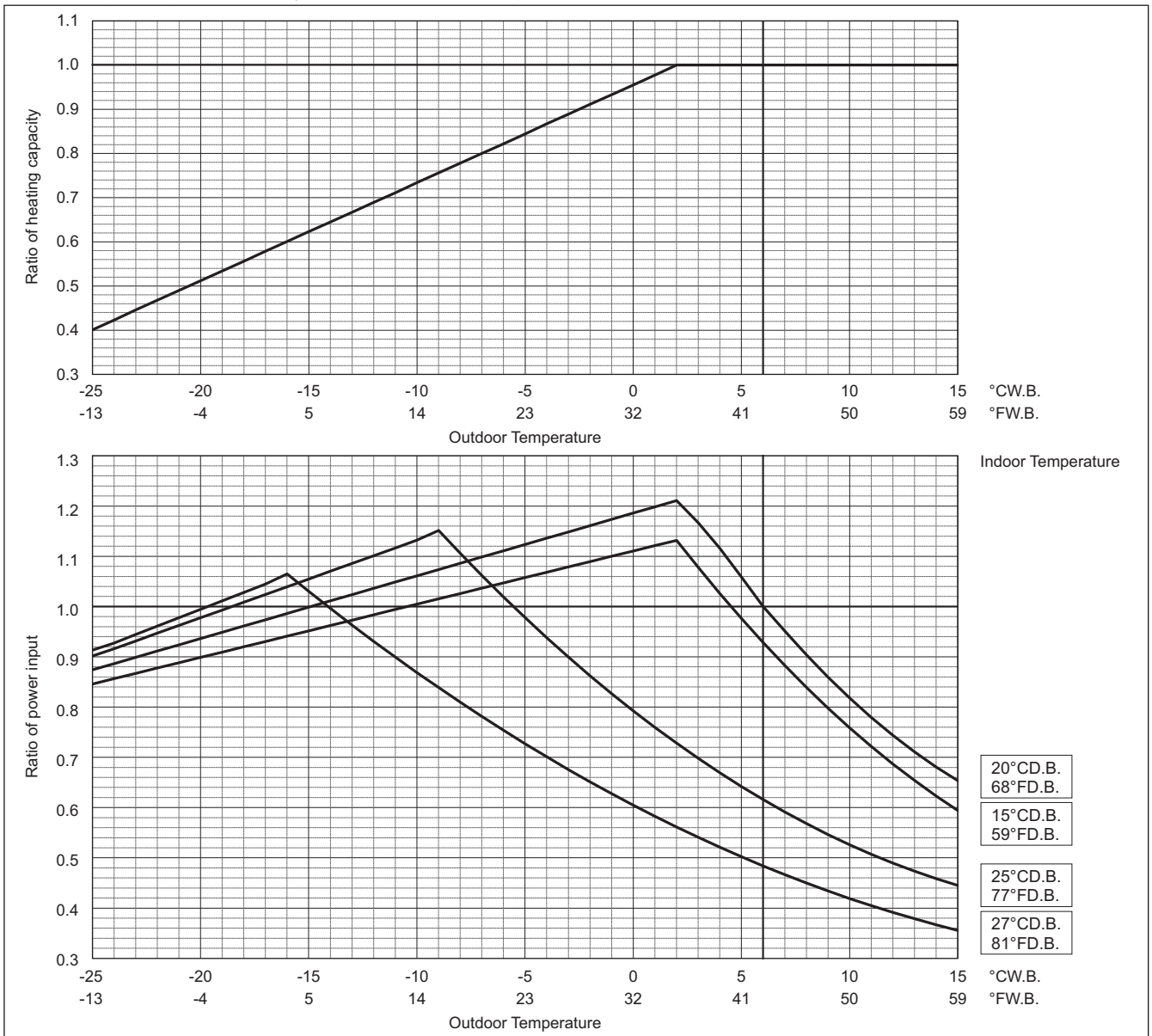

Correction by temperature (Cool toughness mode)

CITY MULTI could have various capacities at different designing temperatures. Using the nominal cooling/heating capacity values and the ratios below, the capacity can be found for various temperatures. To select cool toughness mode, SW4 (959) must be set to ON.

Cool toughness mode

PURY-		M200YXM-A
Cooling Capacity	kW	22.4
	BTU/h	76,400
Input	kW	5.53

Indoor unit temperature correction

To be used to correct indoor unit capacity only

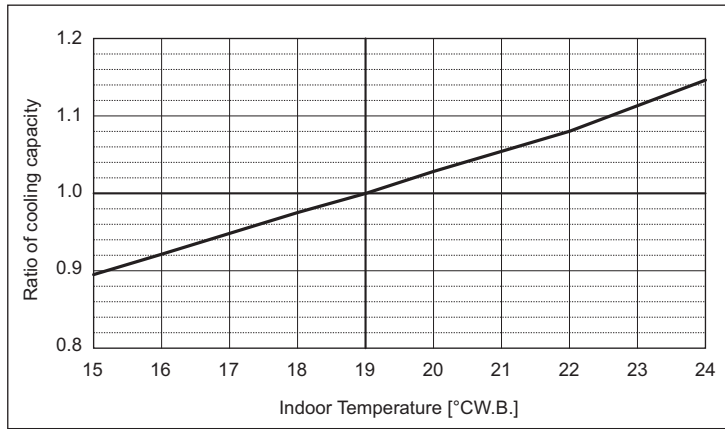

Outdoor unit temperature correction

To be used to correct outdoor unit only

Outdoor unit capacity is NOT affected by the indoor temperature.

Outdoor unit power input is affected by the indoor and outdoor temperatures. Please consult the sales office for details.

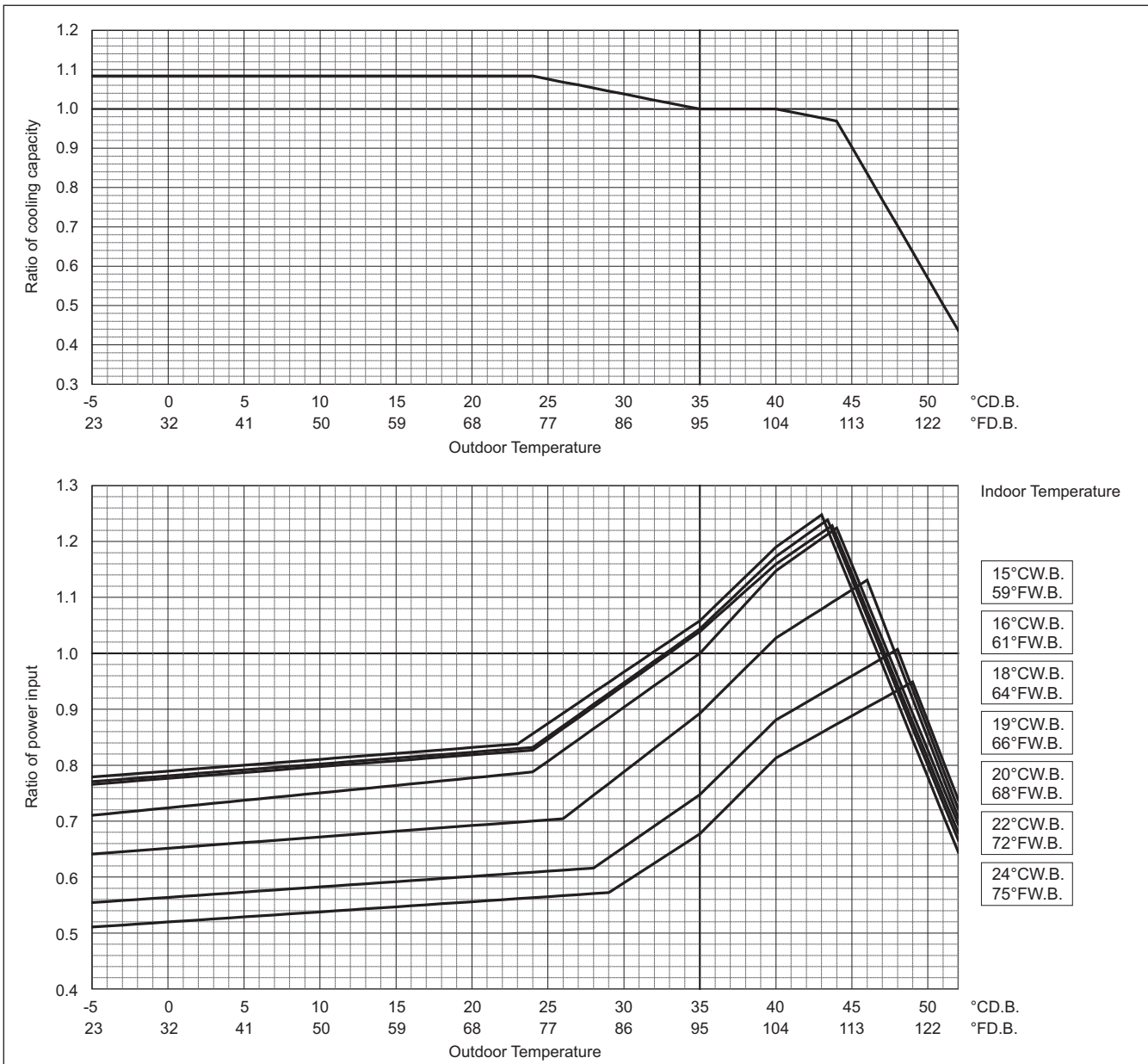

PURY-M-Y(S)XM-A

Cool toughness mode

	PURY-	M250YXM-A
Cooling Capacity	kW	28.0
	BTU/h	95,500
Input	kW	7.79

Indoor unit temperature correction

To be used to correct indoor unit capacity only

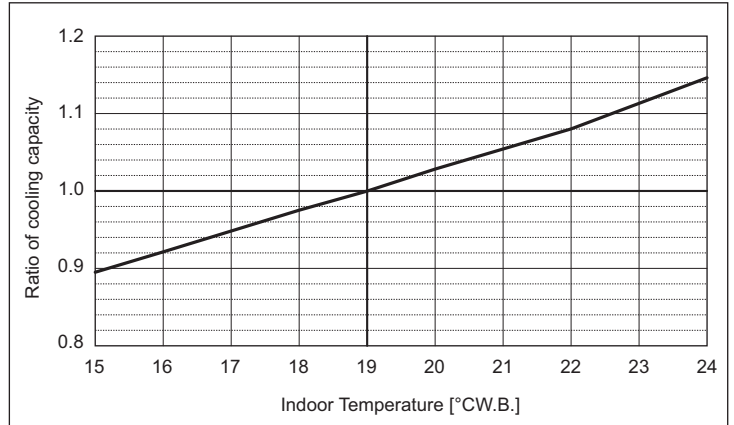

Outdoor unit temperature correction

To be used to correct outdoor unit only

Outdoor unit capacity is NOT affected by the indoor temperature.

Outdoor unit power input is affected by the indoor and outdoor temperatures. Please consult the sales office for details.

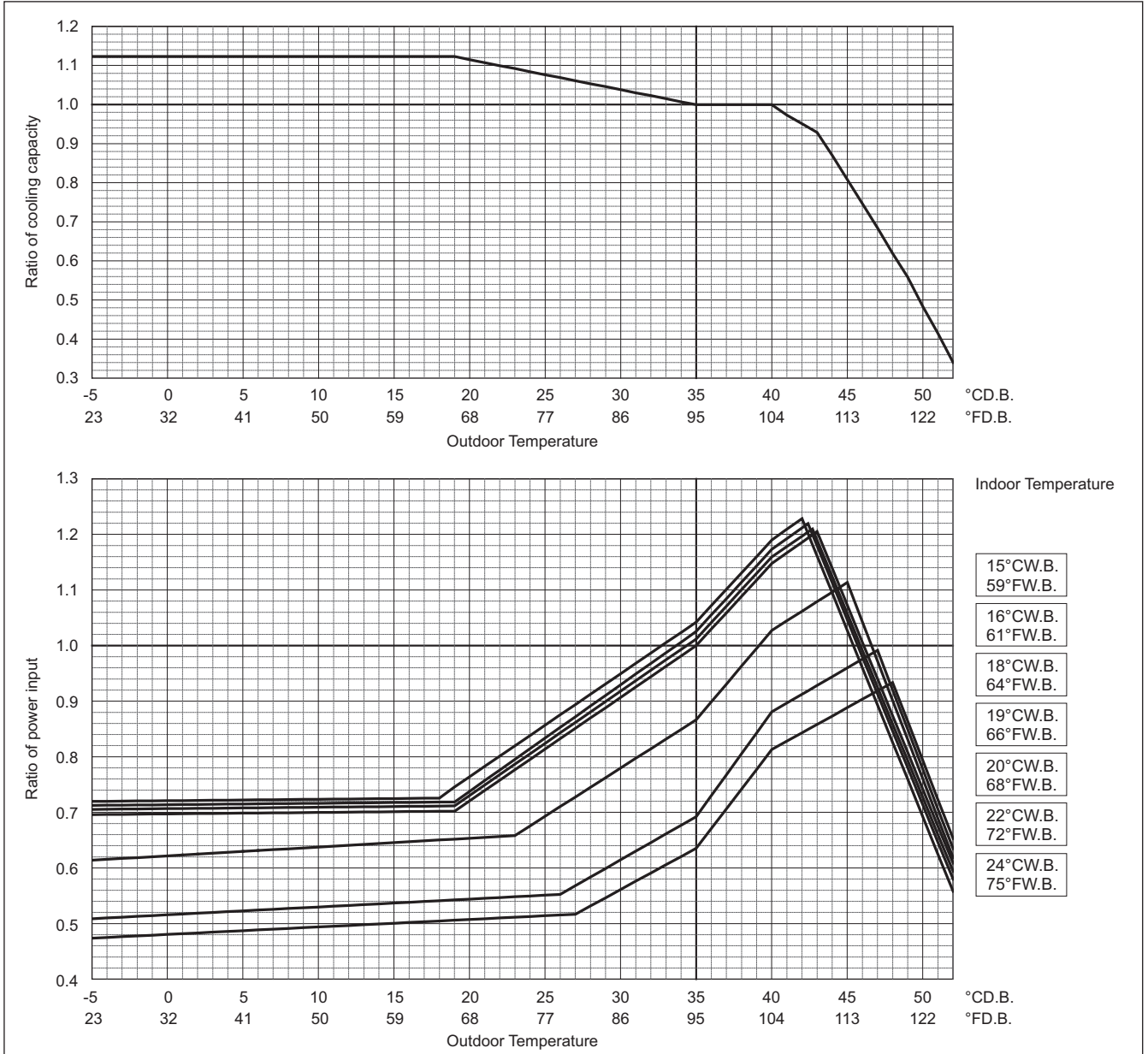

PURY-M-Y(S)XM-A

Cool toughness mode

PURY-		M300YXM-A
Cooling Capacity	kW	33.5
	BTU/h	114,300
Input	kW	9.43

Indoor unit temperature correction

To be used to correct indoor unit capacity only

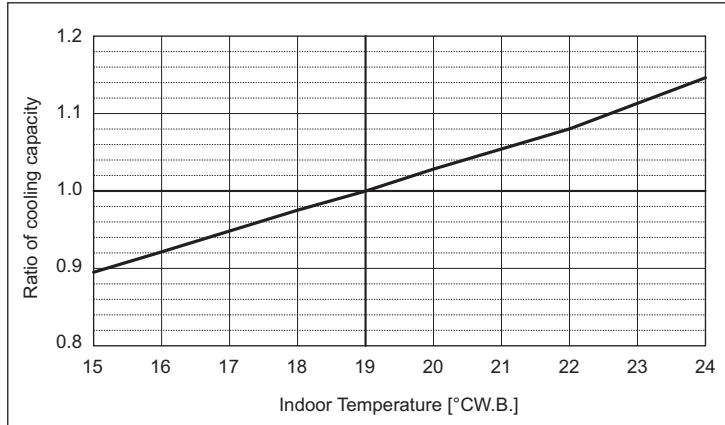

Outdoor unit temperature correction

To be used to correct outdoor unit only

Outdoor unit capacity is NOT affected by the indoor temperature.

Outdoor unit power input is affected by the indoor and outdoor temperatures. Please consult the sales office for details.

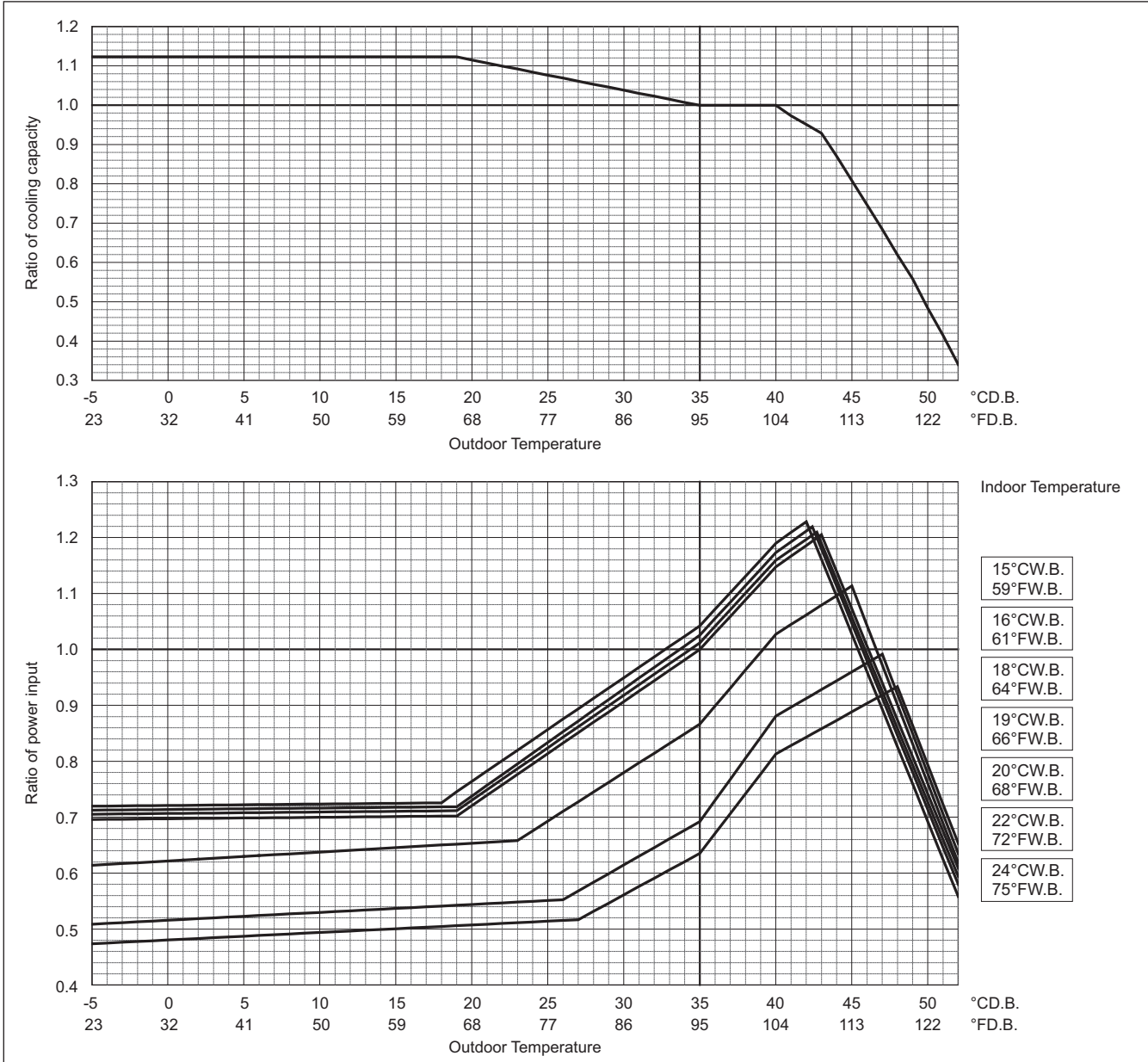

PURY-M-Y(S)XM-A

Cool toughness mode

	PURY-	M350YXM-A
Cooling Capacity	kW	40.0
	BTU/h	136,500
Input	kW	11.62

Indoor unit temperature correction

To be used to correct indoor unit capacity only

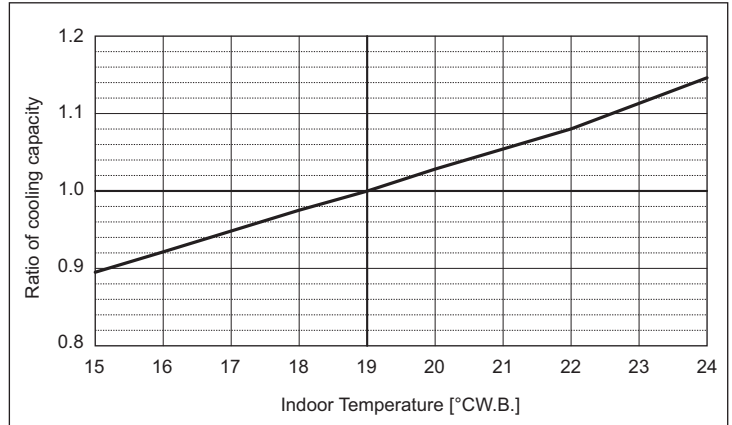

Outdoor unit temperature correction

To be used to correct outdoor unit only

Outdoor unit capacity is NOT affected by the indoor temperature.

Outdoor unit power input is affected by the indoor and outdoor temperatures. Please consult the sales office for details.

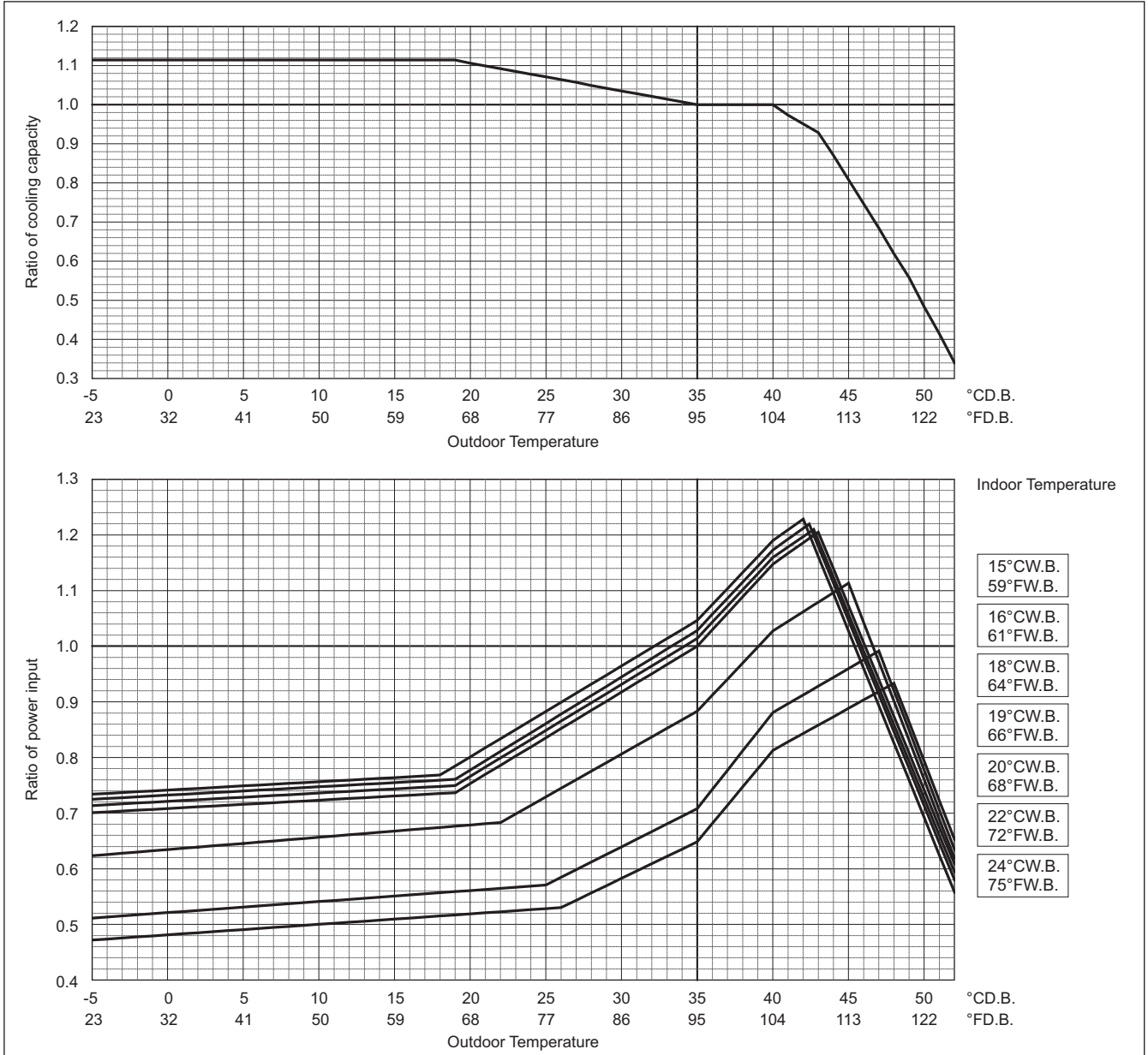

PURY-M-Y(S)XM-A

Cool toughness mode

PURY-		M400YXM-A
Cooling Capacity	kW	45.0
	BTU/h	153,500
Input	kW	13.39

Indoor unit temperature correction

To be used to correct indoor unit capacity only

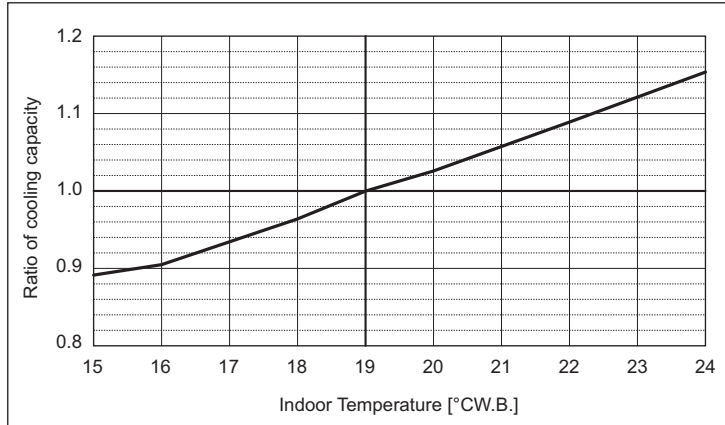

Outdoor unit temperature correction

To be used to correct outdoor unit only

Outdoor unit capacity is NOT affected by the indoor temperature.

Outdoor unit power input is affected by the indoor and outdoor temperatures. Please consult the sales office for details.

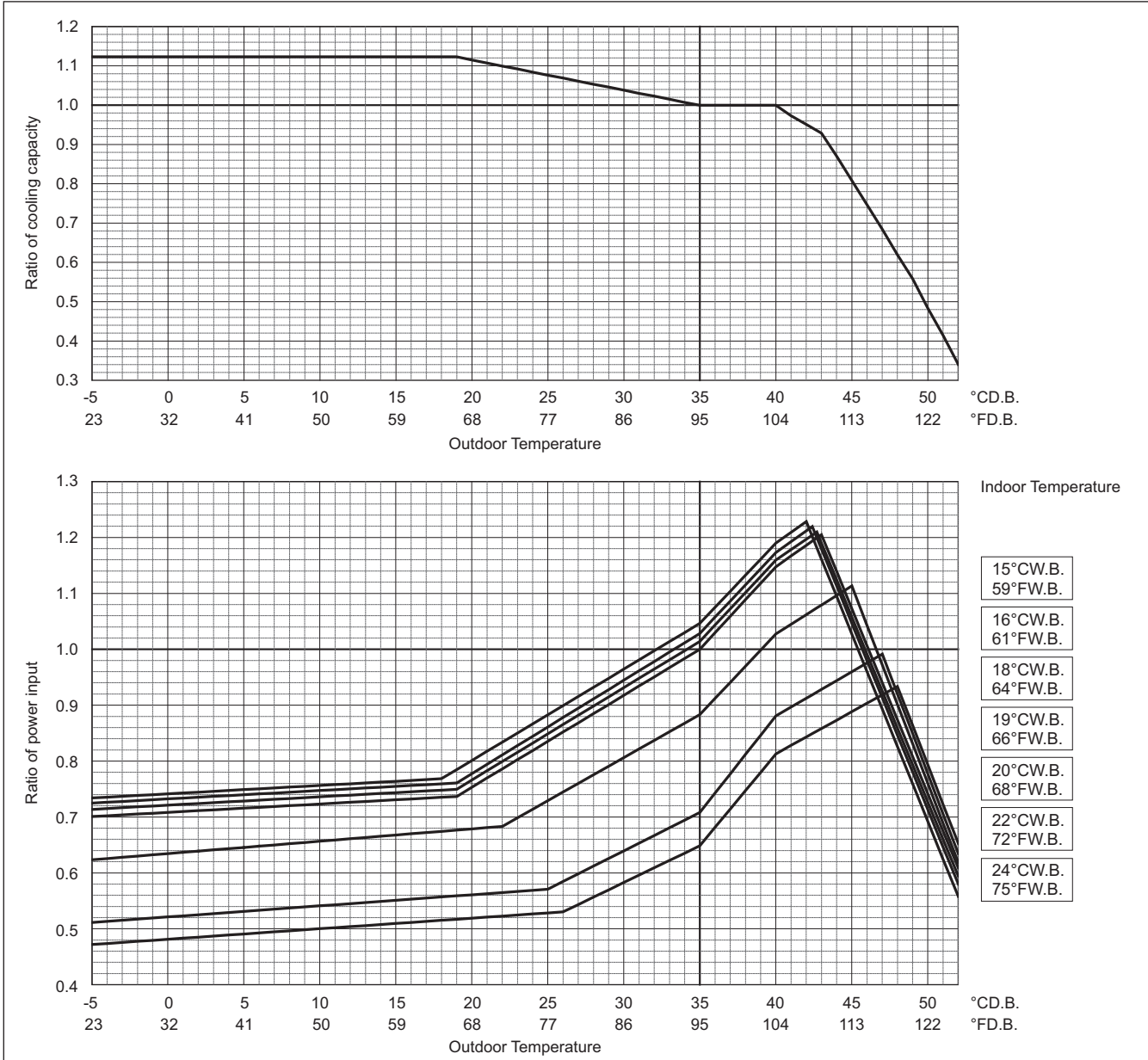

PURY-M-Y(S)XM-A

Cool toughness mode

	PURY-	M450YXM-A
Cooling Capacity	kW	50.0
	BTU/h	170,600
Input	kW	15.47

Indoor unit temperature correction

To be used to correct indoor unit capacity only

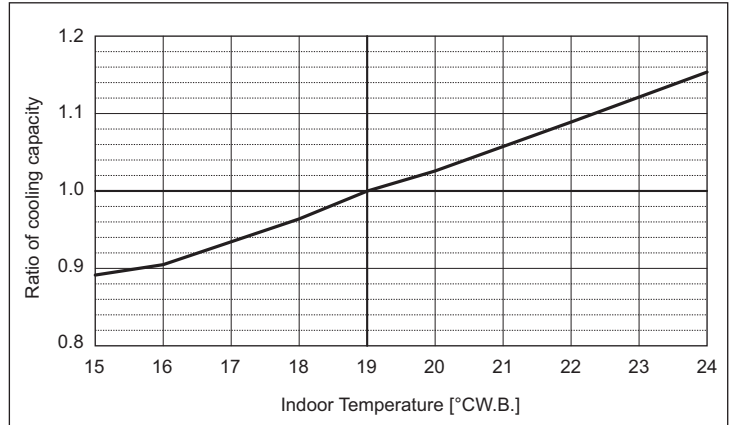

Outdoor unit temperature correction

To be used to correct outdoor unit only

Outdoor unit capacity is NOT affected by the indoor temperature.

Outdoor unit power input is affected by the indoor and outdoor temperatures. Please consult the sales office for details.

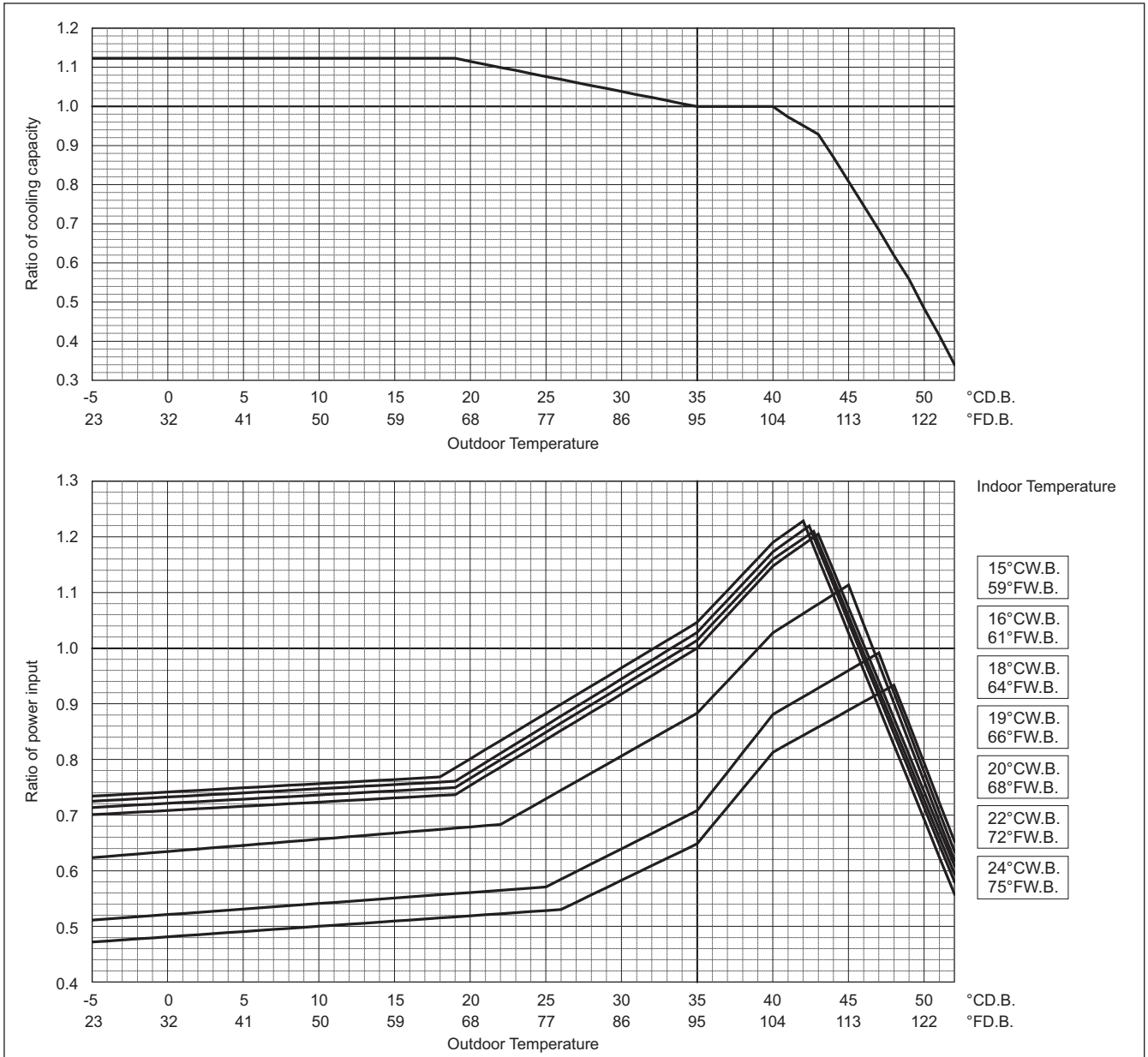

PURY-M-Y(S)XM-A

Cool toughness mode

PURY-		M400YSXM-A
Cooling Capacity	kW	44.8
	BTU/h	152,900
Input	kW	11.17

Indoor unit temperature correction

To be used to correct indoor unit capacity only

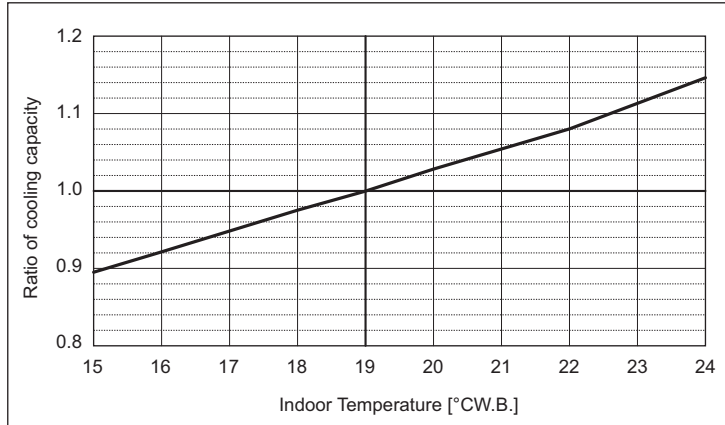

Outdoor unit temperature correction

To be used to correct outdoor unit only

Outdoor unit capacity is NOT affected by the indoor temperature.

Outdoor unit power input is affected by the indoor and outdoor temperatures. Please consult the sales office for details.

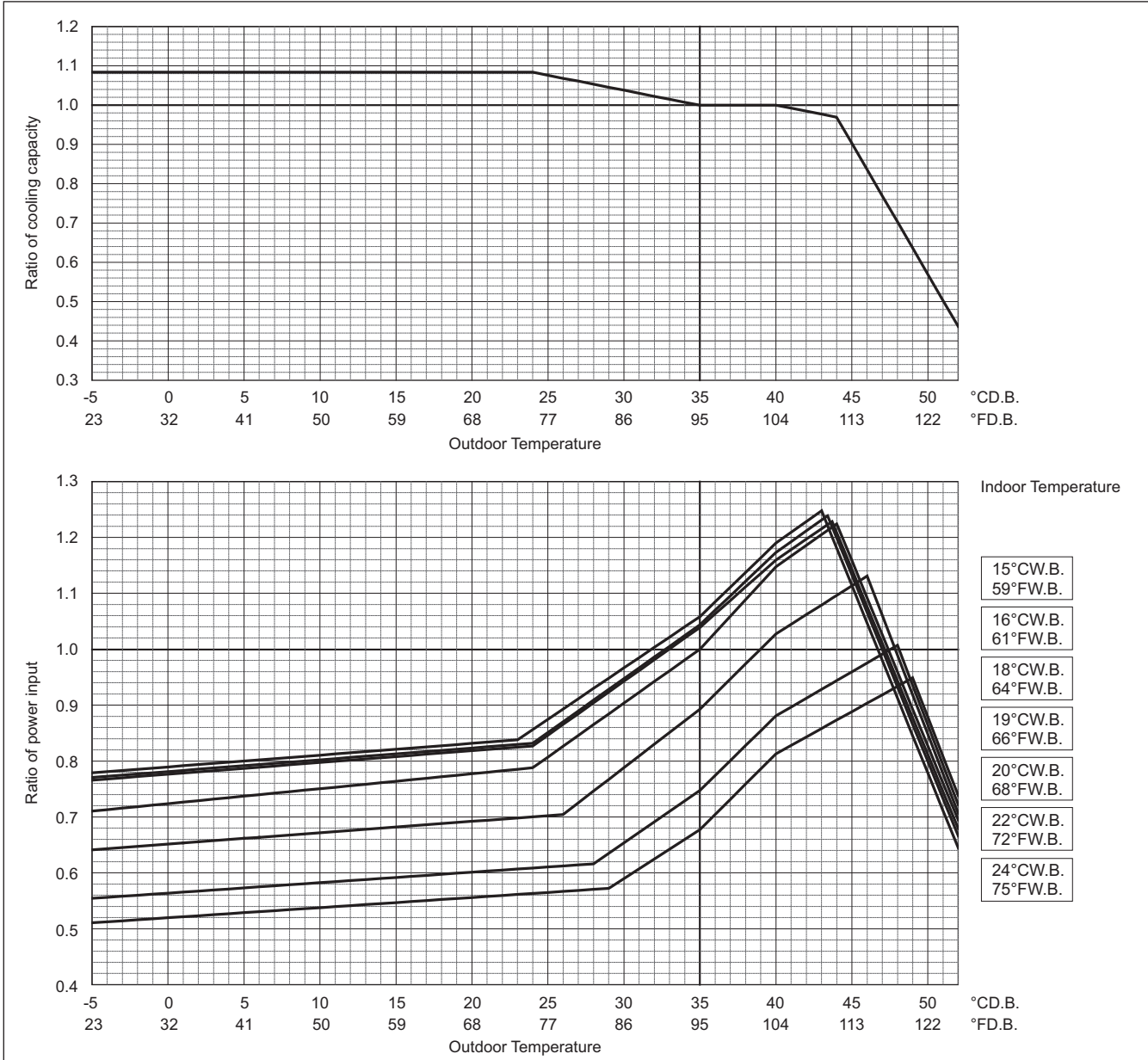

PURY-M-Y(S)XM-A

Cool toughness mode

	PURY-	M450YSXM-A
Cooling Capacity	kW	50.4
	BTU/h	172,000
Input	kW	13.44

Indoor unit temperature correction

To be used to correct indoor unit capacity only

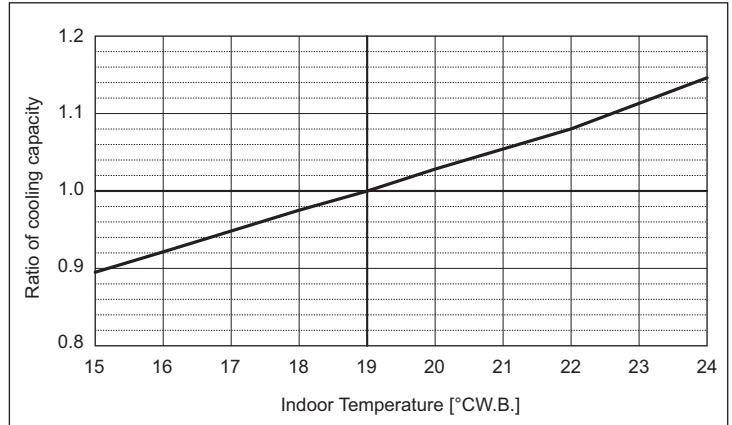

Outdoor unit temperature correction

To be used to correct outdoor unit only

Outdoor unit capacity is NOT affected by the indoor temperature.

Outdoor unit power input is affected by the indoor and outdoor temperatures. Please consult the sales office for details.

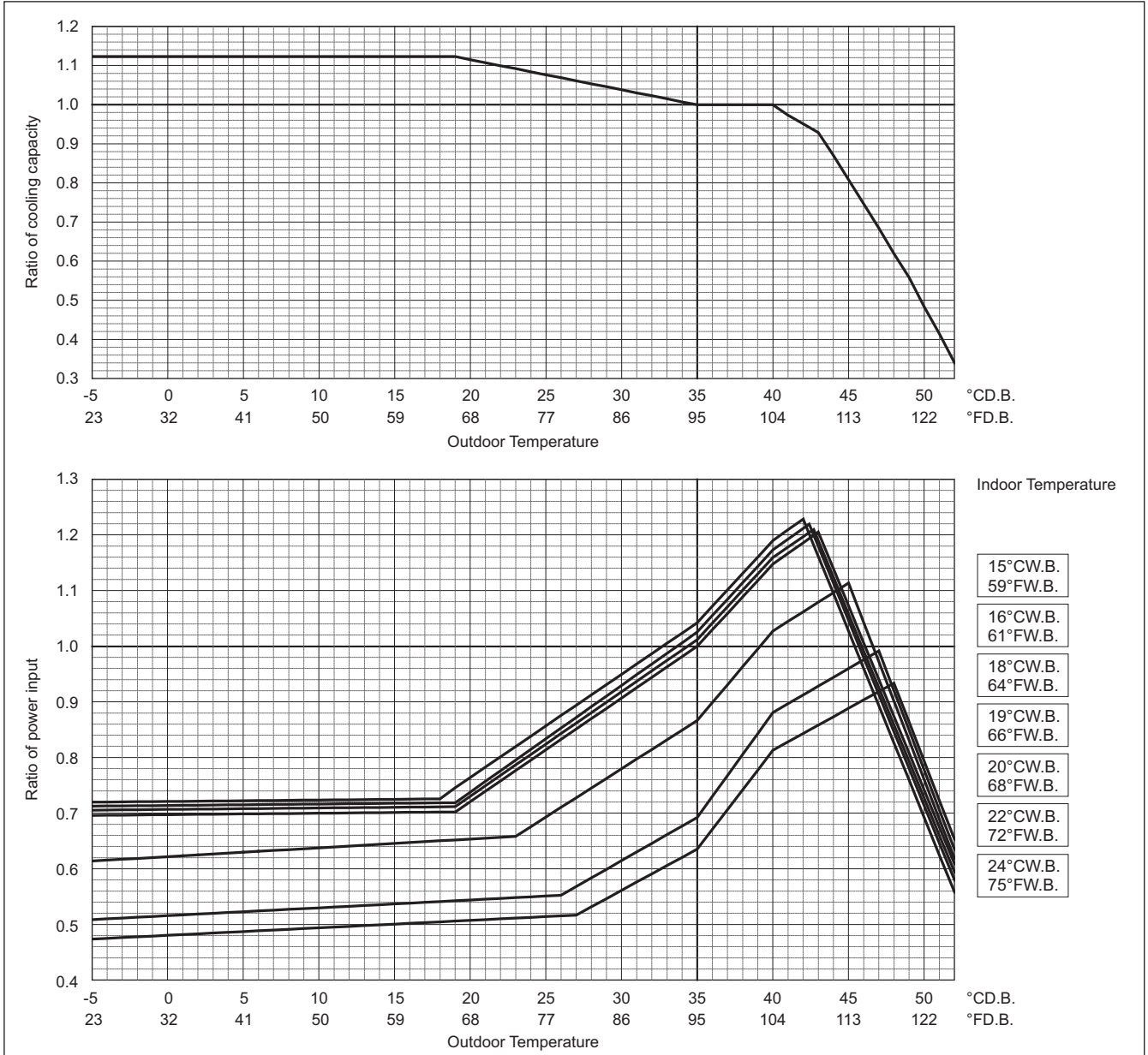

PURY-M-Y(S)XM-A

Cool toughness mode

PURY-		M500YSXM-A
Cooling Capacity	kW	56.0
	BTU/h	191,100
Input	kW	16.00

Indoor unit temperature correction

To be used to correct indoor unit capacity only

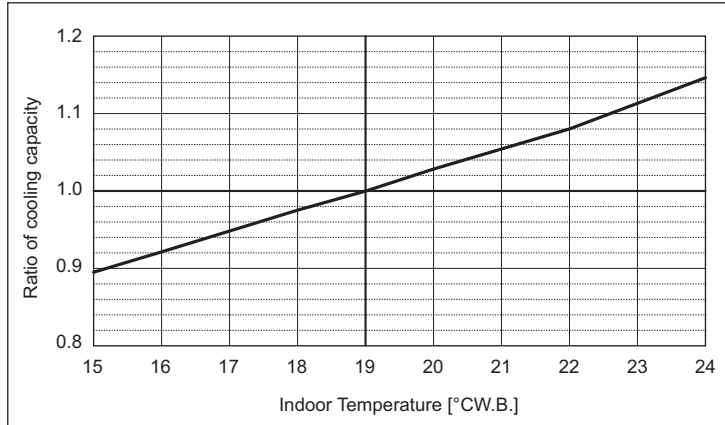

Outdoor unit temperature correction

To be used to correct outdoor unit only

Outdoor unit capacity is NOT affected by the indoor temperature.

Outdoor unit power input is affected by the indoor and outdoor temperatures. Please consult the sales office for details.

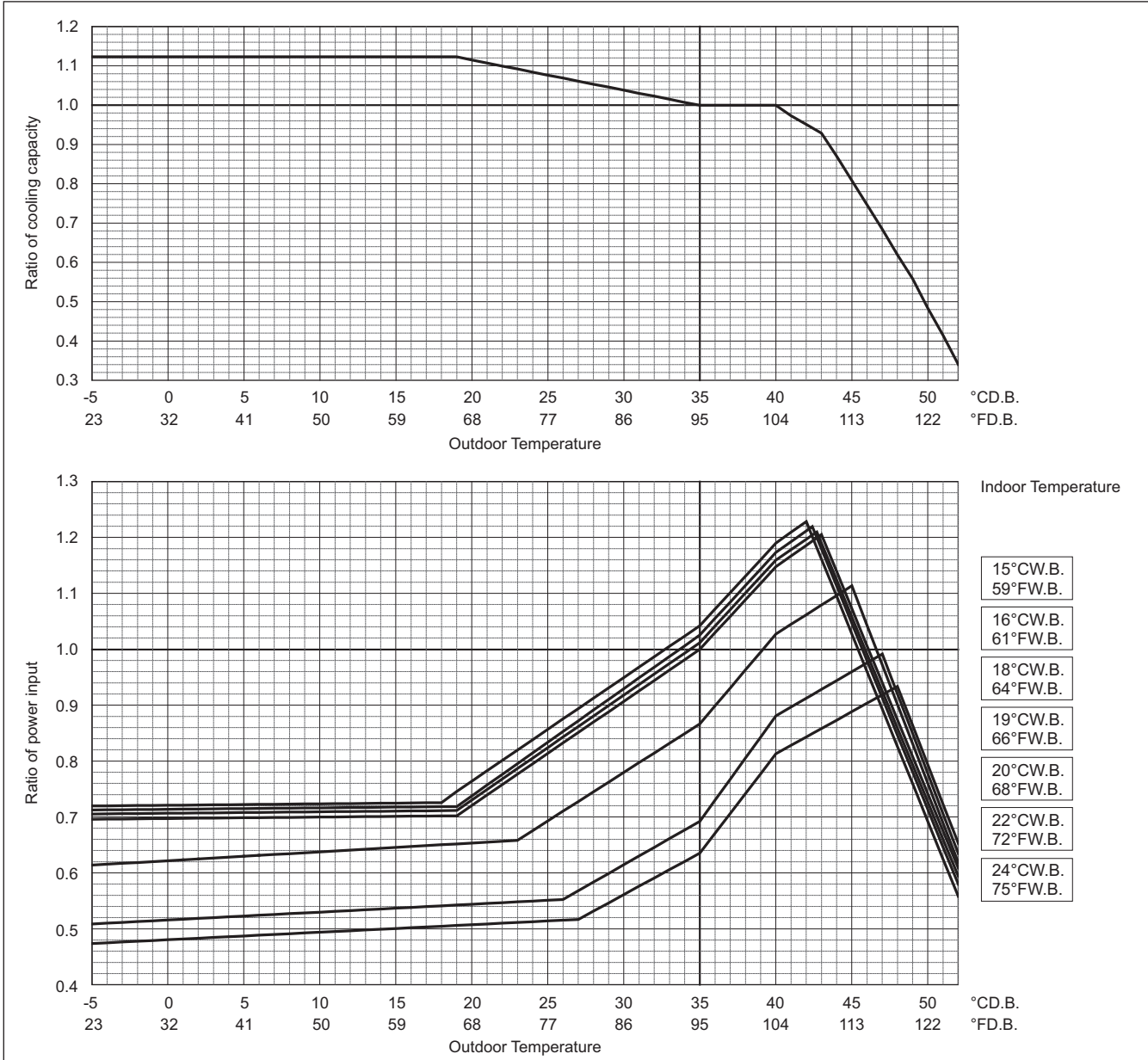

PURY-M-Y(S)XM-A

Cool toughness mode

	PURY-	M550YSXM-A
Cooling Capacity	kW	61.5
	BTU/h	209,800
Input	kW	17.67

Indoor unit temperature correction

To be used to correct indoor unit capacity only

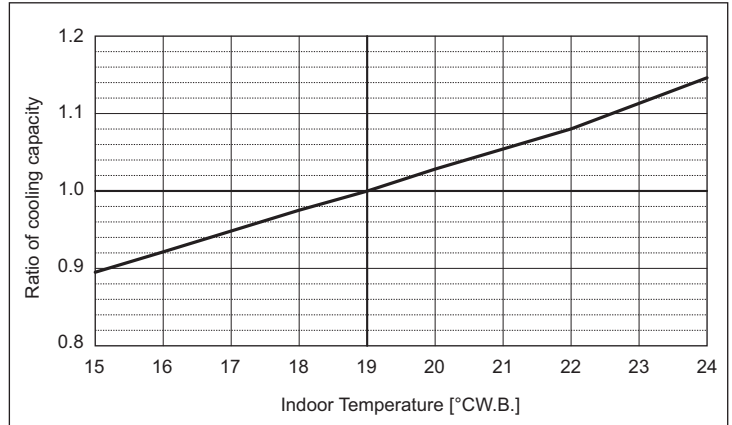

Outdoor unit temperature correction

To be used to correct outdoor unit only

Outdoor unit capacity is NOT affected by the indoor temperature.

Outdoor unit power input is affected by the indoor and outdoor temperatures. Please consult the sales office for details.

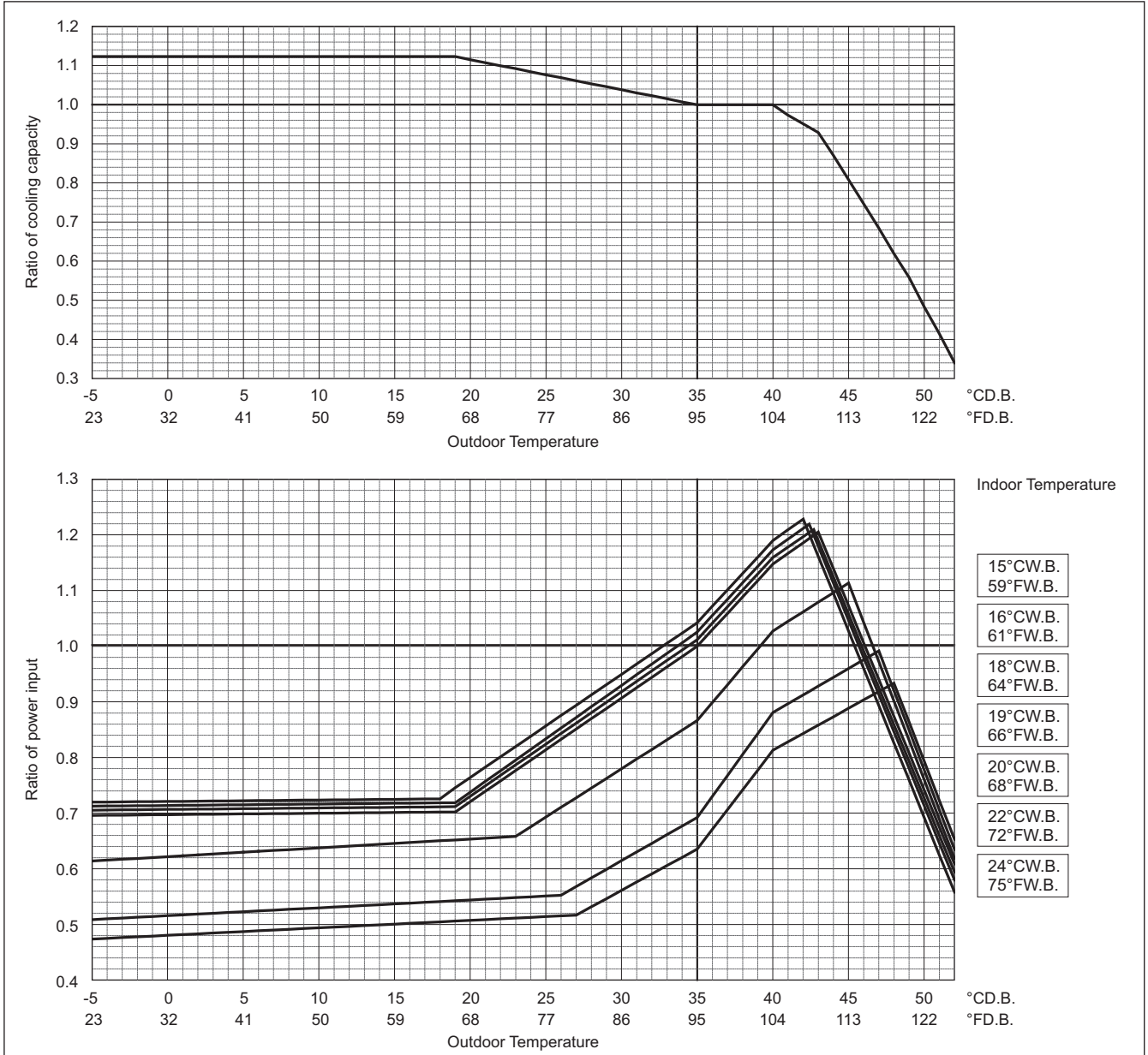

PURY-M-Y(S)XM-A

Cool toughness mode

PURY-		M600YSXM-A
Cooling Capacity	kW	67.0
	BTU/h	228,600
Input	kW	19.36

Indoor unit temperature correction

To be used to correct indoor unit capacity only

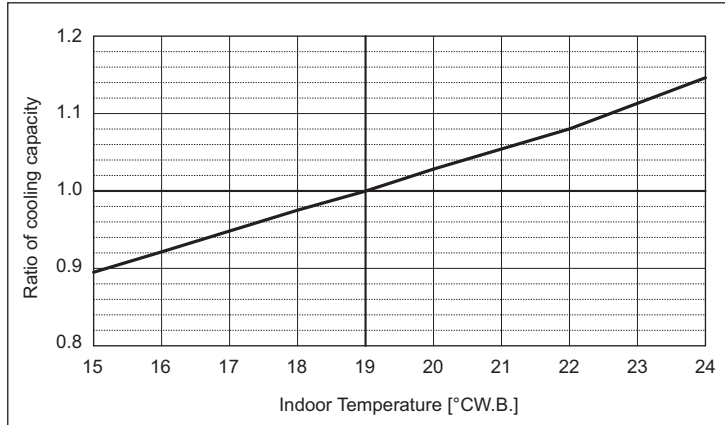

Outdoor unit temperature correction

To be used to correct outdoor unit only

Outdoor unit capacity is NOT affected by the indoor temperature.

Outdoor unit power input is affected by the indoor and outdoor temperatures. Please consult the sales office for details.

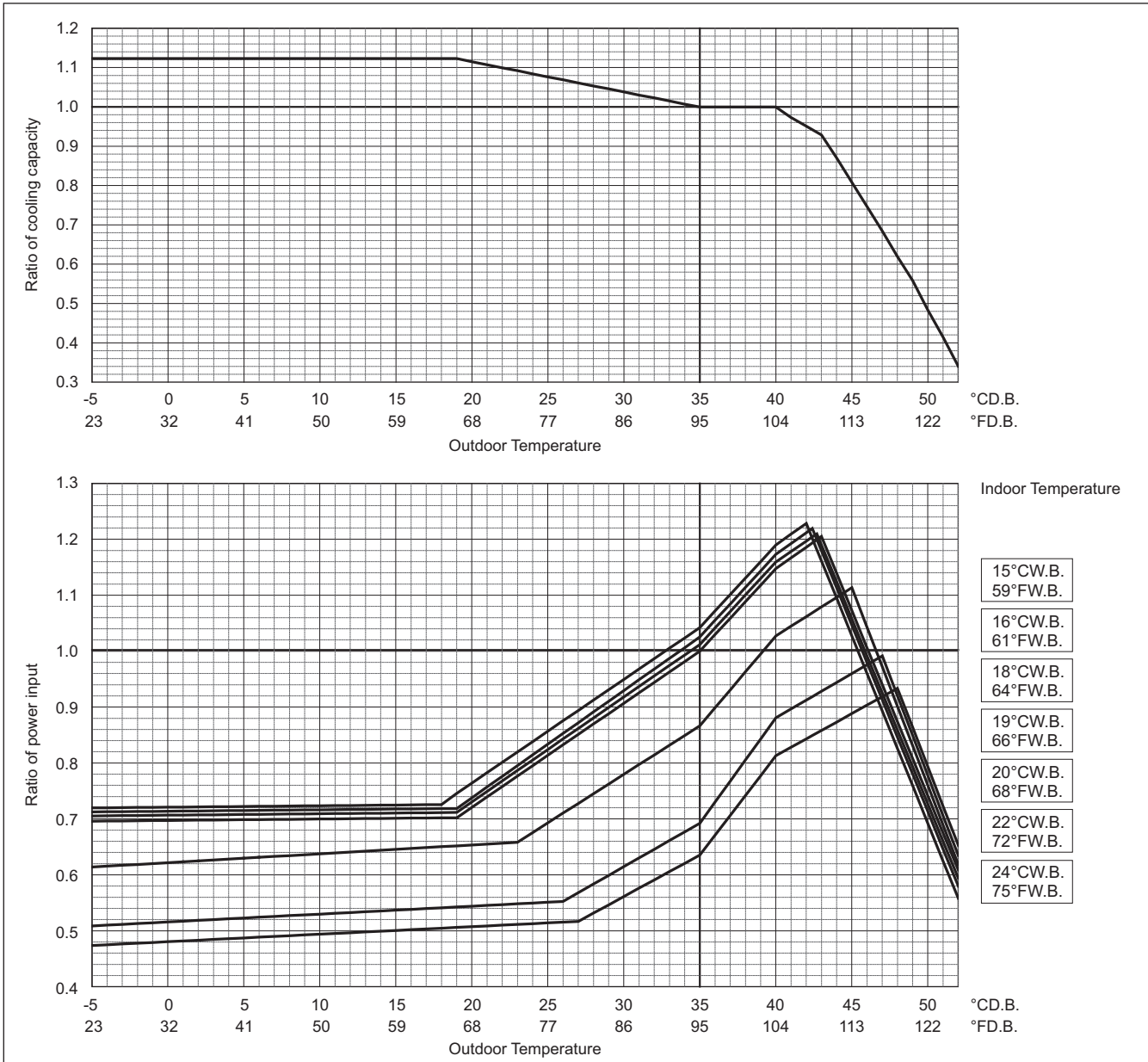

PURY-M-Y(S)XM-A

Cool toughness mode

	PURY-	M650YSXM-A
Cooling Capacity	kW	73.5
	BTU/h	250,800
Input	kW	21.87

Indoor unit temperature correction

To be used to correct indoor unit capacity only

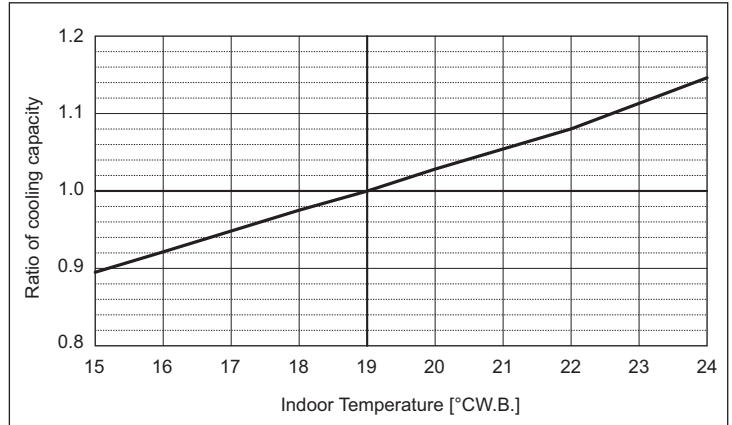

Outdoor unit temperature correction

To be used to correct outdoor unit only

Outdoor unit capacity is NOT affected by the indoor temperature.

Outdoor unit power input is affected by the indoor and outdoor temperatures. Please consult the sales office for details.

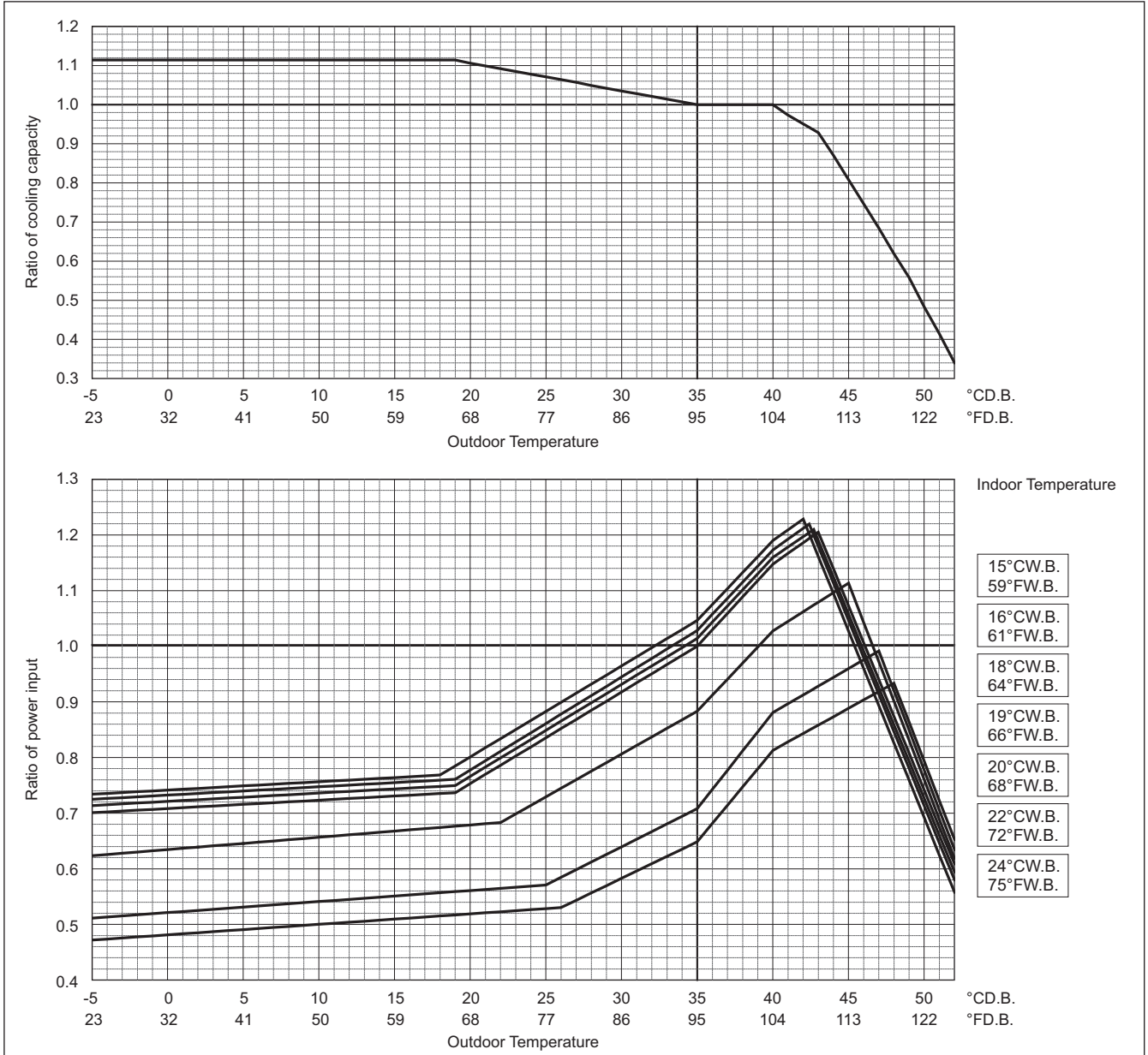

PURY-M-Y(S)XM-A

Cool toughness mode

PURY-		M700YSXM-A
Cooling Capacity	kW	80.0
	BTU/h	273,000
Input	kW	23.80

Indoor unit temperature correction

To be used to correct indoor unit capacity only

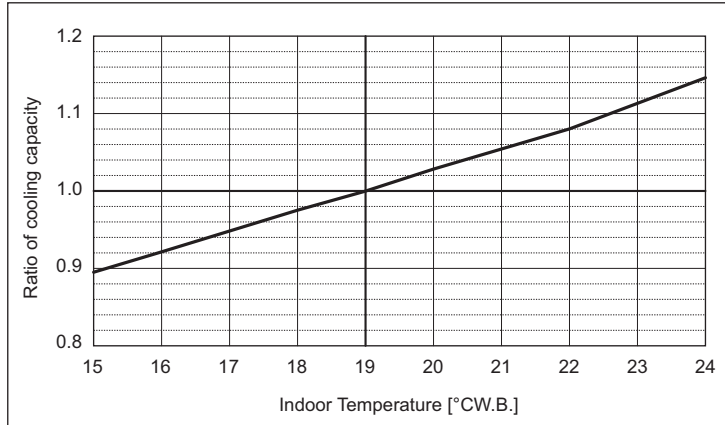

Outdoor unit temperature correction

To be used to correct outdoor unit only

Outdoor unit capacity is NOT affected by the indoor temperature.

Outdoor unit power input is affected by the indoor and outdoor temperatures. Please consult the sales office for details.

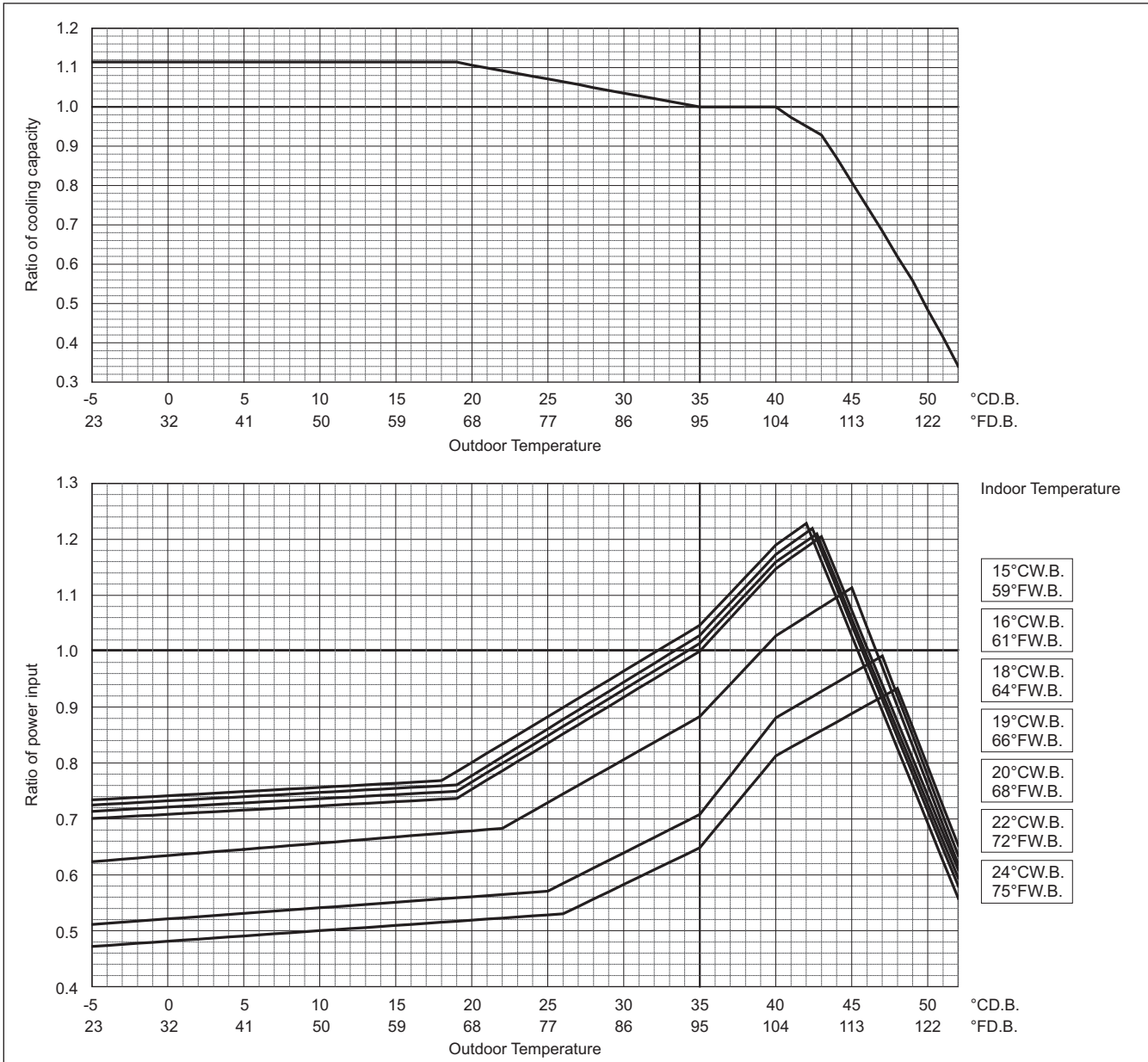

PURY-M-Y(S)XM-A

Cool toughness mode

	PURY-	M750YSXM-A
Cooling Capacity	kW	85.0
	BTU/h	290,000
Input	kW	25.67

Indoor unit temperature correction

To be used to correct indoor unit capacity only

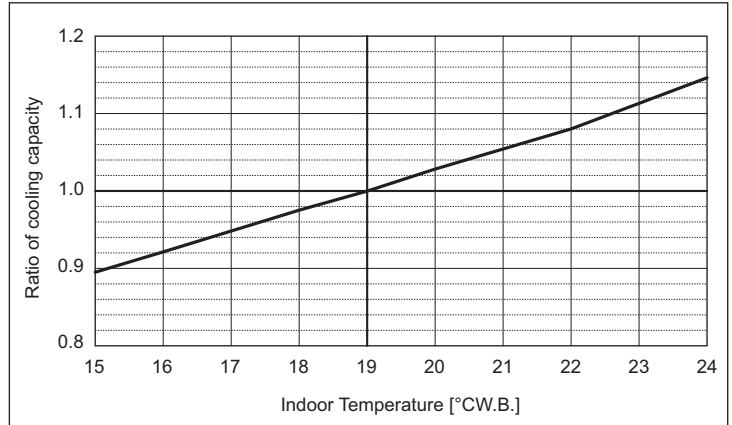

Outdoor unit temperature correction

To be used to correct outdoor unit only

Outdoor unit capacity is NOT affected by the indoor temperature.

Outdoor unit power input is affected by the indoor and outdoor temperatures. Please consult the sales office for details.

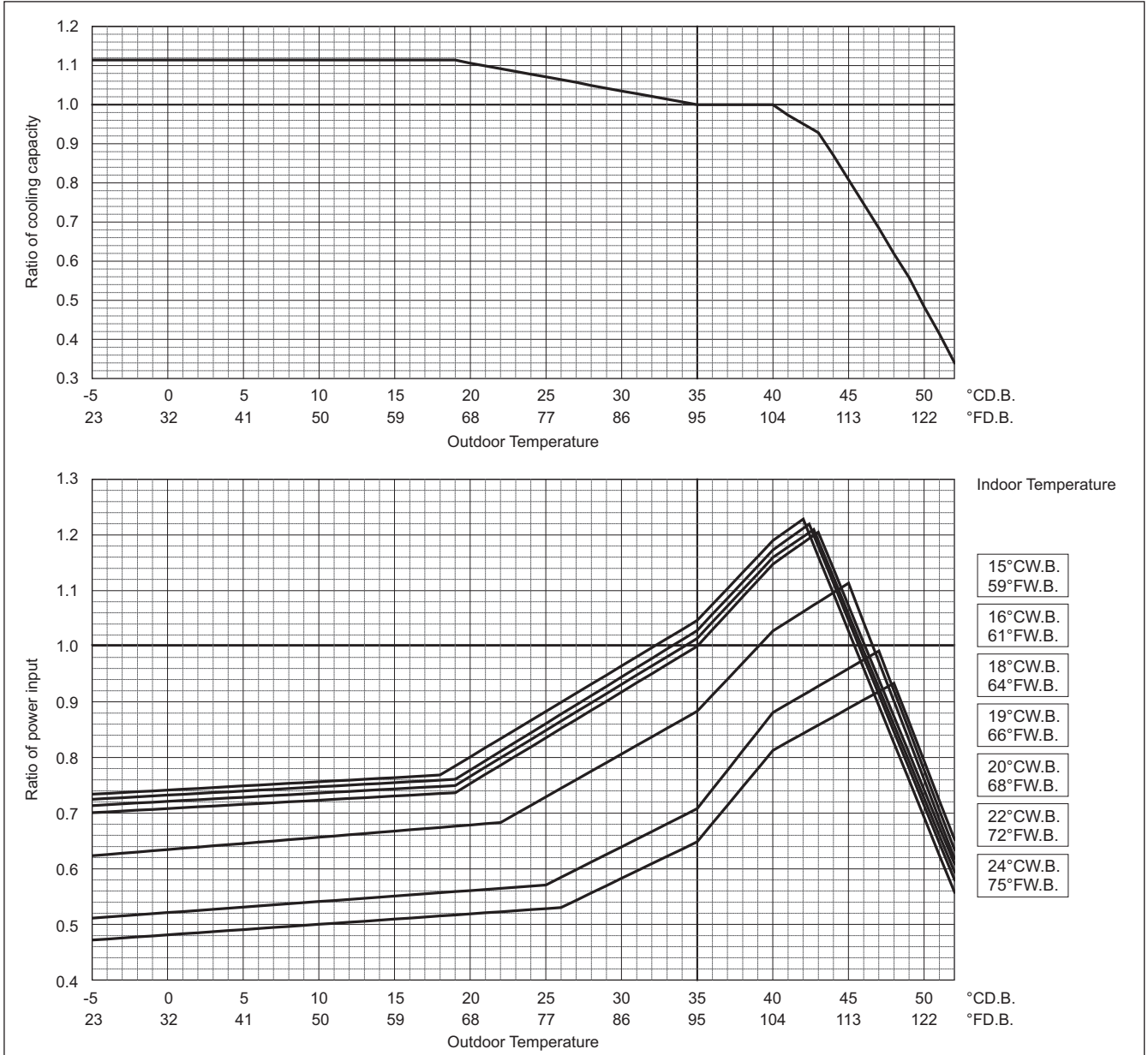

PURY-M-Y(S)XM-A

Cool toughness mode

PURY-		M800YSXM-A
Cooling Capacity	kW	90.0
	BTU/h	307,100
Input	kW	27.60

Indoor unit temperature correction

To be used to correct indoor unit capacity only

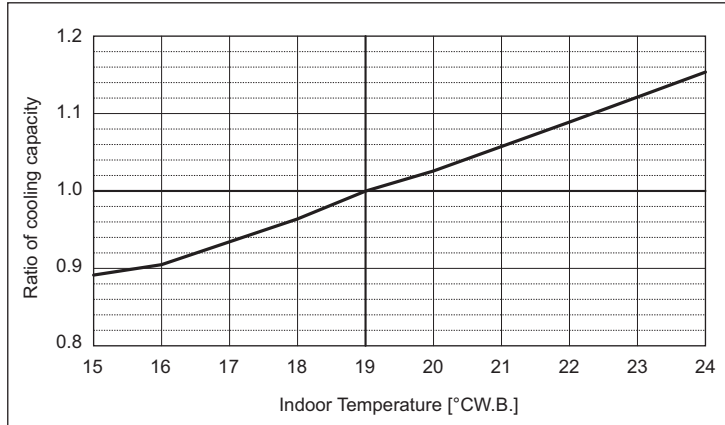

Outdoor unit temperature correction

To be used to correct outdoor unit only

Outdoor unit capacity is NOT affected by the indoor temperature.

Outdoor unit power input is affected by the indoor and outdoor temperatures. Please consult the sales office for details.

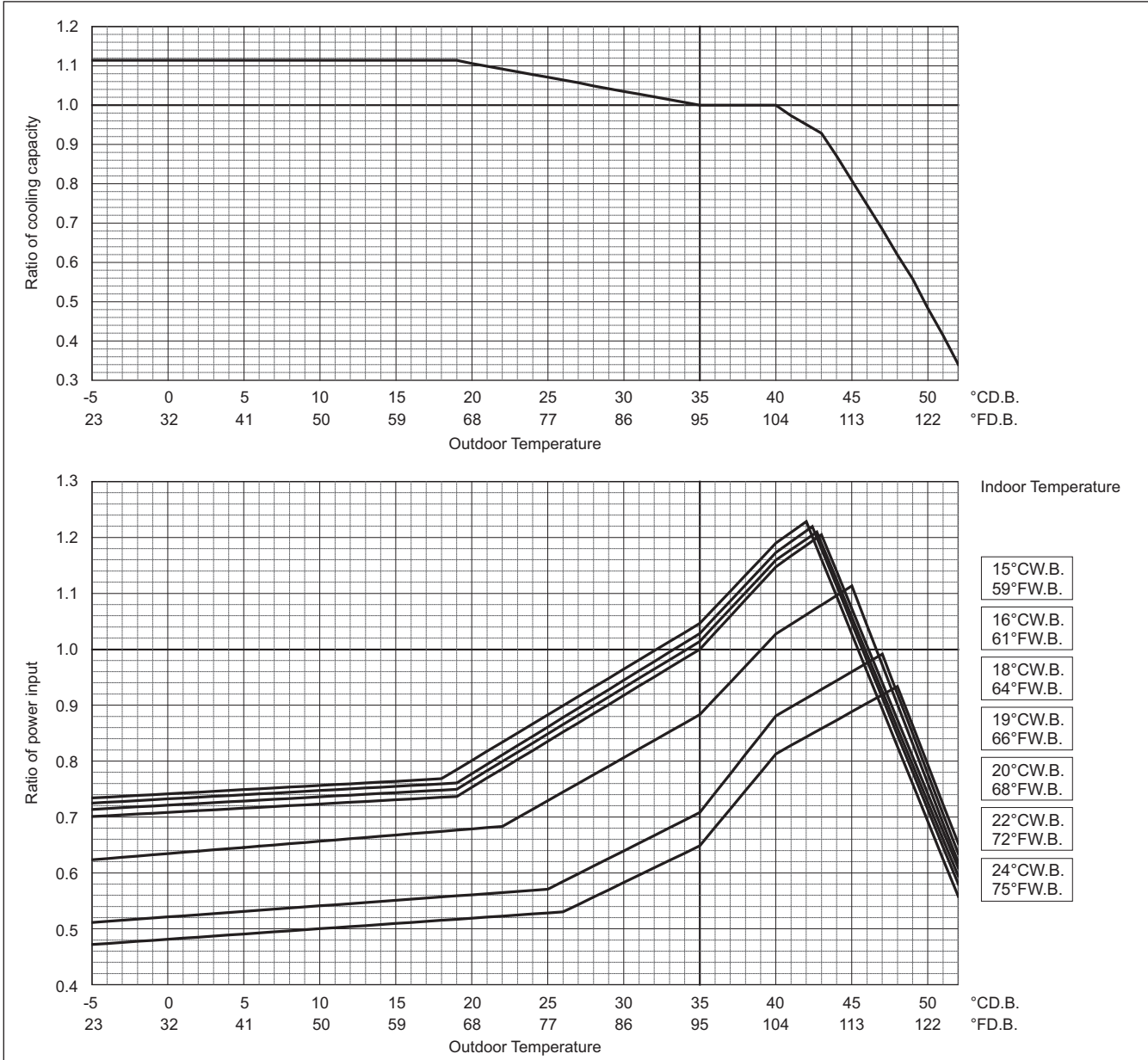

PURY-M-Y(S)XM-A

Cool toughness mode

	PURY-	M850YSXM-A
Cooling Capacity	kW	95.0
	BTU/h	324,100
Input	kW	29.59

Indoor unit temperature correction

To be used to correct indoor unit capacity only

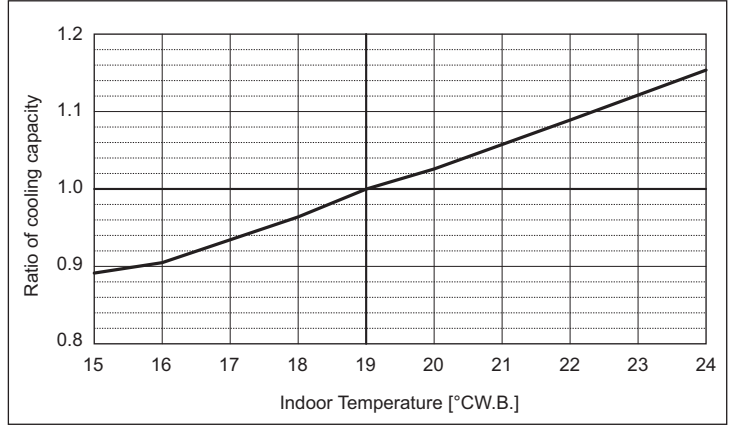

Outdoor unit temperature correction

To be used to correct outdoor unit only

Outdoor unit capacity is NOT affected by the indoor temperature.

Outdoor unit power input is affected by the indoor and outdoor temperatures. Please consult the sales office for details.

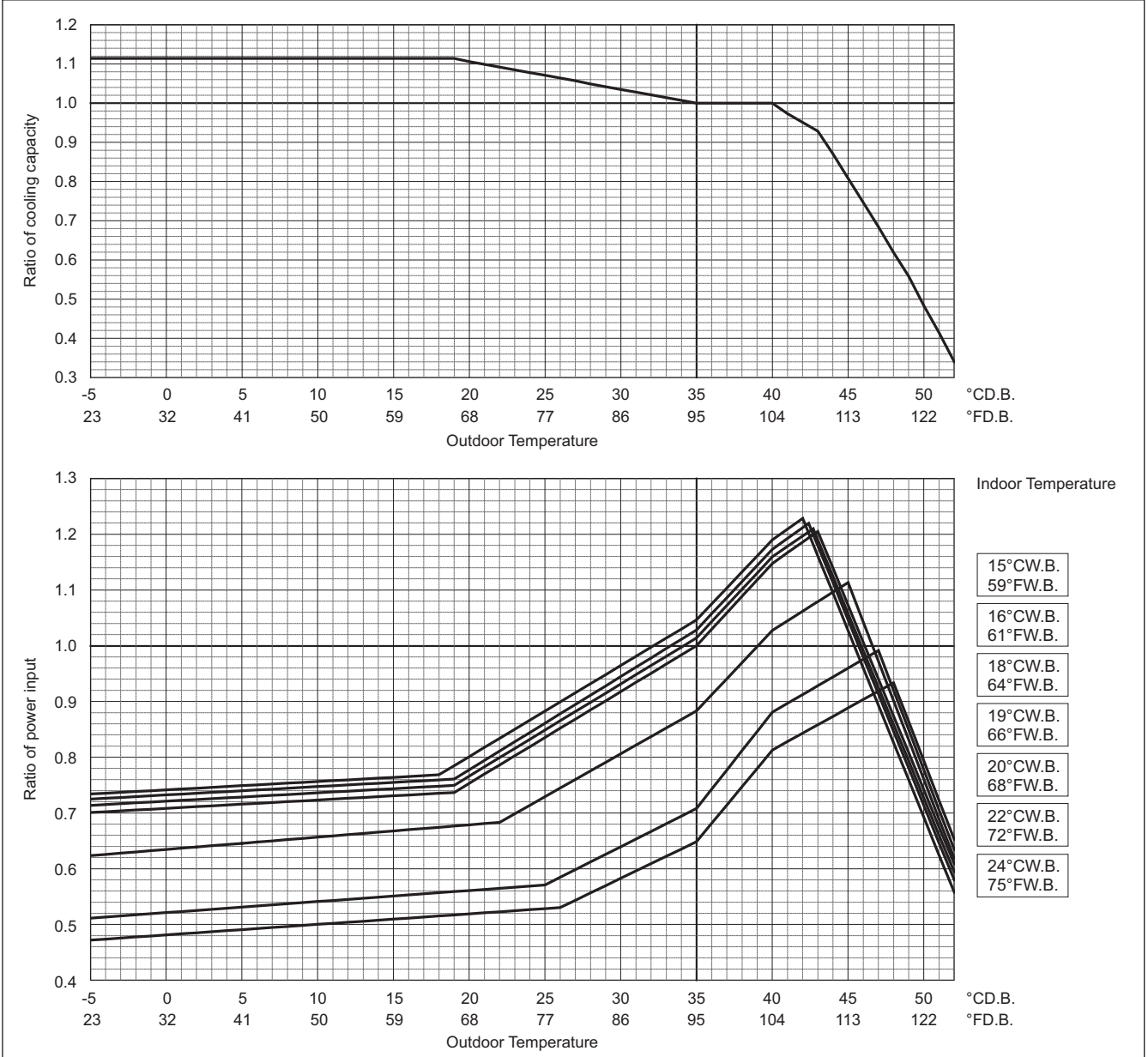

PURY-M-Y(S)XM-A

Cool toughness mode

	PURY-	M900YSXM-A
Cooling Capacity	kW	100.0
	BTU/h	341,200
Input	kW	31.94

Indoor unit temperature correction

To be used to correct indoor unit capacity only

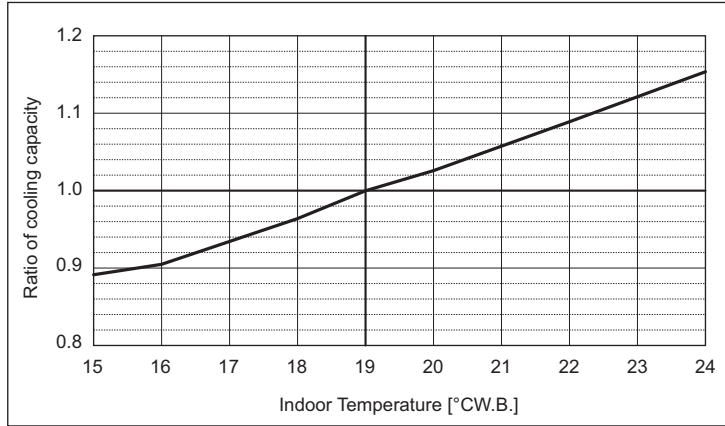

Outdoor unit temperature correction

To be used to correct outdoor unit only

Outdoor unit capacity is NOT affected by the indoor temperature.

Outdoor unit power input is affected by the indoor and outdoor temperatures. Please consult the sales office for details.

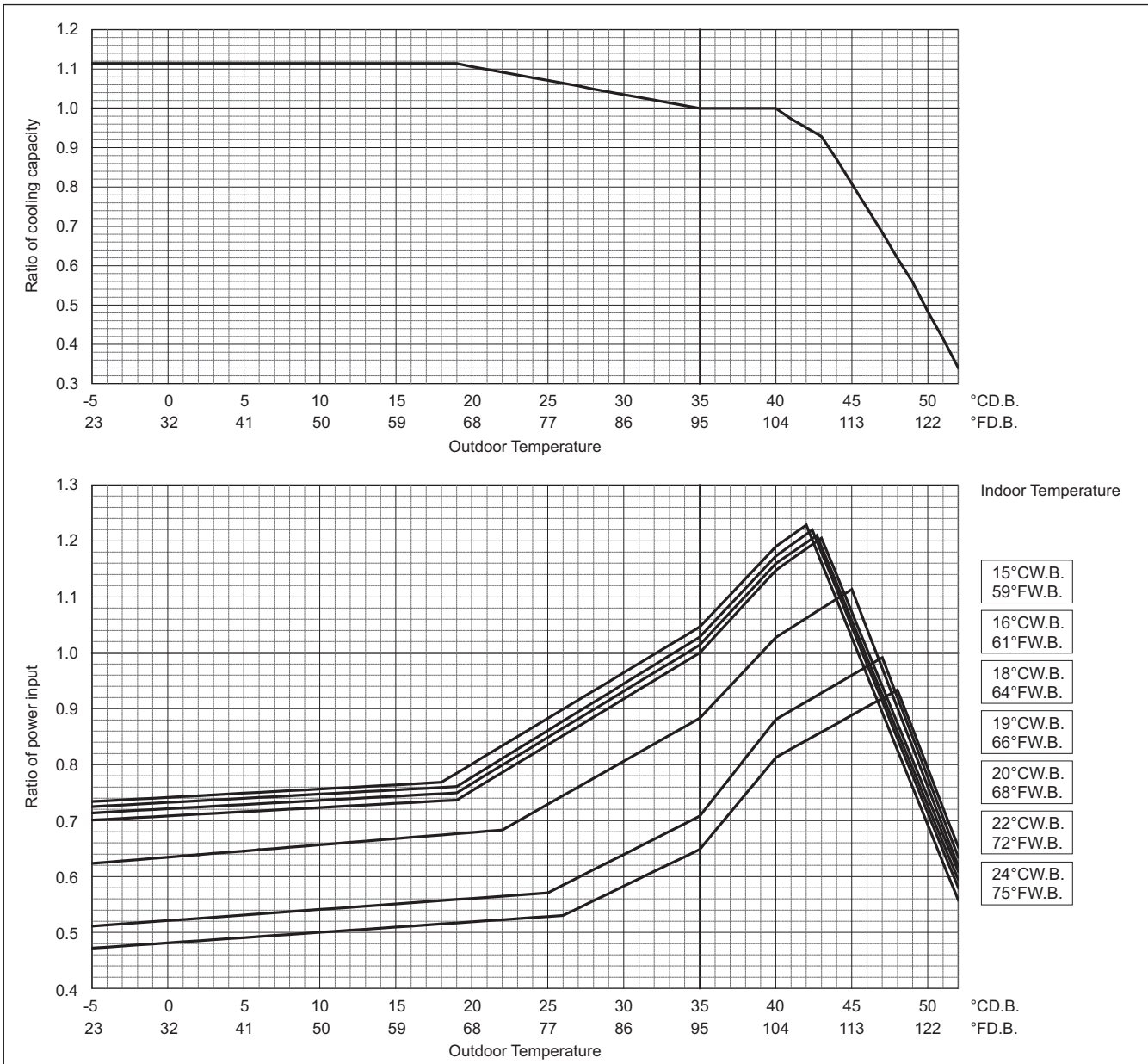

PURY-M-Y(S)XM-A

Correction by temperature (Heating COP priority mode)

CITY MULTI could have various capacities at different designing temperatures. Using the nominal cooling/heating capacity values and the ratios below, the capacity can be found for various temperatures. To select heating COP priority mode, SW4 (857) must be set to ON.

COP Priority Mode

	PURY-	M200YXM-A
Heating Capacity	kW	25.0
	BTU/h	85,300
Input	kW	5.65

Indoor unit temperature correction

To be used to correct indoor unit capacity only

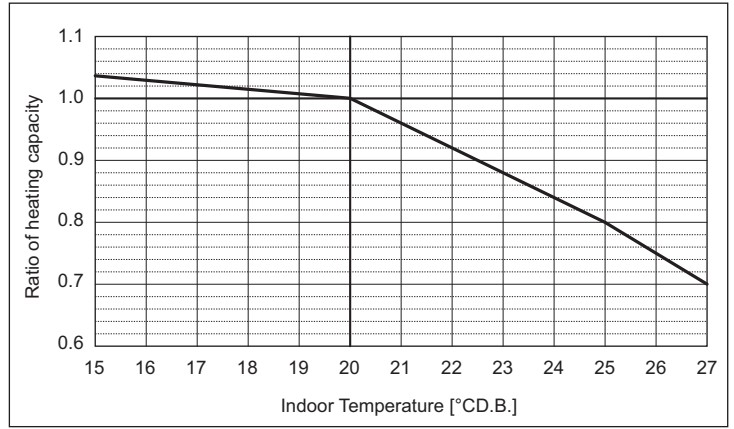

Outdoor unit temperature correction

To be used to correct outdoor unit only

Outdoor unit capacity is NOT affected by the indoor temperature.

Outdoor unit power input is affected by the indoor and outdoor temperatures. Please consult the sales office for details.

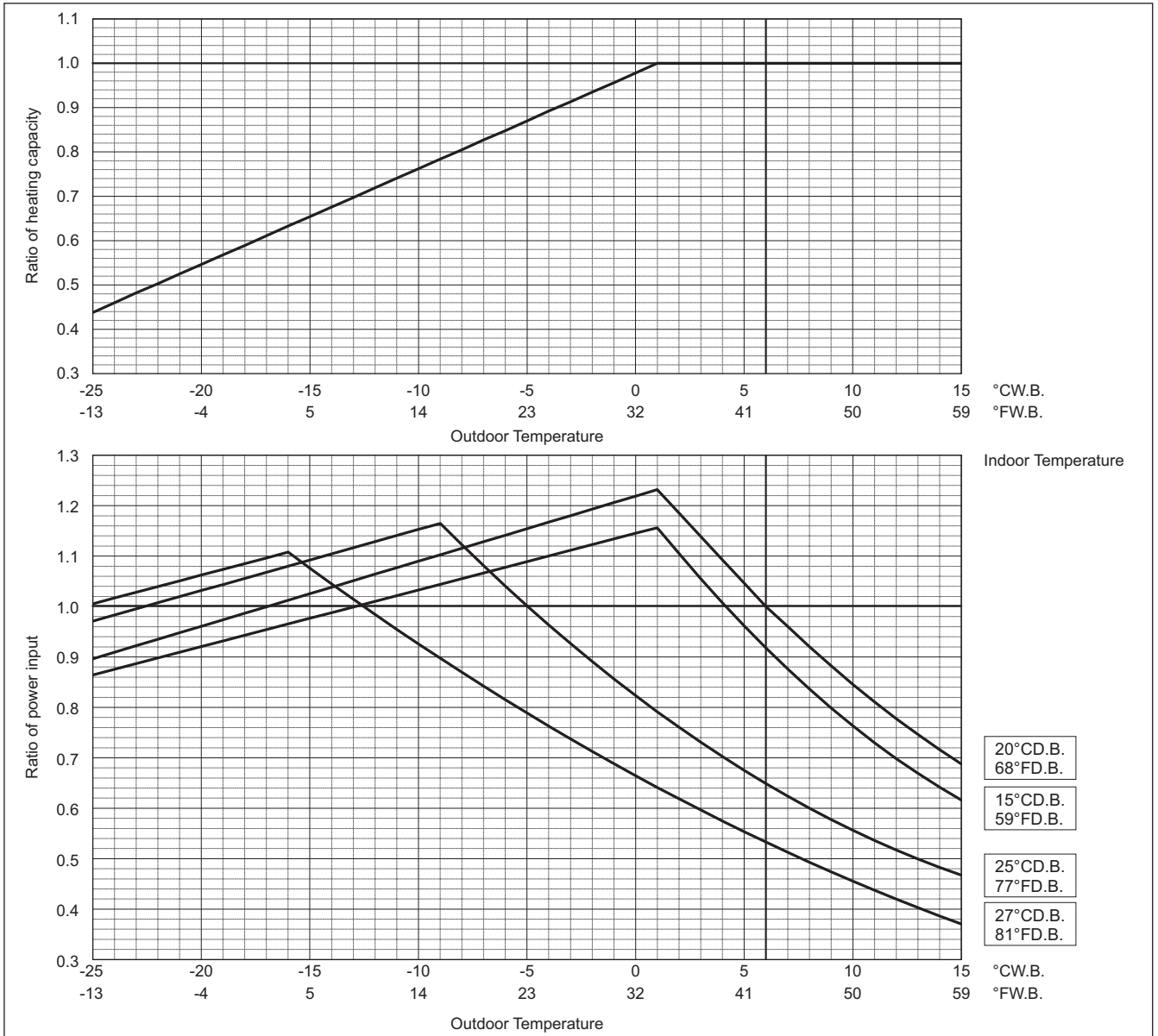

PURY-M-Y(S)XM-A

COP Priority Mode

	PURY-	M250YXM-A
Heating Capacity	kW	31.5
Capacity	BTU/h	107,500
Input	kW	7.79

Indoor unit temperature correction

To be used to correct indoor unit capacity only

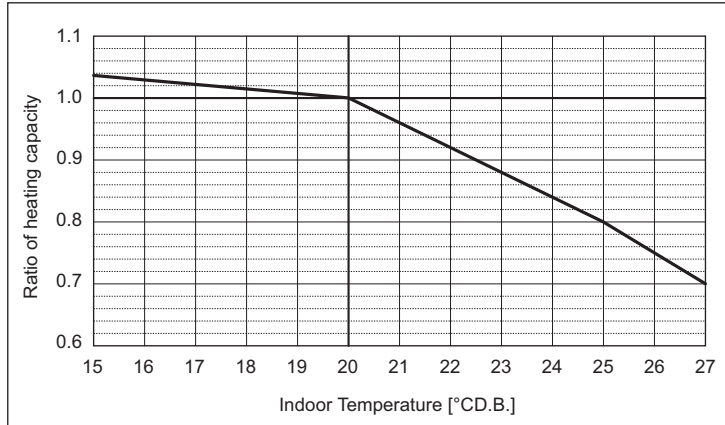

Outdoor unit temperature correction

To be used to correct outdoor unit only

Outdoor unit capacity is NOT affected by the indoor temperature.

Outdoor unit power input is affected by the indoor and outdoor temperatures. Please consult the sales office for details.

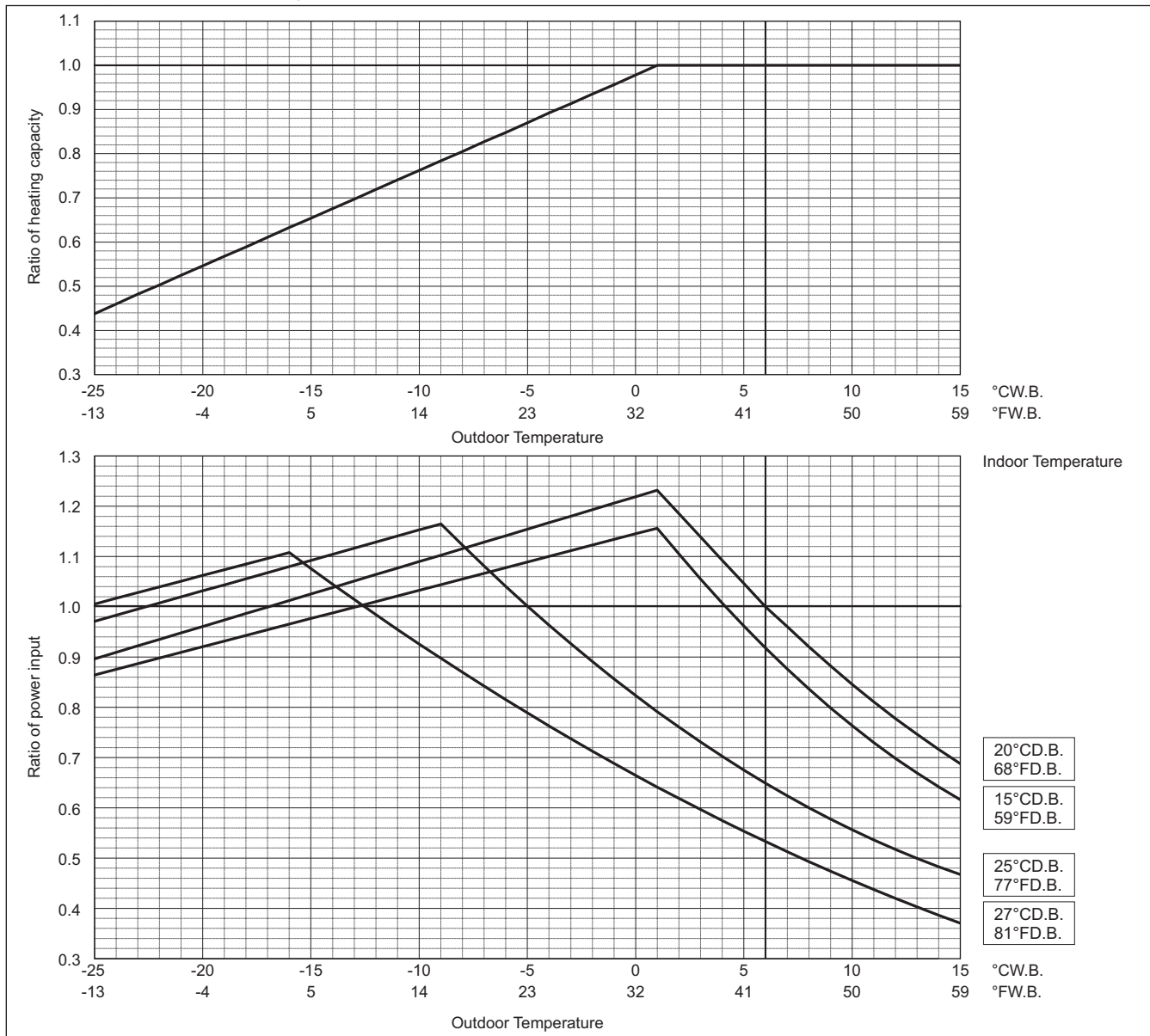

PURY-M-Y(S)XM-A

COP Priority Mode

	PURY-	M300YXM-A
Heating Capacity	kW	37.5
	BTU/h	128,000
Input	kW	9.61

Indoor unit temperature correction

To be used to correct indoor unit capacity only

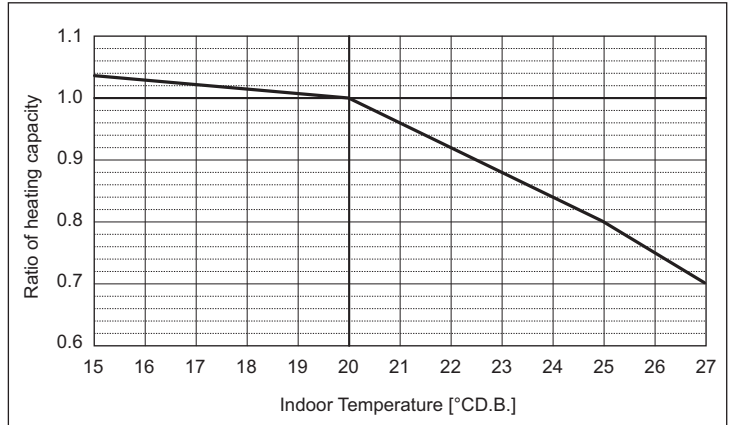

Outdoor unit temperature correction

To be used to correct outdoor unit only

Outdoor unit capacity is NOT affected by the indoor temperature.

Outdoor unit power input is affected by the indoor and outdoor temperatures. Please consult the sales office for details.

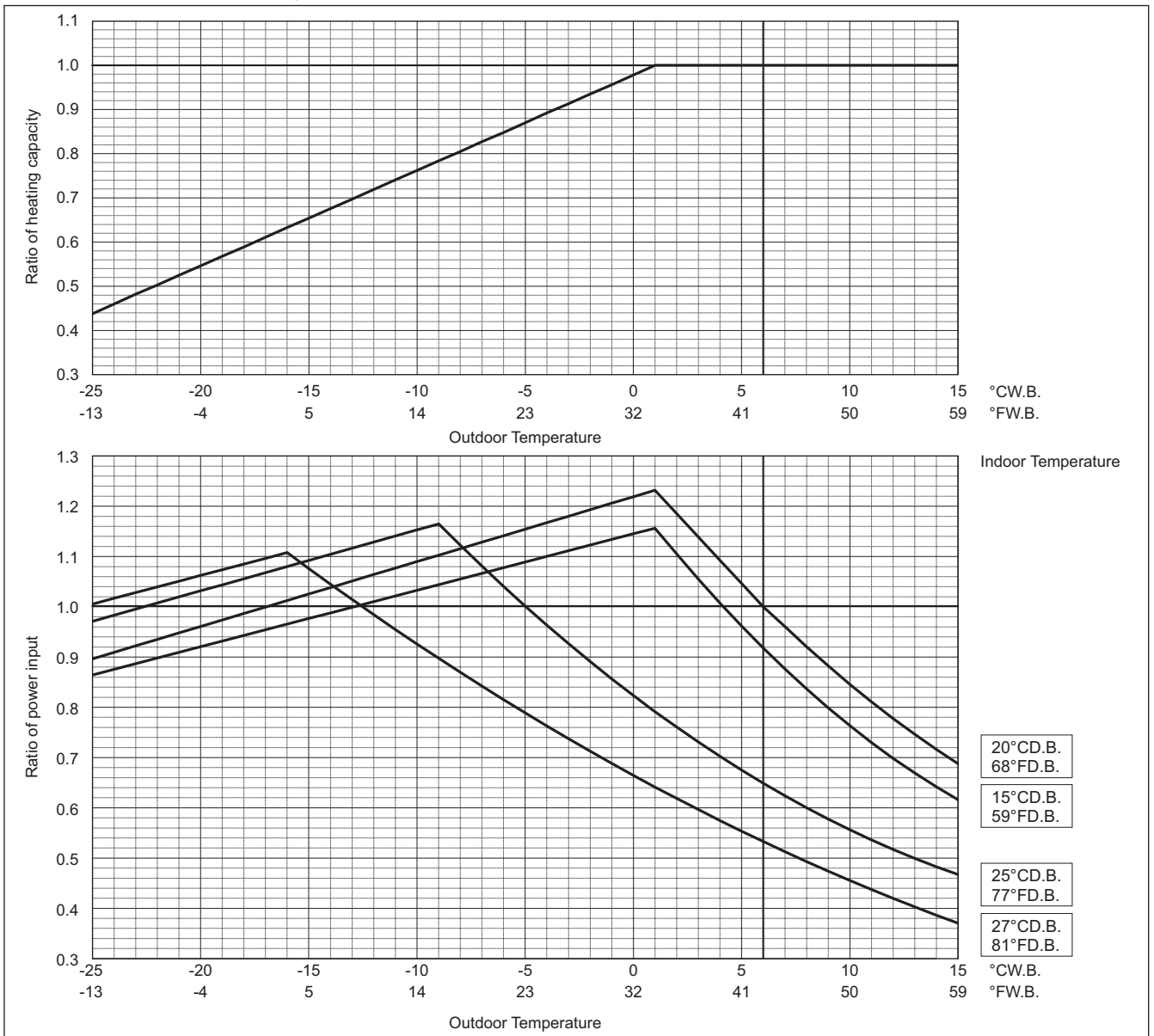

PURY-M-Y(S)XM-A

COP Priority Mode

PURY-		M350YXM-A
Heating Capacity	kW	45.0
	BTU/h	153,500
Input	kW	12.64

Indoor unit temperature correction

To be used to correct indoor unit capacity only

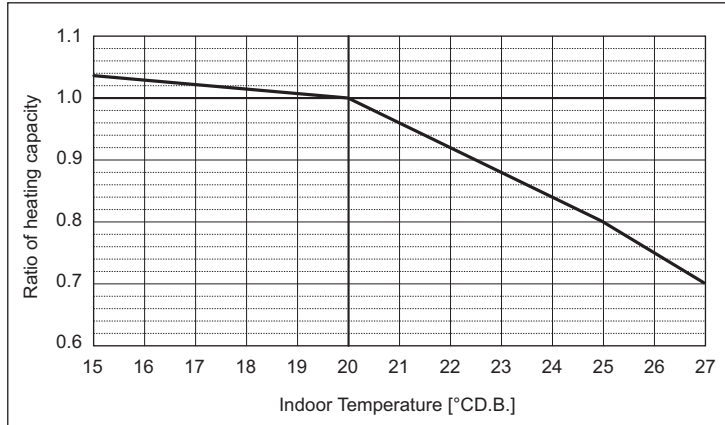

Outdoor unit temperature correction

To be used to correct outdoor unit only

Outdoor unit capacity is NOT affected by the indoor temperature.

Outdoor unit power input is affected by the indoor and outdoor temperatures. Please consult the sales office for details.

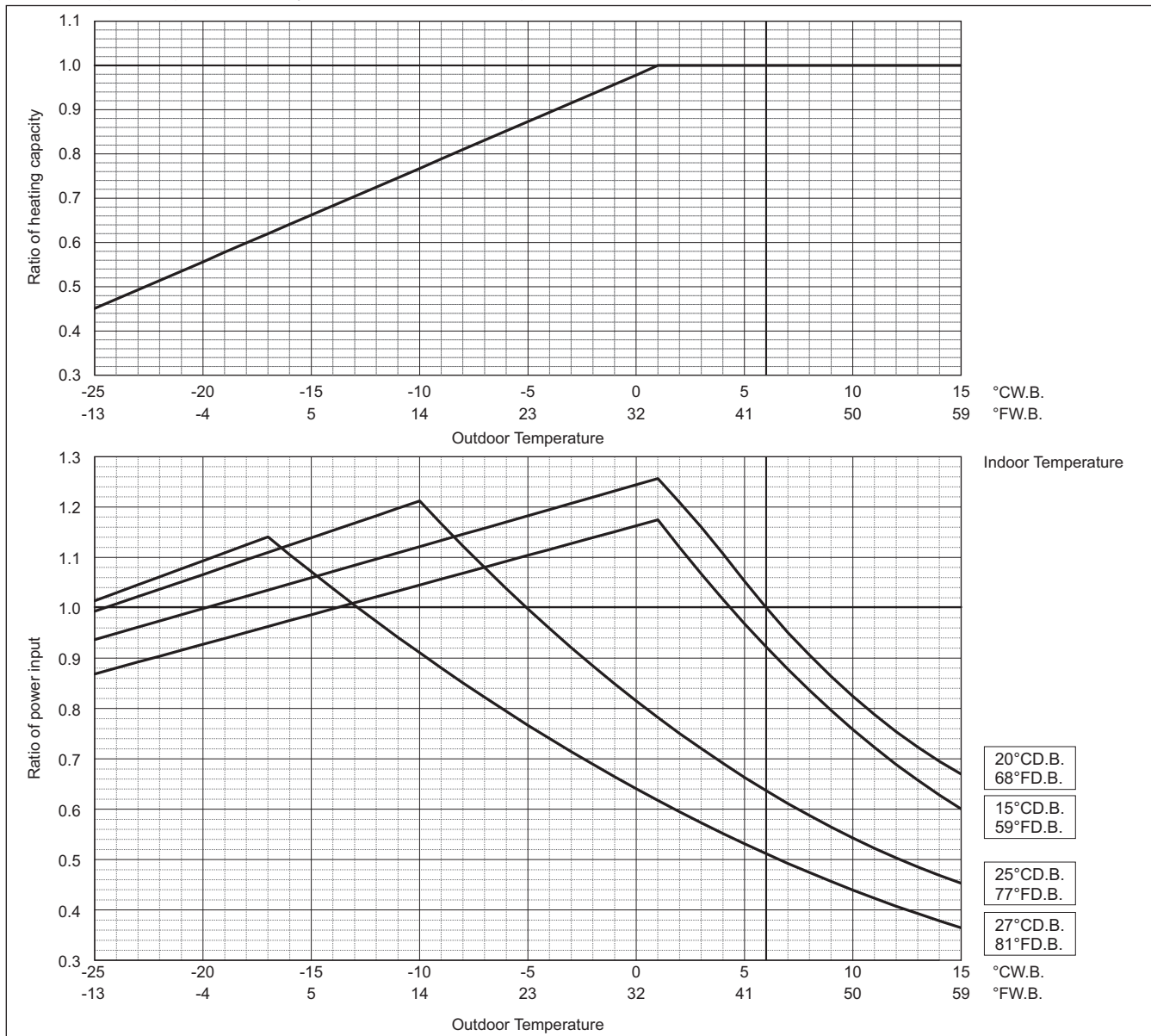

PURY-M-Y(S)XM-A

COP Priority Mode

	PURY-	M400YXM-A
Heating Capacity	kW	50.0
	BTU/h	170,600
Input	kW	14.04

Indoor unit temperature correction

To be used to correct indoor unit capacity only

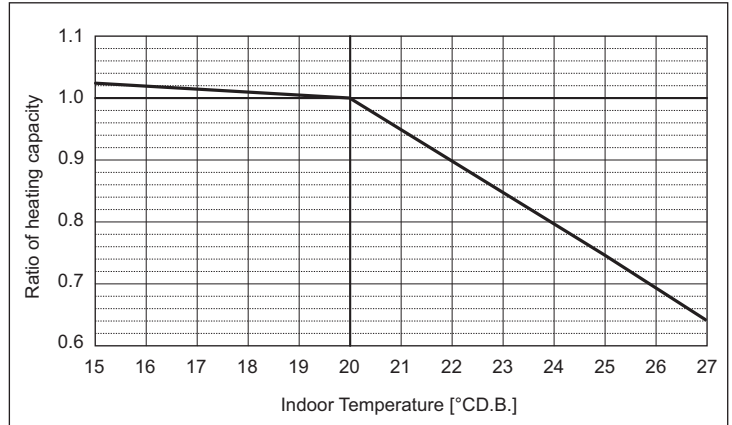

Outdoor unit temperature correction

To be used to correct outdoor unit only

Outdoor unit capacity is NOT affected by the indoor temperature.

Outdoor unit power input is affected by the indoor and outdoor temperatures. Please consult the sales office for details.

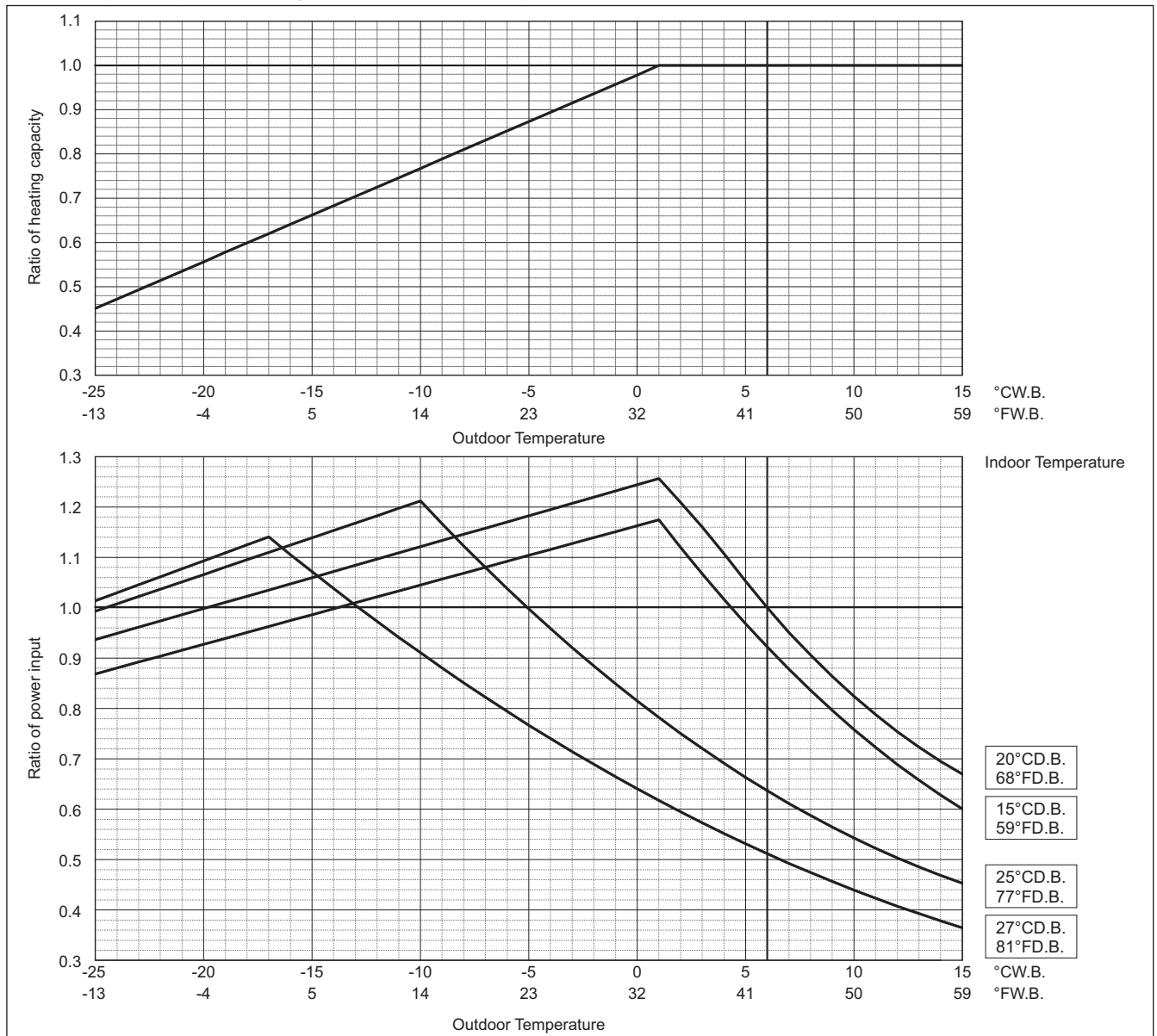

PURY-M-Y(S)XM-A

COP Priority Mode

PURY-		M450YXM-A
Heating Capacity	kW	56.0
	BTU/h	191,100
Input	kW	16.66

Indoor unit temperature correction

To be used to correct indoor unit capacity only

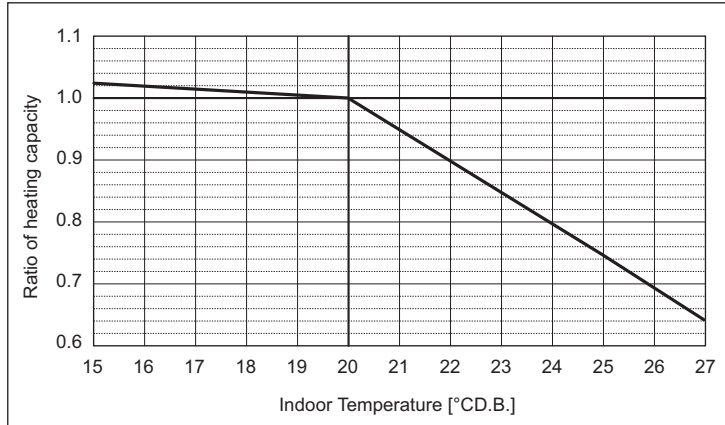

Outdoor unit temperature correction

To be used to correct outdoor unit only

Outdoor unit capacity is NOT affected by the indoor temperature.

Outdoor unit power input is affected by the indoor and outdoor temperatures. Please consult the sales office for details.

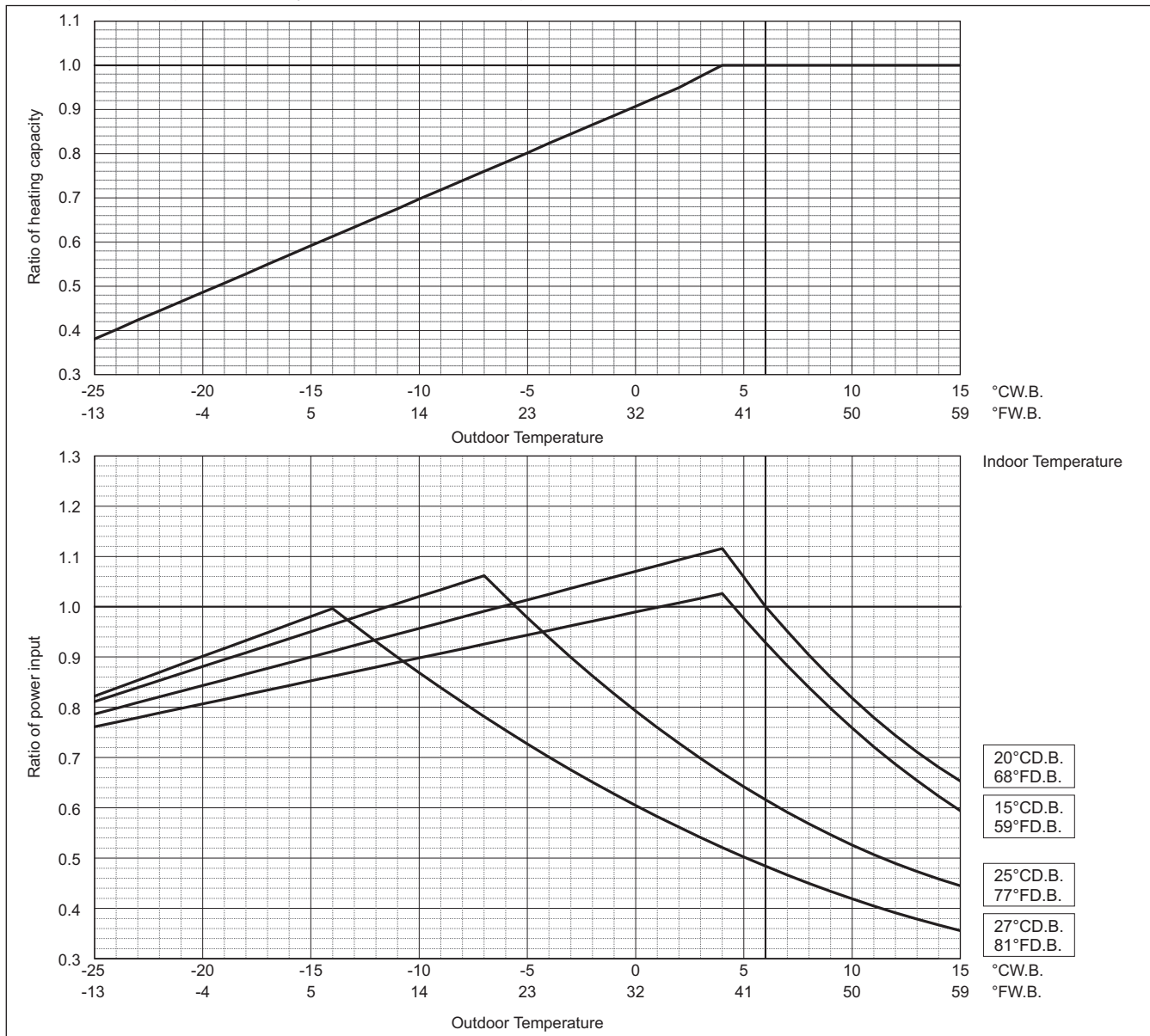

PURY-M-Y(S)XM-A

COP Priority Mode

	PURY-	M500YXM-A
Heating Capacity	kW	58.0
	BTU/h	197,900
Input	kW	17.41

Indoor unit temperature correction

To be used to correct indoor unit capacity only

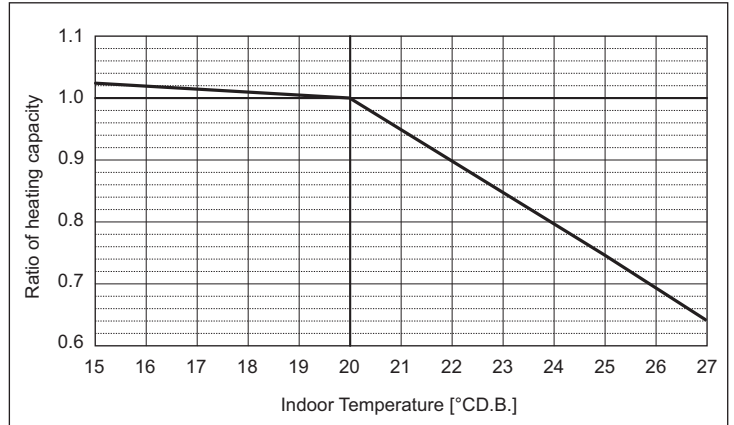

Outdoor unit temperature correction

To be used to correct outdoor unit only

Outdoor unit capacity is NOT affected by the indoor temperature.

Outdoor unit power input is affected by the indoor and outdoor temperatures. Please consult the sales office for details.

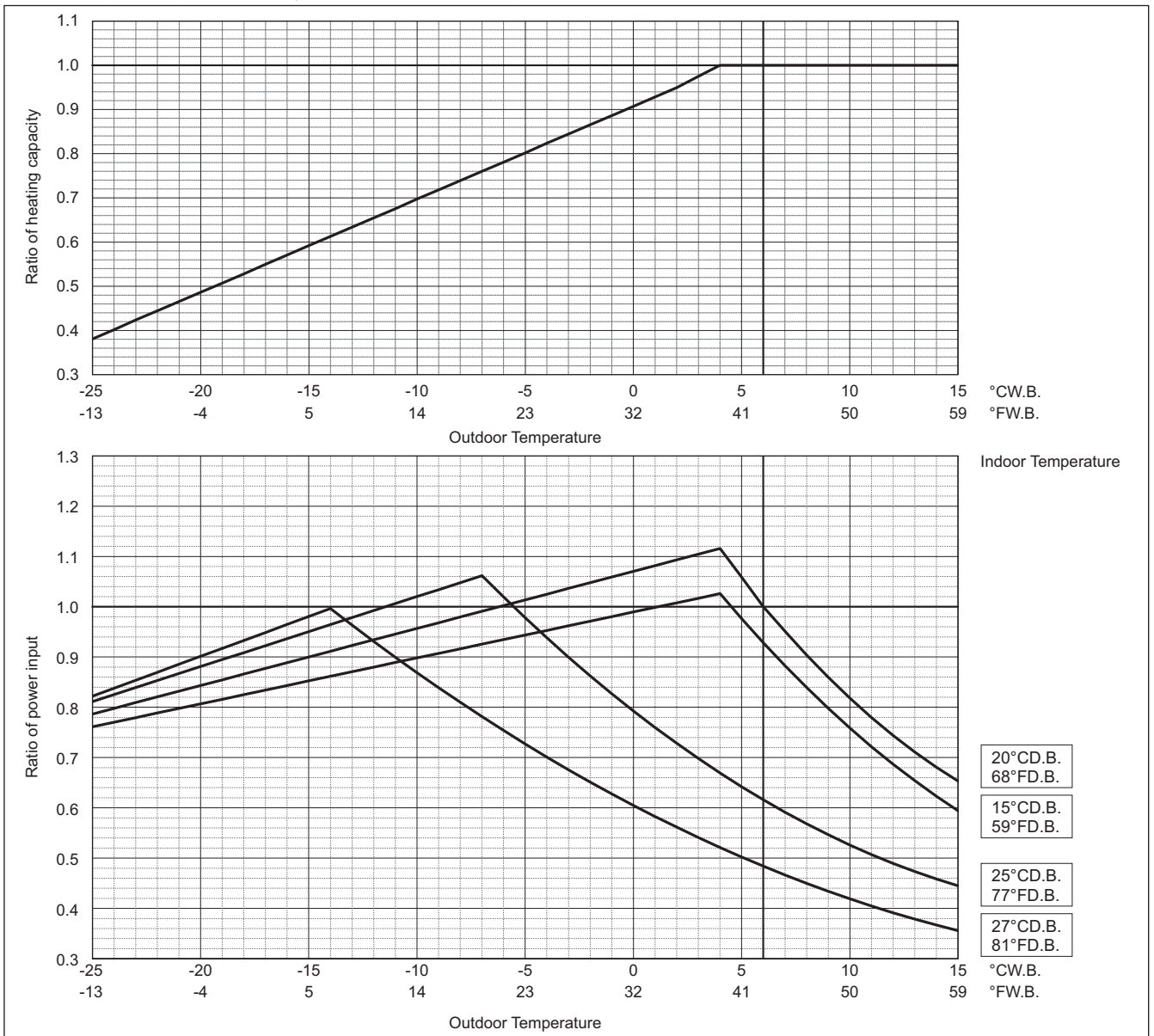

PURY-M-Y(S)XM-A

COP Priority Mode

	PURY-	M400YSXM-A
Heating Capacity	kW	50.0
	BTU/h	170,600
Input	kW	11.68

Indoor unit temperature correction

To be used to correct indoor unit capacity only

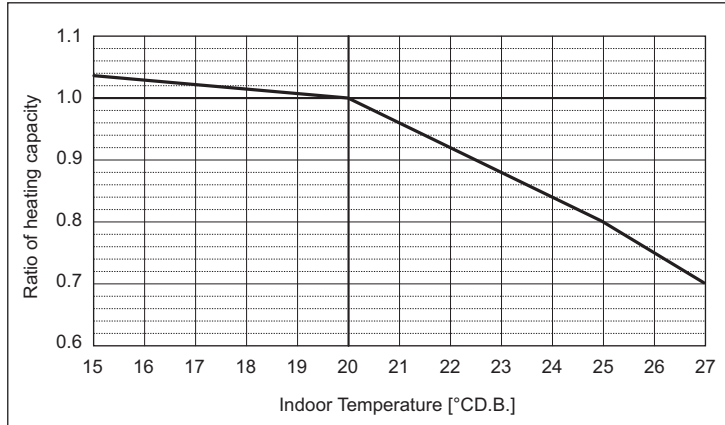

Outdoor unit temperature correction

To be used to correct outdoor unit only

Outdoor unit capacity is NOT affected by the indoor temperature.

Outdoor unit power input is affected by the indoor and outdoor temperatures. Please consult the sales office for details.

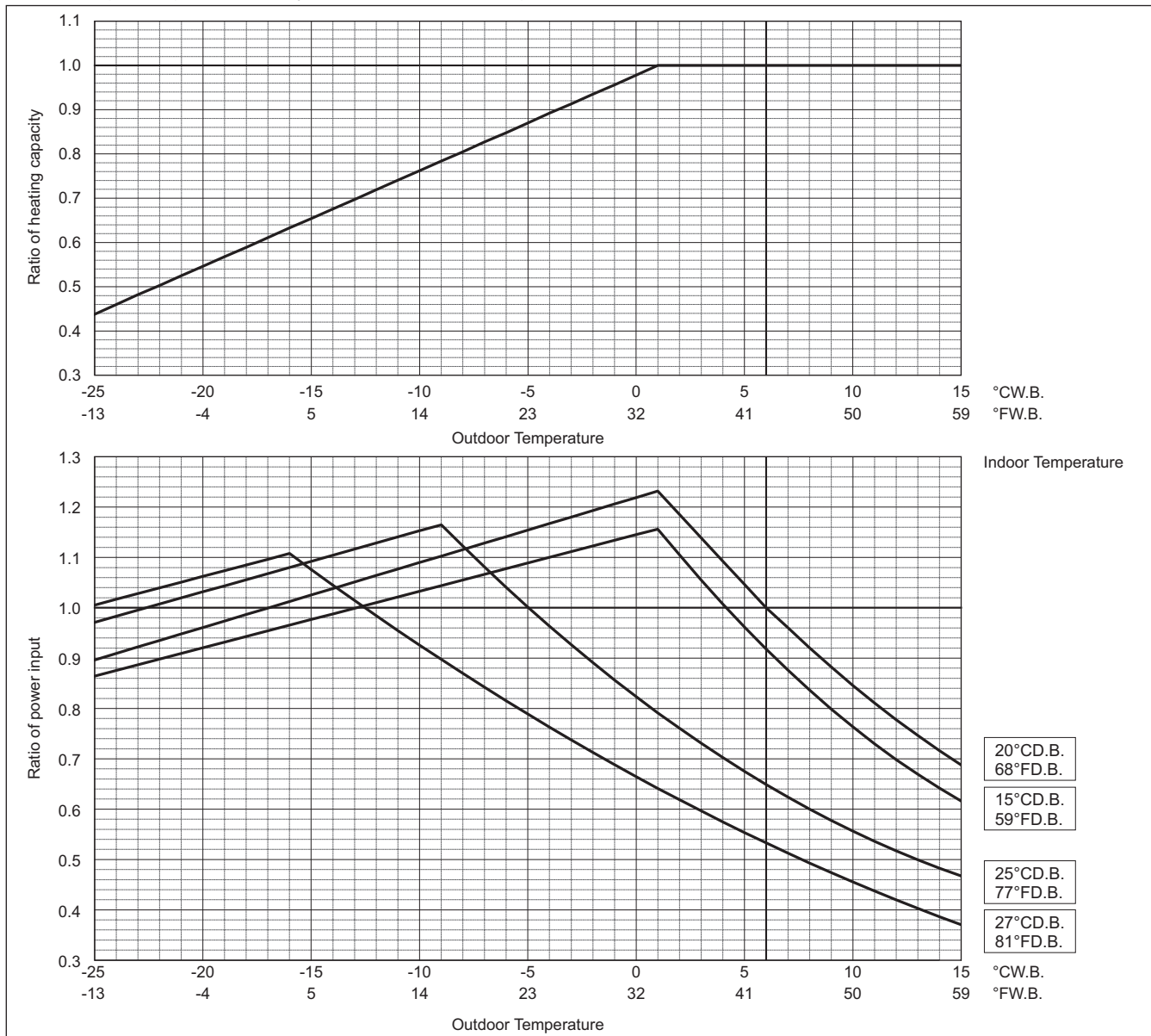

PURY-M-Y(S)XM-A

COP Priority Mode

	PURY-	M450YSXM-A
Heating Capacity	kW	56.5
Capacity	BTU/h	192,800
Input	kW	13.78

Indoor unit temperature correction

To be used to correct indoor unit capacity only

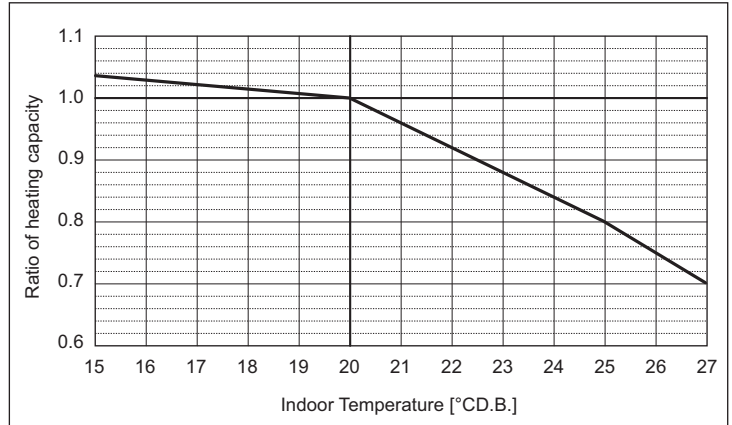

Outdoor unit temperature correction

To be used to correct outdoor unit only

Outdoor unit capacity is NOT affected by the indoor temperature.

Outdoor unit power input is affected by the indoor and outdoor temperatures. Please consult the sales office for details.

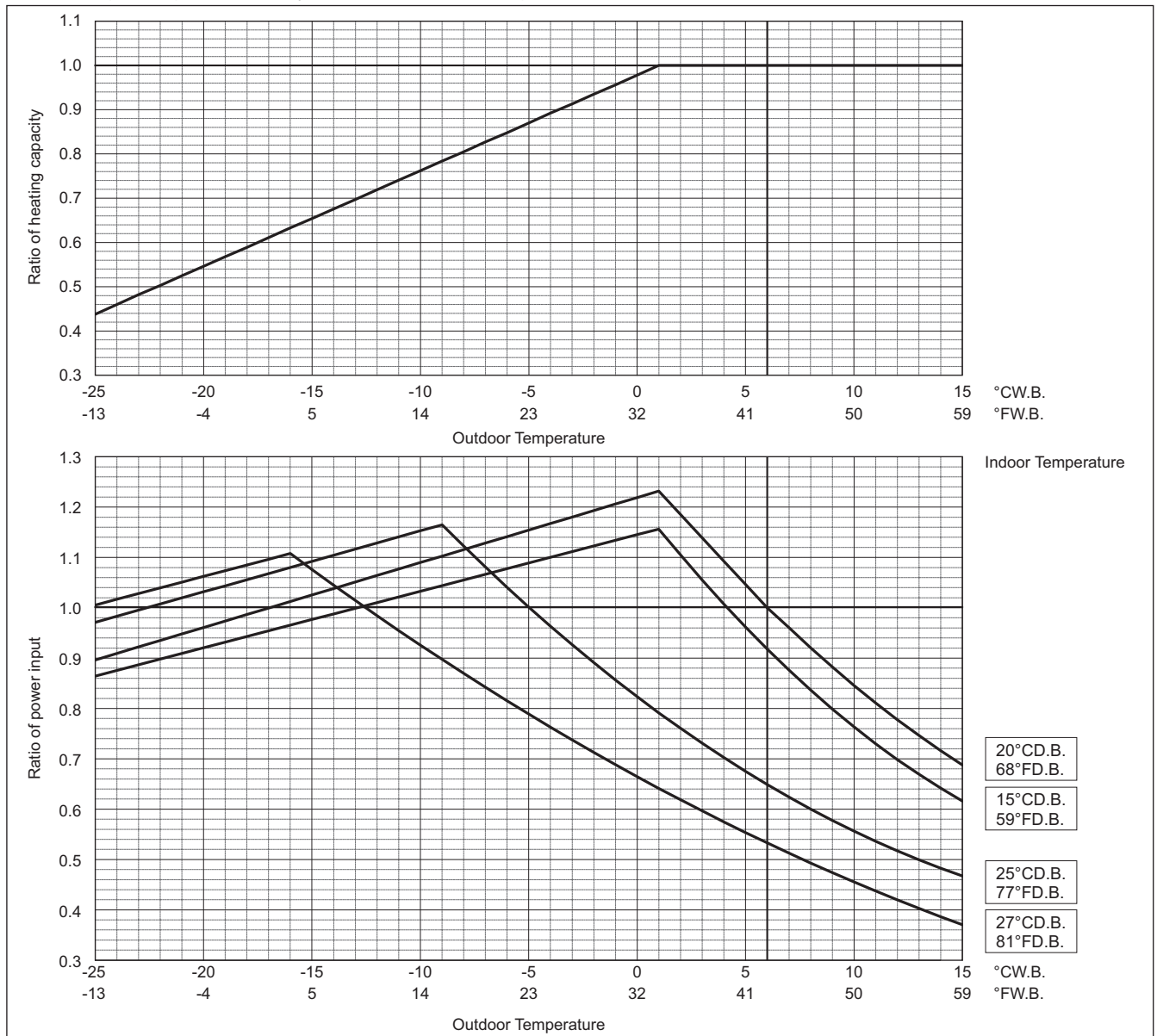

PURY-M-V(S)XM-A

COP Priority Mode

PURY-		M500YSXM-A
Heating Capacity	kW	63.0
	BTU/h	215,000
Input	kW	16.11

Indoor unit temperature correction

To be used to correct indoor unit capacity only

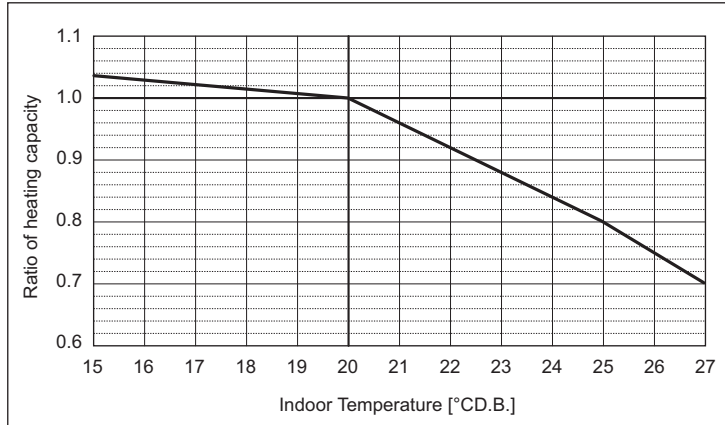

Outdoor unit temperature correction

To be used to correct outdoor unit only

Outdoor unit capacity is NOT affected by the indoor temperature.

Outdoor unit power input is affected by the indoor and outdoor temperatures. Please consult the sales office for details.

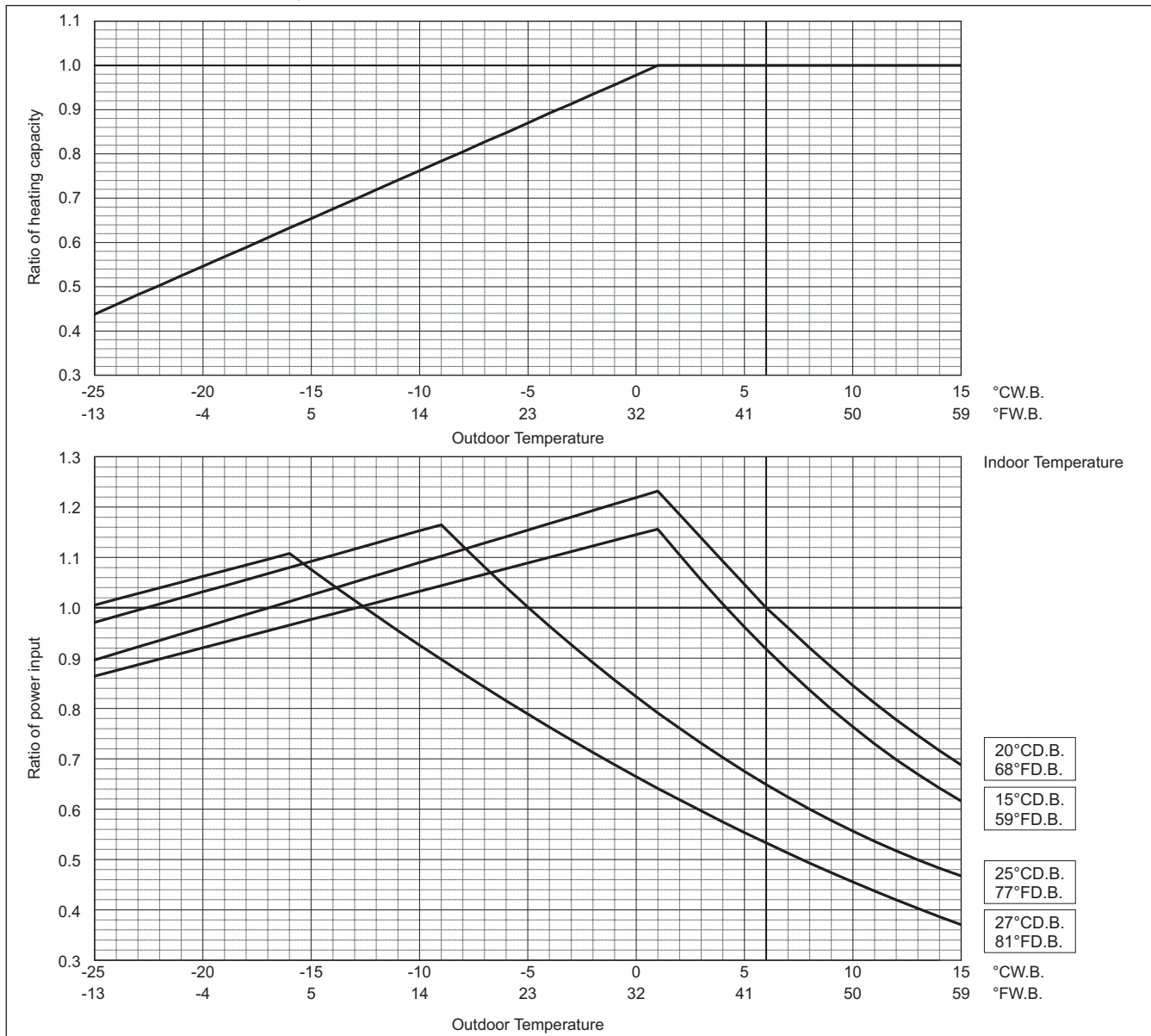

PURY-M-Y(S)XM-A

COP Priority Mode

PURY-		M550YSXM-A
Heating Capacity	kW	69.0
	BTU/h	235,400
Input	kW	17.92

Indoor unit temperature correction

To be used to correct indoor unit capacity only

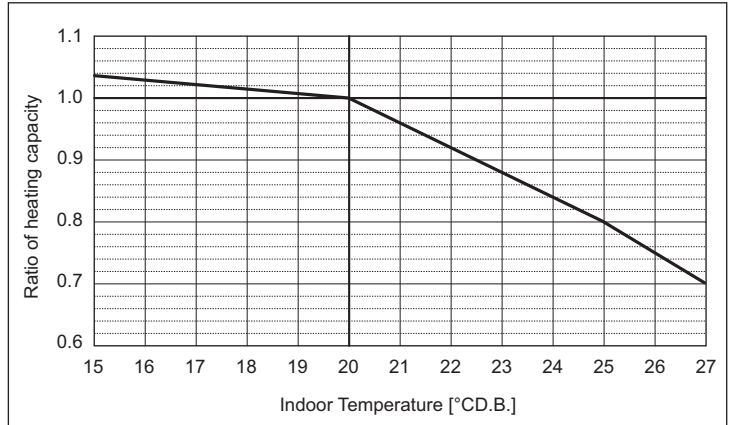

Outdoor unit temperature correction

To be used to correct outdoor unit only

Outdoor unit capacity is NOT affected by the indoor temperature.

Outdoor unit power input is affected by the indoor and outdoor temperatures. Please consult the sales office for details.

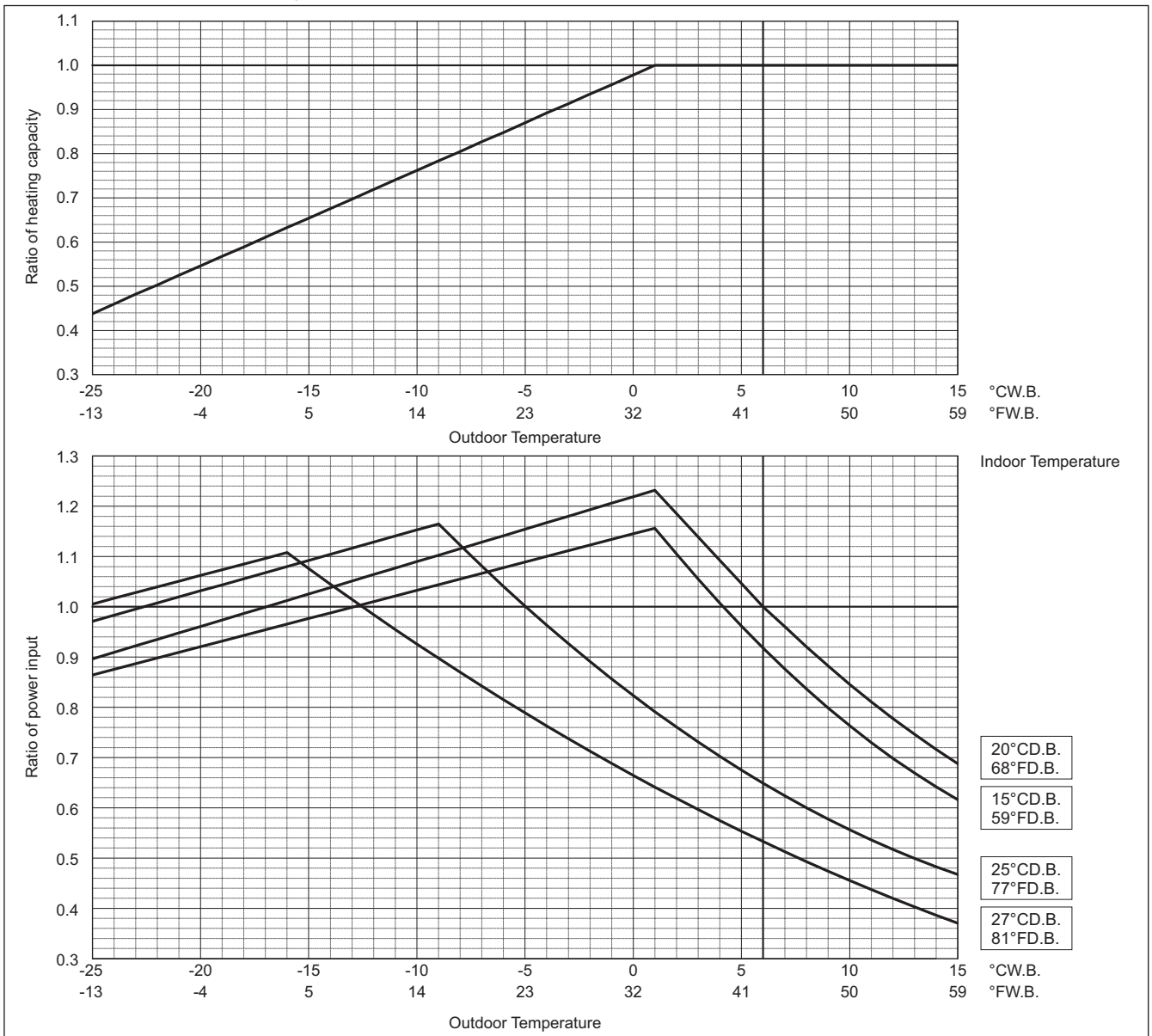

PURY-M-V(S)XM-A

COP Priority Mode

PURY-		M600YSXM-A
Heating Capacity	kW	75.0
	BTU/h	225,900
Input	kW	19.84

Indoor unit temperature correction

To be used to correct indoor unit capacity only

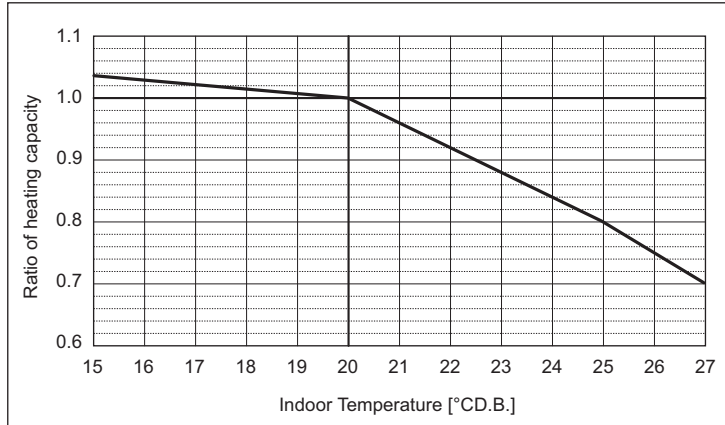

Outdoor unit temperature correction

To be used to correct outdoor unit only

Outdoor unit capacity is NOT affected by the indoor temperature.

Outdoor unit power input is affected by the indoor and outdoor temperatures. Please consult the sales office for details.

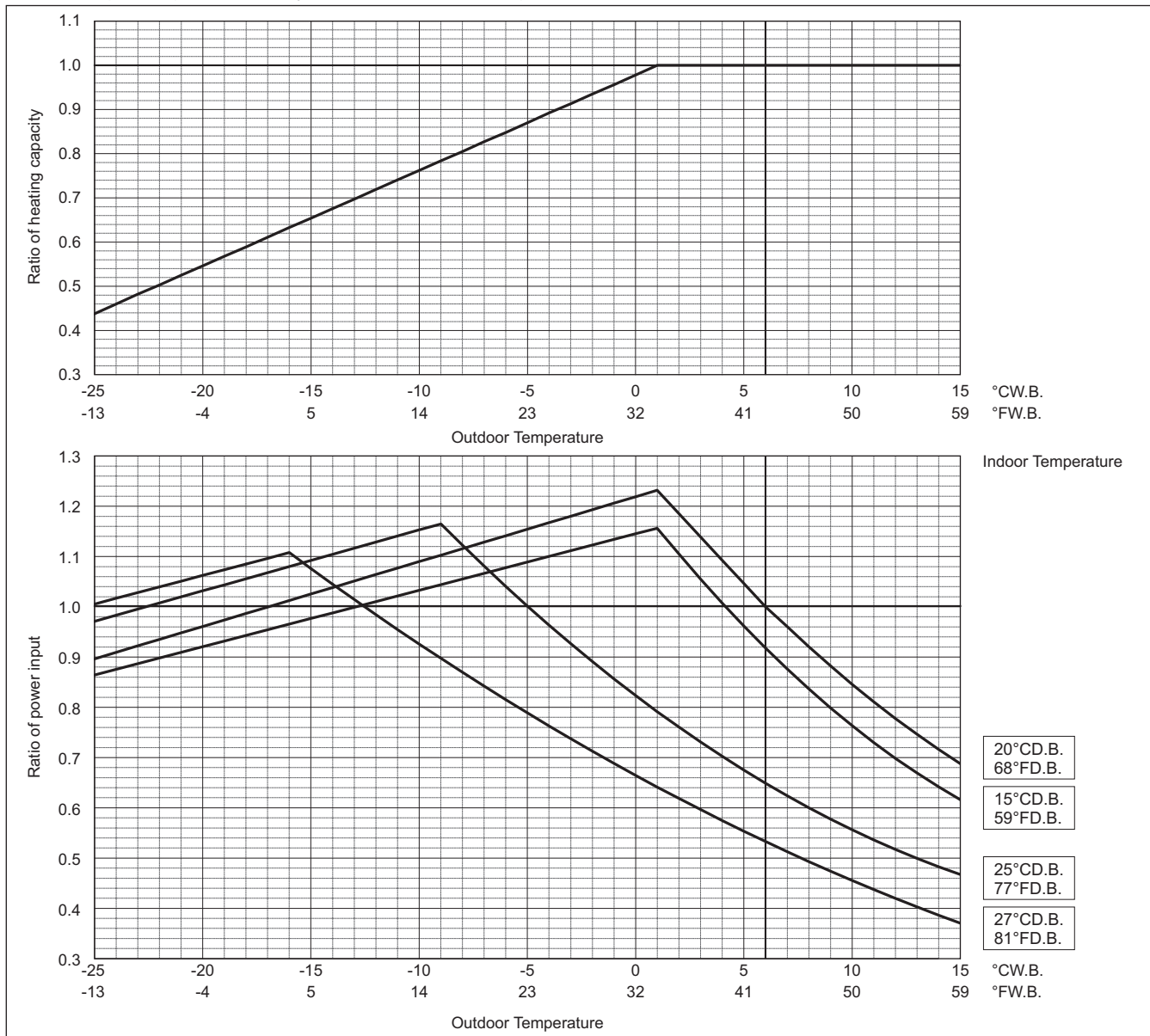

PURY-M-Y(S)XM-A

COP Priority Mode

PURY-		M650YSXM-A
Heating Capacity	kW	82.5
	BTU/h	281,500
Input	kW	22.85

Indoor unit temperature correction

To be used to correct indoor unit capacity only

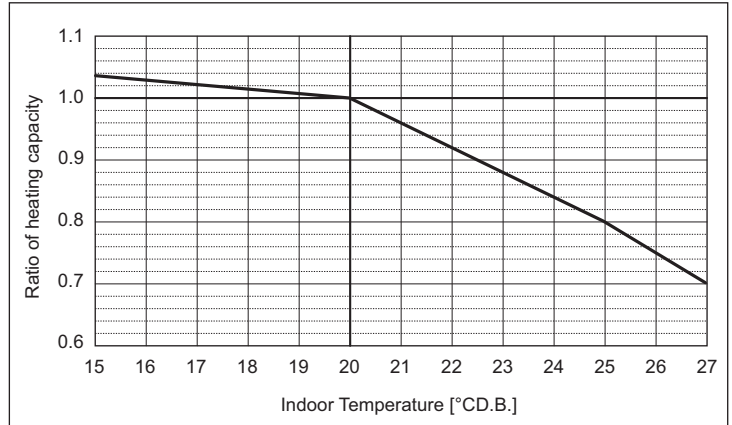

Outdoor unit temperature correction

To be used to correct outdoor unit only

Outdoor unit capacity is NOT affected by the indoor temperature.

Outdoor unit power input is affected by the indoor and outdoor temperatures. Please consult the sales office for details.

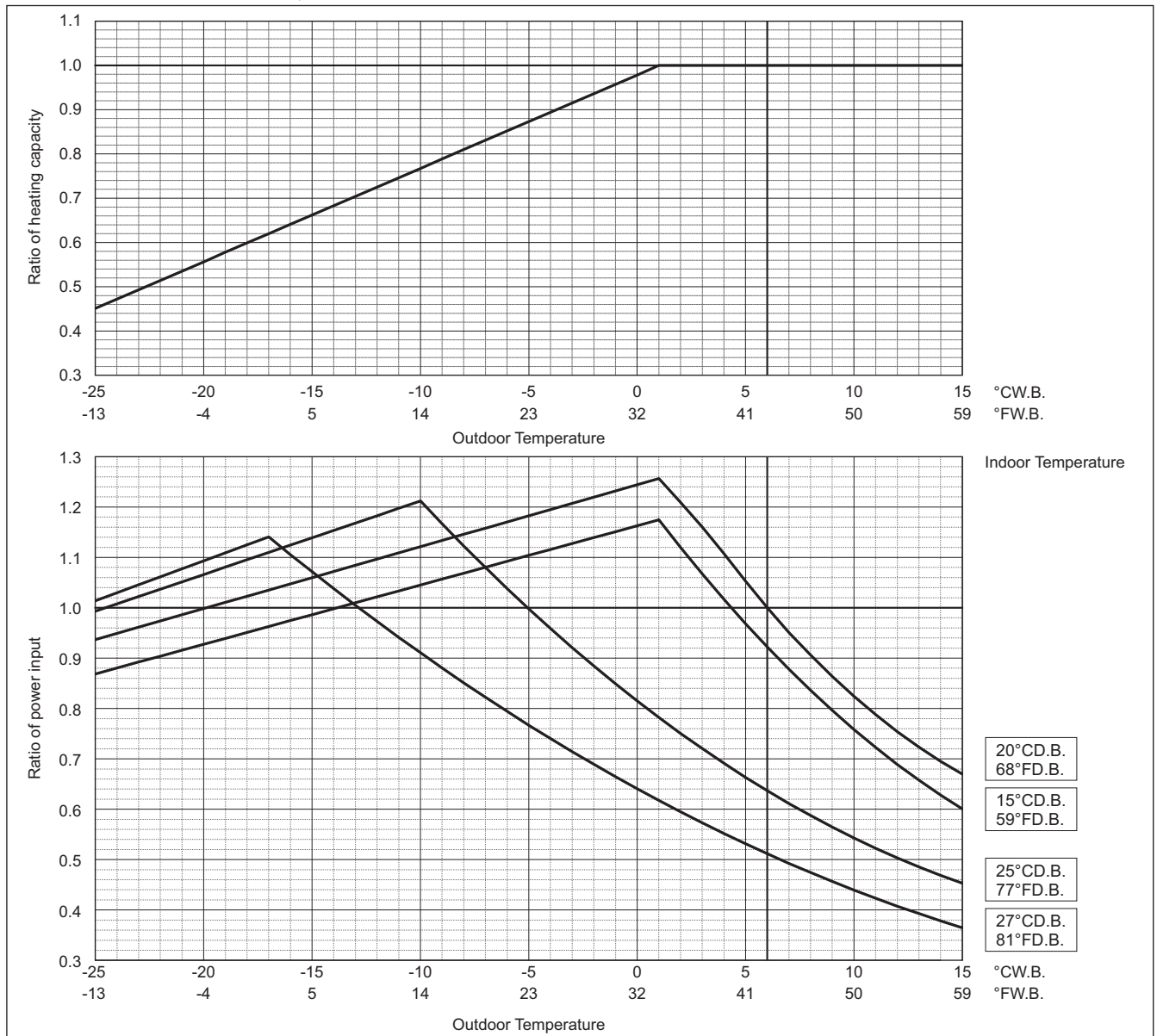

COP Priority Mode

PURY-		M700YSXM-A
Heating Capacity	kW	90.0
	BTU/h	307,100
Input	kW	26.08

Indoor unit temperature correction

To be used to correct indoor unit capacity only

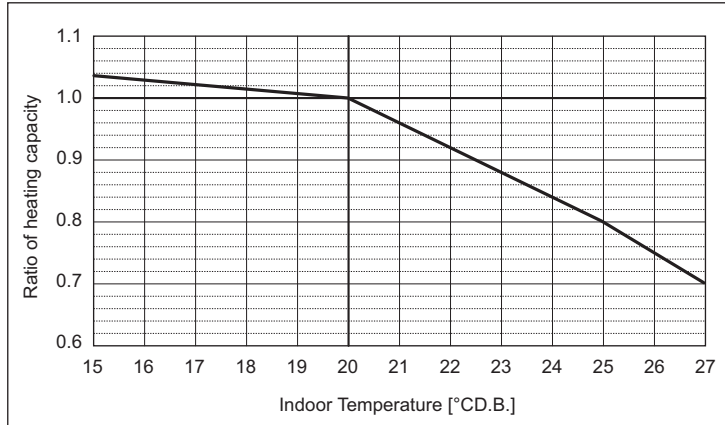

Outdoor unit temperature correction

To be used to correct outdoor unit only

Outdoor unit capacity is NOT affected by the indoor temperature.

Outdoor unit power input is affected by the indoor and outdoor temperatures. Please consult the sales office for details.

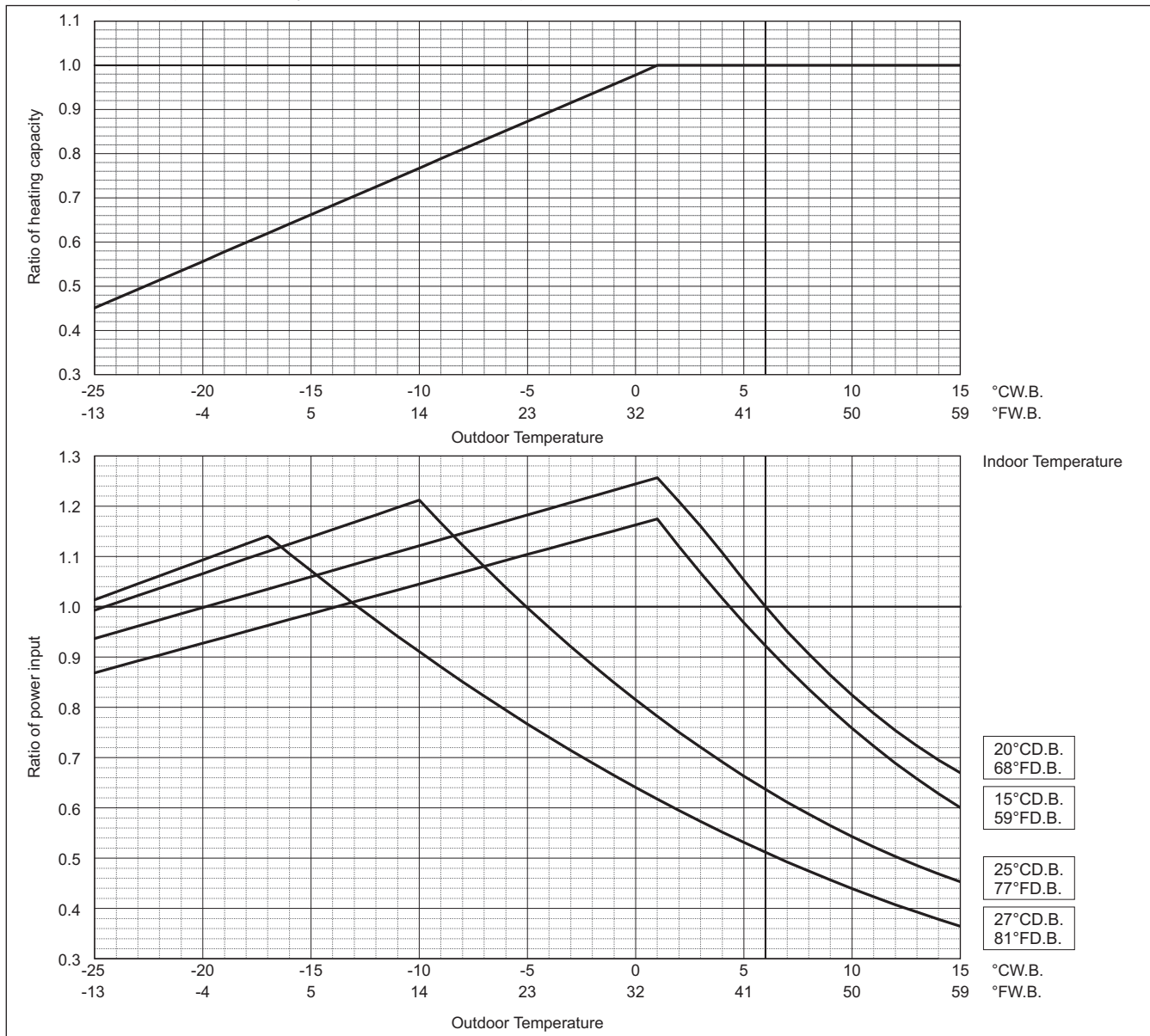

PURY-M-Y(S)XM-A

COP Priority Mode

	PURY-	M750YSXM-A
Heating Capacity	kW	95.0
	BTU/h	324,100
Input	kW	27.53

Indoor unit temperature correction

To be used to correct indoor unit capacity only

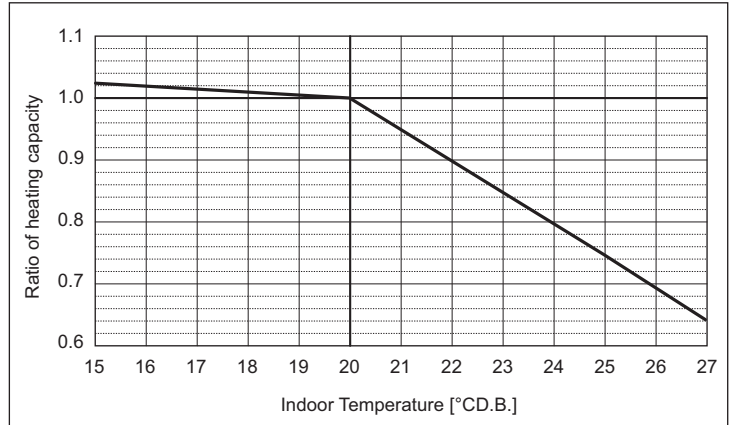

Outdoor unit temperature correction

To be used to correct outdoor unit only

Outdoor unit capacity is NOT affected by the indoor temperature.

Outdoor unit power input is affected by the indoor and outdoor temperatures. Please consult the sales office for details.

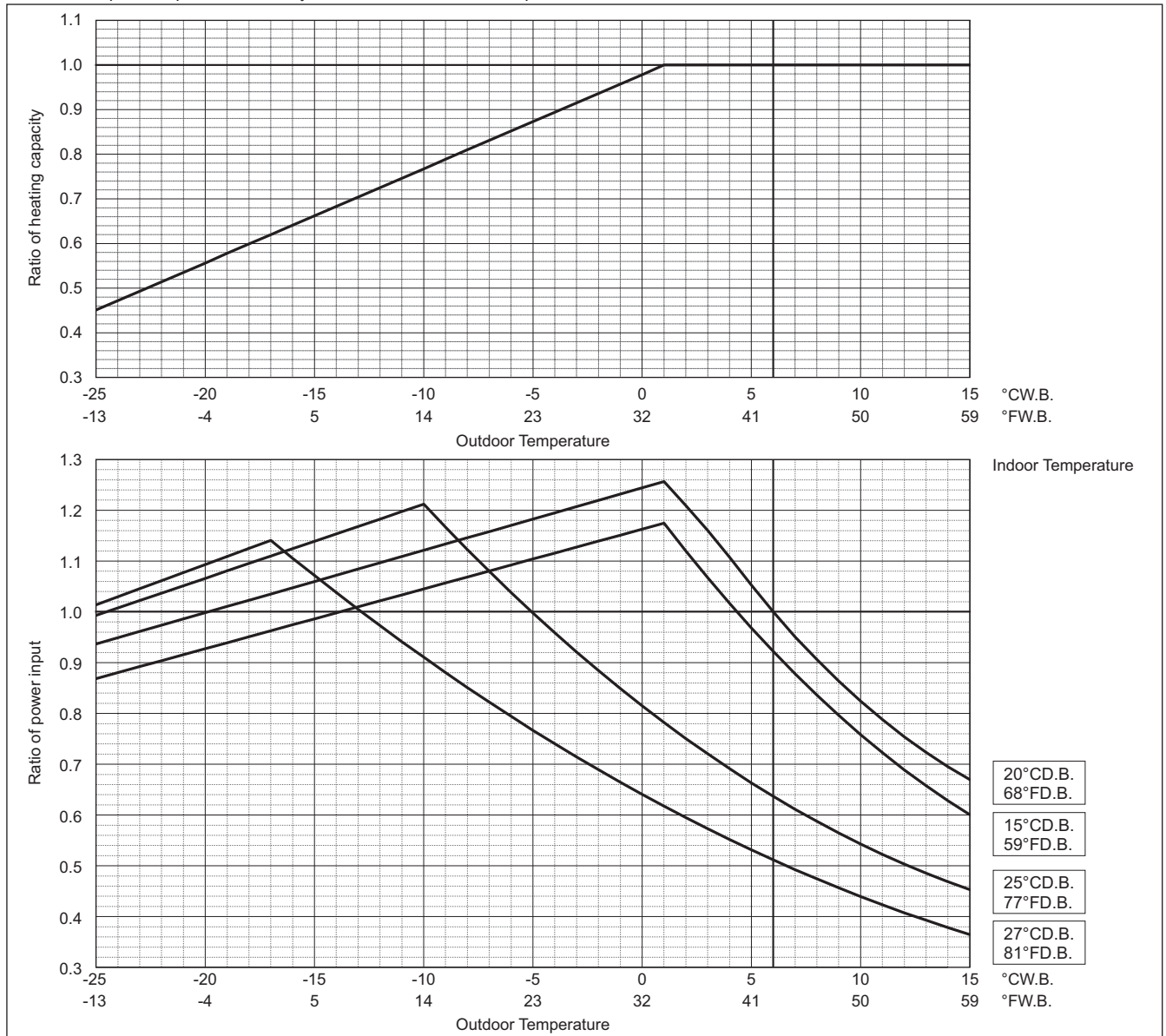

COP Priority Mode

	PURY-	M800YSXM-A
Heating Capacity	kW	100.0
	BTU/h	341,200
Input	kW	28.98

Indoor unit temperature correction

To be used to correct indoor unit capacity only

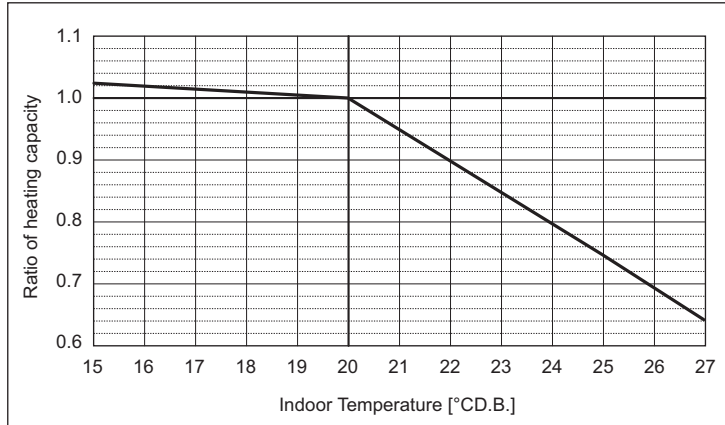

Outdoor unit temperature correction

To be used to correct outdoor unit only

Outdoor unit capacity is NOT affected by the indoor temperature.

Outdoor unit power input is affected by the indoor and outdoor temperatures. Please consult the sales office for details.

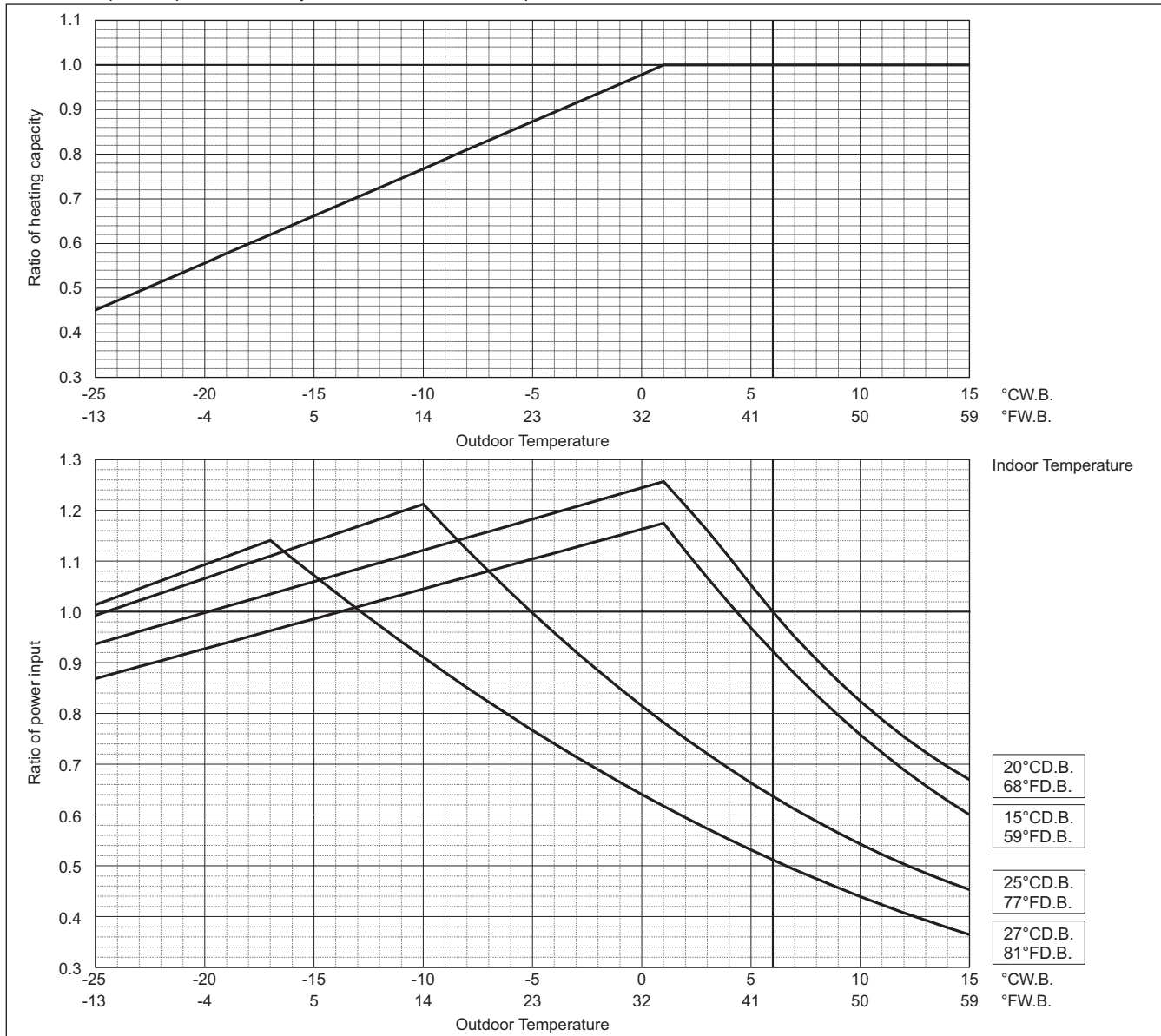

PURY-M-Y(S)XM-A

COP Priority Mode

	PURY-	M850YSXM-A
Heating Capacity	kW	106.0
	BTU/h	361,700
Input	kW	31.64

Indoor unit temperature correction

To be used to correct indoor unit capacity only

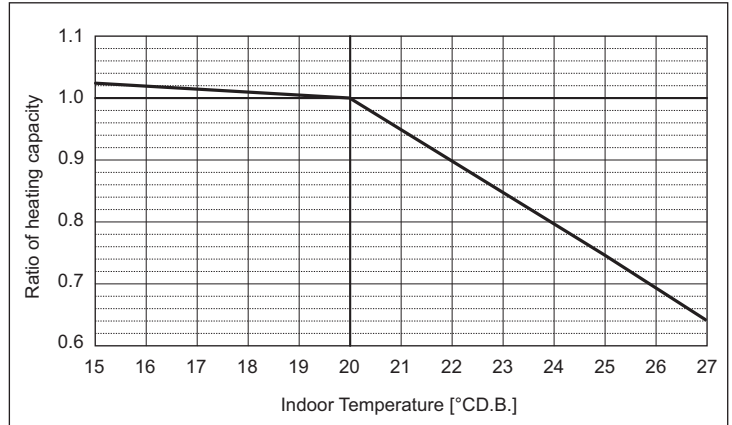

Outdoor unit temperature correction

To be used to correct outdoor unit only

Outdoor unit capacity is NOT affected by the indoor temperature.

Outdoor unit power input is affected by the indoor and outdoor temperatures. Please consult the sales office for details.

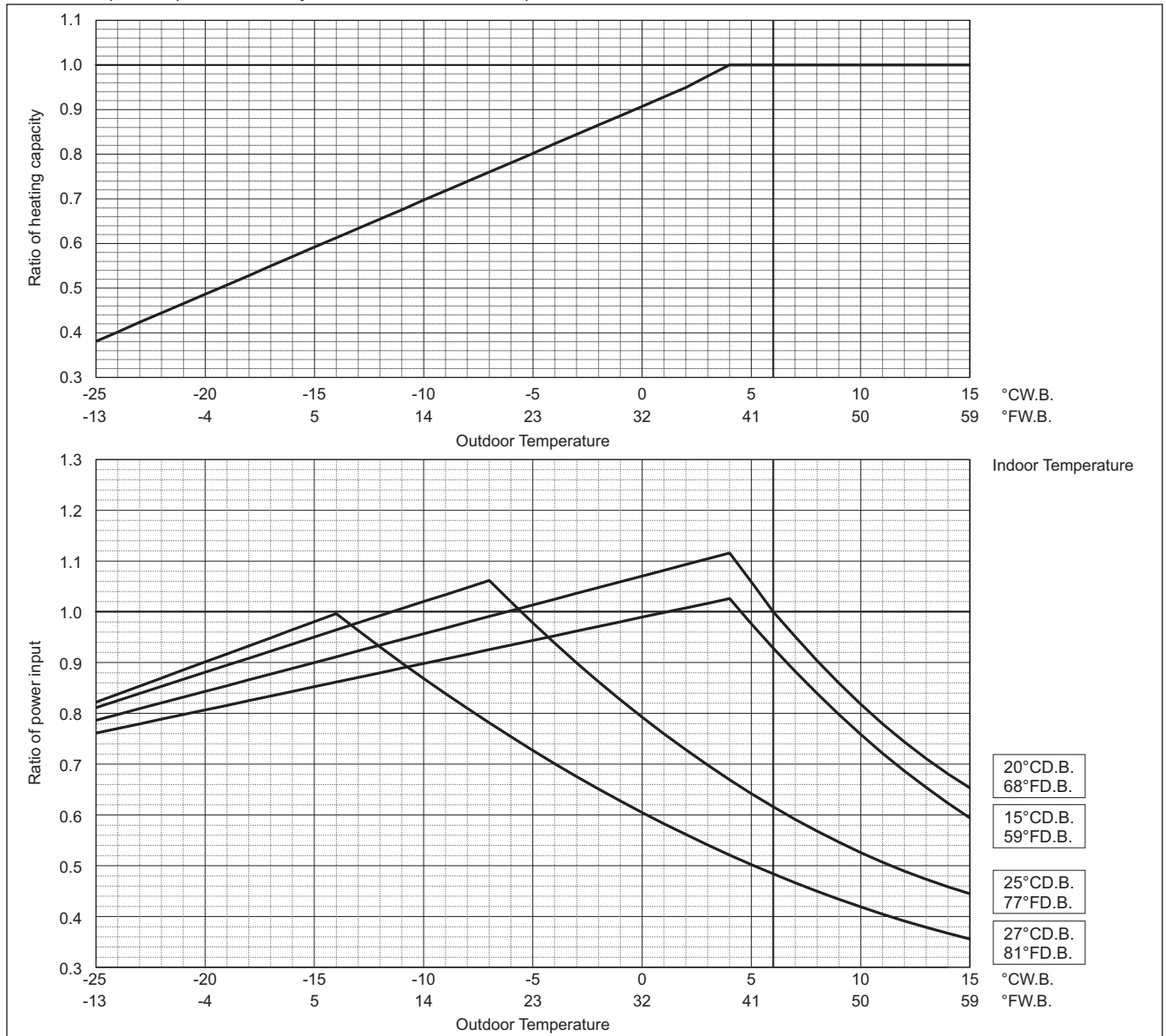

COP Priority Mode

	PURY-	M900YSXM-A
Heating Capacity	kW	112.0
	BTU/h	382,100
Input	kW	34.46

Indoor unit temperature correction

To be used to correct indoor unit capacity only

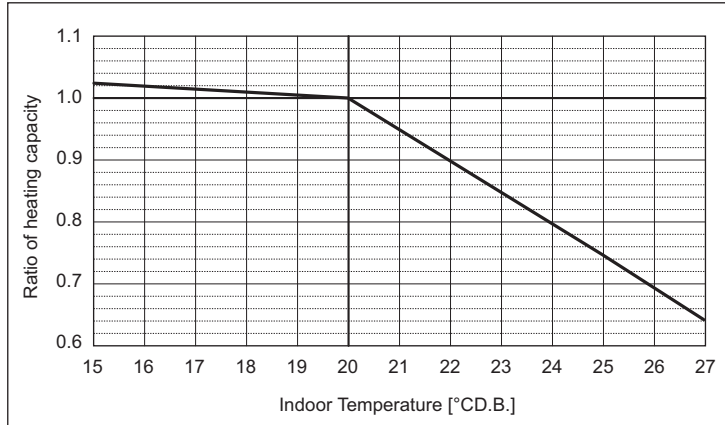

Outdoor unit temperature correction

To be used to correct outdoor unit only

Outdoor unit capacity is NOT affected by the indoor temperature.

Outdoor unit power input is affected by the indoor and outdoor temperatures. Please consult the sales office for details.

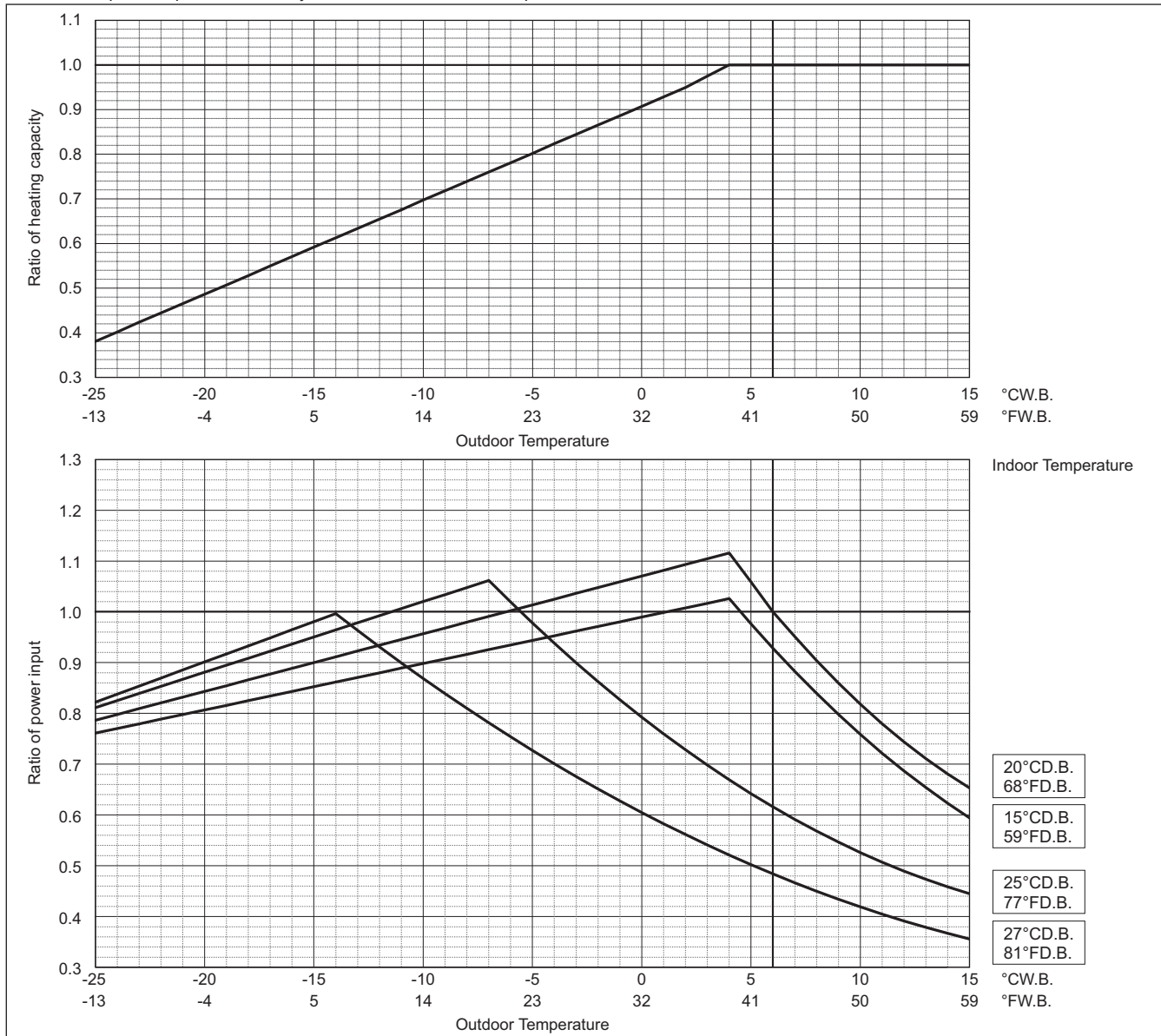

PURY-M-Y(S)XM-A

COP Priority Mode

	PURY-	M950YSXM-A
Heating Capacity	kW	114.0
	BTU/h	389,000
Input	kW	35.18

Indoor unit temperature correction

To be used to correct indoor unit capacity only

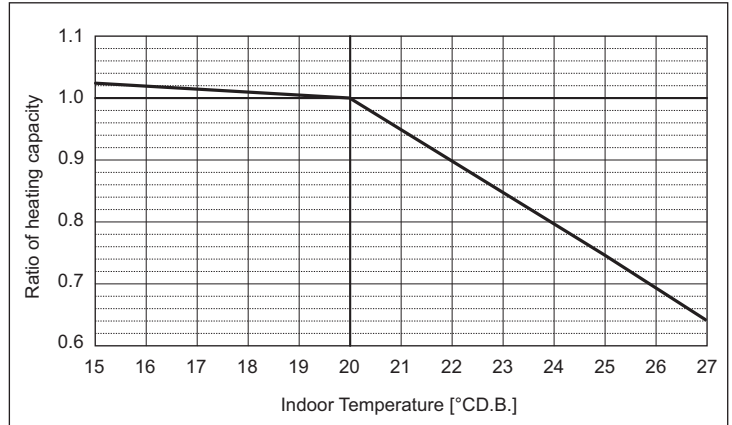

Outdoor unit temperature correction

To be used to correct outdoor unit only

Outdoor unit capacity is NOT affected by the indoor temperature.

Outdoor unit power input is affected by the indoor and outdoor temperatures. Please consult the sales office for details.

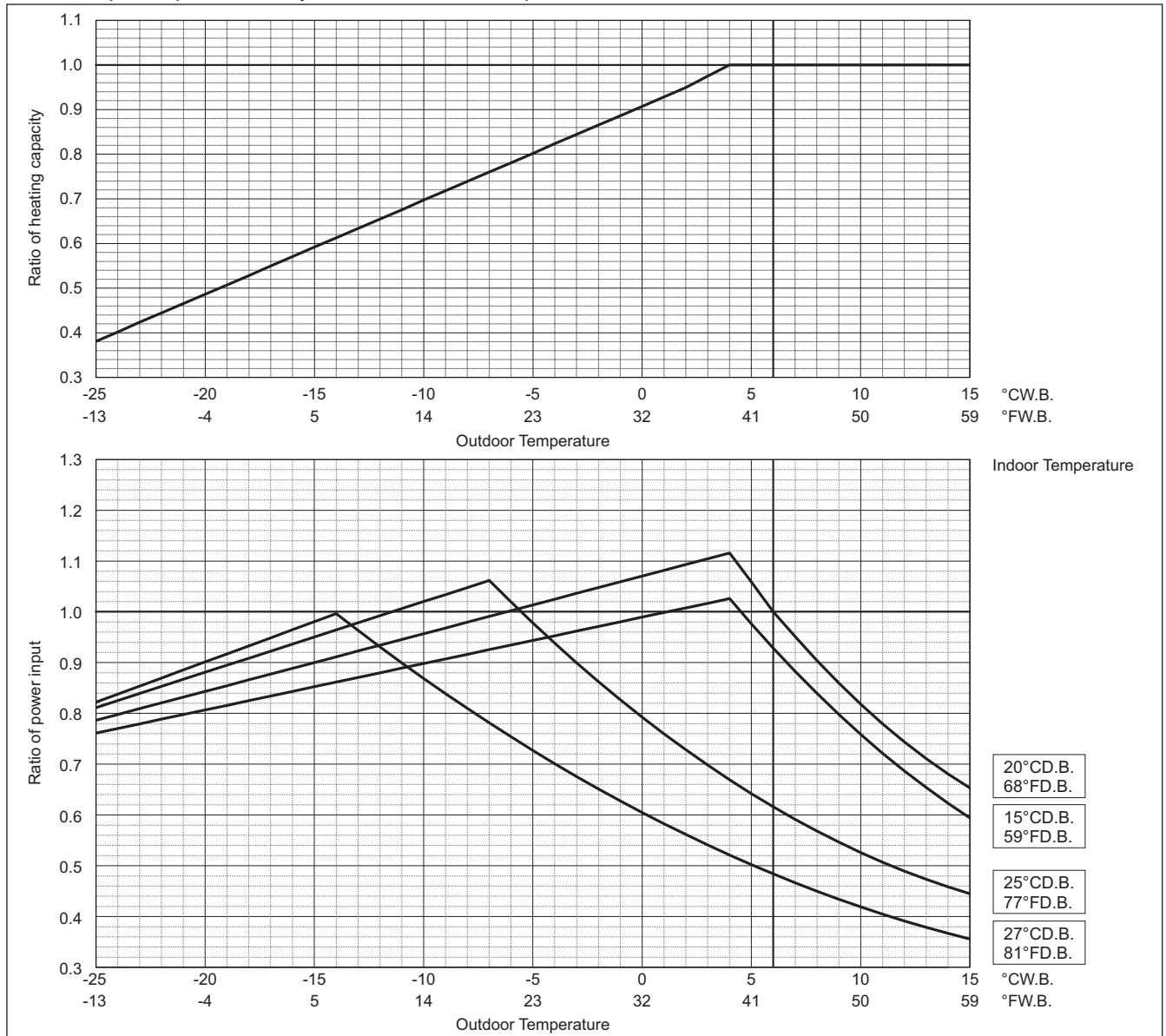

PURY-M-Y(S)XM-A

COP Priority Mode

PURY-		M1000YSXM-A
Heating Capacity	kW	116.0
	BTU/h	395,800
Input	kW	35.91

PURY-M-Y(S)XM-A

Indoor unit temperature correction

To be used to correct indoor unit capacity only

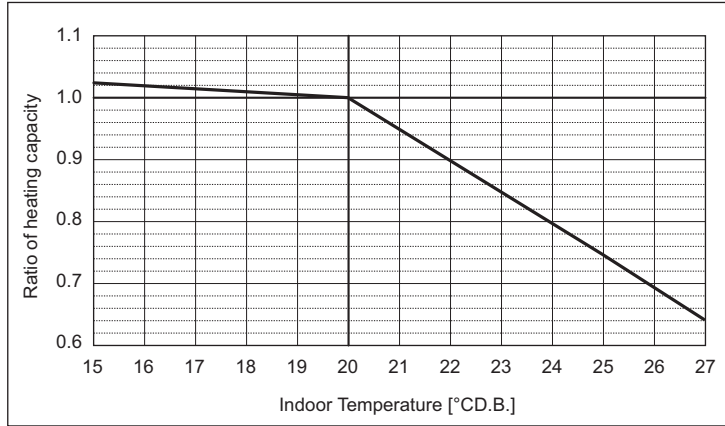

Outdoor unit temperature correction

To be used to correct outdoor unit only

Outdoor unit capacity is NOT affected by the indoor temperature.

Outdoor unit power input is affected by the indoor and outdoor temperatures. Please consult the sales office for details.

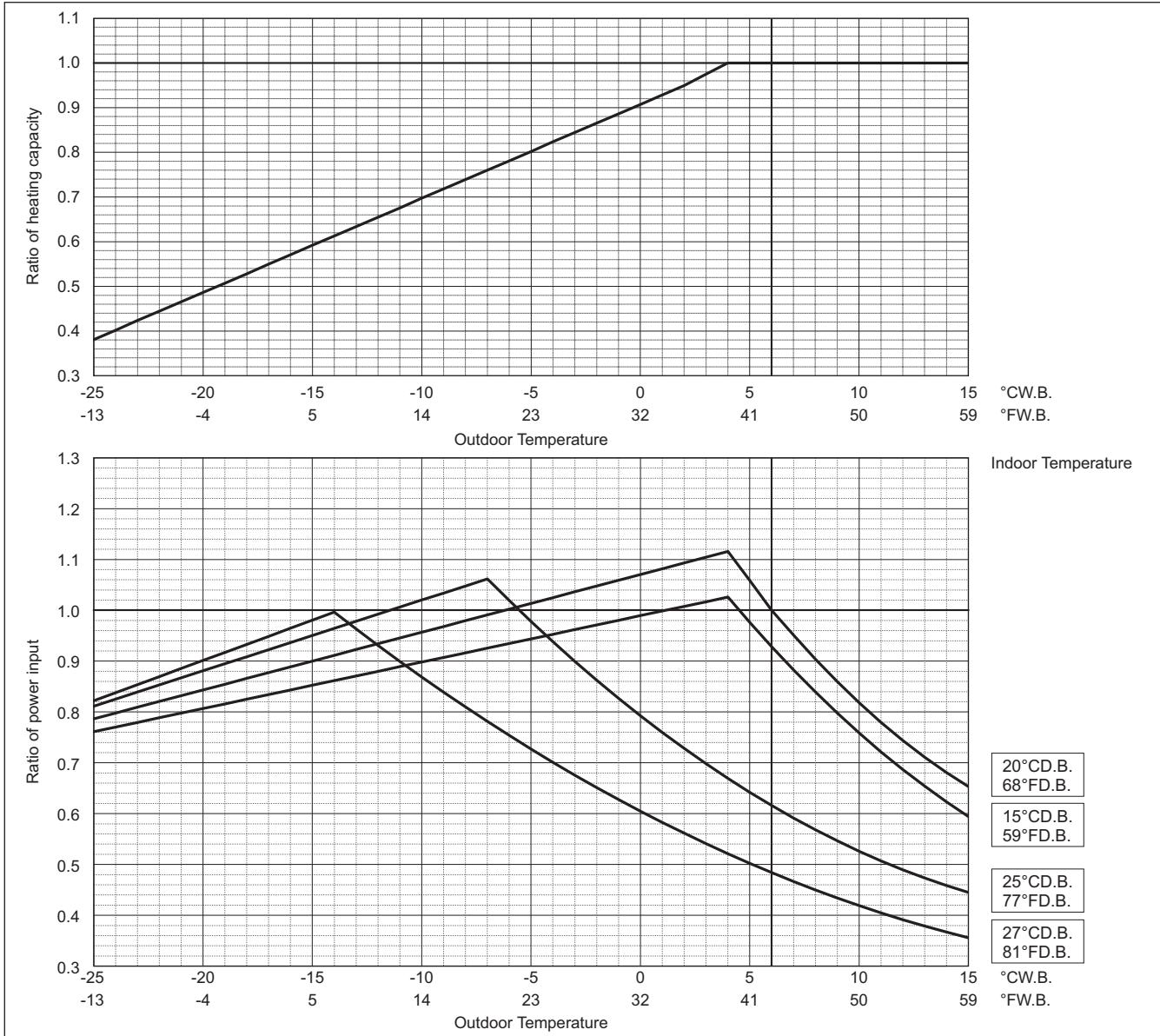

8-3. Correction by total indoor units

CITY MULTI system has different capacities and inputs when many combinations of indoor units with different total capacities are connected. Using following tables, the maximum capacity can be found to ensure the system is installed with enough capacity for a particular application.

PURY-M200YXM-A		
Cooling Capacity	kW	22.4
	BTU/h	76,400
Input	kW	5.53

PURY-M200YXM-A		
Heating Capacity	kW	25.0
	BTU/h	85,300
Input	kW	5.65

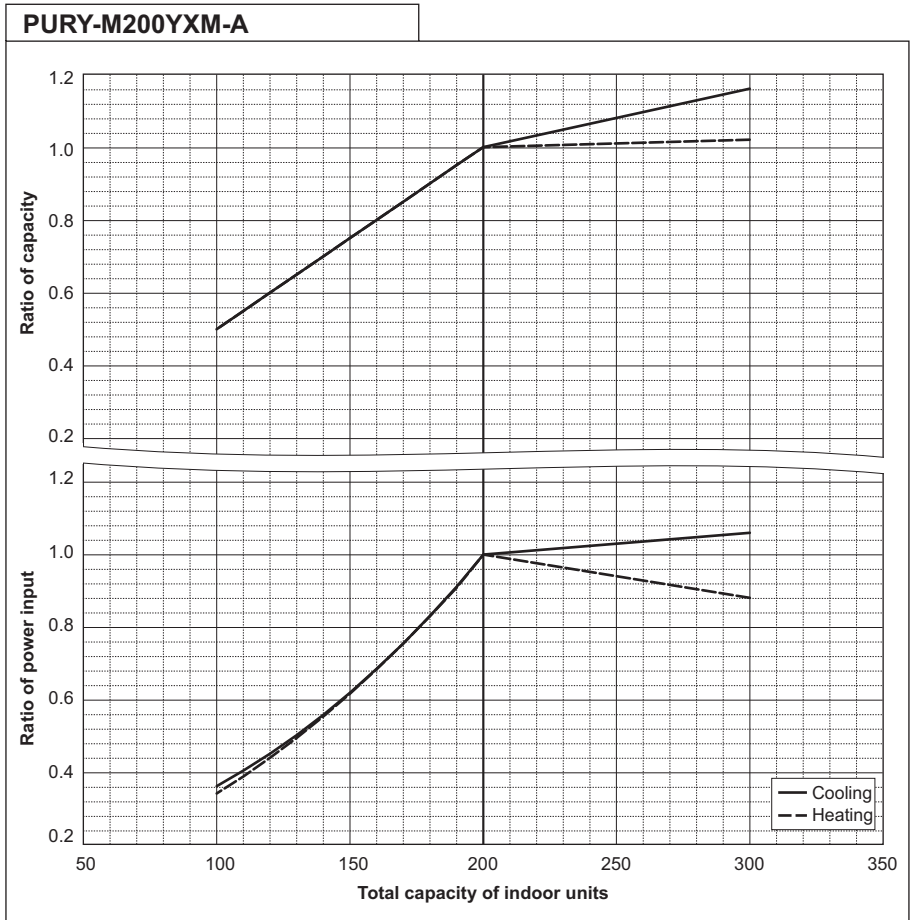

PURY-M250YXM-A		
Cooling Capacity	kW	28.0
	BTU/h	95,500
Input	kW	7.79

PURY-M250YXM-A		
Heating Capacity	kW	31.5
	BTU/h	107,500
Input	kW	7.79

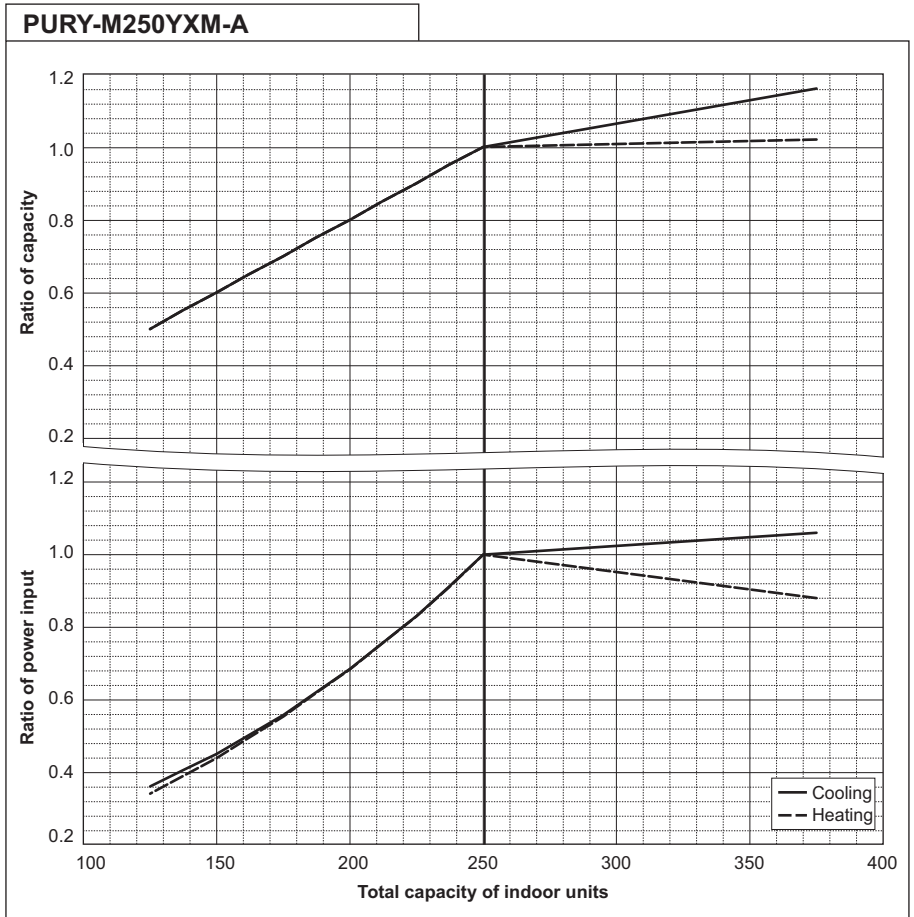

PURY-M300XMA-A		
Cooling Capacity	kW	33.5
	BTU/h	114,300
Input	kW	9.43

PURY-M300XMA-A		
Heating Capacity	kW	37.5
	BTU/h	128,000
Input	kW	9.61

PURY-M300XMA-A

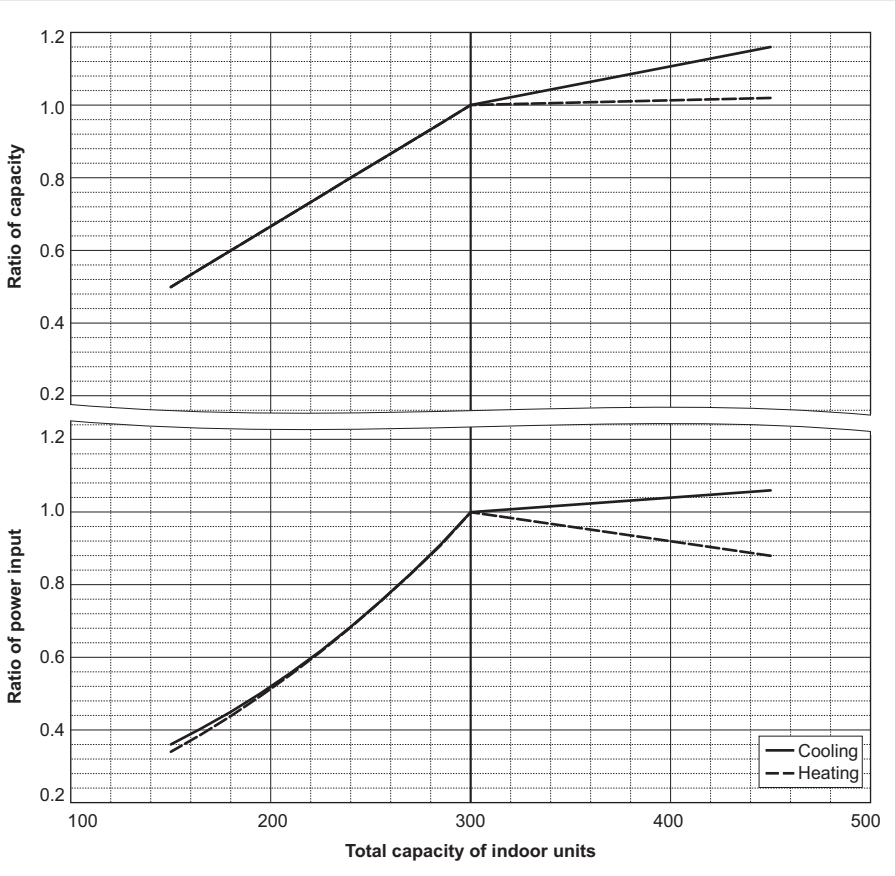

PURY-M350XMA-A		
Cooling Capacity	kW	40.0
	BTU/h	136,500
Input	kW	11.62

PURY-M350XMA-A		
Heating Capacity	kW	45.0
	BTU/h	153,500
Input	kW	12.64

PURY-M350XMA-A

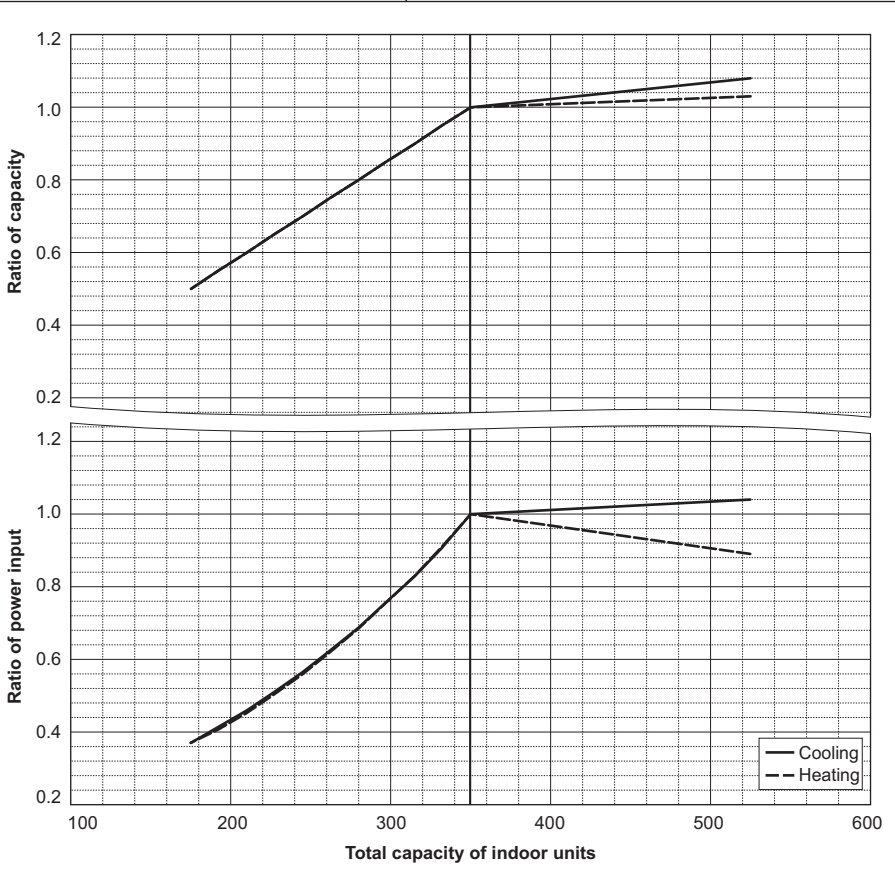

PURY-M400YXM-A		
Cooling Capacity	kW	45.0
	BTU/h	153,500
Input	kW	13.39

PURY-M400YXM-A		
Heating Capacity	kW	50.0
	BTU/h	170,600
Input	kW	14.04

PURY-M400YXM-A

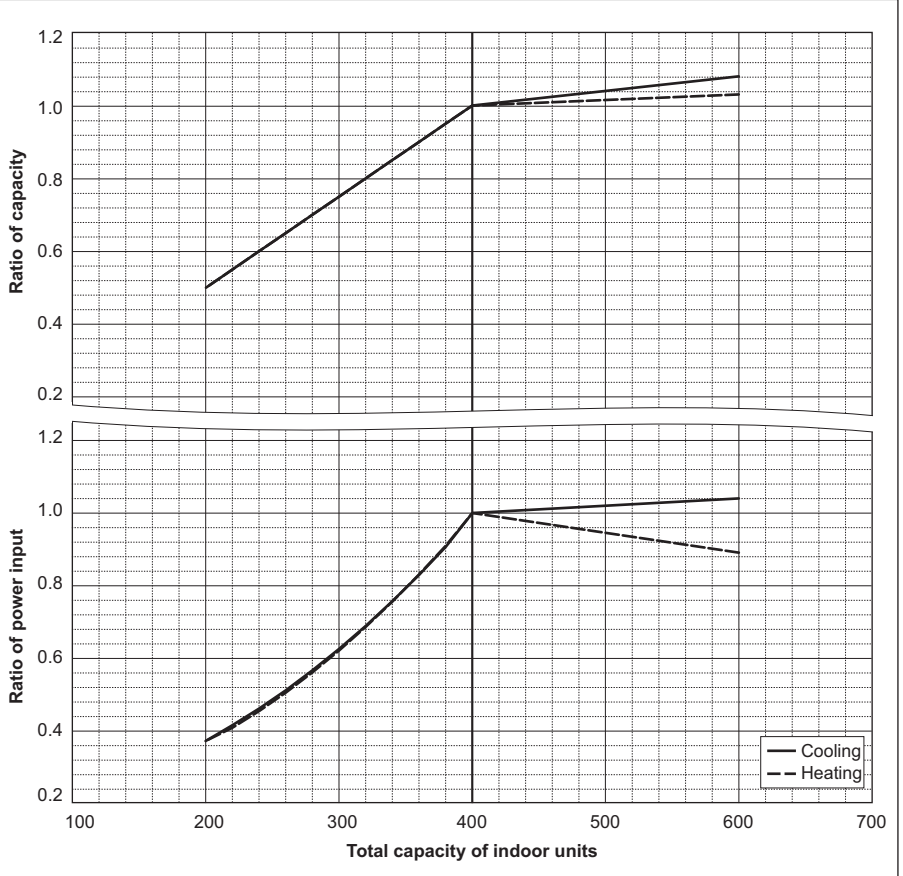

PURY-M450YXM-A		
Cooling Capacity	kW	50.0
	BTU/h	170,600
Input	kW	15.47

PURY-M450YXM-A		
Heating Capacity	kW	56.0
	BTU/h	191,100
Input	kW	16.66

PURY-M450YXM-A

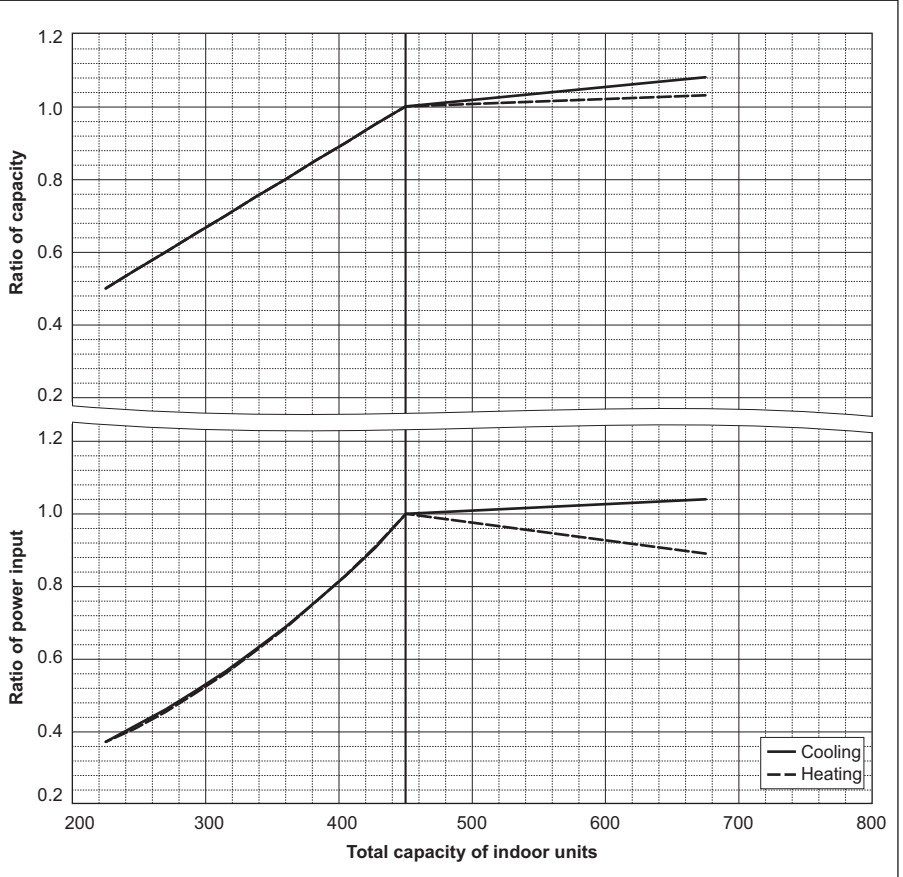

PURY-M-Y(S)XM-A

PURY-M500YXM-A		
Cooling Capacity	kW	56.0
	BTU/h	191,100
Input	kW	19.71

PURY-M500YXM-A		
Heating Capacity	kW	58.0
	BTU/h	197,900
Input	kW	17.41

PURY-M500YXM-A

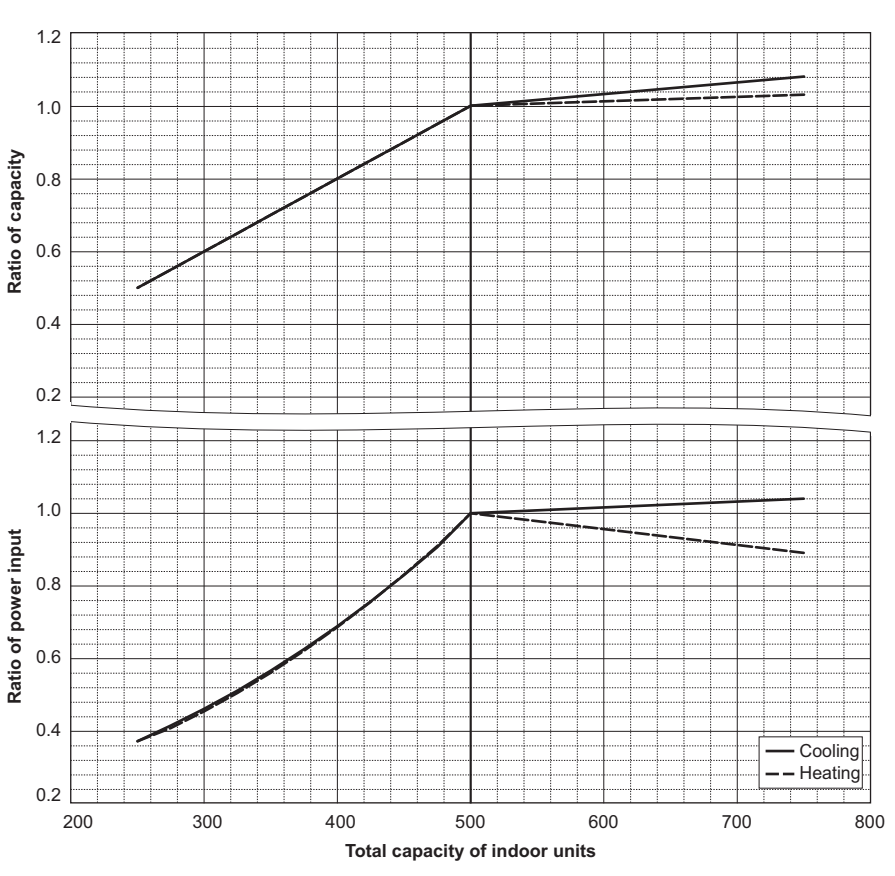

PURY-M400YSXM-A		
Cooling Capacity	kW	44.8
	BTU/h	152,900
Input	kW	11.17

PURY-M400YSXM-A		
Heating Capacity	kW	50.0
	BTU/h	170,600
Input	kW	11.68

PURY-M400YSXM-A

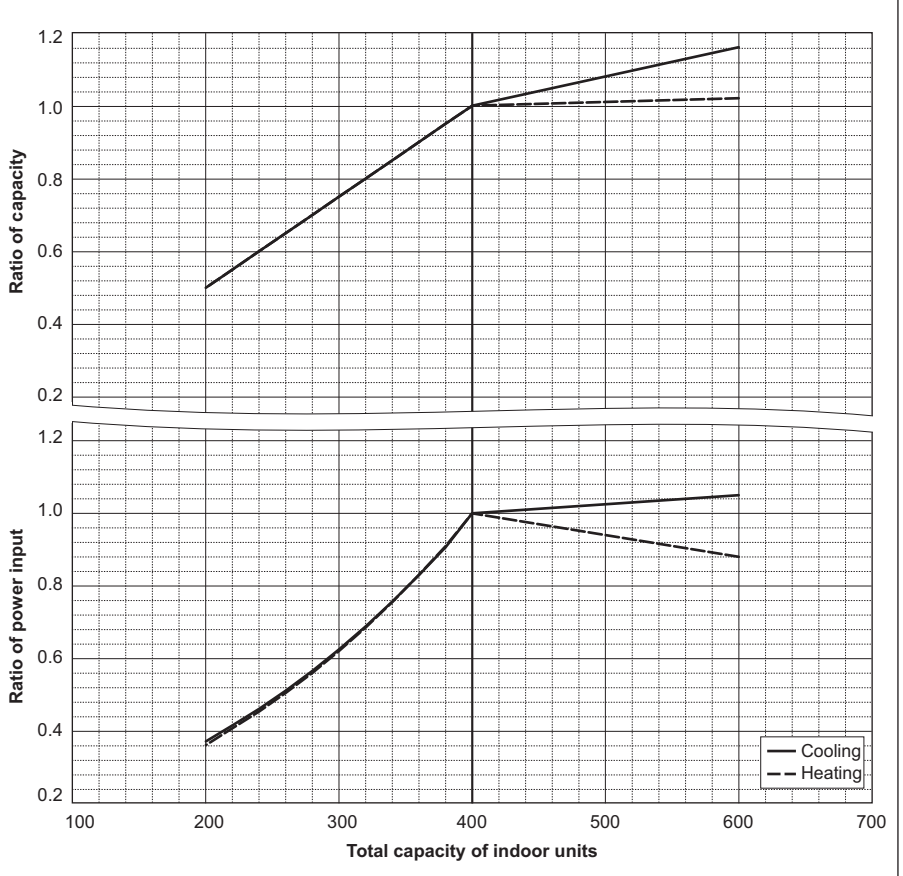

PURY-M450YSXM-A		
Cooling Capacity	kW	50.4
	BTU/h	172,000
Input	kW	13.44

PURY-M450YSXM-A		
Heating Capacity	kW	56.5
	BTU/h	192,800
Input	kW	13.78

PURY-M450YSXM-A

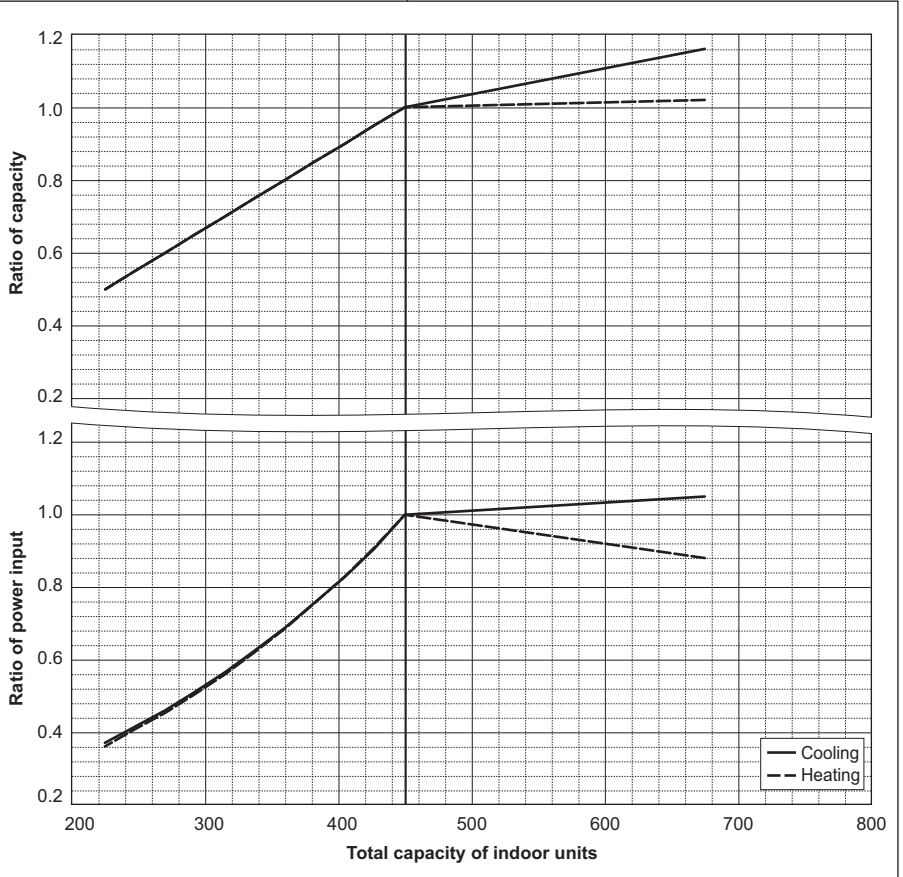

PURY-M-Y(S)XM-A

PURY-M500YSXM-A		
Cooling Capacity	kW	56.0
	BTU/h	191,100
Input	kW	16.00

PURY-M500YSXM-A		
Heating Capacity	kW	63.0
	BTU/h	215,000
Input	kW	16.11

PURY-M500YSXM-A

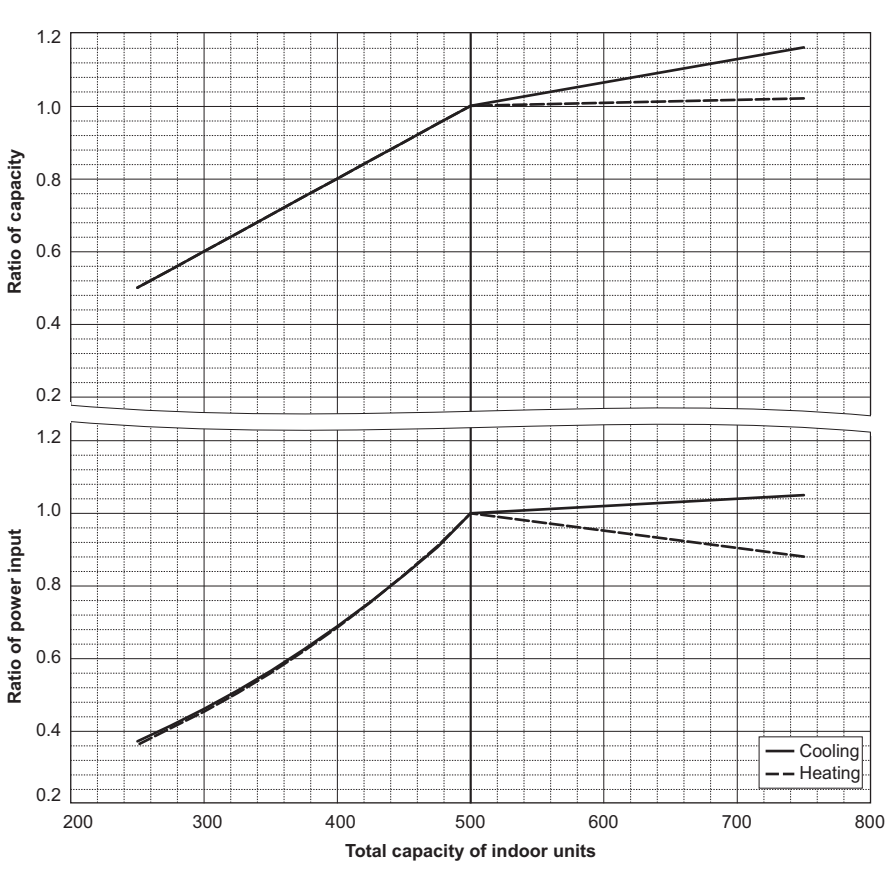

PURY-M550YSXM-A		
Cooling Capacity	kW	61.5
	BTU/h	209,800
Input	kW	17.67

PURY-M550YSXM-A		
Heating Capacity	kW	69.0
	BTU/h	235,400
Input	kW	17.92

PURY-M550YSXM-A

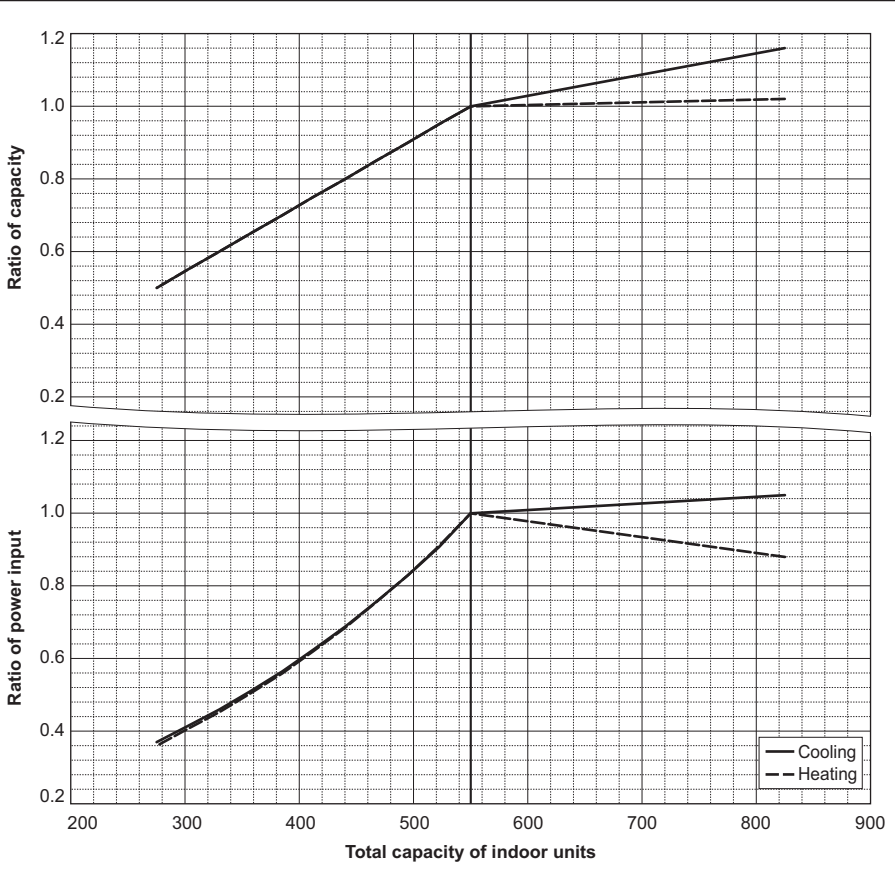

PURY-M600YSXM-A		
Cooling Capacity	kW	67.0
	BTU/h	228,600
Input	kW	19.36

PURY-M600YSXM-A		
Heating Capacity	kW	75.0
	BTU/h	255,900
Input	kW	19.84

PURY-M600YSXM-A

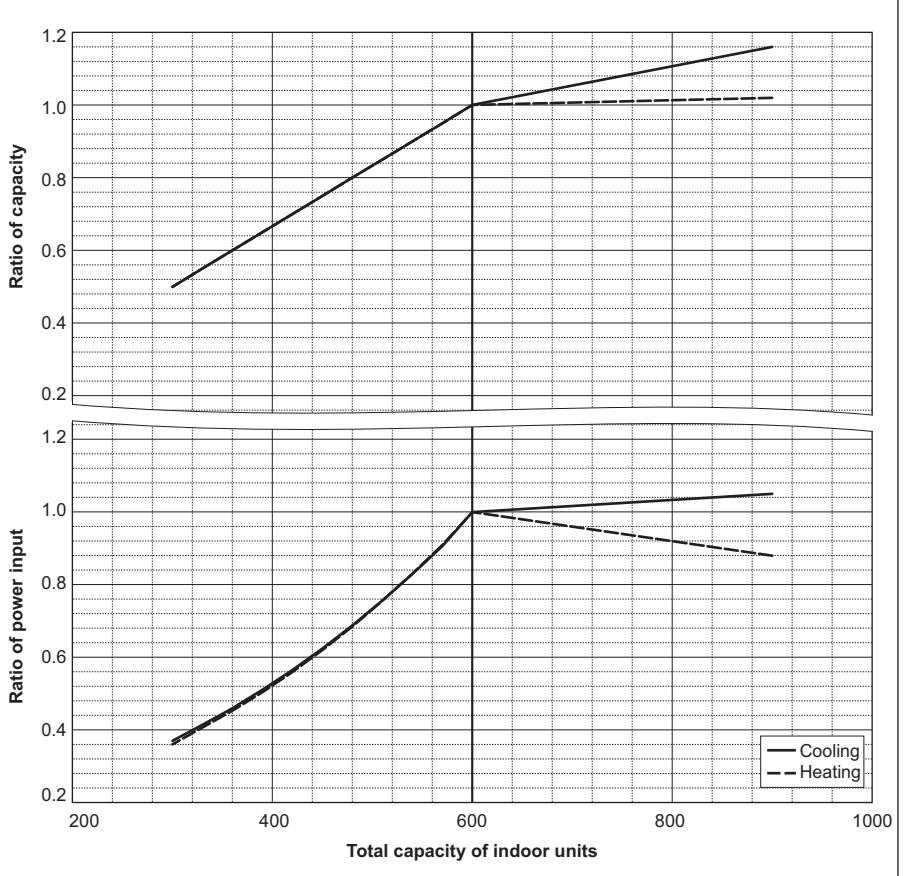

PURY-M650YSXM-A		
Cooling Capacity	kW	73.5
	BTU/h	250,800
Input	kW	21.87

PURY-M650YSXM-A		
Heating Capacity	kW	82.5
	BTU/h	281,500
Input	kW	22.85

PURY-M650YSXM-A

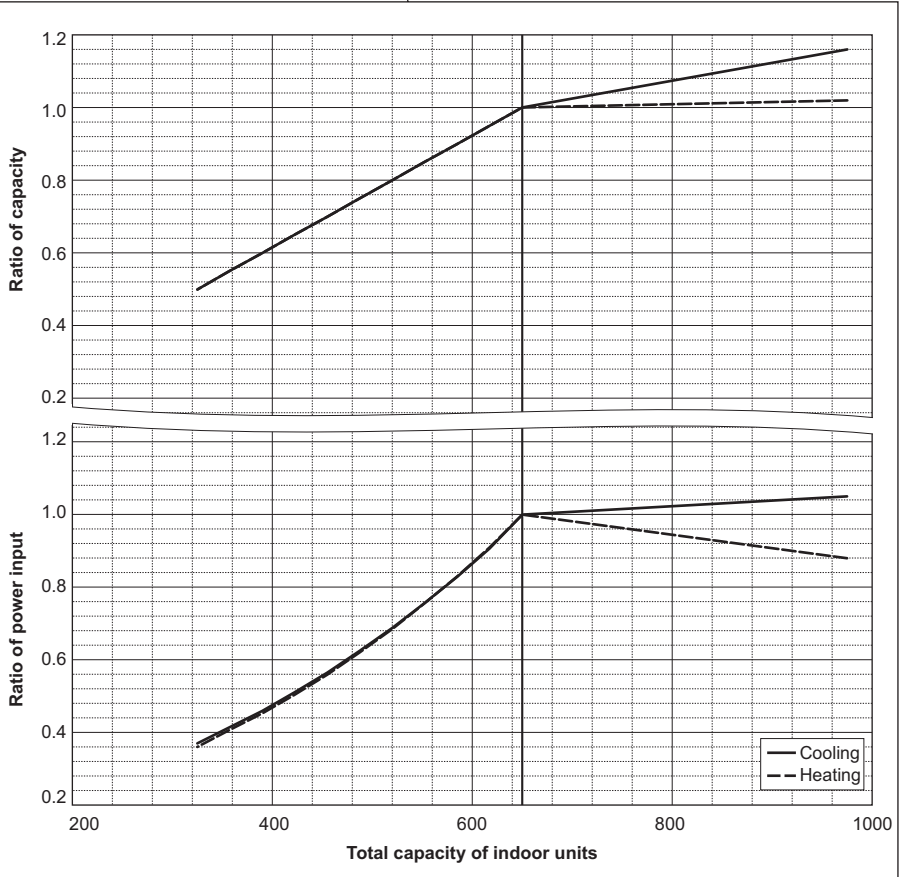

PURY-M-Y(S)XM-A

PURY-M700YSXM-A		
Cooling Capacity	kW	80.0
	BTU/h	273,000
Input	kW	23.80

PURY-M700YSXM-A		
Heating Capacity	kW	90.0
	BTU/h	307,100
Input	kW	26.08

PURY-M700YSXM-A

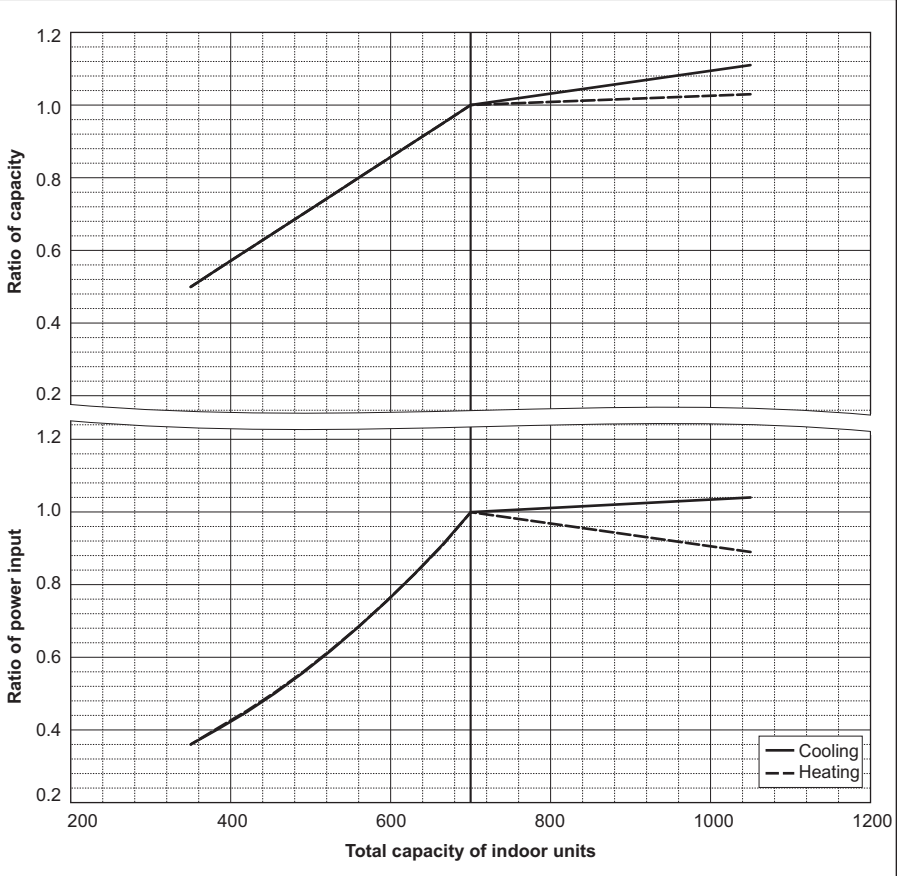

PURY-M750YSXM-A		
Cooling Capacity	kW	85.0
	BTU/h	290,000
Input	kW	25.67

PURY-M750YSXM-A		
Heating Capacity	kW	95.0
	BTU/h	324,100
Input	kW	27.53

PURY-M750YSXM-A

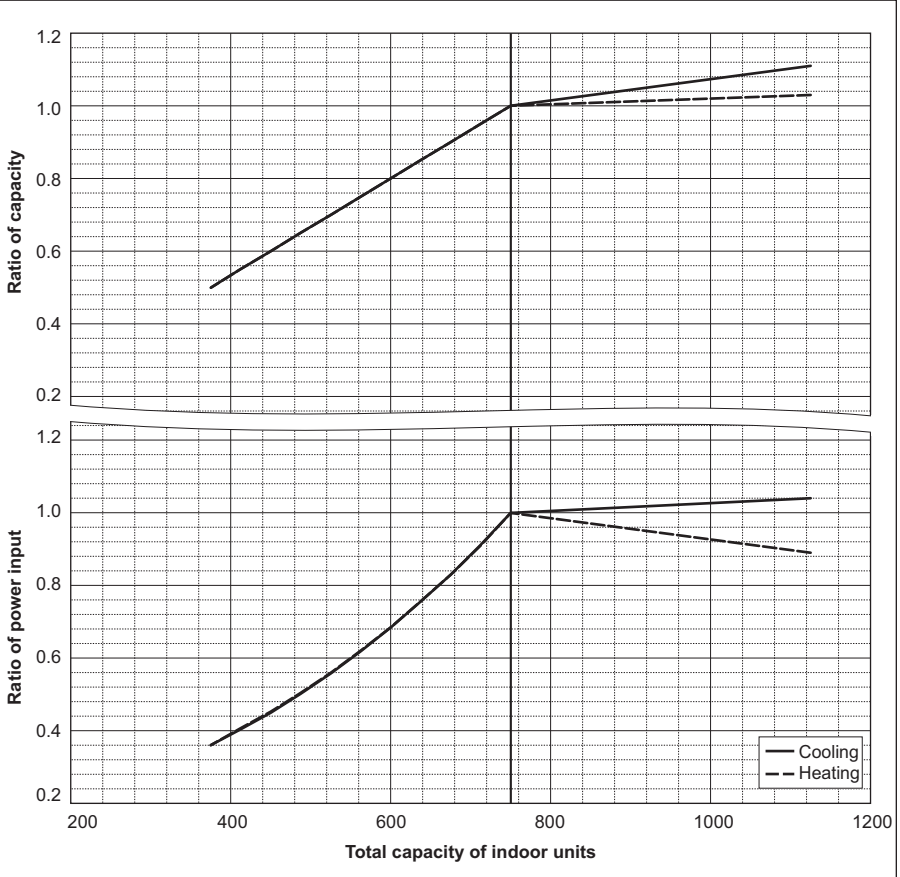

PURY-M800YSXM-A		
Cooling Capacity	kW	90.0
	BTU/h	307,100
Input	kW	27.60

PURY-M800YSXM-A		
Heating Capacity	kW	100.0
	BTU/h	341,200
Input	kW	28.98

PURY-M800YSXM-A

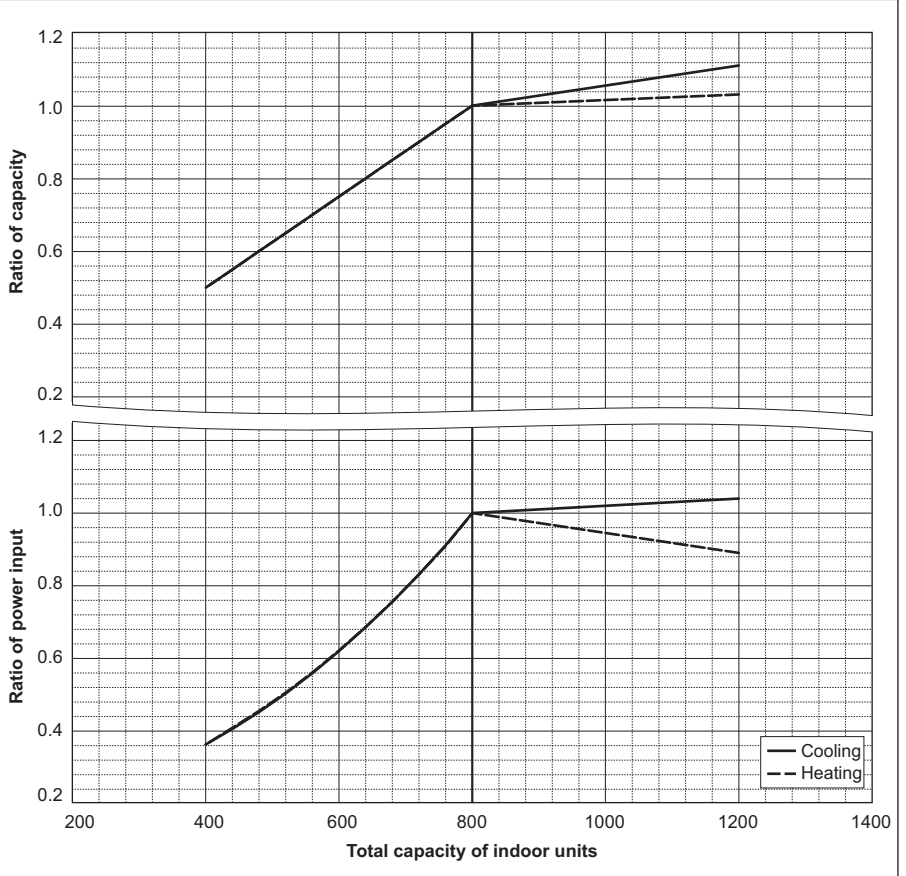

PURY-M850YSXM-A		
Cooling Capacity	kW	95.0
	BTU/h	324,100
Input	kW	29.59

PURY-M850YSXM-A		
Heating Capacity	kW	106.0
	BTU/h	361,700
Input	kW	31.64

PURY-M850YSXM-A

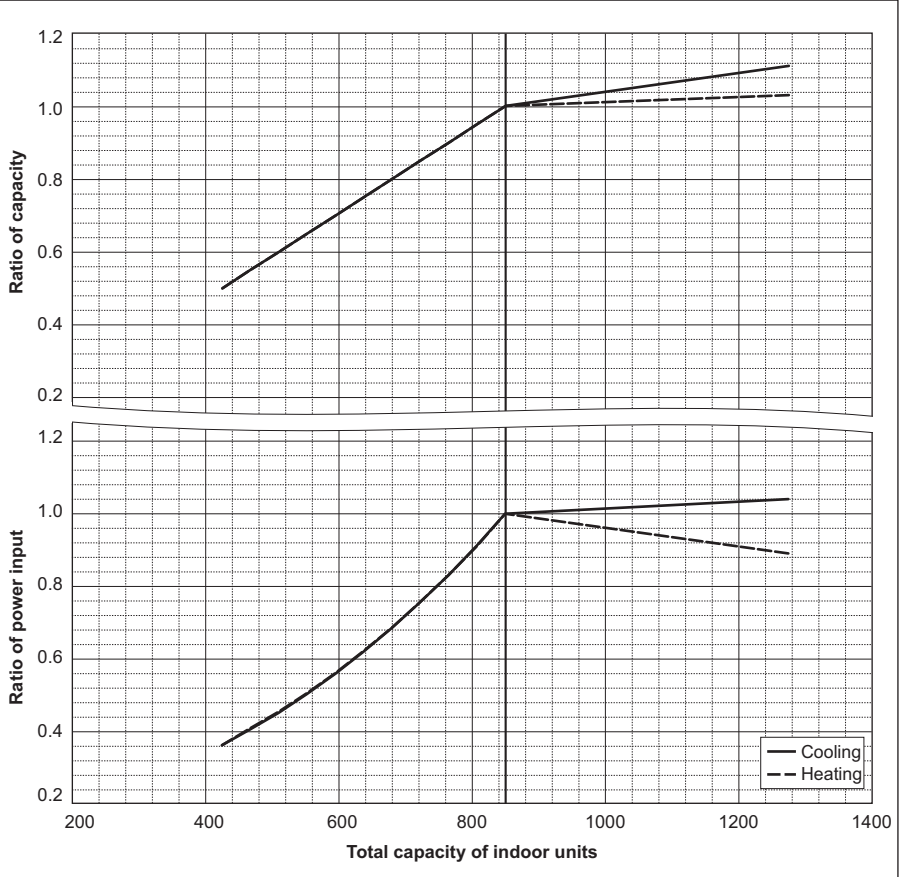

PURY-M-Y(S)XM-A

PURY-M900YSXM-A		
Cooling Capacity	kW	100.0
	BTU/h	341,200
Input	kW	31.94

PURY-M900YSXM-A		
Heating Capacity	kW	112.0
	BTU/h	382,100
Input	kW	34.46

PURY-M900YSXM-A

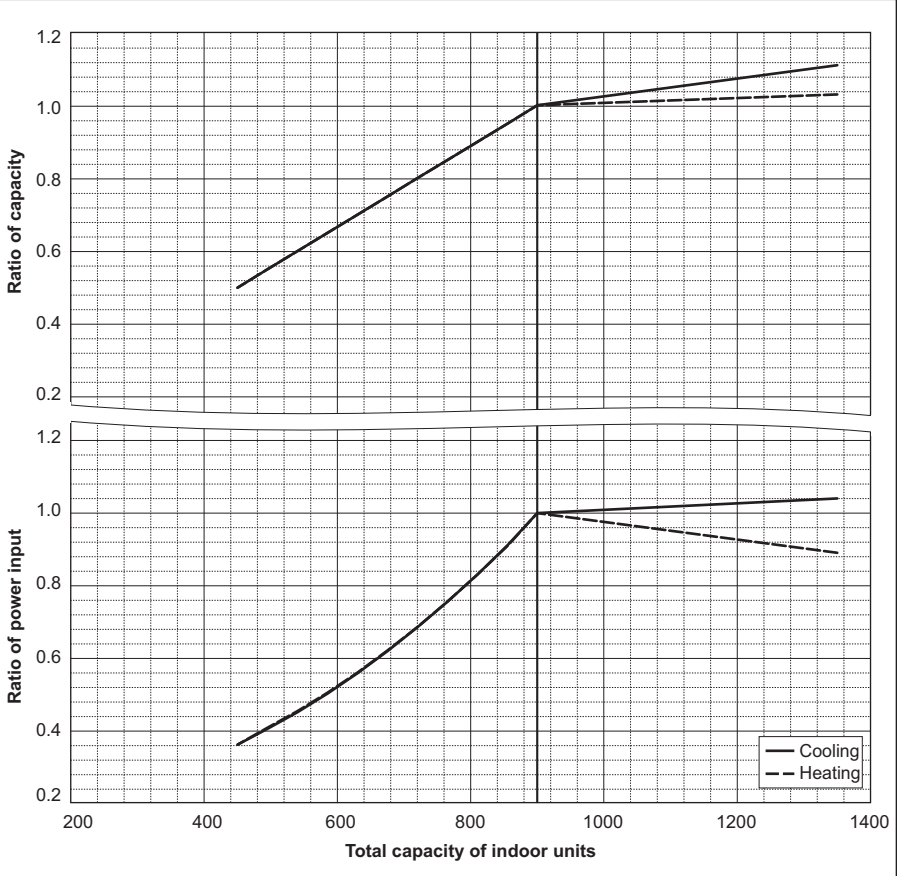

PURY-M950YSXM-A		
Cooling Capacity	kW	106.0
	BTU/h	361,700
Input	kW	36.05

PURY-M950YSXM-A		
Heating Capacity	kW	114.0
	BTU/h	389,000
Input	kW	35.18

PURY-M950YSXM-A

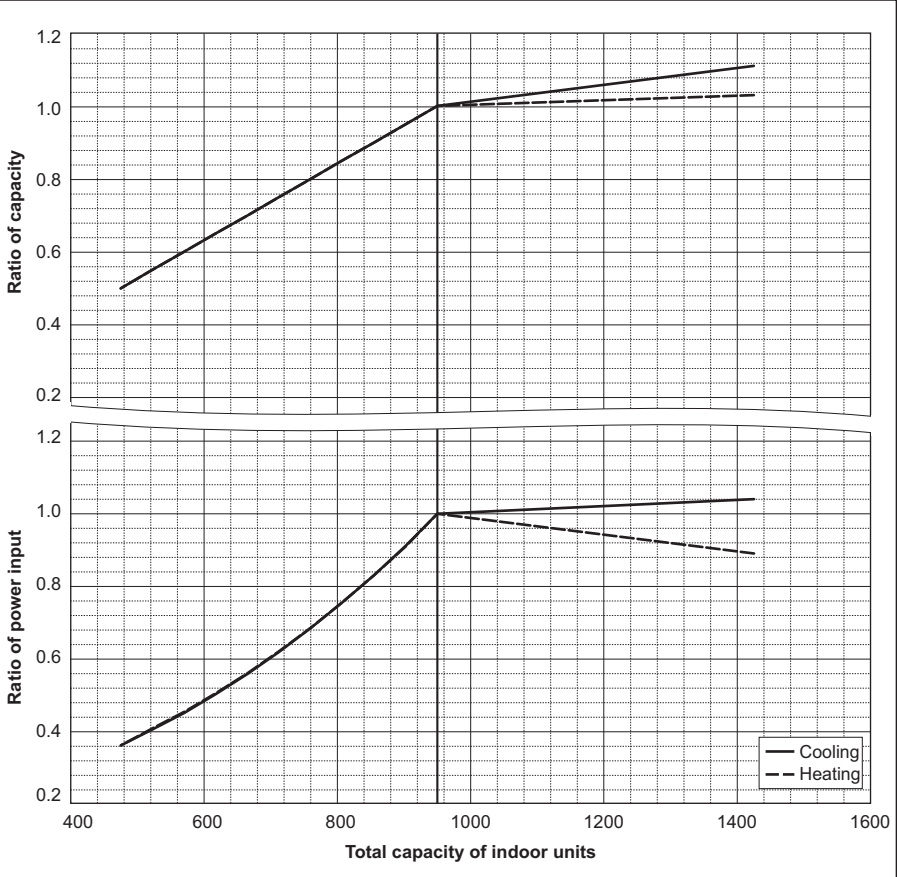

PURY-M1000YSXM-A		
Cooling Capacity	kW	112.0
	BTU/h	382,100
Input	kW	40.87

PURY-M1000YSXM-A		
Heating Capacity	kW	116.0
	BTU/h	395,800
Input	kW	35.91

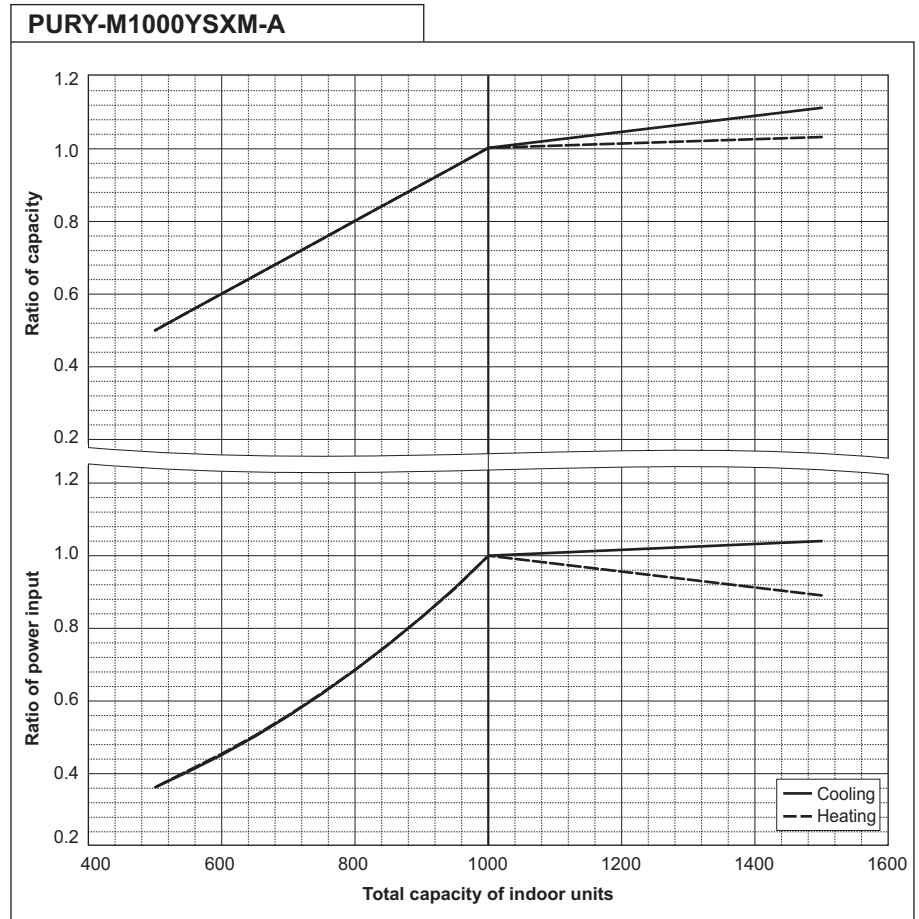

PURY-M-Y(S)XM-A

8-4. Correction by refrigerant piping length

CITY MULTI system can extend the piping flexibly within its limitation for the actual situation. However, a decrease of cooling/heating capacity could happen correspondently. Using following correction factor according to the equivalent length of the piping shown at 8-4-1 and 8-4-2, the capacity can be observed. 8-4-3 shows how to obtain the equivalent length of piping.

8-4-1. Cooling capacity correction

PURY-M-Y(S)XM-A

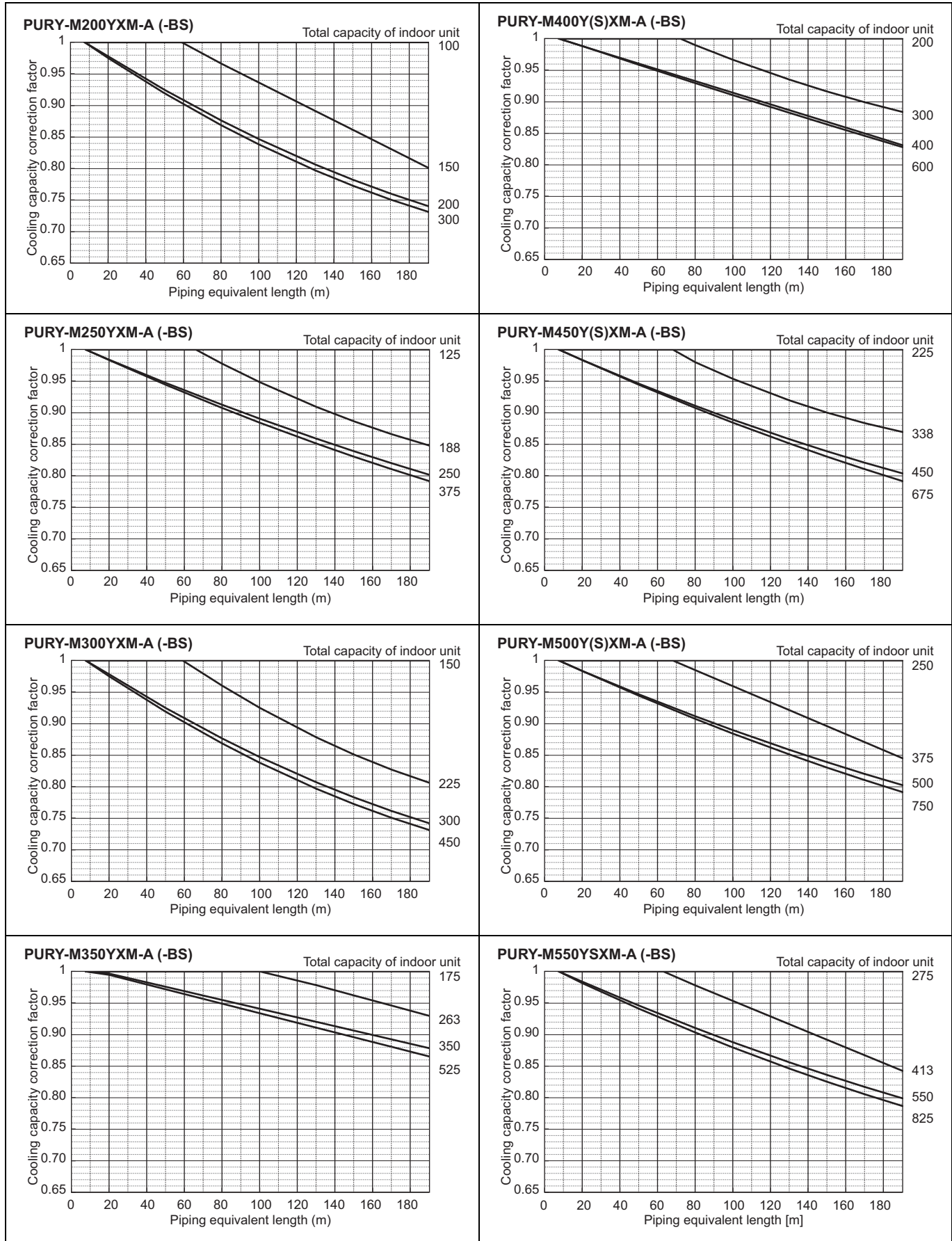

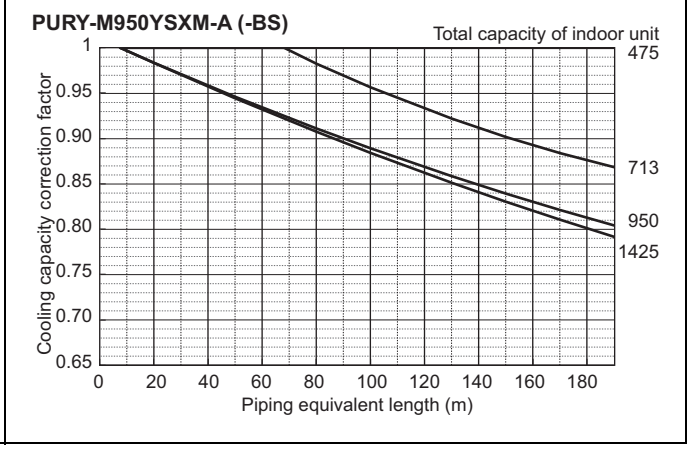
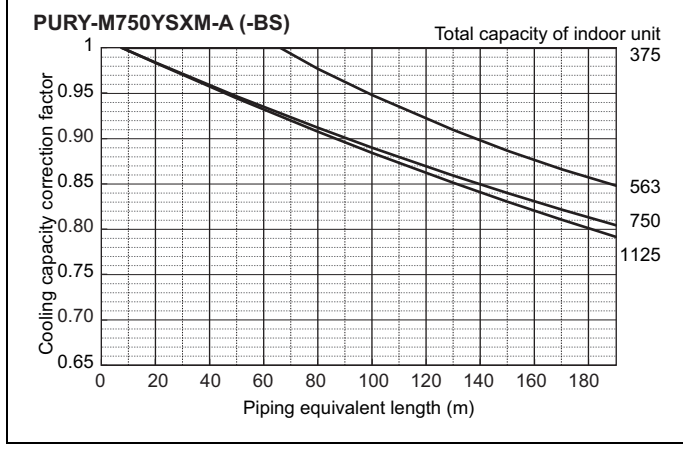
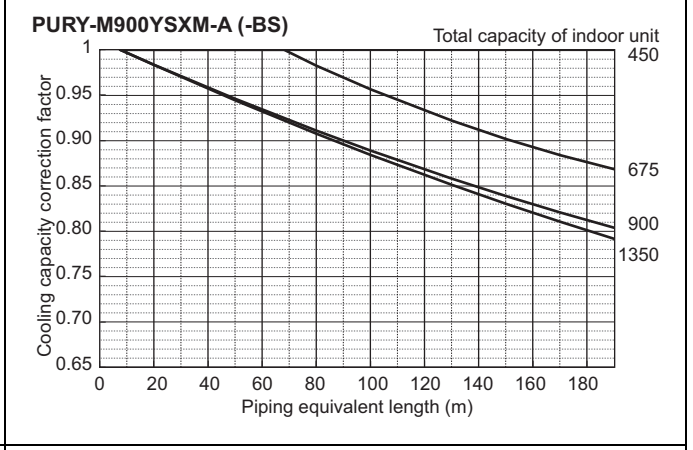
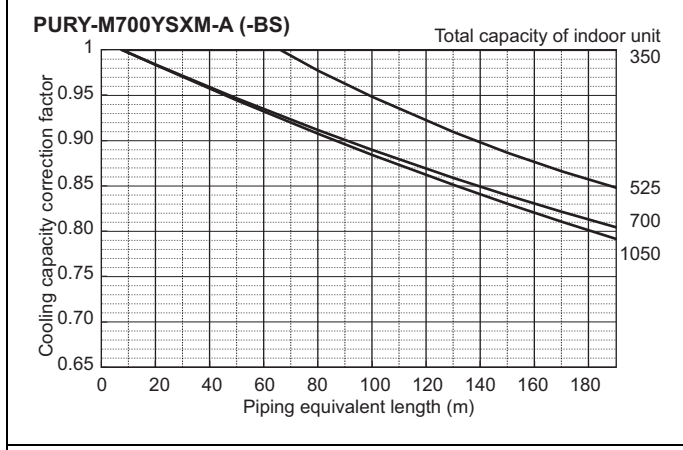
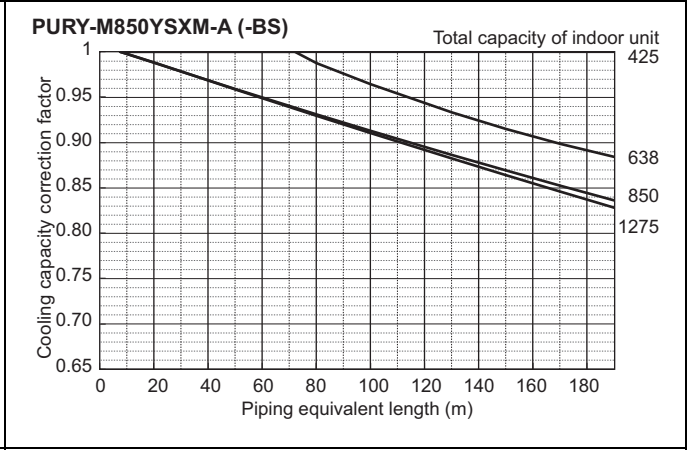
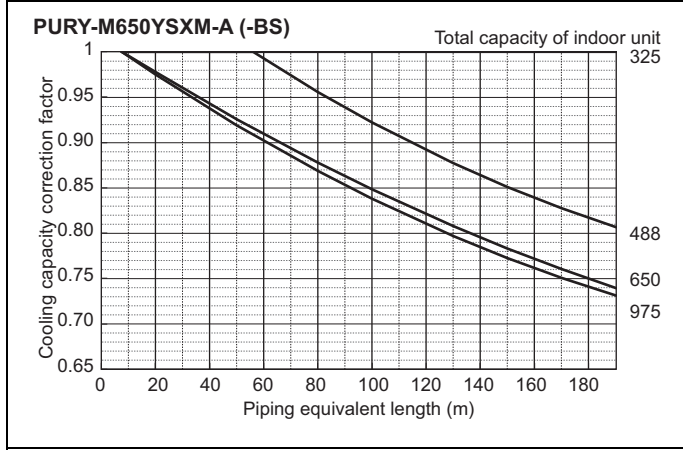
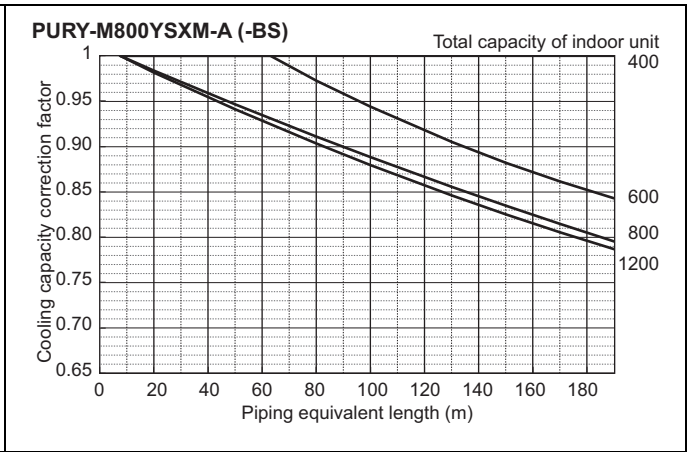
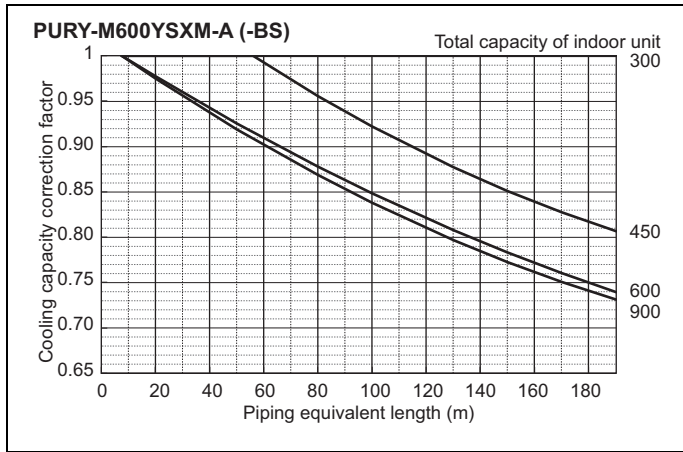

PURY-M-Y(S)XM-A

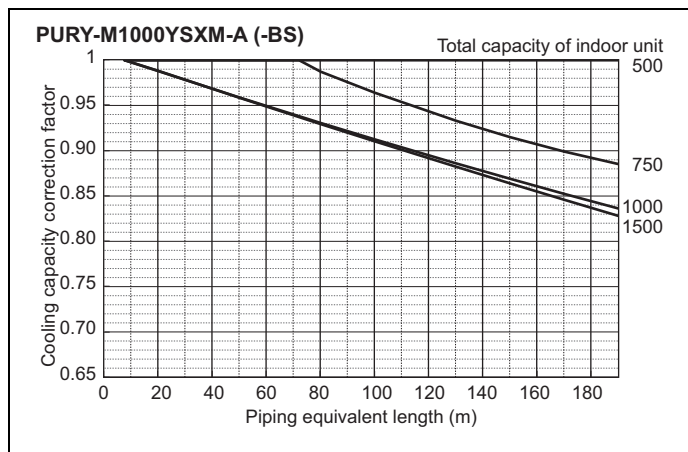

8-4-2. Heating capacity correction

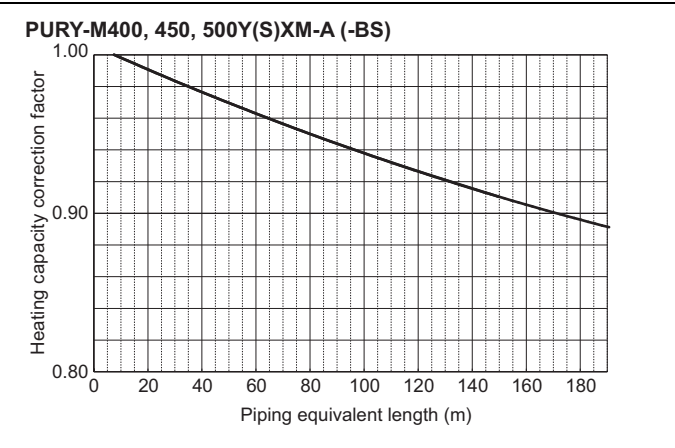
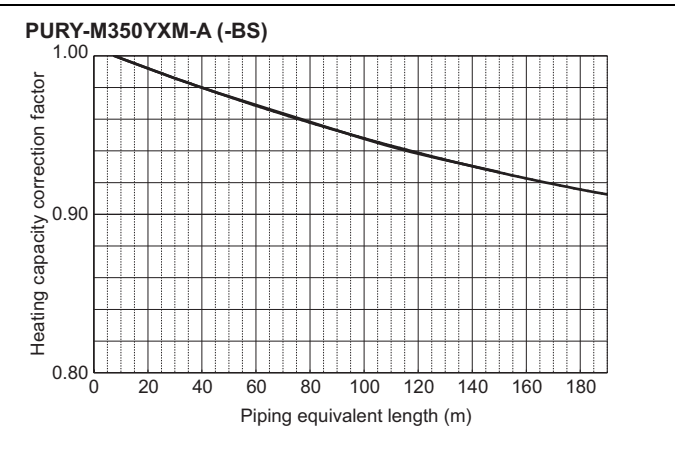
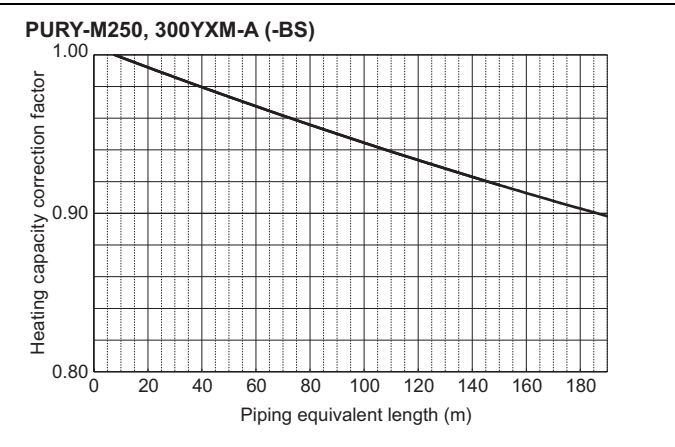
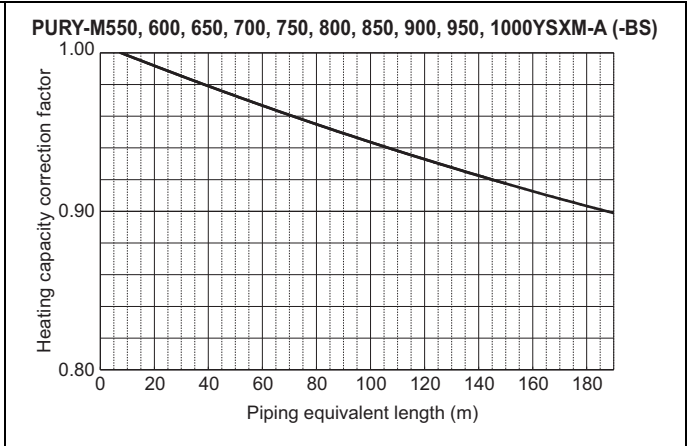
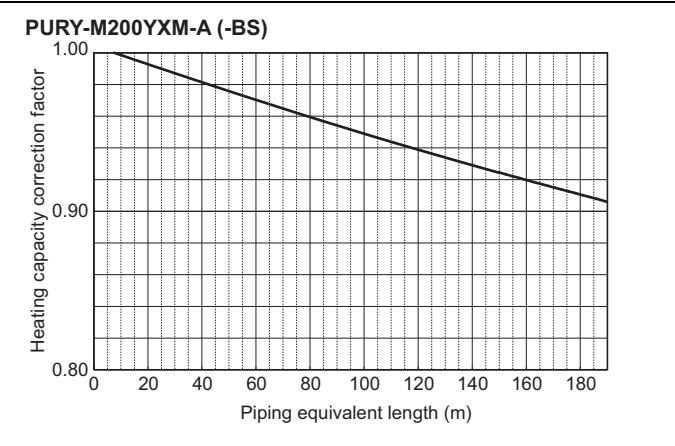

PURY-M-Y(S)XM-A

8-4-3. How to obtain the equivalent piping length

1. PURY-M200YXM-A (-BS)

Equivalent length = (Actual piping length to the farthest indoor unit) + (0.35 × number of bends in the piping) m

2. PURY-M250, 300YXM-A (-BS)

Equivalent length = (Actual piping length to the farthest indoor unit) + (0.42 × number of bends in the piping) m

3. PURY-M350YXM-A (-BS)

Equivalent length = (Actual piping length to the farthest indoor unit) + (0.47 × number of bends in the piping) m

4. PURY-M400, 450, 500, 550, 600, 650Y(S)XM-A (-BS)

Equivalent length = (Actual piping length to the farthest indoor unit) + (0.50 × number of bends in the piping) m

5. PURY-M700, 750, 800YSXM-A (-BS)

Equivalent length = (Actual piping length to the farthest indoor unit) + (0.70 × number of bends in the piping) m

6. PURY-M850, 900, 950, 1000YSXM-A (-BS)

Equivalent length = (Actual piping length to the farthest indoor unit) + (0.80 × number of bends in the piping) m

8-5. Correction by port counts of the BC controller

Indoor unit sizes MS200 and MS250 must be connected to 2 ports on the BC controller.

Indoor unit sizes from M100 to M140 should normally be connected to 2 ports on the BC controller (set BC controller DIP-SW 1-1 to its ON position).

In cases whereby indoor unit sizes from M100 to M140 or total capacity indoor units from 81 to 140 are connected to only 1port on the BC controller (set BC controller DIP-SW 1-1 to its OFF position), the cooling capacity of the outdoor unit should be multiplied by a correction factor of **0.98**.

8-6. Correction at frost and defrost

Due to frost at the outdoor heat exchanger and the automatic defrost operation, the heating capacity of the outdoor unit can be calculated by multiplying the correction factor shown in the table below.

Table of correction factor at frosting and defrosting

Outdoor inlet air temp. °CWB	6	4	2	1	0	-2	-4	-6	-8	-10	-20	-25
Outdoor inlet air temp. °FWB	43	39	36	34	32	28	25	21	18	14	-4	-13
PURY-M200YXM	1.00	0.93	0.86	0.83	0.83	0.78	0.83	0.88	0.88	0.90	0.90	0.90
PURY-M250YXM	1.00	0.93	0.86	0.83	0.83	0.78	0.83	0.88	0.88	0.90	0.90	0.90
PURY-M300YXM	1.00	0.93	0.86	0.83	0.83	0.78	0.83	0.88	0.88	0.90	0.90	0.90
PURY-M350YXM	1.00	0.88	0.76	0.70	0.72	0.73	0.80	0.88	0.88	0.90	0.90	0.90
PURY-M400YXM	1.00	0.90	0.80	0.76	0.77	0.75	0.81	0.88	0.88	0.90	0.90	0.90
PURY-M450YXM	1.00	0.87	0.75	0.69	0.71	0.71	0.79	0.88	0.88	0.90	0.90	0.90
PURY-M500YXM	1.00	0.87	0.75	0.69	0.71	0.70	0.79	0.88	0.88	0.90	0.90	0.90
PURY-M400YSXM	1.00	0.93	0.86	0.83	0.83	0.78	0.83	0.88	0.88	0.90	0.90	0.90
PURY-M450YSXM	1.00	0.93	0.86	0.83	0.83	0.78	0.83	0.88	0.88	0.90	0.90	0.90
PURY-M500YSXM	1.00	0.93	0.86	0.83	0.83	0.78	0.83	0.88	0.88	0.90	0.90	0.90
PURY-M550YSXM	1.00	0.93	0.86	0.83	0.83	0.78	0.83	0.88	0.88	0.90	0.90	0.90
PURY-M600YSXM	1.00	0.93	0.86	0.83	0.83	0.78	0.83	0.88	0.88	0.90	0.90	0.90
PURY-M650YSXM	1.00	0.88	0.76	0.70	0.72	0.73	0.80	0.88	0.88	0.90	0.90	0.90
PURY-M700YSXM	1.00	0.88	0.76	0.70	0.72	0.73	0.80	0.88	0.88	0.90	0.90	0.90
PURY-M750YSXM	1.00	0.88	0.76	0.70	0.72	0.73	0.80	0.88	0.88	0.90	0.90	0.90
PURY-M800YSXM	1.00	0.90	0.80	0.76	0.77	0.75	0.81	0.88	0.88	0.90	0.90	0.90
PURY-M850YSXM	1.00	0.87	0.75	0.69	0.71	0.71	0.79	0.88	0.88	0.90	0.90	0.90
PURY-M900YSXM	1.00	0.87	0.75	0.69	0.71	0.71	0.79	0.88	0.88	0.90	0.90	0.90
PURY-M950YSXM	1.00	0.87	0.75	0.69	0.71	0.70	0.79	0.88	0.88	0.90	0.90	0.90
PURY-M1000YSXM	1.00	0.87	0.75	0.69	0.71	0.70	0.79	0.88	0.88	0.90	0.90	0.90

Note

- ♦ The high humidity condition (e.g., a foggy atmosphere) which causes frost forming on the heat exchanger will worsen the heating performance of the unit.
- ♦ The snow blowing to the heat exchanger will worsen the heating performance of the unit. Install a snow hood as a preventive measure.

8-7. Correction at evaporation-temperature (ET) control

When the target evaporation temperature is changed, the capacity or the power input can be calculated by multiplying the correction factor shown in the table below.

ET *1	°C	6	9	14
Correction factor	Capacity	0.90	0.83	0.55
	Power Input	0.90	0.72	0.36

*1 The evaporation temperature in operation may be different from the preset target evaporation temperature because it depends on such factors as the unit protection control.
The capacity and power input could also fluctuate.

*2 Use the table above which indicates the unit properties as a reference.

9-1. JOINT and REDUCER

CITY MULTI units can be easily connected by using Joint sets and Reducer sets provided by Mitsubishi Electric. Refer to section "Piping Design" or the Installation Manual that comes with the Joint set or Reducer set for how to install the Joint set or Reducer set.

CMY-Y102SS-G2

For Gas pipe:

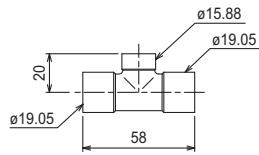

<Deformed pipe(Accessory)>

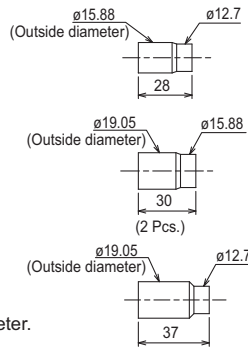

For Liquid pipe:

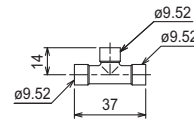

<Deformed pipe(Accessory)>

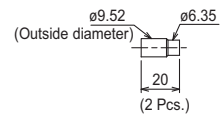

mm

*Pipe diameter is indicated by inside diameter.

CMY-Y102LS-G2

For Gas pipe:

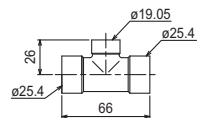

<Deformed pipe(Accessory)>

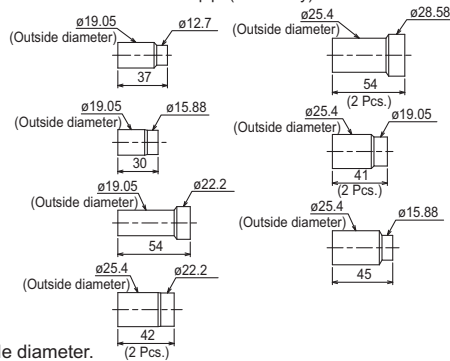

For Liquid pipe:

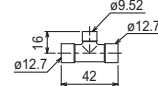

<Deformed pipe(Accessory)>

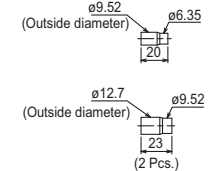

mm

*Pipe diameter is indicated by inside diameter.

CMY-R201S-G

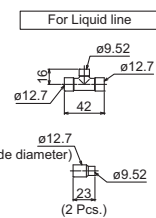
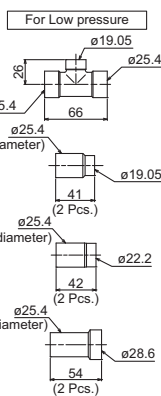
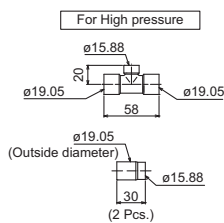

mm

<Accessory>

- Cover3 Pcs.

Note. Pipe diameter is indicated by inside diameter.

CMY-R202S-G

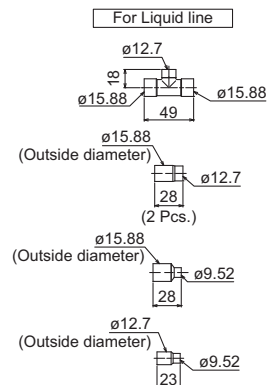
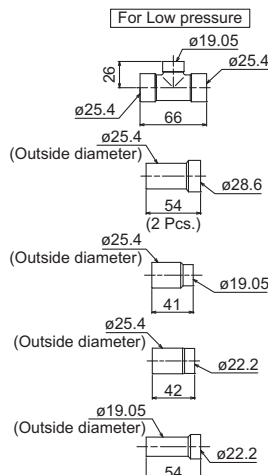
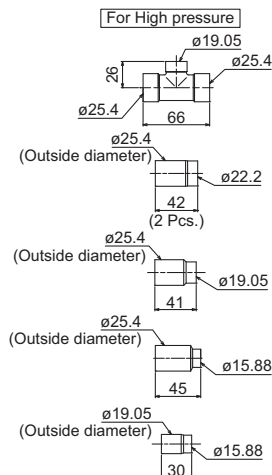

mm

<Accessory>

- Cover3 Pcs.

Note. Pipe diameter is indicated by inside diameter.

CMY-R203S-G

mm

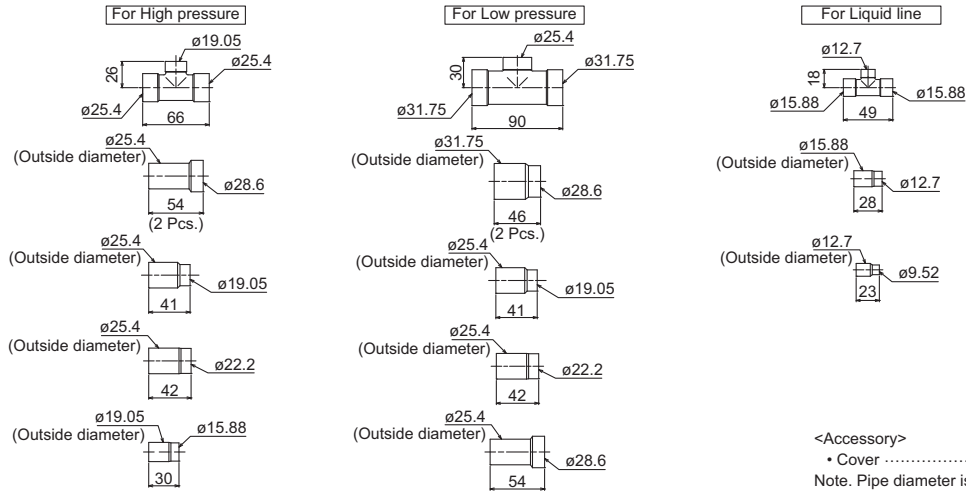

CMY-R204S-G

mm

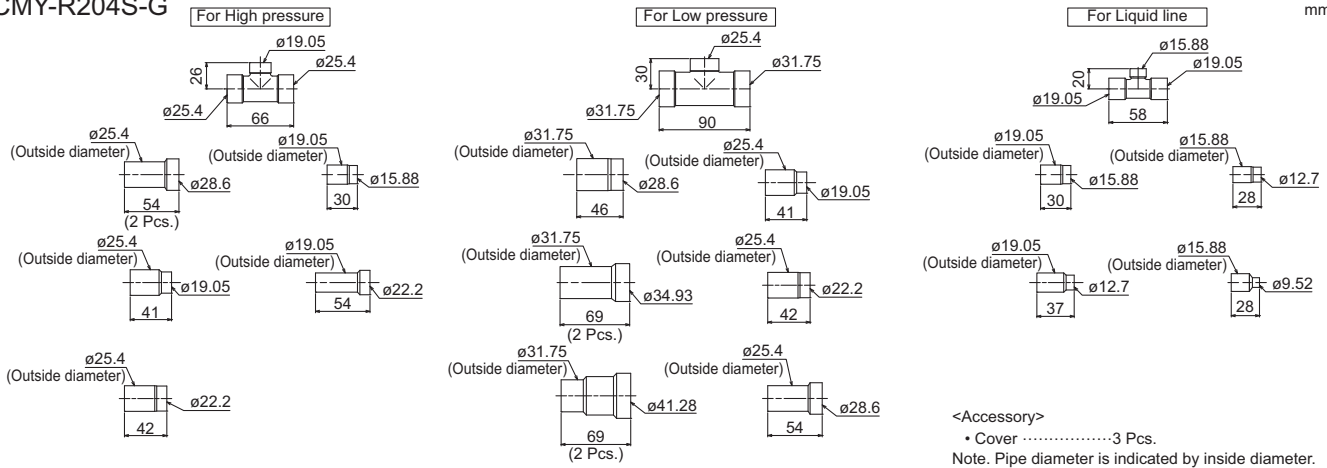

CMY-R205S-G

mm

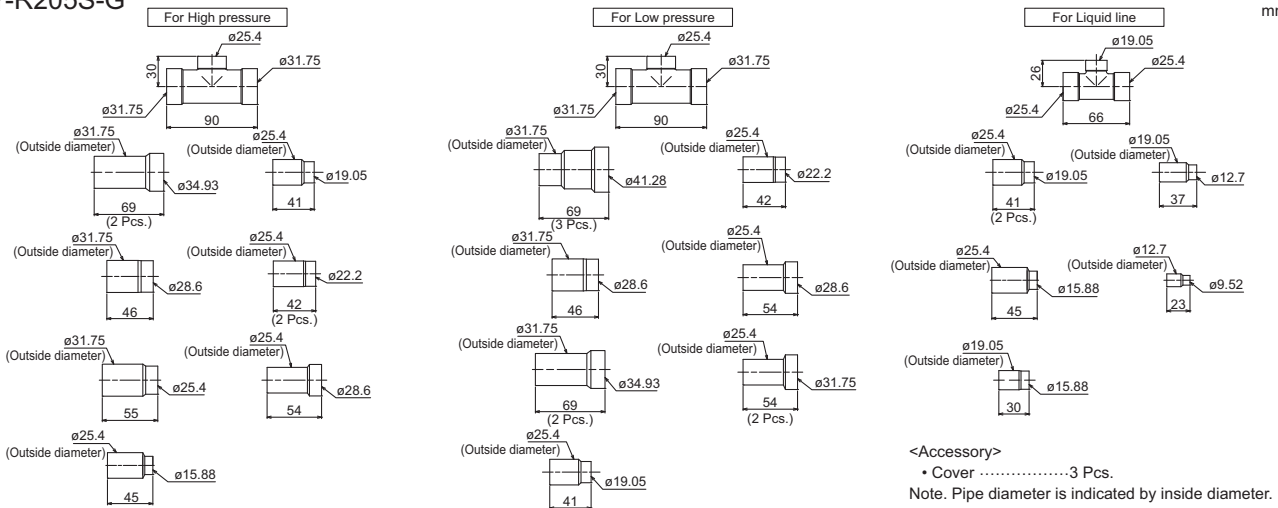

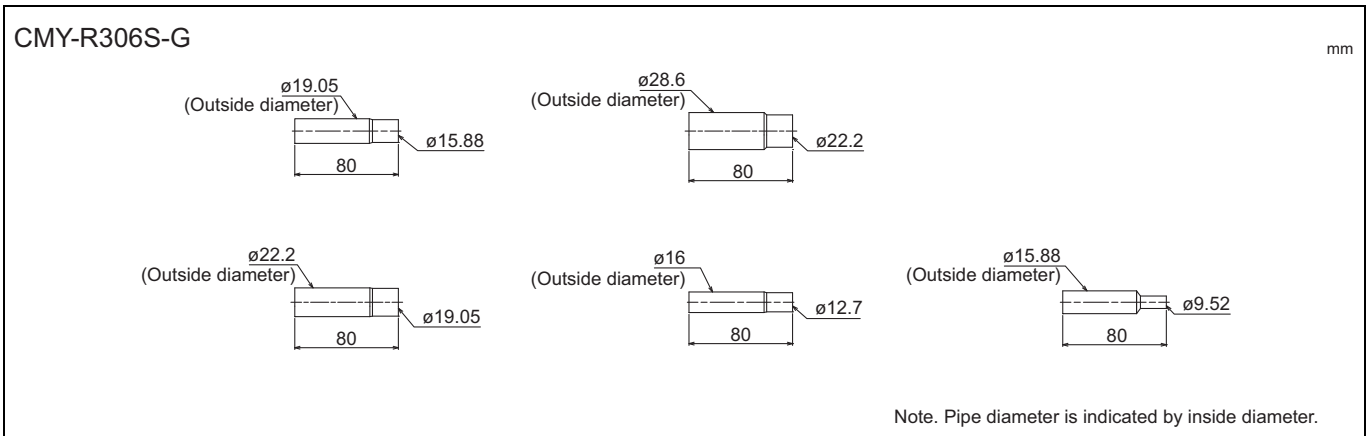
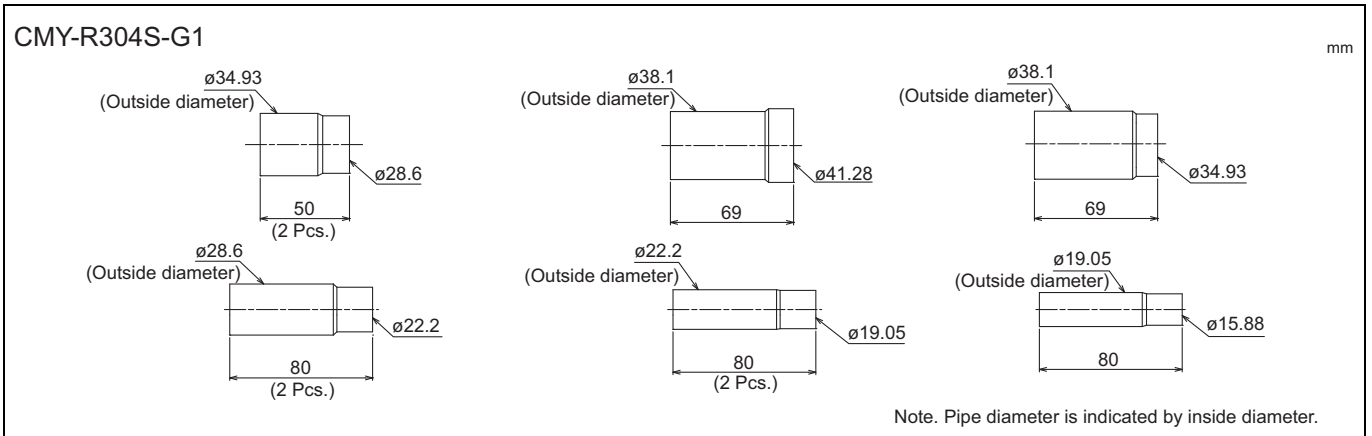
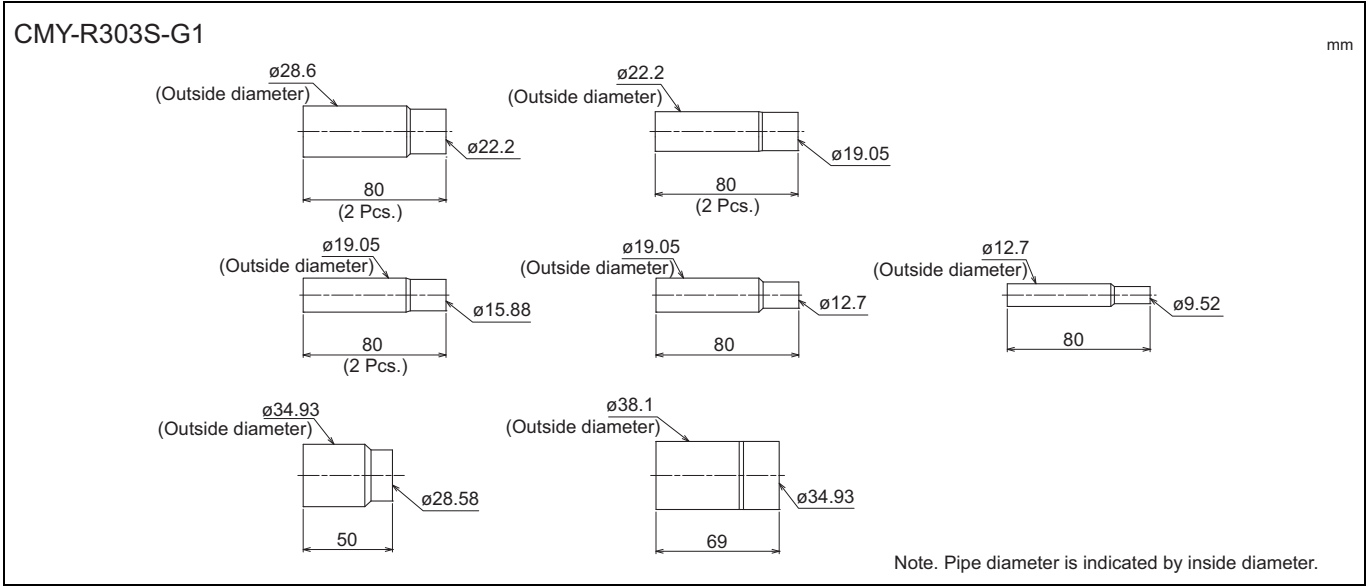

PURV-M-Y(S)XM-A

9-2. OUTDOOR TWINNING KIT

The following optional Outdoor Twinning Kit is needed to use to combine multiple refrigerant pipes. Refer to section "Piping Design" for the details of selecting a proper twinning kit.

CMY-R100VBK4

Low-pressure twinning pipe

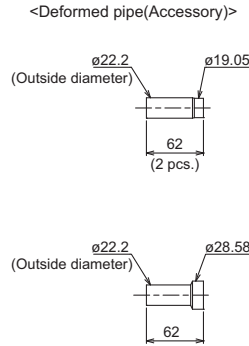
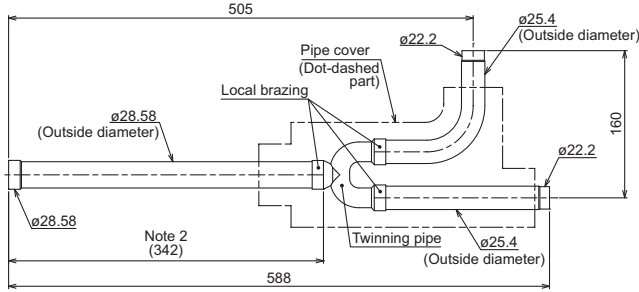

Note 1. Refer to the figure below for the installation position of the twinning pipe.
The Twinning pipe must be installed horizontally using a level vessel to avoid unit damage.

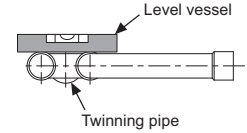

2. Use the attached pipe to braze the port-opening of the twinning pipe.
3. Pipe diameter is indicated by inside diameter.

High-pressure twinning pipe

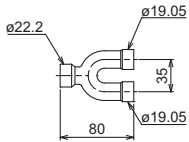

<Deformed pipe(Accessory)>

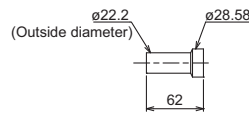
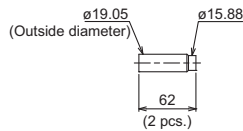

CMY-R200VBK4

Low-pressure twinning pipe

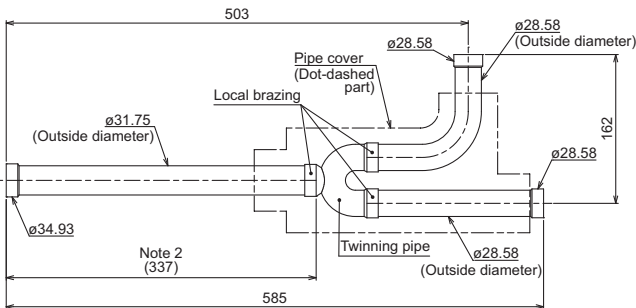

<Deformed pipe(Accessory)>

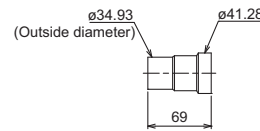

Note 1. Refer to the figure below for the installation position of the twinning pipe.
The Twinning pipe must be installed horizontally using a level vessel to avoid unit damage.

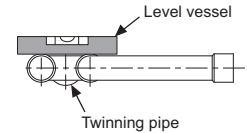

2. Use the attached pipe to braze the port-opening of the twinning pipe.
3. Pipe diameter is indicated by inside diameter.

High-pressure twinning pipe

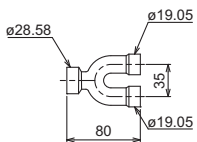

<Deformed pipe(Accessory)>

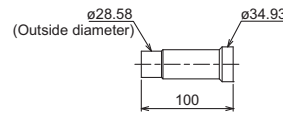
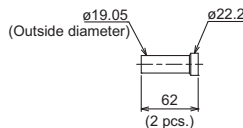

Note 1. Refer to the figure below for the installation position of the twinning pipe.
The Twinning pipe must be installed horizontally using a level vessel to avoid unit damage.

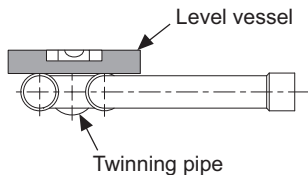

2. Use the attached pipe to braze the port-opening of the twinning pipe.
3. Pipe diameter is indicated by inside diameter.
4. Only use the twinning pipe by Mitsubishi (optional parts).

9-3. JOINT KIT "CMY-R170M-E" FOR BC CONTROLLER

Joint kit "CMY-R170M-E" for BC controller is used to combine 2 ports of the BC controller at a PURY/PQRY system so as to enable down-stream Indoor capacity above 54 (80)* as shown in Fig. 1.

The Joint kit include following items:

① Instruction	② Joint pipe(Small)	③ Joint pipe(Large)	④ Cover 1	⑤ Cover 2	⑥ Cover 3	⑦ Band	⑧ Reducer 1	⑨ Reducer 2
This sheet 1pc	1pc	1pc	2pcs	1pc for gas side	1pc for liquid side	8pcs	OD19.05-ID22.2 1pc	OD19.05-ID15.88 1pc

Please prepare the following items in the field. ①Tape for insulation material sealing ②Extension pipe for refrigerant circuit

② Joint pipe (for liquid side)

③ Joint pipe (for gas side)

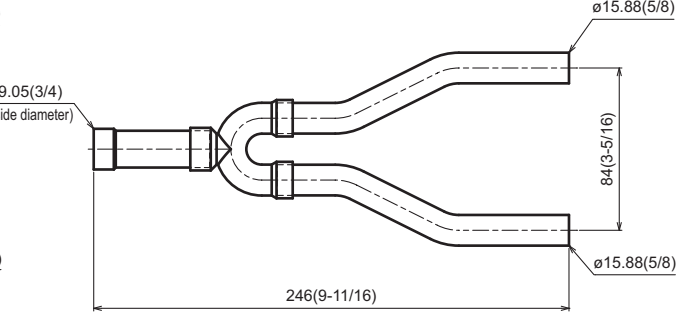
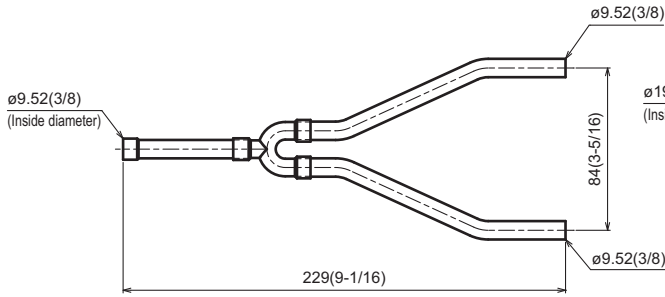

1. Designing CMY-R170M-E to a PURY/PQRY system

1-1. When connecting one indoor unit to the BC controller port

- The maximum capacity index of an indoor unit that can be connected to one port is 54 (80)*.
- When connecting an indoor unit having the capacity index larger than 54 (80)*, use the joint pipe kit to merge two ports.

1-2. When connecting multiple indoor units to the BC controller port

- Up to three indoor units can be connected to one port. Use the branch pipes (CMY-Y102SS-G2 or CMY-Y102LS-G2) to connect the indoor units to the BC controller.
 - If the total downstream capacity index is 54 (80)* or less, all the units can be connected to one port.
 - If the total downstream capacity index is between 55 (81)* and 96 (250)*, use the joint pipe kit to merge two ports. However, the maximum capacity index per unit is 54 (80)*.
- *All the indoor units connected to the same port must be operated in the same mode.

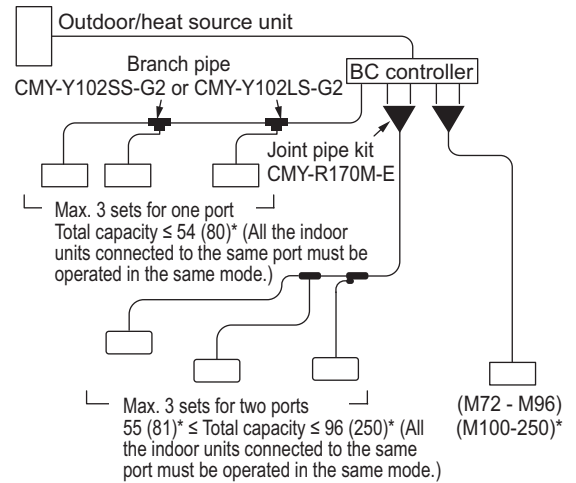

* The capacity indices in parentheses apply to non-US models.

Fig.1. CMY-R170M-E applying scheme

2. Piping at the installation site

The connection of CMY-R170M-E to BC controller and pipe leading to Indoor units is referable to Fig. 2. Non-oxidized brazing is necessary. All piping must be careful to avoid foreign material getting inside.

After piping and air-tight testing, insulation work to the Joint and pipe should be done. Details is available at the Installation Manual.

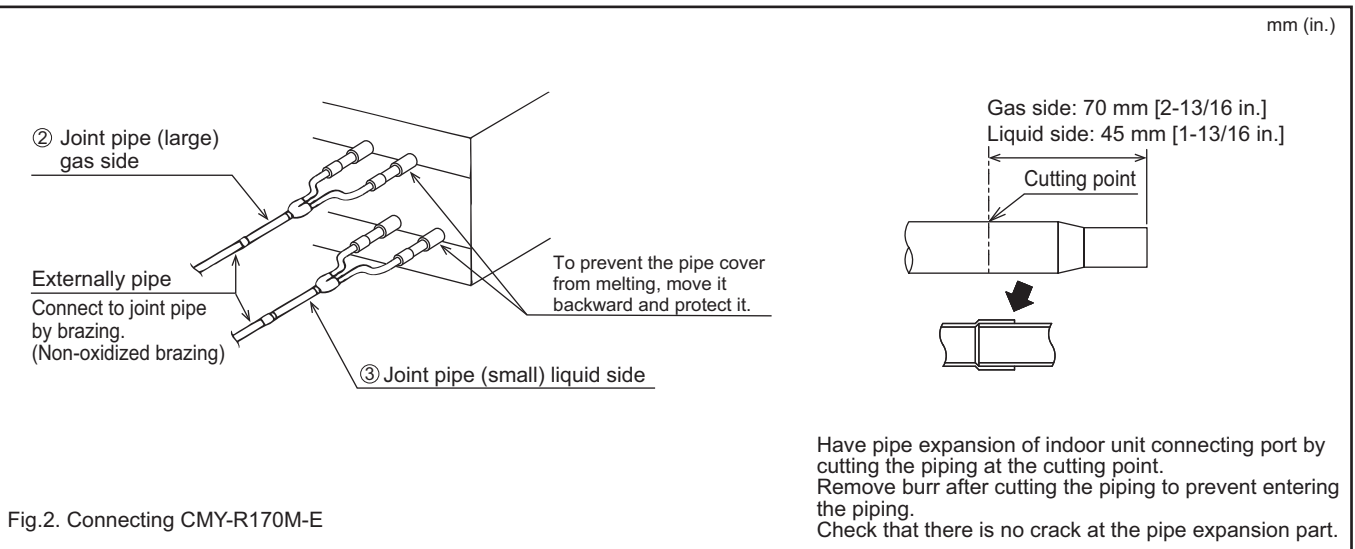

Fig.2. Connecting CMY-R170M-E

9-4. FIN GUARD

PURY-M-Y(S)XM-A

PAC-FG04S-E

For side surfaces (a set of two pieces)

■ Left side of the unit

■ Right side of the unit

mm

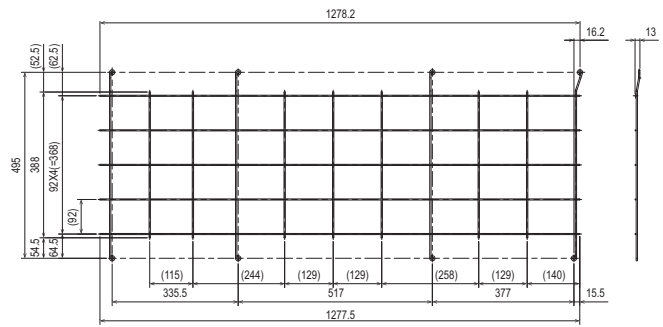
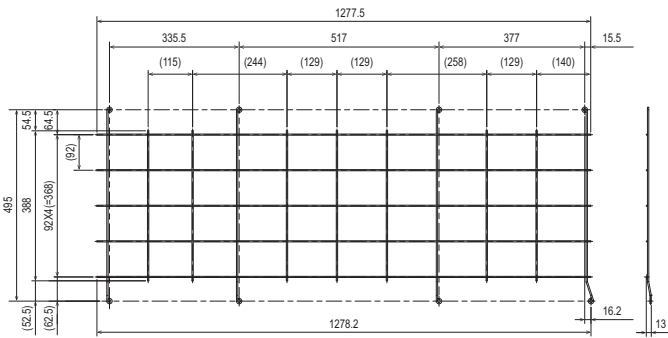

PAC-FG06B-E

For rear surface of S module

mm

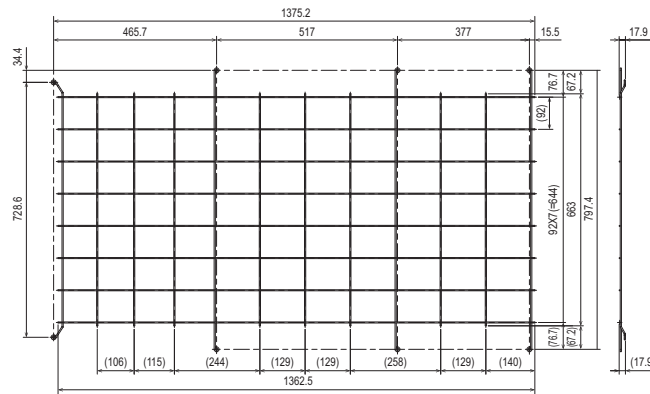

PAC-FG07B-E

For rear surface of L module (a set of two pieces)

■ Behind the unit (left)

■ Behind the unit (right)

mm

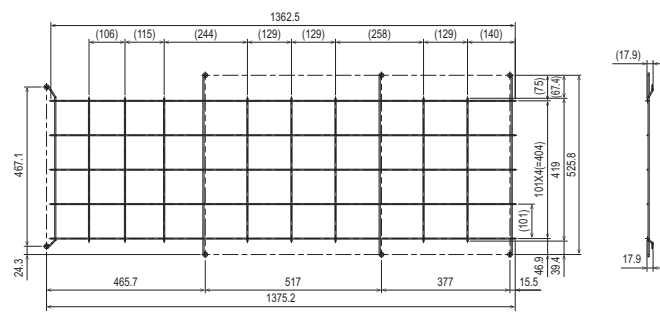
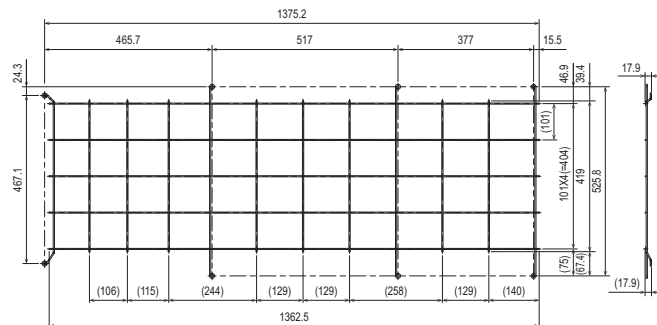

10-1. General cautions

- ① Follow ordinance of your governmental organization for technical standard related to electrical equipment, wiring regulations, and guidance of each electric power company.
- ② Wiring for control (hereinafter referred to as transmission cable) shall be (50mm[1-5/8in] or more) apart from power source wiring so that it is not influenced by electric noise from power source wiring. (Do not insert transmission cable and power source wire in the same conduit.)
- ③ Be sure to provide designated grounding work to outdoor unit.
- ④ Give some allowance to wiring for electrical part box of indoor and outdoor units, because the box is sometimes removed at the time of service work.
- ⑤ Never connect 380~415V(220~240V) power source to terminal block of transmission cable. If connected, electrical parts will be damaged.
- ⑥ Use 2-core shield cable for transmission cable. If transmission cables of different systems are wired with the same multiple-core cable, the resultant poor transmitting and receiving will cause erroneous operations.
- ⑦ When extending the transmission line, make sure to extend the shield cable as well.

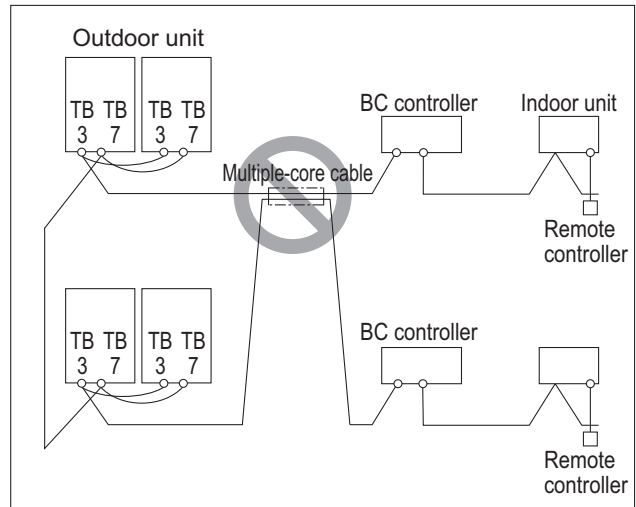
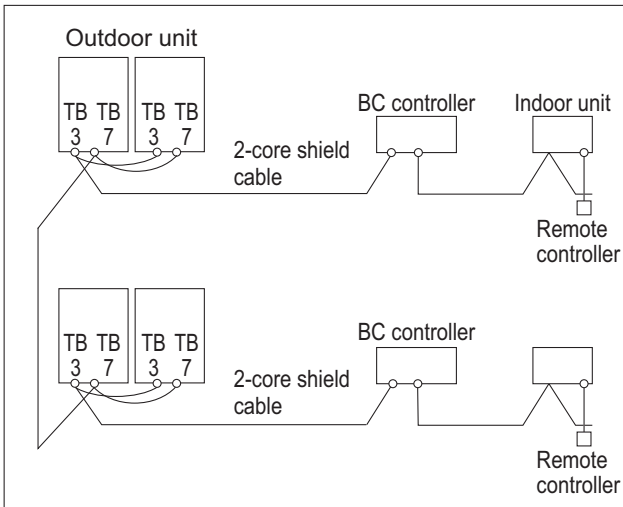

TB3:Terminal block for Indoor/Outdoor transmission cable
 TB7:Terminal block for central control transmission cable

10-2. Power supply for Outdoor unit

10-2-1. Electrical characteristics of Outdoor unit

Symbols: MCA (Max Circuit Amps)

RLA (Rated Load Amps)

SC (Starting Current)

PURY-M-Y(S)XM-A

PURY-M-YXM-A	Unit Combination	Units			Power supply	Compressor		FAN	RLA(A)(50Hz)	
		Hz	Volts	Voltage range	MCA (A)	Output (kW)	SC (A)	Output (kW)	Cooling	Heating
PURY-M200YXM-A(-BS)	-	50	380 400 415	Max:456V Min:342V	21.4	4.0	8	0.92	9.3/8.8/8.5	9.5/9.0/8.7
PURY-M250YXM-A(-BS)	-				21.4	5.8	8	0.92	13.1/12.4/12.0	13.1/12.4/12.0
PURY-M300YXM-A(-BS)	-				26.5	7.4	8	0.92	15.9/15.1/14.5	16.2/15.4/14.8
PURY-M350YXM-A(-BS)	-				27.3	10.0	8	0.46+0.46	19.6/18.6/17.9	21.3/20.2/19.5
PURY-M400YXM-A(-BS)	-				30.4	11.2	8	0.46+0.46	22.6/21.4/20.6	23.7/22.5/21.7
PURY-M450YXM-A(-BS)	-				30.4	13.5	8	0.46+0.46	26.1/24.8/23.9	28.1/26.7/25.7
PURY-M500YXM-A(-BS)	-				33.4	16.1	8	0.46+0.46	33.2/31.6/30.4	29.3/27.9/26.9
PURY-M400YSXM-A(-BS)	PURY-M200YXM-A(-BS)				21.4	4.0	8	0.92	18.8/17.9/17.2	19.7/18.7/18.0
	PURY-M200YXM-A(-BS)				21.4	4.0	8	0.92		
PURY-M450YSXM-A(-BS)	PURY-M250YXM-A(-BS)				21.4	5.8	8	0.92	22.6/21.5/20.7	23.2/22.0/21.3
	PURY-M200YXM-A(-BS)				21.4	4.0	8	0.92		
PURY-M500YSXM-A(-BS)	PURY-M250YXM-A(-BS)				21.4	5.8	8	0.92	27.0/25.6/24.7	27.1/25.8/24.9
	PURY-M250YXM-A(-BS)				21.4	5.8	8	0.92		
PURY-M550YSXM-A(-BS)	PURY-M300YXM-A(-BS)				26.5	7.4	8	0.92	29.8/28.3/27.3	30.2/28.7/27.7
	PURY-M250YXM-A(-BS)				21.4	5.8	8	0.92		
PURY-M600YSXM-A(-BS)	PURY-M300YXM-A(-BS)				26.5	7.4	8	0.92	32.6/31.0/29.9	33.4/31.8/30.6
	PURY-M300YXM-A(-BS)				26.5	7.4	8	0.92		
PURY-M650YSXM-A(-BS)	PURY-M350YXM-A(-BS)				27.3	10.0	8	0.46+0.46	36.9/35.0/33.8	38.5/36.6/35.3
	PURY-M300YXM-A(-BS)				26.5	7.4	8	0.92		
PURY-M700YSXM-A(-BS)	PURY-M350YXM-A(-BS)				27.3	10.0	8	0.46+0.46	40.1/38.1/36.7	44.0/41.8/40.3
	PURY-M350YXM-A(-BS)				27.3	10.0	8	0.46+0.46		
PURY-M750YSXM-A(-BS)	PURY-M400YXM-A(-BS)				30.4	11.2	8	0.46+0.46	43.3/41.1/39.6	46.4/44.1/42.5
	PURY-M350YXM-A(-BS)				27.3	10.0	8	0.46+0.46		
PURY-M800YSXM-A(-BS)	PURY-M400YXM-A(-BS)				30.4	11.2	8	0.46+0.46	46.5/44.2/42.6	48.9/46.4/44.7
	PURY-M400YXM-A(-BS)				30.4	11.2	8	0.46+0.46		
PURY-M850YSXM-A(-BS)	PURY-M450YXM-A(-BS)				30.4	13.5	8	0.46+0.46	49.9/47.4/45.7	53.4/50.7/48.9
	PURY-M400YXM-A(-BS)	30.4	11.2	8	0.46+0.46					
PURY-M900YSXM-A(-BS)	PURY-M450YXM-A(-BS)	30.4	13.5	8	0.46+0.46	53.9/51.2/49.3	58.1/55.2/53.2			
	PURY-M450YXM-A(-BS)	30.4	13.5	8	0.46+0.46					
PURY-M950YSXM-A(-BS)	PURY-M500YXM-A(-BS)	33.4	16.1	8	0.46+0.46	60.8/57.8/55.7	59.3/56.4/54.3			
	PURY-M450YXM-A(-BS)	30.4	13.5	8	0.46+0.46					
PURY-M1000YSXM-A(-BS)	PURY-M500YXM-A(-BS)	33.4	16.1	8	0.46+0.46	68.9/65.5/63.1	60.6/57.5/55.5			
	PURY-M500YXM-A(-BS)	33.4	16.1	8	0.46+0.46					

10-3. Power cable specifications

Thickness of wire for main power supply, capacities of the switch and system impedance

	Model	Minimum wire thickness (mm ²)			Ground-fault interrupter *1	Local switch (A)		Breaker for wiring (A) (Non-fuse breaker)	Max. Permissible System Impedance
		Main cable	Branch	Ground		Capacity	Fuse		
Outdoor unit	PURY-M200YXM-A(-BS)	4.0	-	4.0	30A 100mA 0.1sec. or less	25	25	30	*2
	PURY-M250YXM-A(-BS)	4.0	-	4.0	30A 100mA 0.1sec. or less	32	32	30	*2
	PURY-M300YXM-A(-BS)	4.0	-	4.0	30A 100mA 0.1sec. or less	32	32	30	0.273Ω
	PURY-M350YXM-A(-BS)	6.0	-	6.0	40A 100mA 0.1sec. or less	40	40	40	0.265Ω
	PURY-M400YXM-A(-BS)	10.0	-	10.0	60A 100mA 0.1sec. or less	63	63	60	0.238Ω
	PURY-M450YXM-A(-BS)	10.0	-	10.0	60A 100mA 0.1sec. or less	63	63	60	0.238Ω
	PURY-M500YXM-A(-BS)	10.0	-	10.0	60A 100mA 0.1sec. or less	63	63	60	0.217Ω

*1 The Ground-fault interrupter should support Inverter circuit. The Ground-fault interrupter should combine using of local switch or wiring breaker.

*2 Meet technical requirements of IEC61000-3-3

1. Use dedicated power supplies for the outdoor unit and indoor unit. Ensure OC and OS are wired individually.
2. Bear in mind ambient conditions (ambient temperature, direct sunlight, rain water, etc.) when proceeding with the wiring and connections.
3. The wire size is the minimum value for metal conduit wiring. If the voltage drops, use a wire that is one rank thicker in diameter. Make sure the power-supply voltage does not drop more than 10%. Make sure that the voltage imbalance between the phases is 2% or less.
4. Specific wiring requirements should adhere to the wiring regulations of the region.
5. Power supply cords of parts of appliances for outdoor use shall not be lighter than polychloroprene sheathed flexible cord (design 60245 IEC57). For example, use wiring such as YZW.
6. A switch with at least 3 mm contact separation in each pole shall be provided when the Air Conditioner is installed.
7. For details on indoor unit wiring and breaker for current leakage, refer to the indoor unit Instruction Book and Installation Manual.

⚠ WARNING

- ◆ Be sure to use specified wires for connections and ensure no external force is imparted to terminal connections. If connections are not fixed firmly, heating or fire may result.
- ◆ Be sure to use the appropriate type of overcurrent protection switch. Note that generated overcurrent may include some amount of direct current.

⚠ CAUTION

- ◆ The breakers for current leakage should support Inverter circuit. (e.g. Mitsubishi Electric's NV-S-Series or equivalent). If no earth leakage breaker is installed, it may cause an electric shock.
- ◆ Breakers for current leakage should combine using of switch.
- ◆ Do not use anything other than a breaker with the correct capacity. Using a breaker of too large capacity may cause malfunction or fire.
- ◆ If a large electric current flows due to malfunction or faulty wiring, earth-leakage breakers on the unit side and on the upstream side of the power supply system may both operate.
Depending on the importance of the system, separate the power supply system or take protective coordination of breakers.

Note

- ◆ This device is intended for the connection to a power supply system with a maximum permissible system impedance shown in the above table at the interface point (power service box) of the user's supply.
- ◆ The user must ensure that this device is connected only to a power supply system which fulfils the requirement above.
If necessary, the user can ask the public power supply company for the system impedance at the interface point.
- ◆ This equipment complies with IEC 61000-3-12 provided that the short-circuit power Ssc is greater than or equal to Ssc (*2) at the interface point between the user's supply and the public system. It is the responsibility of the installer or user of the equipment to ensure, by consultation with the distribution network operator if necessary, that the equipment is connected only to a supply with a short-circuit power Ssc greater than or equal to Ssc (*2).

Ssc(*2)

Model	PURY-M200YXM-A	PURY-M250YXM-A	PURY-M300YXM-A	PURY-M350YXM-A	PURY-M400YXM-A	PURY-M450YXM-A	PURY-M500YXM-A
Ssc (MVA)	1.85	1.85	2.29	2.35	2.62	2.62	2.88

10-4-2. PURY-M400, 450, 500, 550, 600, 650, 700, 750, 800, 850, 900, 950, 1000YSXM

The local standards and/or regulations is applicable at a higher priority.

- Note:
- 1 The transmission cable is not-polarity double-wire.
 - 2 Symbol ⊙ means a screw terminal for wiring.
 - 3 The shield wire of transmission cable should be connected to the grounding terminal at Outdoor unit. All shield wire of M-Net transmission cable among Indoor units should be connected to the S terminal at Indoor unit or all shield wire should be connected together.
The broken line at the scheme means shield wire.
 - 4 When connecting a system controller to a central control transmission cable, connect a power supply unit or supply power from a system controller with a power supply function.
 - 5 MA remote controller transmission cable must be less than 200 m in length (100 m when connecting two MA remote controllers in a group).
 - 6 If using 1 or 2 (main/sub) MA remote controller to control more than 1 Indoor unit, use MA transmission cable to connect all the TB 15 terminals of the Indoor units. It is called "Grouping".
 - 7 Indoor board consumes power from TB3. The power balance should be considered according to "System configuration restrictions" section.
 - 8 If a transmission booster is needed, be sure to connect it to the location specified in this diagram.
Also, when connecting, be sure to connect the shielded transmission cable to the S terminals (shield) of the booster.
 - 9 The critical current for choosing power source equipment is approximate 1.4 times of total rated current of the Outdoor unit(s) or Indoor unit(s).
 - 10 When System controller (SC) is connected to the system, turn the SW5-1 on.

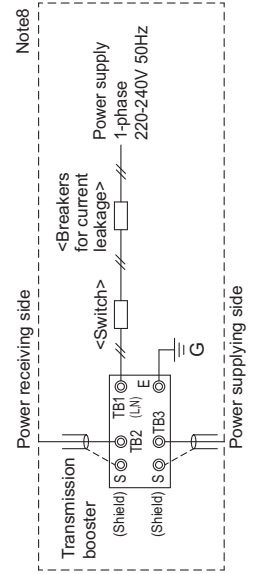
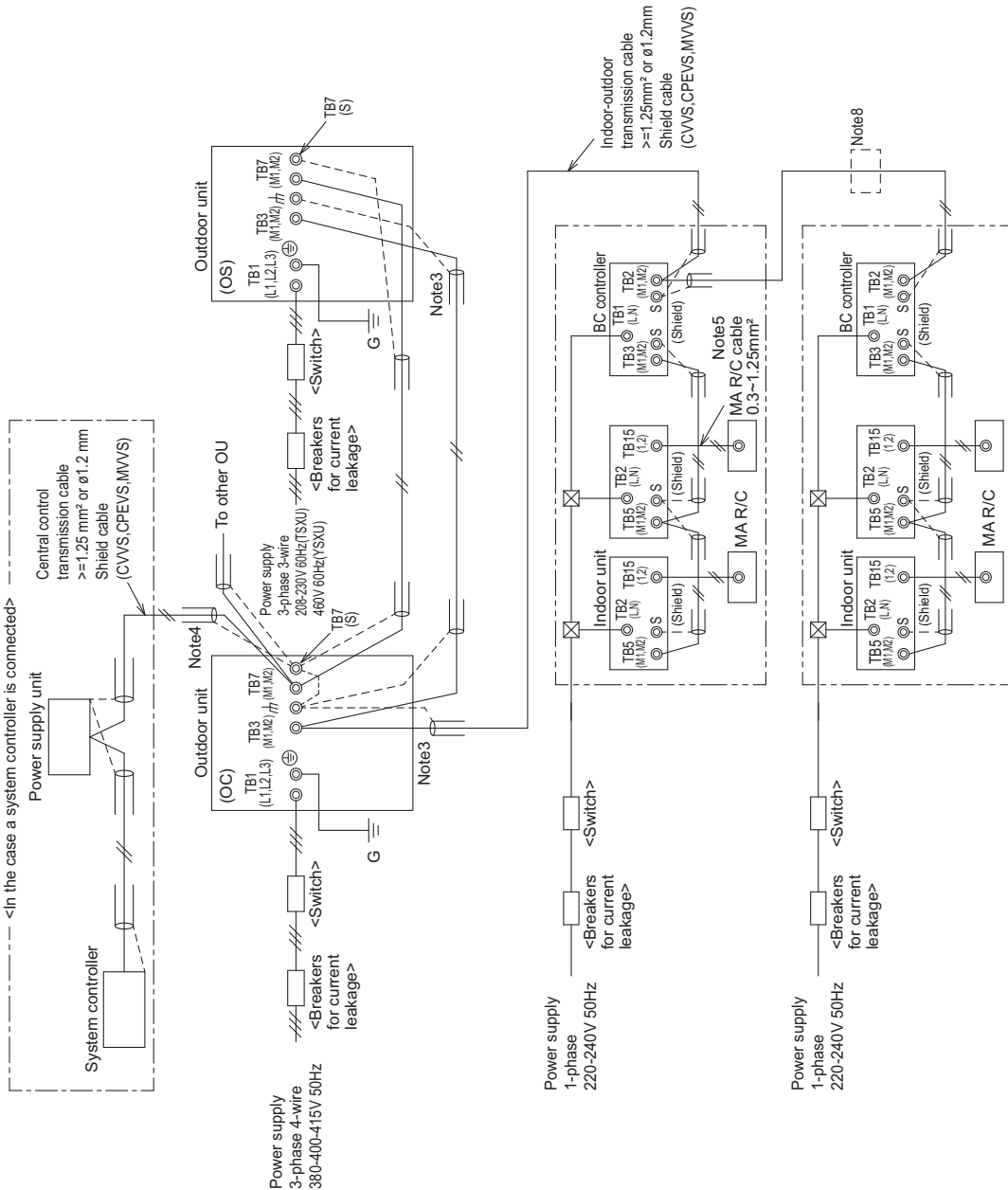

11-1. Transmission cable specifications

	Transmission cables (Li)	MA Remote controller cables
Type of cable	Shielded cables (2-core) CVVS, CPEVS, and MVVS	VCTF, VCTFK, CVV, VVR, VVF, VCT
Cable size	Larger than 1.25 mm ² [AWG16], or ø1.2 mm or above	0.3 to 1.25 mm ² [AWG22 to 16] *1
Maximum overall line length	Refer to 11-3-3.	200 m [656 ft]

*1 The use of cables that are smaller than 0.75 mm² (AWG18) is recommended for easy handling.

CVVS, MVVS: PVC insulated PVC sheathed shielded control cable

CPEVS: PE insulated PVC sheathed shielded communication cable

CVV: PVC insulated PVC sheathed control cable

11-2. System configuration restrictions

11-2-1. Common restrictions for the CITY MULTI system

For each Outdoor/Heat source unit, the maximum connectable quantity of Indoor unit is specified at its Specifications table.

- A) 1 Group of Indoor units can have 1-16 Indoor units;
- B) Maximum 2 remote controllers for 1 group;
- C) 1 LOSSNAY unit can interlock maximum 16 Indoor units; 1 Indoor unit can interlock only 1 LOSSNAY unit.
- D) Maximum 3 System controllers are connectable when connecting to TB3 of the Outdoor/Heat source unit.
- E) A maximum of 6 system controller are connectable to TB3 and TB7 of Outdoor/Heat source unit.
- F) 4 System controllers or more are connectable when connecting to TB7 of the Outdoor/Heat source unit, if the transmission power is supplied by the power supply unit PAC-SC51KUA.

*System controller connected as described in D) would have a risk that the failure of connected Outdoor/Heat source unit would stop power supply to the System controller.

11-2-2. Ensuring proper communication power and the number of connected units for M-NET

In order to ensure proper communication among Outdoor/Heat source unit, Indoor unit, LOSSNAY, and Controllers, the transmission power situation for the M-NET should be observed. In some cases, Transmission booster should be used. Taking the power consumption of Indoor unit as 1, the equivalent power consumption or supply of others are listed at Table 1 and Table 2.

Both the transmission line for centralized controller and indoor-outdoor transmission line must meet the conditions listed below. (Both conditions a) and b) must be met.)

a) [Total equivalent power consumption] ≤ [The equivalent power supply]

b) [Total equivalent number of units (Table1)] ≤ [40] *1*2

*1 [40-2] when one or more BC controllers are connected.

*2 [40-1] when one or more shut off valve kits are connected.

Table 1 The equivalent power consumption and the equivalent number of units

Category	Model	The equivalent power consumption	The equivalent number of units
Indoor unit	M or MS models	1	1
BC controller	CMB-M104, 106, 108, 1012V-MA-SV(-TR) CMB-M104, 108V-MB-SV(-TR)	0.75	1
Shut off valve kit	CMR-M100KT-E	0.75	1
Power Supply Interface for Alarm Kit	PAC-SL73IF-E PAC-SL73IFL-E	0.75	1
MA remote controller/LOSSNAY	PAR-CT01MAU PAR-42MAAB LGH PZ-60, 61, 62DR PZ-43SMF-E	0	0
System controller	AE-C400E/EW-C50E	0	0
	PAC-YG60MCA PAC-YG66DCA PAC-YG63MCA	0.25	1
ON/OFF controller	PAC-YT40ANRA	1	1
MN converter	CMS-MNG-E	2	1
Outdoor/Heat source unit	TB7 power consumption	0	0
A-M converter	PAC-SF83MA-E	1	2

Table 2 The equivalent power supply

Category	Model	The equivalent power supply		
Transmission Booster	PAC-SF46EPA-G	25		
Power supply unit	PAC-SC51KUA	5		
BM ADAPTER	BACS-AP50E	0.75		
System controller	AE-C400E/EW-C50E	0.75		
Outdoor/Heat source unit	Outdoor unit other than the following units *1	TB3 and TB7 total	TB7 only	TB3 only
	S-Series outdoor unit	32	6	32 - equivalent power supplied to TB7
		12	0	12

*1 If PAC-SC51KUA is used to supply power at TB7 side, no power supply need from Outdoor/Heat source unit at TB7, Connector TB3 itself will therefore have 32.

With the equivalent power consumption values and the equivalent number of units in Table 1 and Table 2, PAC-SF46EPA-G can be designed into the air-conditioner system to ensure proper system communication according to (A), (B), (C).

- (A) Firstly, count from TB3 at TB3 side the total equivalent number of units of Indoor units and System controllers. If the total equivalent number of units reaches 40, a PAC-SF46EPA-G should be set.
- (B) Secondly, count from TB7 side to TB3 side the total transmission power consumption. If the total equivalent power supply reaches 32, a PAC-SF46EPA-G should be set. Yet, if a PAC-SC51KUA or another controller with a built-in power supply, such as AE-C400E/EW-C50E, is used to supply power at TB7 side, count from TB3 side only.
- (C) Thirdly, count from TB7 at TB7 side the total transmission power consumption. If the total equivalent power supply for only TB7 reaches 6, a PAC-SF46EPA-G should be set. Also, count from TB7 at TB7 side the total equivalent number of units of System controllers, and so on. If the total equivalent number of units reaches 40, a PAC-SF46EPA-G should be set.

■ System example

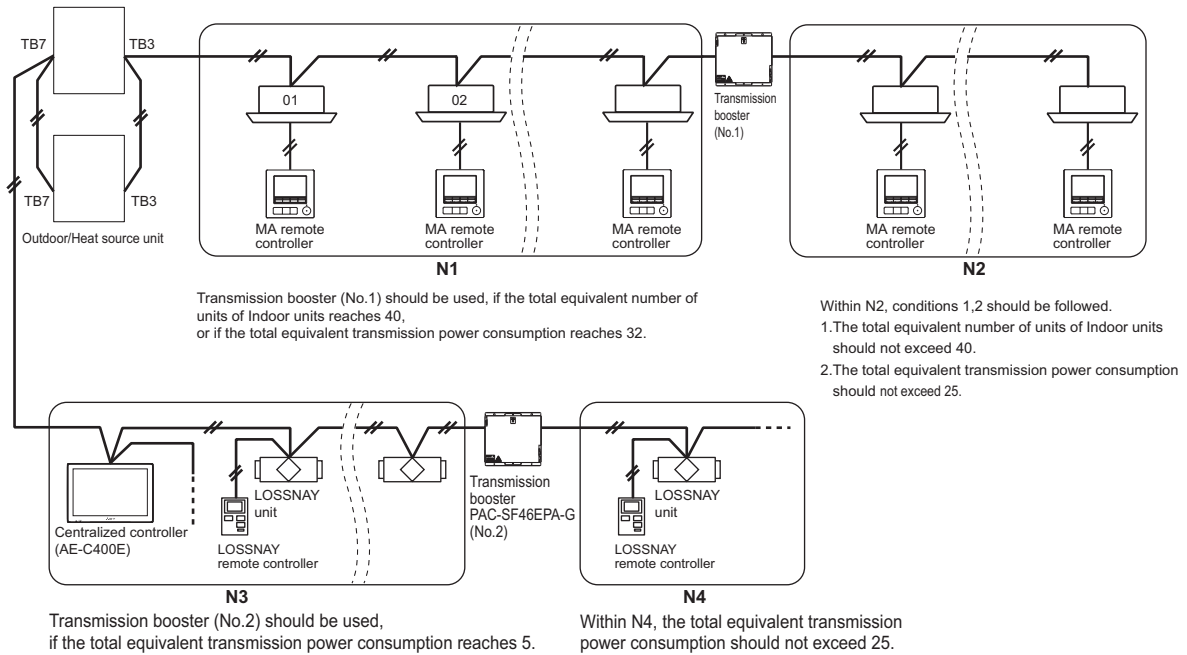

11-2-3. Power supply to BM ADAPTER

1-phase 100-240VAC power supply is needed.

The power supply unit PAC-SC51KUA is not necessary when only BM ADAPTER is connected.

Ensure that connector CN21 remains attached to the BM ADAPTER. (The BM ADAPTER is supplied with CN21 pre-installed and must not be removed.)

11-2-4. Power supply to AE-C400E/EW-C50E

1-phase 100-240VAC power supply is needed.

The power supply unit PAC-SC51KUA is not necessary when connecting only the AE-C400E/EW-C50E.

11-3. Address setting

11-3-1. Switch operation

In order to constitute CITY MULTI in a complete system, switch operation for setting the unit address No. and connection No. is required.

- ① Address No. of outdoor/heat source unit and indoor unit.
The address No. is set at the address setting board.
In the case of R2 system, it is necessary to set the same No. at the branch No. switch of indoor unit as that of the BC controller connected. (When connecting two or more branches, use the lowest branch No.)

② Caution for switch operations

- Be sure to shut off power source before switch setting. If operated with power source on, switch can not operate properly.
- No units with identical unit address shall exist in one whole air conditioner system. If set erroneously, the system can not operate.

③ MA remote controller

- When connecting only one remote controller to one group, it is always the main remote controller.
When connecting two remote controllers to one group, set one remote controller as the main remote controller and the other as the sub remote controller.
- The factory setting is "Main".

PAR-42MAAB or later

The MA remote controller does not have the switches shown above.
Refer to the installation manual for the function setting.

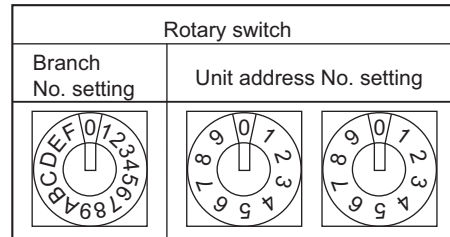

11-3-2. Rule of setting address

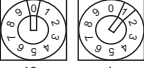
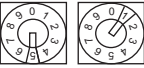
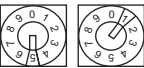
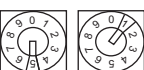
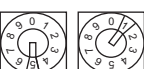
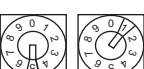
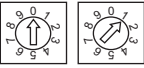
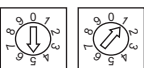
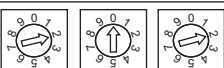
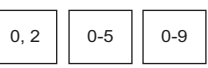
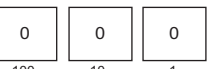
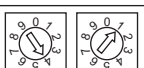
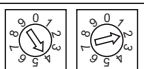
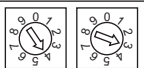
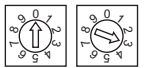
Unit	Address setting	Example	Note	
Indoor unit	00, 01 ~ 50		Use the most recent address within the same group of indoor units. Assign the smallest address in the group to the main unit. If indoor units with different functions operate in the same group, set the unit with the most functions as the main unit.	
Outdoor/Heat source unit	51 ~ 99, 100 (Note1)		The smallest address of indoor unit in same refrigerant system + 50 Assign sequential address numbers to the outdoor/heat source units in one refrigerant circuit system. OC and OS are automatically detected. (Note 2) *Please reset one of them to an address between 51 and 99 when two addresses overlap. *The address automatically becomes "100" if it is set as "01~ 50"	
BC controller (Main)	00, 51 ~ 99, 100		Address is set to "00" by factory setting. No change is required unless manual configuration is necessary. If configuring manually, observe the following conditions.	
BC controller (Sub)	00, 51 ~ 99, 100		The BC controller address should generally be set to 1 + the address of the outdoor unit and Heat source unit. However, if this would result in it having the same address as another outdoor unit and Heat source unit, set the address between 51 and 100, making sure that it is different from the address of other controllers. *The address automatically becomes "100" if it is set as "01~ 50".	
Shut off valve kit	00, 151 ~ 200		Address is set to "00" by factory setting. No change is required unless manual configuration is necessary. If configuring manually, observe the following conditions. The smallest address of outdoor/heat source unit in same refrigerant system + 100 *The address automatically becomes "200" if it is set as "01~ 50"	
Power Supply Interface for Alarm Kit	00, 151 ~ 200		Address is set to "00" by factory setting. No change is required unless manual configuration is necessary. If configuring manually, observe the following conditions. The smallest address of outdoor unit in same refrigerant system + 100 *The address automatically becomes "200" if it is set as "01~ 50"	
Local remote controller	LOSSNAY Remote controller (Main)	101 ~ 150	1 Fixed 	The smallest address of indoor unit in the group + 100 *The place of "100" is fixed to "1"
	LOSSNAY Remote controller (Sub)	151 ~ 199, 200	1 Fixed 	The address of main remote controller + 50 *The address automatically becomes "200" if it is set as "00"
System controller	ON/OFF remote controller	201 ~ 250		The smallest group No. to be managed + 200 *The smallest group No. to be managed is changeable.
	AE-C400E/EW-C50E	000, 201 ~ 250		
	BACS-AP50E	000, 201 ~ 250		* Settings are made with setting tool of BM ADAPTER.
PI, AI, DIDO	PAC-YG60MCA	01 ~ 50		
	PAC-YG63MCA	01 ~ 50		
	PAC-YG66DCA	01 ~ 50		
LOSSNAY	01 ~ 50		After setting the addresses of all the indoor units, assign an arbitrary address.	

Note1: To set the address to "100", set it to "50"

Note2: Outdoor/Heat source units OC and OS in one refrigerant circuit system are automatically detected.

OC and OS are ranked in descending order of capacity. If units are the same capacity, they are ranked in ascending order of their address.

11-3-3. System examples

Example of control wiring

— Interlocking with ventilation system
 SA: Sensor and alarm kit
 FGAIIF: Power supply interface for alarm kit

PURY-M-Y(S)XM-A

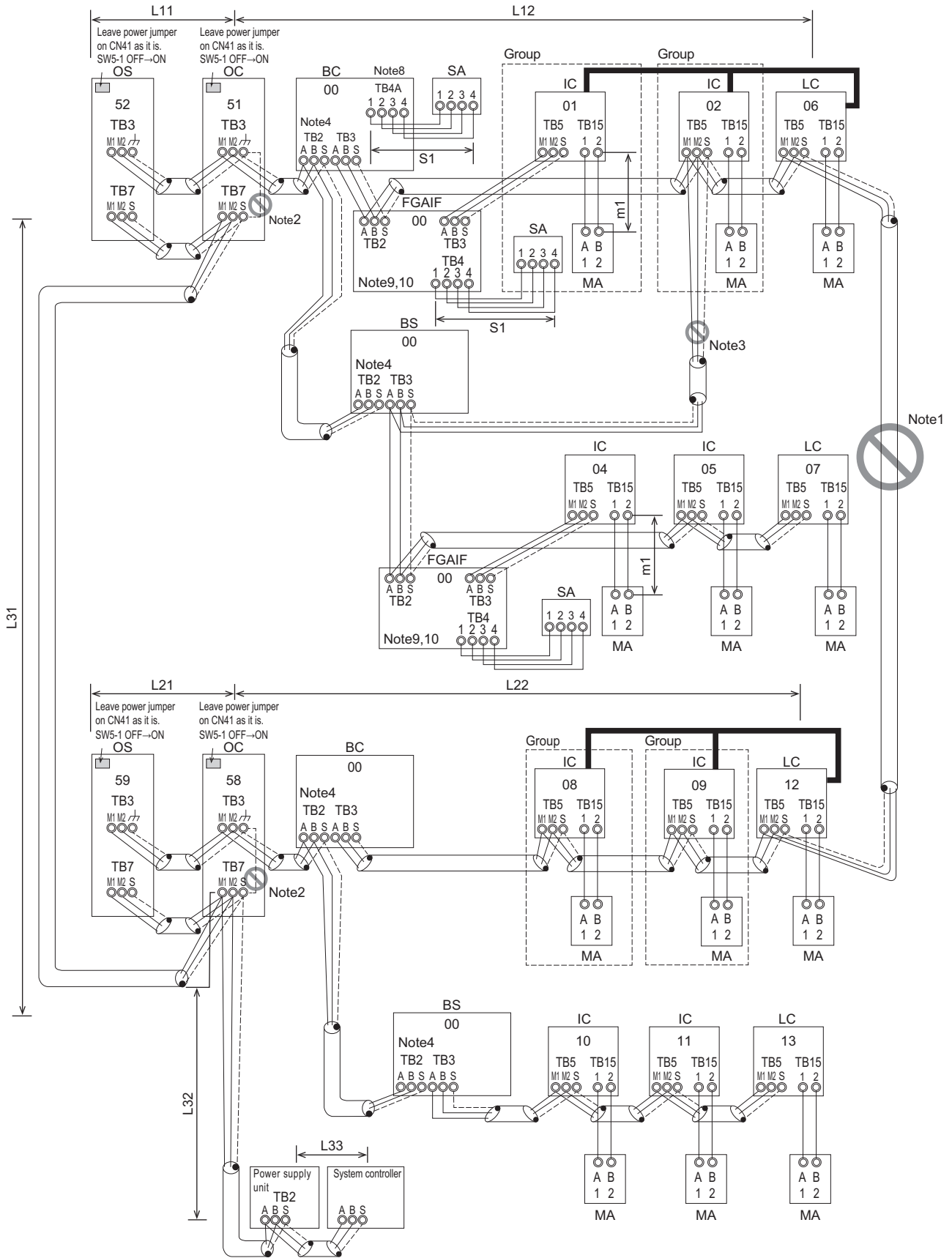

Cautions

- Note1. Do not connect the terminal blocks TB5 on the indoor units that are connected to different outdoor units with each other.
- Note2. If a power supply unit is connected, do not connect the ground terminal (接地) to the shield terminal S on the TB7 terminal block for the centralized control transmission cable.
- Note3. Do not connect the transmission cable terminal block TB3 (indoor unit) of the BC controller to any indoor unit other than the unit connected to the BC controller.
- Note4. Up to two cables can be connected to the transmission cable terminal block TB2 (outdoor unit/indoor unit/BC controller) of the BC controller, and one cable can be connected to the transmission cable terminal block TB3 (indoor unit).
- Note5. When a power supply unit is connected to the centralized control transmission cable, leave the power jumper connector on CN41 as it is (factory setting).
- Note6. For information on the maximum number of indoor units or other devices that can be connected, connection requirements, or the need for a transmission booster, refer to the MELANS Centralized Controller Technical Manual.
- Note7. Grouping is not possible between different refrigerant systems or between main BC controller and sub BC controller.
- Note8. One sensor and alarm kit can be connected to terminal block TB4A on the BC controller.
- Note9. The power supply interface for alarm kit has eight terminals TB4A to TB4H on its terminal block TB4.
- Note10. When detecting refrigerant leaks from the indoor unit using the sensor and alarm kit, connect the indoor unit to terminal block TB3 on the power supply interface for alarm kit.

Wiring and address setting

<a. Indoor-outdoor transmission cable>

Use shielded cables.

Daisy-chain the following terminals: the M1 and M2 terminals of the indoor-outdoor transmission cable terminal block TB3 on the outdoor units (OC and OS), the M1 and M2 terminals of the indoor-outdoor transmission cable terminal block TB5 on each indoor unit IC that does not require safety measures, and the A and B terminals of the transmission cable terminal block TB2 (outdoor unit/indoor unit/BC controller) on each BC controller. (Non-polarized double-wire)

*1 The outdoor units (OC and OS) in the same refrigerant circuit system are automatically designated in the order of capacity from large to small. If the OC and OS have the same capacity, the one with the smaller address number is designated as OC, while the one with the larger address number is designated as OS.

[Shielded cable connection]

To ground the shielded cable, daisy-chain the following terminals: the ground terminals of OC and OS, the S terminal of the terminal block on each indoor unit (IC), and the S terminal of the transmission cable terminal block TB2 (outdoor unit/indoor unit/BC controller) on each BC controller.

<b. Indoor unit transmission cable>

Use shielded cables.

Daisy-chain the following terminals: the M1 and M2 terminals of the indoor-outdoor transmission cable terminal block TB5 on each indoor unit (IC), and the A and B terminals of the transmission cable terminal block TB3 (indoor unit) on the BC controller. (Non-polarized double-wire)

[Shielded cable connection]

To ground the shielded cable, daisy-chain the following terminals: the S terminal of the indoor-outdoor transmission cable terminal block TB5 on each indoor unit (IC), and the S terminal of the transmission cable terminal block TB3 (indoor unit) on the BC controller.

Allowable cable length

<a. Indoor-outdoor transmission cable>

Farthest length (1.25 mm² or more)
 $L11+L12 \leq 200$ m
 $L21+L22 \leq 200$ m

<b. Centralized control transmission cable>

$L31 + L32$ (L21) ≤ 200 m
 $L33 \leq 200$ m

<c. MA remote controller wiring>

Total length (0.3 to 1.25 mm²)
 $m1 \leq 200$ m

If the MA remote controller PAR-42MAAB is connected, use a sheathed cable with a cross-sectional area of 0.3 mm².

<d. Farthest length via outdoor unit (1.25 mm² or more)>

$L33 + L32 + L31 + L12$ (L11) ≤ 1000 m
 $L33 + L32 + L22$ (L21) ≤ 1000 m
 $L12$ (L11) + $L31 + L22$ (L21) ≤ 1000 m

<e. Sensor and alarm kit>

$S1 \leq 40$ m

<c. Centralized control transmission cable> * Ensure shielded cables are used.

Daisy-chain the following terminals: the A and B terminals of the system controller, the A and B terminals of the terminal block TB2 on the power supply unit, the M1 and M2 terminals of the centralized control transmission cable terminal block TB7 on the outdoor unit OC in a different refrigerant circuit system, the M1 and M2 terminals of the centralized control transmission cable terminal block TB7 on the outdoor units (OC and OS) *1 in the same refrigerant circuit system.

If a power supply unit is not connected to the centralized control transmission cable, replace the power jumper connector from CN41 to CN40 on the control board of only one of the outdoor units.

To connect the system controller, set the central control switch SW5-1 on the control board of all outdoor units to "ON".

*1 The outdoor units OC and OS in the same refrigerant circuit system are automatically designated in the order of capacity from large to small. If the OC and OS have the same capacity, the one with the smaller address number is designated as OC, while the one with the larger address number is designated as OS.

*2 If TB7 of the outdoor units in the same refrigerant circuit system is not daisy-chained, connect the centralized control transmission cable to TB7 of the OC *1.

To maintain centralized control even during an OC failure or a power failure, daisy-chain terminal blocks TB7 of the OC and OS.

*3 When connecting TB7, only commence after checking that the voltage is below 20 VDC.

[Shielded cable connection]

To ground the shielded cable, daisy-chain the following: the system controller, the terminal block TB2 of the power supply unit, and the S terminals of the terminal blocks TB7 on the OC and OS.

Connect the ground terminal (⌋) to the S terminal of terminal block TB7 on the outdoor unit whose power jumper connector has been replaced to CN40.

<d. MA remote controller wiring>

Connect the terminals 1 and 2 of the MA remote controller cable terminal block TB15 on the IC to the MA remote controller terminal box (MA). (Non-polarized double-wire)

[When pairing the remote controllers]

When pairing the remote controllers, connect the terminals 1 and 2 of terminal block TB15 on the IC to the terminal blocks of two MA remote controllers.

For requirements for pairing the remote controllers, refer to "Precautions for installing alarm device (MA remote controller, model name: PAR-42MAAB or later)" section in the R32 City Multi Technical Manual.

<e. LOSSNAY connection>

Daisy-chain the M1 and M2 terminals of terminal block TB5 on the IC to the indoor-outdoor transmission cable terminal block TB5 on the LOSSNAY unit (LC). (Non-polarized double-wire)

*Indoor units must be interlocked with the LOSSNAY unit using the system controller. (Refer to the operation manual for the system controller for the setting method.)

Interlock setting from the remote controller is required if the ON/OFF remote controller alone is connected.

<f. Switch setting>

For address setting, refer to the "Rule of setting address" section.

12-1. R32 Piping material

Refrigerant pipe for CITY MULTI shall be made of phosphorus deoxidized copper, and has two types.

A. Type-O: Soft copper pipe (annealed copper pipe), can be easily bent with human's hand.

B. Type-1/2H pipe: Hard copper pipe (Straight pipe), being stronger than Type-O pipe of the same radical thickness.

The maximum operation pressure of R32 air conditioner is 4.30 MPa [623psi]. The refrigerant piping should ensure the safety under the maximum operation pressure. MITSUBISHI ELECTRIC recommends the pipe size in Table1, however, please follow the local industrial standard. Pipes with a radical thickness of 0.7mm or less shall not be used.

Table 1. Copper pipe size and radial thickness for R32 CITY MULTI.

Size [mm (in)]	Radial thickness [mm (mil)]	Type
ø6.35 (ø1/4)	0.8 (32)	Type-O
ø9.52 (ø3/8)	0.8 (32)	Type-O
ø12.7 (ø1/2)	0.8 (32)	Type-O
ø15.88 (ø5/8)	1.0 (40)	Type-O
ø19.05 (ø3/4)	1.2 (48)	Type-O
	1.0 (40)	Type-1/2H or H
ø22.2 (ø7/8)	1.0 (40)	Type-1/2H or H
ø25.4 (ø1)	1.0 (40)	Type-1/2H or H
ø28.58 (ø1-1/8)	1.0 (40)	Type-1/2H or H
ø31.75 (ø1-1/4)	1.1 (44)	Type-1/2H or H
ø34.93 (ø1-3/8)	1.2 (48)	Type-1/2H or H
ø41.28 (ø1-5/8)	1.4 (56)	Type-1/2H or H

* For pipe sized ø19.05 (3/4") for R32 air conditioner, choice of pipe type is up to you.

* The figures in the radial thickness column are based on the Japanese standards and provided only as a reference. Use pipes that meet the local standards.

Procedures for installing the branched pipes

Refer to the instructions that came with the branched pipe kit (separately sold) for details.

[1] Branches on the outdoor/heat source-unit side

Note. Refer to the figure below for the installation position of the twinning kit.

The Twinning kit must be installed horizontally using a level vessel to avoid unit damage.

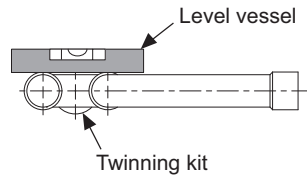

- Minimum length of the straight section of the pipe before the branched pipes
Always use the pipes supplied in the branched kit, and make sure the straight section of the pipe immediately before it connects to the branched pipe is at least 500 mm (19-11/16 in.). Failure to do so may damage the unit.

[2] Branches on the indoor-unit side

■ Joint (CMY-R201/202/203/204/205S-G)

- Restriction on installing the 2-Branch Joint Pipe between main BC and sub BC on the high-pressure piping, low-pressure piping, and liquid piping.

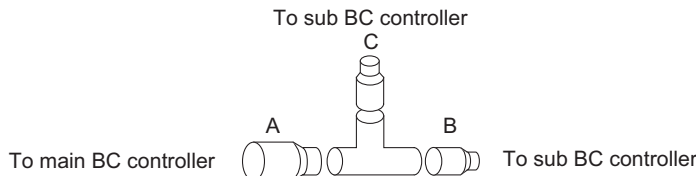

- Regarding the 2-Branch Joint Pipe between main BC and sub BC on the high-pressure/low-pressure/liquid piping, A and B must be installed horizontally, and C must be installed upward higher than the horizontal plane of A and B.

■ Joint (CMY-Y102SS-G2/CMY-Y102LS-G2)

When installing the branch joint on the gas piping, it must be installed horizontally or with the branched pipes facing up (as shown in the figure below).

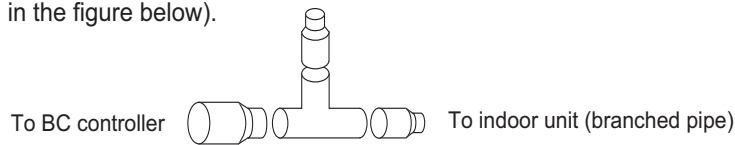

Horizontal installation

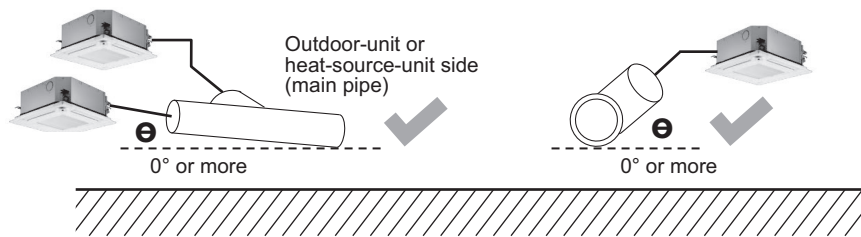

Be careful on return oil.

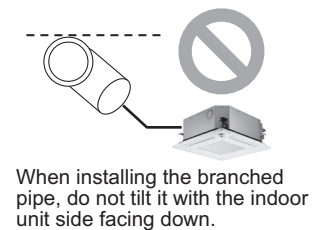

Vertical installation

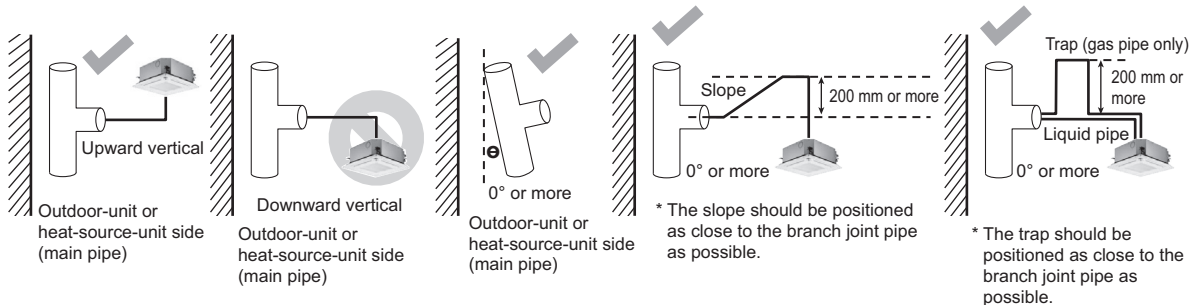

- Restrictions described here apply to the joint in the gas line. Refer to the installation manual of the joint for details.
- If the size of the refrigerant pipe that is selected by following the instructions under "Piping Design" section does not match the size of the joint, use a reducer to connect them. A reducer is included in the kit.
- When installing outdoor units above indoor units, provide a trap to keep the oil from stagnating in the stopped indoor units. The trap should be positioned as close to the branch joint pipe as possible.

PURY-M-Y(S)XM-A

12-2. Piping Design

"BC controller," "BC controller (Main)," and "BC controller (Sub)" that appear in this section refer to the MA type and MB type.

12-2-1. If 12 ports or less are in use, i.e., if only one BC controller is in use with no sub BC controller

- Note1. No Header usable on PURY system.
- Note2. Indoor unit sized M100-M250 should be connected to BC controller via Y shape joint CMY-R170M-E.
- Note3. Indoor unit sized M100-M250 does NOT share BC controller ports with other Indoor units;
- Note4. As bents cause pressure loss on transportation of refrigerant, fewer bents design is better; Piping length needs to consider the actual length and equivalent length which bents are counted. Equivalent piping length (m) = Actual piping length + "M" × Number of bent.
- Note5. Set DIP-SW 1-1 on the BC controller to ON when connecting Indoor unit(s) with a total capacity of 81-250 to 2 ports.
- Note6. It is also possible to connect Indoor unit(s) with a total capacity of 81-140 to 1 port (set DIP-SW 1-1 to OFF). However, the cooling capacity should be multiplied by a correction factor 0.98.
- Note7. Do not connect multiple indoor units to the same port when operating each of them in different mode (cooling, heating, stop, and thermo-off). In case of connecting multiple indoor units to the same port, connecting all indoor units to one remote controller and switching SW1-1 ON in the all connected indoor units (switch to thermostat built in the remote controller) are recommended.
- Note8. Indoor capacity is described as its model size. For example, PEFY-MS63VMA-A1, its capacity is 63.
- Note9. Total down-stream Indoor capacity is the summary of the model size of Indoors down-stream. For example, PEFY-MS63VMA-A1 + PEFY-MS32VMA-A1: Total Indoor capacity = 63 + 32 = 95.
- Note10. To connect the BC controller to the main pipe, use the reducer (CMY-R304S-G1).
- Note11. Install the pipes correctly referring to the section titled "Procedures for installing the branched pipes."

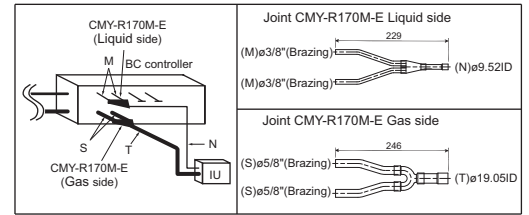

Fig. A

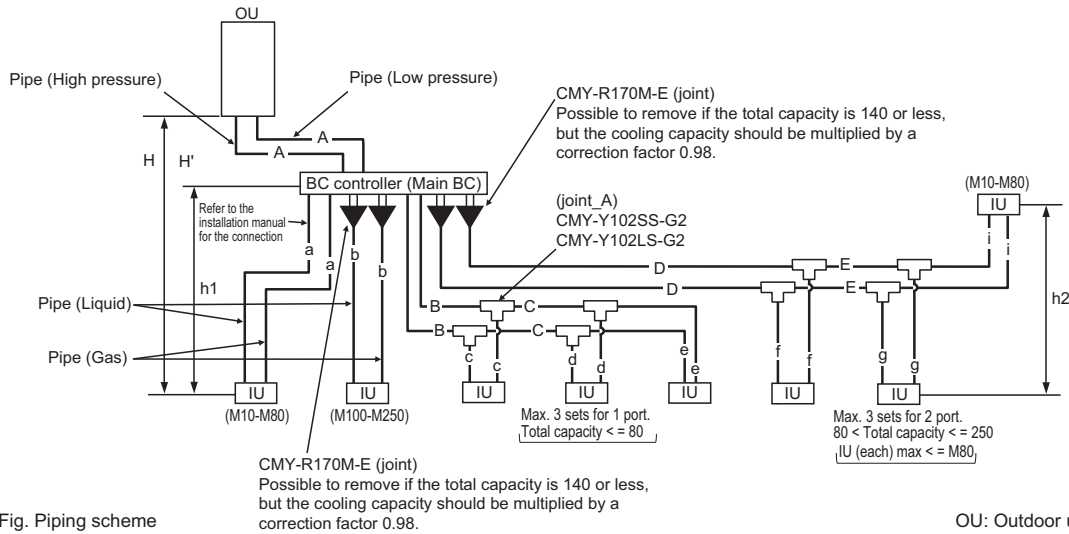

Fig. Piping scheme

OU: Outdoor unit, IU: Indoor unit

Piping length limitation *8

Item	Piping in the figure	Max. length	Max. equivalent length
Total piping length (Total length of high pressure and liquid pipes)	A+B+C+D+E+a+b+c+d+e+f+g+i	*1	-
Farthest IU from OU	A+D+E+i	165 [541]	190 [623]
Distance between OU and BC	A	110 [360] *1	110 [360] *1
Farthest IU from BC controller	D+E+i	60 [197] *2*3	60 [197] *2*3
Height between OU and IU (OU above IU)	H	50 [164] *6	-
Height between OU and IU (OU under IU)	H'	40 [131] *7	-
Height between IU and BC	h1	15 [49] (10 [32]) *4	-
Height between IU and IU	h2	30 [98] (20 [65]) *5	-

OU: Outdoor Unit; IU: Indoor Unit; BC: BC controller

*1. Refer to "Total piping length restrictions" section.

*2. Details refer to Fig. 1.

*3. When the M200 or M250 model of indoor units are connected to the system, the maximum distance from the BC controller to the farthest indoor unit (indicated as "D + E + i" in the figure) is 40 m [131 ft].

*4. Distance of Indoor sized M200, M250 from BC must be less than 10 m [32 ft], if any.

*5. Distance of Indoor sized M200, M250 from IU must be less than 20 m [65 ft], if any.

*6. 113 m [370 ft] is available depending on the model and installation conditions. For more detailed information, contact your local distributor.

*7. 60 m [197 ft] is available depending on the model and installation conditions. For more detailed information, contact your local distributor.

*8. Total length of high-pressure pipes and liquid pipes

*9. The piping length between the BC controller and the indoor unit is subject to restrictions depending on the installation location and the capacity of the indoor unit. For details, refer to the New Design Tool software of Mitsubishi Electric Corporation.

Bent equivalent length

Outdoor Model	M (m/bent [ft./bent])
M200YXM-A	0.35 [1.15']
M250YXM-A	0.42 [1.38']
M300YXM-A	0.42 [1.38']
M350YXM-A	0.47 [1.54']
M400YXM-A	0.50 [1.65']
M450YXM-A	0.50 [1.65']
M500YXM-A	0.50 [1.65']

Fig. 1 Piping length and height between IU and BC controller

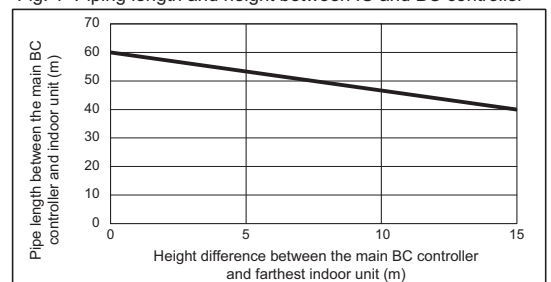

Piping "A" size selection rule (mm [in.])

Outdoor Model	Pipe(High pressure)	Pipe(Low pressure)
M200YXM-A	ø15.88 [5/8"]	ø19.05 [3/4"]
M250YXM-A	ø19.05 [3/4"]	ø22.20 [7/8"]
M300YXM-A	ø19.05 [3/4"]	ø22.20 [7/8"]
M350YXM-A	ø19.05 [3/4"]	ø28.58 [1-1/8"]
M400YXM-A	ø22.20 [7/8"]	ø28.58 [1-1/8"]
M450YXM-A	ø22.20 [7/8"]	ø28.58 [1-1/8"]
M500YXM-A	ø22.20 [7/8"]	ø28.58 [1-1/8"]

Piping "B", "C", "D", "E" size selection rule (mm [in.])

Total down-stream Indoor capacity	Pipe(Liquid)	Pipe(Gas)
140 or less	ø9.52 [3/8"]	ø15.88 [5/8"]
141 ~ 200	ø9.52 [3/8"]	ø19.05 [3/4"]
201 ~ 250	ø9.52 [3/8"]	ø22.20 [7/8"]

Table3. Piping "a", "b", "c", "d", "e", "f", "g" size selection rule (mm [in.])

Indoor Unit size	Pipe(Liquid)	Pipe(Gas)
M10 ~ M50	ø6.35 [1/4]	ø12.70 [1/2]
M63 ~ M80	ø6.35 [1/4] *10	ø15.88 [5/8]
M100 ~ M140	ø9.52 [3/8]	ø15.88 [5/8]
M200	ø9.52 [3/8]	ø19.05 [3/4]
M250	ø9.52 [3/8]	ø22.20 [7/8]

*10. If the length of the liquid pipe exceeds the following restriction, use the one size larger pipe.

M63	40 m
M71	40 m
M80	35 m

Selection criteria for joints_A

Total down-stream Indoor capacity	Joint
~ 200	CMY-Y102SS-G2
201 ~ 250	CMY-Y102LS-G2

12-2-2. If more than 12 ports are in use, or if there is more than one BC controller in use for one outdoor unit

- Note1. No Header usable on PURY system.
- Note2. Indoor unit sized M100-M250 should be connected to BC controller via Y shape joint CMY-R170M-E.
- Note3. Indoor unit sized M100-M250 does NOT share BC controller ports with other Indoor units;
- Note4. As bents cause pressure loss on transportation of refrigerant, fewer bents design is better; Piping length needs to consider the actual length and equivalent length which bents are counted. Equivalent piping length (m) = Actual piping length + "M" x Number of bent.
- Note5. Set DIP-SW 1-1 on the BC controller to ON when connecting Indoor unit(s) with a total capacity of 81-250 to 2 ports.
- Note6. It is also possible to connect Indoor unit(s) with a total capacity of 81-140 to 1 port (set DIP-SW 1-1 to OFF). However, the cooling capacity should be multiplied by a correction factor 0.98.
- Note7. Do not connect multiple indoor units to the same port when operating each of them in different mode (cooling, heating, stop, and thermo-off). In case of connecting multiple indoor units to the same port, connecting all indoor units to one remote controller and switching SW1-1 ON in the all connected indoor units (switch to thermostat built in the remote controller) are recommended.
- Note8. The maximum total capacity of indoor units that can be connected to each sub BC controller CMB-M-V-MB-SV is 350.
- Note9. Indoor capacity is described as its model size. For example, PEFY-MS63VMA-A1, its capacity is 63.
- Note10. Total down-stream Indoor capacity is the summary of the model size of Indoors down-stream. For example, PEFY-MS63VMA-A1 + PEFY-MS32VMA-A1: Total Indoor capacity =63 + 32 = 95.
- Note11. To connect the BC controller to the main pipe, use the reducer (CMY-R304S-G1).
- Note12. To connect the sub BC controller to the main BC controller, use the reducer (CMY-R303S-G1 or CMY-R306S-G).
- Note13. Install the pipes correctly referring to the section titled "Procedures for installing the branched pipes."
- Note14. Up to 11 sub BC controllers can be connected.

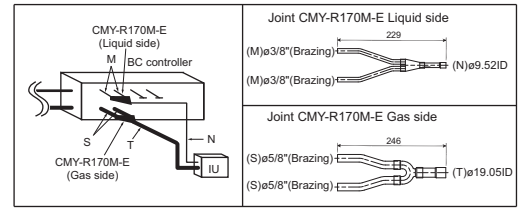

Fig. A

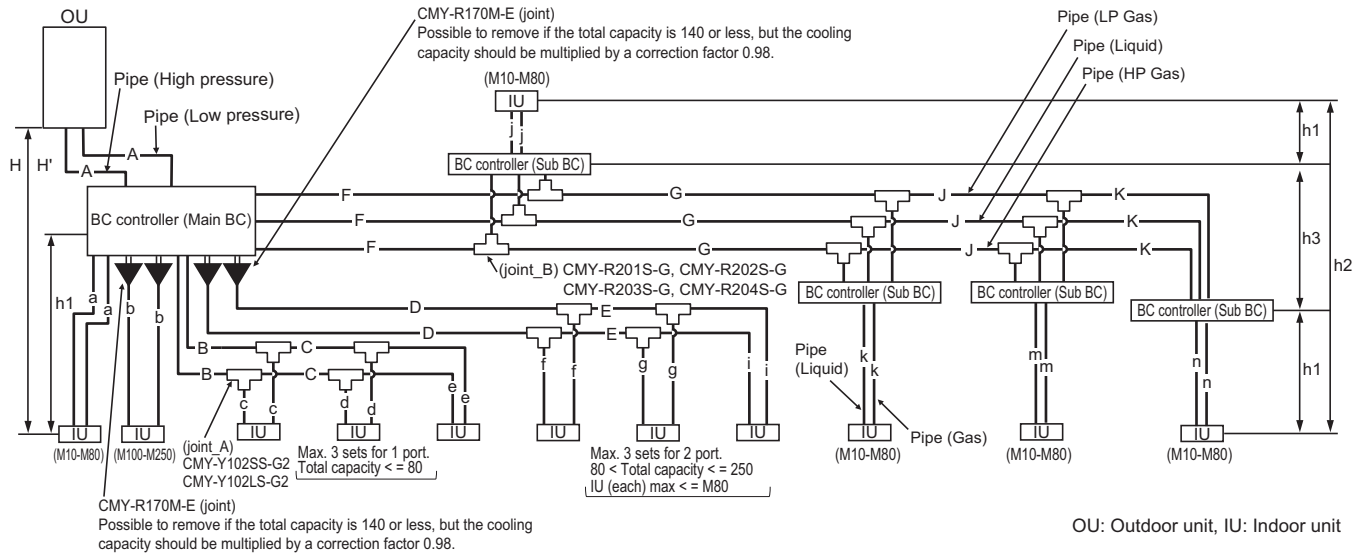

Fig. Piping scheme

Piping length limitation *11

Item	Piping in the figure	Max. length	Max. equivalent length
Total piping length (Total length of high pressure and liquid pipes)	A+B+C+D+E+F+G+J+K+a+b+c+d+e+f+g+i+j+k+m+n	*1	-
Farthest IU from OU	A+F+G+J+K+n	165 [541]	190 [623]
Distance between OU and BC	A	110 [360] *1	110 [360] *1
Farthest IU from BC controller	D+E+i	60 [197] *2*3	60 [197] *2*3
Farthest IU from BC controller via Sub BC controller	F+G+J+K+n	90 [295] *9	90 [295] *9
Height between OU and IU (OU above IU)	H	50 [164] *7	-
Height between OU and IU (OU under IU)	H'	40 [131] *8	-
Height between IU and BC	h1	15 [49] (10 [32]) *4	-
Height between IU and IU	h2	30 [98] (20 [65]) *5	-
Height between BC(Main or Sub) and BC(Sub)	h3	15 [49] (10 [32]) *6	-

OU: Outdoor Unit; IU: Indoor Unit; BC: BC controller

- *1. Refer to "Total piping length restrictions" section.
- *2. Details refer to Fig. 2.
- *3. When the M200 or M250 model of indoor units are connected to the system, the maximum distance from the BC controller to the farthest indoor unit (indicated as "D + E + i" in the figure) is 40 m [131 ft].
- *4. Distance of Indoor sized M200, M250 from BC must be less than 10 m [32 ft], if any.
- *5. Distance of Indoor sized M200, M250 from IU must be less than 20 m [65 ft], if any.
- *6. When using 2 or more Sub BC controllers, max. height "h3" should be considered.
- *7. 113 m [370 ft] is available depending on the model and installation conditions. For more detailed information, contact your local distributor.
- *8. 60 m [197 ft] is available depending on the model and installation conditions. For more detailed information, contact your local distributor.
- *9. When the piping length or the vertical separation exceeds the limit specified in Fig. 2, connect a sub BC to the system. The restriction for a system with a sub BC connection is shown in Fig. 3. When a given system configuration falls within the shaded area in Fig. 3, increase the size of the high-pressure pipe and the liquid pipe between the main BC and sub BC by one size. The maximum liquid branch pipe diameter is ø19.05. If a given system already has a ø19.05-pipe between the main BC and sub BC, there is no need to increase the pipe size. When using M32, M40, M50, M100, or M125 model of indoor units, increase the size of the liquid branch pipe between the sub BC and indoor unit by one size. When using indoor models M140 or larger, the restrictions shown in Fig. 2 cannot be exceeded.
- *10. Total length of high-pressure pipes and liquid pipes
- *11. The piping length between the BC controller and the indoor unit is subject to restrictions depending on the installation location and the capacity of the indoor unit. For details, refer to the New Design Tool software of Mitsubishi Electric Corporation.

Bent equivalent length

Outdoor Model	M (m/bent [ft./bent])
M200YXM-A	0.35 [1.15']
M250YXM-A	0.42 [1.38']
M300YXM-A	0.42 [1.38']
M350YXM-A	0.47 [1.54']
M400YXM-A	0.50 [1.65']
M450YXM-A	0.50 [1.65']
M500YXM-A	0.50 [1.65']

Piping length and height between IU and BC controller

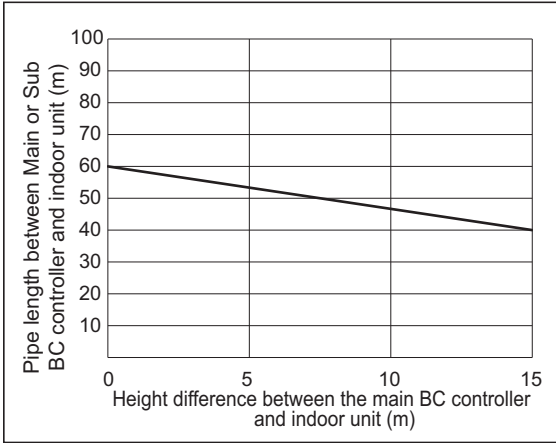

Fig. 2

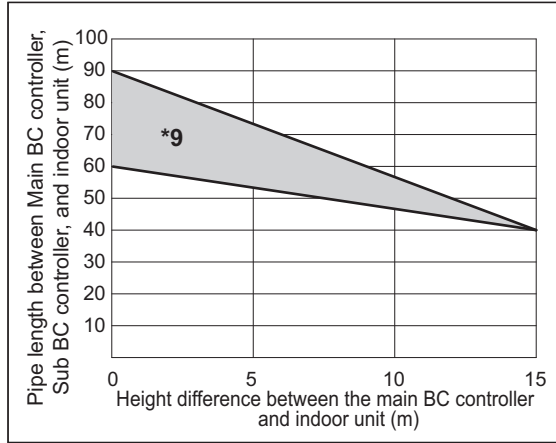
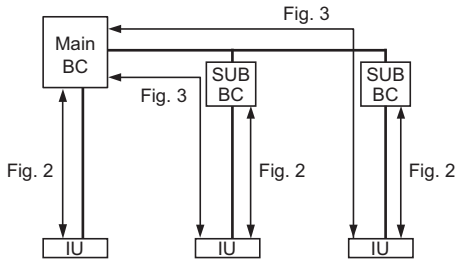

Fig. 3



*9. When the piping length or the vertical separation exceeds the limit specified in Fig. 2, connect a sub BC to the system.
 The restriction for a system with a sub BC connection is shown in Fig. 3.
 When a given system configuration falls within the shaded area in Fig. 3, increase the size of the high-pressure pipe and the liquid pipe between the main BC and sub BC by one size.
 The maximum liquid branch pipe diameter is $\phi 19.05$. If a given system already has a $\phi 19.05$ -pipe between the main BC and sub BC, there is no need to increase the pipe size.
 When using M32, M40, M50, M100, or M125 model of indoor units, increase the size of the liquid branch pipe between the sub BC and indoor unit by one size.
 When using indoor models M140 or larger, the restrictions shown in Fig. 2 cannot be exceeded.

Piping "A" size selection rule

	(mm [in.])	
Outdoor Model	Pipe(High pressure)	Pipe(Low pressure)
M200YXM-A	$\phi 15.88$ [5/8"]	$\phi 19.05$ [3/4"]
M250YXM-A	$\phi 19.05$ [3/4"]	$\phi 22.20$ [7/8"]
M300YXM-A	$\phi 19.05$ [3/4"]	$\phi 22.20$ [7/8"]
M350YXM-A	$\phi 19.05$ [3/4"]	$\phi 28.58$ [1-1/8"]
M400YXM-A	$\phi 22.20$ [7/8"]	$\phi 28.58$ [1-1/8"]
M450YXM-A	$\phi 22.20$ [7/8"]	$\phi 28.58$ [1-1/8"]
M500YXM-A	$\phi 22.20$ [7/8"]	$\phi 28.58$ [1-1/8"]

Selection criteria for joints_A

Total down-stream Indoor capacity	Joint
~ 200	CMY-Y102SS-G2
201 ~ 250	CMY-Y102LS-G2

Piping "B", "C", "D", "E" size selection rule

Total down-stream Indoor capacity	(mm [in.])	
	Pipe(Liquid)	Pipe(Gas)
140 or less	$\phi 9.52$ [3/8"]	$\phi 15.88$ [5/8"]
141 ~ 200	$\phi 9.52$ [3/8"]	$\phi 19.05$ [3/4"]
201 ~ 250	$\phi 9.52$ [3/8"]	$\phi 22.20$ [7/8"]

Selection criteria for joints_B

Total down-stream Indoor capacity	Joint
~ 350	CMY-R201S-G
351 ~ 600	CMY-R202S-G

Table3. Piping "a", "b", "c", "d", "e", "f", "g" size selection rule (mm [in.])

Indoor Unit size	Pipe(Liquid)	Pipe(Gas)
M10 ~ M50	$\phi 6.35$ [1/4"]	$\phi 12.70$ [1/2"]
M63 ~ M80	$\phi 6.35$ [1/4"] *12	$\phi 15.88$ [5/8"]
M100 ~ M140	$\phi 9.52$ [3/8"]	$\phi 15.88$ [5/8"]
M200	$\phi 9.52$ [3/8"]	$\phi 19.05$ [3/4"]
M250	$\phi 9.52$ [3/8"]	$\phi 22.20$ [7/8"]

*12. If the length of the liquid pipe exceeds the following restriction, use the one size larger pipe.

M63	40 m
M71	40 m
M80	35 m

Piping "F", "G", "J", "K" size selection rule

Total down-stream Indoor capacity	(mm [in.])		
	Pipe(Liquid)	Pipe(HP Gas)	Pipe(LP Gas)
200 or less	$\phi 9.52$ [3/8"]	$\phi 15.88$ [5/8"]	$\phi 19.05$ [3/4"]
201 to 300	$\phi 9.52$ [3/8"]	$\phi 19.05$ [3/4"]	$\phi 22.20$ [7/8"]
301 to 350	$\phi 12.70$ [1/2"]	$\phi 19.05$ [3/4"]	$\phi 28.58$ [1-1/8"]
351 to 400	$\phi 12.70$ [1/2"]	$\phi 22.20$ [7/8"]	$\phi 28.58$ [1-1/8"]
401 to 600	$\phi 15.88$ [5/8"]	$\phi 22.20$ [7/8"]	$\phi 28.58$ [1-1/8"]
601 to 650	$\phi 15.88$ [5/8"]	$\phi 28.58$ [1-1/8"]	$\phi 28.58$ [1-1/8"]
651 to 800	$\phi 19.05$ [3/4"]	$\phi 28.58$ [1-1/8"]	$\phi 34.93$ [1-3/8"]
801 to 1000	$\phi 19.05$ [3/4"]	$\phi 28.58$ [1-1/8"]	$\phi 41.28$ [1-5/8"]
1001 or above	$\phi 19.05$ [3/4"]	$\phi 34.93$ [1-3/8"]	$\phi 41.28$ [1-5/8"]

HP: High pressure, LP: Low pressure

12-2-3. If more than 12 ports are in use, or if there is more than one BC controller in use for two outdoor units

- Note1. No Header usable on PURY system.
- Note2. Indoor unit sized M100-M250 should be connected to BC controller via Y shape joint CMY-R170M-E.
- Note3. Indoor unit sized M100-M250 does NOT share BC controller ports with other Indoor units;
- Note4. As bents cause pressure loss on transportation of refrigerant, fewer bents design is better;
Piping length needs to consider the actual length and equivalent length which bents are counted.
Equivalent piping length (m) = Actual piping length + "M" × Number of bent.
- Note5. Set DIP-SW 1-1 on the BC controller to ON when connecting Indoor unit(s) with a total capacity of 81-250 to 2 ports.
- Note6. It is also possible to connect Indoor unit(s) with a total capacity of 81-140 to 1 port (set DIP-SW 1-1 to OFF).
However, the cooling capacity should be multiplied by a correction factor 0.98.
- Note7. Do not connect multiple indoor units to the same port when operating each of them in different mode (cooling, heating, stop, and thermo-off). In case of connecting multiple indoor units to the same port, connecting all indoor units to one remote controller and switching SW1-1 ON in the all connected indoor units (switch to thermostat built in the remote controller) are recommended.
- Note8. The maximum total capacity of indoor units that can be connected to each sub BC controller CMB-M-V-MB-SV is 350.
- Note9. Indoor capacity is described as its model size. For example, PEFY-MS63VMA-A1, its capacity is 63.
- Note10. Total down-stream Indoor capacity is the summary of the model size of Indoors down-stream. For example, PEFY-MS63VMA-A1 + PEFY-MS32VMA-A1: Total Indoor capacity = 63 + 32 = 95.
- Note11. To connect the BC controller to the main pipe, use the reducer (CMY-R304S-G1).
- Note12. To connect the sub BC controller to the main BC controller, use the reducer (CMY-R303S-G1 or CMY-R306S-G).
- Note13. Install the pipes correctly referring to the section titled "Procedures for installing the branched pipes."
- Note14. Up to 11 sub BC controllers can be connected.

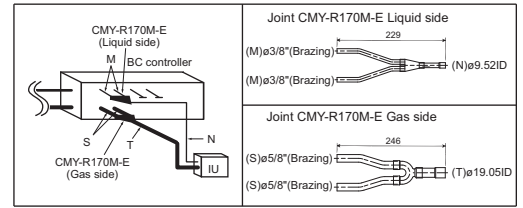

Fig. A

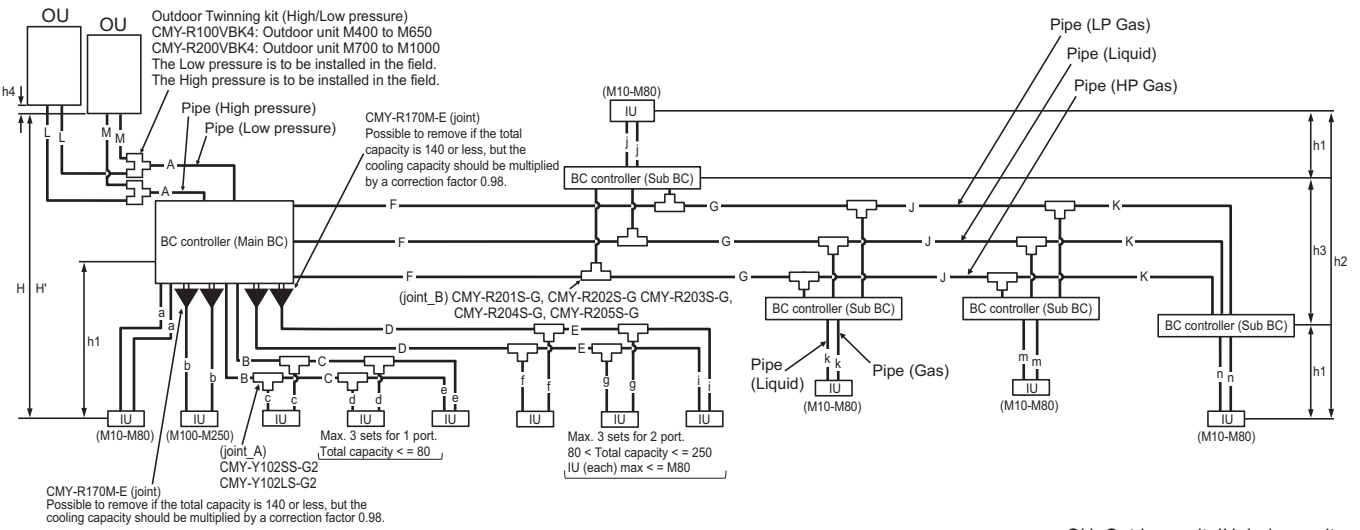

Fig. Piping scheme

OU: Outdoor unit, IU: Indoor unit

Piping length limitation *11

Item	Piping in the figure	Max. length	Max. equivalent length (m [ft.])
Total piping length (Total length of high pressure and liquid pipes)	$L+M+A+B+C+D+E+F+G+J+K+a+b+c+d+e+f+g+i+j+k+m+n$	*1	-
Farthest IU from OU	$L(M)+A+F+G+J+K+n$	165 [541]	190 [623]
Distance between OU and BC	$L(M)+A$	110 [360] *1	110 [360] *1
Farthest IU from BC controller	$D+E+i$	60 [197] *2 *3	60 [197] *2*3
Farthest IU from BC controller via Sub BC controller	$F+G+J+K+n$	90 [295] *9	90 [295] *9
Height between OU and IU (OU above IU)	H	50 [164] *7	-
Height between OU and IU (OU under IU)	H'	40 [131] *8	-
Height between IU and BC	h1	15 [49] (10 [32]) *4	-
Height between IU and IU	h2	30 [98] (20 [65]) *5	-
Height between BC(Main or Sub) and BC(Sub)	h3	15 [49] (10 [32]) *6	-
Distance between Main unit and Sub unit	L+M	5 [16]	-
Height between Main unit and Sub unit	h4	0.1 [0.3]	-

OU: Outdoor Unit; IU: Indoor Unit; BC: BC controller

- *1. Refer to "Total piping length restrictions" section.
- *2. Details refer to Fig. 2.
- *3. When the M200 or M250 model of indoor units are connected to the system, the maximum distance from the BC controller to the farthest indoor unit (indicated as "D + E + i" in the figure) is 40 m [131 ft].
- *4. Distance of Indoor sized M200, M250 from BC must be less than 10 m [32 ft], if any.
- *5. Distance of Indoor sized M200, M250 from IU must be less than 20 m [65 ft], if any.
- *6. When using 2 or more Sub BC controllers, max. height "h3" should be considered.
- *7. 113 m [370 ft] is available depending on the model and installation conditions. For more detailed information, contact your local distributor.
- *8. 60 m [197 ft] is available depending on the model and installation conditions. For more detailed information, contact your local distributor.
- *9. When the piping length or the vertical separation exceeds the limit specified in Fig. 2, connect a sub BC to the system.
The restriction for a system with a sub BC connection is shown in Fig. 3.
When a given system configuration falls within the shaded area in Fig. 3, increase the size of the high-pressure pipe and the liquid pipe between the main BC and sub BC by one size. The maximum liquid branch pipe diameter is ø19.05. If a given system already has a ø19.05-pipe between the main BC and sub BC, there is no need to increase the pipe size. When using M32, M40, M50, M100, or M125 model of indoor units, increase the size of the liquid branch pipe between the sub BC and indoor unit by one size.
When using indoor models M140 or larger, the restrictions shown in Fig. 2 cannot be exceeded.
- *10. When the high pressure piping length is 65 m or less, use ø22.2 (ø7/8) pipe.
When the high pressure piping length exceeds 65 m, use ø22.2 (ø7/8) pipe until 65 m, use ø28.58 (ø1-1/8) pipe for the part that exceeds 65 m.
- *11. Total length of high-pressure pipes and liquid pipes
- *12. The piping length between the BC controller and the indoor unit is subject to restrictions depending on the installation location and the capacity of the indoor unit.
For details, refer to the New Design Tool software of Mitsubishi Electric Corporation.

Bent equivalent length

Outdoor Model	m/bent [ft./bent]
M400YSXM-A	0.50 [1.65]
M450YSXM-A	0.50 [1.65]
M500YSXM-A	0.50 [1.65]
M550YSXM-A	0.50 [1.65]
M600YSXM-A	0.50 [1.65]
M650YSXM-A	0.50 [1.65]
M700YSXM-A	0.70 [2.30]
M750YSXM-A	0.70 [2.30]
M800YSXM-A	0.70 [2.30]
M850YSXM-A	0.80 [2.63]
M900YSXM-A	0.80 [2.63]
M950YSXM-A	0.80 [2.63]
M1000YSXM-A	0.80 [2.63]

Piping length and height between IU and BC controller

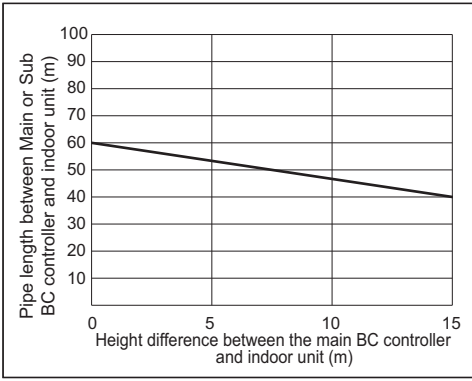

Fig. 2

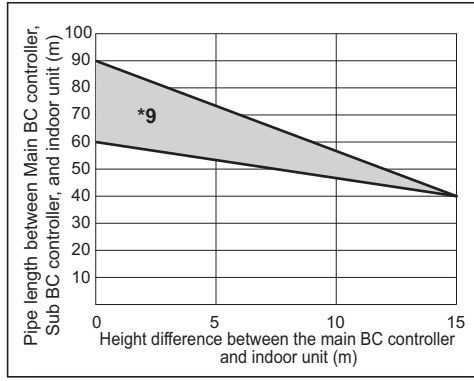
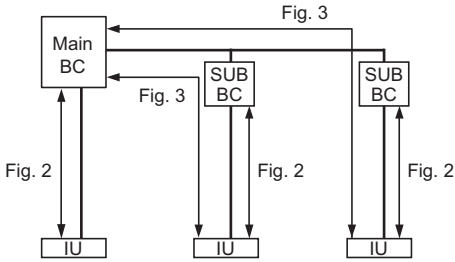

Fig. 3



*9. When the piping length or the vertical separation exceeds the limit specified in Fig. 2, connect a sub BC to the system.

The restriction for a system with a sub BC connection is shown in Fig. 3.

When a given system configuration falls within the shaded area in Fig. 3, increase the size of the high-pressure pipe and the liquid pipe between the main BC and sub BC by one size.

The maximum liquid branch pipe diameter is $\phi 19.05$. If a given system already has a $\phi 19.05$ -pipe between the main BC and sub BC, there is no need to increase the pipe size.

When using M32, M40, M50, M100, or M125 model of indoor units, increase the size of the liquid branch pipe between the sub BC and indoor units, by one size.

When using indoor models M140 or larger, the restrictions shown in Fig. 2 cannot be exceeded.

Piping "A" size selection rule

(mm [in.])

Outdoor Model	Pipe(High pressure)	Pipe(Low pressure)
M400YSXM-A	$\phi 22.20$ [7/8"]	$\phi 28.58$ [1-1/8"]
M450YSXM-A	$\phi 22.20$ [7/8"]	$\phi 28.58$ [1-1/8"]
M500YSXM-A	$\phi 22.20$ [7/8"]	$\phi 28.58$ [1-1/8"]
M550YSXM-A	$\phi 22.20$ [7/8"] *10	$\phi 28.58$ [1-1/8"]
M600YSXM-A	$\phi 22.20$ [7/8"] *10	$\phi 28.58$ [1-1/8"]
M650YSXM-A	$\phi 28.58$ [1-1/8"]	$\phi 28.58$ [1-1/8"]
M700YSXM-A	$\phi 28.58$ [1-1/8"]	$\phi 34.93$ [1-3/8"]
M750YSXM-A	$\phi 28.58$ [1-1/8"]	$\phi 34.93$ [1-3/8"]
M800YSXM-A	$\phi 28.58$ [1-1/8"]	$\phi 34.93$ [1-3/8"]
M850YSXM-A	$\phi 28.58$ [1-1/8"]	$\phi 41.28$ [1-5/8"]
M900YSXM-A	$\phi 28.58$ [1-1/8"]	$\phi 41.28$ [1-5/8"]
M950YSXM-A	$\phi 28.58$ [1-1/8"]	$\phi 41.28$ [1-5/8"]
M1000YSXM-A	$\phi 28.58$ [1-1/8"]	$\phi 41.28$ [1-5/8"]

Piping "B", "C", "D", "E" size selection rule

(mm [in.])

Total down-stream Indoor capacity	Pipe(Liquid)	Pipe(Gas)
140 or less	$\phi 9.52$ [3/8"]	$\phi 15.88$ [5/8"]
141 ~ 200	$\phi 9.52$ [3/8"]	$\phi 19.05$ [3/4"]
201 ~ 250	$\phi 9.52$ [3/8"]	$\phi 22.20$ [7/8"]

Table3. Piping "a", "b", "c", "d", "e", "f", "g" size selection rule

(mm [in.])

Indoor Unit size	Pipe(Liquid)	Pipe(Gas)
M10 ~ M50	$\phi 6.35$ [1/4"]	$\phi 12.70$ [1/2"]
M63 ~ M80	$\phi 6.35$ [1/4"] *13	$\phi 15.88$ [5/8"]
M100 ~ M140	$\phi 9.52$ [3/8"]	$\phi 15.88$ [5/8"]
M200	$\phi 9.52$ [3/8"]	$\phi 19.05$ [3/4"]
M250	$\phi 9.52$ [3/8"]	$\phi 22.20$ [7/8"]

*13. If the length of the liquid pipe exceeds the following restriction, use the one size larger pipe.

M63	40 m
M71	40 m
M80	35 m

Piping "F", "G", "J", "K" size selection rule

(mm [in.])

Total down-stream Indoor capacity	Pipe(Liquid)	Pipe(HP Gas)	Pipe(LP Gas)
200 or less	$\phi 9.52$ [3/8"]	$\phi 15.88$ [5/8"]	$\phi 19.05$ [3/4"]
201 to 300	$\phi 9.52$ [3/8"]	$\phi 19.05$ [3/4"]	$\phi 22.20$ [7/8"]
301 to 350	$\phi 12.70$ [1/2"]	$\phi 19.05$ [3/4"]	$\phi 28.58$ [1-1/8"]
351 to 400	$\phi 12.70$ [1/2"]	$\phi 22.20$ [7/8"]	$\phi 28.58$ [1-1/8"]
401 to 600	$\phi 15.88$ [5/8"]	$\phi 22.20$ [7/8"]	$\phi 28.58$ [1-1/8"]
601 to 650	$\phi 15.88$ [5/8"]	$\phi 28.58$ [1-1/8"]	$\phi 28.58$ [1-1/8"]
651 to 800	$\phi 19.05$ [3/4"]	$\phi 28.58$ [1-1/8"]	$\phi 34.93$ [1-3/8"]
801 to 1000	$\phi 19.05$ [3/4"]	$\phi 28.58$ [1-1/8"]	$\phi 41.28$ [1-5/8"]
1001 or above	$\phi 19.05$ [3/4"]	$\phi 34.93$ [1-3/8"]	$\phi 41.28$ [1-5/8"]

HP: High pressure, LP: Low pressure

Piping "L", "M" size selection rule

(mm [in.])

Outdoor Model	Pipe(High pressure)	Pipe(Low pressure)
M200YXM-A	$\phi 15.88$ [5/8"]	$\phi 19.05$ [3/4"]
M250YXM-A	$\phi 19.05$ [3/4"]	$\phi 22.20$ [7/8"]
M300YXM-A	$\phi 19.05$ [3/4"]	$\phi 22.20$ [7/8"]
M350YXM-A	$\phi 19.05$ [3/4"]	$\phi 28.58$ [1-1/8"]
M400YXM-A	$\phi 22.20$ [7/8"]	$\phi 28.58$ [1-1/8"]
M450YXM-A	$\phi 22.20$ [7/8"]	$\phi 28.58$ [1-1/8"]
M500YXM-A	$\phi 22.20$ [7/8"]	$\phi 28.58$ [1-1/8"]

Selection criteria for joints_A

Total down-stream Indoor capacity	Joint
~ 200	CMY-Y102SS-G2
201 ~ 250	CMY-Y102LS-G2

Selection criteria for joints_B

Total down-stream Indoor capacity	Joint
~ 350	CMY-R201S-G
351 ~ 600	CMY-R202S-G
601 ~ 650	CMY-R203S-G
651 ~ 1000	CMY-R204S-G
1001 ~	CMY-R205S-G

PURY-M-Y(S)XM-A

12-2-4. Total piping length restrictions

[PURY-M200, 250, 300YXM-A]

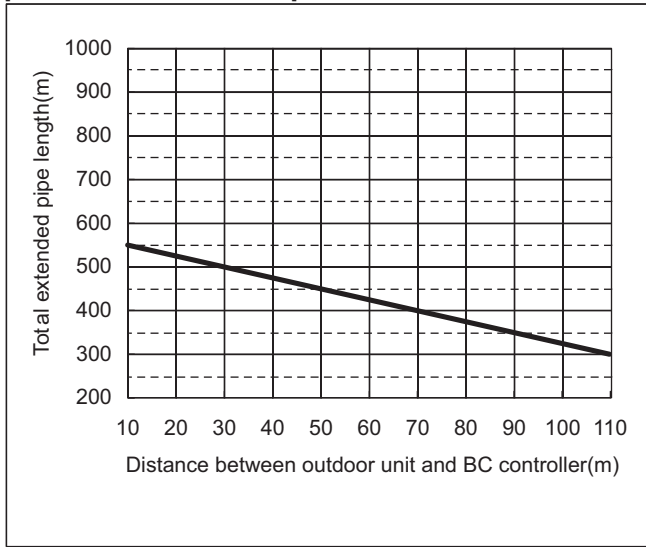

[PURY-M350, 400, 450, 500YXM-A]

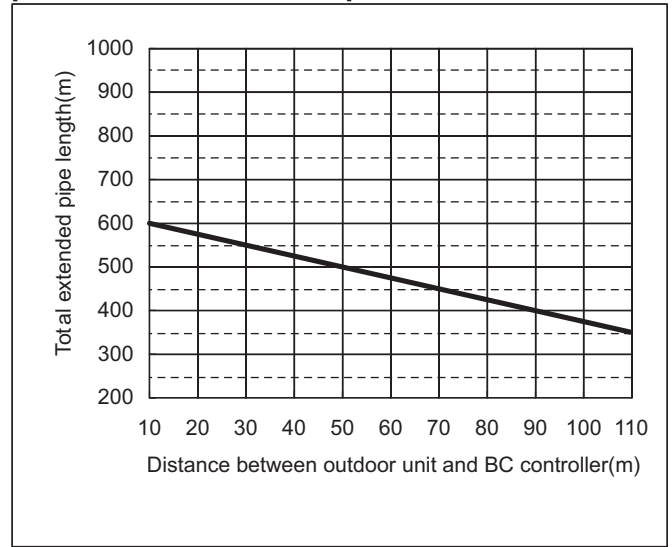

[PURY-M400, 450, 500, 550, 600YSXM-A]

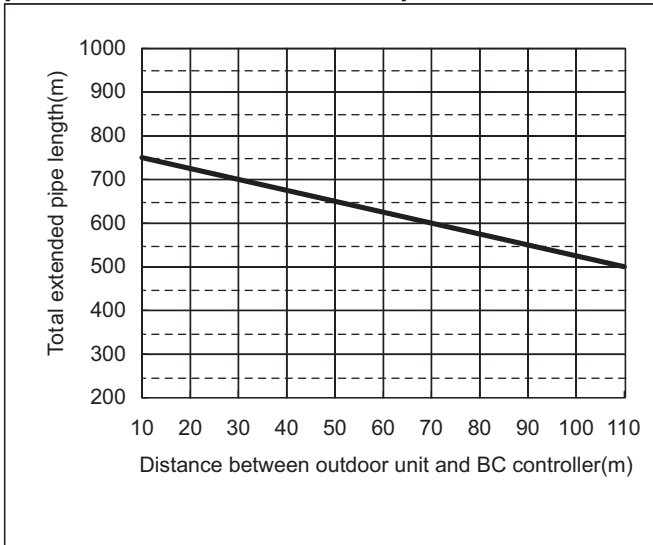

[PURY-M650YSXM-A]

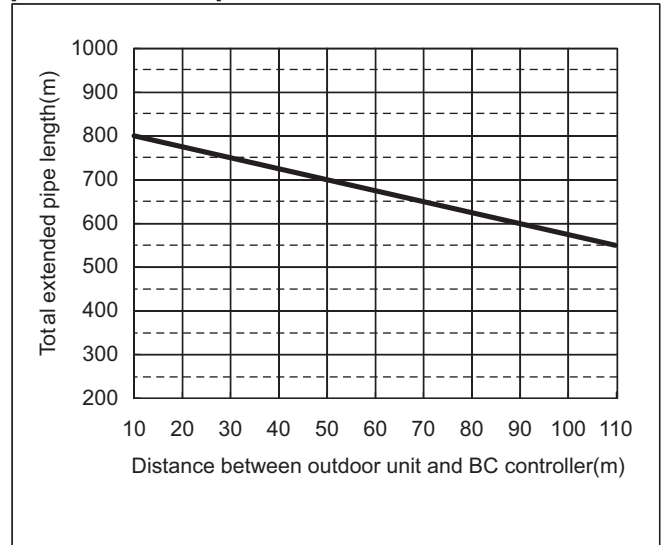

[PURY-M700, 750, 800, 850, 900, 950, 1000YSXM-A]

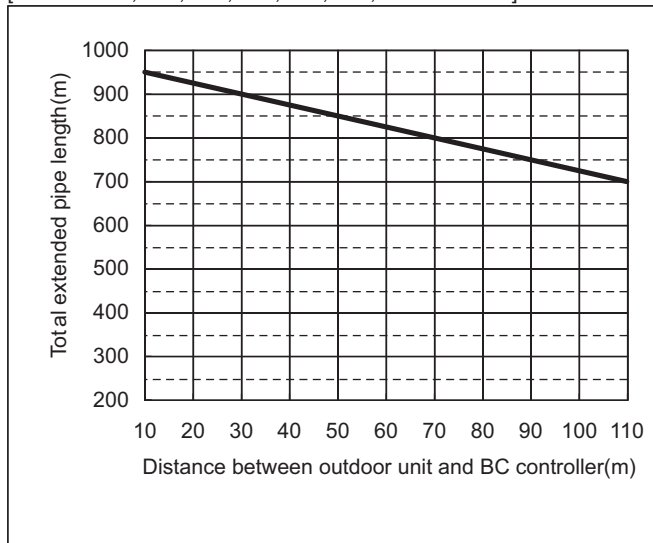

12-3. Refrigerant charging calculation

At the time of shipping, the outdoor unit is charged with the refrigerant. As this charge does not include the amount needed for extended piping, additional charging for each refrigerant line will be required on site. In order that future servicing may be properly provided, always keep a record of the size and length of each refrigerant line and the amount of additional charge by writing it in the space provided on the outdoor unit.

■ Calculation of additional refrigerant charge

- The amount of refrigerant to be added depends on the size and the total length of the high-pressure piping and liquid piping.
- Calculate the amount of refrigerant to be charged according to the formula below.
- Round up the calculation result to the nearest 0.1 kg (0.1 oz).
- The refrigerant amount in the high-pressure piping between the main and sub BC is not included in the calculation of the total additional refrigerant amount.

<Additional Charge>

<Formula>

• When the piping length from the outdoor unit to the farthest indoor unit is 30.5 m (100 ft) or shorter

Amount of additional charge (kg)	=	High-pressure pipe ø28.58 total length × 0.32 (kg/m)	+	High-pressure pipe ø22.2 total length × 0.20 (kg/m)	+	High-pressure pipe ø19.05 total length × 0.14 (kg/m)	+	High-pressure pipe ø15.88 total length × 0.099 (kg/m)	
		Liquid pipe ø19.05 total length × 0.26 (kg/m)	+	Liquid pipe ø15.88 total length × 0.17 (kg/m)	+	Liquid pipe ø12.7 total length × 0.11 (kg/m)	+	Liquid pipe ø9.52 total length × 0.054 (kg/m)	+
+		Main or sub BC controller	Amount (kg/unit)		Total capacity of connected indoor units		Amount (kg) (to be added for indoor unit)		
		MA-type	3.1		80 or below	1.8			
		MB-type	0.8		81 to 160	2.3			
					161 to 290	2.7			
					291 to 390	3.2			
					391 to 510	4.1			
					511 to 630	4.5			
					631 to 710	5.4			
					711 to 800	7.2			
					801 to 890	8.1			
					891 to 1070	9.0			
					1071 to 1250	10.8			
					1251 or above	12.6			

- * When connecting PEFY-MS50/63VMA(L)-A1 units, add 0.34 kg of refrigerant for each of these units.
- * When connecting PEFY-MS71VMA(L)-A1 units, add 0.46 kg of refrigerant for each of these units.
- * When connecting PLFY-M50/63VEM6-E units, add 0.34 kg of refrigerant for each of these units.
- * When connecting PLFY-M71VEM6-E units, add 0.46 kg of refrigerant for each of these units.

• When the piping length from the outdoor unit to the farthest indoor unit is longer than 30.5 m (100 ft)

Amount of additional charge (kg)	=	High-pressure pipe ø28.58 total length × 0.30 (kg/m)	+	High-pressure pipe ø22.2 total length × 0.19 (kg/m)	+	High-pressure pipe ø19.05 total length × 0.13 (kg/m)	+	High-pressure pipe ø15.88 total length × 0.090 (kg/m)	
		Liquid pipe ø19.05 total length × 0.24 (kg/m)	+	Liquid pipe ø15.88 total length × 0.16 (kg/m)	+	Liquid pipe ø12.7 total length × 0.10 (kg/m)	+	Liquid pipe ø9.52 total length × 0.050 (kg/m)	+
+		Main or sub BC controller	Amount (kg/unit)		Total capacity of connected indoor units		Amount (kg) (to be added for indoor unit)		
		MA-type	3.1		80 or below	1.8			
		MB-type	0.8		81 to 160	2.3			
					161 to 290	2.7			
					291 to 390	3.2			
					391 to 510	4.1			
					511 to 630	4.5			
					631 to 710	5.4			
					711 to 800	7.2			
					801 to 890	8.1			
					891 to 1070	9.0			
					1071 to 1250	10.8			
					1251 or above	12.6			

* When the piping length from the outdoor unit to farthest indoor unit is longer than 30.5 m (100 ft), no refrigerant needs to be added to the indoor units with specific model names.

■ Sample calculation

Units "m" and "kg"

Indoor	1: 50	A: ø28.58	40 m	a: ø6.35	10 m
	2: 250	B: ø9.52	10 m	b: ø9.52	10 m
	3: 15	C: ø12.7	20 m	c: ø6.35	5 m
	4: 15	D: ø9.52	5 m	d: ø6.35	5 m
	5: 125	E: ø9.52	5 m	e: ø9.52	5 m
	6: 100	F: ø9.52	5 m	f: ø9.52	5 m
	7: 80	G: ø19.05	3 m	g: ø6.35	5 m
	8: 50	H: ø19.05	1 m	h: ø6.35	10 m

The total length of each liquid line as follows:

- ø28.58: A = 40 m
- ø19.05: G + H = 4 m
- ø12.7: C = 20 m
- ø9.52: B + D + E + F + b + e + f = 45 m
- ø6.35: a + c + d + g + h = 35 m

<Calculation example>

Additional refrigerant charge
 = 40 × 0.30 + 4 × 0.13 + 20 × 0.10
 + 45 × 0.050 + 35 × 0.018 + 3.1 + 0.8 × 4 + 5.4
 = 29.1 (29.10) kg

Outdoor M700
 Main BC controller CMB-M108V-MA-SV
 Sub BC controller CMB-M104V-MB-SV × 4

Sample connection (with 5 BC controllers and 8 indoor units) (PURY-M700YSXM-A)

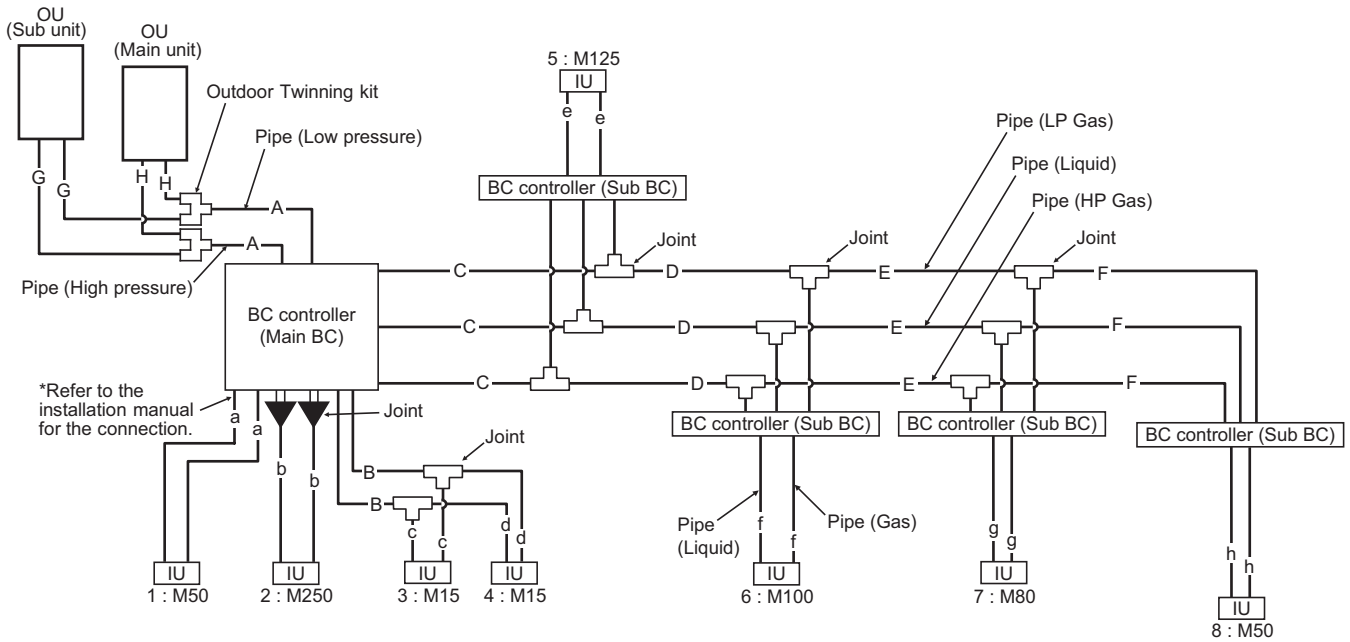

■ Limitation of the amount of refrigerant to be charged

The above calculation result of the amount of refrigerant to be charged must become below the value in the table below.

[kg (oz)]

Unit model	Factory-charged amount	Maximum amount to be added on site	Maximum total amount in the system
M200YXM	8.0 (282)	23.0 (811)	31.0 (1093)
M250YXM	8.0 (282)	27.4 (966)	35.4 (1248)
M300YXM	8.0 (282)	28.3 (998)	36.3 (1280)
M350YXM	9.3 (328)	27.9 (984)	37.2 (1312)
M400YXM	9.3 (328)	28.6 (1008)	37.9 (1336)
M450YXM	9.3 (328)	28.6 (1008)	37.9 (1336)
M500YXM	9.3 (328)	28.6 (1008)	37.9 (1336)
M400YSXM	16.0 (564)	42.6 (1503)	58.6 (2067)
M450YSXM	16.0 (564)	43.5 (1534)	59.5 (2098)
M500YSXM	16.0 (564)	45.3 (1598)	61.3 (2162)
M550YSXM	16.0 (564)	46.2 (1630)	62.2 (2194)
M600YSXM	16.0 (564)	46.6 (1644)	62.6 (2208)
M650YSXM	17.3 (610)	45.3 (1598)	62.6 (2208)
M700YSXM	18.6 (656)	44.2 (1559)	62.8 (2215)
M750YSXM	18.6 (656)	44.2 (1559)	62.8 (2215)
M800YSXM	18.6 (656)	45.3 (1598)	63.9 (2254)
M850YSXM	18.6 (656)	45.4 (1601)	64.0 (2257)
M900YSXM	18.6 (656)	45.9 (1619)	64.5 (2275)
M950YSXM	18.6 (656)	46.5 (1640)	65.1 (2296)
M1000YSXM	18.6 (656)	46.7 (1647)	65.3 (2303)

• Both refrigerant overcharge and undercharge will cause problems. Charge the system with the proper amount of refrigerant.

13-1. General requirements for installation

1. If possible, locate the unit to reduce the direct thermal radiation to the unit.
2. Consider the amount of noise the unit produces when choosing an installation location.

Valves and refrigerant flow on the outdoor/heat source unit may generate noise.

3. Avoid sites that may encounter strong winds.
4. Ensure the installation site can bear the weight of the unit.
5. Condensation should be moved away from the unit, particularly in heating mode.
6. Provide enough space for installation and service as shown in section 13-2. Spacing.
7. Avoid sites where acidic solutions or chemical sprays (such as sulfur sprays) are used frequently.
8. Protect the unit from exposure to combustible gases, oil, steam, chemical gas like acidic solution, sulfur gas and so on.

13-2. Spacing

In case of single installation

When installing the unit, provide sufficient space as shown in the figure below. If the height of the walls around the unit exceeds the height limit, add half of the height that exceeds the limit ($h/2$) to L_1 , L_2 , and L_3 as shown in the table below. When the unit is installed adjacent to the building wall, space must be left open in two directions. A space of at least 300 mm (11-13/16 in) must be left between the unit and the wall, and 200 mm (7-14/16 in) on the side of the unit.

(1) When all walls are within their height limits*.

[mm (in)]

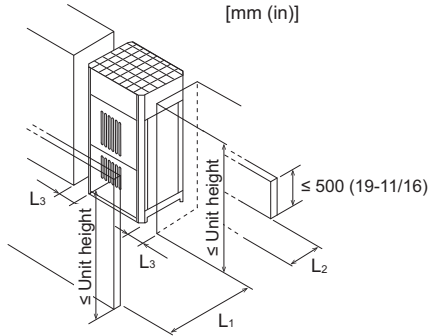

* Height limit

Front/Right/Left/Rear	Same height or lower than the overall height of the unit
-----------------------	--

	Required minimum distance [mm (in)]		
	L ₁ (Front)	L ₂ (Rear)	L ₃ (Right/Left)
When the distance behind the unit (L ₂) needs to be small	450 (17-3/4)	100 (3-15/16)	50 (2)
When the distance to the right or left (L ₃) needs to be small	450 (17-3/4)	300 (11-13/16)	20 (13/16)

(2) When one or more walls exceed their height limits*.

When the wall(s) at the front and/or the right/left exceed(s) their height limits

When the wall at the rear exceeds its height limit

When all walls exceed their height limits

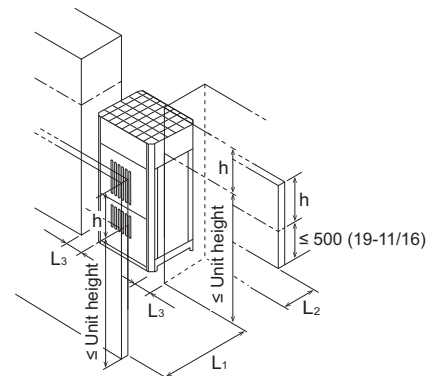
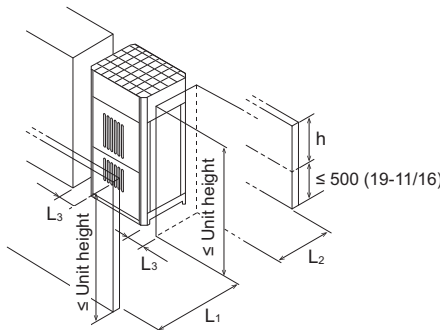
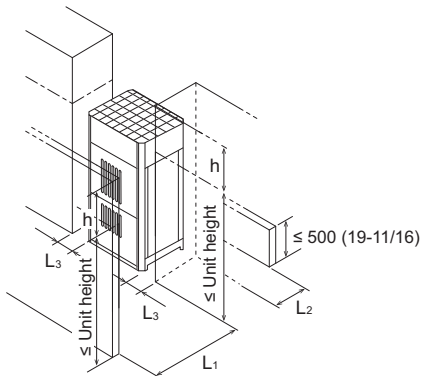

If the height of the walls around the unit exceeds the height limit, add half of the height that exceeds the limit ($h/2$) to L_1 , L_2 , and L_3 as shown in the table below.

	Required minimum distance [mm (in)]		
	L ₁ (Front)	L ₂ (Rear)	L ₃ (Right/Left)
When the distance behind the unit (L ₂) needs to be small	450 (17-3/4) + $h/2$	100 (3-15/16) + $h/2$	50 (2) + $h/2$
When the distance to the right or left (L ₃) needs to be small	450 (17-3/4) + $h/2$	300 (11-13/16) + $h/2$	20 (13/16) + $h/2$

(3) When there are overhead obstacles

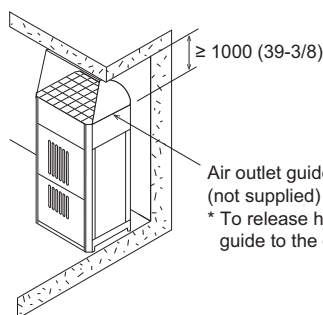
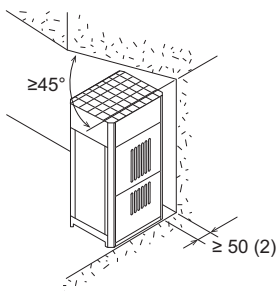

In case of collective installation and continuous installation

- When installing multiple units, make sure to take into consideration factors such as providing enough space for people to pass through, ample space between blocks of units, and sufficient space for airflow. (The areas marked with (A) in the figures below must be left open.)
- In the same way as with the single unit installation, if the height of the walls around the unit exceeds the height limit, add half of the height that exceeds the limit ($h/2$) to L_1 , L_2 , and L_3 as shown in the table below. When installing the unit adjacent to a building wall, ensure that at least two directions are open, with a rear space of at least 300 mm and a side space of at least 200 mm from the wall. When installing the units side by side, ensure a space of at least 400 mm between the units.
- If there are walls in the front and rear of the block of units, up to six units can be installed consecutively side by side, and a space of 1000 mm (39-3/8 in) or more must be left between each block of six units.

(1) Side-by-side installation

When the distances between the units (L_4) need to be small

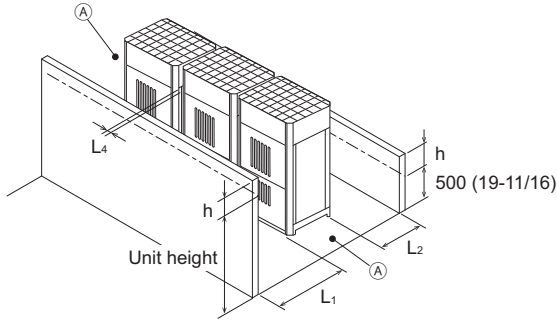

Required minimum distance [mm (in)]		
L_1 (Front)	L_2 (Rear)	L_4 (Between)
$450 (17-3/4) + h/2$	$300 (11-13/16) + h/2$	$40 (1-10/16)$

When the distance behind the block of units (L_2) needs to be small

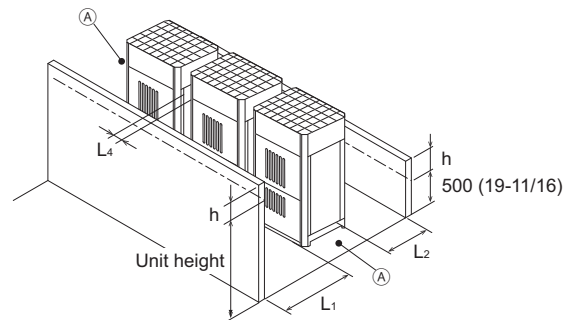

Required minimum distance [mm (in)]		
L_1 (Front)	L_2 (Rear)	L_4 (Between)
$450 (17-3/4) + h/2$	$100 (3-15/16) + h/2$	$100 (3-15/16)$

(2) Face-to-face installation

When there are walls in the front and rear of the block of units

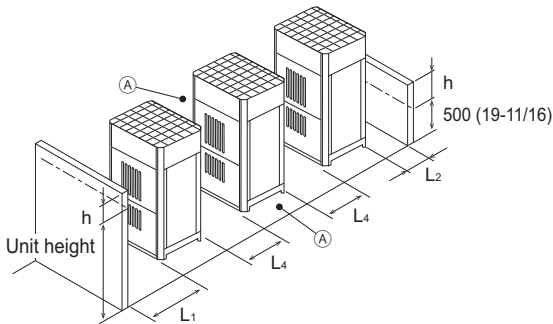

Required minimum distance [mm (in)]		
L_1 (Front)	L_2 (Rear)	L_4 (Between)
$450 (17-3/4) + h/2$	$100 (3-15/16) + h/2$	$450 (17-3/4)$

When there is a wall on either the right or left side of the block of units

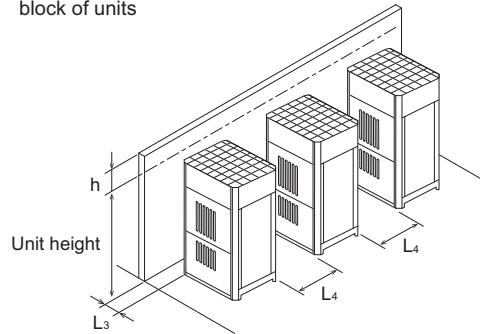

Required minimum distance [mm (in)]	
L_3 (Right/Left)	L_4 (Between)
$20 (13/16) + h/2$	$450 (17-3/4)$

(3) Combination of face-to-face and side-by-side installations

When there are walls in the front and rear of the block of units

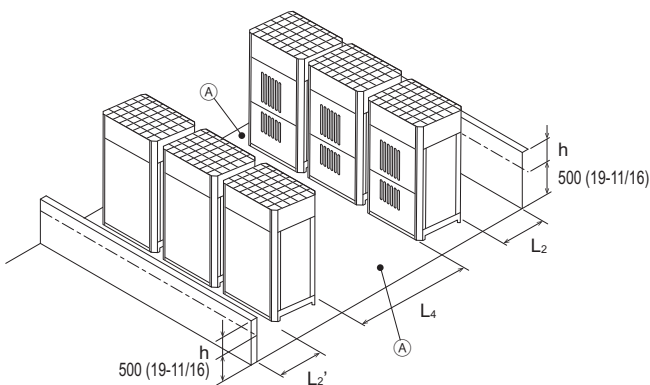

Required minimum distance [mm (in)]		
L_2 (Rear)	L_2' (Rear)	L_4 (Between)
$300 (11-13/16) + h/2$	$300 (11-13/16) + h/2$	$900 (35-7/16)$

When there are two walls in an L-shape

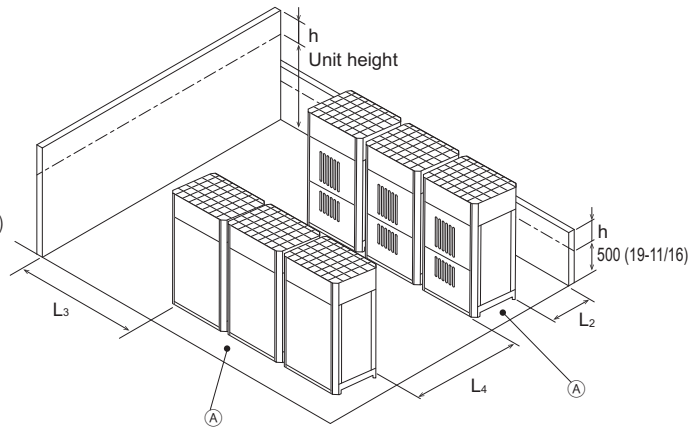

Required minimum distance [mm (in)]		
L_2 (Rear)	L_3 (Right/Left)	L_4 (Between)
$300 (11-13/16) + h/2$	$1000 (39-3/8) + h/2$	$900 (35-7/16)$

(A): Leave open in two directions.

(4) Example of installation in a walled-in area (on all four sides *1)

[mm (in)]

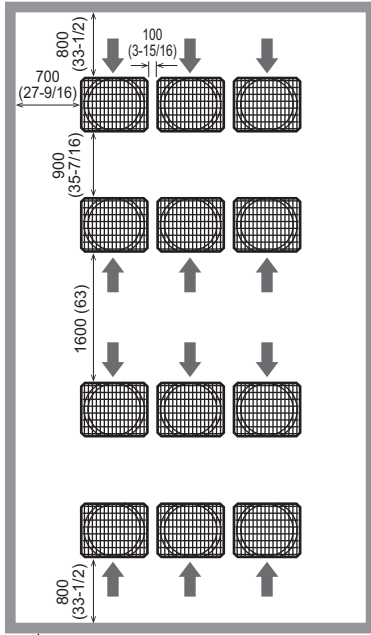

The height of the wall should be equal to or lower than the top of the outdoor unit.

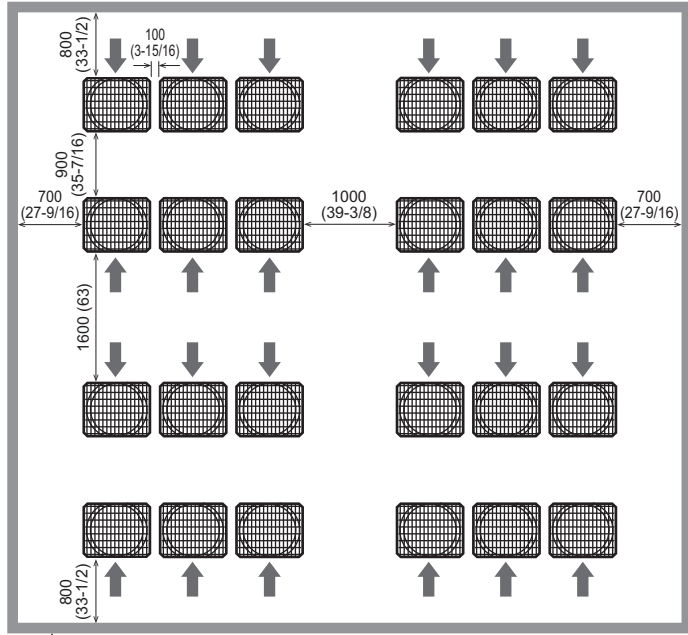

The height of the wall should be equal to or lower than the top of the outdoor unit.

*1 Maintaining the specified wall clearances above allows installation of the outdoor unit in a space enclosed on three sides by walls.

*2 When installing the outdoor unit in a walled-in area, in addition to the above restrictions, adhere to the installation restrictions for locations where refrigerant can stagnate. For details, refer to R32 City Multi Technical Manual (System Design and General Safety Considerations) or Installation Manual.

13-3. Piping direction

13-3-1. Lifting method

- Always use two slings to lift up the unit. Each sling must be at least 8 m (26 ft) long and must be able to support the weight of the unit.
- Put protective pads between slings and the unit where the slings touch the unit at the base to protect the unit from being scratched.
- Make sure that the angles between slings at the top are less than 40 degrees

M200, 250, 300

M350, 400, 450, 500

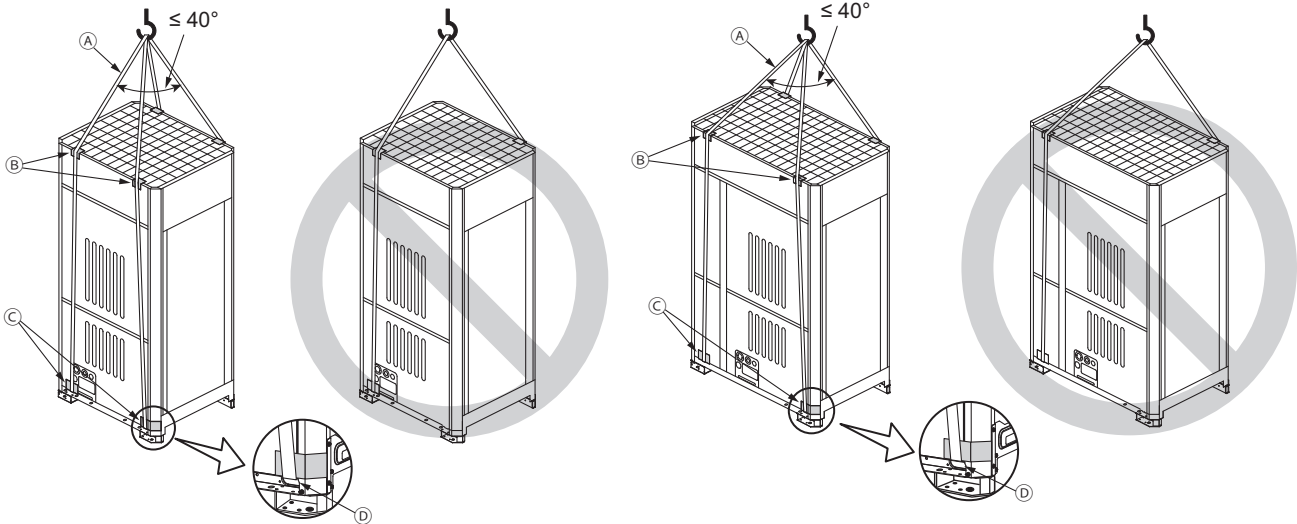

- (A) Slings (Min. 8 m (26 ft) x 2)
- (B) Protective pads
(two each in the front and back)
- (C) Protective pads
(two each in the front and back)
- (D) Sling holes
(two each in the front and back)

CAUTION

Exercise caution when transporting products.

- Products weighing more than 20 kg [45 LBS] should not be carried alone.
- Do not carry the product by the PPbands.
- To avoid the risk of injury, do not touch the heat exchanger fins.
- Plastic bags may pose a risk of choking hazard to children. Tear plastic bags into pieces before disposing of them.
- When lifting and transporting outdoor units with ropes, run the ropes through lifting hole at the unit base. Securely fix the unit so that the ropes will not slide off, and always lift the unit at four points to prevent the unit from falling.

13-3-2. Installation

- Secure the unit with anchor bolts as shown in the figure below so that the unit will not topple over with strong wind or during an earthquake.
- Install the unit on a durable base made of such materials as concrete or angle steel.
- Take appropriate anti-vibration measures (e.g., vibration damper pad, vibration isolation base) to keep vibrations and noise from being transmitted from the unit through walls and floors.
- When installing a unit on a base, place an anti-vibration pad between the base and the unit.
- When using an anti-vibration rubber pad, install it so that the pad covers the entire width of the unit leg.
- All the bottom corners of the unit must still be supported by both the anti-vibration rubber pads and the base.
- Install the unit in such a way that the corner of the angle bracket at the base of the unit shown in the figure below is securely supported.
- Install the anchor bolt in such a way that the top end of the anchor bolt do not stick out more than 30 mm [1-3/16 in.].
- This unit is not designed to be anchored with post-installation-type anchor bolts, although by adding fixing brackets anchoring with such type of anchor bolts becomes possible.
- Securely bolt down the unit as illustrated below so that it will not fall over when subject to wind gusts or earthquakes.

- (A) M12 anchor bolt* procured at the site
*Required specification for M12 anchor bolt: Tensile load of 5.6 kN or more to withstand the short-term load caused by earthquakes or strong winds
- (B) (Incorrect installation) The corner section is not securely received.
- (C) Fixing bracket for M12 hole-in anchor bolt* procured at the site (3 locations to fix with M5 self-tapping screws)
*Required specification for M12 hole-in anchor bolt: Tensile load of 6.7 kN or more to withstand the short-term load caused by earthquakes or strong winds
Use the fixing bracket with sufficient strength.
- (D) Anti-vibration rubber pad
(The pad needs to be large enough to cover the entire width of each unit leg.)
- (E) Detachable leg

WARNING
Properly install the unit on a surface that can withstand the weight of the unit. Unit installed on an unstable surface may fall and cause injury.

WARNING
Take adequate measures against natural disasters including earthquakes and windstorms so that the unit will not fall or tip over. Consult your local specialist for safety measures to be taken.

<Without detachable leg>

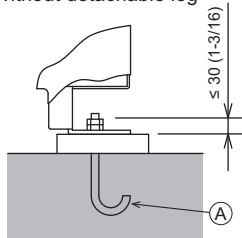

Install the unit in such a way that the corner of the angle bracket at the base of the unit shown in the figure is securely supported. The brackets may bend if they are not securely supported.

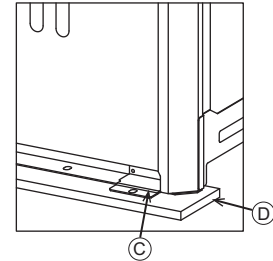
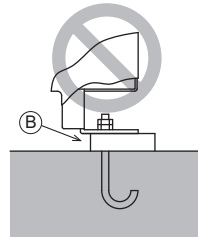

<With detachable leg>

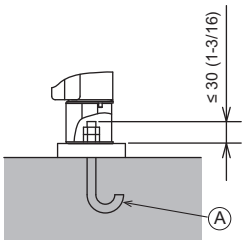

Install the unit in such a way that the corner of the angle bracket at the base of the unit shown in the figure is securely supported. The brackets may bend if they are not securely supported.

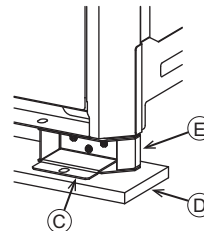

Take into consideration the durability of the base, water drainage route (Drain water is discharged from outdoor units during operation.), piping route, and wiring route when performing foundation work.

13-3-3. Anchor bolt positions

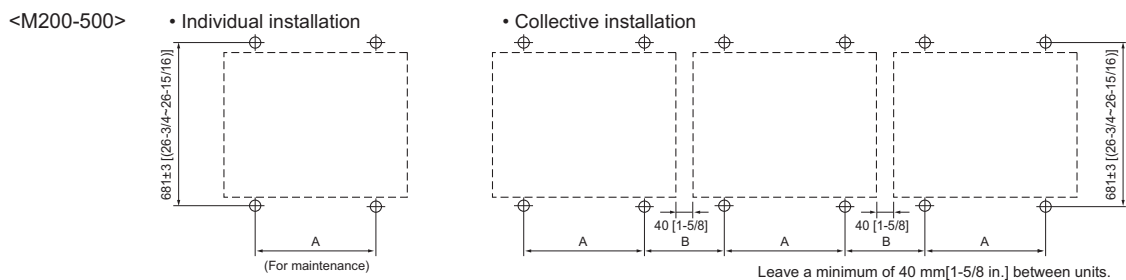

(Unit: mm [in.])

PURY	M200, 250, 300	M350, 400, 450, 500
A	760±2 [29-15/16(29-7/8~30)]	1060±2 [41-3/4(41-11/16~41-13/16)]
B	190 [7-1/2]	187 [7-3/8]

13-3-4. Installation

When the pipes and/or cables are routed at the bottom of the unit, make sure that the through hole at the base of the unit does not get blocked with the installation base.

When the pipes are routed at the bottom of the unit, the base should be at least 100 mm [3-15/16 in.] in height.

(Unit: mm[in.])

M200, 250, 300

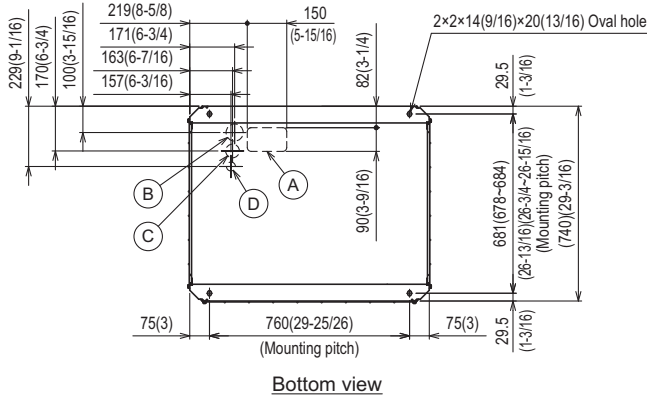

M350, 400, 450, 500

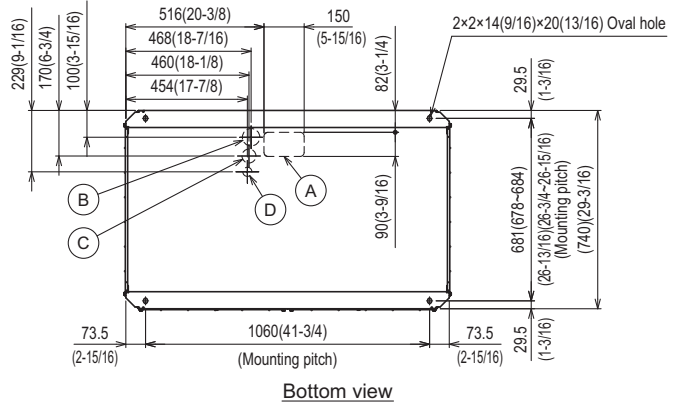

NO.	Usage	Specifications
(A)	For pipes	Bottom through hole: 150 (5-15/16) × 90(3-9/16) Knockout hole
(B)	For wires	Bottom through hole: ø65 (2-9/16) Knockout hole
		Bottom through hole: ø52 (2-1/16) Knockout hole
(D)	For transmission cables	Bottom through hole: ø34 (1-3/8) Knockout hole

Installation base parallel to the unit's front panel

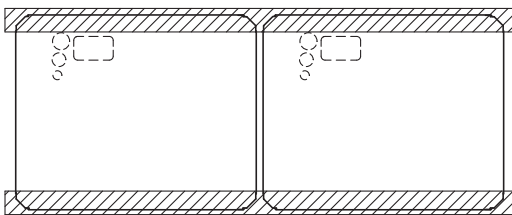

Installation base perpendicular to the unit's front panel

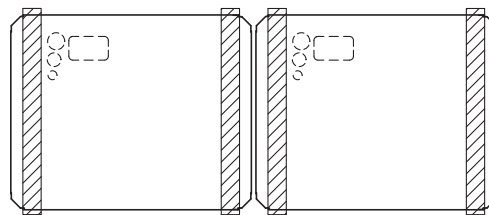

13-3-5. Refrigerant pipe routing

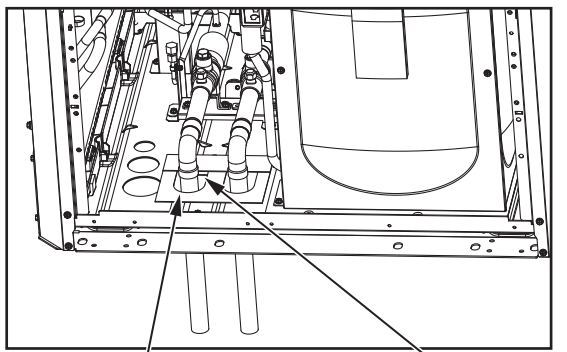

The gaps around the edges of through holes for pipes and wires on the unit allow water or mice to enter the unit and damage its parts. Close these gaps with filler plates.

This unit allows two types of pipe routing:

- Bottom piping
- Front piping

CAUTION

To prevent small animals, water and snow from entering the unit and damage its parts, close the gap around the edges of through holes for pipes and wires with filler plates.

13-3-6. Twinning on the outdoor unit side

- The pipe from multiple outdoor units must be installed so that oil will not accumulate in the pipe under certain conditions. Refer to the figures below for details.

* Small dots in the figures indicate branching points.

Ⓐ To a BC controller

- The pipe from the outdoor units must be inclined downward to the indoor unit side. In the figure on the right, because the pipe is inclined upward, the oil in the pipe accumulates when Unit 1 is in operation and Unit 2 is stopped.



- The distance between the unit bottom and the pipe (H) must be 0.2 m (7-7/8 in) or below. In the figure on the right, because the distance is more than 0.2 m (7-7/8 in), the oil accumulates in Unit 1 when Unit 2 is in operation and Unit 1 is stopped.



- The vertical separation between units (H) must be 0.1 m (3-15/16 in) or below. In the figure on the right, because the distance is more than 0.1 m (3-15/16 in), the oil accumulates in Unit 1 when Unit 2 is in operation and Unit 1 is stopped.



- The vertical separation between units (H) must be 0.1 m (3-15/16 in) or below. In the figure on the right, because the distance is more than 0.1 m (3-15/16 in), the oil accumulates in Unit 2 when Unit 1 is in operation and Unit 2 is stopped.



- The Twinning pipe must be installed horizontally using a level vessel to avoid unit damage.

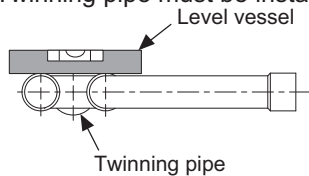

- If the length of the pipe between the branching point and the outdoor unit exceeds 2 m (6 ft), provide a trap within 2 m (6 ft) from the branching point. The trap must be at least 200 mm (7-7/8 in) in height. (high-pressure pipe only) If there is no trap, oil can accumulate inside the pipe, causing a shortage of oil and may damage the compressor.

* Small dots in the figures indicate branching points.

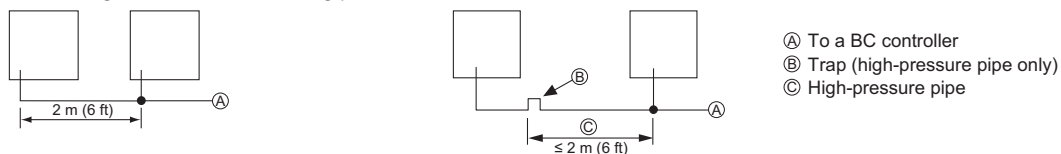

⚠ Caution:

- Do not install expansion loops or offsets other than the ones between outdoor units described on a separate sheet to prevent oil backflow and compressor start-up failure.
- Do not install solenoid valves to prevent oil backflow and compressor start-up failure.
- Do not install a sight glass because it may show improper refrigerant flow. If a sight glass is installed, inexperienced technicians that use the glass may overcharge the refrigerant.
- Refrigerant pipes may expand or shrink due to temperature fluctuations of the refrigerant inside the pipes. When installing long straight pipes, provide expansion loops or offsets to absorb the thermal expansions of the pipes.

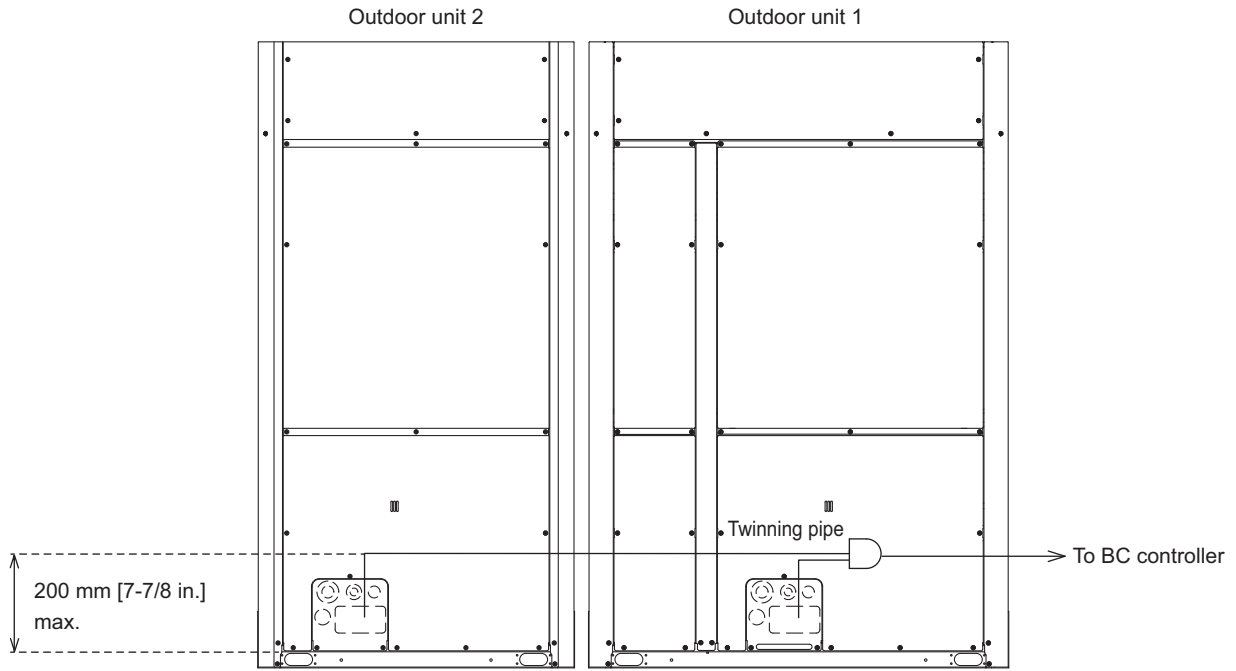

13-3-7. Twinning on the outdoor unit side

See the following drawing for connecting the pipes between the outdoor units.

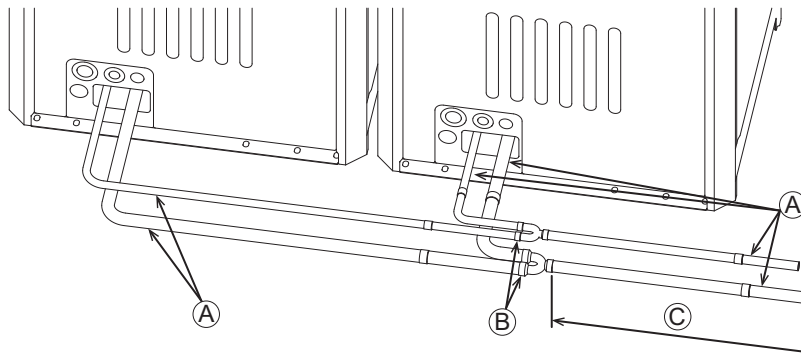

- Ⓐ On-site piping
- Ⓑ Twinning Kit
- Ⓒ The pipe section before the twinning pipe must have at least 500 mm (19-11/16 in) of straight section.

13-4. Weather countermeasure

• Take adequate measures against wind or snow in cold or windy areas to ensure the proper operation of the unit. Failing to install a snow hood may cause the unit to malfunction, leading to serious issues such as gas leak due to freezing of the heat exchanger or insufficient cooling/heating. In any of the following cases, install a snow hood:

- (1) The unit may be exposed to snow accumulation.
- (2) The unit may be exposed to strong winds.
- (3) The outside temperature could drop below -20°C (-4°F).
*Applicable when single module EM350 to EM500 models or combination module EM650 to EM1000 models are used.
- (4) The unit operates in cooling mode at 10°C (50°F) or lower.
*Do not use a snow hood made of stainless steel, which may cause the unit to rust. If the use of a stainless snow hood is the only option, contact the sales office before installing it.

- Install the unit so that the wind will not blow directly against the inlet and outlet.
- If necessary, install the unit on a raised base of the following specifications (not supplied) to prevent damage from snow.

Material: Angle iron (Build a structure that snow and wind can pass through.)
 Height: Expected maximum snowfall plus 500 mm (19-11/16 in)
 Width: Within the unit width (If the raised base is too wide, snow will accumulate on the raised base.)

- When the unit is used in a cold region and the heating operation is continuously performed for a long time when the outside air temperature is below freezing, install a heater on the raised base or take other appropriate measures to prevent water from freezing on the raised base.
- If a drain pan for centralized drainage is used in cold regions, install the drain pan so that freezing does not damage the equipment.
- When installing a snow hood, take pressure loss into consideration to prevent airflow from decreasing.
- Avoid installing a trestle or other structure under the drainage hole in the bottom plate as much as possible.
- If icicles form on the bottom plate, regularly remove them to prevent them from reaching the trestle or ground and growing under the outdoor unit.
- Snow hood

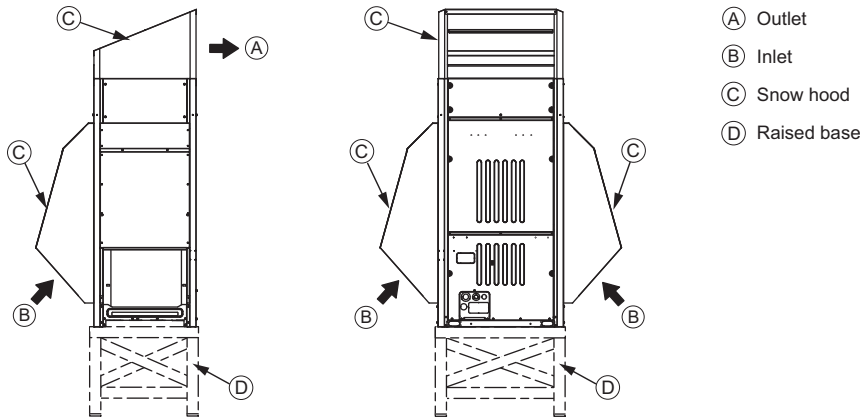

13-5. Countermeasure to wind

Referring to the figure shown below, take appropriate measures which will suit the actual situation of the place for installation. A unit installed alone is vulnerable to strong winds. Select the installation site carefully to minimize the effect of winds. To install a unit in a place where the wind always blows from the same direction, install the unit so that the outlet faces away from the direction of the wind.

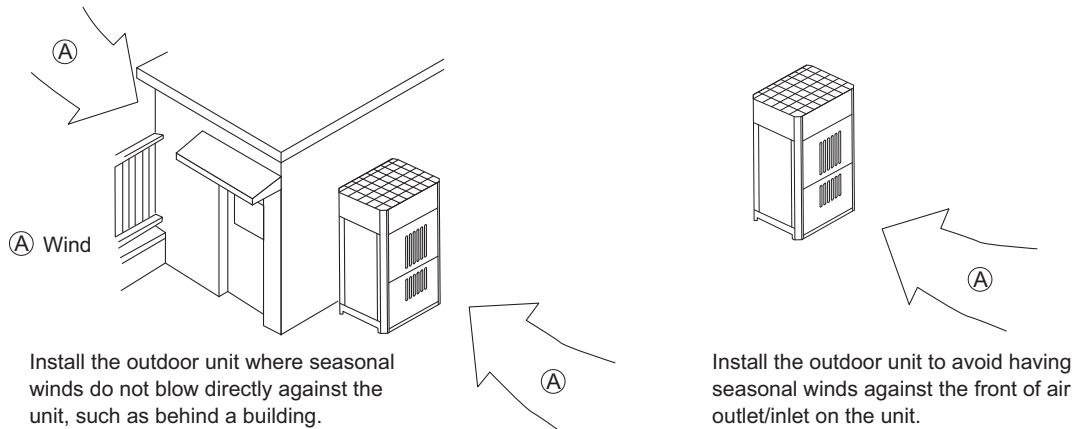

14-1. Indoor unit 200% connection

This series supports the indoor unit 200% connection. Observe the restrictions below when this function is used.

14-1-1. System restrictions and precautions

1. Connection capacity limits for indoor units

The maximum connectable capacities for indoor units are shown in the table below.

Number of outdoor units		One	Two	
Maximum connectable indoor unit capacity	PUHY series	SW4 (775) = ON	200%	160%
		SW4 (775) = OFF	130%	
	PURY series	SW4 (775) = ON	200%	160%
		SW4 (775) = OFF	150%	

2. Simultaneous operation capacity for indoor units

The maximum simultaneous operation capacity for indoor units is 130% for the PUHY series and 150% for the PURY series.

*If indoor units with a total capacity exceeding the limit are operated, their thermostats will turn on in the order the operation commands are issued. If an operation command is issued after the indoor units' total capacity limit is reached, their thermostats will remain off.

3. System refrigerant charge and piping length

When this function is used, the limits on the system refrigerant charge and piping length must be observed, as in other cases.

4. Notes

- Information on the capacity and COP cannot be disclosed.
- The heating capacity is lower than the total capacity of the connected indoor units.
- Failure to observe the restrictions will void the warranty.
- Ensure that the notes and operations described above are explained to users.

14-1-2. Switch setting procedure

The procedure for setting the switch to use this function is as follows.

DIP SW	SW setting timing	Target outdoor unit
SW4 (775)	After the power is turned on	All outdoor units including combined units

<SW setting procedure details>

1. Turn on the power for the system.
2. Check that error code 7100 (total capacity error) is issued.
3. While error code 7100 (total capacity error) is present, set SW4 (775).
*SW4 (775) setting: Set SW4-1 through SW4-10 to 111000011 (0 = OFF, 1 = ON).
4. After setting SW4 (775), push and hold the Push SW (SWP3) for two or more seconds, and check that the LED lights up.
5. Turn off the power, then turn it back on, and check that the above error is not issued.
*For systems with combined units, perform steps 3 and 4 above on all outdoor units.

Installation information

1. Installation information	2
1-1. General precautions	2
1-2. Precautions for Indoor unit and BC controller	4
1-3. Precautions for outdoor unit/heat source unit	5
1-4. Precautions for control-related items	6

* Refer to the enclosed Installation Manual for details on installation. Arrange to have an expert install the system correctly.

1-1. General precautions

1-1-1. Usage

- ♦ The air-conditioning system described in this DATA BOOK is designed for human comfort.
- ♦ This product is not designed to assist in the preservation of food, provide conditions to maintain plants or animals, or stabilize environments for the preservation of precision equipment or art objects. To prevent loss of quality, do not use the product for purposes other than those it is designed for.
- ♦ To reduce the risk of water leakage and electric shock, do not use the product for air-conditioning vehicles or vessels.

1-1-2. Installation environment

- ♦ Do not install any unit other than the dedicated unit in an area where the voltage changes significantly, large amounts of mineral oil (e.g., cutting oil) are present, cooking oil may splash, or a large quantity of steam can be generated, such as a kitchen.
- ♦ Do not install the unit in acidic or alkaline environments.
- ♦ Installation should not be performed in locations exposed to chlorine or other corrosive gases. Avoid installation near sewers.
- ♦ To reduce the risk of fire, do not install the unit in an area where flammable gas may leak or flammable material is present.
- ♦ This air-conditioning unit has a built-in microcomputer. The effects of noise should be taken into consideration when deciding on the installation position. It is recommended that the air-conditioning unit be installed in a position away from antennas or electronic devices.
- ♦ Install the unit on a solid foundation in accordance with local safety measures against typhoons, wind gusts, and earthquakes to prevent the unit from being damaged, toppling over, or falling.

1-1-3. Backup system

- ♦ In regions in which the malfunctioning of the air conditioner may have a critical effect, it is recommended to have two or more systems made up of single outdoor/heat source units and multiple indoor units.

1-1-4. Unit characteristics

- ♦ The heat pump efficiency of the outdoor unit depends on the outdoor temperature. In heating mode, performance drops as the outside air temperature drops. In cold climates, performance can be poor. Warm air will continue to be trapped near the ceiling and the floor level will remain cold. In such cases, heat pumps require a supplemental heating system or air circulator. Before purchasing, consult your local distributor for assistance in selecting the unit and system.
- ♦ When the outdoor temperature is low and the humidity is high, the heat exchanger on the outdoor/heat source unit side tends to collect frost, which reduces its heating performance. The Auto-defrost function will be activated in order to remove the frost, and the heating mode will temporarily stop for 4-15 minutes (maximum defrost time: 23 minutes). Heating mode will automatically resume upon completion of the defrost process.
- ♦ An air conditioner with a heat pump requires time to warm up the whole room after the heating operation begins, because the system circulates warm air in order to warm up the whole room.
- ♦ Sound levels were obtained in an anechoic room. Sound levels during actual operation are usually higher than the simulated values due to ambient noise and echoes. Refer to the section on "SOUND LEVELS" in the DATA BOOK for the measurement location.
- ♦ Depending on the operating conditions, the unit may generate noise due to valve operation, refrigerant flow, and pressure changes, even during normal operation. For example, in some systems such as the YXM R2 system, refrigerant flow noise in the indoor unit may occur during defrosting when the outdoor temperature is -10°C or below. Try to avoid positioning the air conditioner in locations where quietness is required. With regard to the BC controller, installation in areas such as corridor ceilings, restrooms, or plant rooms is recommended.
- ♦ The total capacity of the connected indoor units can be greater than the capacity of the outdoor/heat source unit. However, when the connected indoor units operate simultaneously, each unit's capacity may become smaller than the rated capacity.
- ♦ When starting the unit for the first time after powering on, it performs initial startup operation (capacity control operation) to prevent damage to the compressor. The initial startup operation requires a maximum of 90 minutes to complete, depending on the operating load.

1-1-5. Related equipment

- ♦Use an earth leakage breaker (ELB) with medium sensitivity, and an activation speed of 0.1 second or less.
- ♦Consult your local distributor or a qualified technician when installing an earth leakage breaker.
- ♦If the unit is an inverter type, select an earth leakage breaker able to respond to high harmonic waves and surges.
- ♦Leakage current is generated not only through the air-conditioning unit but also through the power wires. The leakage current of the main power supply is therefore greater than the total leakage current of each unit. Take the capacity of the earth leakage breaker or leakage alarm into consideration when installing one at the main power supply. To measure the leakage current simply on site, use a measurement tool equipped with a filter, and clamp all the four power wires together. The leakage current measured on the ground wire may not be accurate because the leakage current from other systems may be included in the measurement value.
- ♦Do not install a phase-advancing capacitor on a unit connected to the same power system as an inverter-type unit and its related equipment.
- ♦If a large current flows due to the malfunctioning of the product or faulty wiring, both the earth leakage breaker on the product side and the upstream overcurrent breaker may trip almost at the same time. Separate the power system or coordinate all the breakers depending on the system's priority level.

1-1-6. Unit installation

- ♦Your local distributor or a qualified technician must read the Installation Manual that is provided with each unit carefully before performing installation work.
- ♦Consult your local distributor or a qualified technician when installing the unit. Improper installation by an unqualified person may result in water leakage, electric shock, or fire.
- ♦Ensure that there is enough space around each unit.

1-1-7. Optional accessories

- ♦Only use accessories recommended by Mitsubishi Electric. Consult your local distributor or a qualified technician when installing them. Improper installation by an unqualified person may result in water leakage, power leakage, system breakdown, or fire.
- ♦Some optional accessories may not be compatible for use with the air-conditioning unit or may not be suitable for the installation conditions. Check the compatibility when considering any accessories.
- ♦Note that some optional accessories may affect the air conditioner's external form, appearance, weight, operating sound, and other characteristics.

1-1-8. Operation/Maintenance

- ♦Read the Instruction Book that is provided with each unit carefully prior to use.
- ♦Maintenance or cleaning of each unit may be risky and require expertise. Read the Instruction Book to ensure safety. Consult your local distributor or a qualified technician when special expertise is required, such as when the indoor unit needs to be cleaned.

1-2. Precautions for Indoor unit and BC controller

1-2-1. Operating environment

- ♦The refrigerant (R32) used in the air conditioner is non-toxic, but slightly flammable. However, if the refrigerant leaks, the oxygen level may drop to harmful levels. If the air conditioner is installed in a small room, measures must be taken to prevent the refrigerant concentration from exceeding the safety limit even if the refrigerant leaks. For details, refer to R32 City Multi Technical Manual (System Design and General Safety Considerations).
- ♦If the units operate in cooling mode at a humidity above 80%, condensation may collect and drip from the indoor units.
- ♦Condensate may form during use, which may result in water remaining in the drain pan. Regular checking and cleaning of the drain drainage paths, such as the drain pan or the drain pump, is recommended to prevent clogging. The neglect of a clogged drain pump may trigger the water-leakage protection function which stops operation of the entire system.

1-2-2. Unit characteristics

- ♦The return air temperature display on the remote controller may differ from the displays on the other thermometers.
- ♦The clock on the remote controller may be displayed with a time lag of approximately one minute every month.
- ♦The temperature measured by the built-in temperature sensor on the remote controller may differ from the actual room temperature due to the effect of the wall temperature.
- ♦Use the built-in thermostat on the remote controller or a separately-sold thermostat when indoor units installed on or in the ceiling operate the automatic cooling/heating switchover.
- ♦The room temperature may rise drastically due to Thermo OFF in areas where the air-conditioning load is large, such as computer rooms.
- ♦Be sure to use a regular filter. If an irregular filter is installed, the unit may not operate properly, and operating noise may increase.
- ♦The room temperature may increase above the preset temperature in environments in which the heating or air-conditioning load is small.

1-2-3. Unit installation

- ♦The insulation for the low-pressure pipe between the BC controller and the outdoor/heat source unit must be at least 20 mm thick. If the unit is installed on the top floor or in a high-temperature, high-humidity environment, thicker insulation may be necessary.
- ♦Do not have any branching points on the downstream of the refrigerant pipe header.
- ♦When a field-supplied external thermistor is installed or when a device for demand control is used, the unit may stop abnormally or damage may occur to the electromagnetic contactor. Consult your local distributor for details.
- ♦When indoor units employ fresh air intake, install a filter in the duct (locally procured) to remove dust from the air.
- ♦The 4-way or 2-way Airflow Ceiling Cassette Type units that have an outside air inlet can be connected to the duct, but need a booster fan to be installed at site. Refer to the DATA BOOK of indoor units for the available range for fresh air intake volume.
- ♦Employing fresh air intake for the indoor unit may increase the sound pressure level.
- ♦Do not install the unit above the cooking or food processing area.

1-2-4. Noise level (Sound pressure level)

- ♦The sound pressure level is a value measured in an anechoic room in accordance with the conventional method in JIS standard. The sound pressure level actually measured at the installation site is usually higher than the value indicated in DATA BOOK due to the influence of ambient noise and echoes.

1-3. Precautions for outdoor unit/heat source unit

1-3-1. Installation environment

- ♦The outdoor unit with the salt-resistant specification is recommended for use in an area in which it will be exposed to salt air.
- ♦Even when the unit with the salt-resistant specification is used, it is not completely protected against corrosion. Be sure to follow the directions or precautions described in the Instruction Book and Installation Manual for installation and maintenance. The salt-resistant specification is referred to in the guidelines published by JRAIA (JRA9002).
- ♦Install the unit in an area where the flow of discharge air is not obstructed. If the flow of discharge air is obstructed, short-cycling of discharge air may occur.
- ♦Provide proper drainage around the base of the units; condensation may collect and drip from outdoor units. Provide water-proofing protection to the floor when installing the unit on the rooftop.
- ♦In regions where snowfall can be expected, install the unit so that the outlet faces away from the direction of the wind, and install a snow guard to protect the unit from snow. Install the unit on a base approximately 50 cm higher than the expected snowfall. Close the openings for pipes and wiring, because the ingress of water and small animals may cause equipment damage. If a SUS snow guard is used, refer to the Installation Manual that comes with the snow guard and be careful with the installation to avoid the risk of corrosion.
- ♦Install the snow guard so that the outlet/inlet faces away from the direction of the wind.
- ♦When approximately 50 cm or more of snow accumulates on the snow guard, remove the snow from the guard. Install a roof that is strong enough to withstand loads caused by snow in areas where snow accumulates.
- ♦Provide proper protection around the outdoor units in places such as schools to avoid the risk of injury.
- ♦A cooling tower and heat source water circuit should be a closed circuit so that water is not exposed to the atmosphere. When a tank is installed to ensure that the circuit has enough water, minimize the contact with outside air to ensure that the oxygen dissolved in the water is 1 mg/L or less.
- ♦Install a strainer (50 mesh or more recommended) on the water pipe inlet on the heat source unit.
- ♦Interlock the heat source unit and water circuit pump.
- ♦Note the following to prevent the freezing and bursting of pipes when the heat source unit is installed in an area where the ambient temperature can be 0°C or below.
 - ♦Keep the water circulating to prevent it from freezing when the ambient temperature is 0°C or below.
 - ♦Before a long period of non-use, be sure to purge the water from the unit.
- ♦The salt-resistant unit is resistant to salt corrosion, but not salt-proof. Please note the following when installing and maintaining outdoor units in a marine environment.
 1. Install the salt-resistant unit in an area in which it is not directly exposed to sea breezes, and minimize exposure to salt water mist.
 2. Avoid installing a sun shade over the outdoor unit, so that rain will wash away salt deposits off the unit.
 3. Install the unit horizontally to ensure proper water drainage from the base of the unit. Accumulation of water in the base of the outdoor unit will significantly accelerate corrosion.
 4. Periodically wash salt deposits off the unit, especially when the unit is installed in a coastal area.
 5. Repair all noticeable scratches after installation and during maintenance.
 6. Periodically check the unit, and apply an anti-rust agent and replace corroded parts as necessary.
- ♦Do not install the units in a place where iron or copper powders fly around, in an acidic or alkaline atmosphere, or where a large amount of sand containing saline particles accumulates because these factors can corrode the aluminum pipes.

1-3-2. Circulating water

- ♦Regularly check the quality of the water in the heat source unit, following the guidelines published by JRAIA (JRA-GL02-1994).
- ♦A cooling tower and heat source water circuit should be a closed circuit so that water is not exposed to the atmosphere. When a tank is installed to ensure that the circuit has enough water, minimize the contact with outside air to ensure that the oxygen dissolved in the water is 1 mg/L or less.

1-3-3. Unit characteristics

- ♦When the Thermo ON and OFF is frequently repeated on the indoor unit, the operating status of outdoor/heat source units may become unstable.

1-3-4. Related equipment

- ♦Provide grounding in accordance with the local regulations.

1-3-5. Noise level (Sound pressure level)

- ♦The sound pressure level is a value measured in an anechoic room in accordance with the conventional method in JIS standard. The sound pressure level actually measured at the installation site is usually higher than the value indicated in DATA BOOK due to the influence of ambient noise and echoes. Valve operation noise and refrigerant flow noise may occur from inside the outdoor unit/heat-source unit.

1-4. Precautions for control-related items

1-4-1. Product specification

- ◆ To introduce the MELANS system, a consultation with us is required in advance. Especially to introduce the electricity charge-apportioning function or energy save function, further detailed consultation is required. Consult your local distributor for details.
- ◆ Billing calculation for AE-C400E(-X)/EW-C50E(-X), or the billing calculation unit is unique and based on our original method. (Backup operation is included.) It is not based on the metering method, and do not use it for official business purposes. It is not the method that the amount of electric power consumption (input) by air conditioner is calculated. Note that the electric power consumption by air conditioner is apportioned by using the ratio corresponding to the operation status (output) for each air conditioner (indoor unit) in this method.
- ◆ In the apportioned billing function for AE-C400E(-X)/EW-C50E(-X), separate watt-hour meters should be used for A-control units, K-control units, and CITY MULTI packaged air conditioners. It is recommended that an individual watt-hour meter should be used for large-capacity indoor units (with two or more addresses).
- ◆ When using the peak cut function on the AE-C400E(-X)/EW-C50E(-X), note that the control is performed once every minute and it takes time to obtain the effect of the control. Take appropriate measures such as lowering the criterion value. Power consumption may exceed the limits if the AE-C400E(-X)/EW-C50E(-X) malfunctions or stops. Provide a back-up remedy as necessary.
- ◆ The controllers cannot operate while the indoor unit is OFF. (No error)
Turn ON the power to the indoor unit when operating the controllers.
- ◆ When using the interlocked control function on the AE-C400E(-X)/EW-C50E(-X)/PAC-YG66DCA or PAC-YG63MCA, do not use the control for fire prevention or security. (This function should never be used in a way that would put people's lives at risk.) Employ any methods or circuits that allow ON/OFF operation using an external switch in case of failure.

1-4-2. Installation environment

- ◆ Surge protection may be required for the transmission line in areas where lightning strikes occur frequently.
- ◆ The receiver for a wireless remote controller may not work properly due to the effect of general lighting. Leave a space of at least 1 m between the general lighting and the receiver.
- ◆ When the auto-elevating panel is used and the system is operated using a wired remote controller, install the wired remote controller in a place where all the air conditioners being controlled (at least the bottom part of them) can be seen from the wired remote controller. If not, the descending panel may cause damage or injury; be sure to use a wireless remote controller designed for use with the elevating panel (sold separately).
- ◆ Install the wired remote controller (switch box) in a place where the following conditions are met.
 - ◆ Where the installation surface is flat
 - ◆ Where the remote controller can detect an accurate room temperature
The temperature sensors that detect the room temperature are installed both in the remote controller and in the indoor unit.
When the room temperature is detected using the sensor in the remote controller, the main remote controller is used to detect the room temperature. In this case, follow the instructions below.
 - ◆ Install the controller in a place where it is not affected by a heat source.
(If the remote controller faces direct sunlight or the direction of the supply air flow, the remote controller cannot detect the accurate room temperature.)
 - ◆ Install the controller in a place where the average room temperature can be detected.
 - ◆ Install the controller in a place where no other wires are present around the temperature sensor.
(If other wires are present, the remote controller cannot detect an accurate room temperature.)
- ◆ To prevent unauthorized access, always use a security device such as a VPN router when connecting the AE-C400E(-X)/EW-C50E(-X) to the Internet.

⚠ Warning

- Do not use refrigerant other than the type indicated in the manuals provided with the unit and on the nameplate.
 - Doing so may cause the unit or pipes to burst, or result in explosion or fire during use, repair, or at the time of disposal of the unit.
 - It may also be in violation of applicable laws.
 - MITSUBISHI ELECTRIC CORPORATION cannot be held responsible for malfunctions or accidents resulting from the use of the wrong type of refrigerant.
- Our air conditioning equipment and heat pumps contain a fluorinated greenhouse gas, R32.

MITSUBISHI ELECTRIC CORPORATION

www.MitsubishiElectric.com