



thermoscreens®

VRF HP HEAT PUMP RANGE AIR CURTAINS

INSTALLATION, OPERATION & MAINTENANCE INSTRUCTIONS



For use with City Multi (VRF) systems

PLEASE READ THESE INSTRUCTIONS CAREFULLY BEFORE ATTEMPTING INSTALLATION

Thermoscreens Ltd
St. Mary's Road Nuneaton
Warwickshire England
CV11 5AU

Email: sales@thermoscreens.com

Tel: +44 (0) 24 7638 4646

Fax: +44 (0) 24 7638 8578

www.thermoscreens.com



English

Thermoscreens / Mitsubishi Electric

City Multi (VRF) HP Heat Pump Air Curtain System

CONTENTS

	Page
Air Curtain System Schematics	3
Design Information	5
Unpacking the Air Curtain	8
INSTALLATION	
Installation of the Air Curtain	10
Figure 1 – Dimensions of VRF HP Air Curtain	11
Mitsubishi Electric Compressor Unit	12
Refrigerant Pipework	12
To gain access inside the Air Curtain	13
Electrical Supply and Wiring to the Air Curtain	14
Wiring Diagram 1 (Defrost Cycle Auxiliary Heater disabled - as supplied)	16
Wiring Diagram 2 (Defrost Cycle Auxiliary Heater enabled on site)	17
PAR-30MAA Remote Controller	18
Wiring of Air Curtain Fan Speed	18
Condensate Disposal System	18
COMMISSIONING	
Air Curtain Checks	20
Selecting the Fan Speeds of the Air Curtain	22
Starting the Heat Pump System	24
Filter Dirty Indicator	25
Hand-over to End-User	27
USER INSTRUCTIONS	
User Instructions for the Air Curtain	28
SERVICING	
Fortnightly Cleaning	29
Six Monthly Servicing	29
Fault Finding	32

Thermoscreens / Mitsubishi Electric

Thermoscreens HP City Multi (VRF) Heat Pump Air Curtains can be used with Mitsubishi Electric City Multi Y/WY-Series (Heat Pump) or City Multi R2/WR2-Series (Heat Recovery) systems.

City Multi Y/WY-Series Heat Pump Air Curtain System

City Multi Y/WY-Series Heat Pump Air Curtain Schematic :-

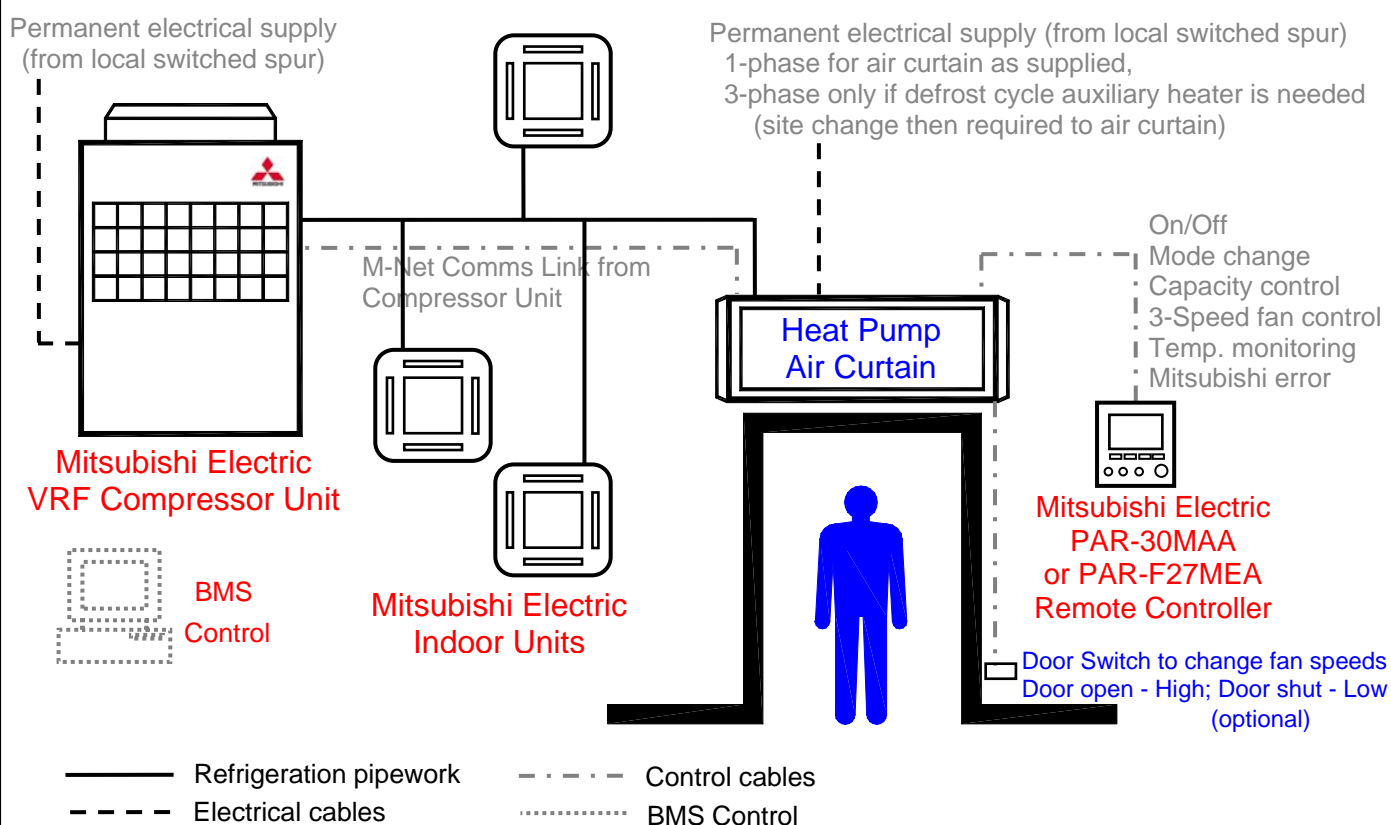

City Multi Y-Series System:-

Indoor Units and Air Curtains(s) all operate on heating at the same time, or all operate on cooling at the same time.

The City Multi Y Series Heat Pump Air Curtain system consists of :-

- one or more Thermoscreens VRF HP Heat Pump (heating and cooling) Air Curtains *
- one or more Mitsubishi Electric City Multi Y/WY-Series Compressor Units +
- a Mitsubishi Electric PAR-30MAA or PAR-F27MEA Remote Controller +
- a door switch to change fan speeds; higher speed when the door is open, lower speed when the door is closed (optional)^
- Mitsubishi Electric Indoor Unit(s) + [NB. Can be used on a full air curtain basis if required up to 100% diversity]

* - supplied by Thermoscreens Ltd.

+ - Mitsubishi Electric items supplied by the installer

^ - supplied by the installer

City Multi R2/WR2-Series Heat Pump Air Curtain System

City Multi R2/WR2-Series Heat Recovery Heat Pump Air Curtain Schematic :-

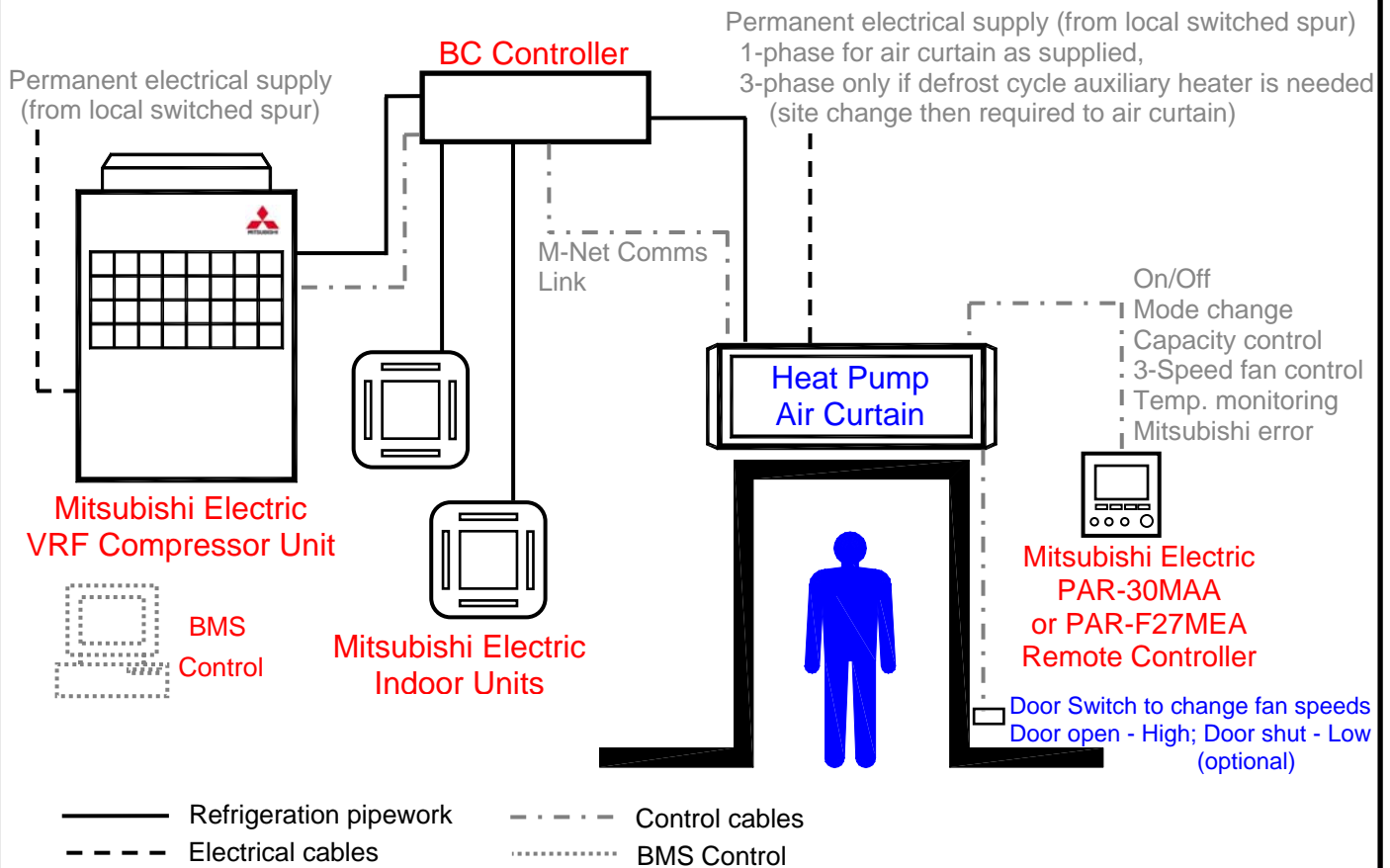

City Multi R2/WR2-Series System:-

Indoor Units and Air Curtains(s) can operate on heating or cooling simultaneously, e.g. some indoor units are cooling whilst other indoor units and air curtain are heating at the same time.

The City Multi R2/WR2-Series heat recovery system with Heat Pump Air Curtain(s) consists of :-

- one or more Thermoscreens VRF HP Heat Pump (heating and cooling) Air Curtains *
- one or more Mitsubishi Electric City Multi R2/WR2-Series Compressor Units +
- Mitsubishi Electric BC Controller +
- a Mitsubishi Electric PAR-30MAA or PAR-F27MEA Remote Controller +
- a door switch to change fan speeds; higher speed when the door is open, lower speed when the door is closed (optional)^
- Mitsubishi Electric Indoor Unit(s) + [NB. Can be used on a full air curtain basis if required up to 100% diversity]

* - supplied by Thermoscreens Ltd.

+ - Mitsubishi Electric items supplied by the installer

^ - supplied by the installer

DESIGN INFORMATION

AS SUPPLIED the air curtain operates on a 1 phase electrical supply (1L+N+E) from a local switched spur which provides power for fans and controls. There is an integral defrost cycle auxiliary heater located inside the air curtain but this is 'disabled' as supplied. If the defrost cycle auxiliary heater is required the air curtain will then need a 3 phase electrical supply (3L+N+E) from a local switched spur, instead of the 1 phase electrical supply, to provide power for the heater as well which will need to be 'enabled' on site during commissioning, see also notes on Page 6 and Section 'Installation - Electrical Supply and Wiring to the Air Curtain', Page 14.

Electrical power to the Mitsubishi Electric Compressor Unit(s) and BC Controller is fed separately in the normal way (see separate Mitsubishi Electric Instructions).

There is a Mitsubishi Electric M-Net communications link between the Mitsubishi Electric Compressor Unit or BC Controller and the Thermoscreens Heat Pump Air Curtain. When used with a Mitsubishi PAR-30MAA or PAR-27MEA Remote Controller this link provides:-

- On/Off control of the Mitsubishi Electric heat pump system
- Mode change between heating, fan only and cooling of the Mitsubishi Electric heat pump system
- Capacity control of the Mitsubishi Electric heat pump system
- 3-speed control of the Thermoscreens air curtain fans*
- Temperature monitoring of the inlet air entering the air curtain, or the room air temperature at the remote controller
- Signal for when the outdoor unit is in defrost mode so a defrost cycle auxiliary heater (if enabled) can provide partial heat back-up during the few minutes of defrost.
- Error signal for if the Mitsubishi Electric system has a problem

**As an alternative a door switch can be used to switch between a higher fan speed with the door open or a lower fan speed with the door closed.*

The air curtain can be set to operate in HEAT, FAN or COOL mode within the Mitsubishi Electric City Multi (VRF) system using a Mitsubishi PAR-30MAA or PAR-27MEA Remote Controller or a Mitsubishi Electric BMS or Centralised Controller.

Refer to a Mitsubishi Electric agent if the air curtain is to be controlled via a Building Management System (BMS) or Centralised Controller.

It should be noted that during heating mode, if the compressor unit goes into its defrost cycle during cold weather, the air curtain fans will continue to operate to maintain the all-important air stream across the doorway. It is this air stream, particularly towards the top of the doorway, which is so effective at stopping buoyant warm air from inside the building escaping to outside and wasting energy and also in reducing airborne contamination.

For Y-Series systems the temperature of the discharge air can be low during the defrost cycle period that may occur every few hours under particular outdoor weather conditions but this has rarely become an issue with the end user and is really only a perceived problem. There is a defrost cycle auxiliary heater fitted in the air curtain which is disabled when the air curtain is delivered. If there are concerns for a particular Y-Series installation this defrost cycle auxiliary heater can be enabled during site commissioning and this will maintain the discharge air at a higher temperature during the defrost cycle. A 3-phase electrical supply is then required to power the air curtain.

NB. The defrost cycle auxiliary heater should not be site enabled during commissioning on R2, WY and WR2 systems. On R2 systems the LEV in the air curtain closes during system defrost and defrost does not occur on WY and WR2 systems.

Point of Information: If used, an auxiliary defrost heater may seem counter-productive for a heat pump system. When put into context, however, the auxiliary heater fitted is of low output for the size of the air curtain, it will just temper the discharge air and is only used for a few minutes a day during a small period of the year. Tests at the Building Research Establishment (BRE) test house on the heat pump air curtain system showed that even with the auxiliary heater cutting in during defrost, as it has to during their EN14511 performance test, the annual seasonal COP was hardly affected.

The air curtain is supplied with an integral condensate drain tray fitted inside the unit so it could be used in cooling mode during warm weather, if so desired. This should be decided at the design stage as a condensate drain system will need to be installed if cooling is required and extended to a suitable drain by the installer. The condensate can be drained by gravity by connecting suitable condensate hose onto the 15mm drain pipe on the condensate drain tray inside the air curtain. If a gravity condensate drain is not visually suitable it will be necessary to remove condensate using a condensate pump, supplied and fitted by the installer. The condensate pump can be located inside the right hand end of the air curtain or in a remote location outside of the unit if required. It must be of sufficient capacity, see Page 19, self priming and capable of providing the appropriate suction head so the pump will lift condensate out of the air curtain, particularly if it is in a remote location. There are two hole penetrations at the right hand end of the air curtain for condensate pipework to pass through, see Figure 1, Page 11. Suitable condensate pumps are Peristaltic or Rotary Diaphragm type. We recommend the Blue Diamond rotary diaphragm type with cooling signal sensor (drainStik) manufactured by Charles Austen Pumps Ltd. (www.miniblue.co.uk).

If using a condensate pump it is recommended that it has the facility so it only operates when the air curtain is in cooling mode by detection of water in the drain tray or by detecting a cooling differential in the airflow. It should also have a pump overrun feature to empty the drain tray as much as possible when the air curtain is switched off. It should have an alarm system with appropriate sensor fitted in the drain tray that will give a volt-free signal (open circuit = alarm) and stop the air curtain cooling if the condensate drain tray is in danger of flooding (air curtain fans will continue to operate). Other indoor units on the same City Multi system are unaffected if the air curtain condensate alarm occurs. There is a fixing bracket with 8mm diameter hole attached to the drain tray inside the air curtain so a condensate sensor can be fixed in the tray by the installer. The hole can be enlarged, if necessary, to suit the type of sensor used so it is located in the tray at the appropriate position, see the manufacturer's instructions that come with the condensate pump for further information. A 230V AC, single phase electrical supply is provided inside the air curtain to power a condensate pump and a condensate alarm connection is provided for the condensate pump alarm circuit.

Warning: The air curtain condensate collection system is designed to remove condensate with the air curtain operating in cooling mode during normal summer weather conditions in countries with a temperate climate. In case of extreme weather conditions, drain tray blockage or condensate pump failure, which can occur, it is vital that the design of the floor beneath the air curtain and its surface is such that it will not become slippery or damaged if it became wet. This is similar to the conditions that might be experienced with heavy

rainfall in at an open doorway or wet pedestrian foot traffic, so careful consideration must be paid to the design of the floor and its surface finish.

If it is intended that the air curtain should not operate in cooling mode and a condensate drain system is not fitted, the BMS System, Centralised Controller or PAR-30 MAA / PAR-27 MEA Remote Controller must be configured at commissioning so that COOL or AUTO mode can never be selected (see Section – Commissioning, Page 20). It is still recommended, however, that the floor design and surface be as described above, in case cooling mode is used in the future and also to cope with heavy rainfall or wet pedestrian foot traffic.

Note: It could still be possible for an end user to unlock a PAR-30 MAA / PAR-27 MEA remote controller if they found out how to and switch it into cooling, not realising that condensate would then flood out of the drain tray. It may be considered prudent, therefore, to install a condensate drain system even if it is intended that the unit should only be used in HEAT or FAN mode.

The air curtain is designed only for use with a Mitsubishi Electric City Multi (VRF) system for use on R410A. The complete Thermoscreens air curtain / Mitsubishi Electric heat pump system, including fridge pipework, wiring, controls, etc. must be installed only by an approved Mitsubishi Electric refrigeration contractor.

Persons using the air curtain must be given adequate instruction and supervision concerning the use of the appliance by a person responsible for their safety. The air curtain is not intended for use by persons (including children) with reduced physical, sensory or mental capabilities.

These instructions must be read in conjunction with the separate Mitsubishi Electric instructions that come with other components of the heat pump system, e.g. Compressor Unit, BC Controller, PAR-30 MAA / PAR-27 MEA Remote Controller, BMS System, Centralised Controller, etc. All instructions should be kept by the building facilities manager for future reference.

UNPACKING THE AIR CURTAIN

The following items are supplied and packaged within the air curtain box :-

VRF HP Heat Pump Air Curtain



Please note, plastic end caps are supplied loose to be fitted during installation

Wall Brackets and Fixing Bolts



for if air curtain is to be wall mounted

If anything is missing or damaged please contact your place of purchase immediately.

There will also be a 'City Multi (VRF) heat pump system' supplied by Mitsubishi Electric.

The Installer will also need to supply and install the following:-

PAR-30 MAA or PAR-F27 MEA Remote Controller



If Air Curtain is to be manually controlled, also needed for commissioning

NB. The PAR-F27 MEA Remote Controller does not have a timer/clock

The installer may also need to supply and install the following optional items:-

Door Switch – for energy efficient, noise friendly, fan speed control,
Door open – Higher fan speed
Door shut – Lower fan speed

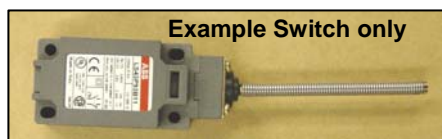

Gives industry standard fan speed control – see wiring diagrams on Pages 16 & 17 and text on Pages 18 & 22 for more information

Condensate Pump – self priming with cooling mode detection, alarm system and pump overrun



If Air Curtain is to be operated in COOL or AUTO mode and gravity drain cannot be used – see text on Page 6 & 7 for more information

The complete Thermoscreens air curtain / Mitsubishi Electric heat pump system, to provide a heat pump air curtain over a doorway, including wiring, fridge pipework, etc. is to be installed only by an approved Mitsubishi Electric refrigeration contractor.

IMPORTANT

This Heat Pump Air Curtain is intended only for use with a Mitsubishi Electric City Multi (VRF) system, for use on R410A.

These instructions must be read in conjunction with the separate Mitsubishi Electric City Multi (VRF) instructions.

(All documentation supplied with the unit should be stored and kept for future reference.)

For your records:

Date of Purchase.....

Place of Purchase.....

Serial Number.....

For warranty purposes proof of purchase is necessary so please keep a copy of your invoice.

INSTALLATION OF THE AIR CURTAIN

The air curtain is designed to be surface mounted inside a building and located horizontally over a doorway. It must not be installed on the outside of the building, or built into a cabinet or recessed in anyway.

■ Location

The air curtain must be mounted so the discharge grille is located up to 3.3m maximum above floor level and as close to the doorway as possible. It must be installed level or condensate may leak out if used for cooling. It is recommended to leave a gap of 250mm minimum above the air curtain to allow for pipework brazing operations. Beware of doorway top edges, structural beams, door opening/closure devices, etc. which may interfere with the air stream and affect the location of the unit.

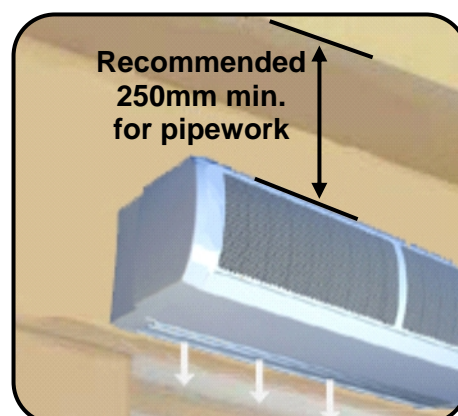

■ Wall Fixing

Bolt all of the wall brackets supplied to the rear face of the unit as shown in the adjacent picture using the M10 bolts supplied. Suitable wall fixing bolts (not supplied) need to be used to fix the brackets to the wall, taking into account the type of wall and the weight of the unit*, see table:

Air Curtain	Weight (kg)
VRF HP1000 DXE	46
VRF HP1500 DXE	67
VRF HP2000 DXE	84



Step 1. Refer to Figure 1, Page 11 for mounting details and drill the fixing points in the wall.

Step 2. Screw in the top wall bolts leaving a small gap between the head and the wall. Lower the unit onto the bolts via the key-hole slots in the top of the wall brackets and then screw in the bottom wall bolts.

Step 3. Ensure all fixing bolts are tightened and the air curtain is safely secured to the wall.

■ Ceiling Suspension

M10 threaded inserts are provided in the top face of the unit (see Figure 1, Page 11 for positions) so it can be suspended on M10 threaded hanging rods (not provided). All suspension points must be used. Ensure each of the hanging rods is secured onto a suitable structure that can support the weight of the unit (see table above)*. Screw the hanging rods into the inserts by a minimum of 20mm and fit locking nuts (not provided) to prevent the rod rotating and coming away from the casing. Do not screw the hanging rod too far in or it could interfere with internal components.

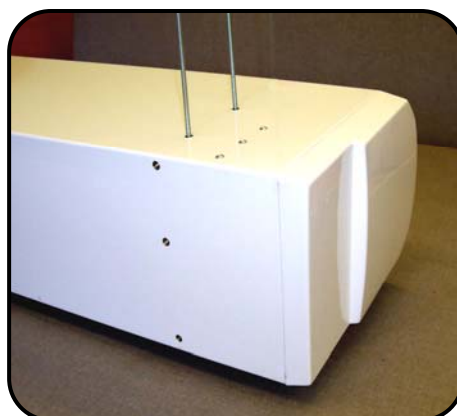

* It is the sole responsibility of the installer to ensure that the building fixing locations and suspension system used are suitable for the air curtain being installed.

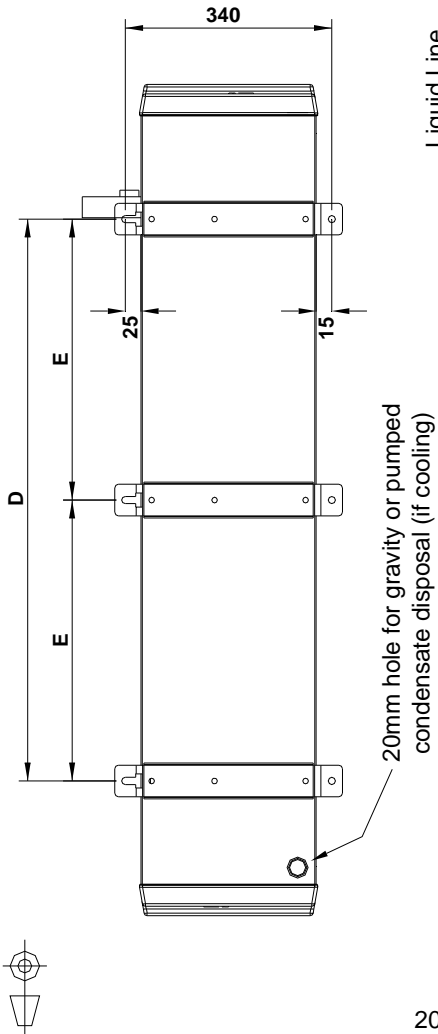
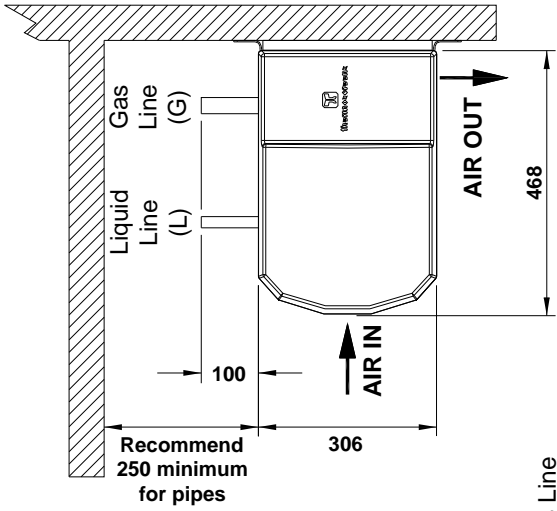

	VRF HP1000DXE	VRF HP1500DXE	VRF HP2000DXE
A (mm)	1300	1825	2350
B (mm)	605	1225	1793
C (mm)	-	655	918
D (mm)	898	1398	1904
E (mm)	-	699	952
F (mm)	182	222	204
G	5/8 in.	5/8 in.	7/8 in.
H (mm)	442	333	299
I (mm)	253	267	258
J (mm)	359	359	334
K (mm)	80	45	80
L	1/2 in.	1/2 in.	5/8 in.
M	-	570	875

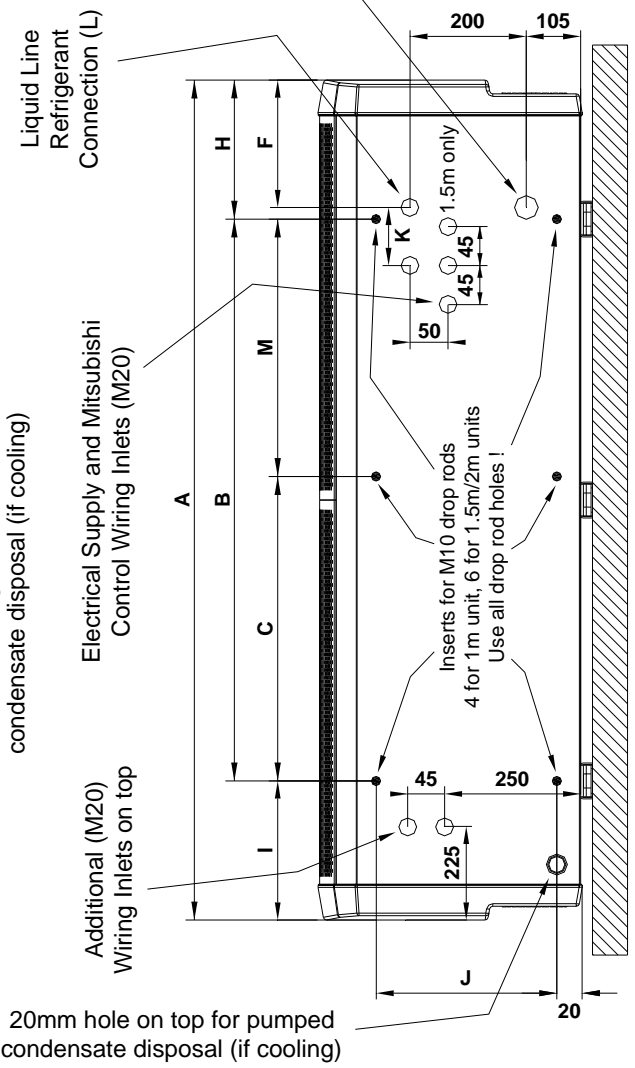

FIGURE 1 – DIMENSIONS OF VRF HP HEAT PUMP AIR CURTAIN

■ Mitsubishi Electric Compressor Unit

See table below for the VRF System Index Size to be used together with performance data for the air curtain.

Air Curtain	VRF system Index Size	Air Curtain Parameters				
		Maximum Heating Output (kW)	Maximum Cooling Output (kW)	Max. Air Volume Flow Rate (m ³ /h)	Maximum Noise Level dB(A) @3m	Effective Width of Airstream (m)
VRF HP1000 DXE	P71	8.3	7.4	1310	58	1.10
VRF HP1500 DXE	P125	13.2	11.8	2070	58	1.63
VRF HP2000 DXE	P140	15.7	14.0	2590	58	2.15

Outputs based on:- Indoor air temperature = 20°C. Outdoor condition = 7/6 db/wb °C for heating output, 35/27 db/wb °C for cooling output.
Performance figures derived from independent testing by UK test houses BRE and BSRIA in accordance with test standard EN14511. Noise testing carried out at Sound Research Laboratories to ISO3741 and BS4856-4. See Table on Page 23 for more details of air volume flow rates and noise levels.

■ Refrigerant Pipework

This must be carried out before connection of any electrical and controls cables and in accordance with the Instructions that come with the Mitsubishi Electric City Multi system. This work must only be undertaken by a Mitsubishi Electric approved Contractor.

Contact Mitsubishi Electric for recommended pipework sizes, pipework lengths, numbers of fittings, etc.

The installation must be carried out in accordance with the Mitsubishi Electric Installation Manual that comes with the compressor unit and with reference to the Index Size of the air curtain (indoor unit).

It is intended that refrigerant pipe connections to the air curtain are made using brazed joints and these must be carried out in a professional and safe manner. If installation pipe sizes for the discharge (gas) line and liquid line are different from the pipe connection sizes on the air curtain (see Figure 1, Page 11), suitable pipe reducers must be used for the connection. R410A refrigerant systems can operate at pressures up to 610 psi (c. 42 Bar). These brazed joints may well be located in a public area and a weakness leading to an explosion could be extremely dangerous.

The air curtain with its coil is manufactured in accordance with the Pressure Equipment Directive (PED) and the installation must be carried out to a good standard of workmanship. Remove the protective plastic film on top of the air curtain before starting work and protect the top surface of the air curtain. Use a heat sink on the copper pipes during brazing to reduce the transfer of heat to the inside of the air curtain where sensitive components are located. Make sure the thermistor (gas) sensor has not been inserted into its pocket on the gas line pipe at the top of the air curtain before brazing. Remove it if it has or it will burn and damage when the pipe connection is brazed.

For the City Multi (VRF) R2 and WR2 Series system, pipework from each air curtain must connect to one pair of ports on the Mitsubishi Electric BC Controller. Do not combine pipework from two or more air curtains together into one set of pipework and then connect this to one pair of ports. With the VRF HP2000 DXE air curtain, however, although a maximum P140 Index is possible from 1 pair of ports it is recommended that 2 pairs of ports on the BC Controller are used to achieve the correct output, contact Mitsubishi Electric for advice.

Fit the thermistor (gas) sensor bulb into the Hot-Gas pocket on the refrigerant gas pipe at the top of the air curtain after brazing all pipe connections. Insulate over the pocket when insulating the refrigerant pipework.



■ To gain access inside the Air Curtain

To gain access for connection of the electrical supply, controls wiring and to work on the unit during commissioning, remove the air inlet grilles and the bottom access panel.

First remove the plastic end caps at each end of the unit, if already fitted, by pulling off to the side (see picture).



Then remove each inlet grille in turn with its filter by unfastening the quarter-turn Philips Head fastener at the bottom corner of the grille. Use a Philips No.1 screwdriver to access the screw via the elongated hole at the bottom corner of each grille and turn anti-clockwise to remove (see picture).

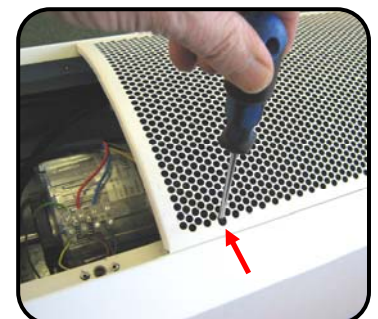

To remove the bottom access panel unfasten the access panel securing screws, one at each end, plus two in the centre (VRF HP1500 DXE and VRF HP2000 DXE units) and slide the panel out forwards (see picture).

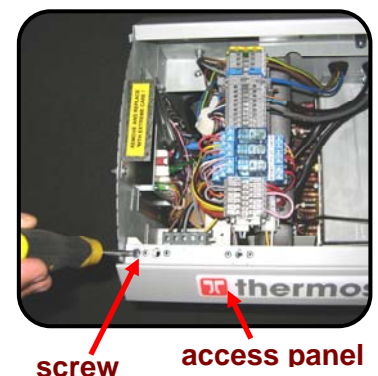

Please note: All the panels of the air curtain are covered in a protective plastic film which should now be removed.

■ Electrical Supply and Wiring to the Air Curtain

This must be carried out AFTER the connection of the refrigerant pipework. All electrical wiring and connections MUST be carried out by a competent qualified electrician in accordance with the latest edition of the IEE wiring regulations and/or local statutory regulations. (see also Wiring Diagrams 1 & 2 on Page 16/17)

- A local isolator having a contact separation of at least 3mm on all poles must be fitted in the 1 phase electrical supply (1L + N + E) to the air curtain and located in an accessible position adjacent to the unit.
- If the defrost cycle auxiliary heater is to be used the air curtain then requires a 3 phase electrical supply (3L + N + E) to the air curtain instead of a 1 phase electrical supply. A local isolator having a contact separation of at least 3mm on all poles must be fitted in the 3 phase electrical supply and located in an accessible position adjacent to the unit. The defrost cycle auxiliary heater will need to be enabled during commissioning (see Section 'Design Information' – Page 5 and Section 'Commissioning' Page 20).
- The appliance must be connected using cables having an appropriate temperature rating (heat resistant).
- Ensure that the supply cables, circuit breakers and other electrical installation equipment are correctly sized for the air curtain being installed. See Table below.
- A 25mm size cable gland or conduit connector should be used for the Electrical Supply into the air curtain. See Figure 1, Page 11 showing where the electrical supply enters the unit.
- This appliance must be Earthed.
- Wire in accordance either with **1)** or **2)** in the Table below:

Air Curtain	1) Unit as supplied - defrost cycle auxiliary heater is disabled (230V/1ph/50Hz electrical supply from separate local isolator)		2) the defrost cycle auxiliary heater is to be enabled during commissioning (400V/3ph/50Hz electrical supply from separate local isolator)	
	Rated Electrical Power Input (kW)	Rated Current (A)	Rated Electrical Power Input (kW)	Rated Current per phase (A)
VRF HP1000 DXE	0.2	0.8	4.7	7.3
VRF HP1500 DXE	0.3	1.2	7.8	12.1
VRF HP2000 DXE	0.35	1.4	9.35	14.4

1) Unit as supplied – defrost cycle auxiliary heater is disabled, see Wiring Diagram 1, Page 16 (230V/1ph/50Hz electrical supply from separate local isolator)

Connect to terminals Earth, L1 and N with a 1-phase electrical supply.

Connect a Mitsubishi Electric PAR-30MAA Remote Controller to terminals 1 and 2 on the air curtain, or a PAR-F27MEA to terminals M1 and M2.

Connect the M-Net 2-core cable to terminals M1 and M2 on the air curtain – this is the communication link between the City Multi system and the air curtain.

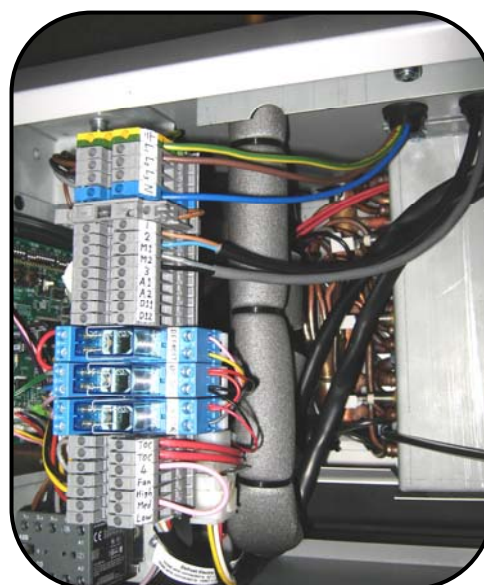

2) If the defrost cycle auxiliary heater is to be enabled during site commissioning, see Wiring Diagram 2, Page 17 (400V/3ph/50Hz electrical supply from separate local isolator)

Connect to terminals Earth, L1, L2, L3 and N with a 3-phase electrical supply.

Connect a Mitsubishi Electric PAR-30MAA Remote Controller to terminals 1 and 2 on the air curtain, or a PAR-F27MEA to terminals M1 and M2.

Connect the M-Net 2-core cable to terminals M1 and M2 on the air curtain – this is the communication link between the City Multi system and the air curtain.

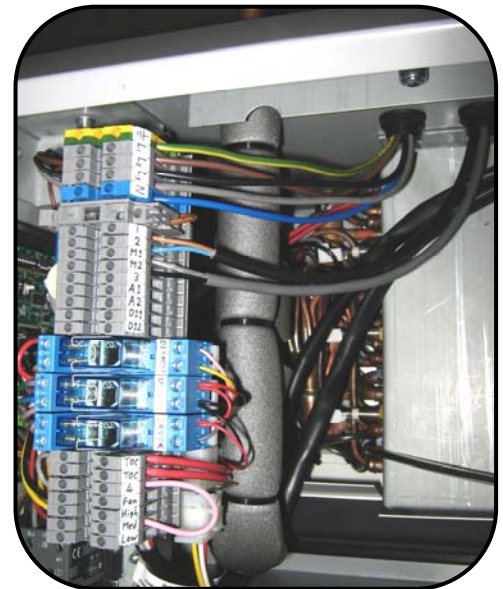

If required the defrost cycle auxiliary heater can be enabled by disconnecting the neutral wire (violet) from the auxiliary terminal 14NO on the contactor inside the air curtain. This wire is then connected onto terminal A2 on the contactor as shown in the adjacent picture (see also Wiring Diagram 2 on Page 17).

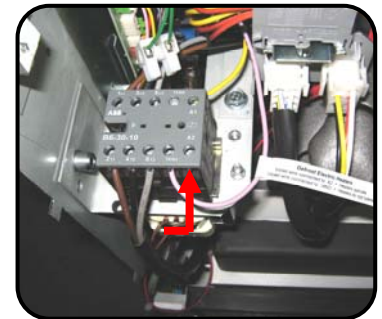

Recommended wire sizes for electrical connections are as follows:

Electrical Connection	Wire Size
1-phase electrical supply from separate local isolator	2.5mm ² max. for access
3-phase electrical supply from separate local isolator - if the defrost cycle auxiliary heater is to be enabled	2.5mm ² max. for access
Mitsubishi Electric PAR-30MAA or PAR-27MEA Remote Controller (2-core cable)	0.75mm ²
Mitsubishi Electric M-Net (2-core cable)	0.75mm ²
Door switch to change fan speeds as door opens and shuts	0.75mm ²

THERMOSCREENS HEAT PUMP AIR CURTAIN

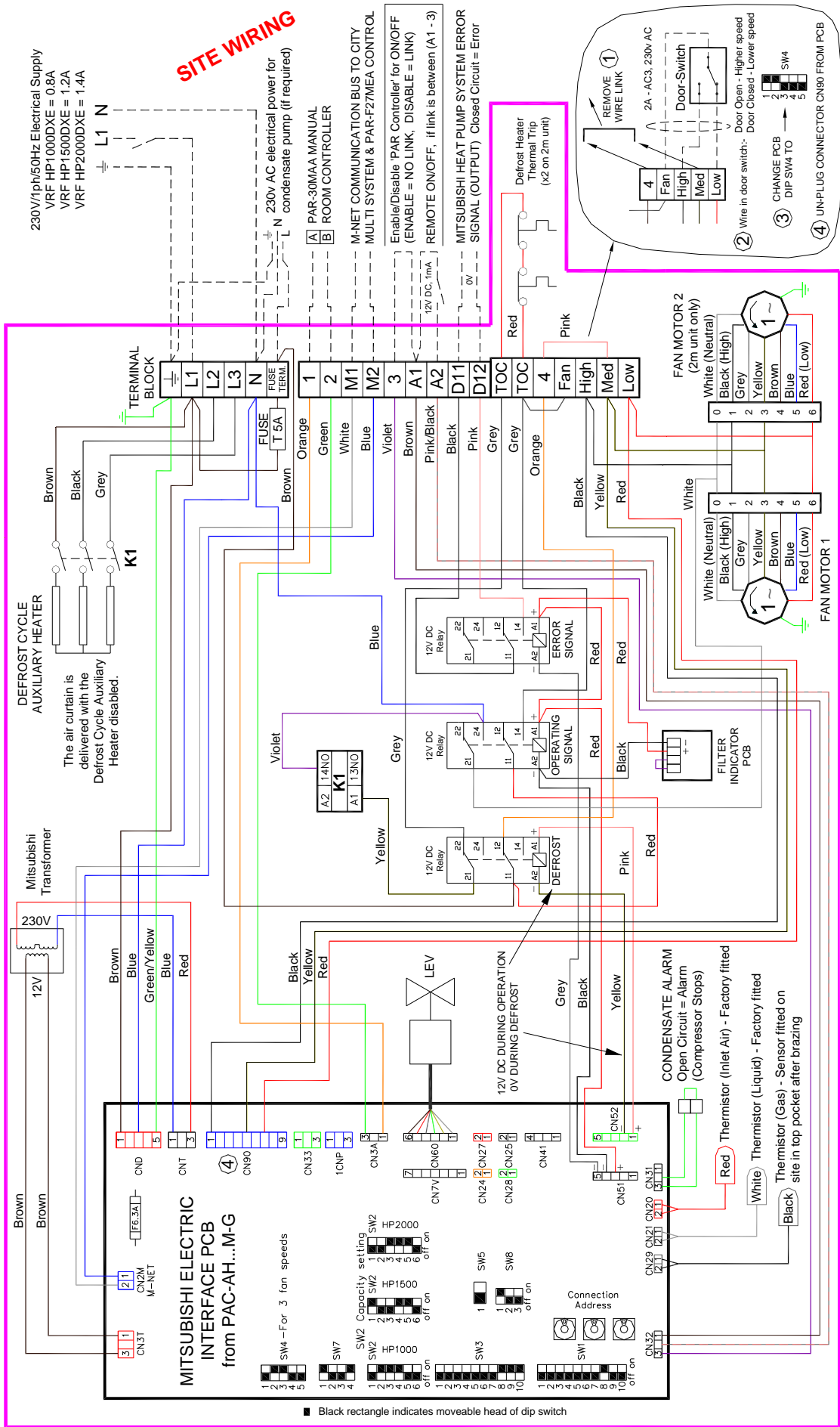

SITE WIRING

WIRING DIAGRAM 1 – VRF HP HEAT PUMP AIR CURTAIN (No Defrost Cycle Heater – unit as supplied)

THERMOSCREENS HEAT PUMP AIR CURTAIN

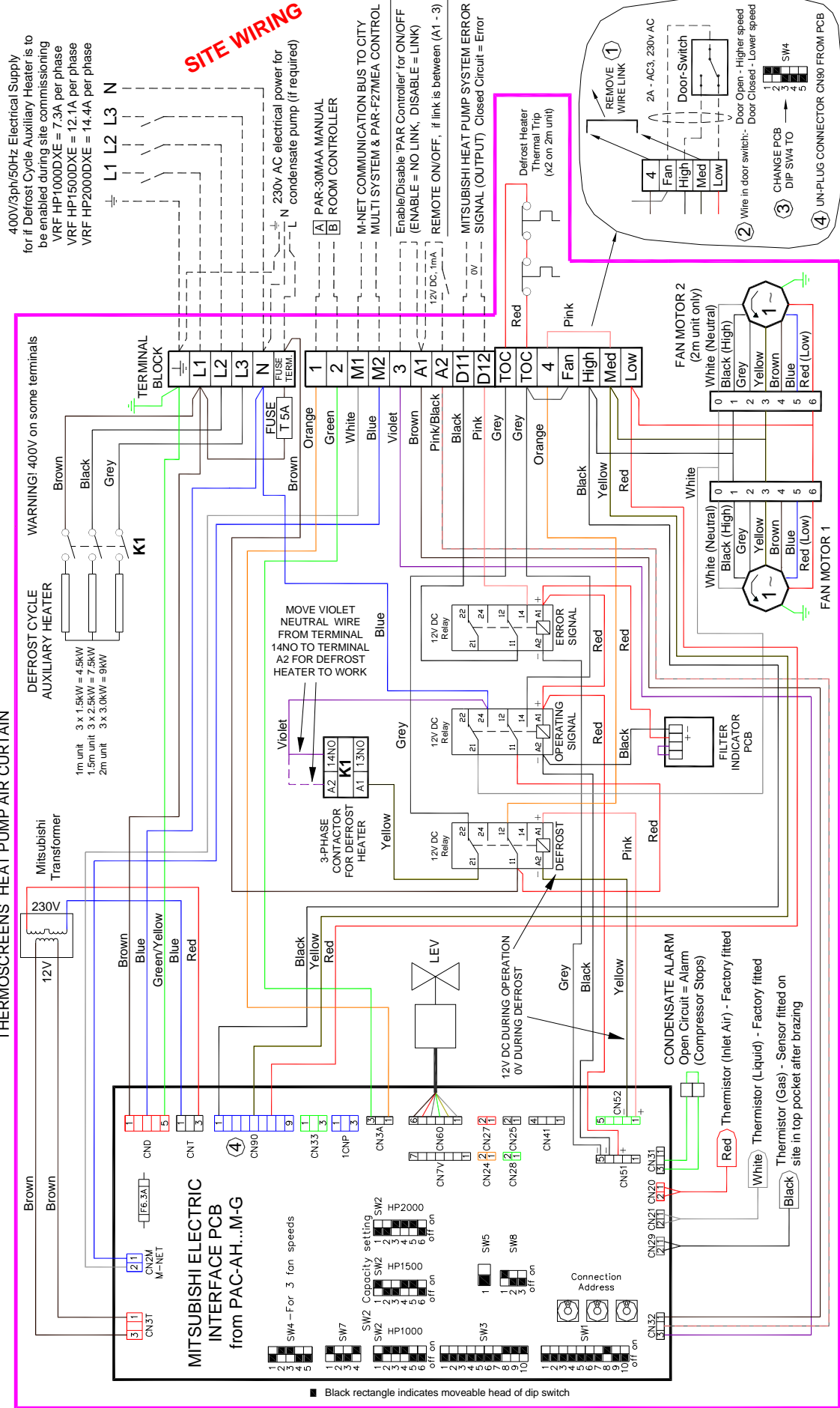

SITE WIRING

WIRING DIAGRAM 2 – VRF HP HEAT PUMP AIR CURTAIN (Defrost Cycle Auxiliary Heater enabled on site)

■ PAR-30MAA Remote Controller

If the air curtain is to be manually controlled by the end user a Mitsubishi Electric PAR-30MAA remote controller (not supplied by Thermoscreens) must be supplied and fitted by the installer. This is wired to terminals 1 and 2 on the air curtain using 2-core cable. Refer to the Mitsubishi Electric instructions that come with the PAR-30MAA remote controller for the installation and wiring of the controller.

A PAR-30MAA Remote Controller is also required for commissioning purposes and if using AUTO mode with a BMS System or Centralised Controller. Master/Slave control with a PAR-30MAA should be done as follows:-

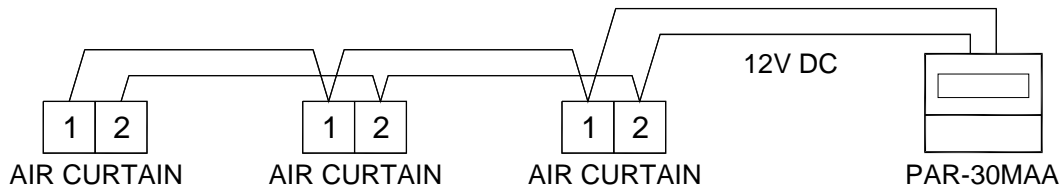

NB. Y-Series systems need two controllers for AUTO control, Master controller at the lower address, refer to Mitsubishi Electric for details.

A PAR-F27MEA can also be used to manually control the air curtain. The PAR-F27MEA is a M-NET device and must be connected to terminals M1 & M2 on the air curtain or anywhere in the M-NET wiring, it does not offer timed switching however.

■ Wiring of Air Curtain Fan Speed

As delivered the air curtain is set-up to provide 3-speed fan control (High, Medium and Low) using a PAR-30MAA or PAR-F27MEA remote controller. A suitable alternative is to have a Door-Switch wired to switch the unit between a Higher fan speed - Door Open and a Lower fan speed - Door Closed. This is both energy efficient and noise friendly. There is a wire link that needs to be removed from the air curtain terminals and dip switch SW4 needs to be changed (the PAR-30MAA or PAR-F27MEA remote controller will not then provide 3-speed fan control). See Wiring Diagram 1 or 2 on Pages 16 or 17 for details and Section, Commissioning; 'Selecting the fan speeds of the air curtain' on page 22 which gives details as to how the available speeds of the six speed fan motor(s) can be set to suit outdoor environmental conditions and indoor noise levels.

■ Condensate Disposal System

If it is intended to use the air curtain in cooling mode a condensate disposal system must be installed.

The air curtain is fitted with a condensate drain tray with 15mm copper outlet pipe at the right hand side of the air curtain. Suitable condensate hose can be fitted to the pipe (see picture) and fed through a 20mm hole at the back of the unit, see Figure 1, Page 11, so condensate will gravity drain away. Means of condensate disposal must then be provided at the rear of the air curtain.



If it is not practical to gravity drain from the air curtain a suitable condensate pump (not supplied with the unit) can be supplied and fitted by the installer to remove condensate directly from the unit. The condensate pump must be of sufficient capacity (see Table below) and if located higher than the drain tray; self priming and capable of providing the appropriate suction head so the pump will lift condensate out from the top of the air curtain. Suitable condensate pumps with a suction head are Peristaltic or Rotary Diaphragm type. It is recommended that the condensate pump has the facility so it only operates when the air curtain is in cooling mode by detection of water in the drain tray or by detecting a cooling differential in the airflow. It should also have a pump overrun to empty the drain tray as much as possible when the air curtain is switched off. We recommend the Blue Diamond rotary diaphragm type with cooling signal sensor (drainStik) manufactured by Charles Austen Pumps Ltd. (www.miniblue.co.uk).

Air Curtain	Maximum likely condensate flow rate (litres/hour)
VRF HP1000 DXE	6.0
VRF HP1500 DXE	9.0
VRF HP2000 DXE	11.0

There is space inside the air curtain at the right hand end of the unit to mount a condensate pump. A permanent 230V AC, single phase electrical supply is provided inside the air curtain at the DIN-Rail terminals to power the pump. See Wiring Diagrams 1 & 2 on Pages 16 and 17. There are two 20mm condensate outlet holes in the casing, one at the top of the unit and a lower one at the rear, both fitted with rubber plugs (see Figure 1, Page 11). These can be used to feed a hose from the condensate pump to a remote condensate drain.

Condensate drain hose should be pushed through either of the two condensate outlet holes after removing the plug and connected to the condensate pump using the adapter supplied with the pump. It may be necessary to extend the hose if the pump is remotely located.

Whether a gravity drain system or a condensate pump is used to remove the condensate there should be an alarm system with appropriate sensor fitted in the drain tray that will give a volt-free signal (open circuit = alarm). A 2-wire condensate alarm signal should be wired back to the condensate alarm connection provided at the Interface PCB inside the air curtain. This will stop the air curtain cooling if the condensate drain tray is in danger of flooding, bringing up an error code on the Mitsubishi Electric system (air curtain fans will continue to operate). Other indoor units on the same City Multi system are unaffected if the air curtain condensate alarm occurs.

There is a fixing bracket with 8mm diameter hole attached to the drain tray inside the air curtain so a condensate alarm sensor can be fixed in the tray by the installer. Hinge the drain tray down to gain better access to the fixing bracket (see picture and Section, Servicing – Page 29). Enlarge the hole if necessary to suit the type of sensor being used so it is located in the tray at the appropriate position. If a condensate pump is being used see the manufacturers instructions that come with the pump for further information.

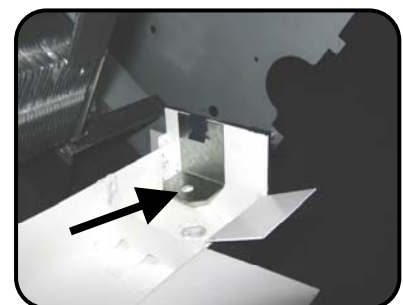

COMMISSIONING THE AIR CURTAIN

Ensure that the local electrical supply to the Air Curtain and if necessary the electrical supply to the Mitsubishi Electric City Multi system are switched off.

■ Air Curtain Checks

Check that the components inside the air curtain are as shown in the picture below. If the defrost cycle auxiliary heater has been enabled check that the thermal overheat cut-out switch(s) has not 'tripped'. Press the reset button at the top of the unit (2 on a VRF HP2000 DXE unit). If the cut-out switch has tripped it will click back on – see picture

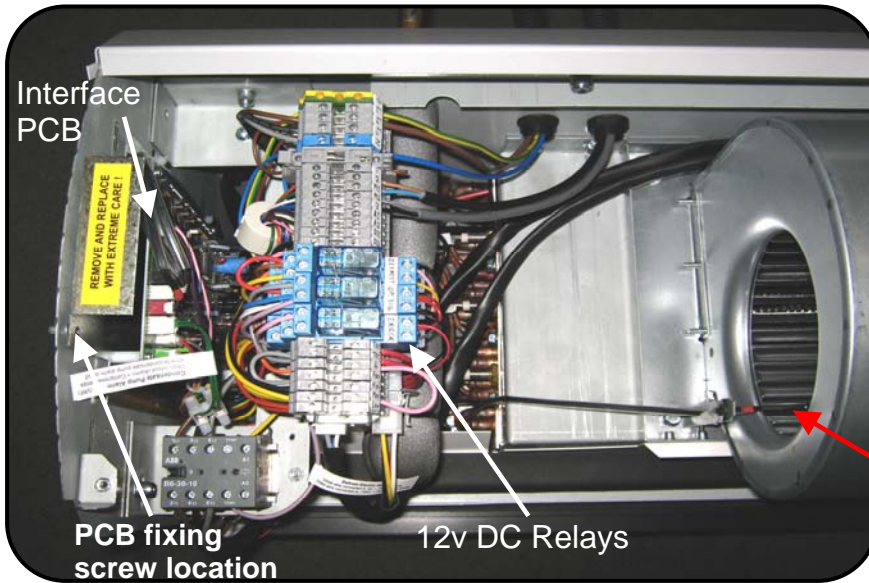

There is a Mitsubishi Electric Interface PCB located within the left hand end of the Thermoscreens Air Curtain. This provides control and communication between the Mitsubishi Electric City Multi system and the Air Curtain Indoor Unit. It is held in place by a fixing screw located in the left-hand end panel of the air curtain under the left-hand plastic end cap. Remove the screw and carefully slide the PCB partially out.

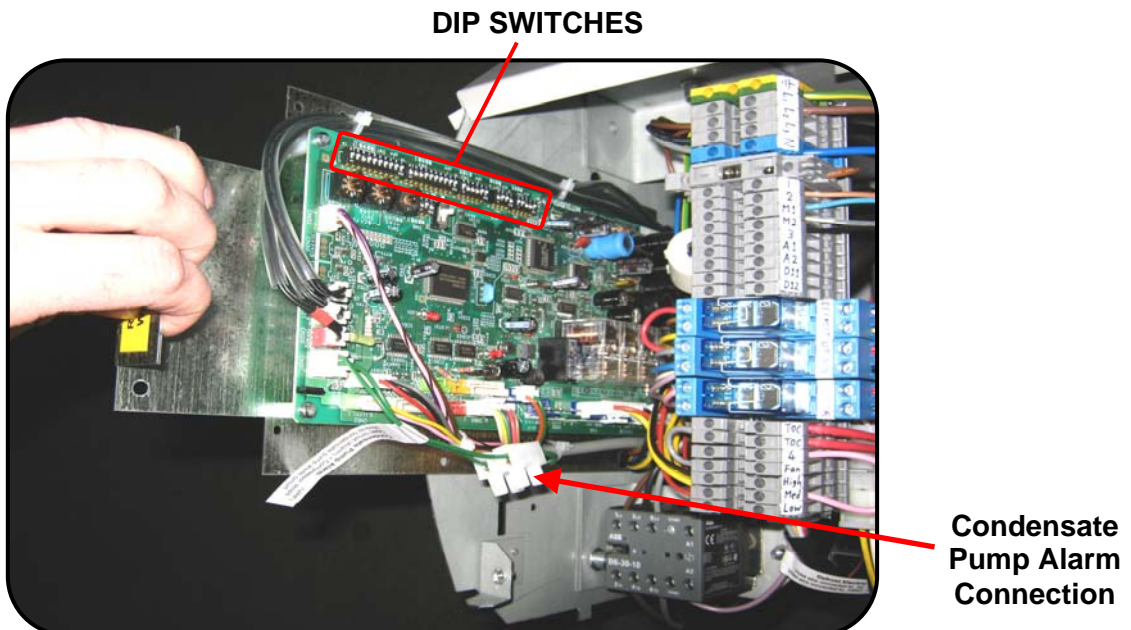

Check that the dip switches on the Interface PCB are set as shown in Wiring Diagrams 1 or 2 on Pages 16 and 17. The SW2 Capacity Setting dip switch should be as follows:

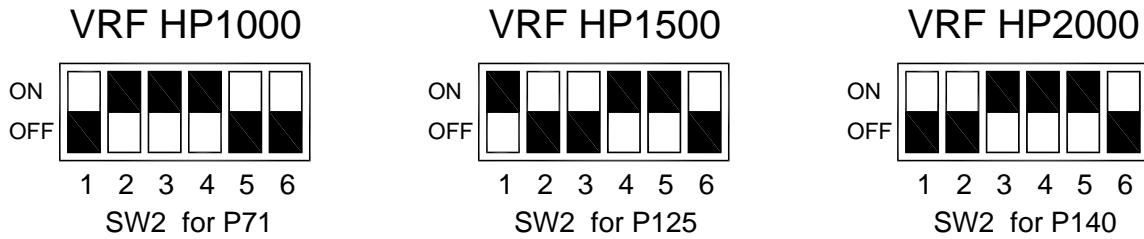

■ Black rectangle indicates moveable head of dip switch

NB. If a Door Switch to switch fan speeds has been fitted, as an alternative to the PAR-30MAA 3-speed fan control, dip switch SW4 will also need to be changed. See Wiring Diagram 1 or 2 on Pages 16 and 17 for details.

Check that the wiring between the Air Curtain and the City Multi (VRF) system is in accordance with Wiring Diagram 1 or 2 on Pages 16 and 17. If still withdrawn, carefully slide the Interface PCB back into place. Ensure cables are not trapped inside and refit the retaining screw.

If not already done wire a Mitsubishi Electric PAR-30MAA Remote Controller to terminals 1 and 2, or a PAR-F27MEA Remote Controller to terminals M1 and M2 (see Wiring Diagram 1 or 2 on Pages 16 and 17 for details). This is used to set the air curtain to the mode of operation, HEAT, FAN, AUTO or COOL, and to set the target temperature.

■ Selecting the Fan Speeds of the Air Curtain

The fan motor(s) in the air curtain is a 6-speed motor and fan speeds can be re-selected at commissioning to suit the installation, both to suit the outdoor environmental conditions and for indoor noise levels.

As delivered, for the 3 fan speeds available from the PAR-30MAA or PAR-F27MEA remote controller:-

the HIGH fan speed (black wire) is wired into motor tapping 1 (highest motor speed tapping),

the MEDIUM fan speed (yellow wire) is wired into motor tapping 3,

the LOW fan speed (red wire) is wired into motor tapping 6 (lowest motor speed tapping),

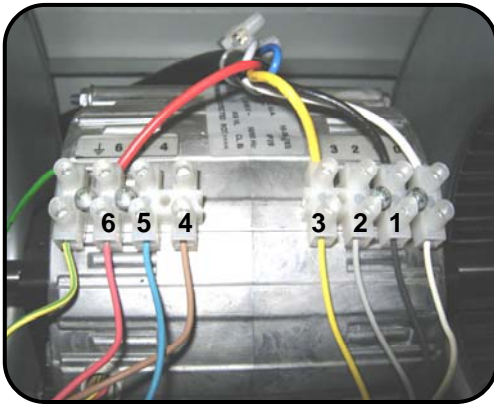

VRF HP1000DXE
VRF HP2000DXE

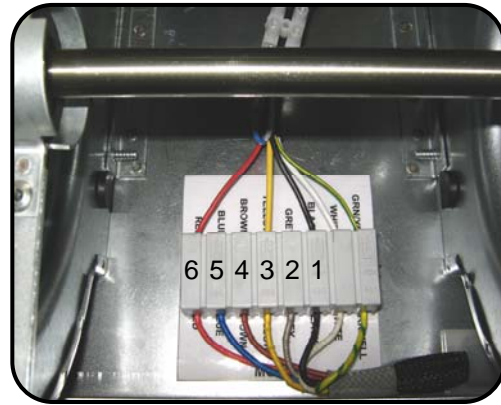

VRF HP1500DXE

The table below provides guidance as to how the fan speeds can be set. **WARNING:** There are two motors on the VRF HP2000DXE model, make sure both motors are wired up in exactly the same way or the motors will overheat with possible damage.

Fan Speed (air curtain as delivered)	Motor Speed Tapping (see Wiring Diagram 1, Page 16 or Wiring Diagram 2, Page 17)	Maximum air curtain mounting height (m)	Sound Pressure Level of air curtain [dB(A) at 3m]	Air Volume Flow Rate (m ³ /h)
HIGH (black wire)	1 – black wire at motor (Highest speed)	3.3	HP1000DXE - 58 HP1500DXE - 58 HP2000DXE - 58	1310 2070 2590
	2 – grey wire at motor	3.0	HP1000DXE - 57 HP1500DXE - 55 HP2000DXE - 57	1250 1900 2480
MEDIUM (yellow wire)	3 – yellow wire at motor	2.8	HP1000DXE - 55 HP1500DXE - 54 HP2000DXE - 55	1170 1800 2340
	4 – brown wire at motor	2.3	HP1000DXE - 53 HP1500DXE - 52 HP2000DXE - 53	1070 1650 2160
LOW (red wire)	5 – blue wire at motor	2.0	HP1000DXE - 50 HP1500DXE - 49 HP2000DXE - 50	970 1450 1930
	6 – red wire at motor (Lowest speed)	1.7	HP1000DXE - 48 HP1500DXE - 45 HP2000DXE - 48	900 1240 1810

See also Section, Installation; 'Wiring of Air Curtain Fan Speed' on Page 18 giving details of how to wire in fan speeds.

Sound pressure levels dB(A) at 3m distance are for a single air curtain mounted at its maximum mounting height, operating in a room with average acoustic characteristics as defined in CIBSE Guide B5 (reverberation time 0.7s at 1kHz) and a room size equivalent to 8 air changes per hour (ac/h). Care needs to be taken when selecting air curtains for an installation as noise levels can be several dB higher if the mounting height is reduced, if the room is more 'live' (i.e. hard surfaces, no furnishings or absorbent materials), if the room is smaller than 8 ac/h equivalent or a combination of these factors. Noise levels will also increase if more than one air curtain is installed at the same doorway (e.g. +3dB(A) for 2 equal point sources: direct field).

■ Starting the Heat Pump System

Carry out a final inspection to ensure that all wiring is in accordance with Wiring Diagram 1 on Page 16 or wiring Diagram 2 on Page 17 and that all connections have been properly made. Ensure that the refrigerant system is complete, there are no leaks and there is sufficient charge of refrigerant R410A. Switch on electrical power to the Mitsubishi Electric compressor unit and other City Multi system components. Wait 30 seconds and switch on electrical power to the air curtain at the local isolator.

WARNING! The Interface PCB inside the air curtain will have 230 volts on it and there will be 400V on some air curtain terminals if the defrost cycle auxiliary heater is enabled.

The system will 'boot-up' and when the screen on the PAR-30MAA or PAR-F27MEA Remote Controller becomes active it will repeat the message "PLEASE WAIT". After several minutes when the PLEASE WAIT message has stopped the system is ready to start.

DANGER: Beware of Fans Starting!

Turn the air curtain on using the ON/Off Button on the Remote Controller and the air curtain fans will start straight away. Using the Fan Speed Button on the remote controller check that the fans run at HIGH speed, MEDIUM speed and LOW speed and there is no mechanical noise coming from the fans at each of the three fan speeds. If a door switch has been installed to change fan speeds from High (door open) to Low (door closed) check this operates correctly. Switch the Mode Button on the remote controller to 'HEAT' and adjust the target temperature to 28°C maximum setting using the **+ Temp.** Button. Check that the air stream from the discharge grille warms up across the whole length of the air curtain after approximately 20 minutes of operation and that the air stream reaches right down across the doorway with the door open or closed.

If the end user is to operate the air curtain with a Remote Controller it can be set-up to monitor room air temperature at the controller instead of return air temperature at the air inlet of the air curtain. If this is required see the Mitsubishi Electric remote controller instructions for details.

If it is intended that the air curtain is to ever operate in cooling mode* switch the Mode Button on the remote controller to 'COOL' and adjust the target temperature to 14°C using the **- Temp.** Button. Wait for the air curtain air stream to go cold. Check there is no debris in the outlet spout, there are no kinks in condensate hoses and the condensate pump (if used) will operate. It is unlikely that condensate will fill the drain tray straight away so it will be necessary to fill the tray manually with water to see if the condensate removal system is working satisfactorily. If an alarm sensor is fitted in the drain tray, check it operates to stop the air curtain cooling if the drain tray becomes too full. Test the air curtain for a time in cooling mode with all the panels and grilles fitted and if environmental conditions permit check that condensate is being collected and pumped away by the condensate pump. No condensate should leak out of the air curtain. At the end of the cooling test remove the inlet grilles and the bottom access panel and check that the inside of the air curtain has remained dry and that all condensate was collected by the removal system.

* For the air curtain to operate in cooling mode there must be a condensate disposal system fitted.

To conserve energy and carbon resources it is recommended to set up the Remote Controller, BMS System or Centralised Controller so it operates in HEAT Mode at a target temperature of 24°C. This is the normal mode of operation for the heat pump air

curtain and it should run in this set-up with no further adjustments, automatically heating as required. If the target temperature is reached the air curtain fans will still operate but the air stream is then not heated (ambient air curtain).

If the end user is to operate the air curtain with a remote controller, set up the No.1 locking function on the controller so they can only switch the air curtain ON or OFF, with no control of mode or target temperatures. If there is no condensate disposal system fitted COOL mode must be locked off on the remote controller so it cannot be used. See instructions for the Mitsubishi Electric PAR-30MAA or PAR-F27MEA remote controller.

If the air curtain is to be operated from a BMS System or Centralised Controller this should be configured such that the air curtain can only operate in HEAT or FAN mode if it is not fitted with a condensate disposal system. The air curtain should only be configured to operate in AUTO or COOL mode if it is fitted with a condensate disposal system.

BEWARE: It is possible for the air curtain to go into cooling mode on a warm day if the Remote Controller, BMS System or Centralised Controller is set in AUTO mode. A condensate disposal system must therefore be fitted if the air curtain is to be used in AUTO mode.

Switch off the electrical power to the Air Curtain and the Mitsubishi Electric City Multi system. Carefully slide the Interface PCB back into place. Ensure cables are not trapped inside and refit the retaining screw.

■ Filter Dirty Indicator

The air curtain is fitted with a Filter Dirty Indicator. It is located at the left-hand end of the outlet grille and signals when the air curtain inlet grille/filters should be vacuum cleaned or the air curtain requires servicing.

NB.The filter dirty interval feature on the Mitsubishi Electric remote controller is not available.



The indicator states are outlined below:

Indicator State	Indicator Light	Action Required	Reset Button
GREEN FLASH	On 0.5s; Off 3s	None	N/A
RED ON	On permanently	Vacuum inlet	Quick reset
RED FLASH	On 0.5s; Off 0.5s	Service filters	Press for 5s

The filter indicator schedule is based on fan operating hours. For the default schedule, shown schematically below, the inlet grilles should be vacuum cleaned every 240hrs of fan operation (3 to 4 weeks depending on use) and a full service should take place every 960hrs of fan operation (4 to 6 months depending on use).

MT2

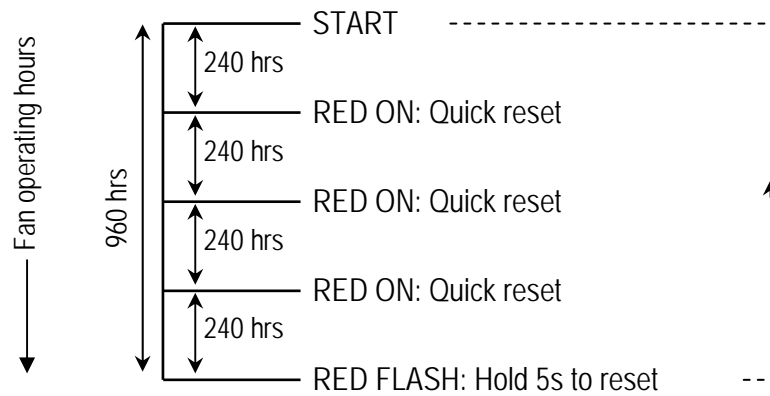

The factory set default schedule is suitable for most applications. However, the actual frequency of cleaning required will depend on the environment. Two alternative filter indicator schedules are available, and can be selected by changing the 'jumper' position (marked 1, 2 or 3) on the Filter Indicator PCB.

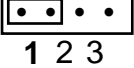
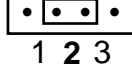
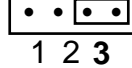
Filter Indicator Schedule	Half Period	Default Period	Double Period
Jumper position	 1 2 3	 1 2 3	 1 2 3
Inlet grille vacuum interval	120 hrs	240 hrs	480 hrs
Filter service interval	480 hrs	960 hrs	1920 hrs

To access the Filter Indicator PCB to change jumper position:-

Switch off the electrical power to the Air Curtain. Remove the plastic end caps, inlet grilles and bottom access panel, see 'To gain access inside the Air Curtain', Page 13.

Unfasten the two screws as shown in the picture at the left hand end of the discharge grille.



Gently lower the left-hand end of the discharge grille, supporting it from below. The Filter Indicator PCB is now accessible to change the jumper position.

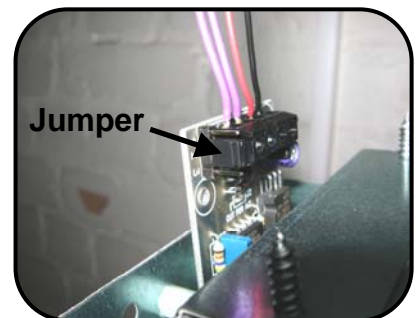

Once the filter indicator PCB 'jumper' has been re-positioned, push the discharge grille back up into place and re-fasten the screws. Replace bottom access panel, inlet grilles and plastic end caps in reverse order.

■ Final Check of the Unit

Replace the bottom access panel, air inlet grilles (with filters) and plastic end caps (see 'To gain access inside the Air Curtain', page 13).

Power-up both the Mitsubishi Electric City Multi system and the Air Curtain and re-check the operation of the unit.

■ Hand-over to End-User

Before leaving site it is important that there is a 'Hand-Over Meeting' to hand-over the heat pump system and air curtain installation to the end user or their representative. This should include a full and clear explanation of how the system operates and a demonstration showing the air curtain running. Be sure to explain the Filter Indicator Schedule, that the air inlet grilles and air filters must be regularly vacuum cleaned and the unit serviced at regular intervals. See "Servicing the Air Curtain", Page 29.

If the air curtain is to be operated under manual control using a PAR-30MAA or PAR-F27MEA remote controller, it is important that the end user understands how the heat pump system works. That the air curtain operates in FAN (Ambient) mode or in HEAT mode with a fixed target temperature of, say, 24°C.

Explain how the fan speeds operate, whether this is manual 3-speed fan control using a PAR-30MAA or PAR-F27MEA remote controller if there is a door operated switch that switches fan speeds to High – Door open, or Low – Door closed.

If a condensate drain system has been installed and it is intended that the unit is to operate in cooling mode, show the end user how the COOL/AUTO mode operates. Leave the system set to HEAT and lock all buttons on the remote controller except the ON/OFF button before leaving site (Locking Function No.1).

If the air curtain is to be operated under the control of a BMS System or Centralised Controller, explain all the settings and demonstrate the operation of the system. That the air curtain should be operated in FAN (Ambient) mode or in HEAT mode with a fixed target temperature of, say, 24°C. It is vital they understand that the air curtain must not be run in COOL or AUTO mode if a condensate drain system has not been installed.

If a condensate pump and drain system has been fitted and the air curtain is to be operated in COOL mode explain that the target temperature should be adjusted to a comfortable level of cooling, not necessarily to the lowest target temperature possible as this uses a lot more energy and increases the carbon footprint.

Explain to the end user that the doorway should be closed whenever possible but that during times of high pedestrian use it will become effectively 'open doorway'. The air curtain serves an essential purpose by saving energy and providing comfort to the occupants when compared to an open doorway with no air curtain fitted.

Ensure that all instructions and manuals are handed to the end user or their representative.

USER INSTRUCTIONS FOR THE AIR CURTAIN

To Switch On and Off:

Turn the air curtain ON by pressing the ON/OFF Button on the PAR-30MAA (or PAR-F27MEA) Remote Controller and the air curtain fans will start within a few seconds. As set up by the Commissioning Technician the air curtain will operate in **Heat** mode, automatically heating as required, with a target temperature of 24°C - all other buttons on the Remote Controller are locked out.

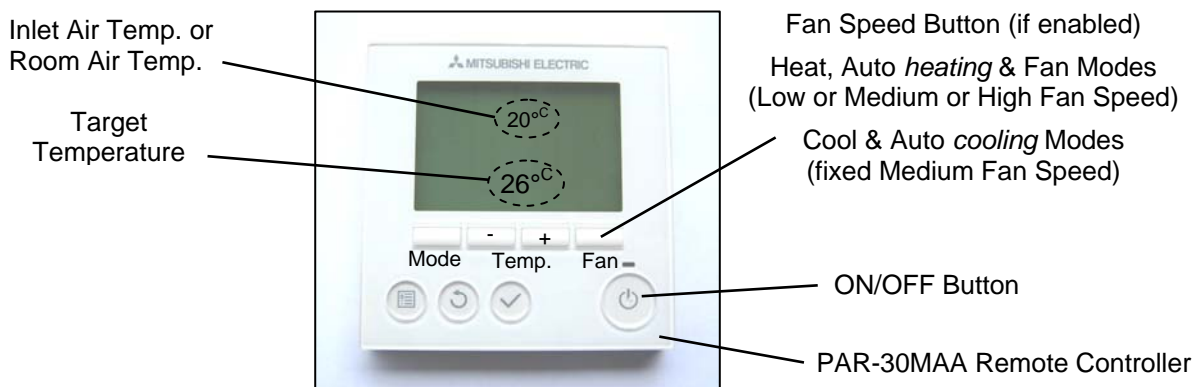

Turn the air curtain OFF by pressing the ON/OFF Button on the Remote Controller and the air curtain fans will stop. Do not turn off if **DEFROST** shows on the screen, wait until 5 minutes after defrost has finished.

If the Remote Controller is not locked the following functions operate:-

FAN SPEEDS:

If enabled, press the Fan Speed Button on the Remote Controller to operate the fans on LOW, MEDIUM or HIGH fan speed. Fan speed logic is explained in the diagram above. If a door switch is set-up to change fan speeds Fan Speed Button will not operate.

HEAT Mode:

Press the Mode Button on the Remote Controller until **Heat** appears on the display. Adjust the target temperature using the **- or + Temp.** buttons between 22°C and 28°C maximum. This is the normal mode of operation for the heat pump air curtain and it should run in this set-up with no further adjustments, automatically heating as required. Allow time for the air stream to heat up.

AUTO Mode: (only use if a condensate pump and drain system is fitted)

Press the Mode Button on the Remote Controller until **Auto** appears on the display. Adjust the target temperature using the **- or + Temp.** buttons. Allow time for the air stream to heat up or cool down.

FAN Mode (Fan only - no heating or cooling):

Press the Mode Button on the Remote Controller until **Fan** appears on the display.

COOL Mode: (only use if a condensate pump and drain system is fitted)

Press the Mode Button on the Remote Controller until **Cool** appears on the display. Adjust the target temperature using the **- or + Temp.** buttons between 24°C and 19°C (minimum recommended). Allow time for the air stream to cool. Do not necessarily use the lowest target temperature possible as this uses more energy and carbon resources.

SERVICING THE AIR CURTAIN

■ Vacuum Clean the Air Inlet Grilles / Filters (Fortnightly, or when the Filter Dirty Indicator shows PERMANENT RED)

With the air curtain switched OFF, a vacuum cleaner with an extension tube and brush attachment at its end should be used to clean the face of the air inlet grilles. This is important to minimise the build-up of dust and lint on the air filters inside the inlet grilles which will affect the performance of the air curtain. This is a simple service task that can be carried out by the Cleaner or Janitor on a weekly basis from floor level without having to access the air curtain at high level. This should be done weekly as a regular service task and/or when the Filter Dirty Indicator shows permanent red.



ONLY if the Filter Dirty Indicator shows PERMANENT RED

Reset the Filter Dirty Indicator after cleaning by a quick press of the Reset Button.

NB. The filter dirty interval feature on the Mitsubishi Electric remote controller is not available.

■ Servicing the Air Curtain (suggest every 6 Months, or if the Filter Dirty Indicator shows FLASHING RED)

Before servicing, maintaining or repairing the Air Curtain always isolate the local electrical supply to the Air Curtain and, if necessary, the electrical supply to the Mitsubishi Electric City Multi system.

Note: All servicing, maintenance and repairs to the air curtain must be carried out by an approved Service Agent. Keep any loose fixings for re-assembly.



Remove the plastic end caps at each end of the unit by pulling off to the side as shown in the picture.

Remove each air inlet grille with its air filter by unfastening the quarter-turn Philips Head fastener at the bottom corner of the grille. Use a Philips No.1 screwdriver to access the screw via the elongated hole at the bottom corner of each grille and turn anti-clockwise to remove (see picture).

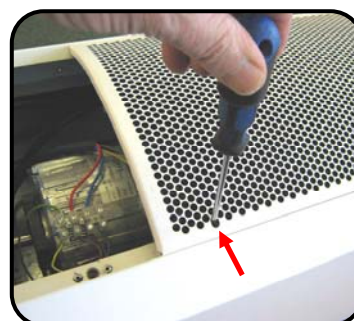



Remove the air filters from the air inlet grilles by gently prizing them free as shown. Gently vacuum clean and refit the filters into the curved air inlet grilles. The filters are durable but may need to be replaced after a number of service intervals.

To remove the bottom access panel unfasten the access panel securing screws, one at each end, plus two in the centre (VRF HP1500DXE and VRF HP2000DXE units) and slide the panel out forwards (see picture).

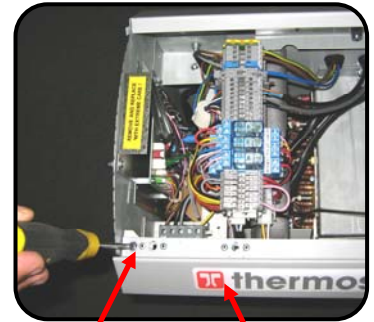

screw access panel

Vacuum clean and remove any build-up of dust, dirt and debris within the air-curtain, especially on the fans.

Note: Fan motors are permanently lubricated and require no additional lubrication.

If the Air Curtain has been used in Cooling:-

Remove two screws from each end of the air curtain that attach the air discharge grille assembly to the unit. Remove the discharge grille assembly from the unit.



On the VRF HP1500DXE and VRF HP2000DXE air curtains there is an additional screw at the middle of the grille that also needs to be removed.

Remove condensate hose from the drain tray outlet pipe, see picture.





Using a 10mm spanner loosen the two bolts, one at each end of the air discharge opening, by 2 turns. Do not remove these two bolts completely.

Remove the row of fixing screws along the whole length of the drain tray (see picture).



The drain tray now hinges down along its front edge and the inside surface of the tray can be cleaned. Remove all debris and deposits from the coil face, drain tray, outlet pipe, condensate hoses and the condensate disposal system.

Check there are no kinks in condensate hoses. If the condensate pump is a peristaltic type change the rubber pump head tube. Refit drain tray opposite to removal

Once the air curtain has been cleaned, visually inspect the air curtain components. Ensure pipe temperature sensors are located in their pockets and any foam insulation covering these pockets is un-damaged. Check that the thermal overheat cut-out switch (two on a VRF HP2000DXE unit) has not tripped (see Section – Commissioning, Page 20). Check all electrical connections and terminals within the unit are tight and that crimp connections have not become loose.

Refit the bottom access panel and air inlet grilles with filters. Switch on the electrical supplies and fully function test the air curtain to ensure correct operation (see Section – Commissioning, Page 20).

Reset the Filter Dirty Indicator after the service by pressing the Reset Button for at least 5 seconds (even if the indicator has not gone flashing red) and hand back the unit to the end user.



■ Fault Finding

If the Thermoscreens Heat Pump Air Curtain System does not operate as expected refer to the fault finding table below:

Symptom	Possible Cause	Action Required
Air curtain fans do not operate	Electrical power is not switched on to the Mitsubishi Electric City Multi system <u>and</u> at the local electrical isolator next to the Thermoscreens Air Curtain	Switch on power to all components in the heat pump system and wait for system to boot-up
	Air curtain is not switched On	Switch on the air curtain using the Remote Controller, BMS System or Centralised Controller
	Remote ON/OFF or ENABLE/DISABLE wiring to terminals 3, A1 & A2 not wired up correctly	Wire terminals 3, A1 & A2 correctly – see Wiring Diagrams
	Problem with air curtain fan motor(s), internal wiring, controls or fan speed door switch if fitted	Use wiring diagram to investigate possible cause of fault
Air curtain discharge air stream is not heating or cooling when required	Air curtain has been running for less than 20 minutes and is still warming up or cooling down	Give system sufficient time to reach operating condition
	Air curtain is set to Fan-Only on PAR-30MAA/F27MEA Remote Controller, BMS System or Centralised Controller	Check schedule on Controller and amend if necessary
	Target temperature is set incorrectly, i.e. too low for heating or too high for cooling	Adjust the target temperature on the Remote Controller, BMS System or Centralised Controller
	The operating mode is set incorrectly, i.e. set on COOL when heating is required	Select the correct mode for the conditions on the Remote Controller, BMS System or Centralised Controller
	Condensate Alarm circuit is open circuit and air curtain will not COOL or HEAT	Rectify alarm circuit which must be closed circuit for heat pump system to operate
	Air Curtain filters and/or coil is dirty.	Service air curtain as described in Section – Servicing, Pages 29 to 31
Mitsubishi Electric system is indicating an error code	Error Code 2503 indicating condensate alarm from condensate pump alarm system	Inspect air curtain condensate tray and condensate pump, service or repair if necessary
	A variety of error codes can occur because of a fault within the air curtain	Refer to Mitsubishi Electric Service Manual to understand fault, then inspect and repair air curtain if there is a fault

If the Heat Pump Air Curtain system is still not operating correctly call for a Mitsubishi Electric Service Agent.

■ Warranty

If any problems are encountered with the heat pump warm air curtain please contact your Mitsubishi Electric Service Agent.

Care has been taken in compiling these instructions to ensure they are correct, although Thermoscreens Ltd. disclaims all liability for damage resulting from any inaccuracies and/or deficiencies in this documentation. Thermoscreens Ltd. retain the right to change the specifications stated in these instructions.

Thermoscreens Ltd
St. Mary's Road Nuneaton
Warwickshire England
CV11 5AU

Email: sales@thermoscreens.com

Tel: + 44 (0) 24 7638 4646

Fax: + 44 (0) 24 7638 8578

www.thermoscreens.com

Thermoscreens Ltd
St. Mary's Road
Nuneaton
Warwickshire
CV11 5AU
United Kingdom
Telephone: +44 (0)24 7638 4646
Fax: +44 (0)24 7638 8578



EC DECLARATION OF CONFORMITY

as defined by the EC Council Directive on Machinery 2006/42/EC, the Low Voltage Directive 2006/95/EC, Electromagnetic Compatibility Directive 2004/108/EC, the Pressure Equipment Directive 97/23/EC

Herewith we declare that the air movement equipment designated below, on the basis of its design and construction in the form brought onto the market by us in accordance with the relevant safety, health and performance requirements of the Machinery.

If alterations are made to the machinery without prior consultations with us, this declaration becomes invalid.

Designation of Equipment : THERMOSCREENS HEAT PUMP AIR CURTAINS used with a MITSUBISHI ELECTRIC CITY MULTI HEAT PUMP SYSTEM

Series Type : VRF HP1000 DXE; VRF HP1000R DXE; VRF HP1500 DXE; VRF HP1500R DXE; VRF HP2000 DXE; VRF HP2000R DXE

Relevant EC Council Directives : the Machinery Directive (2006/42/EC)
the Low Voltage Directive (2006/95/EC)
the Electromagnetic Compatibility Directive (2004/108/EC)
the Pressure Equipment Directive (97/23/EC)

Applied Harmonised Standards : Machinery - EN ISO 14121-1:2007, EN 294:1992, EN 414:2000
LVD - EN 60335-1:2002, EN 60335-2-30:2003, EN 60335-2-40:2003
EMC - EN 61000-6-1:2007, EN 61000-6-3:2007,
EN 61000-3-2:2006 + A2:2009, EN 61000-3-3:2008
PED - EN 13133:2000, EN 13134:2000

Basis of Self Attestation : Quality Assurance to BS EN ISO 9001 : 2008
B.S.I. Registered Firm Certificate Number FM 85224
SGS Test Report DUR 43908/2/R/RG/05; GL Test Report TR/09/149;
Wemtech Test Report 6619

Responsible Person : Mr. P. Casey, Site Managing Director, Thermoscreens Ltd.

Date : 19th January 2012

Signed :